

✓ U113
12
TM
1944

TM 11-2609

WAR DEPARTMENT TECHNICAL MANUAL

U.S. Dept. of Army

RADIO BEACON EQUIPMENT

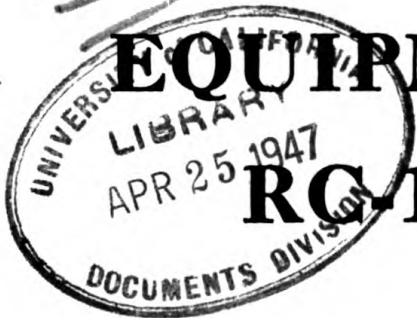

RC-163

CONFIDENTIAL

WAR DEPARTMENT

Digitized by Google

1944

Original from
UNIVERSITY OF CALIFORNIA

WAR DEPARTMENT TECHNICAL MANUAL

TM 11-2609 

**RADIO BEACON
EQUIPMENT
RC-163**



WAR DEPARTMENT

1944

 WAR DEPARTMENT,
WASHINGTON 25, D. C., 1944.

TM 11-2609, War Department Technical Manual, Radio Beacon Equipment RC-163, is published for the information and guidance of all concerned.
[A.G. 300.7 (26 Feb 44).]

BY ORDER OF THE SECRETARY OF WAR:

G. C. MARSHALL,
Chief of Staff.

OFFICIAL:

J. A. ULIO,
*Major General,
The Adjutant General.*

DISTRIBUTION:

X.

(For explanation of symbols see FM 21-6.)

Table of Contents

U113
.2
T M II: 2609
1944
★ ★

SECTION I.	Description.	Paragraph	Page
	General	1	1
	Power source	2	3
	Power consumed	3	3
	Frequency range	4	3
	Range	5	3
	List of components	6	4-5
	Antenna Mount MP-67	7	6
	Antenna system	8	7
	Tuning Indicator I-234	9	12
	Compass and tripod	10	14
	Cables	11	15
	Control Panel PN-26	12	17
	Oscillator BC-1304	13	19
	Resonance Tuner BC-1305	14	19
	Motor	15	20
	Clutch	16	21
	Automatic code keyer	17	21
	Code disc	18	23
	Emergency keyer	19	23
	Mounting FT-492	20	25
II.	Installation and Operation.		
	General	21	26
	Initial procedure	22	27
	Installation	23	29
	Cable connections	24	29
	Assembly of antenna array	25	31
	Tuning the transmitter	26	34
	Antenna pattern tuning	27	37
	Orientation and alignment of beacon to compass	28	39
	Receiver operation	29	44
	Homing operation	30	46
	Directive transmission and reception	31	47
	Standby operation	32	47
	Direction finding	33	47
	Directing a friendly station	34	47

M574758

III

TABLE OF CONTENTS

	<i>Paragraph</i>	<i>Page</i>
Navigating with the beacon	35	47
Use of antenna array to overcome enemy jamming	36	48
Emergency keying	37	48
III. Functioning of Parts.		
General	38	49
Resonance Tuner BC-1305	39	51
Oscillator BC-1304	40	52
Automatic code keyer	41	52
Clutch assembly	42	52
Tuning Indicator I-234	43	54
IV. Maintenance.		
Cleanliness	44	56
Lubrication	45	56
Gear adjustment	46	57
Variable capacitor tuning knobs	47	57
Mast sight care	48	57
Rotating link coupling-adjustment	49	57
Tuning Indicator I-234	50	58
Emergency replacement of Mast Sections		
MS-120 and MS-121	51	58
Bent mast sections	52	58
Code-keyer contact	53	58
Variable capacitor care	54	59
Tube replacement	55	59
Fuse replacement	56	59
Motor brush replacement	57	59
Pilot light replacement	58	59
Compass care	59	60
Battery replacement	60	60
Removing r-f cable from Mast MS-119	61	60
Replacing r-f cable in Crossarms M-407 and M-408	62	61
Replacing r-f line in mast stub	63	62
Motor	64	62
Pattern maintenance: testing	65	63
Trouble chart	66	64
Moistureproofing and fungiproofing	67	66
V. Supplementary Data.		
Maintenance parts list for Radio Beacon Equipment RC-163	68	68

List of Illustrations

<i>Fig. No.</i>	<i>Title</i>	<i>Page</i>
1.	Radio Beacon Equipment RC-163	2
2.	Antenna Mount MP-67	6
3.	Antenna array, assembled	8
4.	Phase-load box, side view	9
5.	Phase-load box, bottom view	10
6.	Crossarms M-407 and M-408	11
7.	Mast sight	12
8.	Tuning Indicator I-234	8
9.	Compass MC-323	14
10.	Compass and tripod	15
11.	Cords CD-1151, CD-1155, and CD-1156	16
12.	Control Panel PN-26	17
13.	Oscillator BC-1304	18
14.	Resonance Tuner BC-1305	19
15.	Motor	20
16.	Clutch, exploded view	21
17.	Code-keyer well	22
18.	Code disc	23
19.	Mounting FT-492	24
20.	Bolting mounting plate to floor of vehicle	26
21.	Beacon mounted in various vehicles	27
22.	Cording diagram	28
23.	Transmitter base, ground connection	30
24.	R-F cable connection to transmitter	31
25.	Placing crossarms in mast	32
26.	Placing mast sections in crossarms	33
27.	Placing assembled antenna array on antenna mount	34
28.	Adjustment tank circuit trimmer capacitor of transmitter	35
29.	Adjusting antenna tuning capacitor of transmitter	36
30.	Beacon clearance	38
31.	Orienting the beacon	40
32.	Azimuth correction for beacon	41
33.	Table of code discs	42
34.	Homing disc	45
35.	Schematic diagram of antenna array	50
36.	Schematic diagram of oscillator	53
37.	Schematic diagram of tuning indicator	54
38.	Removing connector from crossarm	61
39.	Antenna pattern	63

LIST OF ILLUSTRATIONS

<i>Fig. No.</i>	<i>Title</i>	<i>Page</i>
40.	Components of Antenna Mount MP-67	94
41.	Control panel and resonance tuner	95
42.	Clutch	96
43.	Oscillator	97
44.	Tuning indicator	98
45.	Phase-load box	99
46.	Tool kit	100
47.	Mast sections	101

Destruction Notice

WHY — To prevent the enemy from using or salvaging this equipment for his benefit.

WHEN—When ordered by your commander.

HOW — 1. Smash—Use sledges, axes, handaxes, pickaxes, hammers, crowbars, heavy tools.

2. Cut—Use axes, handaxes, machetes.

3. Burn—Use gasoline, kerosene, oil, flame throwers, incendiary grenades.

4. Explosives—Use firearms, grenades, TNT.

5. Disposal—Bury in slit trenches, fox holes, other holes. Throw in streams. Scatter.

**USE ANYTHING IMMEDIATELY AVAILABLE
FOR DESTRUCTION OF THIS EQUIPMENT.**

WHAT—1. Smash—Oscillator, resonance tuner, control panel, code-keyer contact, turntable, tuning indicator, compass, phaseload box, spare coils and tubes, mast and cross-arm insulators.

2. Cut—All cords and wiring.

3. Bend and/or break—Compass tripod and all mast sections.

4. Burn—Cut cords and wires, tuning discs, technical manuals, codes, records, and calibration charts.

5. Bury or scatter—Bury code discs and bury or scatter any or all of the above pieces after breaking.

DESTROY EVERYTHING

Safety Notice

Keep away from the gears when the beacon is operating. Always disconnect the power cord before making gear adjustments. The voltage used (12 volts) is not high enough to be dangerous.

SECTION I

Description

1. GENERAL

a. Radio Beacon Equipment RC-163 is auxiliary equipment designed to provide a method for radio receiver-equipped units to locate themselves in unfamiliar terrain. No additional equipment other than a receiver capable of tuning the beacon frequencies and a compass are required to "home" to the beacon.

b. The beacon equipment (fig. 1) consists essentially of a rotating directional antenna synchronized to an automatic code keyer. Substituting the beacon equipment for the standard whip antenna will convert a transmitter into a beacon station. Radio Beacon Equipment RC-163 is designed for ready connection to Radio Set SCR-508-(*&*) or SCR-608-(*&*)¹ which are regularly employed in vehicles of the armed forces. By use of only one beacon, all radio receiver operators able to receive the beacon signal and who know the beacon code are able to "home" to the beacon. (Official Signal Corps nomenclature followed by the symbol (*&*) is used to indicate any item of the equipment regardless of its model or procurement.)

c. A permanent or semipermanent installation of the beacon equipment can be made either in a wooden building or outside if there is enough room for the antenna array to rotate.

d. The directional characteristics of the beacon antenna are such that the signal sent out in one direction is practically zero. This direction, indicated by a white band on antenna Crossarm M-408, is always the direction indicated by 0° on the antenna mount-stub azimuth ring. This direction of minimum radiation, or antenna null, is used most frequently when taking bearings.

e. In operation, the automatic code keyer, synchronized with the rotating antenna array, transmits a series of eight International code characters, each repeated three times, during each complete rotation of the antenna. Each character of the 24 is centered and definitely identifies each 15° position of the antenna pattern with a particular character.

f. Thus, any receiver operator in the field, who is previously informed which direction of the compass each character stands for, can readily find his own direction with respect to the beacon by noting the center of the group of characters either completely omitted or those that come in the weakest. This group of characters, will be those transmitted while the antenna null points directly toward the receiver operator.

¹Radio Beacon Equipment RC-163 will work equally as well with Radio Sets SCR-528-(*&*), SCR-538-(*&*), or SCR-628-(*&*).

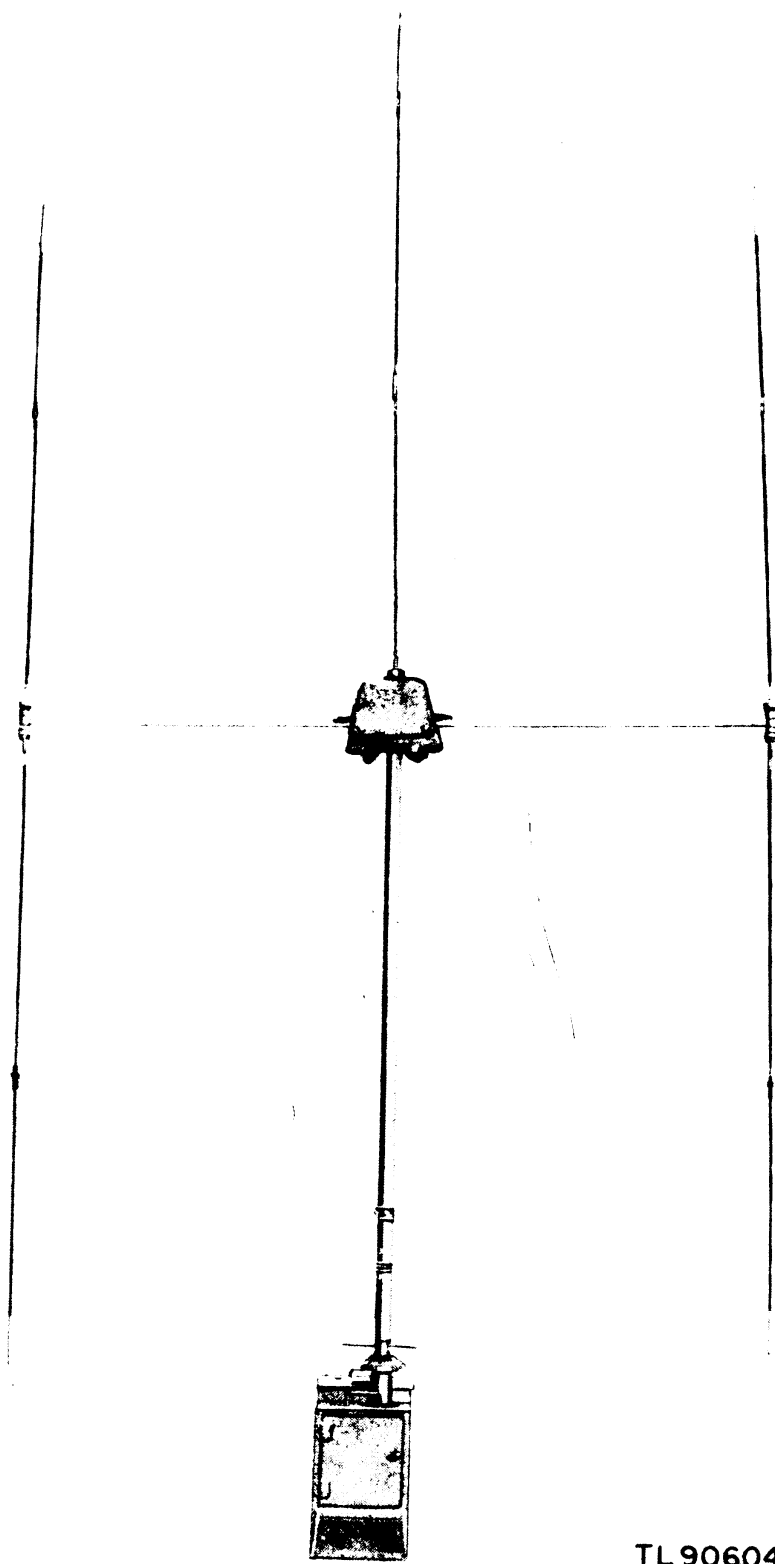

TL 90604

Figure 1. Radio Beacon Equipment RC-163.

g. A radio receiver and transmitter are not furnished as a part of Radio Beacon Equipment RC-163.

b. Radio Beacon Equipment RC-163 may also be used for directive transmission and reception, and for navigation using two beacons on a base line.

2. POWER SOURCE. Radio Beacon RC-163 is designed to operate from a 12-volt storage battery, using either the battery of the vehicle in which the equipment is mounted or a separate battery.

3. POWER CONSUMED. Power consumed by the equipment is approximately 54 watts when operated from a 12-volt source with a current drain of 4.5 amperes.

4. FREQUENCY RANGE. Radio Beacon Equipment RC-163 is designed to operate between the frequencies of 20 and 39 megacycles. Four sets of plug-in inductors, with their frequency ranges marked, are supplied. Equipment is shipped with the 25-30 megacycle inductor coils installed in the phase-load box. These inductors cover the lower end of the frequency range of Radio Set SCR-608-(*&*) and the upper end of the frequency range of Radio Set SCR-508-(*&*). The six remaining inductors are mounted within the antenna mount.

5. RANGE.

a. The electrical characteristics of the antenna increase the range of the transmitter, to which the radio beacon is attached. The increase is approximately 50 percent when used on voice and 100 percent when the audio oscillator of the beacon is keyed.

b. The range of the equipment over ground is approximately 35 miles, and when contacting airplanes at 5,000 feet or more in altitude, the range is approximately 80 miles, when using Radio Set SCR-508-(*&*) or SCR-608-(*&*).

6. LIST OF COMPONENTS.

Quantity	Names of components	Dimensions (in.)					Weight (lb)
		Height	Width	Depth	Length	Diam	
1	Adapter, Brunson Type MC-324, or equal.						
1	Antenna Mount MP-67.	20	13	15 3/4			116.5
1	Bag BG-179, for cross-arms.						13 oz.
2	Battery BA-15-A, for Tuning Indicator I-234.	4	2 5/8	1 1/4			3/4
4	Clamp, sighting.	2 1/4	2 1/2		4 1/2		5/8
1	Coil C-456, 20-23 mc.	1 3/4			2 1/2	1	1/8
1	Coil C-457, 23-25 mc.				2 1/2	1	1/8
1	Coil C-458, 25-30 mc.				2 1/2	1	1/8
1	Coil C-459, 30-40 mc.				2 1/2	1	1/8
1	Coil C-460, 20-23 mc.				2 1/2	1	1/8
1	Coil C-461, 23-25 mc.				2 1/2	1	1/8
1	Coil C-462, 25-30 mc.				2 1/2	1	1/8
1	Coil C-463, 30-40 mc.				2 1/2	1	1/8
1	Code disc, set, includes 15 code discs.			1/8		5 1/2	7 1/3
1	Compass MC-323.			3/4		5	2 1/8
1	Control Panel PN-26.	8 3/4		7 1/2	9 1/8		7 1/8
1	Cord CD-1151, power cable.				10 ft		3/4
1	Cord CD-1155, audio cable.				10 ft		3/4
1	Cord CD-1156, r-f coaxial cable.				10 ft		3/4
1	Cord CD-1178, bonding strap.						1/8
1	Cover BG-177, for antenna mounting stub.						1/8
1	Cover BG-181, for mast base.						1/8
1	Crossarm M-407.		1	1	46 1/2		4
1	Crossarm M-408 (null).		1	1	46 1/2		4

		<i>Description</i>					
4	Lamp, neon glow, G. E. No. T4½, with candelabra base.						
1	Mast MS-119, includes phase-load box.					25	
5	Mast Section MS-50.					¼	
1	Mast Section MS-51.					⅜	
4	Mast Section MS-120.					⅛	
1	Mast Section MS-121.					1/16	
1	Mounting FT-492, base-plate mounting.		12		19	11½	
1	Mounting FT-493, tuning-indicator mounting.	2⅛	5⅝		7 5/16	½	
1	Mounting FT-494, audio-oscillator mounting.	1	4¼		7⅝	1⅛	
1	Mounting FT-495; coil, fuse and bulb storage mounting.		4⅞		8	1	
1	Oscillator BC-1304.	1¾	3¼		7½	2½	
1	Resonance Tuner BC-1305.	3¼	3¼		5¼	2	
1	Roll BG-56-A.					1¼	
2	Technical manual for Radio Beacon Equipment RC-163.		9		11	1¼	
1	Tools, set: Consists of 1 screwdriver, 4-inch, ⅛-inch blade; 1 wrench; Allen No. 6 or equal; 1 wrench, Allen No. 12 or equal; 1 wrench, Allen ¼-inch or equal; 1 pliers, water pump; and 1 screwdriver, 3-inch.					¾	
1	Tripod, Brunson Type MC-325 or equal.	15¼				1⅜	
1	Tuning Indicator I-234.	5¼	4½		6½	1½	5⅜

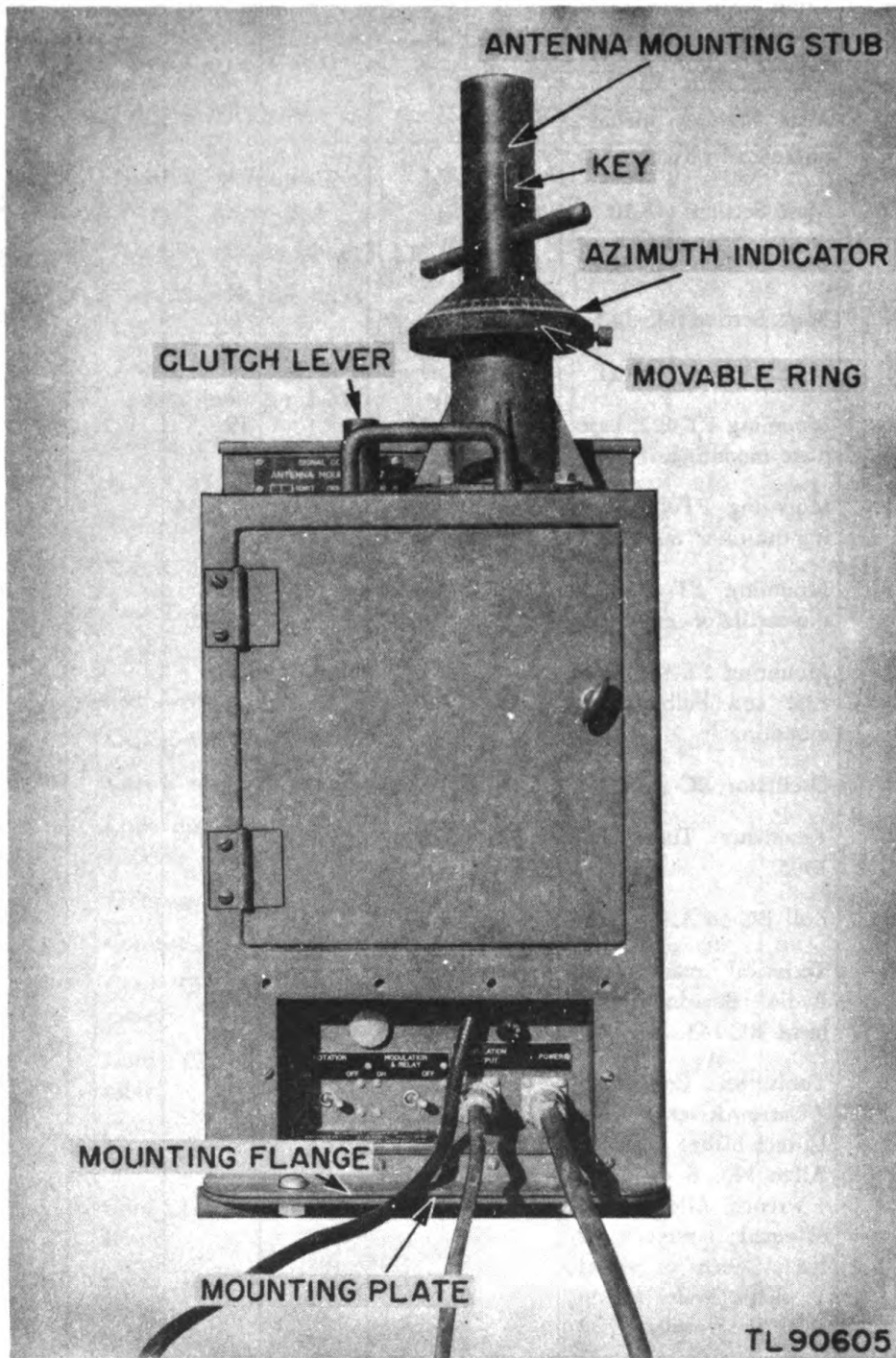

Figure 2. Antenna Mount MP-67.

7. ANTENNA MOUNT MP-67.

a. The antenna mount (fig. 2) is a steel box 12 inches wide, 15 $\frac{3}{4}$ inches deep, and 20 inches high. Flanges on the bottom of the mount are bored for

bolts to permit fastening the mount to a mounting plate or directly to the floor of a vehicle.

b. A hinged lid on the top of the antenna mount permits entrance into the code-disc well which houses the automatic code-keyer, emergency keyer, tripod, and tuning indicator.

c. A hinged door on the front of the antenna mount, that is held shut by a thumbscrew, permits entrance to the lower compartment where the resonance tuner and audio oscillator are mounted. The lower compartment also houses the spare code-discs, pilot lights, inductors, neon glow lamps, fuses, battery, and compass.

d. The antenna mounting stub is located on top of the antenna mount. The azimuth indicator, which has luminous markings for night reading, is mounted on the antenna mounting stub. A movable knurled ring, that can be fastened in any one position by a knurled screw threaded in the side of the ring, has a zero set scribe mark for use in orienting the beacon.

e. A canvas cover, Cover BG-177, is furnished to protect the antenna mounting stub when not in use.

8. ANTENNA SYSTEM.

a. General. The beacon antenna system (fig. 3), consists of an Adcock-type antenna in conjunction with a vertical dipole. Included with the system is the phase-load box containing the necessary phasing circuits.

b. Vertical Dipole. (1) The vertical dipole consists of a hollow Mast MS-119, on top of which is mounted the phase-load box, and a mast consisting of three sections which screws into the top of this box.

(2) Mast MS-119 consists of approximately 6 feet 5½ inches of 2¼-inch hollow tubing, with bakelite insulators at each end and a polarized socket below the bottom insulator. This socket slides over the antenna mounting stub in the antenna mount. Two keys on the outside of the mounting stub (fig. 2), fit into the notches in the polarized mast socket. These keys serve as a rest and are so constructed that the mast can only be inserted correctly into the antenna mounting stub. These keys eliminate strain from the electrical connections between the stub and the mast when the antenna rotates. Within the mast an r-f transmission line terminates at the lower end in solid male type jacks which mate with split female plugs mounted within the stub. At the upper end, the r-f transmitter line connects to the circuits within the phase-load box.

(3) A canvas cover, Cover BG-181, is furnished to protect the lower end of the mast when not in use.

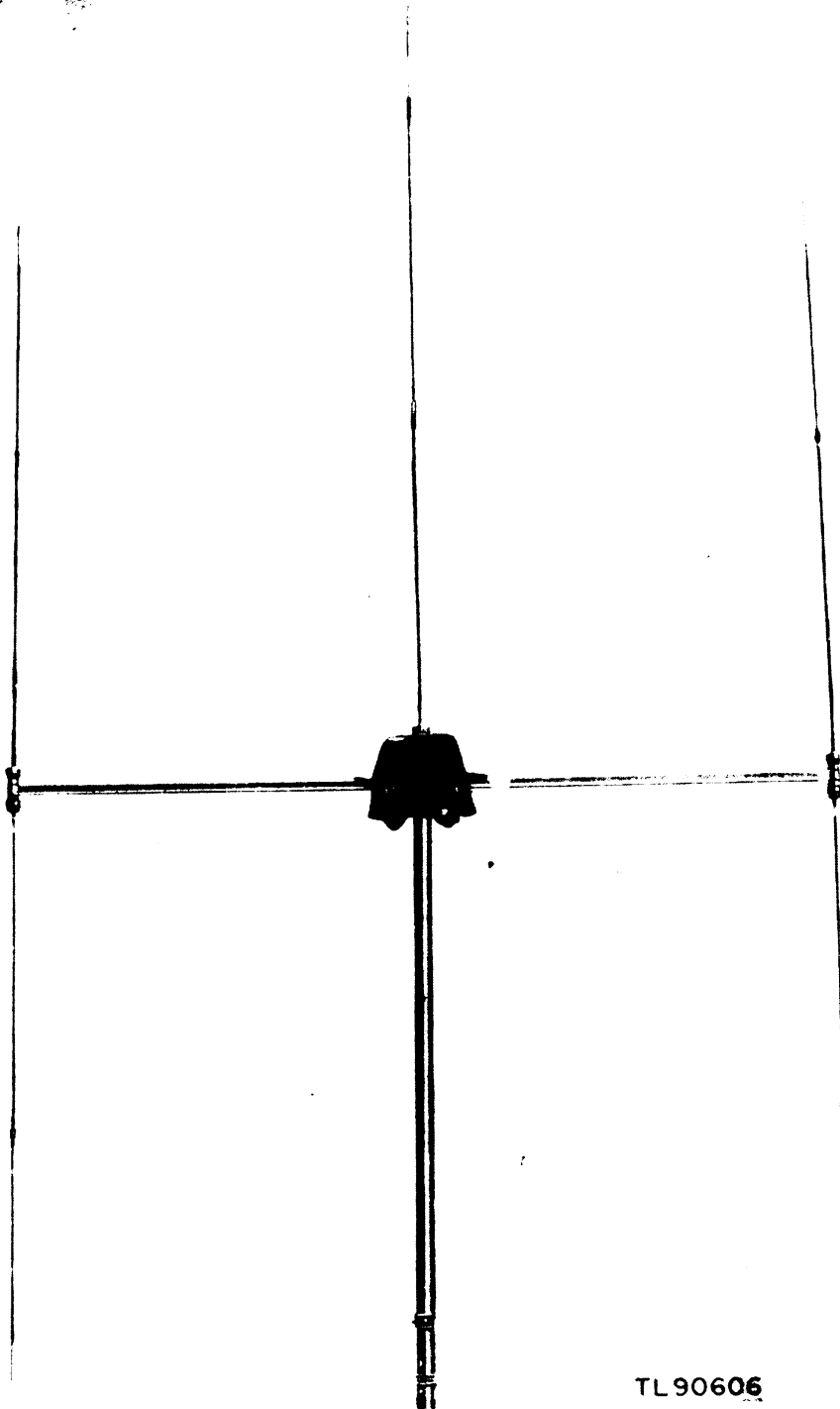

Figure 3. Antenna array, assembled.

(4) At the top of the mast is mounted the phase-load box (figs. 4 and 5), which has a canvas protected sheet metal case. Slots at each end are provided for the

insertion of two Crossarms M-407 and M-408. These crossarms support the Adcock elements. A female connector in the top of the box allows for mounting the vertical dipole consisting of Mast Sections MS-51, MS-50, and MS-121. Mast Section MS 121, forming the tip of the vertical dipole, is removed when the beacon is operated with Radio Set SCR-608-(&) on frequencies of 29-38.9

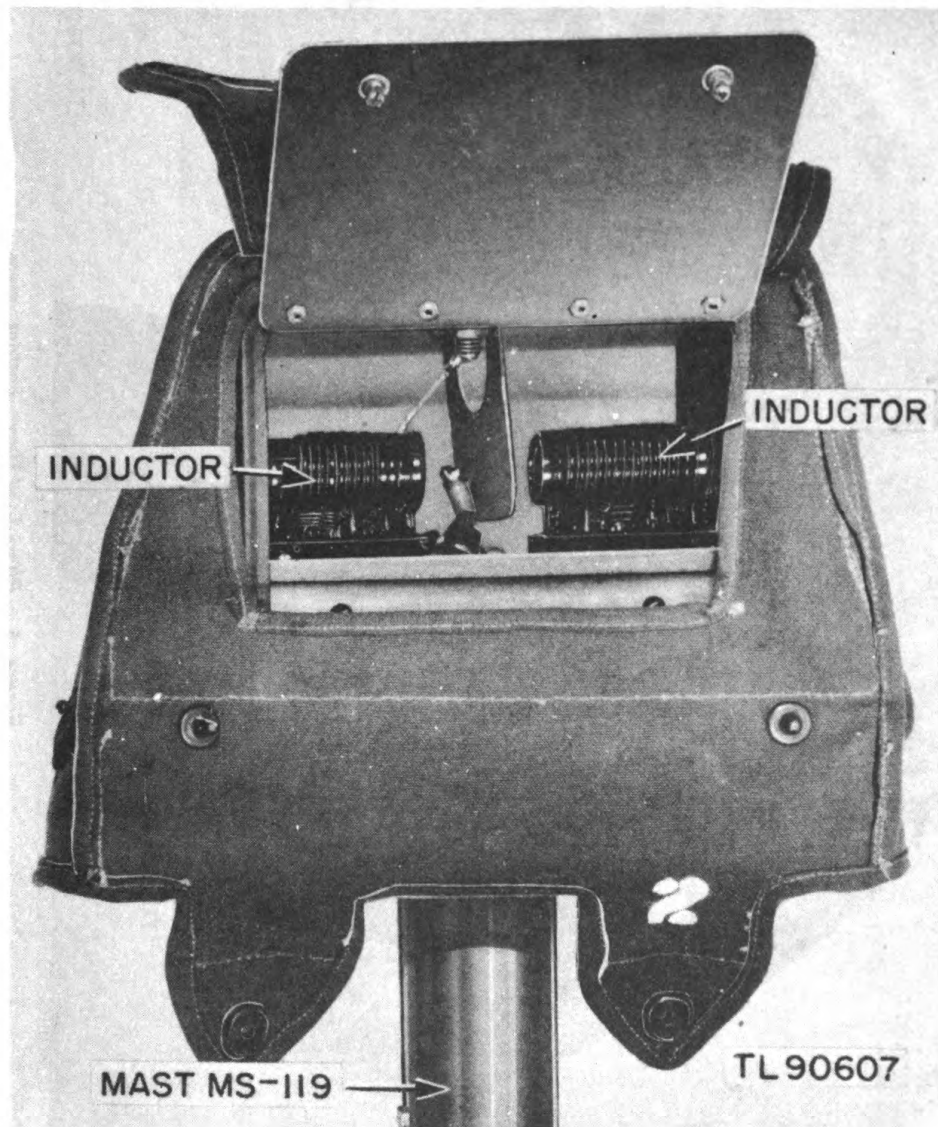

Figure 4. Phase-load box, side view.

megacycles. Two inductors plug into the phase-load box and are tuned by variable capacitors which are mounted so their tuning shafts protrude through the bottom of the box (fig. 5) and are turned by dials. Two finger-operated rim locks hold the dials in position once the desired setting is secured.

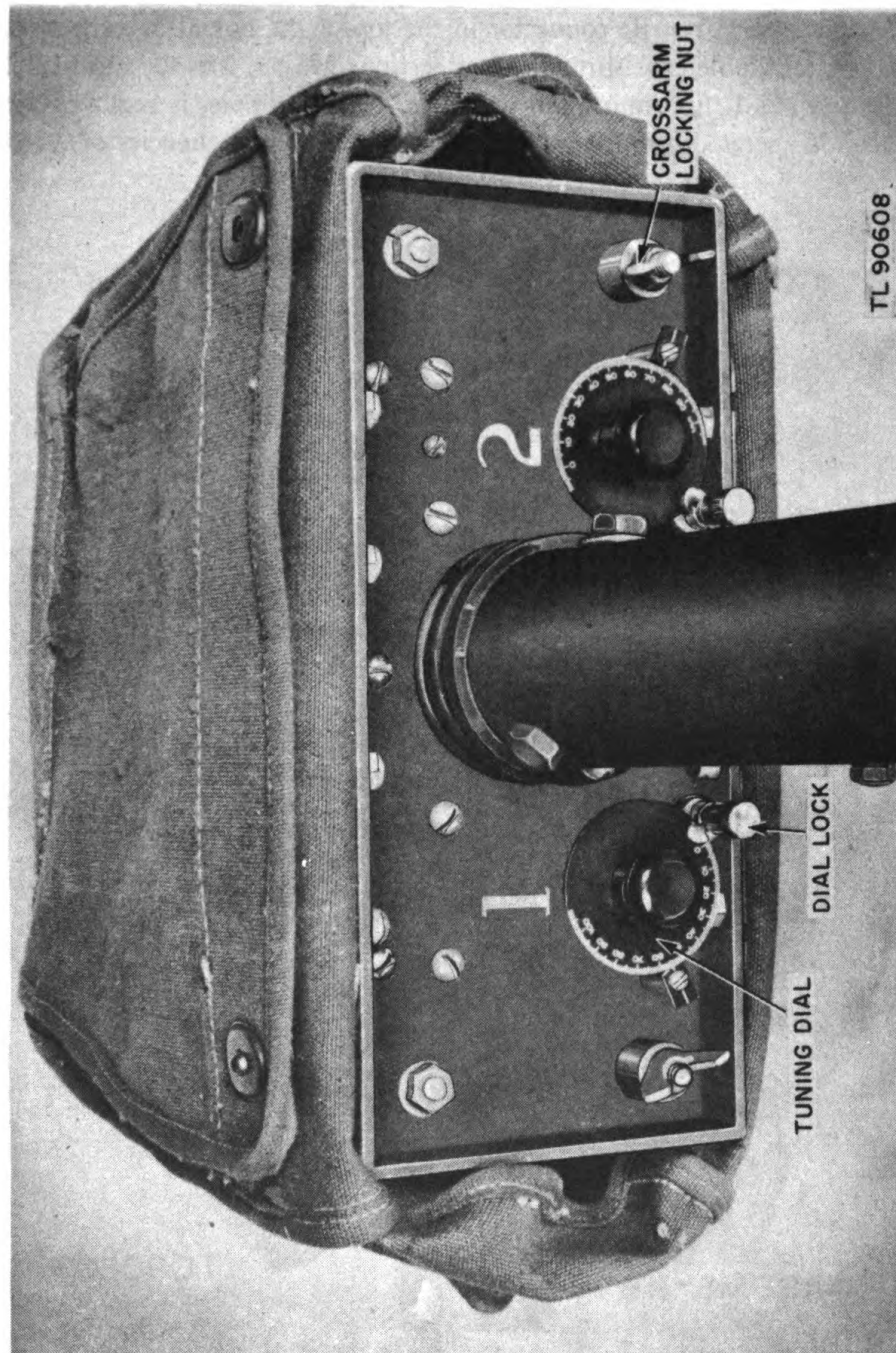

Figure 5. Phase-load box, bottom view.

c. Adcock-type Antenna. (1) Two crossarms M-407 and M-408 (fig. 6) consists of 46-inch lengths of 1-inch square metal tubing. Within each crossarm is a two-wire transmission line which connects the Adcock elements. The line is supported by feed-through insulators at one end and terminates in a female plug inserted into the other end. The crossarms are marked and the plugs are

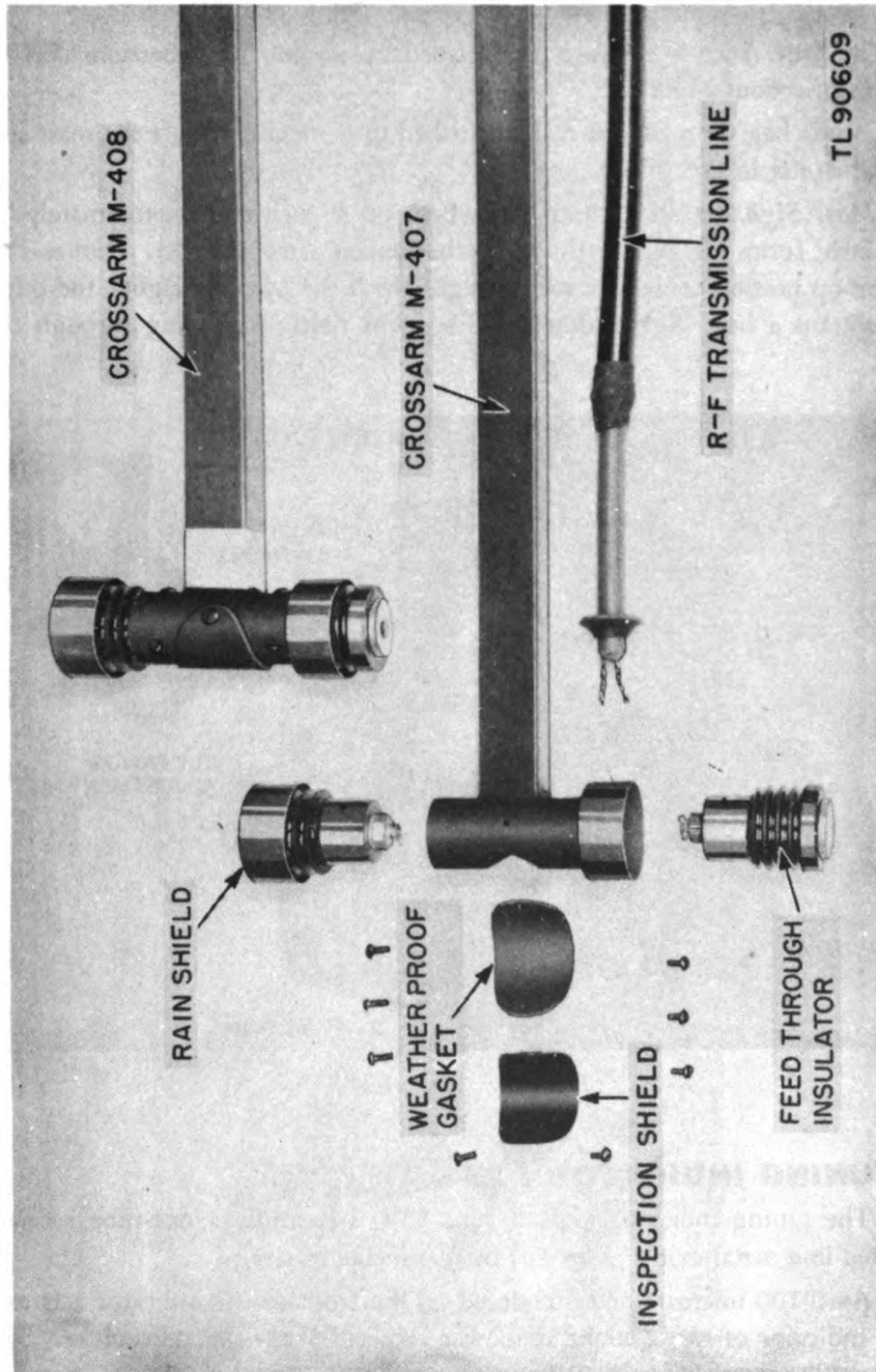

Figure 6. Crossarms M-407 and M-408.

polarized to make certain the arms are inserted in the correct socket. The null, Crossarm M-408, is marked with white painted stripes.

601736 O - 44 - 2

- (2) A canvas cover, Bag BG-179, is furnished to protect the crossarms when not in use.
- (3) The four Adcock elements are formed by joining Mast Sections MS-50 with Mast Sections MS-120.
- (4) Canvas bag, Roll BG-56-A, is furnished to store and protect the mast sections when not in use.

d. Mast Sight. A short metal strip, bent up at each end approximately $\frac{3}{4}$ of an inch, forms a sight for lining up the beacon array (fig. 7). One end of the bent-up portion contains a slit through which the operator sights, the other end contains a hole with a thin metal strip or hairline running through the center.

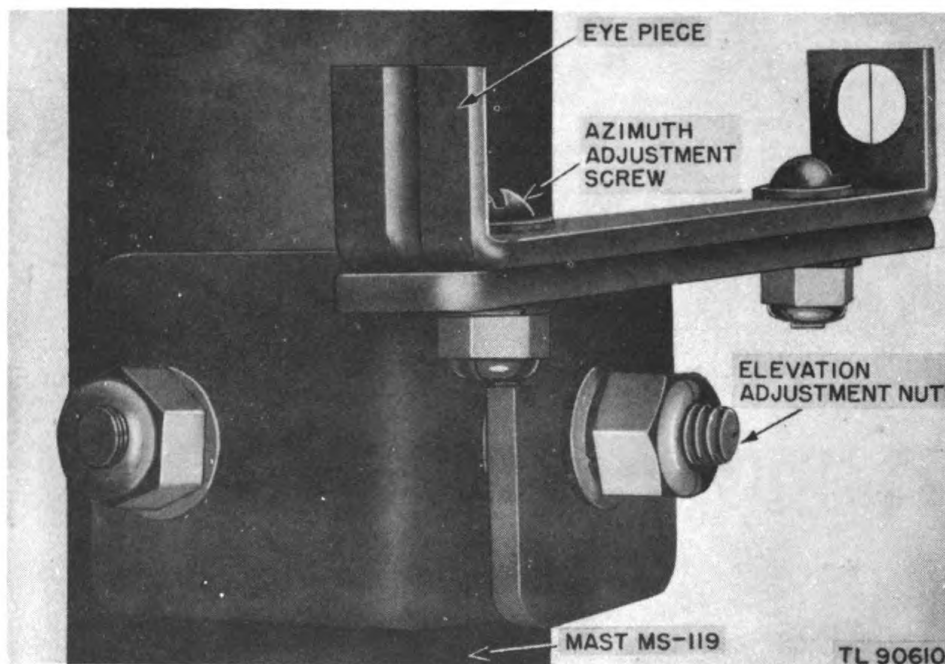

Figure 7. Mast sight.

9. TUNING INDICATOR I-234.

- a.* The tuning indicator (figs. 8 and 17) is basically a one-tube receiver mounted in a metal case $5\frac{1}{4}$ by $4\frac{1}{2}$ by $6\frac{1}{2}$ inches in size.
- b.* An 0-100 microammeter mounted on the front of the indicator acts as a visual indicator of the amount of power received from the transmitter. The pointer of the meter is luminous for night readings.
- c.* A telescopic antenna is fastened permanently to the indicator.
- d.* A calibration chart is mounted on the removable back of the tuning indicator. This chart gives approximate dial settings.

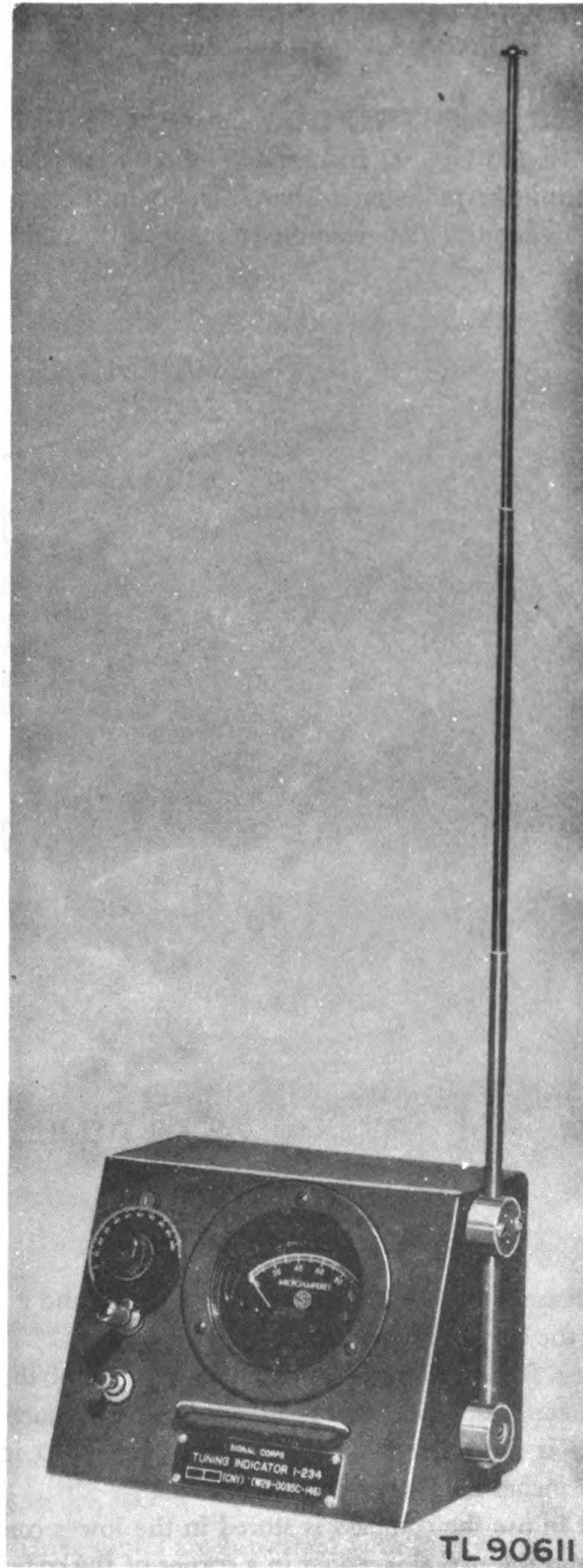

Figure 8. Tuning Indicator I-234.

e. Necessary power for operation of the indicator is furnished by a self-contained battery, Battery BA-15-A.

10. COMPASS AND TRIPOD.

a. Compass MC-323 (fig. 9) and tripod (fig. 10) are issued with each radio beacon for orienting the radiation pattern. The 5-inch compass with a 4-inch pointer and azimuth calibration reading from 0-360° counterclockwise, has a

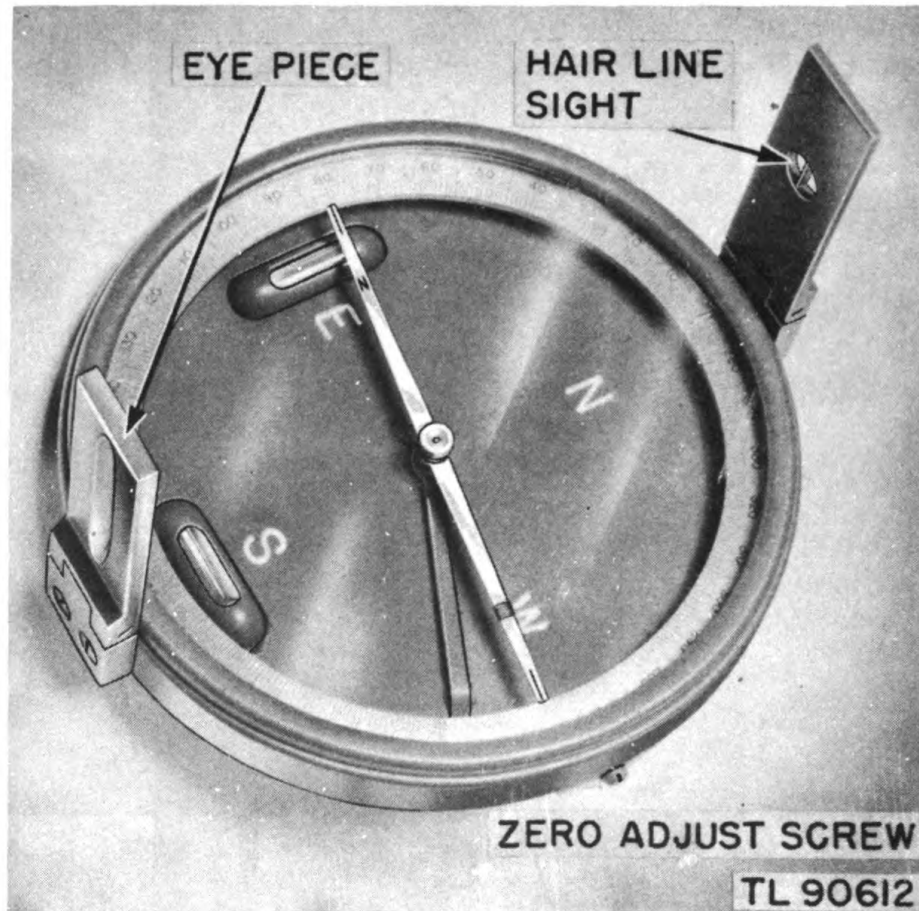

Figure 9. Compass MC-323.

ball and socket mount adapter, built-in levels, a zero set, and a screw for locking the needle when the compass is not in use.

b. Two vertical folding sights are placed on the case of the compass so that a line through them passes through the 0-180 degree divisions on the scale.

c. The tripod is the telescoping type approximately 20 inches long when collapsed and 47 inches long when extended.

d. When not in use the compass is stored in the lower compartment of the antenna mount and the tripod is stored in a corner of the code-keyer well.

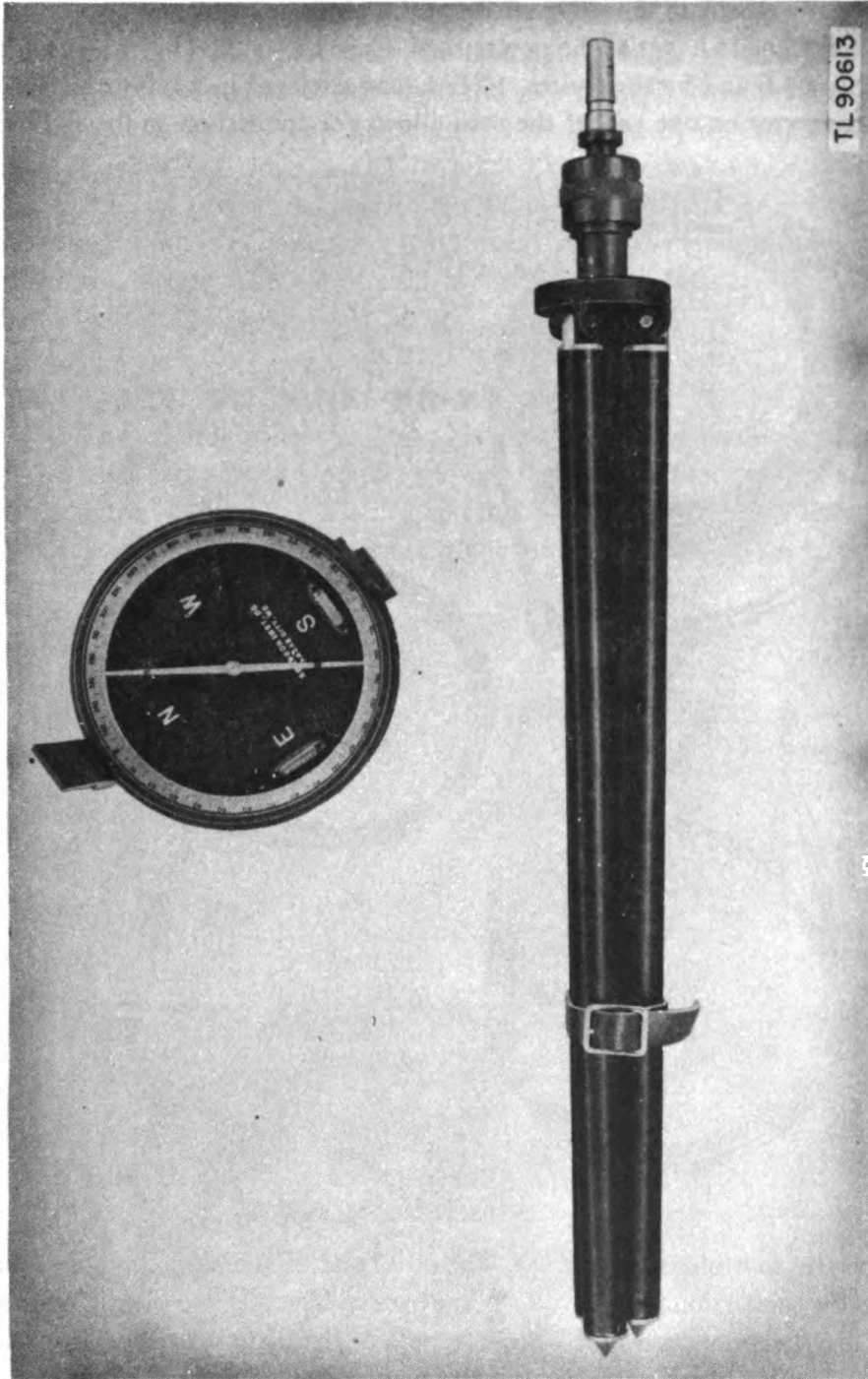

Figure 10. Compass and tripod.

11. CABLES.

a. General. Three cables are furnished with the beacon equipment for connecting the beacon to the transmitter being used. All the cables are 10 feet long.

These lengths are longer than necessary for average installations, but the surplus allows for any repairs of defective wiring at the plugs or lugs.

- b. Cord CD-1151.* (1) The power cord, Cord CD-1151 (fig. 11), consists of two No. 14 B and S gauge wires, 10 feet long enclosed in a rubber sheath. (2) A connector on one end of the cord allows for connection to the POWER

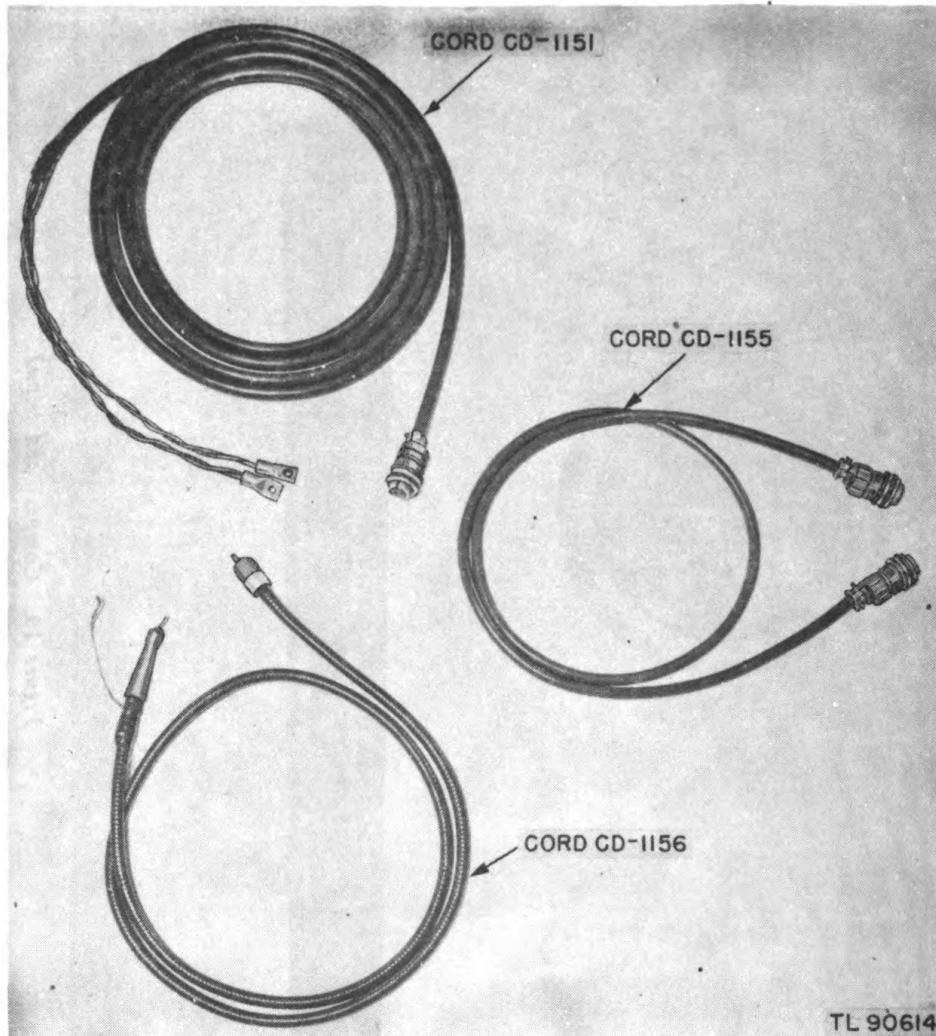

Figure 11. Cords CD-1151, CD-1155, and CD-1156.

socket on the control panel (fig. 2). The other end of the cord contains 2 battery lugs for connection to a 12-volt storage battery. The lugs are plainly marked; the red lug for connection to the positive pole of the battery, and the black lug for connection to the negative side of the battery.

- c. Cord CD-1155.* (1) The audio cord, Cord CD-1155 (fig. 11), consists of two shielded No. 18 B and S gauge wires covered with a rubber sheath. The cord is terminated on one end by a three-prong connector for connection to the MODULATION OUTPUT control socket (fig. 2) on the panel and the other

end is terminated by a four-prong connector which plugs into the magnetic microphone input on Radio Set SCR-508-(&) or SCR-608-(&). The C and D contacts of the connector carry the modulating audio voltage. The A and B contacts are shorted together within the connectors. This eliminates the use of a microphone switch. The transmitter is controlled by its ON-OFF switch.

d. Cord CD-1156. Cord CD-1156 (r-f coaxial cable) (fig. 11) is a flexible two-conductor coaxial cordage which is intended for transmission of high-frequency current. The inner wire is one conductor and the outer shield acts as the other conductor. The entire cord is vinyl covered to prevent damage to the shield.

12. CONTROL PANEL PN-26.

a. The control panel (fig. 12), is recessed in the bottom of the antenna mount and is protected from the weather by a canvas flap. All external connections to the beacon are made through this panel. The r-f cable from the transmitter is attached to the resonance tuner through a large opening in the top of

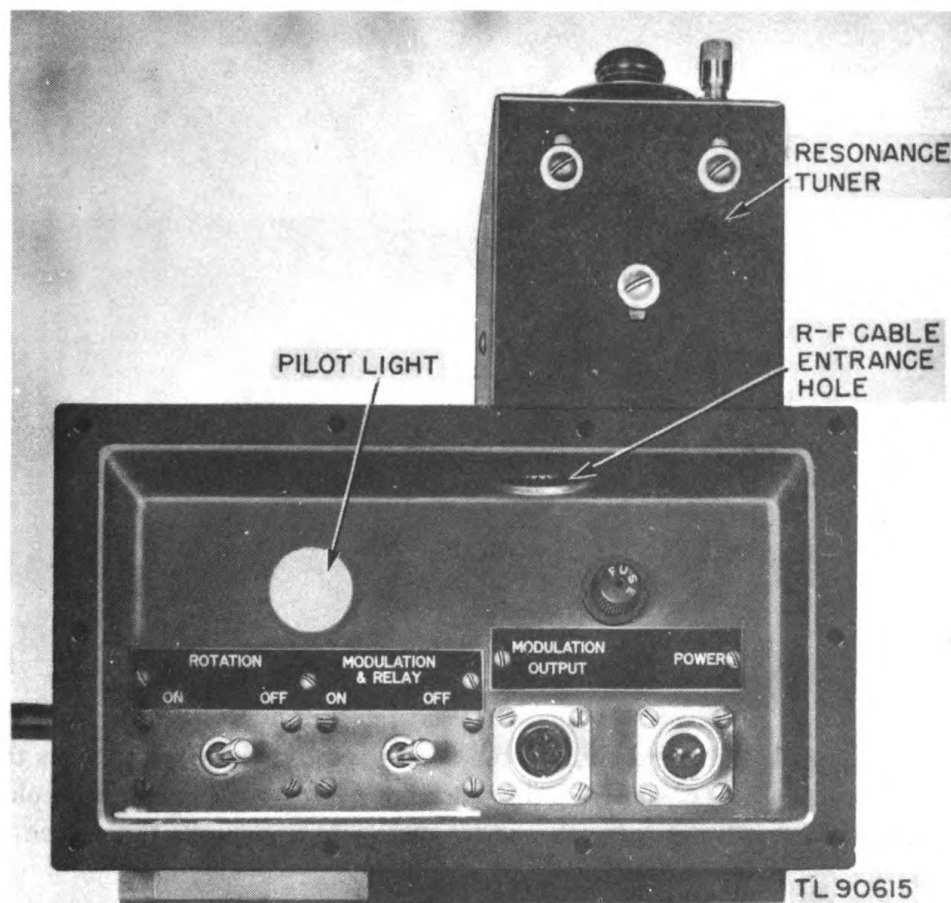

Figure 12. Control Panel PN-26.

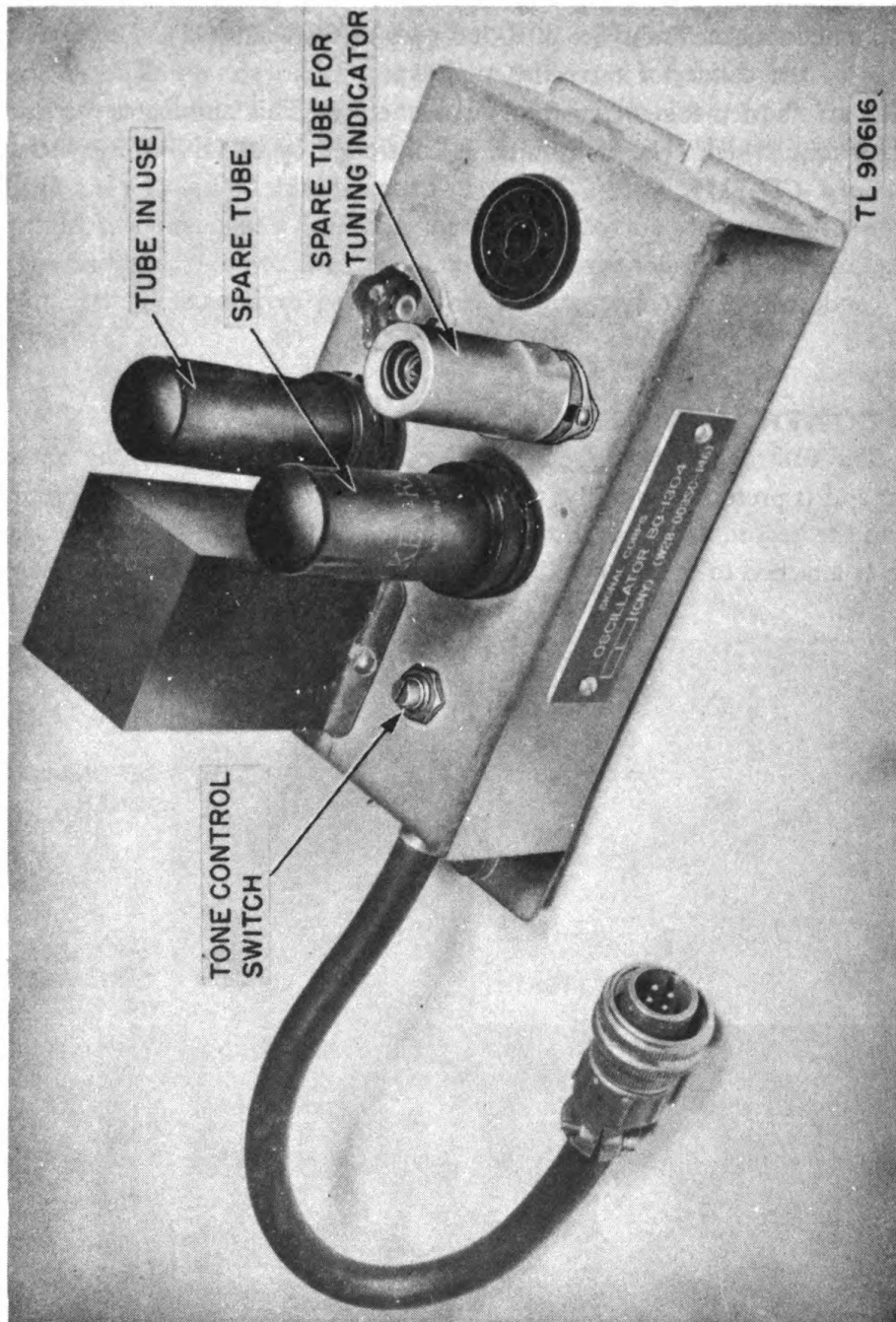

Figure 13. Oscillator BC-1304.

the control panel. An audio outlet is provided for the cable which delivers the keyed audio-frequency power from the beacon to the magnetic microphone plug on the transmitter and also for the power cable which connects the beacon to the 12-volt d-c power source.

b. A fuse is located in a fuse extractor post on the front of the panel. A toggle switch marked **ROTATION** controls the motor which drives the beacon

array. The toggle switch marked MODULATION & RELAY controls the filament voltage of the audio tube and applies voltage to the relay keyed by the rotating code disc.

13. OSCILLATOR BC-1304. The audio oscillator (fig. 13), consists of a $\frac{1}{16}$ -gauge metal chassis $3\frac{3}{4}$ inches by $6\frac{1}{2}$ inches by $1\frac{13}{16}$ inches, upon which is mounted an audio transformer, 2 small octal sockets, 3 large octal sockets, a 5-point switch, and a 12-inch 4-wire cable with an amphenol connector. The audio oscillator uses a pentode 12A6 tube, one to be used and one to be carried on the chassis as a spare. A spare 1S4 tube for the tuning indicator is also carried on the chassis. The entire oscillator assembly is mounted within the antenna mount on a shock-proof plate. A Dzus fastener facilitates installation or removal of the oscillator and eliminates the need of tools.

14. RESONANCE TUNER BC-1305. The resonance tuner (fig. 14), is a $\frac{1}{16}$ -gauge, olive drab finish, cold-rolled steel box housing a stationary coil of two windings and a variable capacitor. One side of the box is removable

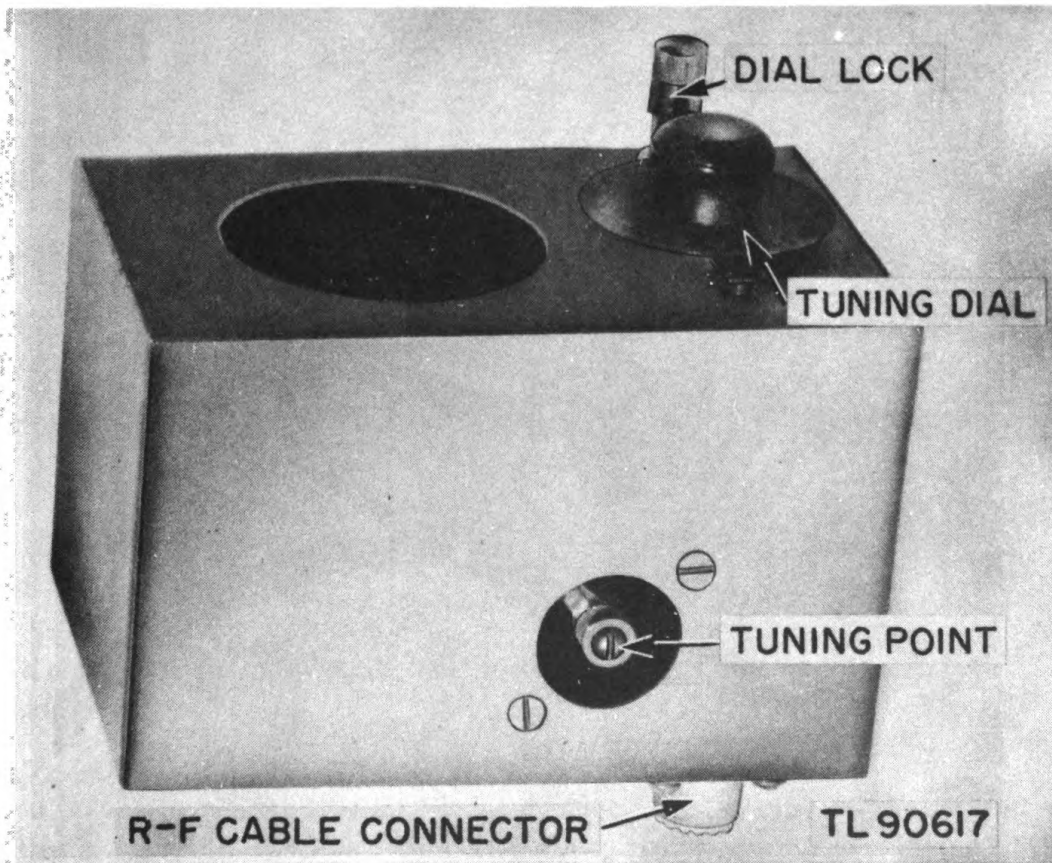

Figure 14. Resonance Tuner BC-1305.

for quick inspection or servicing. A Dzus fastener holds this side in place. The r-f transmission cable connects to an amphenol connector in the bottom of the box. On the left side of the box in the center of a circle of polystyrene insulation is a screwhead used when tuning by a neon glow lamp. An oversize hole in the top of the box provides for the entrance of the rotating link into the stationary coil. A 0-100 scale dial tunes the variable capacitor, and a dial-rim lock is provided to hold the desired setting. A calibration chart is mounted on the door of the antenna mount.

15. MOTOR. A d-c, 12-volt, $\frac{1}{12}$ -horsepower motor, shunt wound, with a built-on reducer (fig. 15), is coupled to a worm drive which engages a 7-inch worm gear to rotate the antenna array and the automatic code keyer at $2\frac{1}{2}$ rpm. The motor input to the reducer is 1,725 rpm, and the motor output to worm gear is 43 rpm.

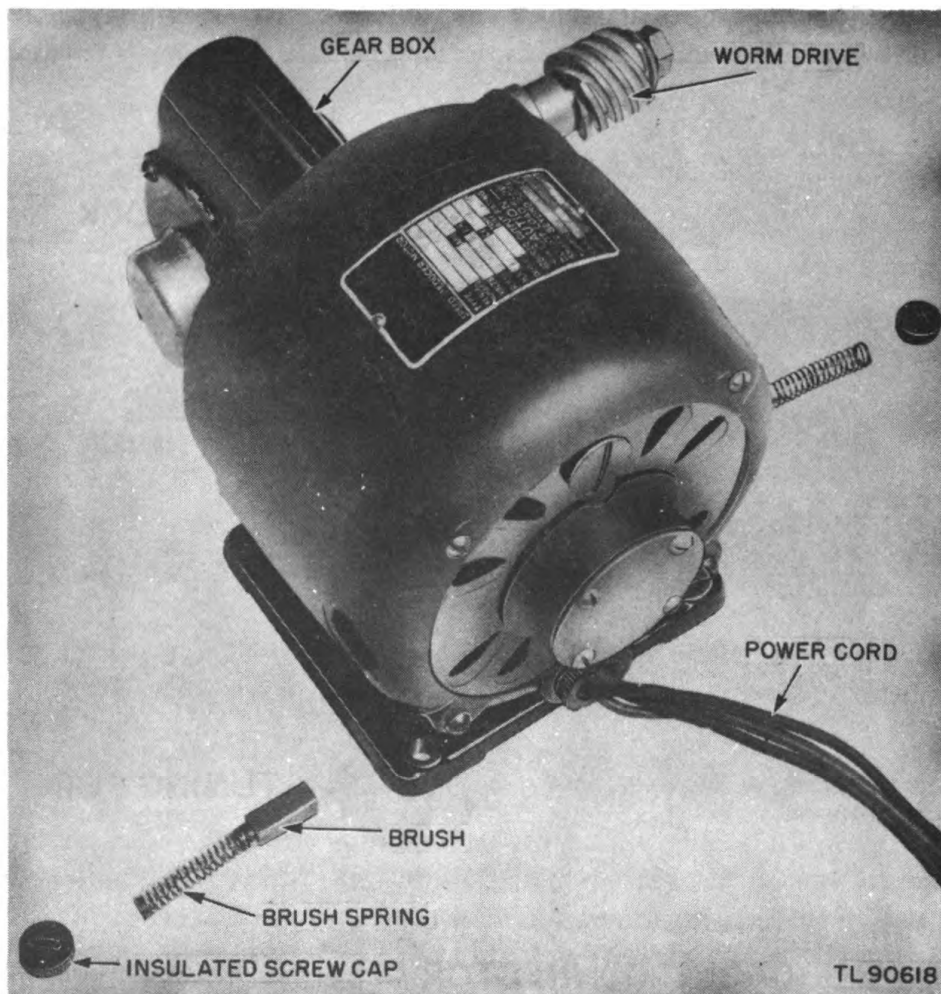

Figure 15. Motor.

16. CLUTCH. The floating clutch (fig. 16) is made up of a collar with three pins protruding downward into the special drive worm gear. The clutch is activated by a lever operated externally at the top of the antenna mount by means of an inverted cup sliding on a grooved axle. The clutch is placed in neutral when the cup is pulled upward. Twisting the cup locks the clutch in neutral.

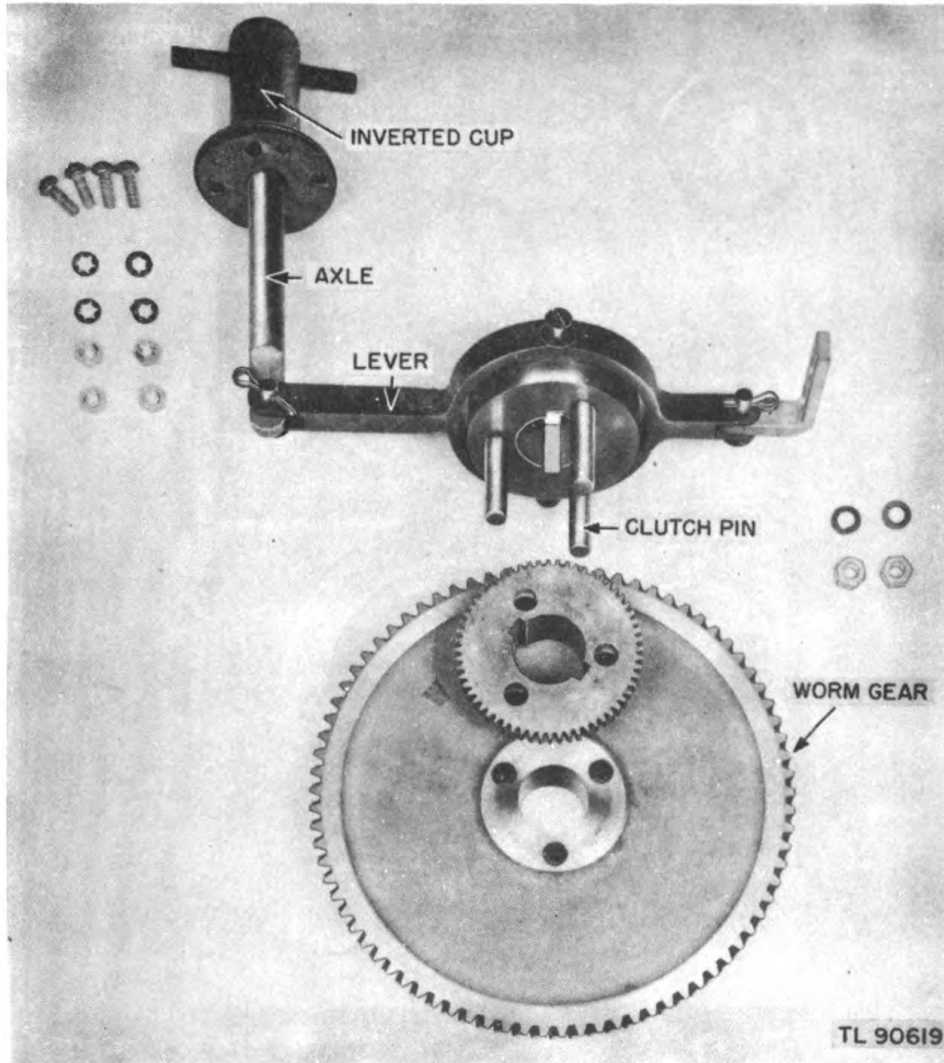

Figure 16. Clutch, exploded view.

To engage the clutch, twist the cup allowing the clutch pins to drop into position.

17. AUTOMATIC CODE KEYS.

a. The automatic code keyer (fig. 17), is located in the well on top of the antenna mount. A drive shaft extends up through the bottom of the well from the drive gear. This drive shaft supports a metal turntable to hold the code disc.

A phenolic and metal compression-insulator plate fits over the code disc and is held down by a large knurled nut that screws down on the threaded end of the

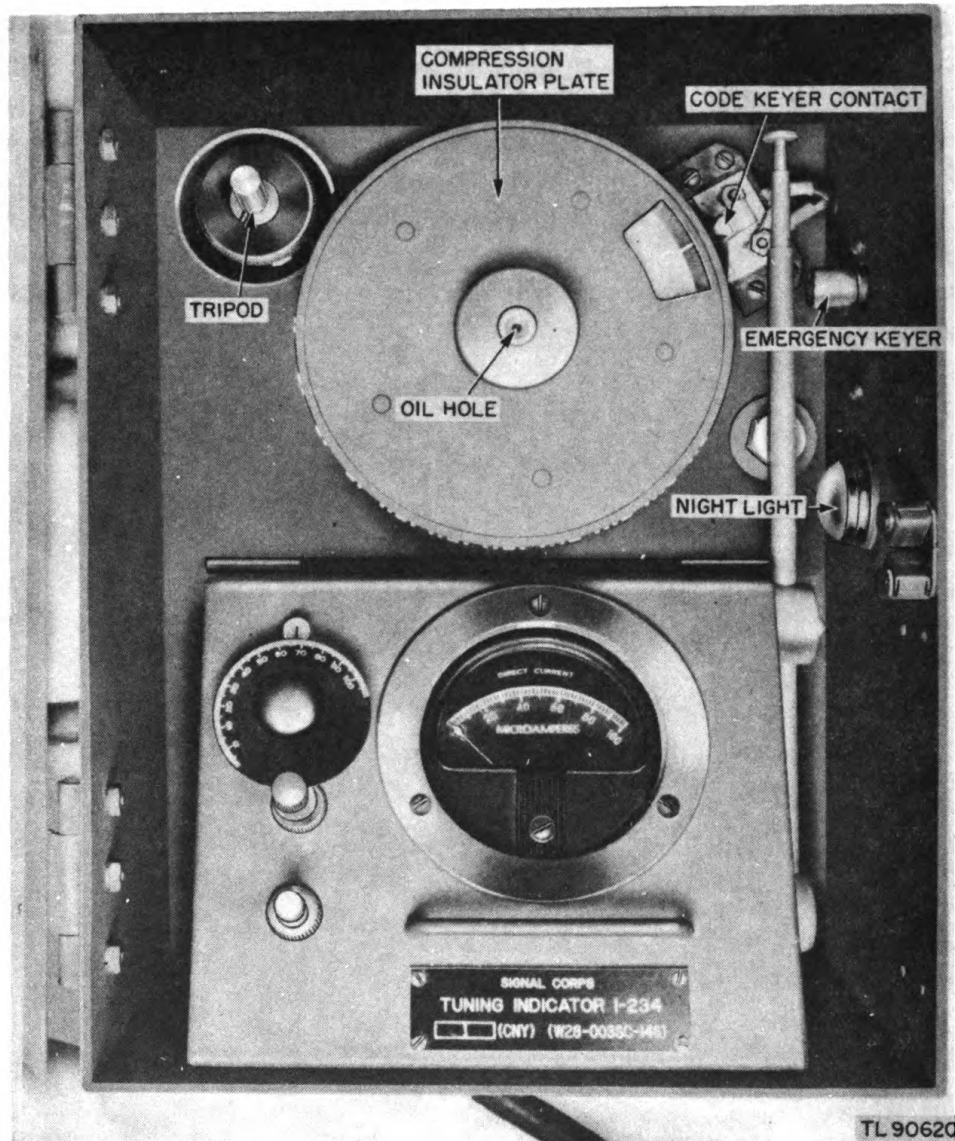

Figure 17. Code-keyer well.

shaft. The compression-insulator plate has an opening and index mark on its edge to line up the desired letter on the code disc with the code-keyer contact.

b. A small wedge-shaped stainless-steel contact, mounted on a vertical strip of beryllium copper, makes and breaks the contact as the toothed edge of the code disc rotates against it.

18. CODE DISC. The code disc (fig. 18), is a 16-gauge, stainless-steel disc $5\frac{1}{2}$ inches in diameter. The edge has teeth cut to form characters in International code when rotated against the V-shaped keying contact. Eight different characters, each repeated 3 times, make a total of 24 characters for the circumference of the disc. This divides the disc into 24 sectors of 15° , or one character for each sector. Each sector is stamped with the character and the number of its order in the group of three characters. These markings are visible through the opening in the compression-insulator plate when the code disc is in use. Both

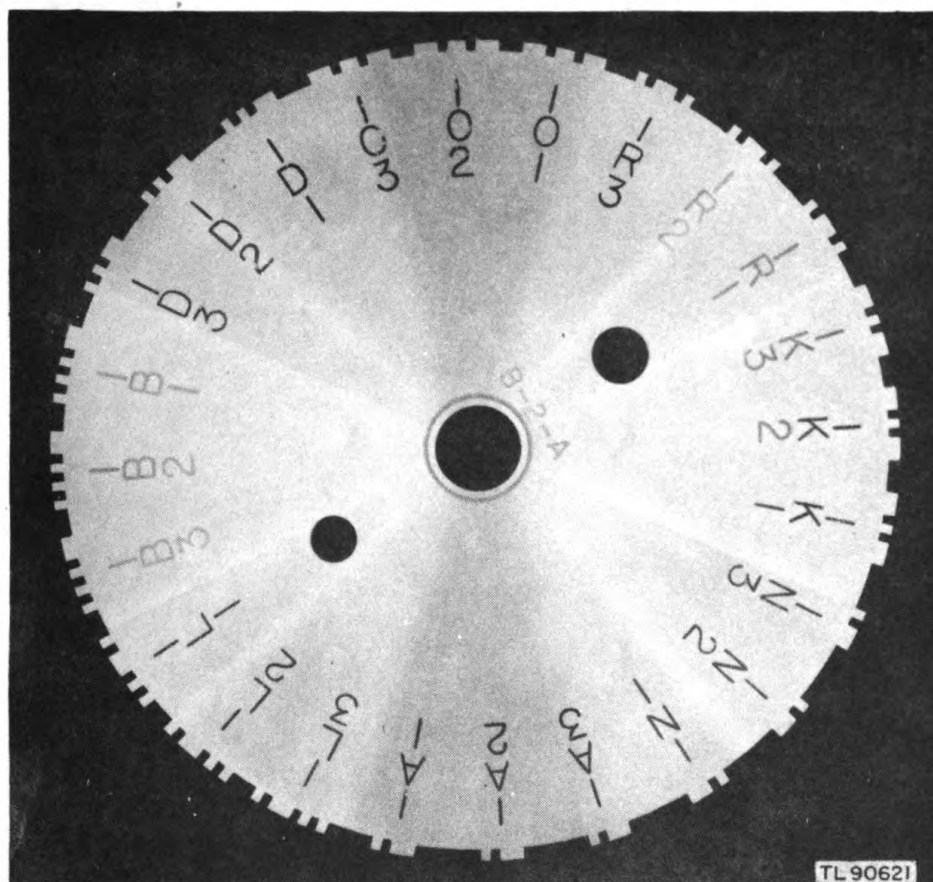

Figure 18. Code disc.

sides of each disc are marked and usable. Fifteen code discs, making a total of 30 usable codes, are issued and are stowed in the base of the antenna mount, but only one is used at a time.

19. EMERGENCY KEYS. A switch located on the side of the code-keyer well (fig. 17), activated by a push-button protruding into the well, may be used to manually key the transmitter with tone modulation for code communication.

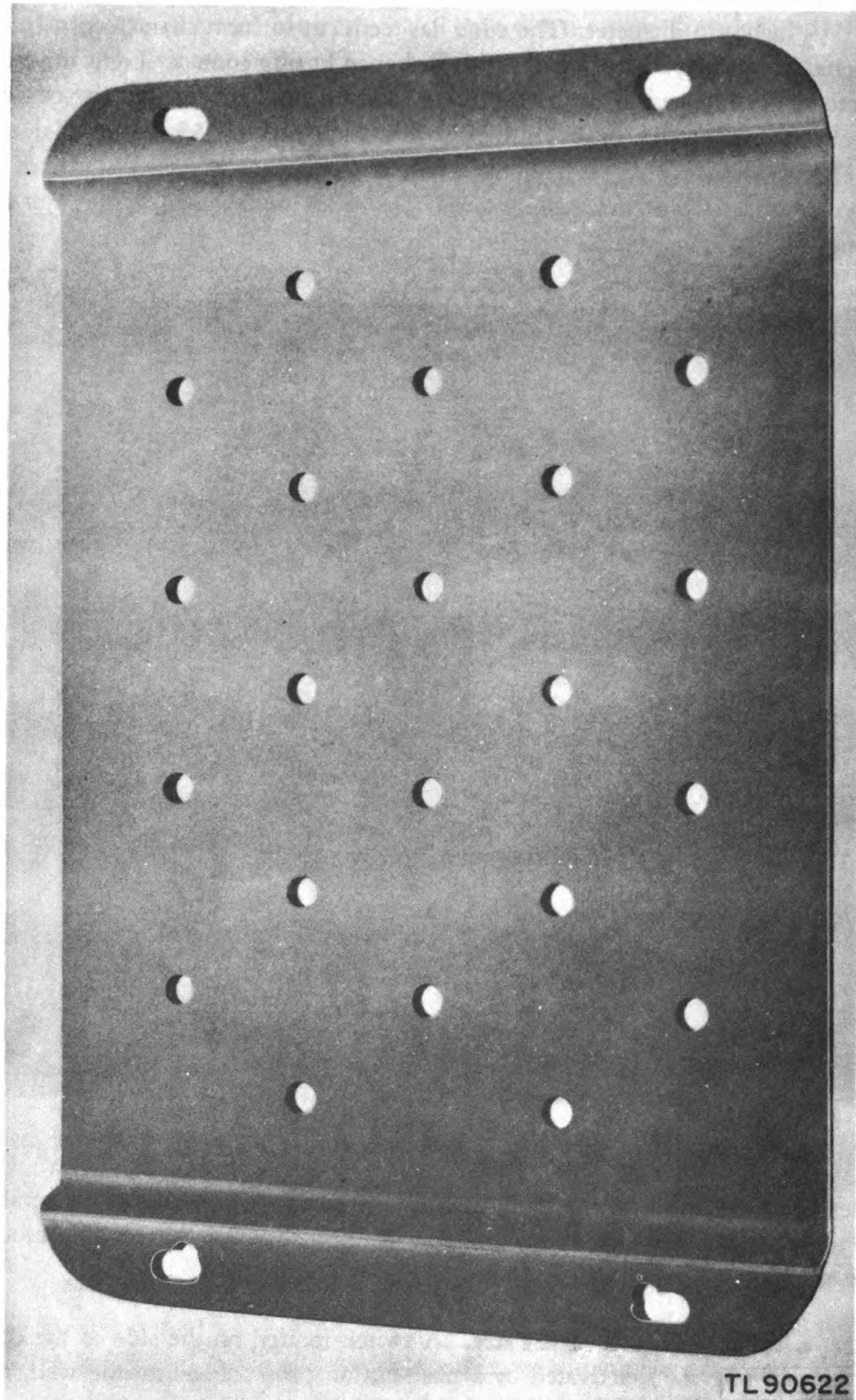

Figure 19. Mounting FT-492.

Description

20. MOUNTING FT-492. The universal mounting plate (fig. 19), consists of a piece of sheet steel 19 by 12 inches. A 1½-inch flange, the width of the plate, is bent-up at each end and drilled to accommodate the antenna mount. The flat portion of the plate is drilled with a total of 22 holes to facilitate mounting the beacon in various types of vehicles having predrilled holes, thus eliminating the necessity of boring holes in vehicles with armor plate. If, in any installation the rear holes are inaccessible for bolt tightening, two bolts can be installed upward on the plate, thus providing a quick and effective installation. The weight of the mounting plate is 11½ pounds.

SECTION II

Installation and Operation

21. GENERAL.

a. Only experienced and qualified personnel should attempt the alignment and adjustment of Radio Beacon Equipment RC-163. The beacon equipment



Figure 20. Bolting mounting plate to floor of vehicle.

is used in conjunction with the transmitter of Radio Set SCR-508-(&) or SCR-608-(&) and only personnel competent enough to adjust a transmitter of this type to different frequencies and antennas should attempt to tune the output of the transmitter to the beacon input.

b. Preset the transmitter push-buttons so the channels are pretuned to the desired frequencies. To do this follow directions in the instruction book for the

transmitter being used (TM 11-600, Radio Sets SCR-508-(*), SCR-528-(*), and SCR-538-(*), or TM 11-620, Radio Sets SCR-608-A and SCR-628-A.

c. When the 10 transmitter channels are correctly tuned, it is possible for relatively inexperienced personnel to operate the beacon on one or possibly more channels. If the transmitter channels are chosen so that they are not too far apart, then an adjustment of the beacon equipment may serve for as many as five to seven channels.

EXAMPLE: When the beacon is tuned to 26.7 mc, a useful pattern with slightly less output can also be obtained on 26.8 mc, 26.9 mc, 27 mc, 26.6 mc, 26.5 mc, or 26.4 mc. This is done by merely pressing the proper push-button on the transmitter panel.

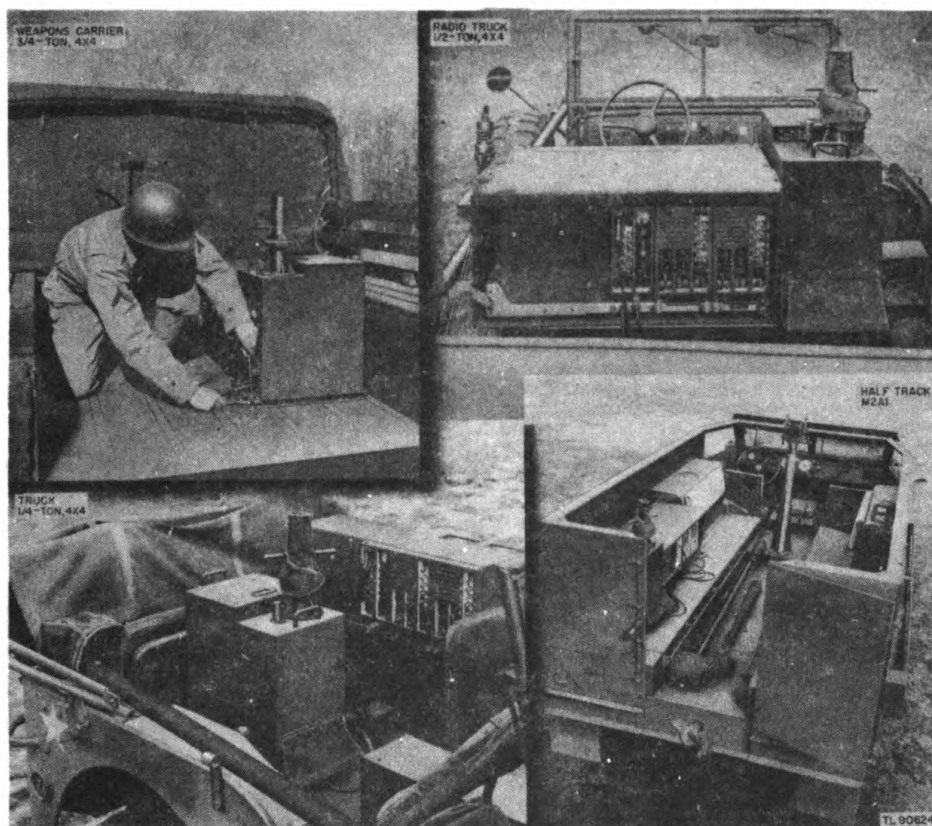

Figure 21. Beacon mounted in various vehicles.

22. INITIAL PROCEDURE.

a. Radio Beacon Equipment RC-163 is shipped from the manufacturer with the antenna array disassembled, but with all components of the antenna mount in place.

b. Unpack the equipment carefully to prevent loss or damage. Check against the list of components in paragraph 6.

601736 O - 44 - 3

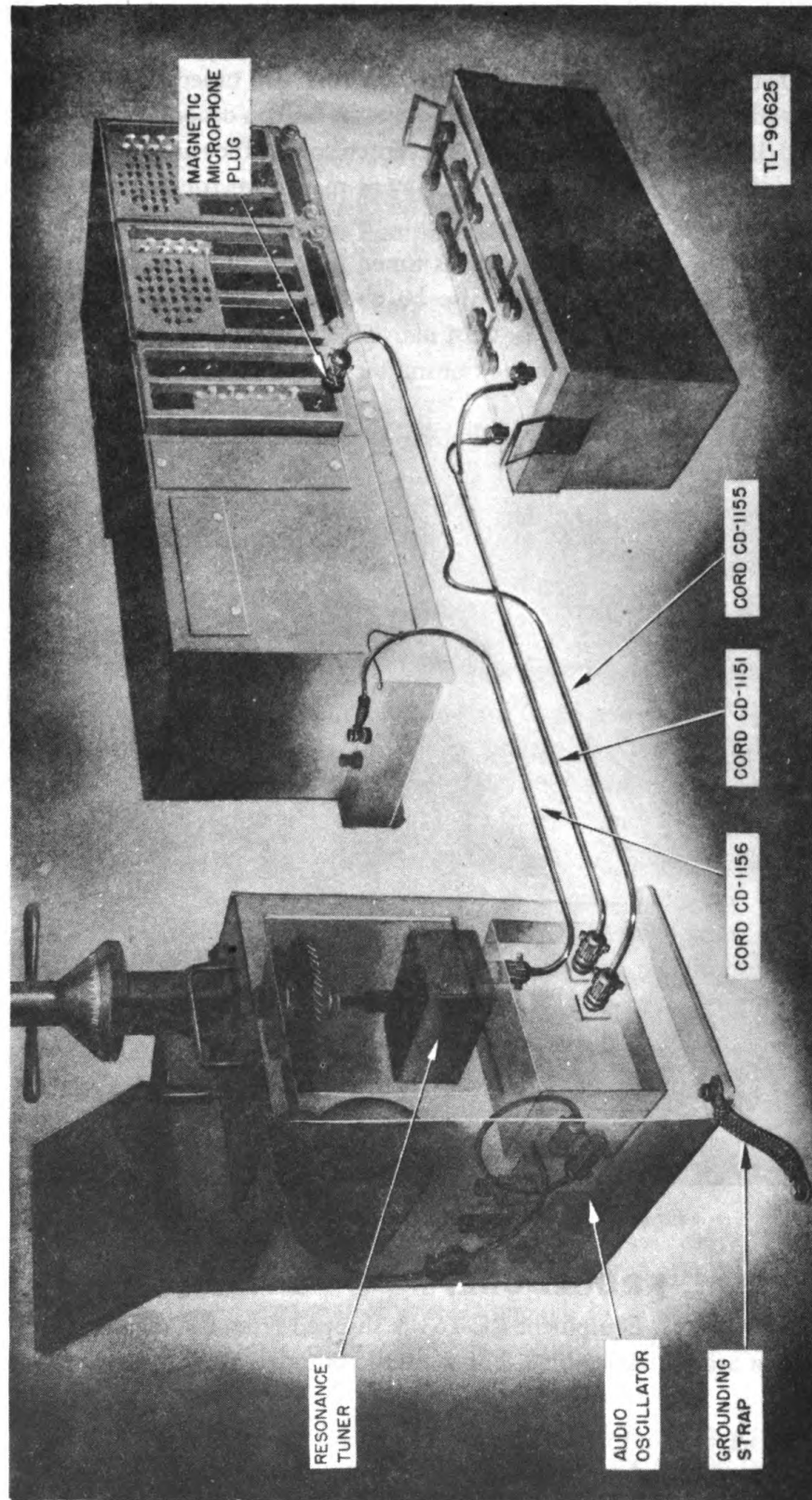

Figure 22. Cording diagram.

23. INSTALLATION.

a. Radio Beacon Equipment RC-163 can be installed in any vehicle having a Radio Set SCR-508-($\&$) or SCR-608-($\&$) installation and capable of accommodating the antenna array. Recommended vehicles include jeeps, half-tracks, command cars, and weapons carriers (fig. 21). If other than a recommended vehicle is used, make sure there is ample room for storage and the Adcock elements of the beacon array clear the metal sides or cab of the vehicle by at least 6 inches. This clearance is necessary to prevent antenna pattern distortion.

b. Bolt Mounting Plate Ft-492 to the floor of the vehicle, using any 2 or 3 of the 22 holes in the plate (fig. 20). Then bolt the antenna mount to the universal mounting plate flanges by two bolts in the front and two bolts in the rear. Ground the antenna mount with the grounding strap to the vehicle chassis. Position the antenna mount so the control panel is easily accessible.

CAUTION: The beacon is not designed for mobile operation with the antenna array set up. Always take the antenna array down before moving the vehicle. Serious damage to the antenna array and to the beacon may result from failure to follow this procedure.

24. CABLE CONNECTIONS.

CAUTION: When installing the cables run them so there will be no sharp bends, strain, or chafing points along their lengths. Run them as far out of the way as possible. Be sure to disconnect the transmitter power supply cable, Cord CD-278-A, from the battery before connecting the beacon.

a. *Cord CD-1151 (fig. 22).* (1) Plug the 2-contact plug of Cord CD-1151 into the terminal marked POWER on the control panel of the antenna mount. Screw the locking ring tight.

CAUTION: Do not use pliers.

(2) Take the other end of Cord CD-1151 and ground the black negative lug to any convenient point on the transmitter mounting. The screw connection marked X in figure 23 makes a good point to make the ground connection.

(3) Connect the white positive wire of Cord CD-1151 to the positive battery terminal of Radio Set SCR-508-($\&$) or SCR-608-($\&$).

NOTE: The easiest way to make connections described in subparagraphs (2) and (3) above is to remove the receiver from the radio set mounting, open the door in the mounting and thread the end of Cord CD-1151 through one of the knock-out holes in the side of the mounting base. The positive battery terminal is marked +12 OR 24V, and is the terminal on the right when facing the set.

CAUTION: The beacon equipment is designed for 12-volt operation. Do not use it with a 24-volt chassis.

(4) Loosen and remove the nut on the terminal, install the positive wire lug,

replace, and tighten the nut. Make the ground connection to the screw marked X in figure 23 or any other convenient point on the chassis.

CAUTION: Be sure the positive connection is made directly to the power supply nut. This avoids overloading the transmitter fuse. The beacon is protected by a 20-ampere fuse mounted in a fuse extractor post on its control panel.

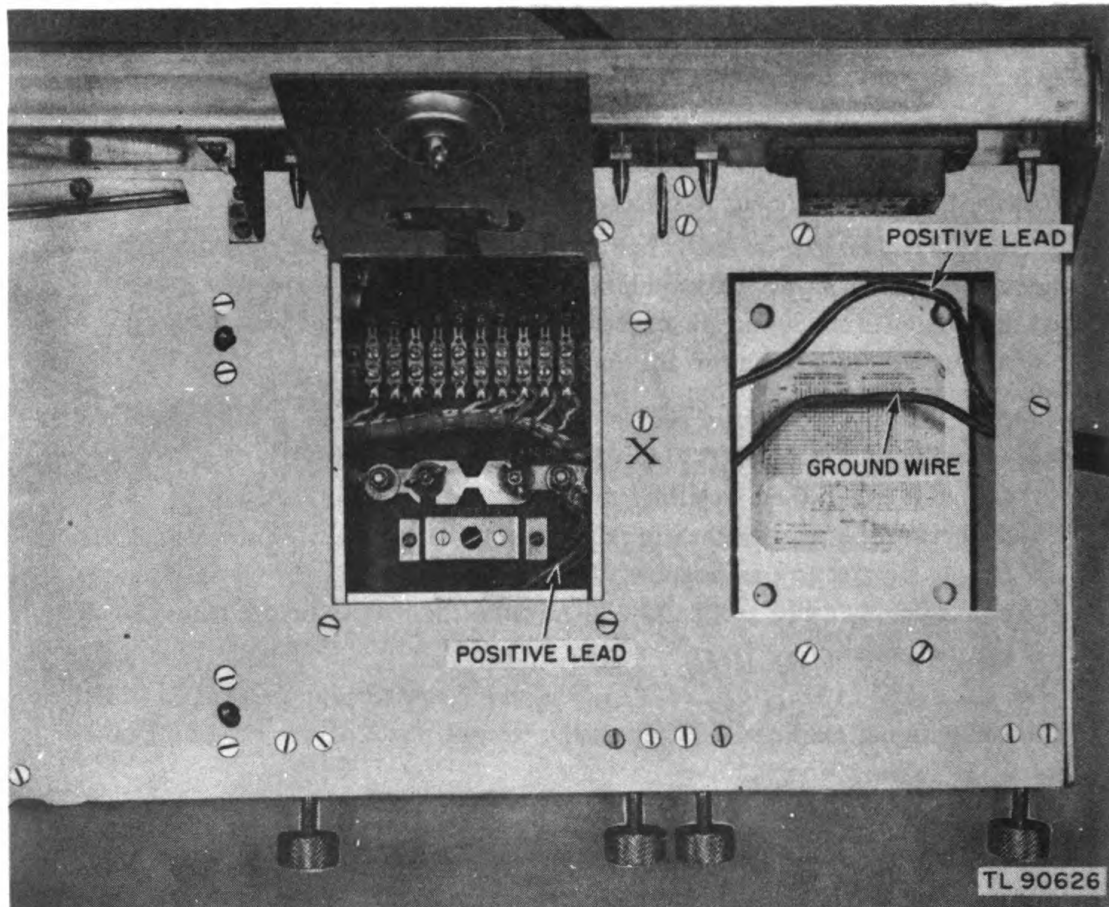

Figure 23. Transmitter base, ground connection.

(5) If a separate battery is used connect the black lug of Cord CD-1151 to the negative terminal of the battery and the red lug to the positive terminal.

b. Cord CD-1156. (1) Connect the plug end of Cord CD-1156 (r-f coaxial cable) to the resonance tuner through the large clearance hole in the top of the beacon control panel on the antenna mount (fig. 22).

(2) Connect the central conductor on the other end of Cord CD-1156 to the TR binding post on the end of the transmitter mounting and ground the coaxial cable sheath to the unmarked grounding screw next to the TR binding post (figs. 22 and 24).

NOTE: A substitute connection for the r-f coaxial cable may be made to the transmitter by connecting the central conductor of Cord CD-1156 to the binding post marked A which is located above the push-button tuning panel on the transmitter. Ground the coaxial-cable sheath to the binding post marked G. This substitute connection is not recommended as the binding posts are close together and short-circuiting may occur.

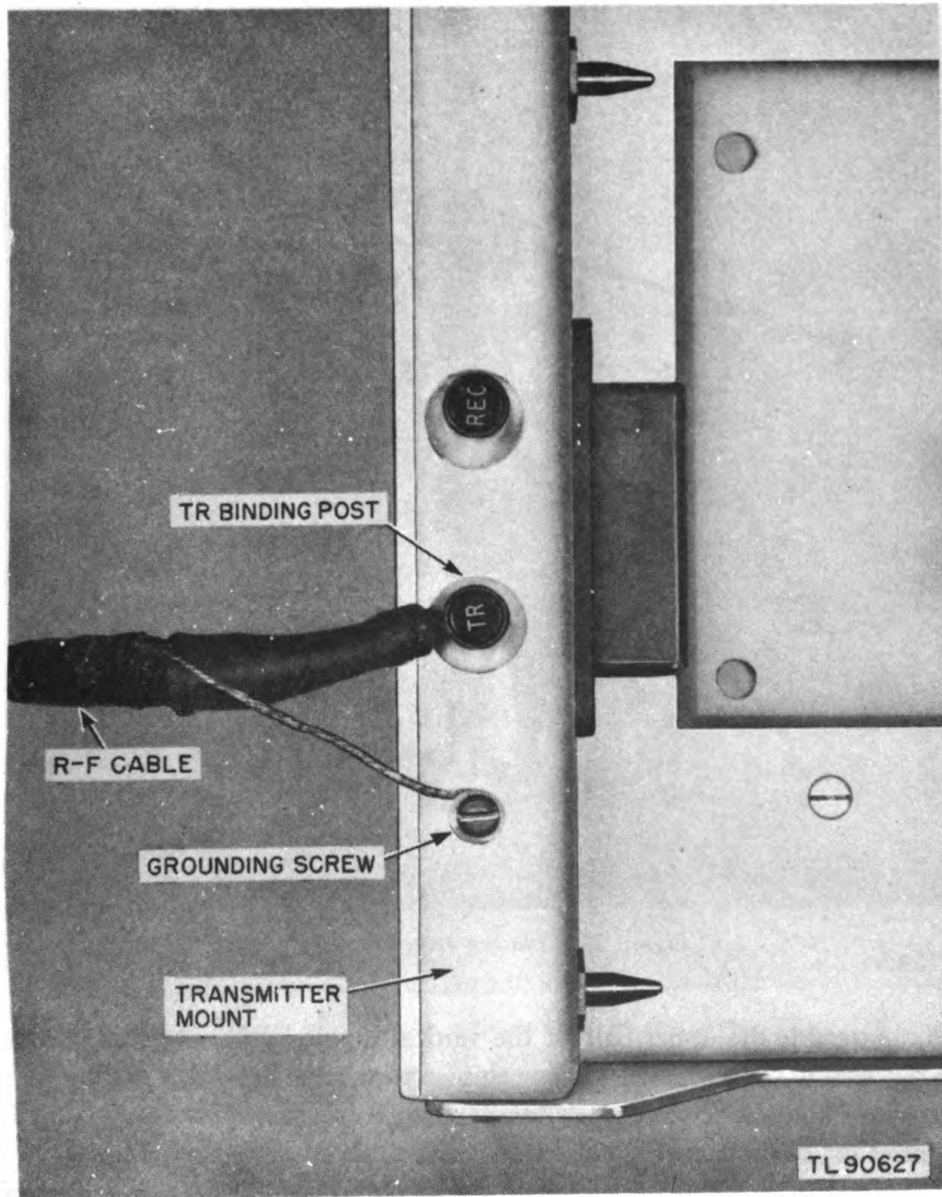

Figure 24. R-f cable connection to transmitter.

25. ASSEMBLY OF ANTENNA ARRAY.

a. Raise Mast MS-119 so its top is shoulder high while the lower end rests on the ground or floor of the vehicle on a clean surface so dirt will not get in

and foul the contacts. Slip the end of each crossarm into its proper socket in the phase load box on top of Mast MS-119. The white-stripped Crossarm M-408, fits into the slot marked in white paint with the figure 2 (fig. 25). Tighten the wingnuts on the bolts to secure the crossarms in their sockets.



Figure 25. Placing crossarms in mast.

b. Assemble the upper half of the vertical dipole by joining Mast Sections MS-51, MS-50, and MS-121. Screw this antenna into the socket on top of the phase load box. When using the beacon with Radio Set SCR-608-($\&$) on frequencies of 29 to 39 megacycles remove the small Mast Sections MS-121 from the vertical dipole. This tip is used only with Radio Set-508-($\&$) on frequencies of 20-27.9 megacycles (fig. 26).

CAUTION: When joining mast sections be sure to place lockwashers between each joint. Make sure all connections are clean, paint-free, tight, and make good electrical connection. This is important as the

beacon will not work unless all parts of the antenna array are functioning. Once the mast sections are assembled do not take them apart for storing unless necessary. This will save a lot of time in reassembling the beacon.

c. Assemble the antenna array by first joining four Mast Sections MS-50 with four Mast Sections MS-120. Screw the four resulting lengths into the sockets in the outer ends of each crossarm (fig. 26).

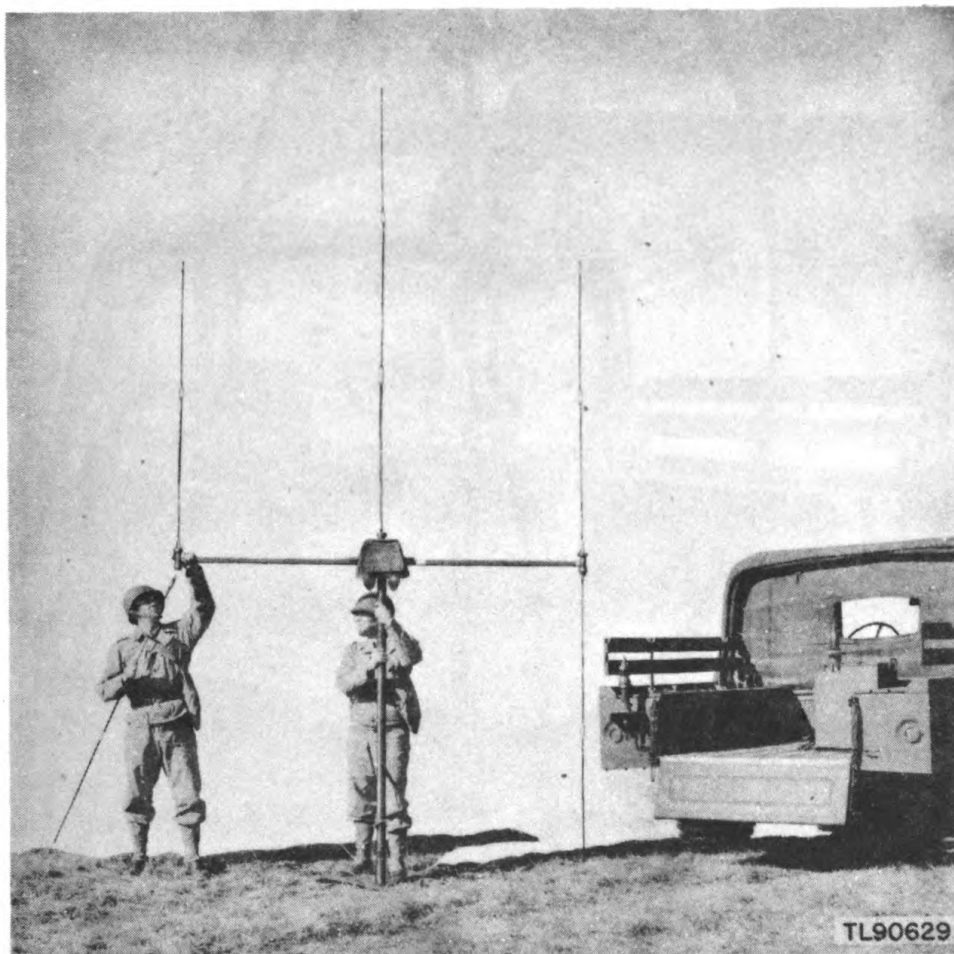

Figure 26. Placing mast sections in crossarms.

CAUTION: Hand tighten the antennas into their sockets sufficiently to avoid having them loosen up and fall out from vibration when the antenna array is rotating. Do not use abnormal force or an insulator may be cracked.

d. Lift the antenna array bodily and place it over the stub projecting from the top of the antenna mount (fig. 27). Slip the socket on the bottom of the mast down over the stub, and turn the mast until it aligns with the keys on the side of the stub. Push the mast down to seat it firmly on the stub.

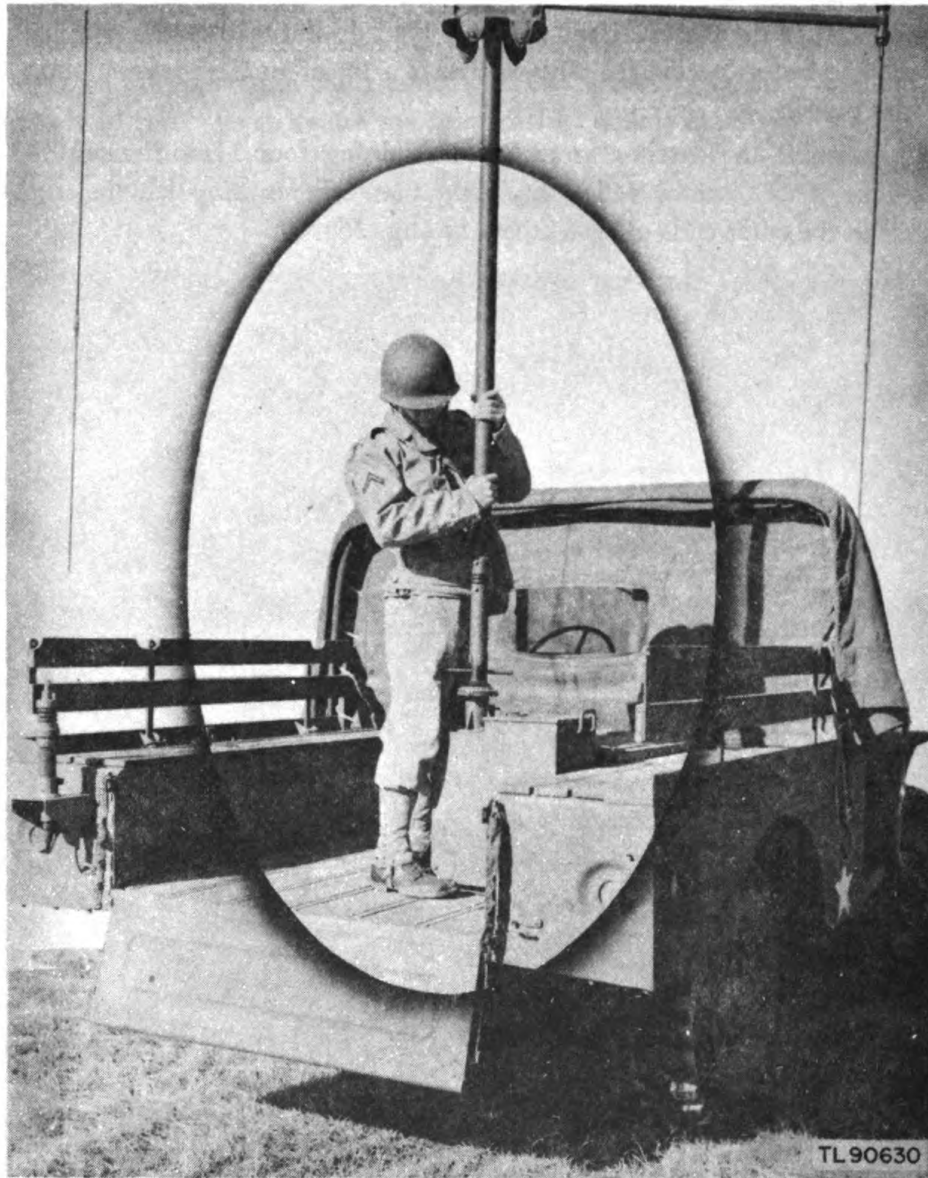

Figure 27. Placing assembled antenna array on antenna mount.

NOTE: Both the antenna array socket and the beacon antenna mount stub are polarized. One of the keys and the proper slot in the socket are marked by means of two phosphorous-painted dots to allow easy assembly at night. It is only necessary to insert Mast M-119 so the luminous dots are aligned next to each other.

26. TUNING THE TRANSMITTER.

a With the 10 channels pre-set, it is now necessary to tune the transmitter antenna primary and secondary to resonance with the resonance tuner within

the antenna mount. A calibrated chart for the resonance tuner is fastened to the door of the antenna mount. Proceed in the following manner:

- (1) Set the resonance tuner dial to calibrated setting.
- (2) Latch the proper push-button on the transmitter. It is best to start tuning the transmitter on about the middle frequency of the bend of frequencies to be covered, as the tank circuit trimmer capacitor can be adjusted for maximum output on one frequency only.
- (3) Turn the transmitter on.

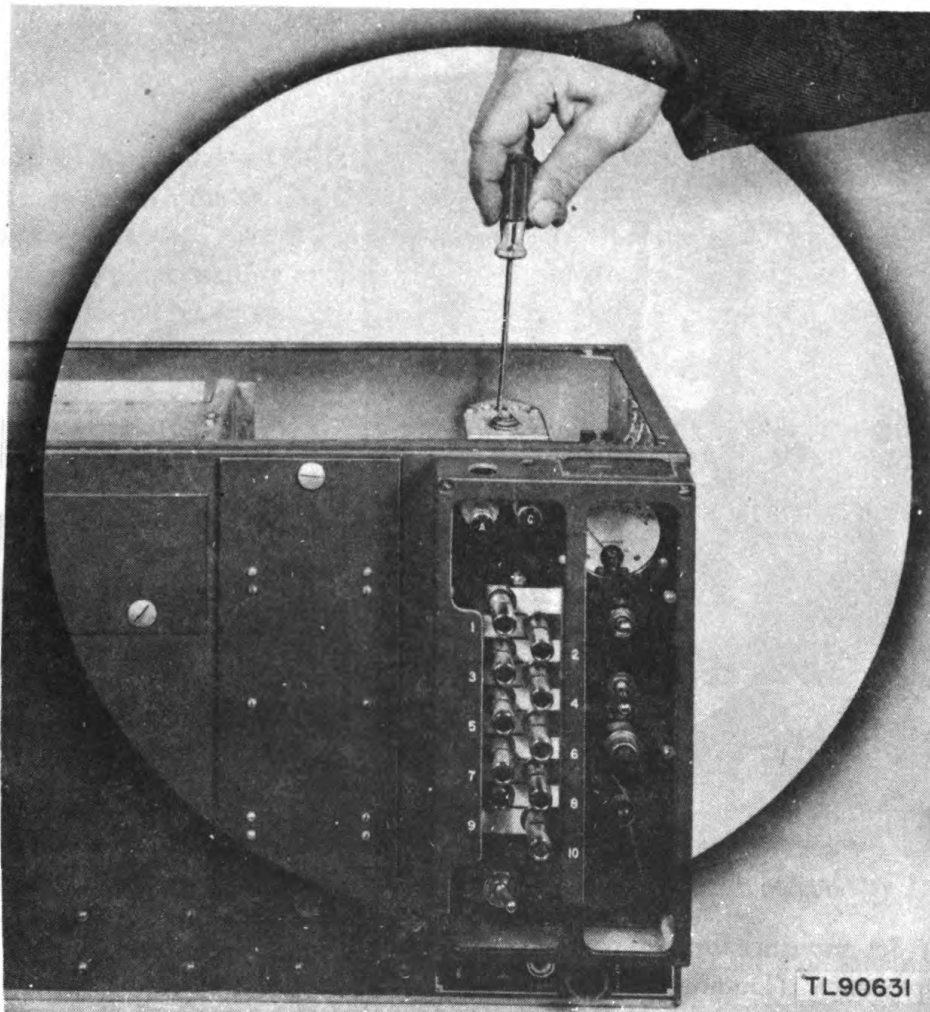

Figure 28. Adjusting tank circuit trimmer capacitor of transmitter.

(4) Set the tank circuit trimmer capacitor (located within the transmitter at the top) to midway capacity as shown in figure 28. Tune for resonance by adjusting antenna tuner capacitor for the channel being tuned. This capacitor is located on the right side of the transmitter as shown in figure 29. Either the

r-f current meter on the transmitter or a neon bulb, with glass portion held close to the neon glow tuning point (fig. 14) on the resonance tuner, will serve to indicate resonance. Adjust the tank circuit capacitor for greater r-f output and readjust the antenna tuner capacitor. Repeat these adjustments until maximum output is reached. The tank circuit capacitor should not be touched again in tuning the other channels.

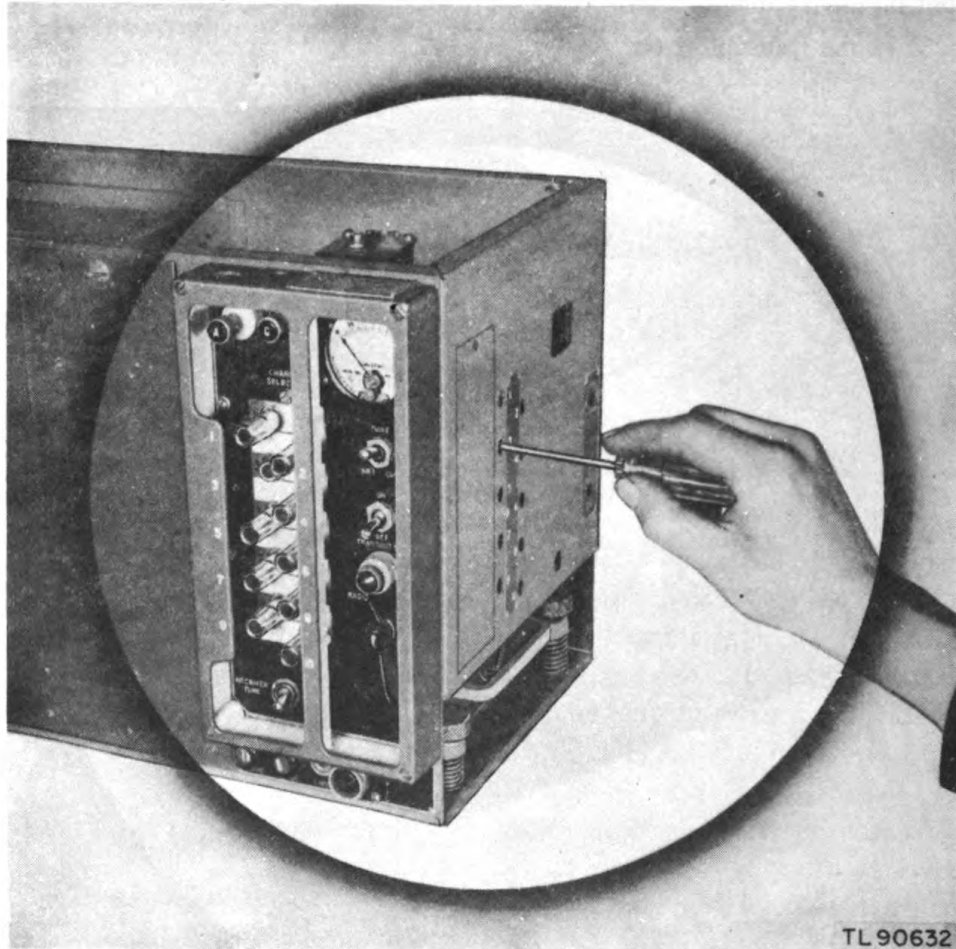

Figure 29. Adjusting antenna tuning capacitor of transmitter.

- (5) Set resonance tuner to next frequency and tune the antenna tuner capacitor to resonance. (Do not touch the tank circuit capacitor.)
- (6) Repeat the process given in subparagraph (5) above for each of the other eight frequencies.

NOTE: If the 10 frequencies chosen lie within 1 mc, the resonance tuner need only be set once and dial locked. The antenna tuner capacitors will equalize the transmitter output with very little loss in power.

b. The steps as outlined are in most cases more than ample for average distances. If maximum distances are required it is best to repeat all tuning proce-

dures using Tuning Indicator I-234 as an intensity meter rather than the neon bulb or meter on the transmitter panel. This method permits better visual indication of transmitter output because of its measurement of actual radiated power. The tuning indicator, with the switch pulled out, is placed nearby and antenna elements rotated close to its antenna. Tune the tuning indicator for some sign of power.

CAUTION: If, at any time, meter swings off scale, shorten the tuning indicator antenna, or, if necessary, detune the meter a little.

c. Any adjustments made to the antenna tuner trimmer or the tank circuit capacitor will show an increase or decrease in the tuning indicator reading. Thus, following the exact procedure as outlined for the neon bulb or r-f meter on the transmitter, it will be possible to adjust the transmitter to resonance more critically.

d. Unless crystals in the transmitter are changed, make no further adjustments to the transmitter. All that is necessary to change the transmitter from one channel to another, once it has been tuned, is to set the beacon resonance tuner dial to the proper setting as shown by the calibration curve and latch the transmitter push-button for the desired channel.

27. ANTENNA PATTERN TUNING.

a. Make all cable connections between the beacon antenna mount and the transmitter (fig. 22).

CAUTION: When tuning the antenna and when operating the beacon make sure that the antenna array is at least 150 feet from trucks, tanks, power wires, and other metal objects (fig. 30).

b. Lift the antenna mount clutch and lock it in neutral (fig. 2).

c. Snap the MODULATION & RELAY switch on the control panel OFF (fig. 12).

d. Latch the transmitter push-button to the desired frequency and turn transmitter ON.

e. Set the resonance tuner to the calibrated setting.

f. Tune the tuning indicator to its most sensitive position, with its antenna fully extended and then place the tuning indicator at least 20 feet away from the beacon.

g. Sight the null side of the antenna array to the tuning indicator antenna.

h. Reach up and detune the No. 2 control knob in the phase-load box (fig. 5) by turning the dial to zero. This is minimum capacitance.

CAUTION: When tuning the phase-load box avoid touching the mast.

Lean the body away from the mast.

i. Now tune the No. 1 knob in the phase-load box (fig. 5), while watching the meter on the tuning indicator. When tuned to resonance the meter will indicate maximum.

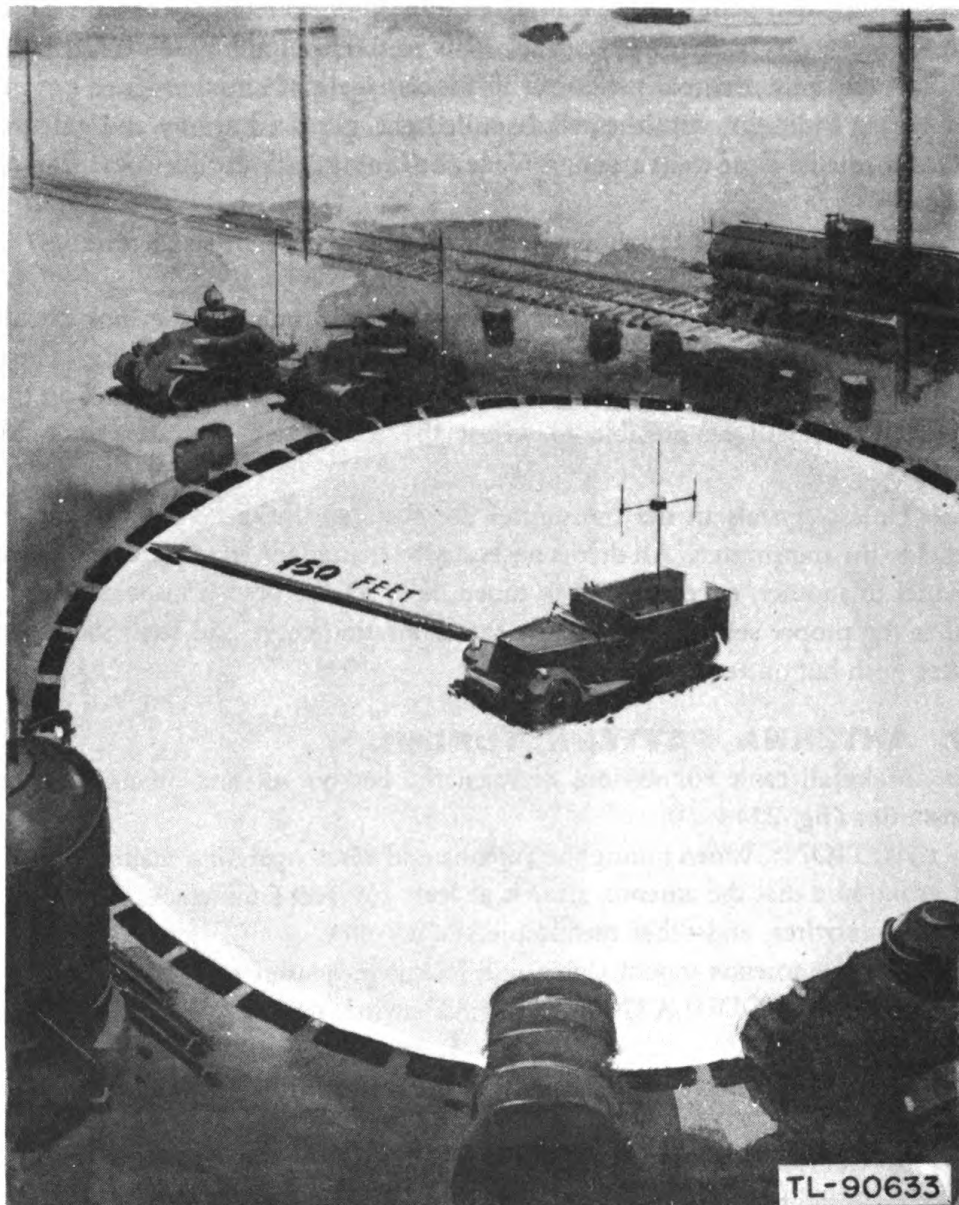

Figure 30. Beacon clearance.

j. If the meter fails to go off scale it indicates improper tuning of either the transmitter, the transmitter antenna circuits, or the resonance tuner. In any case, before proceeding further it is best to correct this condition. Assuming that the No. 1 knob, when tuned, caused the meter on the tuning indicator to go off scale or near maximum, proceed to the next adjustment. Tune the No. 2 knob. This time turn until the meter in the tuning indicator returns to zero.

NOTE: If the tuning indicator does not return to zero detune the No. 1 knob until the desired result is obtained.

k. If the No. 2 control has been able to return the tuning indicator meter to zero, the pattern has been tuned. Checking the pattern is a simple matter.

Rotate the mast by hand and the meter reading will increase to maximum and return to zero as the mast revolves.

NOTE: If the two controls have properly phased the circuit, any movement of the No. 1 or No. 2 dials should cause a sharp increase on the tuning meter.

l. When the pattern has been effected, it is possible in most cases to increase the power output from the transmitter. Turn the antenna array so that the tuning indicator shows about half-scale deflection, and adjust the control on the resonance tuner for an increase in output. If an increase has been effected, return the null end of the array so it is in line with the tuning indicator and re-tune the No. 2 control until zero is again indicated, so as to bring the null of the cardioid pattern to its greatest depth. Check the pattern by rotating the beacon array. When the null (white-stripped arm) points toward the tuning indicator there should be a full dip to zero on the tuning indicator meter. As the array rotates the needle should deflect until *off scale* is reached when the array reaches the direction where the "maximum" crossarm points to the tuning meter. The antenna pattern is now correctly adjusted.

28. ORIENTATION AND ALIGNMENT OF BEACON TO COMPASS.

a. After installing the beacon as described in paragraphs 22, 23, 24, and 25, proceed as follows:

- (1) Remove the tripod from the code-keyer well and the compass from the lower compartment of the antenna mount.
- (2) Set up the compass and tripod at a distance of 50 to 75 feet from the beacon and as nearly north from the beacon as possible. Turn the compass to zero on the compass-azimuth scale points toward the beacon. Level the compass. This is necessary so that the compass pointer will not stick or act erratic.

CAUTION: Magnetic compasses are affected by any magnetic metal such as iron, guns, knives, etc. Vehicles should be at least 150 feet away from the compass. The operator should have no magnetic metal on his person. In any case, keep the body as far away as possible by leaning forward at the waist, thus minimizing the magnetic attraction of any metal on the person.

b. The easiest way to orient the beacon is to use two men as shown in figure 31 for the operation, with one man stationed at the beacon, and the other man at the compass, although one man can accomplish the orientation.

- (1) Disengage the clutch and line up the null (white stripped) end of the beacon array so that it points to the compass. Use the sight on the mast and take directions from the compass operator.
- (2) The compass operator sights through the compass sights until he lines up the antenna array of the beacon in his sights. The slit-sight eyepiece of the compass should be next to the compass operator's eyes, as shown in figure 9. This will give assurance that the zero of the compass azimuth will point to the beacon.

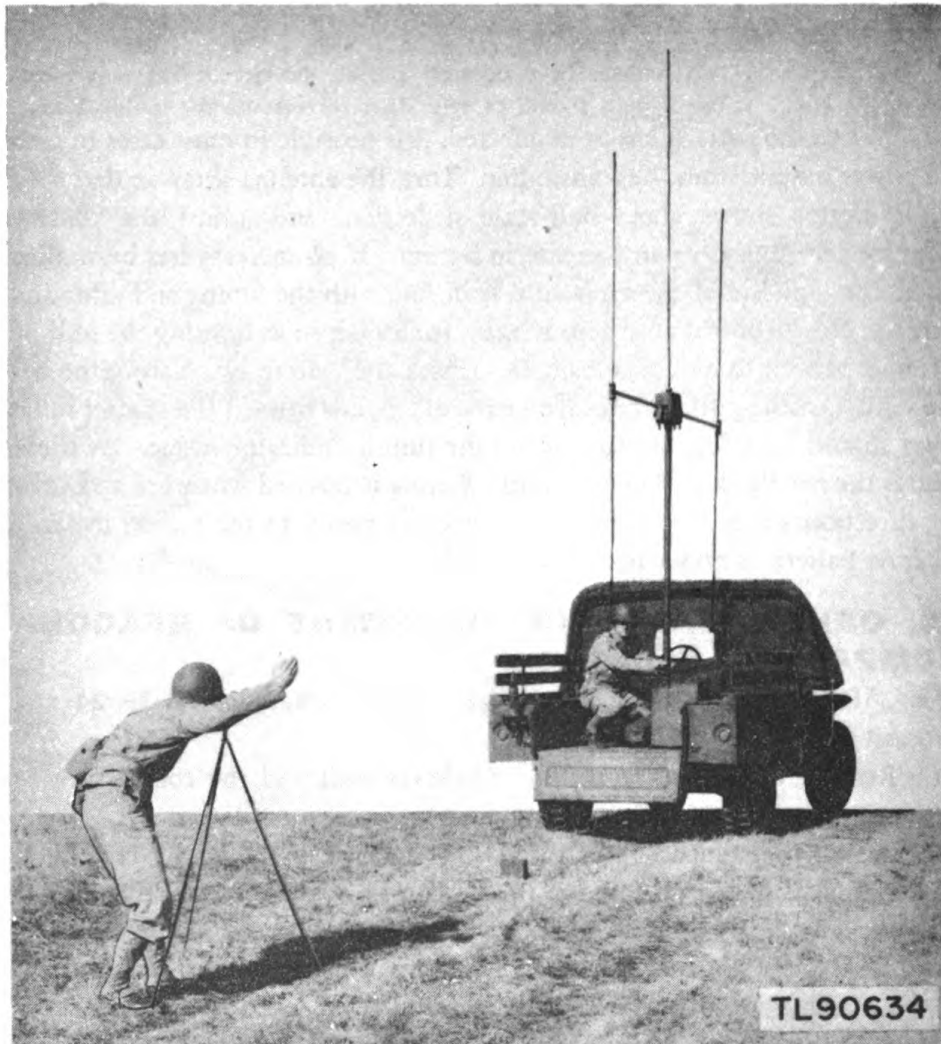

Figure 31. Orienting the beacon.

(3) The compass operator takes the azimuth reading from the compass dial as marked by the south end of the needle, and calls the reading to the beacon operator.

CAUTION: Always use the reading from the south end of the compass needle. Disregard the north reading.

(4) The beacon operator sets the zero set-ring on the antenna mount to zero on the beacon azimuth by loosening the knurled screw on the zero set-ring and turning the ring until zero on the scale is opposite the scribe mark on the zero set-ring and tightens the knurled screw.

(5) The beacon operator then turns the antenna mast to the same azimuth reading as that called by the compass operator. This will place the antenna array parallel with the compass needle (fig. 32).

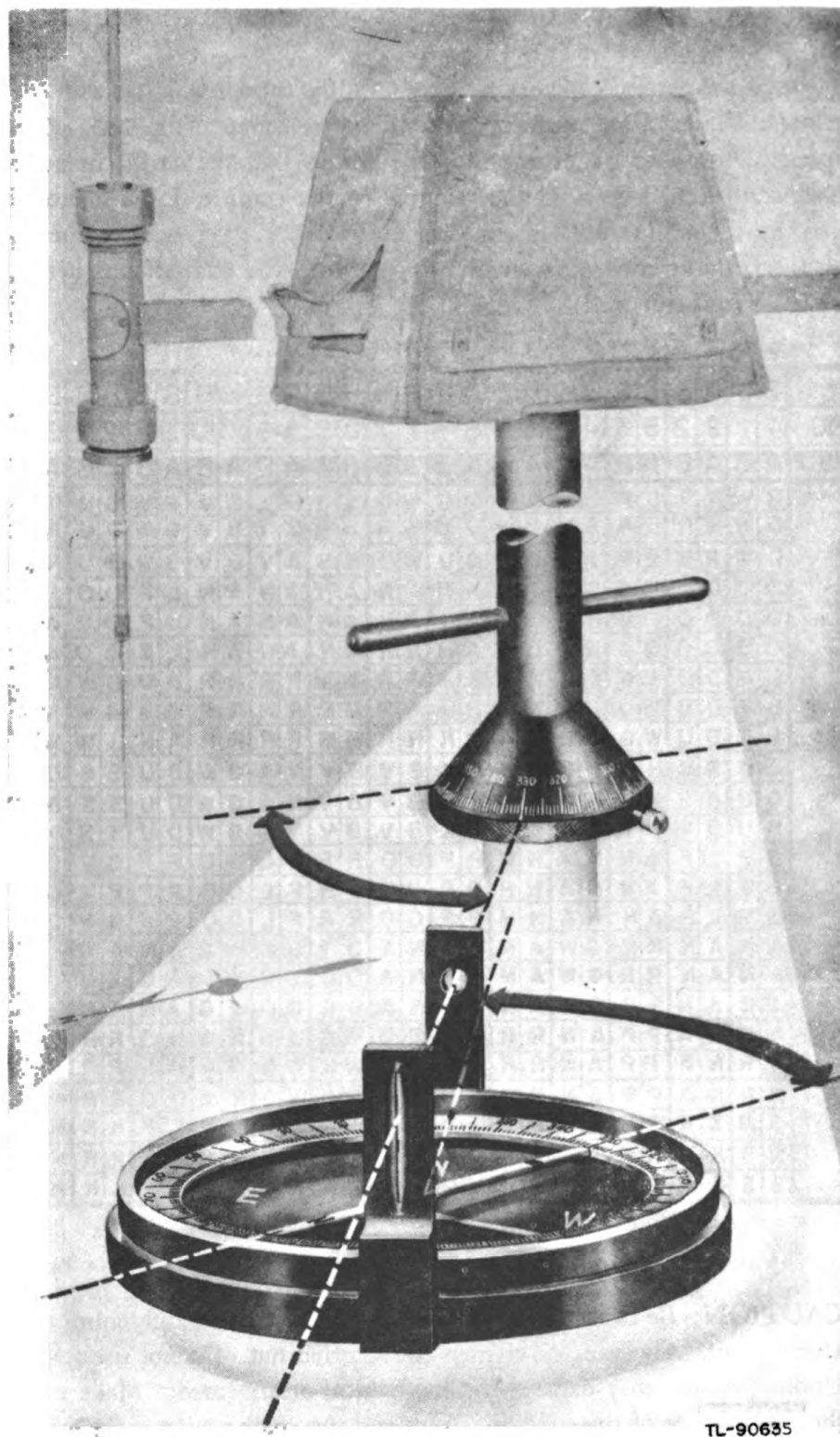

Figure 32. Azimuth correction for beacon.

CAUTION: Do not turn or move the antenna array while making the following alignment.

c. Insert the desired code disc (fig. 33) on the turntable, align with the pre-determined character for north opposite the keyer contact (fig. 17). Place the compression-insulator plate over the code disc so that the north character and number can be read through the window in the compression-insulator plate, and so the center line of the window points to the keyer contact, then screw down the large knurled nut with the fingers until the code disc is held tight. Close the code-keyer well lid.

SERIES	B	B	B	B	B	B	B	B	B	B	B	B	B	B	B	B	B	B	B	B											
NO. OF DISC	1	1	2	2	3	3	4	4	5	5	6	6	7	7	8	8	9	9	10	10	11	11	12	12	13	13	14	14	15	15	
SIDE OF DISC	A	B	A	B	A	B	A	B	A	B	A	B	A	B	A	B	A	B	A	B	A	B	A	B	A	B	A	B	A	B	
LETTERS	G	W	R	R	L	F	B	V	D	U	D	U	W	G	S	S	B	V	B	V	G	W	D	U	R	R	S	S	R	R	
	G	W	R	R	L	F	B	V	D	U	D	U	W	G	S	S	B	V	B	V	G	W	D	U	R	R	S	S	R	R	
	G	W	R	R	L	F	B	V	D	U	D	U	W	G	S	S	B	V	B	V	G	W	D	U	R	R	S	S	R	R	
	O	O	O	O	O	R	R	O	O	A	N	A	N	A	N	A	N	A	N	A	N	L	F	O	O	A	N	L	F	K	K
	O	O	O	O	O	R	R	O	O	A	N	A	N	A	N	A	N	A	N	A	N	L	F	O	O	A	N	L	F	K	K
	O	O	O	O	O	R	R	O	O	A	N	A	N	A	N	A	N	A	N	A	N	L	F	O	O	A	N	L	F	K	K
	L	F	D	U	W	G	O	O	N	A	R	R	R	R	M	M	R	R	R	R	R	A	N	G	W	N	A	A	N	N	A
	L	F	D	U	W	G	O	O	N	A	R	R	R	R	M	M	R	R	R	R	R	A	N	G	W	N	A	A	N	N	A
	L	F	D	U	W	G	O	O	N	A	R	R	R	R	M	M	R	R	R	R	R	A	N	G	W	N	A	A	N	N	A
	D	U	B	V	H	H	W	G	S	S	K	K	B	V	B	V	N	A	G	W	D	U	S	S	D	U	P	P	A	N	A
	D	U	B	V	H	H	W	G	S	S	K	K	B	V	B	V	N	A	G	W	D	U	S	S	D	U	P	P	A	N	A
	D	U	B	V	H	H	W	G	S	S	K	K	B	V	B	V	N	A	G	W	D	U	S	S	D	U	P	P	A	N	A
	B	V	L	F	A	N	N	A	H	H	P	P	O	O	R	R	F	L	O	O	P	P	B	V	O	O	D	U	L	F	F
	B	V	L	F	A	N	N	A	H	H	P	P	O	O	R	R	F	L	O	O	P	P	B	V	O	O	D	U	L	F	F
	B	V	L	F	A	N	N	A	H	H	P	P	O	O	R	R	F	L	O	O	P	P	B	V	O	O	D	U	L	F	F
	A	N	A	N	R	R	G	W	A	N	L	F	N	A	O	O	O	W	G	A	N	A	N	L	F	O	O	B	V	V	V
	A	N	A	N	R	R	G	W	A	N	L	F	N	A	O	O	O	W	G	A	N	A	N	L	F	O	O	B	V	V	V
	A	N	A	N	R	R	G	W	A	N	L	F	N	A	O	O	O	W	G	A	N	A	N	L	F	O	O	B	V	V	V
	R	R	N	A	P	P	A	N	R	R	U	D	D	U	W	G	W	G	N	A	U	D	R	R	P	P	W	G	D	U	U
	R	R	N	A	P	P	A	N	R	R	U	D	D	U	W	G	W	G	N	A	U	D	R	R	P	P	W	G	D	U	U
R	R	N	A	P	P	A	N	R	R	U	D	D	U	W	G	W	G	N	A	U	D	R	R	P	P	W	G	D	U	U	
S	S	K	K	S	S	L	F	P	P	M	M	S	S	N	A	L	F	S	S	L	F	K	K	H	H	N	A	O	O	O	
S	S	K	K	S	S	L	F	P	P	M	M	S	S	N	A	L	F	S	S	L	F	K	K	H	H	N	A	O	O	O	
S	S	K	K	S	S	L	F	P	P	M	M	S	S	N	A	L	F	S	S	L	F	K	K	H	H	N	A	O	O	O	

TL90636

Figure 33. Table of code discs.

CAUTION: Be careful not to shift the code disc while tightening the knurled nut. Always hand-tighten the knurled nut. Do not use tools. Undue pressure may damage the mechanical arrangement. Make sure the desired side of the code disc is up and the compression insulator is placed right side up (metal plate on top).

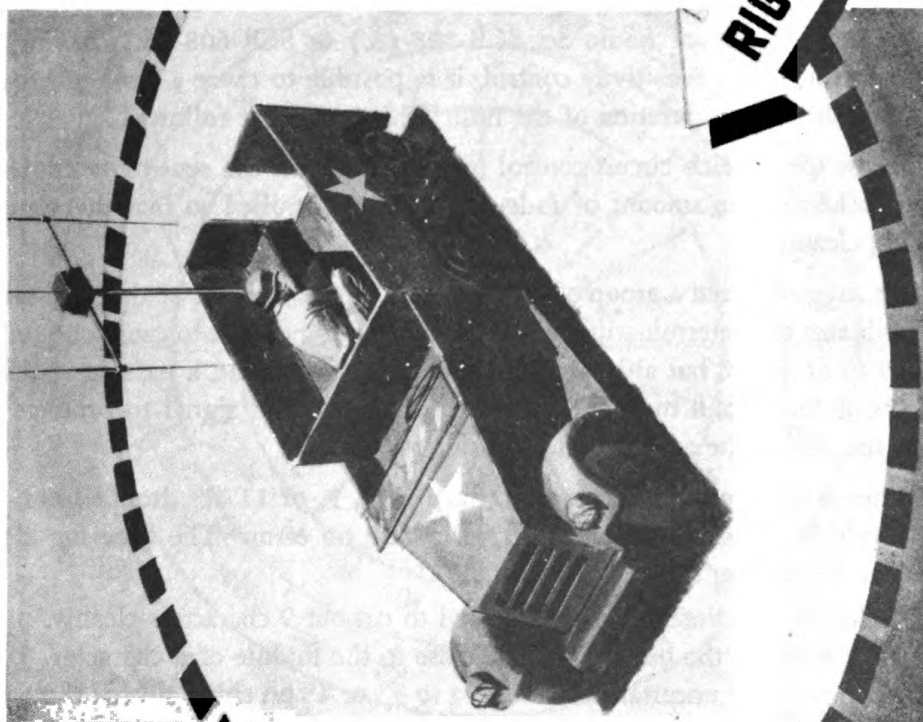
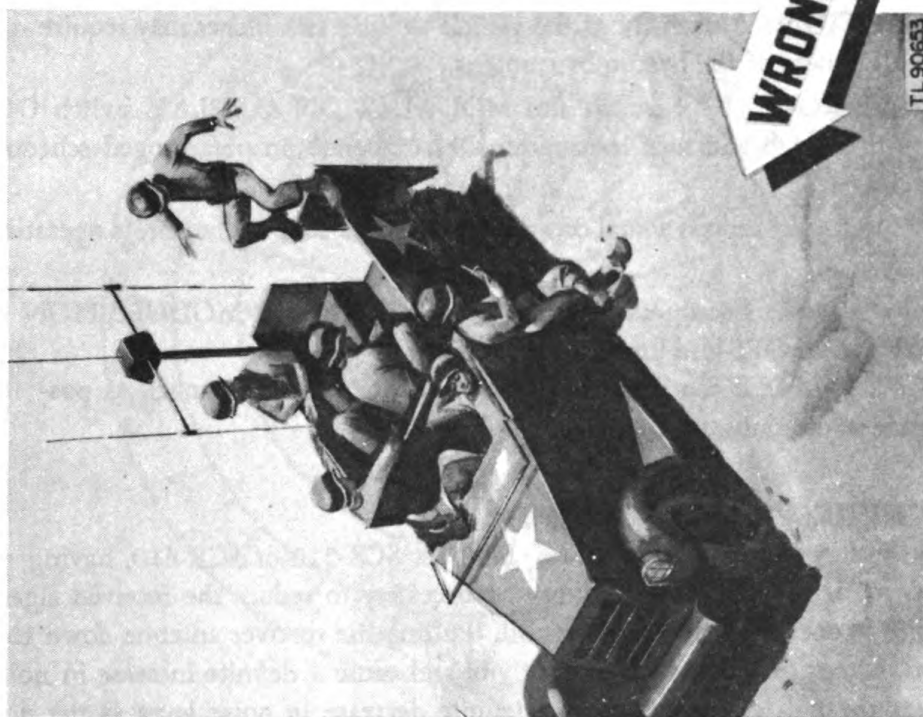

Keep Personnel Away When Transmitting.

601736 O - 44 - 4

43

d. (1) The beacon equipment is now ready for operation and can be used without further adjustment provided the vehicle is not moved.

CAUTION: Movement of the vehicle as little as 3 inches may require realignment of the beacon by compass.

(2) Turn ROTATION switch and MODULATION & RELAY switch ON, engage the clutch and turn transmitter ON. Operate on prearranged schedule or on call.

(3) Monitor the beacon signal occasionally to make sure the beacon is operating properly.

(4) To stop the beacon turn ROTATION switch and MODULATION & RELAY switch OFF and turn off the transmitter.

CAUTION: Keep personnel away from the beacon as much as possible while transmitting.

29. RECEIVER OPERATION.

a. With some receivers, such as Radio Set SCR-510 or SCR-610, having no sensitivity or squelch control, it may be necessary to reduce the received signal strength in order to determine the null. Pulling the receiver antenna down to a horizontal position will reduce sensitivity and cause a definite increase in noise level as the null approaches and a definite decrease in noise level as the null passes out. With such a receiver, very near the beacon location, it may be necessary to disconnect the receiver antenna entirely to cause a definite drop or fade out of the signal.

b. With a receiver of Radio Set SCR-508-($\&$) or SCR-608-($\&$), having a squelch circuit with a sensitivity control, it is possible to cause a definite break with no signal for the duration of the null. This is done as follows:

(1) Throw the squelch circuit control to ON, and turn the sensitivity control counterclockwise; the amount of fade out can be controlled so that the signal drops out cleanly.

(2) It is suggested that a group of characters of an odd number be dropped out. This facilitates the determination of the bearing. It is possible to cause only one character to drop out, but although this method is spectacular, a passing vehicle or effects of the terrain may cause a refracted or reflected signal to produce a shift of the null at the receiver, thus causing an error.

(3) When a large group of characters such as 7, 9, or 11 are dropped out, a passing vehicle or an intervening hill will cause no error. The time lag also minimizes the receiver shock or circuit delay.

EXAMPLE: If the squelch is adjusted to cut out 9 characters cleanly, but not 8 or 10, the bearing will be close to the middle of a character. Thus the zone of uncertainty is reduced to 3° or 4° on either side of the

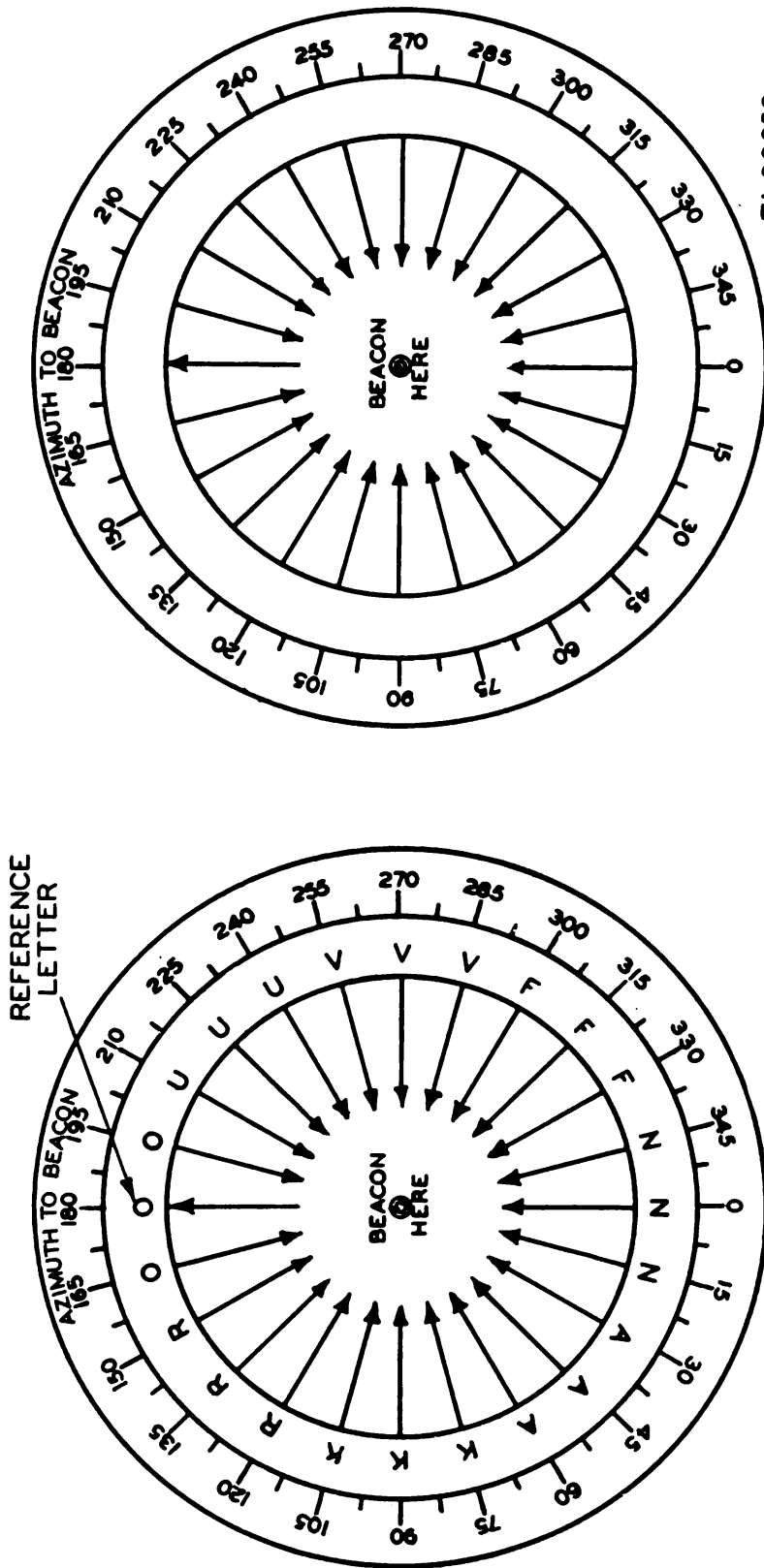

Figure 34. Homing disc.

bearing, instead of 7.5° . This is about the limit of accuracy possible with the present equipment, even if it were possible to estimate smaller fractions of a character.

c. At extreme distances it is possible that only three or four characters will be heard. These will be the maximum signal side (hot end) and bearings will be reversed.

30. HOMING OPERATION.

a. Each operator of a receiving station, mobile or stationary, must know the code disc number, character sequence, and the north orientation character transmitted by the beacon for the particular day or transmission.

b. A circular piece of paper showing an azimuth scale with degrees marked in clockwise direction 0-360, in 15° segments, and a compass are the only additional equipment necessary for homing. Figure 34 shows the form required.

(1) These homing discs have been designed to eliminate computation and to give the operator receiving the beacon signal a direct azimuth on which to travel home. For this reason the reference letter which is oriented to North on the beacon, is placed on 180 degrees on the homing disc.

(2) If only the reference letter is known and the characters are copied on the homing disc from signals received in the field, they should be copied in a clockwise direction starting with the reference letter on 180 degrees.

(3) It is best when circumstances permit to use a homing disc with the characters to be received already written in. In case these characters are copied directly from the code disc to be used, and not from radio signals, it is necessary because of the clockwise rotation of the code disc against the fixed point of the keyer contact, to proceed in the following manner: Write in the reference letter (oriented to North on the beacon) on 180 degrees on the homing disc. Following the characters around the code disc in a counterclockwise manner, write them on the homing disc in a clockwise direction.

c. Listening to the signal and visually following the characters transmitted by the beacon station around the disc, the operator makes careful note of the last character heard, and places the left thumb on this character. After the null, or period of silence, passes, the operator notes the first character heard and marks it with his right thumb. A point midway between these characters will be the bearing traveled to reach the beacon. In performing this operation it is best to adjust the sensitivity of the receiver so that an uneven number of characters drop out, in this way the center of the null is easy to find. As the receiving disc azimuth is a direct reading, the bearing indicated on the homing disc is the azimuth to travel to arrive home.

d. It is possible to get bearings in either moving or stationary vehicles. A motor vehicle, plane or boat can get a bearing and travel in the given direction for quite a distance, at which time another beacon transmission may be received, and the bearing can be rechecked.

31. DIRECTIVE TRANSMISSION AND RECEPTION. To make use of the cardioid pattern for directing a maximum signal (either phone or tone-modulated CW) towards a friendly station and a minimum signal towards the enemy location, point the hot end towards the friendly station if the location is known. If the location is not known, get a short test transmission from the operator of the friendly station while rotating the array by hand. Stop the array when the friendly signal is loudest. Proceed with transmission.

32. STANDBY OPERATION. Because of the selective pattern received by the array, do not use the beacon array for standby calls. However, if standby operation is desired, connect a piece of wire 8 or 10 feet long (run horizontally away from the array) directly to the A binding post of the receiver in use. This will dephase the circuit for receiving and will not affect transmission.

33. DIRECTION FINDING. To locate friendly or enemy station by using the beacon array as a direction finder proceed as follows:

- a.* Disengage the clutch.
- b.* Revolve the array by hand using the two turning handles.
- c.* If the signal is weak the unpainted or hot side will indicate the direction.
- d.* If the signal is very strong, throw squelch circuit on the receiver to ON, and reduce the receiver sensitivity. Use either the maximum or null ends to find the direction.

34. DIRECTING A FRIENDLY STATION. Using the same method described in paragraph 31, a friendly station can be given its azimuth to within 7° after a very short test transmission by the friendly station.

35. NAVIGATING WITH THE BEACON.

a. A dual installation of beacons on a known or mapped line, 10 to 30 miles apart, with synchronized ON and OFF operation, will provide fixes to travel to a given azimuth or position.

b. Depending on the care with which both stations have been aligned, and the receiving operator's experience, such fixes can be accurate to within 1/4 mile.

c. The two beacons are best operated on two different frequencies, preset on the receivers to allow quick shift from one of the beacon stations to the other, as soon as the first station's bearing has been determined.

d. One station might use an audio tone of 1,000 cps and the other 2,000 cps to help distinguish between the stations.

e. This same arrangement can be used to locate the position of a forward vehicle or the forward observer would transmit two received bearings, thus positioning himself.

36. USE OF ANTENNA ARRAY TO OVERCOME ENEMY JAMMING. The beacon antenna array can be used to overcome enemy jamming of received signals. Swing the hot end of the antenna array toward the friendly station. The selective pattern of the antenna array will reduce or eliminate the jamming.

37. EMERGENCY KEYING.

a. To emergency key the transmitter with tone modulation proceed as follows:

- (1) Make all cable connections between the beacon and transmitter.
- (2) Remove code disc from turntable in code-keyer well and replace compression-insulator plate.
- (3) Turn ROTATION switch OFF.
- (4) Turn MODULATION & RELAY switch ON.
- (5) Hand key the emergency keyer button in the code-keyer well (fig. 17).

b. Turning the antenna array until the hot crossarm points to the desired station will increase the signal strength.

SECTION III

Functioning of Parts

38. GENERAL

a. Radio Beacon Equipment RC-163 is an auxiliary rotating antenna system which converts the output of the frequency modulated transmitter of Radio Set SCR-508-(*&*) or Radio Set SCR-608-(*&*) into a cardioid pattern.

b. The output of the transmitter of Radio Set SCR-508-(*&*) or Radio Set SCR-608-(*&*) is carried through a coaxial r-f line into an antenna-coupler or resonance tuner. A stationary link terminates the transmitter output and provides an inductive r-f source coupled to a stationary secondary winding. This antenna coupler, when tuned to resonance, provides ample r-f energy to energize a loosely coupled rotating link. The link, mounted by a connector, is fixed in axis and carries the r-f energy through the beacon rotating stub axle. The stub axle is engaged by the mast which has a continuation of the r-f coaxial line. The center portion of the mast acts as a physical support for the array, and the insulated portion also radiates as a part of the vertical dipole output (fig. 35).

c. The phase-load circuit, coupled by the parallel connected link winding on the inductors, splits the energy from the transmitter into a dual output circuit.

d. The vertical dipole-circuit inductor is connected to provide a high current source for the current fed vertical dipole, which consists of Mast MS-119 (insulated by phenolic) and Mast Sections MS-50, MS-51, and MS-121, used with frequencies of 20-27.9 megacycles. The tip of the dipole, Mast Section MS-121, is removed for frequencies of 29-38.9 megacycles.

e. Four plug-in inductors are provided for the vertical dipole circuit to tune over a frequency range of 20-38.9 megacycles.

f. The Adcock circuit inductor provides a reduced voltage to the 4 Adcock elements. These 4 elements are transposed at the crossarm-socket ends, causing a 90° phase shift. Additional phase shift is introduced by conductors, longer than necessary in the transposition assembly. These conductors are twisted to provide added impedance and a deeper null, and are bundled to prevent damage and circuit interaction.

g. The r-f energy is transmitted from the Adcock circuit inductor through the two removable crossarms by r-f transmission lines. Four plug-in Adcock inductors are provided to enable the one array to tune from 20-38.9 megacycles.

h. The minimum output or null, of the cardioid pattern is phased to occur on the white-painted Crossarm M-408. This facilitates orienting the cardioid pattern to compass. The tone modulator is mechanically keyed by the automatic code-keyer, synchronized to the rotation of the antenna array.

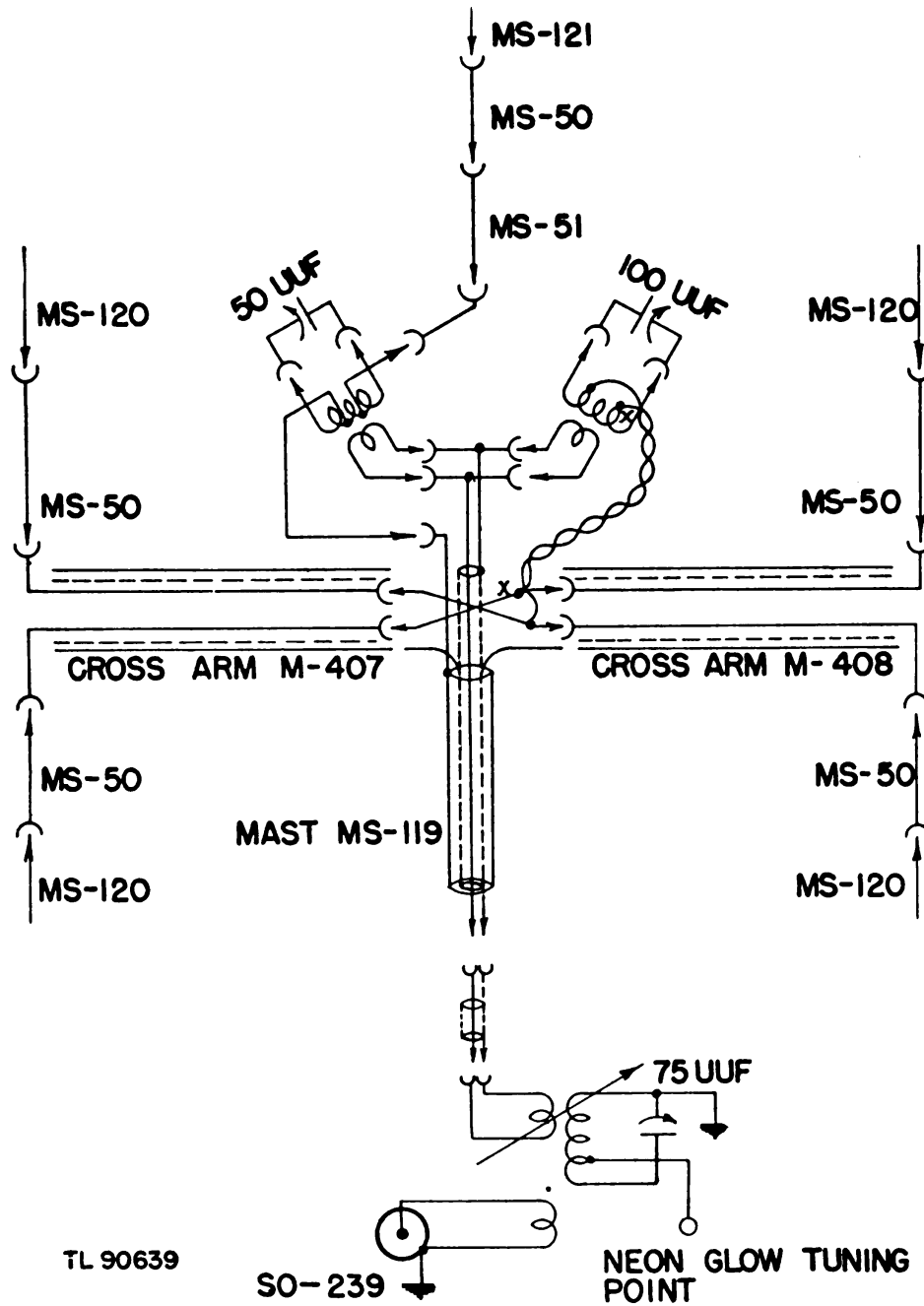

Figure 35. Schematic diagram of antenna array.

(1) When the null is aligned to any given position and a certain character on the code disc placed on the code-keyer contact, a complete rotation of the antenna array will return the null and disc character to the starting point.

(a) Thus, using a code disc with characters as shown in figure 34, aligning the null of the antenna array to magnetic north and setting the second letter O

on the code disc to the code-keyer contact and locking the compression-insulator plate, a full rotation of the antenna array will return the null crossarm to magnetic north and the code-keyer contact will again be on the second letter O on the code disc.

(*b*) Some confusion may be caused by the fact that the code disc rotates. Rotation is necessary for mechanical reasons as it is easier to rotate the code disc against the code-keyer contact, than to have the code disc stationary and rotate the code-keyer contact around the code disc. Actually the code disc characters remain in a fixed position in the antenna pattern.

(2) The beacon antenna array rotates in a clockwise direction at approximately $2\frac{1}{2}$ rpm. Eight characters, each repeated 3 times, makes a total of 24 characters transmitted each time the code disc makes a complete rotation. These 24 characters are each centered at intervals of 15° and, varying with the width of the character, provide a calibration for almost the entire 360° . The speed of the transmitted signals is approximately 12 words per minute. Repetition of the characters enables inexperienced operators to follow the signals on the homing disc and receive a bearing.

i. In operation, the heart-shaped pattern revolves with the antenna array, and the white marked crossarm null revolves the full 360° marking each section of the service area. With code disc having characters as shown in figure 34 aligned, as in subparagraph *b(1)(a)* above, a receiver to the north of the beacon would miss the second letter O. A receiver located east of the beacon would miss the second letter K. A receiver south of the beacon would miss the second letter N and a receiver west of the beacon would miss the second letter V.

NOTE: One-character drop-outs are given as examples for ease in explanation. In actual operation, one character drop-outs, requiring critical tuning and adjustment of the receiver, will not be necessary because satisfactory bearings will result from group drop-outs of 7, 9, or 11 characters (par. 29).

39. RESONANCE TUNER BC-1305. (fig. 35). The electrical components of the resonance tuner consists of a 2-inch phenolic form, mounted by an 8-32 screw and nut. Oversized mounting holes allow centering the rotating link in the form. The form has two windings. Two turns of No. 18 copper wire are used as an inductive termination load for Radio Set SCR-508-($\&$) or SCR-608-($\&$). This inductive termination winding is wound close to a 4-turn No. 16 copper wire secondary, tuned by a 75-u uf variable capacitor. The secondary provides a concentrated r-f radiating tank circuit for the 2-turn rotating link which rotates within the form. A connection at a high-voltage point of the secondary winding terminates in a screw head in a circular piece of polystyrene insulation and provides a point of contact for neon glow lamp tuning (fig. 14).

40. OSCILLATOR BC-1304 (fig. 36).

a. The audio oscillator employs a grid feedback circuit. The output tone frequency is varied from approximately 800 to 2,500 cycles per second, by a 5-point control selecting one of 5 resistors in the cathode circuit of the type 12A6 pentode tube used as the oscillator. The 12 volts applied to the filament is also used as plate voltage. The cathode circuit is opened and closed by a relay keyed by the automatic code-keyer.

b. The grid return of the pentode tube and the keyed cathode return are conducted through a shielded twin-conductor cable to the magnetic microphone connector on the C and D terminals of the transmitter. The C and D terminals are connected to the primary of a grounded input transformer. The grid return of the audio oscillator completes its circuit in the transmitter through one side of the magnetic microphone transformer. The keyed cathode circuit completes its circuit through the other half of the magnetic microphone transformer.

41. AUTOMATIC CODE KEYSER. International Morse code signals are formed when the MODULATION & RELAY switch on the control panel is turned ON and the code disc, mounted on the grounded turn-table, is rotated against the wedge-shaped code-keyer contact by the beacon motor, thus keying the relay in the circuit. One side of the relay solenoid connects to the 12-volt source. The wedge-shaped contact connects to the other end of the relay solenoid and, riding along the edge of the compression-insulator plates, grounds on the metal protrusions of the code disc, energizing the solenoid and closing the relay contacts which form a single-pole single-throw switch which opens and closes the audio-oscillator cathode circuit. A 300-ohm resistor and a 0.5- μ f capacitor in series are shunted across the keyer contact to ground at the relay terminal to minimize sparking.

42. CLUTCH ASSEMBLY. Two collars are used to disengage the mast from the drive worm. The bottom collar acts as a guide and limits the drop of the engaging clutch collar. The engaging clutch collar is controlled by two pivoted slide guides, mounted in a fulcrum yoke. The guides ride in a milled groove in the yoke. One end of the fulcrum yoke is attached by a clevis pin to a support bracket on the inside of the antenna mount. The other end is attached by a clevis pin to a vertical pull bar. This bar extends through a stationary 2-inch standup axle in the antenna mount roof and terminates in an inverted rain-proof cup fitted with finger pulls. Lifting the cup lifts the fulcrum yoke, raises the engaging clutch collar, and disengages the clutch pins. A quarter-turn twist of the cup holds the clutch disengaged. A spiral-wound helper spring is used to assist the gravity-forced engagement of the clutch with the drive worm (fig. 16).

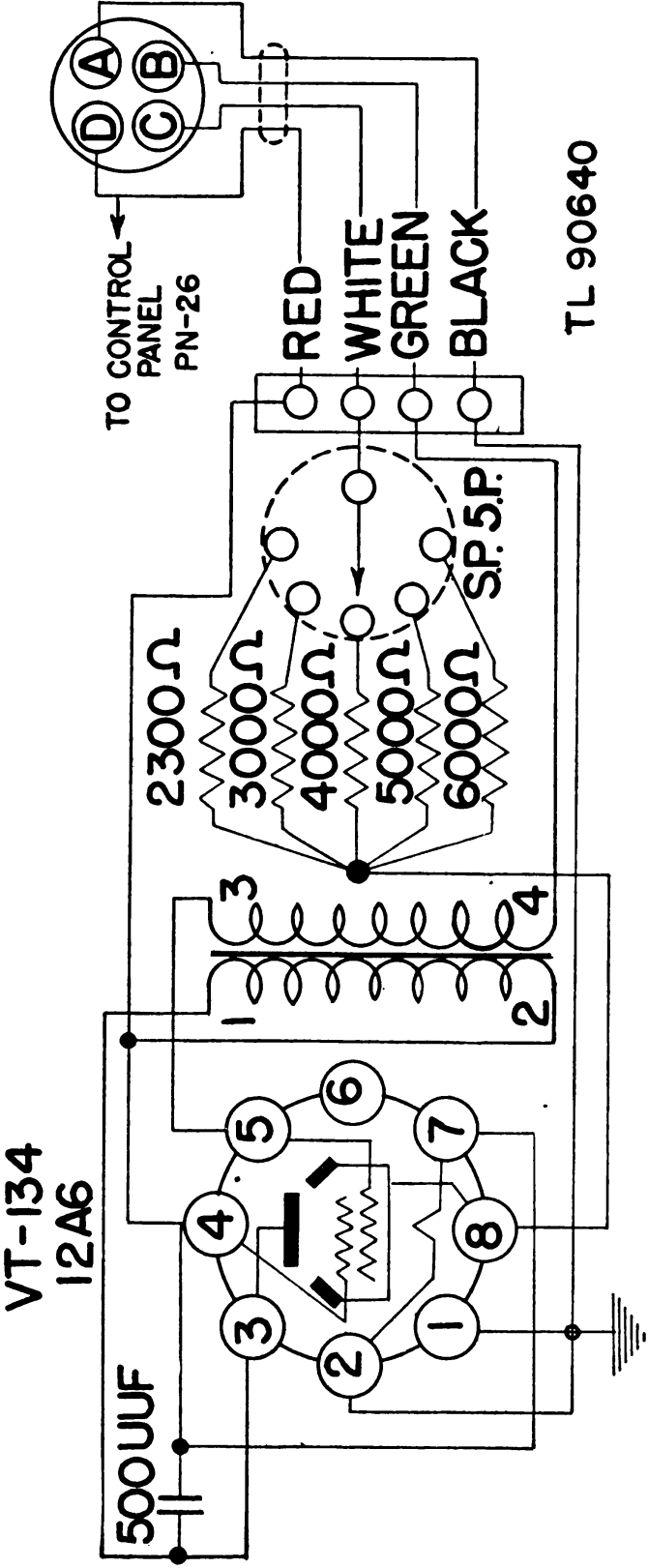

Figure 36.—Schematic diagram of oscillator.

43. TUNING INDICATOR I-234.

- a. The tuning indicator consists of a telescopic antenna, a 0-100 microammeter, and Tube VT-210 (1S4) used as a diode rectifier.
- b. The control and screen-grid and the diode plate of the 1S4 tube are externally connected to the plate of the tube (fig. 37).
- c. A coil of 8 turns of No. 20 wire, with a tap at the fifth turn, and tuned

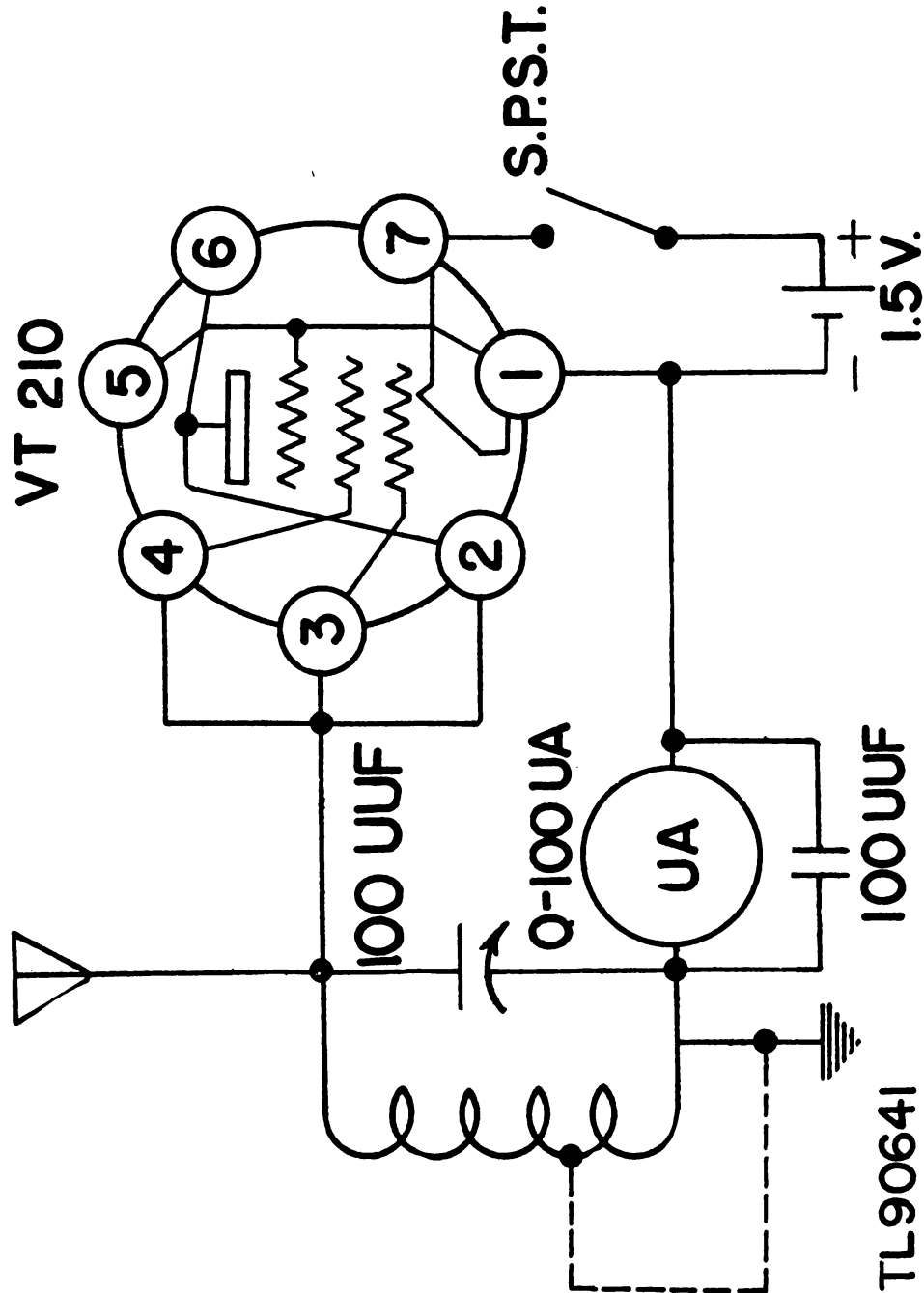

Figure 37. Schematic diagram of tuning indicator.

Functioning of Parts

by a 100-uuf capacitor, is connected between the plate and filament of the tube. The 0-100 microammeter is connected in the return circuit and serves as a visual indication of received signal strength.

d. For use between the frequencies of 20 and 31 mc, the tap on the coil is not used and the lead is soldered to a blank lug on top of the coil form. This arrangement is used when the beacon equipment is used with Radio Set SCR-508-(&). For use between the frequencies of 23 and 39 mc, the lead from the tap is soldered to the chassis of the tuning indicator. This arrangement is used when the beacon equipment is used with Radio Set SCR-608-(&).

e. Power for the tuning indicator is furnished by a 1.5-volt battery mounted in the case.

f. A chart mounted on the cover of the tuning indicator gives approximate dial settings, with antenna fully extended.

SECTION IV

Maintenance

NOTE: Report unsatisfactory performance of this equipment immediately on W.D., A.G.O. Form No. 468. If form is not available see TM 38-250.

44. CLEANLINESS.

a. Make every effort to prevent mud and dirt from coming in contact with plugs, antenna screw contacts, the control panel interior, and the cable connectors. As soon as possible after a rain storm wipe dry the machined phenolic supports which hold the female sockets for the mast sections. Take special care of the vertical insulator on the phase-load box. Keep it clean and dry to prevent distortion of pattern.

b. Mast sections should be locked together with lockwashers after cleaning the engaging parts with sandpaper. Avoid taking the mast sections apart, as the assembled units are easily stored. This saves time in setting up the beacon.

c. Keep gears free of dirt and excess grease.

d. Clean keyer contact and code discs if erratic keying occurs.

e. Keep the resonance tuner free of dirt and moisture.

f. Always keep the antenna mounting stub covered with Bag BG-179 when not in use. Wipe the stub clean before covering it.

g. Wipe off all dust and dirt from exposed parts and blow out any dust from the interior of the antenna mount, being careful not to damage any of the components. If the gears become dirty, clean them with a rag soaked in dry cleaning solvent, Federal Specification PS-661-6. Wipe dry and apply a very small amount of light grease (par. 45e).

45. LUBRICATION. The beacon equipment requires very little oil and grease. Use a small amount and wipe away all excess.

a. Motor. Place two or three drops of engine oil, Spec. U.S.A. 2-104B, SAE No. 10 in the two oil cups of the motor every 256 operating hours. The oil cups are easily reached from the front of the motor. For temperatures below zero use special preservative, lubricating oil, Spec. AXS-777, if available.

b. Code-keyer Shaft Oil Hole. Remove screw and put two or three drops of engine oil, Spec. U.S.A. 2-104B, SAE No. 10 in the oil hole in the tapped end of the code-keyer shaft every 256 operating hours. When operating in temperatures below zero use special, preservative, lubricating oil, Spec. AXS-777, if available. Be sure to replace screw in oil hole (fig. 17).

c. Clutch Lever. Pack the clutch lever with general purpose grease No. 2, Spec. U.S.A. 2-108 or Spec. U.S.A. 2-110, wheel-bearing grease. When operating in temperatures lower than 10° below zero remove grease and use special,

preservative lubricating oil, Spec. AXS-777, if available, or engine oil, Spec. U.S.A. 2-104B, SAE No. 10.

d. Antenna Bearing (Oilite). The antenna bearing (oilite) should require little or no attention in the field. If conditions indicate that lubrication is required, follow the same procedure as that for the clutch lever in subparagraph *c* above.

e. Worm and Drive Gears. The worm and drive gears require a very small amount of lubrication and, where extreme conditions of sand and dust are encountered, can be operated without grease for long periods without serious damage to the equipment. Use a small amount of general purpose, grease No. 1, Spec. U.S.A. 2-107 or equal when operating in temperatures above 32°F. For temperatures below +32°F use general purpose grease No. 0, Spec. U.S.A. 2-106. Where extreme temperatures of 10° below zero, and lower, are encountered, remove grease and use special, preservative, lubricating oil, Spec. AXS-777, if available, or engine oil, Spec. U.S.A. 2-104B, SAE No. 10.

46. GEAR ADJUSTMENT. The radio beacon equipment has been designed with the mast-bearing support and the code-keyer support in fixed positions. An idler gear is used as adjustment for play between the mast drive and the code-keyer drive. The motor bolt holes are drilled oversize to allow adjustment between motor worm and drive power gear. In adjusting the idler gear, be careful to avoid binding or overplay. After adjustment tighten the nut holding the idler gear.

47. VARIABLE CAPACITOR TUNING KNOBS. All dial shafts should rotate freely. Make setscrews as tight as practical so calibration will not be changed.

48. MAST SIGHT CARE. The mast sight is useful during the training period or when one operator is sighting the beacon. With an operator at the compass directing the sighting it can be disregarded. This sight has been adjusted before shipment to be parallel with the antenna crossarms. Check the sight adjustment by sighting through the compass to the beacon assembly until the three top antenna mast sections appear as one. Loosen the two locking nuts on the sight assembly and loosen the adjustment screw (painted red) (fig. 7). Adjust the sight to line up with the compass, tighten the adjustment screw and lock the locking nuts. An elastic stop nut is provided to allow vertical azimuth adjustment without the use of tools. Tighten this nut just enough to allow sight movement and to hold its position without binding.

49. ROTATING LINK COUPLING-ADJUSTMENT. The rotating link coupled into the resonance tuner is adjusted by the manufacturer for optimum output. Three 10-32 screws and washers ride up or down in elongated slots allowing a coupling adjustment of approximately 1/4 inch. This adjust-

ment can be arbitrarily set at halfway. For maximum output the use of a dummy antenna is necessary.

50. TUNING INDICATOR I-234. A spare tube for the tuning indicator is carried on the audio-oscillator chassis. If the tuning indicator is defective, and replacement of tube or other minor repairs does not suffice to correct it, use the receiver for pattern tuning.

51. EMERGENCY REPLACEMENT OF MAST SECTIONS MS-120 AND MS-121. Emergency replacement of Mast Sections MS-120 and MS-121 can be made by using Mast Section MS-49 (often available in the field) and cutting it down to a length of $31\frac{1}{8}$ inches for replacement of Mast Section MS-120. To replace Mast Section MS-121 cut Mast Section MS-49 down to a length of $13\frac{1}{8}$ inches. Make all measurements from tip to tip and hold accuracy to within $\frac{1}{4}$ inch to avoid unequal loading which will cause pattern instability and require retuning on the next setup, even though the same frequencies are used.

52. BENT MAST SECTIONS. Through accident or rough handling one or more of the mast sections in the antenna array may become bent. The bent mast section can be straightened by carefully bending it with the hand until it is parallel with the other mast sections in the antenna array. It is best to have the mast sections in line to allow easy alignment to compass and in order that the radiated pattern may not be affected.

53. CODE-KEYER CONTACT.

a. Make a frequent check of the code-keyer contact. This stainless steel V-shaped contact should ride smoothly over the code disc teeth with enough tension to make and break the signal cleanly. Should the contact show appreciable wear, reshape it to the proper angle with a file.

b. The keying can be checked by monitoring the signal. To do this, with or without the antenna array installed, do the following:

- (1) Connect all the cables between the beacon and transmitter.
- (2) Turn receiver ON and VOLUME full on. Tune to transmitter frequency.
- (3) Turn beacon MODULATION & RELAY switch and ROTATION switch ON.
- (4) Throw switch on transmitter to RECEIVER TUNE.
- (5) Latch proper frequency and turn transmitter ON.

c. The keying and modulated signal will be heard in the receiver. Check for poor contacts or slurring of letters. A worn contact edge-on the V-shaped code-keyer contact will short between the dots and dashes.

CAUTION: Avoid unnecessary rough handling or bending of the contact spring. The spring is built to stand a lot of wear but it is not unbreakable.

54. VARIABLE CAPACITOR CARE. Protect the three capacitors from mechanical damage such as bending of plates, and keep them free from dirt and moisture. If necessary, these capacitors can be cleaned by blowing them out with clean, dry air. Make sure all condensed moisture has been removed from the airhose that is being used.

55. TUBE REPLACEMENT. To replace the tube in the tuning indicator remove the back of the tuning indicator, depress the shield and remove the 1S4 tube. Replace with the spare 1S4 tube carried on the chassis of the audio oscillator.

56. FUSE REPLACEMENT. One 20-ampere fuse is used and is mounted on the control panel in a fuse extractor post. If replacement is necessary use a 20-ampere fuse. Spare fuses are carried on a mount on the inside right-hand side of the antenna mount.

57. MOTOR BRUSH REPLACEMENT. The motor has more than ample power to operate the beacon so brush life should be long and replacement infrequent. To replace motor brushes it will be necessary to remove the motor from the antenna mount. Proceed as follows:

- a. Disconnect the power supply cable.
- b. Remove the compass.
- c. Remove resonance tuner. Unscrew the three mounting screws and lift out the resonance tuner.
- d. Unscrew the audio cable fastened to the rear of the control panel.
- e. Remove the audio-oscillator chassis by twisting the winged Dzus fastener counterclockwise. Remove the chassis from the antenna mount.
- f. Remove the tuning indicator shock-mount from the code-keyer well by unscrewing the two screws located in the felt of the shock-mount.
- g. Unscrew the four bolts holding the motor.

CAUTION: Hold the motor while unscrewing the holding bolts.

Do not let the motor drop.

- b. Remove the motor from engagement with the worm gear and bring the motor out of the antenna mount.
- i. Remove the two bakelite covered screws and then remove the spring and brush assembly.
- j. Replace with new brush assemblies.

CAUTION: Be sure to replace the new brush assemblies so the concave face of the brush will fit the convex surface of the commutator.

58. PILOT LIGHT REPLACEMENT.

- a. Control panel light replacement is made by unscrewing the jewel, pressing in the light, and turning it to the left. Replace with a 12-volt pilot light.

b. Replace the code-keyer well pilot light by opening the front door of the antenna mount, then depress the pilot light holder springs until the assembly is loose. Remove the light and replace it with a 12-volt light.

59. COMPASS CARE.

a. Give the compass the best of care; avoid rough handling and protect it from rain. The compass is the most delicate part of the equipment and proper functioning of the beacon depends on its accuracy.

b. When using the compass be sure the azimuth is set at zero. In case the azimuth scale is not set to zero, correct it by turning the zero set screw on the side of the compass. (The set screw is near 270° on compass scale fig. 9).

c. When not in use, lock the floating pointer needle by tightening the knurled screw on the back of the compass; this prevents damage to the compass jewel. Then place the compass on its mount in the code-keyer well, face inward toward the felt and clamp carefully.

d. If the compass becomes damaged, replace it. Do not attempt repairing it in the field.

60. BATTERY REPLACEMENT. To replace the battery in the tuning indicator, remove the back of the meter and lift out the battery (fig. 44). Slack has been allowed in the wire so the battery can be brought out to unfasten the nuts. Replace with a 1½-volt Battery BA-15-A. This spare is carried in the antenna mount. Be sure to maintain correct polarity.

61. REMOVING R-F CABLE FROM MAST MS-119.

a. Remove Crossarms M-407 and M-408.

b. Remove vertical dipole.

c. Remove the eight screws which hold the metal cover of the phase-load box to the chassis. There are four screws on each side.

d. Remove the dial edge lock cap. Loosen the set screws in the two tuning knobs and remove knobs from shafts (fig. 45).

e. Unsolder the connection at the top of the r-f transmission line.

f. Remove the nut that holds the lead from the shield of the transmission line to the chassis and remove the lead.

g. Remove the six screws that hold the bakelite plate to the lower portion of the phase-load box. There are three screws on each side.

h. Remove the clamp that holds the r-f transmission line to the cross-arm channel support.

i. Unscrew the two screws holding the bottom male plugs. Pull out the unit with a pair of pliers.

j. Pull the insulator and the r-f transmission line free of the mast.

k. To replace the r-f transmission line reverse the above procedure.

62. REPLACING R-F TRANSMISSION CABLE IN CROSS-ARMS M-407 AND M-408.

- a. Remove the two screws that hold the inspection shield in place at the end of the crossarms (fig. 6).
- b. Unsolder the two leads from the mast socket.

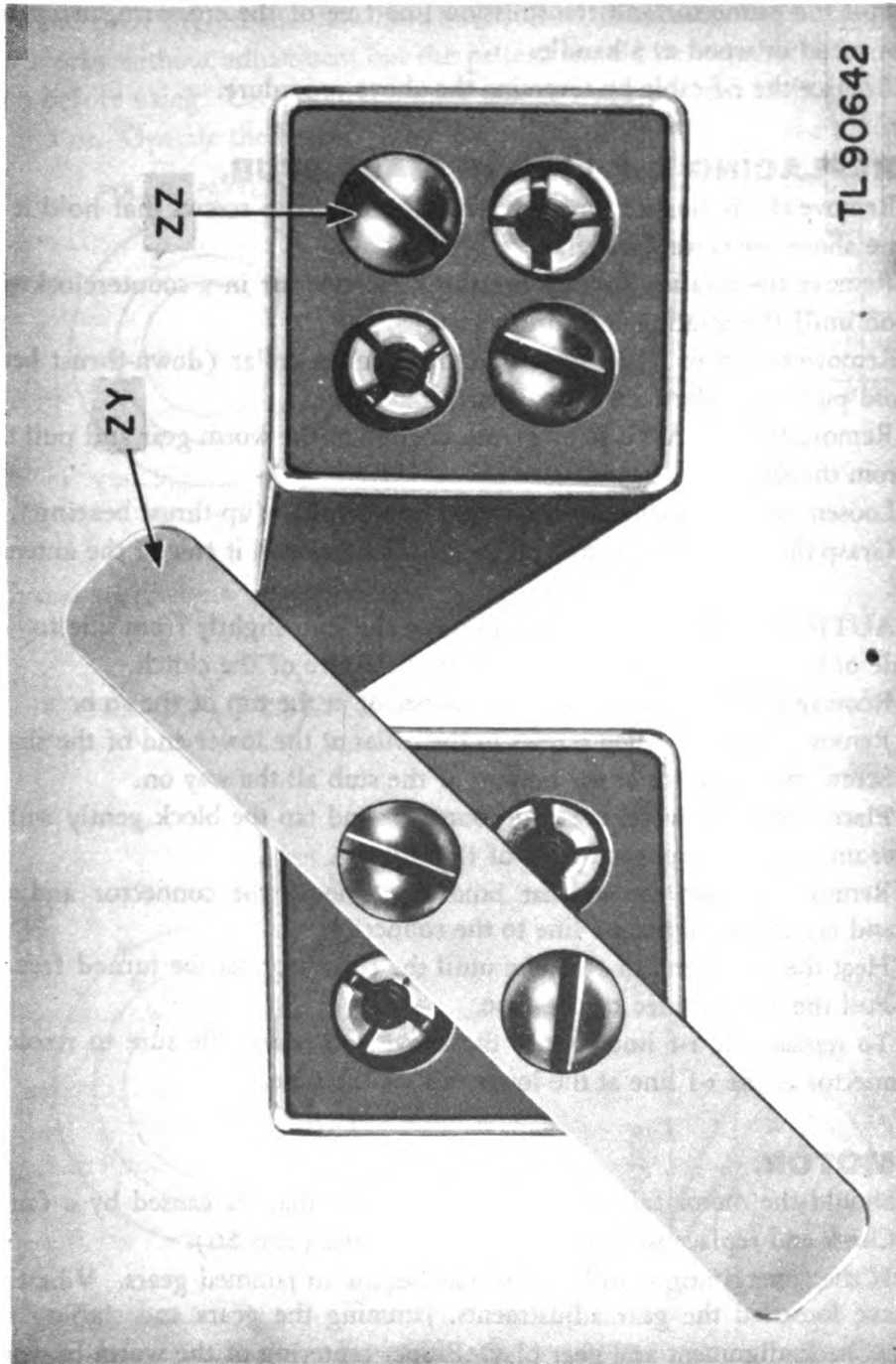

Figure 38. Removing connector from crossarm.

- c.* Remove the two screws that hold the connector in place in the opposite end of the crossarm.
- d.* Remove the two bolts in the face of the connector.
- e.* Drill two holes in a small piece of metal or wood (*z* and *y* in fig. 38) spaced so as to coincide with the holes in the connector.
- f.* Bolt the piece of wood or metal to the connector as shown in figure 38.
- g.* Pull the connector and transmission line free of the crossarm, using the piece of metal or wood as a handle.
- b.* Replace the r-f cable by reversing the above procedure.

63. REPLACING R-F LINE IN MAST STUB.

- a.* Remove the resonance tuner by removing the three screws that hold it to the plate above the control panel.
- b.* Remove the rotating link by turning the connector in a counterclockwise direction until the rotating link drops free.
- c.* Remove the three Allen screws from the lower collar (down-thrust bearing) and pull the collar free of the shaft.
- d.* Remove the two Allen screws from the hub of the worm gear and pull the gear from the shaft.
- e.* Loosen the three Allen screws in the upper collar (up-thrust bearing).
- f.* Grasp the rotating mast stub by the handles and pull it free of the antenna mount.

CAUTION: It may be necessary to move the stub slightly from side to side or to twist it slightly so that it will slide free of the clutch.

- g.* Remove the two screws from the connector at the top of the stub.
- b.* Remove the three Allen screws in the collar at the lower end of the shaft.
- i.* Screw the connector at the bottom of the stub all the way on.
- j.* Place a block of wood over the connector and tap the block gently with a hammer until the r-f line comes out of the stub.
- k.* Remove the two screws that hold the tube to the connector and the screw and lug that hold the r-f line to the connector.
- l.* Heat the lower end of the tube until the connector can be turned free.
- m.* Pull the r-f line free of the tube.
- n.* To replace the r-f line reverse the above procedure. Be sure to resolder the connector to the r-f line at the lower end of the tube.

64. MOTOR.

- a.* Should the motor fail to operate, the trouble may be caused by a faulty fuse. Check and replace with a new fuse as required (par. 56).
- b.* If the fuses continue to blow, it may be due to jammed gears. Vibration may have loosened the gear adjustments, jamming the gears and stalling the motor. Check alignment and gear play. Proper centering of the worm to worm

gear both horizontally and vertically is important. Bronze filings in the bottom of the antenna mount indicate improper adjustment.

c. If, after checking fuses, connections, and cable, the trouble is localized to the motor brushes, replace the faulty brush (par. 57).

d. Check and tighten screws which may have been loosened by vibration.

65. PATTERN MAINTENANCE: TESTING. a. After the pattern has been aligned and dials have been locked, the beacon may hold alignment for weeks without adjustment but the pattern should be tested without modulation before using. Use the tuning indicator to make the test. Set up the tuning indicator. Operate the beacon in the normal manner and watch the tuning indi-

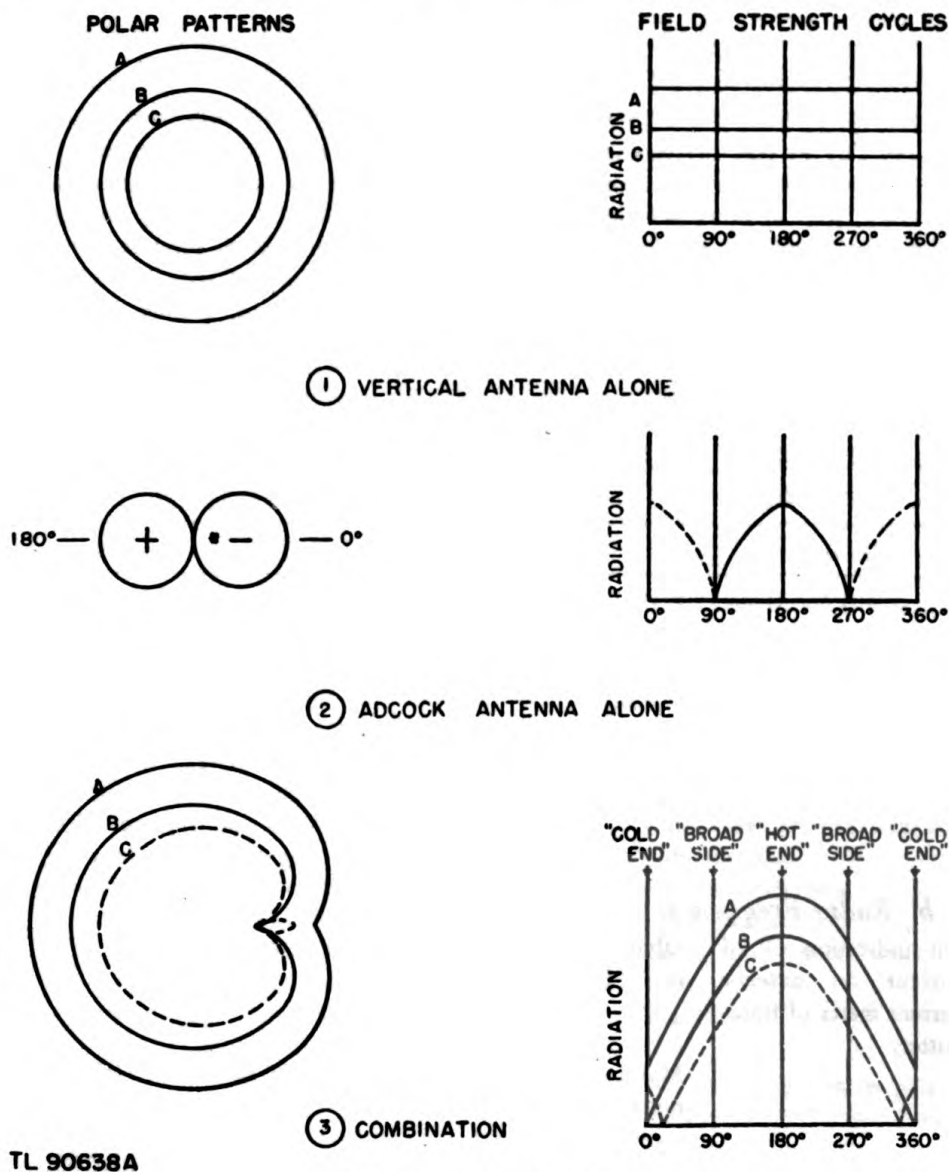

Figure 39. Antenna pattern.

cator closely. If correctly tuned the meter will vary smoothly from maximum to minimum and back to maximum for each revolution of the beacon with only one minimum; and that, when the cold end on the beacon antenna points to the tuning indicator.

b. The beacon antenna system combines a vertical antenna, which has a circular or non-directional radiation pattern and an H type Adcock antenna, which has a figure eight radiation pattern, to produce a cardioid, or heart shaped radiation pattern (③ fig. 39).

c. A perfect cardioid pattern would be produced if the maximum radiation from the vertical and Adcock were equal as shown by curve B (③ fig. 39). In this case the minimum of the combined radiation would be zero. In practice, the vertical antenna is adjusted to radiate a little more strongly than the Adcock. If the Adcock radiation were the stronger, as indicated by curve C, ③ figure 3, the pattern would be a lop-sided figure 8 with two minimums close together.

NOTE: In case the tuning indicator is defective, a receiver can be used for emergency test or alignment. This may be the receiver installation in a half-track, jeep or other vehicle. Locate the vehicle about 100 feet away from the beacon, with the null crossarm sighted to the receiver. With receiver volume control full on, sensitivity control tuned to a minimum and with squelch on, the beacon pattern can be tuned or checked by actual sound. Tuning a pattern in this manner is somewhat critical and will require some practice for satisfactory results.

66. TROUBLE CHART.

a. Mechanical.

<i>Trouble</i>	<i>Probable Cause</i>	<i>Remedy</i>
Beacon will not rotate.	POWER switch off.	Turn on switch.
	Fuse blown.	Replace.
	Clutch defective or not engaging.	Adjust and operate.
	Gears loose.	Check alignment and tighten set screws.
	Cord defective.	Check for short or open. Repair or replace. Check and tighten connections.

b. Radio Frequency.

No indication of r-f current on antenna current meter of transmitter.	ON-OFF switch on transmitter in OFF position.	Turn on switch.
	Monitoring switch on transmitter in RECEIVER TUNE position.	Put switch on OPERATE.
	Radio interphone switch in INTERPHONE position.	Put switch on RADIO.

Maintenance

<i>Trouble</i>	<i>Probable Cause</i>	<i>Remedy</i>
No indication of r-f current on antenna current meter of transmitter.— (Continued)	Channel selector latch not engaged.	Latch push-button.
	Transmitter antenna tuning capacitor adjustment off.	Retune channel.
Transmitter fails to go on when turned ON.	Cord CD-1155, audio cable from beacon loose, disconnected, or defective.	Check connections and replace if necessary.
	Fuse blown or defective.	Replace.
No indication of signal on tuning indicator.	Tuning indicator switch off.	Turn on switch.
	Tuning indicator defective.	Replace battery or tube as required.
	Resonance tuner setting has been disturbed.	Reset resonance tuner dial according to calibration chart on door of beacon mount.
	Rotary link loose or disconnected.	Tighten connections.
	Antenna mast not making contact.	See that mast is pushed all the way down on the stub.
	No coils in phase-load box.	Insert proper plug-in coils.
	Mast coaxial cable open or shorted.	Repair or replace.
	Crossarm M-407 or M-408 open or shorted.	Do.
	Resonance tuner.	
	1. Cable loose or disconnected.	Tighten connections.
2. Inductor open.	Repair.	
Intermittent r-f output.	Transmitter at fault.	Check for indication of r-f on antenna current meter. If none, proceed according to instructions for SCR-508 or SCR-608.
Intermittent r-f output.	R-f cable, poor connections or shorted.	Tighten connections or replace cable if necessary.
	Resonance tuner connector.	Tighten connection.
	Mast plug-in contact poor.	Push mast all the way down onto the stub.
	Inductor contacts loose.	Push in inductors.
	Crossarms poorly installed.	Check installation.
	Antenna elements loose and contacts poor.	Clean and tighten mast sections securely.
No tone modulation.	Rotating link connector loose.	Tighten.
	Disc not in place.	See that a disc is in place in the keyerwell. Tighten knurled nut on compression insulator plate.

<i>Trouble</i>	<i>Probable Cause</i>	<i>Remedy</i>
No tone modulation. —(continued)	Clutch not engaged. Modulator cable not connected or defective. Modulation switch OFF. Defective 12A6. Defective audio-oscillator chassis.	Engage clutch and turn on ROTATION. Check cable for short or open according to diagram. Turn on switch. Replace tube. Inspect chassis visually for loose connections and replace if necessary.
<i>c. Modulation.</i>		
Audio oscillator does not function.	Modulation switch OFF.	Turn switch ON.
Audio oscillator does not function.	Oscillator cables defective. Defective connector. Defective 12A6.	Tighten connections, if loose, or replace cable. Do. Replace tube.
Impossible to tune pattern.	Defective contacts or connections in crossarms M-407 or M-408. Wrong inductor for frequency in use.	Remove arms, check for continuity. With both Adcock and vertical inductors out of circuit, check or open according to diagram.
Poor keying.		For quick check, key emergency keyer.
a. Missing letters.	Contact point worn. Phenolic compression disc off center.	File contact point to a V. Center with code disc; replace when possible.
b. Slurring letters.	Do.	Do.
c. Irregular keying.	Relay dirty.	Clean relay points and adjust if necessary.

67. MOISTUREPROOFING AND FUNGIPROOFING.

a. General. Communication failures commonly occur when Signal Corps equipment is operated in tropical areas where temperature and relative humidity are extremely high. The following problems are typical:

- (1) Resistors and capacitors fail.
- (2) Electrolytic action takes place in coils, chokes, transformer windings, etc., causing eventual break-down.
- (3) Hook-up wire and cable insulation break down. Fungus growth accelerates deterioration.
- (4) Moisture forms electrical leakage paths on terminal boards and insulating strips causing flash-overs and crosstalk.

(5) Moisture provides leakage paths between battery terminals.

b. Treatment. A moistureproofing and fungiproofing treatment has been devised which, if properly applied, provides a reasonable degree of protection against fungus growth, insects, corrosion, salt spray, and moisture. The treatment involves the use of a moisture and fungi-resistant varnish applied by means of a spray gun. A brief description of the method of application follows:

(1) All repairs and adjustments necessary for the proper operation of the equipment are made.

(2) Equipment to be processed is thoroughly cleaned of all dirt, dust, rust, fungus, oil, grease, etc.

(3) Equipment is partially disassembled and certain points, such as relay contacts, open switches, air capacitors, sockets, bearings, etc., are covered with masking tape.

(4) Equipment is thoroughly dried by heat to expel moisture which the circuit elements have absorbed.

(5) All circuit elements and all parts of the equipment are sprayed or painted with three coats of moistureproofing and fungiproofing varnish.

(6) The equipment is given a final operational check; radio sets receiving a 24 to 36 hour aging period, when time permits, before alignment.

c. Step-by-step Instructions.

(1) DISASSEMBLY.

(a) Remove Tuning Indicator I-234, Oscillator BC-1304 and Panel PN-26 from the antenna mount.

(b) Remove the r-f line in Crossarms M-407 and M-408.

(c) Disassemble Mast MS-119.

(2) MASKING.

(a) Remove tube and battery from Tuning Indicator I-234. Mask tube socket, battery connections and variable capacitor.

(b) Leave tubes in sockets of Oscillator BC-1304. Mask rotary 5-point switch.

(c) Mask relay contacts and all connector sockets.

(3) DRYING. Dry for 2 to 3 hours at 160° F. Do not apply heat to batteries of tuning indicator.

(4) VARNISHING. Apply 3 coats of moistureproofing and fungiproofing varnish.

(5) Reassemble and test operation.

(6) Mark MFP and date of treatment.

d. Reference. For a full description of the varnish spray method of moistureproofing and fungiproofing refer to TB SIG 13.

SECTION V

Supplementary Data

68. MAINTENANCE PARTS LIST FOR RADIO BEACON EQUIPMENT RC-163

NOTE: Order maintenance parts by stock number, name, and description.

Ref. Symbol	Signal Corps stock No.	Name of part and description	Quan. per equip.	Running Orgn. spares stock	3d ech.	4th ech.	5th ech.	Depot stock
a	2Z261-2	ADAPTER: Brunson type MC-324, or equal (to be used with compass). Brunson Mfg. Dwg.	1	*				*
b	2A2562-67	ANTENNA MOUNT MP-67.	1					*
BG-179	2Z551-179	BAG BG-179: Boot-shaped with flap. (Used to cover both cross-arms when knocked down for transport.)	1					*
	3G87-3	BEAD #73-T: American Phenolic Corp. (Part of CD-1156.)	2			*		*
	2Z2636-12	CLAMP: cable, Amphenol AN-3057-6. (Part of CD-1155 and CD-1151.)	2					*
di	2Z8549-2	CLAMP: slighting.	2	*				*
ao	2A2562-67/C3	CODE DISC: stainless steel, B-15-A/B, #16 gauge, 5 1/2" O.D.	1		*			*
ap	2A2562-67/C4	CODE DISC: stainless steel, B-14-A/B, #16 gauge, 5 1/2" O.D.	1		*			*
aq	2A2562-67/C5	CODE DISC: stainless steel, B-13-A/B, #16 gauge, 5 1/2" O.D.	1		*			*

* Indicates stock available.

68. MAINTENANCE PARTS LIST FOR RADIO BEACON EQUIPMENT RC-163 (cont'd.)

NOTE: Order maintenance parts by stock number, name, and description.

Ref. Symbol	Signal Corps stock No.	Name of part and description	Quan. per equip.	Running Orgn. spares	3d stock	4th ech.	5th ech.	Depot stock
ar	2A2562-67/C6	CODE DISC: stainless steel, B-12-A/B, #16 gauge, 5 1/2" O.D. Dwg. No. ES-D-33730-A-12.	1		*			*
as	2A2562-67/C7	CODE DISC: stainless steel, B-11-A/B, #16 gauge, 5 1/2" O.D. Dwg. No. ES-D-33730-A-11.	1		*			*
at	2A2562-67/C8	CODE DISC: stainless steel, B-10-A/B, #16 gauge, 5 1/2" O.D. Dwg. No. ES-D-33730-A-10.	1		*			*
au	2A2562-67/C9	CODE DISC: stainless steel, B-9-A/B, #16 gauge, 5 1/2" O.D. Dwg. No. ES-D-33730-A-9.	1		*			*
av	2A2562-67/C10	CODE DISC: stainless steel, B-8-A/B, #16 gauge, 5 1/2" O.D. Dwg. No. ES-D-33730-A-8.	1		*			*
aw	2A2562-67/C11	CODE DISC: stainless steel, B-7-A/B, #16 gauge, 5 1/2" O.D. Dwg. No. ES-D-33730-A-7.	1		*			*
ax	2A2562-67/C12	CODE DISC: stainless steel, B-6-A/B, #16 gauge, 5 1/2" O.D. Dwg. No. ES-D-33730-A-6.	1		*			*
ay	2A2562-67/C13	CODE DISC: stainless steel, B-5-A/B, #16 gauge, 5 1/2" O.D. Dwg. No. ES-D-33730-A-5.	1		*			*
az	2A2562-67/C14	CODE DISC: stainless steel, B-4-A/B, #16 gauge, 5 1/2" O.D. Dwg. No. ES-D-33730-A-4.	1		*			*
ba	2A2562-67/C15	CODE DISC: stainless steel, B-3-A/B, #16 gauge, 5 1/2" O.D. Dwg. No. ES-D-33730-A-3.	1		*			*
bb	2A2562-67/C16	CODE DISC: stainless steel, B-2-A/B, #16 gauge, 5 1/2" O.D. Dwg. No. ES-D-33730-A-2.	1		*			*

* Indicates stock available.

68. MAINTENANCE PARTS LIST FOR RADIO BEACON EQUIPMENT RC-163 (cont'd.)

NOTE: Order maintenance parts by stock number, name, and description.

Ref. Symbol	Signal Corps stock No.	Name of part and description	Quan. per equip.	Running Orgn. 3d eq.	4th ech. stock	5th ech. stock	Depot stock
bc	2A2562-67/C17	CODE DISC: stainless steel, B-1-A/B, #16 gauge, 3/2" O.D. Dwg. No. ES-D-33730-A-1.	1	*			*
bd	3C300-456	COILS C-456: R.F., plug in, Adcock Antenna circuit, 20-22.5 mc (used with but not part of MS-119).	1				*
be	3C300-457	COILS C-457: R.F., plug in, Adcock Antenna circuit, 22.5-25 mc (used with but not part of MS-119).	1				*
bf	3C300-458	COILS C-458: R.F., plug in, Adcock Antenna circuit, 25-30 mc (used with but not part of MS-119).	1				*
bg	3C300-459	COILS C-459: R.F., plug in, Adcock Antenna circuit, 30-40 mc (used with but not part of MS-119).	1				*
bh	3C300-460	COILS C-460: R.F., plug in, Vertical, antenna circuit, 20-22.5 mc (used with but not part of MS-119).	1				*
bi	3C300-461	COILS C-461: R.F., plug in, Vertical, antenna circuit, 22.5-25 mc (used with but not part of MS-119).	1				*
bj	3C300-462	COILS C-462: R.F., plug in, Vertical, antenna circuit, 25-30 mc (used with but not part of MS-119).	1				*

* Indicates stock available.

68. MAINTENANCE PARTS LIST FOR RADIO BEACON EQUIPMENT RC-163 (cont'd.)

NOTE: Order maintenance parts by stock number, name, and description.

Ref. Symbol	Signal Corps stock No.	Name of part and description	Quan. per equip.	Running Orgn. spares stock	3d ech.	4th ech.	5th ech.	Depos stock
bk	3C300-463	COILS C-463: R.F., plug in, Vertical, antenna circuit, 30-40 mc (used with but not part of MS-119).	1					*
bl	3F2670-323B	COMPASS MC-323-B: Brunson Inst. Co., Kansas City, Mo.	1		*			*
bm	2ZK7114.21	CONNECTOR: Male, 4 contact, Amphenol AN-3106-14S-2P (part of CD-1155).	1					*
bn	2Z8672.52	CONNECTOR: Female, 2 contact, Amphenol AN-3106-14S-9S (part of CD-1151).	1					*
bo	2Z7226-259	CONNECTOR: Male, 1 contact, Amphenol 83-ISP (part of CD-1156). ES-D-33740-A.	1					*
bp	2ZK8673.27	CONNECTOR: Female, 3 contact, Amphenol AN-3106-14S-1S (part of CD-1155). ES-D-33740A, Item #2.	1					*
PN-26	2Z6950-26	CONTROL PANEL PN-26 ES-D-33712-A.	1					*
CD-1151	3E1999-151	CORD CD-1151: rubber jacket, 10', 2-conductor, AN-3106-14S-9S plug on one end, 2 Sherman S35A lugs on other end (connect Control Panel PN-26 to 12-volt battery).	1		*			*
CD-1155	3E1999-155	CORD CD-1155: rubber jacket, 10', 2-conductor, connector AN-3106-14S-1S on one end, connector AN-3106-14S-2P on other end (connects Oscillator BC-1304 to radio transmitter).	1		*			*

* Indicates stock available.

68. MAINTENANCE PARTS LIST FOR RADIO BEACON EQUIPMENT RC-163 (cont'd.)

NOTE: Order maintenance parts by stock number, name, and description.

Ref. Symbol	Signal Corps stock No.	Name of part and description	Quan. per equip.	Running Orgn. stock	3d ech.	4th ech.	5th ech.	Depos stock
CD-1156	3E1999-156	CORD CD-1156: Coaxial, RG11/U, 10' single-conductor Amphenol Connector 83-1SP on one end, 2 Amphenol #73-T Bead, Mueller #29 insulator, flexible ground lead of #14-72 stranded copper wire on other end (connects Control Panel PN-26 to antenna post of radio transmitter). ES-D-33740-A-6.	1	*				*
CD-1197	3E1999-197	CORD CD-1197: Bonding Strap, 1', one-conductor, tinned copper wire, as made by Belden, Sherman S35-A lug on either end. ES-D-33740-A-6.	1					*
	1F425.11	CORDAGE: RG-11/U, R.F. coaxial, single-conductor (part of CD-1156). ES-D-33740-A.	10 ft.					*
	1B3018-2.5	CORDAGE: rubber covered, 10', 2-conductor, audio (type H.S.J. 3000 cycle cable by Belden) (part of CD-1156). ES-D-33740-A-3.	10 ft.					*
	1B814.31	CORDAGE: rubber covered, 2-conductor, power (type S) Whitney Blake Rubber Sheathed Cord. Part of CD-1151.	10 ft.					*
BG-177	2Z3400-177	COVER BG-177: olive drab cotton, 16½" x 4⅜" x 4⅜" max. diameter (for Azimuth Dial). ES-D-33768-A.	1	*	*	*	*	*

* Indicates stock available.

68. MAINTENANCE PARTS LIST FOR RADIO BEACON EQUIPMENT RC-163 (cont'd.)

NOTE: Order maintenance parts by stock number, name, and description.

Ref. Symbol	Signal Corps stock No.	Name of part and description	Quan. per equip.	Running Orgn. stock	3d ech.	4th ech.	5th ech.	Depos stock
BG-181	2A2419/C1	COVER BG-181: olive drab cotton, tubular (for base of mast). ES-D-33771-A.	1		*	*		*
M-407	2Z3409-407	CROSSARM M-407: ES-D-33761-A.	1					*
M-408	2Z3409-408	CROSSARM M-408: See ES-D-33759-A.	1					*
	3Z1942	FUSE 4 AG: 20 amps, 25 volts, glass.	1	*				*
	6D13211	INSTRUCTION BOOK.	2					*
MS-50	2A2350	MAST SECTION MS-50.	5					*
MS-51	2A2351	MAST SECTION MS-51.	1					*
MS-119	2A2419	MAST MS-119: See ES-D-33746-A.	1					*
MS-120	2A2420	MAST SECTION MS-120: overall length 31-1/16", steel plug on one end, knurled and threaded male joint and pilot on other end. Fits into MS-50 (for Crossarm M-407). ES-D-33762-A.	4					*
MS-121	2A2421	MAST SECTION MS-121: overall length 13-1/16" (including plug on one end and male joint on other.) Fits into MS-50 (for Crossarm M-407). ES-D-33756-A-11.	1					*
FT-492	2A2582-492	MOUNTING FT-492: steel, base plate, 19" x 12" with 1/2" lip (used to Mount MP-67 to vehicle). ES-D-33745-A.	1					*

* Indicates stock available.

68. MAINTENANCE PARTS LIST FOR RADIO BEACON EQUIPMENT RC-163 (cont'd.)

NOTE: Order maintenance parts by stock number, name, and description.

Ref. Symbol	Signal Corps stock No.	Name of part and description	Quan. per equip.	Running Orgn. stock	3d ech.	4th ech.	5th ech.	Depot stock
FT-493	2Z6721-493	MOUNTING FT-493: shock, pan 6 15/16" x 5 1/2" lined with feet (for tuning Indicator). ES-D-33741-A, ES-D-33742-A, ES-D-33743-A.	1					*
FT-494	2Z6721-494	MOUNTING FT-494: shock, 4 1/4" x 7 5/8" x 53/64", base plate, 2 Lord Shock Mounts #102PH-2, one Lord Shock Mount #102PH-4, upper mounting plate with Dzus Spring type A4-AS4, S4-200 (for audio Osc.). ES-D-33716-A.	1					*
FT-495	2Z6721-495	MOUNTING FT-495: steel, pan 6 15/16" x 5 1/2", with felt pad (for spare lamps, fuses and coils). ES-D-33720-A, ES-D-33721-A.	1					*
BC-1304 ec	2C2697 6R4720-9.5	OSCILLATOR BC-1304: See ES-D-33715-A. PLIERS: water pump, standard adjustable "Superpliers," Williams, Buffalo, N. Y.	1 1					* *
BC-1305 BG-56-A	268100-1305 2Z8056A	RESONANCE TUNER BC-1305: ES-D-33717-A. ROLL BG-56-A (for storage of mast sections). ES-D-33767-A-1.	1 1					* *
el cm	6R14990 33F5311	SCREWDRIVER: 4" x 1/8" blade. TRIPOD: Brunson type, MC-325, Brunson Instrument Co.	1 1					* *
I-234	2C3390-234	TUNING INDICATOR I-234: ES-D-33733-A.	1					*

* Indicates stock available.

68. MAINTENANCE PARTS LIST FOR RADIO BEACON EQUIPMENT RC-163 (cont'd.)

NOTE: Order maintenance parts by stock number, name, and description.

Ref. Symbol	Signal Corps stock No.	Name of part and description	Quant. per equip.	Running spares stock	3d stock	4th stock	5th stock	Depot stock
fd	6R55075	WRENCH: Allen type #1/8.	1	*	*			*
fc	6R57400-10	WRENCH: Allen type #5/32.	1	*	*			*
	6R55498	WRENCH: Allen type #1/16.	1	*	*			*
	6L3108-32	NUT: brass, hex, #8-32.	2		*	*	*	*
	6L3602-56P	NUT: steel, hex, #2-56.	57		*	*	*	*
	6L3604-40P	NUT: steel, hex, #4-40.	74		*	*	*	*
	6L3606-32P	NUT: steel, hex, #6-32.	20		*	*	*	*
	6L3608-32E	NUT: steel, hex, #8-32.	1		*	*	*	*
	6L3610-24P	NUT: steel, hex, #10-24.	15		*	*	*	*
	6L3712-24P	NUT: steel, wing, #12-24.	1		*	*	*	*
	6L3504-20P	NUT: steel, hex, 1/4"-20.	11		*	*	*	*
	6L3806-20P	NUT: steel, wing 1/4"-20.	7		*	*	*	*
	6L3504-20.4P	NUT: steel, stop nut, 1/4"-20, Elastic Stop Nut #2920040.	1		*	*	*	*
	6L3505-18P	NUT: steel, hex, 5/16"-18.	7		*	*	*	*
	6L3805-18P	NUT: steel, wing, 5/16"-18.	1		*	*	*	*
	6L3006-16CR	NUT: steel, castellated, 3/8"-16.	1		*	*	*	*
	6L3006-JP	NUT: steel, jam, hex, 3/8"-16.	4		*	*	*	*
	6L974-8-80	PIN: cotter, steel, 1/8" x 1 1/4" AN-380-4C-5.	1		*	*	*	*
	6L974-6-32	PIN: cotter, steel, 3/32" x 1/2" AN-380.	1		*	*	*	*
	6L6632-2-39	SCREW: set; Allen, cup, #6-32 x 1/8", steel.	2		*	*	*	*
	6L18506-4-31	SCREW: set; Allen, cup, #6-32 x 1/4", steel.	2		*	*	*	*

* Indicates stock available.

68. MAINTENANCE PARTS LIST FOR RADIO BEACON EQUIPMENT RC-163 (cont'd.)

NOTE: Order maintenance parts by stock number, name, and description.

Ref. Symbol	Signal Corps stock No.	Name of part and description	Quan. per equip.	Running Orgn. spares stock	3d ecb.	4th ecb.	5th ecb.	Depot stock
6L18506-4.39		SCREW: set; Allen, cup, 1/4-20 x 1/4", steel.	4	*	*	*	*	*
6L18604-10.95		SCREW: set; Allen, cup, 1/4-20 x 3/8", steel.	2	*	*	*	*	*
6L18604-12.39P		SCREW: set; Allen, cup, 1/4-20 x 3/4", steel.	3	*	*	*	*	*
6L18605-6.39		SCREW: set; Allen, cup, 5/16-18 x 3/8", steel.	3	*	*	*	*	*
6L18512-10-39P		SCREW: set; Allen, cup, #12-24 x 3/8", steel.	2	*	*	*	*	*
6L18208-6.1		SCREW: cap, #8 x 3/8", self-tapping, steel.	12	*	*	*	*	*
6L4884-8P		SCREW: cap, 1/4" x 1/2", self-tapping, steel.	4	*	*	*	*	*
6L4885-8P		SCREW: cap, 5/16" x 1/2", self-tapping, steel.	7	*	*	*	*	*
6L5022-3.1M		SCREW: drive, #2 x 3/16", round head, steel.	28	*	*	*	*	*
		Type "U", Parker Kalon Corp., or equal.						
6L7918-5-12.81P		SCREW: hex head, 5/16"-18 x 3/4", steel.	2	*	*	*	*	*
6L4906-16		SCREW: hex head, 3/8"-16 x 1", steel.	2	*	*	*	*	*
6L6632-7.1Z		SCREW: machine, 6-32 x 7/16" round head, steel.	20	*	*	*	*	*
6L6632-12.1Z		SCREW: machine, 6-32 x 3/4", round head, steel.	20	*	*	*	*	*
6L6832-14.1P		SCREW: machine, 8-32 x 7/8", round head, steel.	16	*	*	*	*	*
6L7032-4.Z		SCREW: machine, 10-32 x 1/4" round head, steel.	1	*	*	*	*	*
6L7024-12-1S		SCREW: machine, 10-24 x 3/4", round head, steel.	4	*	*	*	*	*
6L7224-7.1P		SCREW: machine, 12-24 x 7/16", round head, steel.	4	*	*	*	*	*
6L7920-4-10.1P		SCREW: machine, 1/4"-20 x 3/8", round head, steel.	4	*	*	*	*	*
6L6440-6.1		SCREW: machine #4-40 x 3/8", flat head, brass.	2	*	*	*	*	*
6L6632-8S		SCREW: machine, 6-32 x 1/2", flat head, steel.	5	*	*	*	*	*

* Indicates stock available.

68. MAINTENANCE PARTS LIST FOR RADIO BEACON EQUIPMENT RC-163 (cont'd.)

NOTE: Order maintenance parts by stock number, name, and description.

Ref. Symbol	Signal Corps stock No.	Name of part and description	Quan. per equip.	Running spares	Orgn. stock	3d ech.	4th ech.	5th ech.	Depot stock
	6L6832-44P	SCREW: machine, 8-32 x 2 3/4", flat head, steel.	2		*	*	*	*	*
	6L7024-10S	SCREW: machine, 10-24 x 3/8", flat head, steel.	6		*	*	*	*	*
	6L7920-4-74S	SCREW: machine, 1/4"-20 x 4 7/8", flat head, steel.	3		*	*	*	*	*
	6L388-7P	SCREW: spade, hole in shank 8-32 x 3/4", commercial.	11		*	*	*	*	*
	6L7004	WASHER: lock, steel, #4.	10		*	*	*	*	*
	6L58006P	WASHER: plain, flat, steel, #6.	21		*	*	*	*	*
	6L58008P	WASHER: flat, steel, #8.	5		*	*	*	*	*
	6L76008	WASHER: lock, brass, #8.	3		*	*	*	*	*
	6L70010P	WASHER: lock, steel, #10.	10		*	*	*	*	*
	6L58004P-1	WASHER: flat, steel, 1/4".	5		*	*	*	*	*
	6L71005-2	WASHER: lock, steel, 5/16".	11		*	*	*	*	*
	6L50515	WASHER: flat, fibre, 5/16".	13		*	*	*	*	*
	6L58026-3P	WASHER: plain, flat, steel 3/8".	9		*	*	*	*	*
	6L50506-2	WASHER: flat, fibre, 3/8".	5		*	*	*	*	*
	3A15A	BATTERY: BA-15-A.	15	*	*	*	*	*	*
	2Z5933	LAMP LM-33: incandescent, 12-16V, 125 ma., miniature, bayonet base, single contact, Mazda 57.	2	*	*	*	*	*	*
	3F4056A/L2	LAMP: neon glow, 115 V, 1/4 watt candelabra screw base, Mazda T4-1/2.	4	*	*	*	*	*	*
	2T134	TUBE JAN-12A6 (VT-134).	1	*	*	*	*	*	*
	2T172	TUBE JAN-1S4 (VT-210).	1	*	*	*	*	*	*

77 * Indicates stock available.

68. MAINTENANCE PARTS LIST FOR ANTENNA MOUNT MP-67 (Part of RC-163)

NOTE: Order maintenance parts by stock number, name, and description.

Ref. Symbol	Signal Corps stock No.	Name of part and description	Quan. per equip.	Running Orgn. spares stock	3d ech.	4th ech.	5th ech.	Depot stock
	2Z380-2	ARM: steel; 6-14" long, 1/2" maximum O.D. 1/8" deep x 5/32" wide. ES-D-33723-5. (Part of clutch lever.)	1					*
	2A2562-67/B2	BEARING HOUSING: 6-1/16" long, maximum diameter, 2 3/4" (contains 2 "Oilite" Bearings #F2203-6 Cat. #41). Made by Chrysler Corp., Amplex Div., Detroit, Mich. ES-D-33724-2-15.	1					*
	2A2562-67/B1	BEARING HOUSING, 7/8" O.D. x 1-3/32" long with a .6224" I.D. (contains "Oilite" bronze bearing #F-620-4.) ES-D-33730-19-23.	1					*
	6L405-1.6RF	BOLT: 5/16-18 x 1 1/8" long, RHB, oxidized, medium knurled, ES-D-33726 and ES-D-33727-11. (Assembled with fibre shoe in #25 hole on main shaft.)	1					*
	2A2562-67/C1	CLUTCH: stainless steel, 2 3/8" O.D. x 1" thick. ES-D-33701-1.	1					*
	2Z2935-7	COLLAR: Boston #SC-100 drilled and tapped 5/16-18. ES-D-33701-5. (Used on clutch.)	1					*
	2Z7226-259	CONNECTOR: male, 1 prong. Amphenol 83-1SP. (Used to connect link assembly) ES-D-33728-0.	1					*
	2Z3197	CONTACT: stainless steel, 15/16" long, 1/4" square overall. ES-D-33729-4. (Used with code disc.)	1					*

* Indicates stock available.

68. MAINTENANCE PARTS LIST FOR ANTENNA MOUNT MP-67 (Part of RC-163) (cont.)

NOTE: Order maintenance parts by stock number, name, and description.

Ref. Symbol	Signal Corps stock No.	Name of part and description	Quan. per equip.	Running Orgn. spares stock	3d ech.	4th ech.	5th ech.	Depot stock
	2Z8876.20	CONTACT SPRING: Beryllium copper; 1 1/4" maximum width, 1 3/4" long, #25 gauge (to hold contact for code disc) ES-D-33739-3.	1					*
	2A2562-67/F1	FLAP: panel, cloth, size 5-5/16" x 9 1/4" ES-D-33707-23 metal stiffeners in each long side (for Control Panel PN-26).	1					*
	6Z8906.2	GASKET MATERIAL: vellumoid; 12" x 12" x 1/16" thick. (Used on main shaft.)	1					*
	6Z8906.1	GASKET MATERIAL: vellumoid; 12" x 12" x 1/32" thick. (Used on clutch lever.)	1					*
	2Z4866.72	GASKET: rubber, O.D. 1 1/8", I.D. 1-7/16", thickness 1/16" ES-D-33727-10. (Used on main shaft.)	1					*
	6Z6325	GROMMET: rubber, Amphenol #22-10, ES-D-33701-44.	1					*
	2Z4928-10	HANDLE: steel, P-4 Parkerized, straight tapered handles, overall length 3-3/16". (Part of main shaft assembly) ES-D-33726-5.	2					*
	2Z4928-11	HANDLE, steel, 1-11/64" long x 1/4" maximum O.D. (Part of clutch lever assembly) ES-D-33723-3.	2					*

* Indicates stock available.

80 **68. MAINTENANCE PARTS LIST FOR ANTENNA MOUNT MP-67 (Part of RC-163) (cont.)**

NOTE: Order maintenance parts by stock number, name, and description.

Ref. Symbol	Signal Corps stock No.	Name of part and description	Quan. per equip.				
			Running spares	Orgn. stock	3d ech.	4th ech.	5th ech. Depos stock
2A2562-67/J1		INSERT: natural Phenolic XXX, 1 1/8" O.D. x 1-19/64" long. ES-D-33728-3. Mounts to angles on coaxial line.	1				*
2Z5575-13		JACK: special, beryllium copper, silver plate inside and outside, single-contact, assembled with music wire ring. ES-D-33728-2-5. Used on coaxial line.	3				*
6L996-19		KEY: steel, 11/64" square x 1-3/16" long. For securing worm to shaft. ES-D-33701-11.	1				*
2A2562-67/C2		LINE ASSEMBLY: coaxial brass outer conductor, RG-11/U cable inner conductor, 83-1SP plug, 2 brass angles, ES-D-33728-1-2-3-4-5-7-8-9-10-11-12—with phenolic insert and 3 copper jacks. (Used on main shaft.)	1				*
2A2562-67/L2		LINK ASSEMBLY: coupling, coil on phenolic tubing connected to SO-239 receptacle on brass spinning. ES-D-33729-1-2-3-5-6-7-8-9-10-11.	1				*
3H3100-7		MOTOR: gear reducer, Bodine Elec. Co., Chicago, Ill. ES-D-33707-21.	1				*
6L3426-20P		NUT: special, 7/8" long x 1 1/2" O.D. tapped 1/2"-20, medium Diamond knurl. ES-D-33732-21-12. (Used on shaft of code wheel.)	2				*

* Indicates stock available.

68. MAINTENANCE PARTS LIST FOR ANTENNA MOUNT MP-67 (Part of RC-163) (cont.)

NOTE: Order maintenance parts by stock number, name, and description.

Ref. Symbol	Signal Corps stock No.	Name of part and description	Quan.				
			per equip.	Running spares stock	3d ech.	4th ech.	5th ech. Depos stock
2Z3883-66		PILOT LIGHT ASSEMBLY: Gothard #805. ES-D-33701-42. 1" frosted jewel, miniature bayonet socket. (Mounts in 1" hole.)	1				*
2Z7091-11		PLATE: black phenolic, XXX, 2 1/4" long, 1" wide, 1/32" thick, with 4 #27 mounting holes. ES-D-33739-2. (Used on Keyer.)	1				*
2A2362-67/P1		PLATE: black phenolic, XXX, 2 1/4" long, 1" wide, 3/16" thickness, with 6 #27 mounting holes. ES-D-33739-1. (Used on Keyer.)	1				*
2Z7091-10		PLATE: brass, 1 1/4" with 2 #27 mounting holes. ES-D-33739-5. (Used on Keyer.)	1				*
2Z7091-12		PLATE ASSEMBLY: rider, 5.457" O.D., linen bakelite 1/4" thick disc riveted to 5 3/16" O.D. x 16 gauge sheet supporting plate. ES-D-33732-16-17. .562" hole in diameter. (Used on Code Wheel.)	1				*
2Z7858-11		RING: bronze, oxidized, 1/8" thick, I.D. 1 1/2" O.D. 1.747". ES-D-33727-12. (Used on Main Shaft.)	1				*
6L7920-4-10.93P		SCREW: steel, special; 1/4"-20 thread, 3/16" long x 5/32" diameter, smooth tip, head with slot. ES-D-33723-9. (Used on Clutch Lever.)	2				*

81 * Indicates stock available.

68. MAINTENANCE PARTS LIST FOR ANTENNA MOUNT MP-67 (Part of RC-163) (cont.)

NOTE: Order maintenance parts by stock number, name, and description.

Ref. Symbol	Signal Corps stock No.	Name of part and description	Quan. per equip.	Running Orgn. spares stock	3d ech.	4th ech.	5th ech.	Depot stock
	2A2562-67/S1	SHELL (Outer): steel; 1" O.D. x 2 1/8" long assembled with 2 steel studs. ES-D-33723-1-11. (Part of Clutch Lever.)	1					*
	2A256-67/S2	SHOE: brass; 1/4" thick x .245" wide, curved to fit around 11/16" radius. ES-D-33723-8. (Used on Clutch Lever.)	2					*
	2Z8876.21	SPRING: coil; 6 coils of #14 A.S. & W. gauge steel music wire. ES-D-33705-6. I.D. 1 1/32", free length 2".	1					*
	6L31374	STUD: steel; 1/2" diameter 1/8" thick flat head. ES-D-33723-10. (Used on Clutch Lever.)	2					*
	6L31139-1	STUD: steel; 1 41/64" long, hex head, 3/8-24 thread. ES-D-33701-7.	1					*
	3Z9558-27.1	SWITCH ASSEMBLY: "MU-switch" type AGBP-SPST. ES-D-33701-43. Assembled with steel bracket and plunger.	1					*
	6L8026-3P	WASHER: steel, special; P-4 Parkerized, flat, O.D. 1 1/2", center hole W(.386)", thickness 3/32", ES-D-33706-16.	1					*
	2A2562-67/L1	YOKE: steel; 1/2" long piece of 15/16" I.D. tubing with 2 steel arms. ES-D-33723-7. (Used on Clutch Lever.)	1					*

* Indicates stock available.

68. MAINTENANCE PARTS LIST FOR MAST MS-119 (Part of RC-163)

NOTE: Order maintenance parts by stock number, name, and description.

Ref. Symbol	Signal Corps stock No.	Name of part and description	Quan. per equip.	Running Orgn. spares stock	3d ech.	4th ech.	5th ech.	Depos stock
	2Z1250.58	BRACKET: sheet, "U" shaped, Sides 1 9/16" long with 1/4"-20 x 7/8" long flat head machine screw (steel), ES-D-33749-2-6. (Part of Sight.)	1					*
	2A2419/C2	CABINET: steel; 4 3/16" x 6 1/4" x 7" overall dimensions with hinged door, steel shield, steel graph holders. ES-D-33754-1-2-3-10-13-17-18-31. (Part of Tuning and Phasing Box.)	1					*
cs	3DF15	CAPACITOR: air variable 6.5mmf. to 50mmf. (Part of Tuning and Phasing Box.)	1					*
	3DF91	CAPACITOR: air variable 7.5 mmf. to 100 mmf. (Part of Tuning and Phasing Box.)	1					*
	2A2419/C3	CLAMP: steel; 1 3/4" x 1 1/32", 2 lips, steel pads and brackets, ES-D-33750-15. (Part of Tuning and Phasing Box.)	2					*
	IF4N1-1.81	CORD: assembly mast, overall length 81" vinyl jacket RG-11/U, single-conductor, RF cable, Amphenol #73-T Bead on one end, bonding tube with 2 brass brackets on other end, ES-D-33766.	1					*
	2A2419/C4	COVER: olive drab cloth; 4 3/8" x 10" at bottom, 4 3/8" x 7" at top, overall height 10", ES-D-33754-16. (For Tuning and Phasing Box.)	1					*

* Indicates stock available.

68. MAINTENANCE PARTS LIST FOR MAST MS-119 (Part of RC-163) (cont'd.)

NOTE: Order maintenance parts by stock number, name, and description.

Ref. Symbol	Signal Corps stock No.	Name of part and description	Quan. per equip.	Running spares stock	3d ech.	4th ech.	5th ech.	Depot stock
	2Z3764.12	DIAL: 0-100 over 180°, 1 3/4" O.D. complete with indicators ICA single line #2193, Crowe #6168, ES-D-33750-19. (Part of Tuning and Phasing Box.)	2					*
	6Z8906.1	GASKET MATERIAL: Vellumoid; 12" x 12", 1/32" thick.	1					*
	6Z8906	GASKET MATERIAL: Vellumoid; 12" x 12", 1/64" thick.	1					*
	3G1837-24.7	INSULATOR: insert XXX natural Phenolic; 3/4" long x 2" maximum O.D., ES-D-33746-5.	1					*
	3G1837-136	INSULATOR: XXX natural Phenolic; 4 1/4" long x 2 1/2" maximum O.D., 3 flutes, steel tube, ES-D-33750-8-9. (Part of Tuning and Phasing Box.)	1					*
	3G1837-240	INSULATOR ASSEMBLY: Special, XXX natural Phenolic; 7 1/2" long x 2 3/8" max. O.D., 3 flutes around center, assembled with .8875 x #16 gauge steel stiffener tube, ES-D-33746-2-6.	1					*
	2A2419/J1	JACK: beryllium copper, 2 3/8" long, 1" max. O.D. threaded 5/16"-18 (to receive mast section MS-51) ES-D-33754-6.	1					*

* Indicates stock available.

68. MAINTENANCE PARTS LIST FOR MAST MS-119 (Part of RC-163) (cont'd.)

NOTE: Order maintenance parts by stock number, name, and description.

Ref. Symbol	Signal Corps stock No.	Name of part and description	Quan. per equip.	Running Orgn. spares stock	3d ech.	4th ech.	5th ech.	Depot stock
	2A2419/J2	JACKET: Rain Shield spinning, steel, 2 1/4" O.D. x 3/4" deep, ES-D-337544. (Part of Tuning and Phasing Box.)	1					*
	2ZK3714-6	LOCK: dial; Millen type #10050, ES-D-33717-13.	2					*
	2A2419/P1	PLATE: coil; special, XXX natural Phenolic, 4-1/16" x 6 3/4" x 5/16", ES-D-33750-2. (Part of Tuning and Phasing Box.)	1					*
	3G1837-8.10	INSULATOR: XXX natural Phenolic Plate, 2" O.D. x 1/4" thick, .332" hole in center, ES-D-33754-7. (Part of Tuning and Phasing Box.)	1					*
	2A2419/P3	PLUG: beryllium copper, 1 3/16" overall length, plug proper 13/16" long x 1/8" diameter, rounded tip, ES-D-33750-7. (Part of Tuning and Phasing Box.)	4					*
	2A2419/P2	PLUG: beryllium copper, 1 5/16" overall length, plug proper 13/16" long x 1/8" diameter, rounded tip, ES-D-33746-7.	3					*
	2A2419/E1	SHAFT EXTENSION: overall length 4 3/4" steel shaft pinned in linen bakelite tubing, ES-D-33750-10-11. (Part of Tuning and Phasing Box.)	2					*

* Indicates stock available.

68. MAINTENANCE PARTS LIST FOR MAST MS-119 (Part of RC-163) (cont'd.)

NOTE: Order maintenance parts by stock number, name, and description.

Ref. Symbol	Signal Corps stock No.	Name of part and description	Quan. per equip.	Running Orgn. stock	3d ecb.	4th ecb.	5th Depot stock
	2A2419/S1	SIGHT: steel; 4 1/4" long x 3/8" wide x 1/8" thick with ends turned up 11/16", ES-D-33746-11.	1				*
	2A2419/S2	SUPPORT: XXX natural Phenolic, 2 3/8" x 1/2" x 1", ES-D-33750-6. (Part of Tuning and Phasing Box.)	1				*
	2A3419/S4	SUPPORT: XXX natural Phenolic, 2 3/8" x 1/2" x 1" has spot of white paint identifying it with Crossarm M408. (Part of Tuning and Phasing Box.)	1				*
	2A2419/S3	SUPPORT: steel; "L" shaped, ES-D-33749-1. (Used on Sight.) (Holds mast sight.)	1				*
	2A2419/M1	MAST SECTION: lower, stainless steel, 2 1/4" O.D. x 8 1/2" long, ES-D-33746-3, #11 gauge steel wall.	1				*
	2A2419/M2	MAST SECTION: upper, steel, O.D. 2 1/8", length 67", ES-D-33746-1.	1				*
	6L58764	WASHER: steel; 17/8" O.D. x 7/8" I.D. x 3/32" thick, ES-D-33750-14. (Used in Tuning and Phasing Box.)	1				*
	6L50114-1	WASHER: shim type; brass, 1 1/2" O.D. x 9/32" I.D. ES-D-33749-2. (Used on Sight.)	2				*
	2Z4880-38	WINDOW: lucite; 2 15/16" x 1/32", ES-D-33754-14. (Used in Tuning and Phasing Box.)	2				*

* Indicates stock available.

68. MAINTENANCE PARTS LIST FOR CONTROL PANEL PN-26 (Part of RC-163)

NOTE: Order maintenance parts by stock number, name, and description.

Ref. Symbol	Signal Corps stock No.	Name of part and description	Quan. per equip.	Running Orgn. stock	3d ecb.	4th ecb.	5th ecb.	Depot stock
	2Z9405-1	TERMINAL STRIP: bakelite, 3" long x 5/8" wide, 1/2" max. thick., 5 terminals, Howard B. Jones Co., #5-141.	1					*
	3DA500-148	CAPACITOR: paper; triple 500,000 mmf., 100 VDCW, -10%, +20%, Solar type 3XDH1-5.	1					*
	2Z2636-1	CLAMP: cable; AN-3057-8 with female threads for mechanically fastening the cable to connector.	1					*
	2Z7226-Q264	CONNECTOR: 5-conductor, male, with coupling ring, AN-3106-16S-8S.	1					*
	2Z8799-231	RECEPTACLE: female; 4 conductor.	1					*
	2Z8799-33	RECEPTACLE: male; 3 conductor.	1					*
	2Z7112-30	RECEPTACLE: male; 2-conductor, AN-3102-14S-9P.	1					*
	1B3016-4.1	CORDAGE: 4 conductors, #16 stranded copper, rubber insulated, .410 O.D.	9 ft.					*
	3Z1942	FUSE: 20 amp., volt, type 4AG, Littelfuse.	1					*
	3Z1939	FUSEHOLDER: Littelfuse #1212B (for type 4AG).	1					*
	2Z5883-66	LAMP MOUNTING ASSEMBLY: miniature bayonet socket (pilot) Gothard #805.	1					*

* Indicates stock available.

∞ **68. MAINTENANCE PARTS LIST FOR CONTROL PANEL PN-26 (Part of RC-163) (cont.)**

NOTE: Order maintenance parts by stock number, name, and description.

Ref. Symbol	Signal Corps stock No.	Name of part and description	Quan. per equip.	Running Orgn. stock	3d ech.	4th ech.	5th ech.	Depot stock
	2Z7585-38	RELAY, SPST: 20 amp., normally open, 12 volt DC coil Guardian Elec. Co., Type A-1.	1					*
	3Z6030.5	RESISTOR: carbon; 300 ohms, 1 watt, +10%, insulated, American War Standard Type RC 31AE301K.	1					*
	2Z8320	SHIM: fiber; 3/8" long, 1 3/8" wide, 1/64" thick (insulates relay).	1					*
	2Z8320-1	SHIM: fiber; 3/4" long, 1 1/4" wide, 1/64" thick (insulates relay).	1					*
	3Z9849.69	SWITCH: toggle; DPST, Cutler-Hammer, Inc., #8701-K5.	1					*

* Indicates stock available.

68. MAINTENANCE PARTS LIST FOR TUNING INDICATOR I-234 (Part of RC-163)

NOTE: Order maintenance parts by stock number, name, and description.

Ref. Symbol	Signal Corps stock No.	Name of part and description	Quan. per equip.	Running spares stock	3d ech.	4th ech.	5th ech.	Depos stock
eo	2A288A-7	ANTENNA: telescopic, steel, (Top 3 sections only), North American Philips #RB-3141.	1					*
ep	3K2010112	CAPACITOR: mica; 100 mmf., 500 VDCW, +5%, Aerovox 1468.	1					*
ep	3D9104V	CAPACITOR: variable; 100 mmf., maximum capacity, 500 VDCW air dielectric "Telradio" AP-10.	1					*
	2C5390-234/C1	COIL ASSEMBLY: tuning coil, lug and flange.	1					*
	2Z3764.12	DIAL: 1 3/4" O.D. calibrated 0-100 over 180°.	1					*
	6Z8906	GASKET: vellumoid; 12" x 12" x 1/64" thick.	1					*
	6Z8906.2	GASKET: vellumoid; 12" x 12" x 1/16" thick.	1					*
	6Z8906.1	GASKET: vellumoid, 12" x 12" x 1/32" thick.	1					*
	3G1837-22.1	INSULATOR: XXX natural Phenolic, 1" ma. O.D. x 43/64" long.	1					*
	2ZK3714-6	LOCK: dial, rim type, Millen type 10050.	1					*
	3G1837-20.4	INSULATOR: support XXX natural Phenolic, 1" O.D. x 3/8" long.	1					*
	2ZK11102.4	SHIELD: tube; bayonet type, 3/4" O.D. x 1 3/4" long.	1					*
	2Z8675.43	SOCKET: tube; 7-contact, miniature mica-filled bakelite.	1					*
	3Z9815-2	SWITCH: push-pull; SPST, 5 amp., 110V Cutler.	1					*

* Indicates stock available.

68. MAINTENANCE PARTS LIST FOR TUNING INDICATOR I-234 (Part of RC-163) (cont.)

NOTE: Order maintenance parts by stock number, name, and description.

Ref. Symbol	Signal Corps stock No.	Name of part and description	Quan.					
			per equip.	Running spares stock	3d ech.	4th ech.	5th Depot stock	
3G1837-3.2		INSULATOR WASHER: XXX Natural Phenolic, 1" O.D. x 3/32" thick, #18 hole in center.	1					*
2Z4880-40		GLASS WINDOW: lucite; 3 7/16" O.D. x 1/8" thick.	1					*

* Indicates stock available.

68. MAINTENANCE PARTS LIST FOR OSCILLATOR BC-1304 (Part of RC-163)

NOTE: Order maintenance parts by stock number, name, and description.

Ref. Symbol	Signal Corps stock No.	Name of part and description	Quan. per equip.	Running Orgn. shares	3d stock	4th ech.	5th ech.	Depos stock
	3K2051122	CAPACITOR: mica; fixed 500 VDCW, 500 mmf., +5%, Aerovox 1468.	1					*
	2Z2636-12	CLAMP: cable AN-3057-6.	1					*
	2ZK7114.21	CONNECTOR: AN-3106-14S-2P, 4-conductor.	1					*
	1B3018-4	CORDAGE: rubber-covered, 4-conductor, #18/20 wire.	1		*			*
dv	3Z4663	RESISTOR: carbon; insulated, 2,500 ohms, 1/2W, +10%, American War Standard Type RC-21AE242J.	1		*			*
dya	3Z6300-20	RESISTOR: carbon; insulated, 3,000 ohms, 1/2W, +10%, A.W.S. type RC21AE302J.	1		*			*
dw	3Z6390-5	RESISTOR: carbon; insulated, 3,900 ohms, 1/2W, +10%, A.W.S. type RC21AE392J.	1		*			*
dx	3Z6500-64	RESISTOR: carbon; insulated, 5,000 ohms, 1/2W, +10%, A.W.S. type RC21AE512J.	1		*			*
dy	3Z6570-2	RESISTOR: carbon; insulated, 7,000 ohms, 1/2W, +10%, A.W.S. type RC21AE682J.	1		*			*
	2ZK11102.4	SHIELD ASSEMBLY: tube; bayonet type, with retaining spring, Cinch #8661.	2					*
ea	2Z8678.62	SOCKET: tube; 8 contact, molded bakelite.	3		*			*
eb	2Z8675.43	SOCKET: tube; miniature, 7-contact, mica-filled bakelite.	2		*			*
ec	3Z9825-55.32	SWITCH: rotary; 5-contact, Shorting.	1					*
ed	2Z9638-8	TRANSFORMER: audio; 2 to 1 ratio.	1					*

* Indicates stock available.

68. MAINTENANCE PARTS LIST FOR RESONANCE TUNER BC-1305 (Part of RC-163)

NOTE: Order maintenance parts by stock number, name, and description.

Ref. Symbol	Signal Corps stock No.	Name of part and description	Quan. per equip.	Running Orgn. stock	3d ech.	4th ech.	5th ech.	Depot stock
	3D9080V-8	CAPACITOR: variable air, 6.5 mmf. to 80 mmf., 500 V.A.C. breakdown.	1	*				*
	3C1084Y	COIL ASSEMBLY: special 4-turns of #18 gauge copper wire on bakelite form, impregnated with varnish. ES-D-33717-8-4-31-17-9-18-19-20.	1	*				*
	2Z8799-239	CONNECTOR: SO-239.	1					*
	2Z3352.28	COVER: steel, 3 3/8" x 5 5/32" #18 U.S. gauge, zinc-plated, ES-D-33717-2-32-33 (side cover).	1					*
db	2Z3764.12	DIAL: calibrated 0-100 over 180°, 1 3/4" O.D. Crowe #6168 ES-D-33717-12.	1	*				*
	2ZK3714-6	LOCK: dial, rim type, Millen type 10050. ES-D-33717-13.	1	*				*
	2Z6960-42	PANEL: lucite, 2 11/16" x 1 29/32" x 1/64" (for calibration chart) ES-D-33717-7.	1					*

* Indicates stock available.

68. MAINTENANCE PARTS LIST FOR CROSSARM M-407 or M-408 (Part of RC-163)

NOTE: Order maintenance parts by stock number, name, and description.

Ref. Symbol	Signal Corps stock No.	Name of part and description	Quan. per equip.	Running spares stock	3d ecb.	4th ecb.	5th ecb.	Depot stock
1F425-57		CABLE: RG-57/U, RF, solid dielectric, 2-conductor cable (connects jacks on ends of crossarms).	15 1/3 ft.	*	*	*	*	*
2Z3352.27		COVER: 20 gauge CRS, 2 3/8" long.	2	*	*	*	*	*
2Z3294		RECEPTACLE: mast section; hard brass, silver plated.	4	*	*	*	*	*
2Z3352.26		JACKET: steel; upper, #20 CRS (cap 1 3/4" dia. x 3/4" high).	2	*	*	*	*	*
6Z8906.1		GASKET MATERIAL: vellumoid; 12" x 12" x 1/32" thick.	1	*	*	*	*	*
6Z8906		GASKET MATERIAL: vellumoid; 12" x 12" x 1/64" thick.	1	*	*	*	*	*
2Z7102		INSERT: crossarm; Phenolic, 57/64" sq. x 1 1/2" long (for M-407).	1	*	*	*	*	*
2Z7102-1		INSERT: crossarm, Phenolic, 57/64" sq. x 1 1/2" long (for M-408, marked with a white spot).	1	*	*	*	*	*
3G1837-62		INSULATOR: Phenolic; 1.39" dia. x 1 15/16" long.	4	*	*	*	*	*
2Z5522.4		JACK ASSEMBLY PIN: 1-conductor (fits plug on MS-119).	4	*	*	*	*	*

* Indicates stock available.

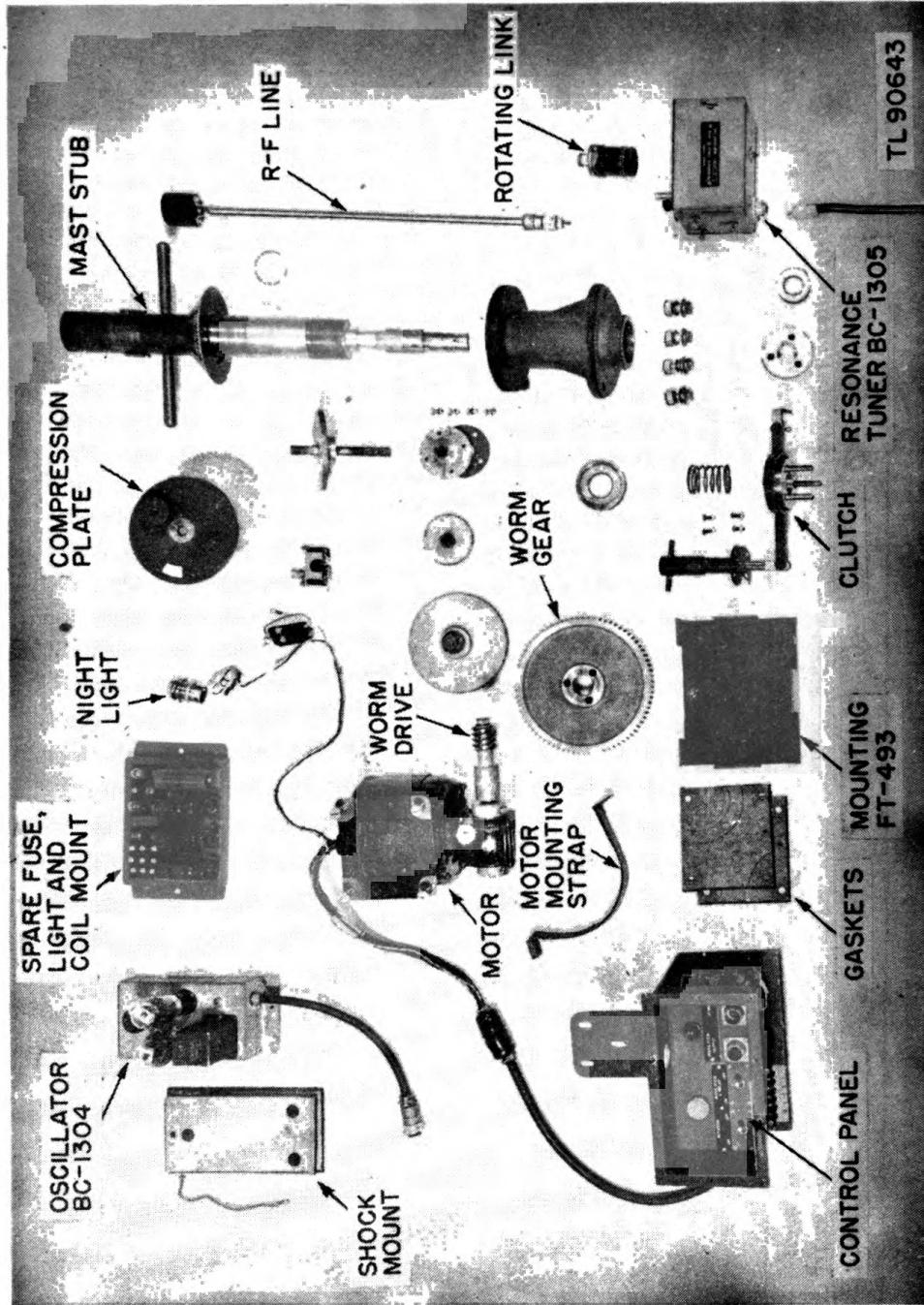

Figure 40. Components of Antenna Mount MP-67.

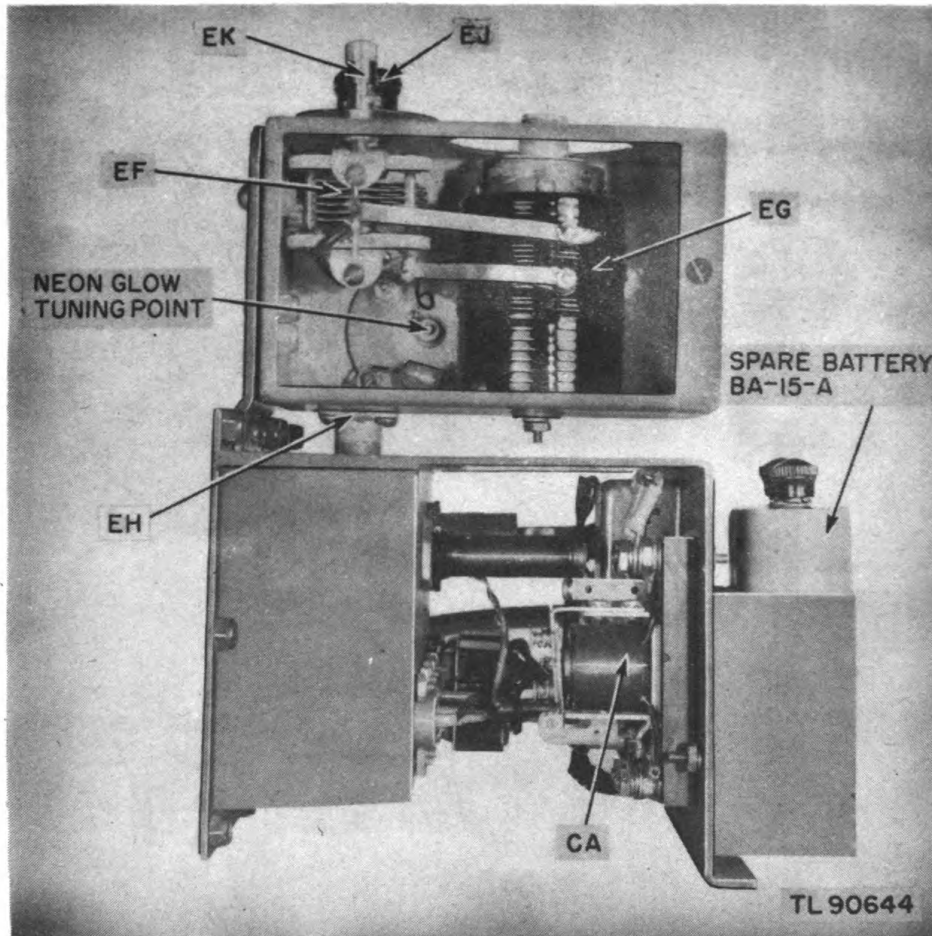

Figure 41. Control panel and resonance tuner.

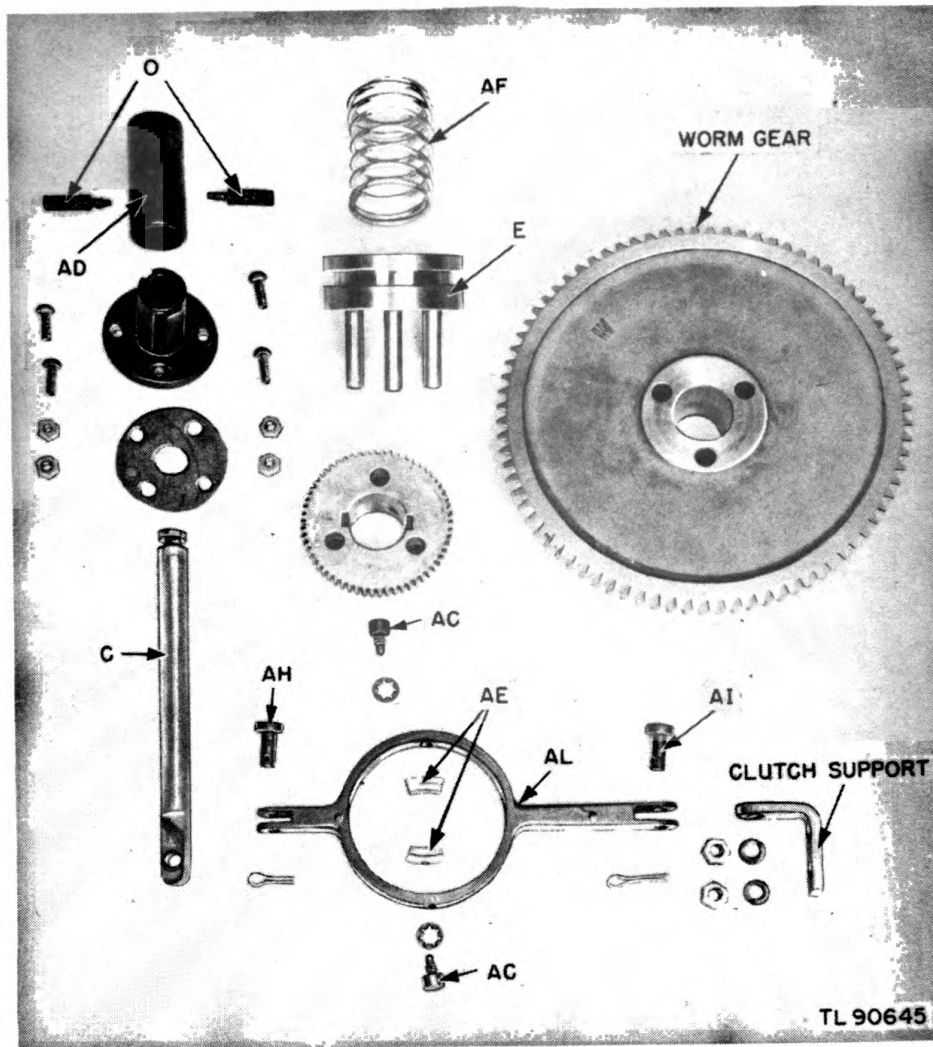

Figure 42. Clutch.

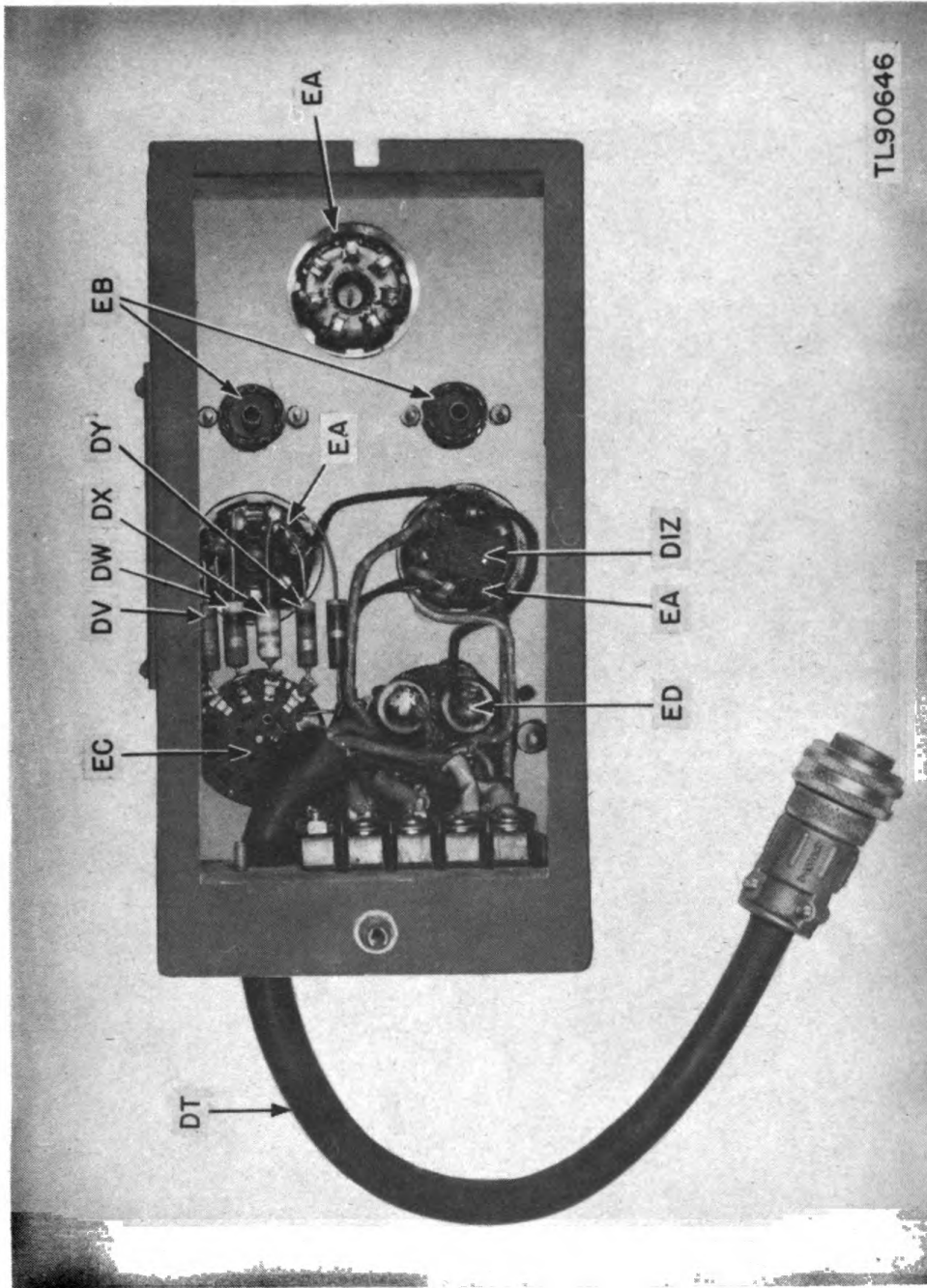

Figure 43. Oscillator.

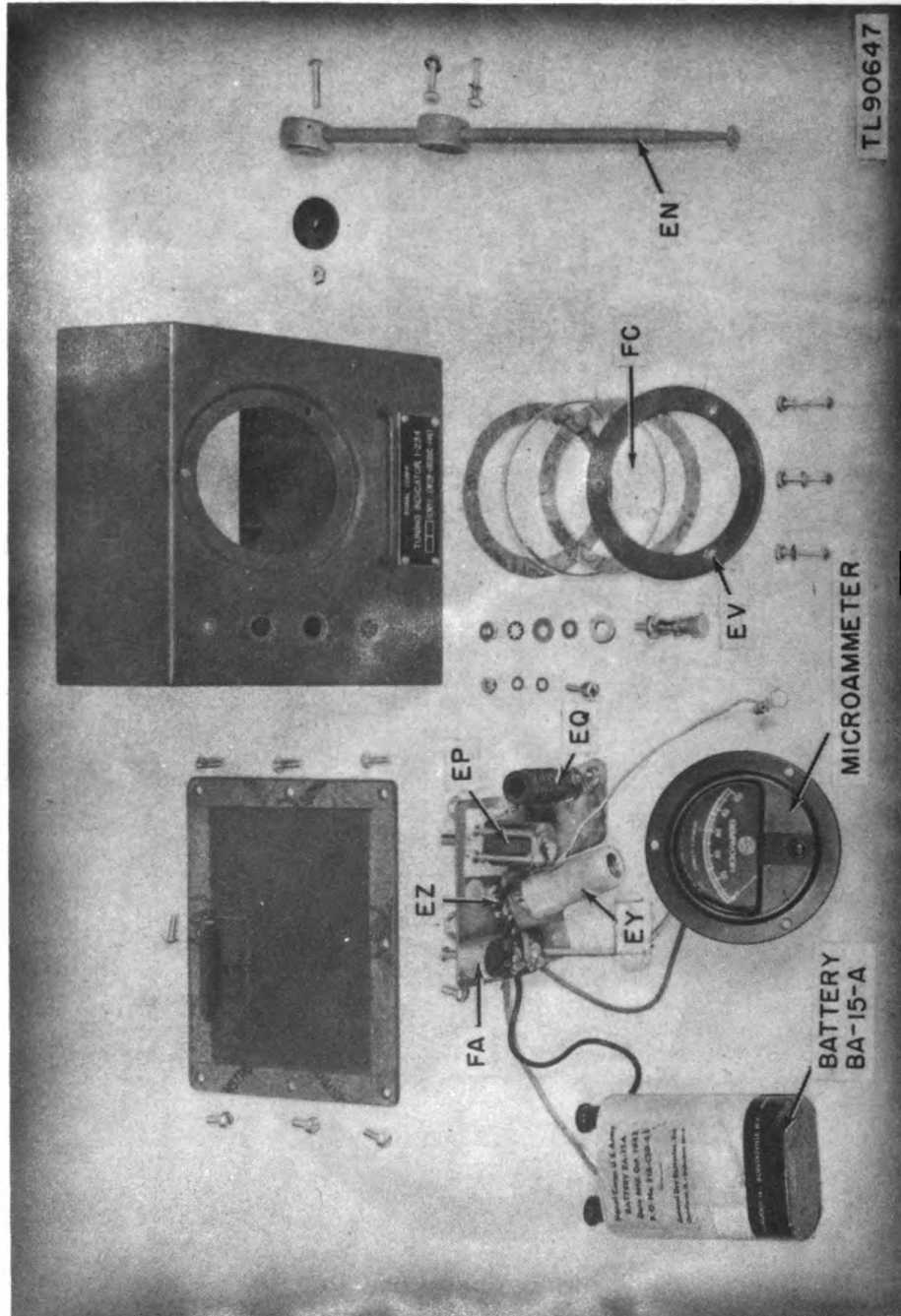

Figure 44. Tuning indicator.

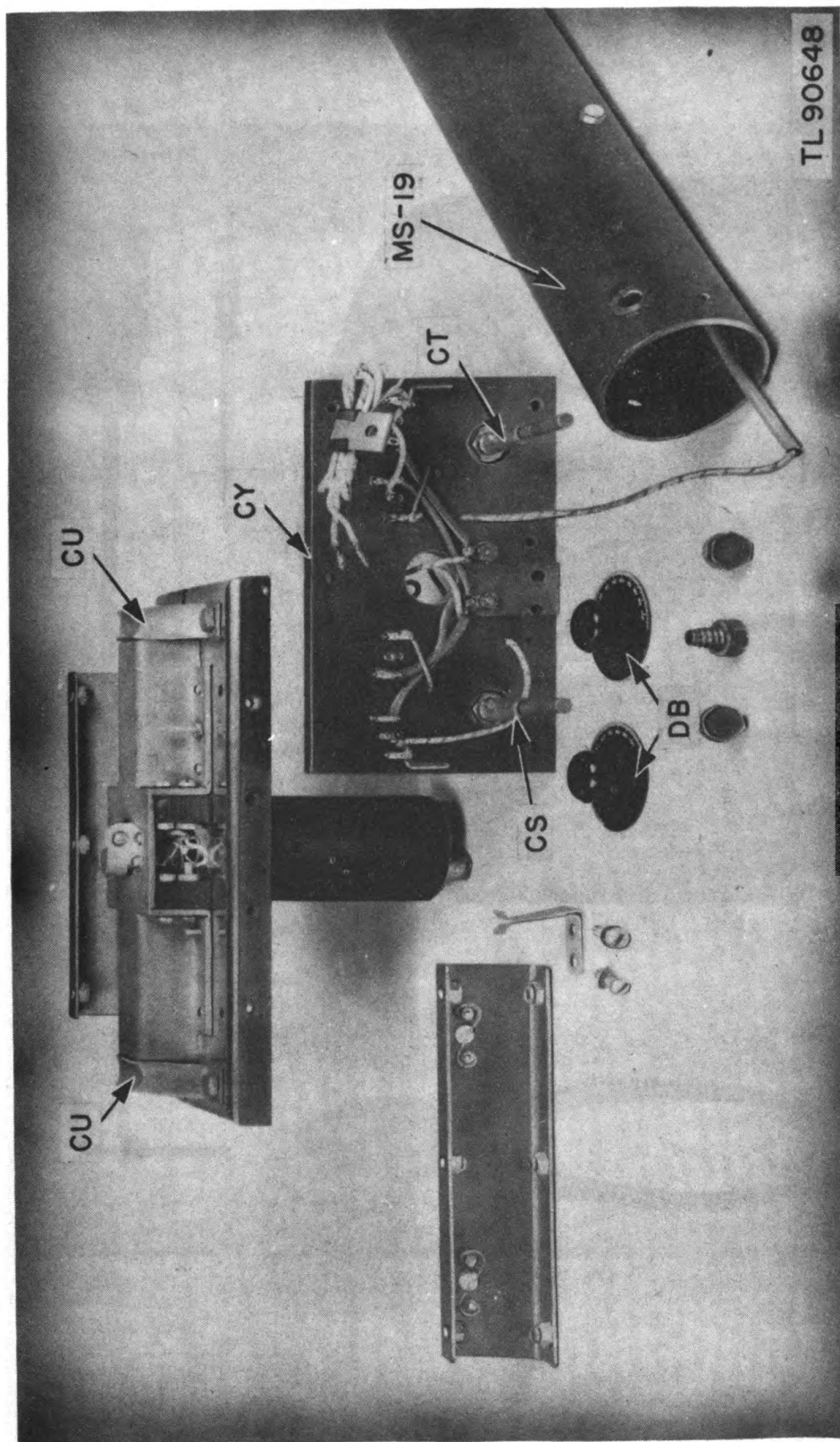

Figure 45. Phase-load box.

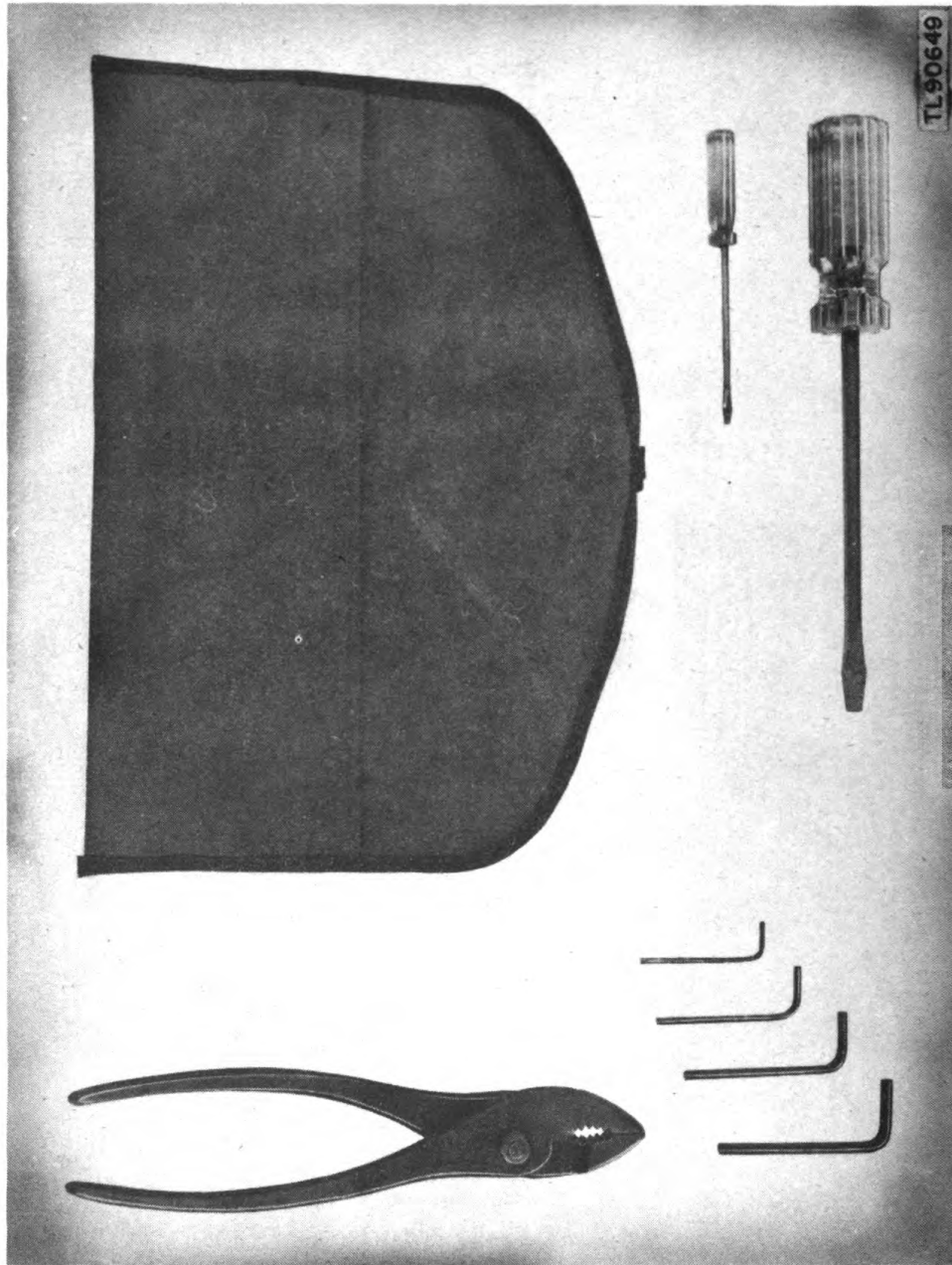

Figure 46. Tool kit.

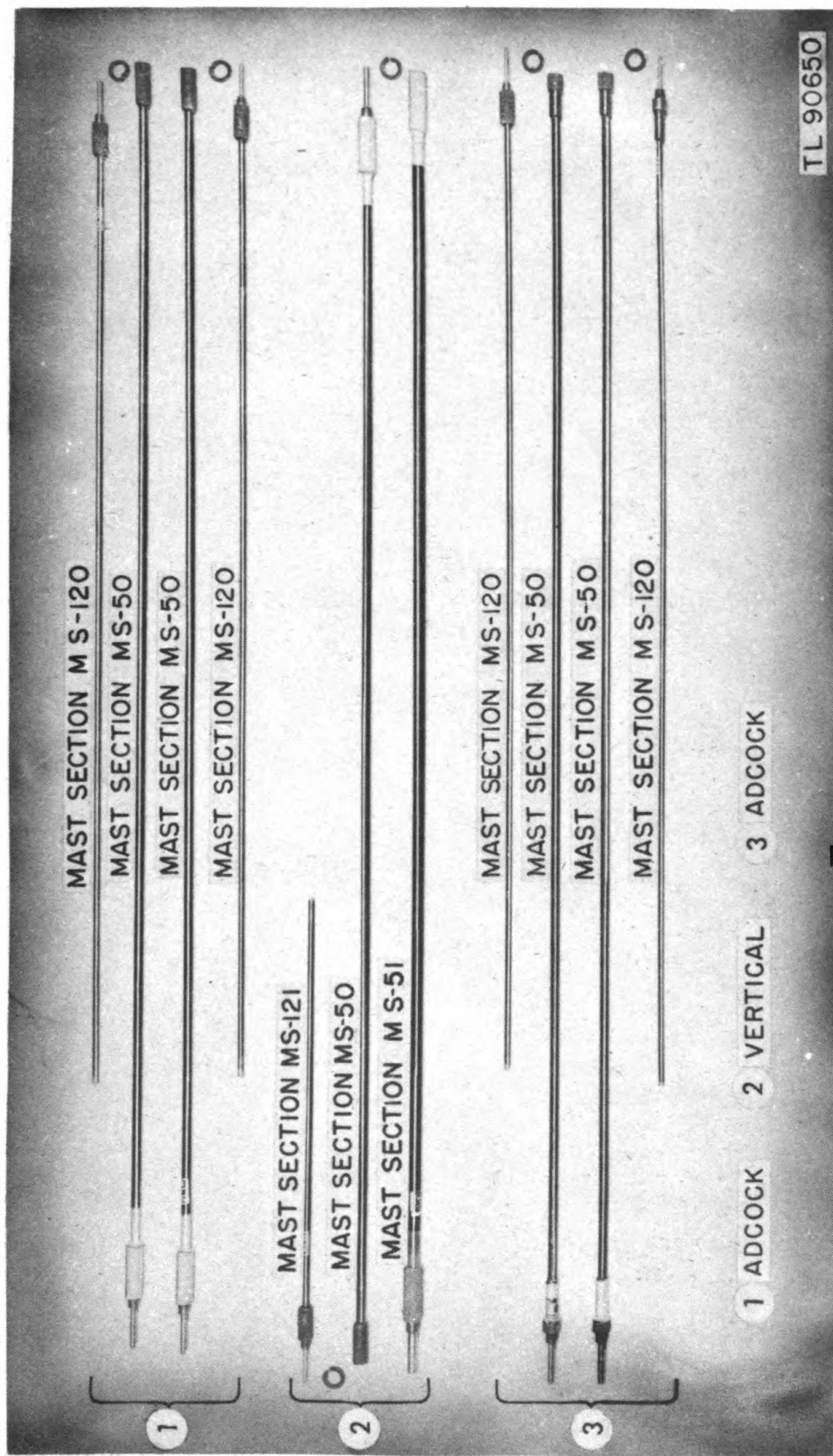

Figure 47. Mast sections.

714—MPD—44

1750

29 May 1944

U. S. GOVERNMENT PRINTING OFFICE O-1944

Digitized by 

Original from
UNIVERSITY OF CALIFORNIA

