

SC  
3585  
A

RESTRICTED



# SIGNAL SECTION AIR SERVICE COMMAND

## *VHF Fighter Control*

# EQUIPMENT HANDBOOK



**SIGNAL SECTION • AIR SERVICE COMMAND**  
**PATTERSON FIELD • FAIRFIELD, OHIO**

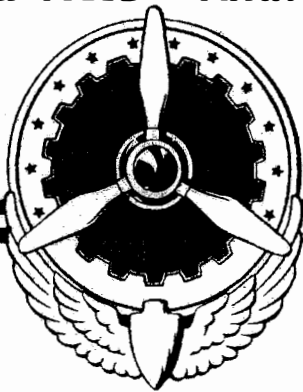

RESTRICTED

THE OTTERBEIN PRESS, DAYTON, OHIO  
OCTOBER, 1943—2,000

RESTRICTED

Approved for publication and distribution in Air Service Command

**THIS PUBLICATION MAY BE USED BY PERSONNEL RENDERING SERVICE TO THE UNITED STATES OR ITS ALLIES**

Paragraph 5.d. of Army Regulation 380-5 relative to the handling of "restricted" printed matter is quoted below.

*"d. Dissemination of restricted matter.—The information contained in restricted documents and the essential characteristics of restricted material may be given to any person known to be in the service of the United States and to persons of undoubted loyalty and discretion who are cooperating*

*in Government work, but will not be communicated to the public or to the press except by authorized military public relations agencies."*

This permits the issue of "restricted" publications to civilian contract and other accredited schools engaged in training personnel for Government work, to civilian concerns contracting for overhaul and repair of aircraft or aircraft accessories, and to similar commercial organizations.

**LIST OF REVISED PAGES ISSUED**

**NOTE:** A heavy black vertical line, to the left of the text on revised pages, indicates the extent of the revision. This line is omitted where more than 50 percent of the page is revised.

This issue contains no revisions.

**ADDITIONAL COPIES** of this publication may be secured on Requisition, AAF Form 102, as prescribed in AAF Regulations 15-102. Submit requisitions to: Commanding General, Air Service Command, Patterson Field, Fairfield, Ohio. Also, see T. O. No. 00-25-3 for details on distribution of Technical Orders. (Requests from Naval activities shall be submitted to: Chief of the Bureau of Aeronautics, Navy Department, Washington, D. C.)

SC  
3585  
A

RESTRICTED

ARMY AIR FORCES  
HEADQUARTERS  
AIR SERVICE COMMAND

ASCPT  
50-180-1  
1 Page  
Page 1

5 October 1943

PERSONNEL & TRAINING )  
DIVISION CIRCULAR :  
NO. 50-180-1 )

TRAINING

Signal Section VHF Fighter Control  
Equipment Handbook

1. Establishment of Handbook. The Signal Section, Air Service Command, VHF Fighter Control Equipment Handbook is established as a guide for the use of Signal Supply Officers and others concerned.

2. Purpose. The Signal Section VHF Fighter Control Equipment Handbook has been designed to:

a. Facilitate the training of inexperienced supply officers and to help them become familiar with actual VHF Ground Radio Equipment in the shortest period of time.

b. Act as a reference for experienced Air Service Command Supply Officers.

3. Additional Signal Section Equipment Handbooks. This is the second in a series of picture supply manuals. Additional handbooks covering other categories of equipment will be issued as soon as the compilation of material is complete.

4. Distribution. Distribution of copies of this Handbook is being made direct from Headquarters, Air Service Command to the Signal Sections of area Air Service Commands and other Signal activities concerned.

By command of Major General FRANK:

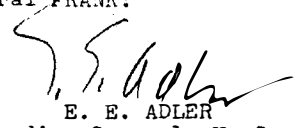

E. E. ADLER  
Brigadier General, U. S. A.  
Chief, Personnel & Training Division

RESTRICTED

B



**RESTRICTED**

**THIS MANUAL IS ONLY A GUIDE**

The equipment listed in this Manual is based on the standard VHF Fighter Control Systems. Equipment in these systems vary according to the tactical situation and are not always standard.

## **★ I N T R O D U C T I O N ★**

This is the second of a series of picture supply manuals. It is hoped that it will be of help to Air Service Command Supply Officers. There may be mistakes in this manual, as in all others, but these mistakes will be corrected from time to time. It is requested that any errors found, be reported to the Signal Officer, Air Service Command.

### **PURPOSE**







The purpose of this manual is to speed up the training of inexperienced supply officers and to help them become familiar with the actual VHF Ground Radio Equipment in the shortest period of time. It is impossible to picture every piece of equipment, but the most frequently used will be shown.

It is intended that experienced Air Service Command Supply Officers will also use this manual as a ready reference.

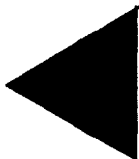
**RESTRICTED**

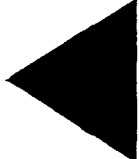
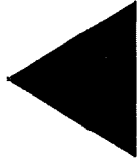
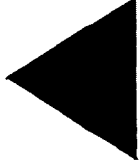

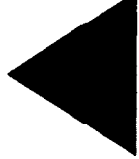
# Table of Contents

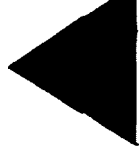
General Index.	①	
Index of Complete Radio Sets and Equipment.	②	
Alphabetical Index by Name of Item and Cross Reference Chart.	③	
Alphabetical Index by Type and Cross Reference Chart.	④	
Brief Description of SCS-2, SCS-3 and "Superman" Fighter Control Systems.	⑤	
Illustrations and Descriptions of Complete Radio Sets.	⑥	
Charts Showing Components of Complete Radio Sets.	⑦	
Illustrations and Descriptions of RC Units.	⑧	
Illustrations and Descriptions of Major Components.	⑨	
Vacuum Tubes Used in VHF Equipment.	⑩	





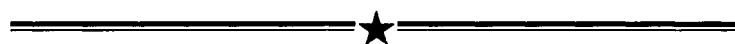
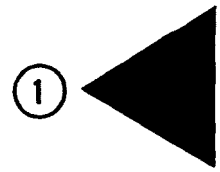

# General Index





RESTRICTED

GENERAL INDEX

ITEM	PAGE	ITEM	PAGE
Brief Description of Fighter Control Systems . . . . .	1	Amplifier BC-686 . . . . .	37
Illustration of Taking a Fix . . . . .	2	Amplifier Panel PN-8 . . . . .	37
Illustrations and Descriptions of Complete Radio Sets:		Antenna Equipment AN-94-A and Coaxial Cable WC-549 . . . . .	38
Radio Set SCR-561 . . . . .	3	Antenna Mast AN-56 . . . . .	38
Radio Set SCR-562 . . . . .	4	Antenna Mast AN-57 . . . . .	39
Radio Set SCR-563 . . . . .	5	Antenna Mast MA-7-A . . . . .	40
Radio Set SCR-564 . . . . .	6	Battery Charger and Charger Panel . . . . .	41
Radio Set SCR-565 . . . . .	7	Buzzer BZ-8 . . . . .	41
Radio Set SCR-566 . . . . .	8	Communication Panel (Receiver Station) . . . . .	42
Radio Set SCR-567 . . . . .	9	Communication Panel (Transmitter Station) . . . . .	42
Radio Set SCR-572 . . . . .	10	Control Box BC-602 . . . . .	43
Radio Set SCR-573-A . . . . .	10	Control Box BC-1176-A, BC-1171-A . . . . .	43
Radio Set SCR-573-B . . . . .	11	Control Panel PN-11 . . . . .	43
Radio Set SCR-574 . . . . .	11	Control Unit RM-18 . . . . .	44
Radio Set SCR-575 . . . . .	12	Control Unit RM-23 . . . . .	45
Radio Set SCR-624 . . . . .	13	Control Unit RM-24 . . . . .	45,46
Radio Set SCR-632 . . . . .	14	Control Unit RM-25 . . . . .	46
Radio Set SCR-633 . . . . .	14	Control Unit RM-26 . . . . .	47
Radio Set SCR-634 . . . . .	15	Control Unit RM-27 . . . . .	47,48
Radio Set SCR-637 . . . . .	16	Control Unit RM-28 . . . . .	48
Radio Set SCR-642 . . . . .	16	Control Unit RM-38 . . . . .	49
Radio Set SCR-643 . . . . .	17	Cord CC-70 . . . . .	49
Radio Set SCR-644 . . . . .	17	Cord CD-307-A . . . . .	49
Radio Set SCR-645 . . . . .	18	Crystal Unit . . . . .	50
Charts Showing Components of Complete Radio Sets . . . . .	19,20,21	Distribution Panel BD-102 . . . . .	50
Illustration of Equipment on Railroad Siding . . . . .	22	Dynamotor Unit PE-94 . . . . .	51
Illustrations and Descriptions of RC Units:		Dynamotor Unit PE-100 . . . . .	51
Radio Receiving Equipment RC-72 . . . . .	23	Frequency Meter BC-638 . . . . .	52
Radio Receiving Equipment RC-76 . . . . .	23	Fuse Panel PN-2 . . . . .	52
Radio Receiving Equipment RC-77 . . . . .	24	Fuse Panel PN-5 . . . . .	53
Radio Receiving Equipment RC-78 . . . . .	24	Fuse Panel PN-15 . . . . .	53
Radio Receiving Equipment RC-79 . . . . .	25	Handset TS-14 . . . . .	53
Monitoring Equipment RC-80 . . . . .	26	Headset HS-23 . . . . .	54
Antenna Equipment RC-81 . . . . .	27	Jack Box BC-629 and Jack Box BC-630 . . . . .	54
Antenna Equipment RC-82 . . . . .	28	Jack Box BC-631 . . . . .	54,55
Antenna Equipment RC-83 . . . . .	29	Jack Panel PN-3 . . . . .	55
Radio Receiving and Transmitting Equipment RC-84 . . . . .	30	Junction Box JB-29 . . . . .	55
Radio Receiving Equipment RC-86 . . . . .	31	Junction Box JB-45 . . . . .	56
Oscillator and Test Equipment RC-93 . . . . .	31	Microphone T-48 . . . . .	56
Control Equipment RC-113 . . . . .	32	Modulator Panel PN-10 . . . . .	57
Antenna Equipment RC-153 . . . . .	33	Oscillator Panel PN-9 . . . . .	57
Radio Receiving Equipment RC-155 . . . . .	34	Power Control Panel PN-13 . . . . .	58
Radio Receiving and Transmitting Equipment RC-165 . . . . .	34	Power Supply Panel PN-12 . . . . .	58
Radio Receiving Equipment RC-168 . . . . .	34	Power Unit PE-75-D . . . . .	59
Antenna Equipment RC-213 . . . . .	35	Power Unit PE-99 . . . . .	60
Radio Receiving Equipment RC-229 . . . . .	35	Radio Receiver BC-624 and Radio Transmitter BC-625 . . . . .	61
Illustration of Ground to Plane Communication . . . . .	36	Radio Receiver BC-639 . . . . .	62
Illustrations and Descriptions of Major Components:		Radio Transmitter BC-640 . . . . .	62,63
		Rectifier RA-42 . . . . .	63
		Rectifier RA-62 . . . . .	64
		Reel DR-5 With Wire W-110-B . . . . .	64
		Relay Unit BC-685 . . . . .	65
		Relay Unit BC-687 . . . . .	65
		Shelter HO-3 . . . . .	66
		Shelter HO-34 . . . . .	66
		Socket Panel PN-4 . . . . .	67
		Switching Panel PN-6 . . . . .	67

RESTRICTED

GENERAL INDEX (CONTINUED)

ITEM	PAGE	ITEM	PAGE
Target Transmitter BC-655 . . . . .	. 68	Trailer K-35 . . . . .	.70
Telegraph Key J-44 . . . . .	. 68	Trailer K-63 . . . . .	.71
Telephone EE-8-A . . . . .	. 68	Truck K-53 . . . . .	.71
Telephone Repeater . . . . .	. 69	Volt Ohmyst Jr. . . . .	.72
Telephone Switchboard BD-72-A . . . . .	. 69	Equipment and Vacuum Tube Complements .	.73
Tester 504-A . . . . .	. 69	Vacuum Tubes Used in VHF Equipment . . .	.74
Tower TR-17 . . . . .	. 70		

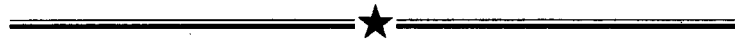

**Index To Complete Radio Sets  
and Equipment**

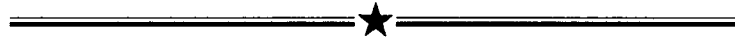



RESTRICTED

INDEX OF COMPLETE RADIO SETS AND EQUIPMENT

	PAGE
KE-2	Receiving Equipment (SCR-563). . . . . 5
KE-3	Mobile Homing and Direction Finding Equipment (SCR-566) . 8
KE-4	Transmitting Equipment (SCR-567). . . . . 9
KE-5	Receiving Equipment (SCR-567). . . . . 9
RC-72	Radio Receiving Equipment . . . . . 23
RC-76	Radio Receiving Equipment . . . . . 23
RC-77	Radio Receiving Equipment . . . . . 24
RC-78	Radio Receiving Equipment . . . . . 24
RC-79	Radio Receiving Equipment . . . . . 25
RC-80	Monitoring Equipment . . . . . 26
RC-81	Antenna Equipment . . . . . 27
RC-82	Antenna Equipment . . . . . 28
RC-83	Antenna Equipment . . . . . 29
RC-84	Radio Receiving and Transmitting Equipment . . . . 30
RC-86	Radio Receiving Equipment . . . . . 31
RC-93	Oscillator and Test Equipment . . . . . 31
RC-113	Control Equipment . . . . . 32
RC-153	Antenna Equipment . . . . . 33
RC-155	Radio Receiving Equipment . . . . . 34
RC-165	Radio Receiving and Transmitting Equipment . . . . 34
RC-168	Radio Receiving Equipment . . . . . 34
RC-213	Antenna Equipment . . . . . 35
RC-229	Radio Receiving Equipment . . . . . 35
SCR-561	Operations Block . . . . . 3
SCR-562	Transmitting Station. . . . . 4
SCR-563	Receiving Station . . . . . 5
SCR-564	Homing Station . . . . . 6
SCR-565	D/F Fixer Station . . . . . 7
SCR-566	Mobile D/F Station . . . . . 8
SCR-567	Forward Relay Station . . . . . 9
SCR-572	Control Set (Mobile). . . . . 10
SCR-573-A	Transmitter Station (Mobile) . . . . . 10
SCR-573-B	Transmitter Station (Mobile) Modified . . . . . 11
SCR-574	Receiver Station (Mobile) . . . . . 11
SCR-575	Direction Finding Station (Mobile) . . . . . 12
SCR-624	Air Transportable Radio Transmitting and Receiving Station. 13
SCR-632	Local Transmitter Station (Fixed) . . . . . 14
SCR-633	Local Receiver Station (Fixed) . . . . . 14
SCR-634	Air Transportable Direction Finding Station . . . . 15
SCR-637	Relay Transmitter and Receiver Station (Fixed) . . . 16
SCR-642	Operations Block (Fixed) . . . . . 16
SCR-643	Transmitter Station (Fixed) . . . . . 17
SCR-644	Receiving Station (Fixed) . . . . . 17
SCR-645	D/F Homer and Fixer Station (Fixed) . . . . . 18







**Alphabetical Index By Name of Item  
and Cross Reference Chart**





RESTRICTED

ALPHABETICAL INDEX BY NAME OF ITEM AND CROSS REFERENCE CHART

NAME	TYPE	PART OF FOLLOWING RADIO SETS	PAGE
AF Oscillator		561, 572, 642 . . . . .	* .
Amplifier	BC-686	567, 574, 637, 644 . . . . .	. 37
Amplifier Panel	PN-8	562, 567, 573, 632, 637, 643 . . . . .	. 37
Antenna Equipment	AN-94	624 . . . . .	. 38
Antenna Equipment	RC-81	562, 563, 567, 573, 574, 632, 633, 637, 643, 644 . . . . .	. 27
Antenna Equipment	RC-82	564, 565 . . . . .	. 28
Antenna Equipment	RC-83	566 . . . . .	. 29
Antenna Equipment	RC-153	575, 634 . . . . .	. 33
Antenna Equipment	RC-213	645 . . . . .	. 35
Antenna Mast	AN-56	562, 563, 632, 633, 643, 644 . . . . .	. 38
Antenna Mast	AN-57	567, 637 . . . . .	. 39
Antenna Mast	AN-86	573, 574 . . . . .	* .
Antenna Mast	AN-96	Substitute . . . . .	* .
Antenna Mast	MA-7-A	624 . . . . .	. 40
Ballantine Voltmeter #300		561, 572, 642 . . . . .	* .
Battery Charger, General Electric Model 6RB33B1		561, 565, 566, 567, 572, 573, 637, 642, 644, 645 . . . . .	. 41
Battery, 6 Volt		565, 566, 575, 645 . . . . .	* .
Battery, 12 Volt		561, 565, 567, 572, 574, 575, 637, 642 644, 645 . . . . .	* .
Buzzer	BZ-8	561, 562, 563, 565, 632, 573, 643 . . . . .	. 41
Cabinet	BE-78-A	561 . . . . .	. 50
Cable, Coaxial	WC-549	624 . . . . .	. 38
Cable, (40-Pr.)	WC-505	561, 572, 642 . . . . .	* .
Case	CS-80	566, 575, 624, 645 . . . . .	. 61
Charger Panel		561, 565, 566, 567, 572, 574, 575, 637, 642, 645 . . . . .	. 41
Chest	CH-170	624 . . . . .	. 38
Chest	CH-172	624 . . . . .	. 64
Chest	CH-173	624 . . . . .	. 13
Control Box	BC-602	566, 575, 624, 645 . . . . .	. 43
Control Box	BC-1171	624 . . . . .	. 43
Control Box	BC-1176	624 . . . . .	. 43
Control Equipment	RC-113	572, 642 . . . . .	. 32
Control Panel	PN-11	562, 567, 573, 632, 637, 643 . . . . .	. 63
Control Panel	PN-25	575, 645 . . . . .	* .
Control Unit	RM-18	566, 567, 574, 575, 637, 644, 645 . . . . .	. 44
Control Unit	RM-23	563, 633, 644 . . . . .	. 45
Control Unit	RM-24	564 . . . . .	. 45,46
Control Unit	RM-25	561, 572, 642 . . . . .	. 46
Control Unit	RM-26	561, 572, 642 . . . . .	. 47
Control Unit	RM-27	562, 573, 643 . . . . .	. 47,48
Control Unit	RM-28	561, 572, 642 . . . . .	. 48
Control Unit	RM-38	634 . . . . .	. 35,49
Cord, Patching	CC-70	561, 562, 563, 572, 573, 632, 633, 642, 643, 644 . . . . .	. 49
Cord	CC-348	561, 562, 563, 564, 567, 572, 573, 574, 575, 632, 633, 637, 642, 643, 644, 645 . . . . .	. 53
Cord, Extension	CD-307	561, 562, 563, 564, 565, 566, 567, 572, 573, 574, 575, 632, 633, 634, 637, 642, 643, 644, 645 . . . . .	. 49
Cord	CD-588	561, 562, 563, 564, 566, 567, 572, 573, 574, 575, 632, 633, 637, 642, 643, 644, 645 . . . . .	. 56
Cord	CD-809	624 . . . . .	. 13

\* Material not available at time of printing.

RESTRICTED

ALPHABETICAL INDEX BY NAME OF ITEM AND CROSS REFERENCE CHART

NAME	TYPE	PART OF FOLLOWING RADIO SETS	PAGE
Cord	CD-810	624 . . . . .	* .
Cord	CD-815	624 . . . . .	. 13
Crystals, Sets	DC-11	562, 563, 564, 565, 566, 567, 573, 574, 575, 624, 632, 633, 634, 637, 643, 644, 645 . . . . .	. 50
Desk Unit	PN-1	562, 563, 564, 565, 566, 567, 573, 574, 575, 632, 633, 637, 643, 644, 645 . . . . .	* .
Distribution Panel	BD-102	561 . . . . .	. 50
Dynamotor Unit	PE-94	566, 575, 645 . . . . .	. 51
Dynamotor Unit	PE-100	566, 567, 575, 645 . . . . .	. 51
Extension Cord	CD-307	561, 562, 563, 564, 565, 566, 567, 572, 573, 574, 575, 632, 633, 634, 637, 642, 643, 644, 645 . . . . .	. 49
Frame	FM-39	562, 563, 564, 565, 566, 567, 572, 573, 574, 575, 632, 633, 637, 642, 643, 644, 645 . . . . .	* .
Frame	FM-40	561, 572, 642 . . . . .	* .
Frequency Meter	BC-638	563, 564, 565, 567, 574, 575, 633, 637, 644, 645 . . . . .	. 52
Fuse Panel	PN-2	561, 572, 642 . . . . .	. 52
Fuse Panel	PN-5	566, 567, 574, 575, 637, 644, 645 . . . . .	. 53
Fuse Panel	PN-15	563, 564, 565, 567, 574, 575, 633, 637, 644, 645 . . . . .	. 53
Handset	TS-14	561, 562, 563, 564, 567, 572, 573, 574, 575, 632, 633, 637, 642, 643, 644, 645 . . . . .	. 37,53
Head and Chest Set	HS-19	572, 642 . . . . .	* .
Head Set	HS-23	561, 562, 563, 564, 565, 566, 567, 572, 573, 574, 575, 632, 633, 634, 637, 642, 643, 644, 645 . . . . .	. 54
Jack Box	BC-629	566, 575, 624, 645 . . . . .	. 54
Jack Box	BC-630	566, 575, 624, 645 . . . . .	. 54
Jack Box	BC-631	566, 575, 624, 645 . . . . .	. 54,55
Jack Panel	PN-3	561, 572, 642 . . . . .	. 55
Junction Box	JB-29	566, 575, 645 . . . . .	. 55
Junction Box	JB-45	566, 575, 645 . . . . .	. 35,56
Key	J-44	574, 575, 644, 645 . . . . .	. 68
Mast, Antenna	AN-56	562, 563, 632, 633, 643, 644 . . . . .	. 38
Mast, Antenna	AN-57	567, 637 . . . . .	. 39
Mast, Antenna	AN-86	573, 574 . . . . .	* .
Mast, Antenna	AN-96	Substitute . . . . .	* .
Mast, Antenna	MA-7-A	624 . . . . .	. 40
Microphone	T-48	561, 562, 563, 564, 566, 567, 572, 573, 574, 575, 632, 633, 637, 642, 643, 644, 645 . . . . .	. 56
Modulator Panel	PN-10	562, 567, 573, 632, 637, 643 . . . . .	. 57
Monitoring Equipment	RC-80	562, 573, 632, 643 . . . . .	. 26
Oscillator, A-F		561, 572, 642 . . . . .	* .
Oscillator Panel	PN-9	562, 567, 573, 632, 637, 643 . . . . .	. 57
Oscillator Test Set	RC-93	564, 565, 566, 575, 645 . . . . .	. 31
Oscilloscope	RCA-155-A	561, 562, 567, 572, 573, 632, 637, 642, 643 . . . . .	* .
Patching Cord	CC-70	561, 562, 563, 572, 573, 632, 633, 642, 643, 644 . . . . .	. 49
Plug	PL-68	. . . . .	. 56
Plug	PL-198	. . . . .	. 46,47
Plug	PL-204	. . . . .	. 53

\* Material not available at time of printing.

RESTRICTED

ALPHABETICAL INDEX BY NAME OF ITEM AND CROSS REFERENCE

NAME	TYPE	PART OF FOLLOWING RADIO SETS	PAGE
Power Control Panel	PN-13	562, 567, 573, 632, 637, 643 . . . . .	.58
Power Supply Panel	PN-12	562, 567, 573, 632, 637, 643 . . . . .	.58
Power Trailer	K-63	562, 563, 566, 567, 573, 574, 575. . . . .	.71
Power Unit	PE-75-D	562, 563, 566, 567, 573, 574, 575. . . . .	.59
Power Unit	PE-99	561, 564, 565, 632, 633, 637, 642, 643, 644, 645 . . . . .	60,71
Power Unit	PE-214	634 . . . . .	*
Radio Control Unit	BC-602	566, 575, 645 . . . . .	.43
Radio Receiver	BC-624	566, 575, 624, 645 . . . . .	.61
Radio Receiver	BC-639	563, 564, 565, 566, 567, 574, 575, 633, 634, 637, 644, 645 . . . . .	35,62
Radio Receiving Equipment	RC-72	567, 574, 637, 644 . . . . .	.23
Radio Receiving Equipment	RC-76	563, 633 . . . . .	.23
Radio Receiving Equipment	RC-77	563, 633 . . . . .	.24
Radio Receiving Equipment	RC-78	564 . . . . .	.24
Radio Receiving Equipment	RC-79	565, 575, 645 . . . . .	.25
Radio Receiving Equipment	RC-86	567 . . . . .	.31
Radio Receiving Equipment	RC-155	567, 574, 637 . . . . .	.34
Radio Receiving Equipment	RC-168	637, 644 . . . . .	.34
Radio Receiving Equipment	RC-229	634 . . . . .	.35
Radio Receiving and Transmitting Equipment	RC-84	566 . . . . .	.30
Radio Receiving and Transmitting Equipment	RC-165	575, 645 . . . . .	.34
Radio Transmitter	BC-625	566, 575, 624, 645 . . . . .	.61
Radio Transmitter	BC-640	562, 567, 573, 632, 637, 643 . . . . .	62,63
Radio Transmitter	BC-655	564, 565, 566, 575, 634, 645 . . . . .	.68
Rectifier	RA-42	563, 564, 565, 567, 574, 575, 633, 634, 637, 644, 645 . . . . .	35,63
Rectifier	RA-62	624 . . . . .	.64
Reel	DR-5	561, 562, 563, 567, 573, 574, 632, 633, 637, 643, 644 . . . . .	.64
Reel	DR-11	561, 562, 563, 567, 573, 574, 632, 633, 637, 643, 644 . . . . .	*
Reel Unit	RL-26-A	561, 562, 563, 567, 573, 574, 632, 633, 637, 643, 644 . . . . .	.64
Relay Unit	BC-685	567, 574, 637, 644 . . . . .	.65
Relay Unit	BC-687	561, 572, 575, 642, 645 . . . . .	.65
Repeater, Telephone	EE-99	561, 572, 642 . . . . .	.69
Shelter	HO-3	561, 564, 565, 632, 633, 637, 642, 643, 644, 645 . . . . .	.66
Shelter	HO-34	634 . . . . .	.66
Signal Generator, 18-D		561, 572, 642 . . . . .	*
Signal Generator, 22-A		561, 572, 642 . . . . .	*
Socket Panel	PN-4	563, 564, 633 . . . . .	.67
Supreme Tester		561, 563, 567, 572, 575, 633, 637, 642, 644, 645 . . . . .	.69
Switchboard	BD-72	572, 642 . . . . .	.69
Switching Panel	PN-6	565, 575, 645 . . . . .	.67
Telephone	EE-8	561, 562, 563, 564, 565, 566, 567, 572, 573, 574, 575, 624, 632, 633, 637, 642 643, 644, 645 . . . . .	13,68
Telephone Frame	FM-40	561, 572, 642 . . . . .	*
Telephone Repeater	EE-99	561, 572, 642 . . . . .	.69
Tester, Supreme		561, 563, 567, 572, 574, 575, 633, 637, 642, 644, 645 . . . . .	.69

\* Material not available at time of printing.

**RESTRICTED**

**ALPHABETICAL INDEX BY NAME OF ITEM AND CROSS REFERENCE CHART**

NAME	TYPE	PART OF FOLLOWING RADIO SETS	PAGE
Test Set, I-139		575, 645 . . . . .	.*
Tower	TR-17	564, 565, 645 . . . . .	.70
Trailer	K-35	562, 563 . . . . .	.70
Trailer	K-55	572 . . . . .	.*
Trailer	K-63	562, 563, 566, 567, 573, 574, 575. . . . .	.71
Truck	K-53	566, 567, 573, 574, 575 . . . . .	.71
Voltmeter, (Ballantine) #300		561, 572, 642 . . . . .	.*
Volt-Ohmyst		561, 562, 567, 572, 573, 574, 575, 632, 637, 642, 643, 644, 645 . . . . .	.72
Wire	W-110-B	561, 562, 563, 567, 573, 574, 632, 633, 637, 643, 644 . . . . .	.64

\* Material not available at time of printing.



**Alphabetical Index By Type and  
Cross Reference Chart**







RESTRICTED

ALPHABETICAL INDEX BY TYPE AND CROSS REFERENCE CHART

TYPE		PART OF FOLLOWING RADIO SETS	PAGE
AN-56	Antenna Mast	562, 563, 632, 633, 643, 644 . . . . .	38
AN-57	Antenna Mast	567, 637 . . . . .	39
AN-86	Antenna Mast	573, 574 . . . . .	*
AN-94	Antenna Equipment	624 . . . . .	38
AN-96	Antenna Mast	Substitute . . . . .	*
BC-602	Control Box	566, 575, 624, 645 . . . . .	43
BC-624	Radio Receiver	566, 575, 624, 645 . . . . .	61
BC-625	Radio Transmitter	566, 575, 624, 645 . . . . .	61
BC-629	Jack Box	566, 575, 624, 645 . . . . .	54
BC-630	Jack Box	566, 575, 624, 645 . . . . .	54
BC-631	Jack Box	566, 575, 624, 645 . . . . .	54,55
BC-638	Frequency Meter	563, 564, 565, 567, 574, 575, 633, 637, 644, 645 . . . . .	52
BC-639	Radio Receiver	563, 564, 565, 566, 567, 574, 575, 633, 634, 637, 644, 645 . . . . .	35,62
BC-640	Radio Transmitter	562, 567, 573, 632, 637, 643 . . . . .	62,63
BC-655	Radio Transmitter	564, 565, 566, 575, 634, 645 . . . . .	68
BC-685	Relay Unit	567, 574, 637, 644 . . . . .	65
BC-686	Amplifier	567, 574, 637, 644 . . . . .	37
BC-687	Relay Unit	561, 572, 575, 642, 645 . . . . .	65
BC-1171	Control Box	624 . . . . .	43
BC-1176	Control Box	624 . . . . .	43
BD-72	Switchboard	572, 642 . . . . .	69
BD-102	Distribution Panel	561 . . . . .	50
BE-78-A	Cabinet	561 . . . . .	50
BZ-8	Buzzer	561, 562, 563, 565, 632, 573, 643 . . . . .	41
CC-70	Cord, Patching	561, 562, 563, 572, 573, 632, 633, 642, 643, 644 . . . . .	49
CC-348	Cord	561, 562, 563, 564, 567, 572, 573, 574, 575, 632, 633, 637, 642, 643, 644, 645 . . . . .	53
CD-307	Cord, Extension	561, 562, 563, 564, 565, 566, 567, 572, 573, 574, 575, 632, 633, 634, 637, 642, 643, 644, 645 . . . . .	49
CD-588	Cord	561, 562, 563, 564, 566, 567, 572, 573, 574, 575, 632, 633, 637, 642, 643, 644, 645 . . . . .	56
CD-809	Cord	624 . . . . .	13
CD-810	Cord	624 . . . . .	*
CD-815	Cord	624 . . . . .	13
CH-170	Chest	624 . . . . .	38
CH-172	Chest	624 . . . . .	64
CH-173	Chest	624 . . . . .	13
CS-80	Case	566, 575, 624, 645 . . . . .	61
DC-11	Crystals, Sets	562, 563, 564, 565, 566, 567, 573, 574, 575, 624, 632, 633, 634, 637, 643, 644 645 . . . . .	50
DR-5	Reel	561, 562, 563, 567, 573, 574, 632, 633 637, 643, 644 . . . . .	64
DR-11	Reel	561, 562, 563, 567, 573, 574, 632, 633 637, 643, 644 . . . . .	*
EE-8	Telephone	561, 562, 563, 564, 565, 566, 567, 572, 573, 574, 575, 624, 632, 633, 637, 642, 643, 644, 645 . . . . .	13,68
EE-99	Telephone Repeater	561, 572, 642 . . . . .	69
FM-39	Frame	562, 563, 564, 565, 566, 567, 572, 573, 574, 575, 632, 633, 637, 642, 643, 644, 645 . . . . .	*

\* Material not available at time of printing.

RESTRICTED

ALPHABETICAL INDEX BY TYPE AND CROSS REFERENCE CHART

TYPE		PART OF FOLLOWING RADIO SETS	PAGE
FM-40	Frame, Telephone	561, 572, 642.	* .
HO-3	Shelter	561, 564, 565, 632, 633, 637, 642, 643, 644, 645 . . . . .	. 66
HO-34	Shelter	634 . . . . .	. 66
HS-19	Head and Chest Set	572, 642 . . . . .	* .
HS-23	Head Set	561, 562, 563, 564, 565, 566, 567, 572, 573, 574, 575, 632, 633, 634, 637, 642, 643, 644, 645. . . . .	. 54
I-139	Test Set	575, 645 . . . . .	* .
J-44	Key	574, 575, 644, 645 . . . . .	. 68
JB-29	Junction Box	566, 575, 645. . . . .	. 55
JB-45	Junction Box	566, 575, 645. . . . .	. 35,56
K-35	Trailer	562, 563 . . . . .	. 70
K-53	Truck	566, 567, 573, 574, 575 . . . . .	. 71
K-55	Trailer	572 . . . . .	* .
K-63	Trailer (Power)	562, 563, 566, 567, 573, 574, 575 . . . . .	. 71
MA-7-A	Antenna Mast	624 . . . . .	. 40
PE-75-D	Power Unit	562, 563, 566, 567, 573, 574, 575 . . . . .	. 59
PE-94	Dynamotor Unit	566, 575, 645 . . . . .	. 51
PE-99	Power Unit	561, 564, 565, 632, 633, 637, 642, 643, 644, 645 . . . . .	. 60,71
PE-100	Dynamotor Unit	566, 567, 575, 645 . . . . .	. 51
PE-214	Power Unit	634 . . . . .	* .
PL-68	Plug	. . . . .	. 56
PL-198	Plug	. . . . .	. 46,47
PL-204	Plug	. . . . .	. 53
PN-1	Desk Unit	562, 563, 564, 565, 566, 567, 573, 574, 575, 632, 633, 637, 643, 644, 645 . . . . .	* .
PN-2	Fuse Panel	561, 572, 642. . . . .	. 52
PN-3	Jack Panel	561, 572, 642. . . . .	. 55
PN-4	Socket Panel	563, 564, 633. . . . .	. 67
PN-5	Fuse Panel	566, 567, 574, 575, 637, 644, 645 . . . . .	. 53
PN-6	Switching Panel	565, 575, 645. . . . .	. 67
PN-8	Amplifier Panel	562, 567, 573, 632, 637, 643 . . . . .	. 37
PN-9	Oscillator Panel	562, 567, 573, 632, 637, 643 . . . . .	. 57
PN-10	Modulator Panel	562, 567, 573, 632, 637, 643 . . . . .	. 57
PN-11	Control Panel	562, 567, 573, 632, 637, 643 . . . . .	. 63
PN-12	Power Supply Panel	562, 567, 573, 632, 637, 643 . . . . .	. 58
PN-13	Power Control Panel	562, 567, 573, 632, 637, 643 . . . . .	. 58
PN-15	Fuse Panel	563, 564, 565, 567, 574, 575, 633, 637, 644, 645 . . . . .	. 53
PN-25	Control Panel	575, 645 . . . . .	* .
RA-42	Rectifier	563, 564, 565, 567, 574, 575, 633, 634, 637, 644, 645 . . . . .	. 35,63
RA-62	Rectifier	624 . . . . .	. 64
RC-72	Radio Receiving Equipment	567, 574, 637, 644 . . . . .	. 23
RC-76	Radio Receiving Equipment	563, 633 . . . . .	. 23
RC-77	Radio Receiving Equipment	563, 633 . . . . .	. 24
RC-78	Radio Receiving Equipment	564 . . . . .	. 24
RC-79	Radio Receiving Equipment	565, 575, 645 . . . . .	. 25
RC-80	Monitoring Equipment	562, 573, 632, 643 . . . . .	. 26
RC-81	Antenna Equipment	562, 563, 567, 573, 574, 632, 633, 637, 643, 644 . . . . .	. 27
RC-82	Antenna Equipment	564, 565 . . . . .	. 28
RC-83	Antenna Equipment	566 . . . . .	. 29
RC-84	Radio Receiving and Transmitting Equipment	566 . . . . .	. 30

\* Material not available at time of printing.

RESTRICTED

ALPHABETICAL INDEX BY TYPE AND CROSS REFERENCE CHART

TYPE		PART OF FOLLOWING RADIO SETS	PAGE
RC-86	Radio Receiving Equipment	567 . . . . .	. 31
RC-93	Oscillator Test Set	564, 565, 566, 575, 645 . . . . .	. 31
RC-113	Control Equipment	572, 642 . . . . .	. 32
RC-153	Antenna Equipment	575, 634 . . . . .	. 33
RC-155	Radio Receiving Equipment	567, 574, 637 . . . . .	. 34
RC-165	Radio Receiving and Transmitting Equipment	575, 645 . . . . .	. 34
RC-168	Radio Receiving Equipment	637, 644 . . . . .	. 34
RC-213	Antenna Equipment	645 . . . . .	. 35
RC-229	Radio Receiving Equipment	634 . . . . .	. 35
RL-26-A	Reel Unit	561, 562, 563, 567, 573, 574, 632, 633, 637, 643, 644 . . . . .	. 64
RM-18	Control Unit	566, 567, 574, 575, 637, 644, 645. . . . .	. 44
RM-23	Control Unit	563, 633, 644 . . . . .	. 45
RM-24	Control Unit	564 . . . . .	45,46
RM-25	Control Unit	561, 572, 642 . . . . .	. 46
RM-26	Control Unit	561, 572, 642 . . . . .	. 47
RM-27	Control Unit	562, 573, 643 . . . . .	47,48
RM-28	Control Unit	561, 572, 642 . . . . .	. 48
RM-38	Control Unit	634 . . . . .	. 35,49
T-48	Microphone	561, 562, 563, 564, 566, 567, 572, 573, 574, 575, 632, 633, 637, 642, 643, 644, 645 . . . . .	. 56
TR-17	Tower	564, 565, 645 . . . . .	. 70
TS-14	Handset	561, 562, 563, 564, 567, 572, 573, 574, 575, 632, 633, 637, 642, 643, 644, 645 . . . . .	. 37,53
WC-505	Cable (40-Pr.)	561, 572, 642 . . . . .	*
WC-549	Coaxial Cable	624 . . . . .	. 38

\* Material not available at time of printing.





**Brief Description  
Of SCS-2, SCS-3 and "Superman"  
Fighter Control Systems**





RESTRICTED

**BRIEF DESCRIPTION OF SCS-2, SCS-3, AND  
"SUPERMAN" FIGHTER CONTROL NET SYSTEMS**

The radio art has made rapid progress during the last few years, moving up to higher and higher frequencies. VHF is a British terminology for very high frequency, corresponding to what is more familiarly known as ultra high frequency (UHF) in America. The frequency range of VHF equipment is from 99 to 156 megacycles.

Pilots accustomed to the noise and static in the high frequency (HF) systems still being used in the armed forces, both here and in England, often say of this very high frequency (VHF) equipment, "it's as good as a public telephone."

There are, generally speaking, three VHF systems used for control of tactical aircraft:

- a. SCS-2 System
- b. SCS-3 System
- c. "Superman" System

CONTROL NET SYSTEM SCS-2 (semi-fixed communications equipment for ground control of interceptor pursuit operations) consists of a control center (SCR-561), a radio transmitting station (SCR-562), a radio receiving station (SCR-563), a homing direction finding station (SCR-564), three fixed direction finding stations (SCR-565), a mobile homing and direction finding station (SCR-566), and a mobile relay transmitting and receiving station (SCR-567). This equipment is designed to facilitate control of a number of squadrons of aircraft. The radio transmitting and receiving equipment is provided for ground-to-air and air-to-ground communications, while the radio direction finding equipment is provided for the locating of friendly aircraft in flight. The entire system is con-

nected to the control center by land wire lines so that all information relative to the location of aircraft is transmitted to the controller by means of wire telephone facilities. In some cases this information is transmitted to the controller by radio when telephone communication is impracticable.

CONTROL NET SYSTEM SCS-3 is used in the same manner and for the same purposes as control net system SCS-2, but is made up of different radio sets. The equipment making up this system formerly consisted of the following mobile radio sets:

- 1 SCR-572, Control Center
- 3 SCR-573, Transmitting Station
- 3 SCR-574, Receiving Station
- 4 SCR-575, Mobile Direction Finding and Homing Station

It is anticipated that control net system SCS-3 will be composed of the following radio sets, instead of the above mentioned radio equipment:

- 1 SCR-642, Control Set (Fixed)
- 3 SCR-643, Transmitting Station (Fixed)
- 3 SCR-644, Receiving Station (Fixed)
- 4 SCR-645, Direction Finding and Homing Station (Fixed)

Control net system SCS-3 is very flexible and the above information is to be used only as a guide.

"SUPERMAN" CONTROL NET SYSTEM (mobile communications equipment for ground control of tactical aircraft), consists of a transmitting and receiving station (SCR-567 or SCR-573 and 574) and mobile direction finding and homing station (SCR-566). This equipment is designed to provide only homing facilities and air-ground, ground-air communications with tactical aircraft.

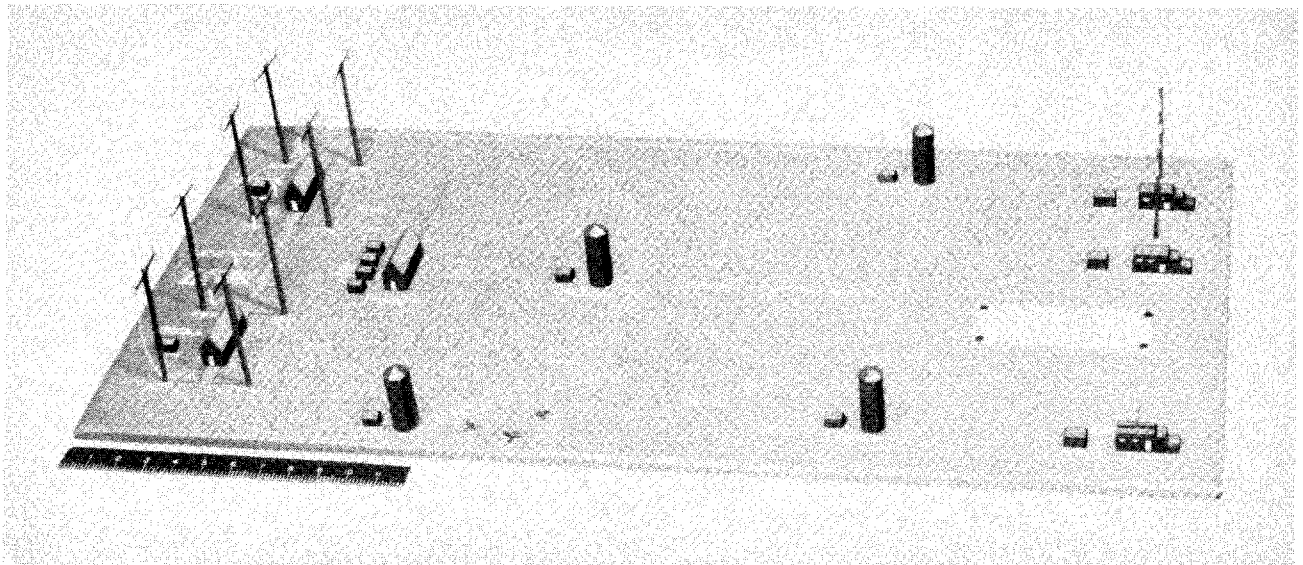
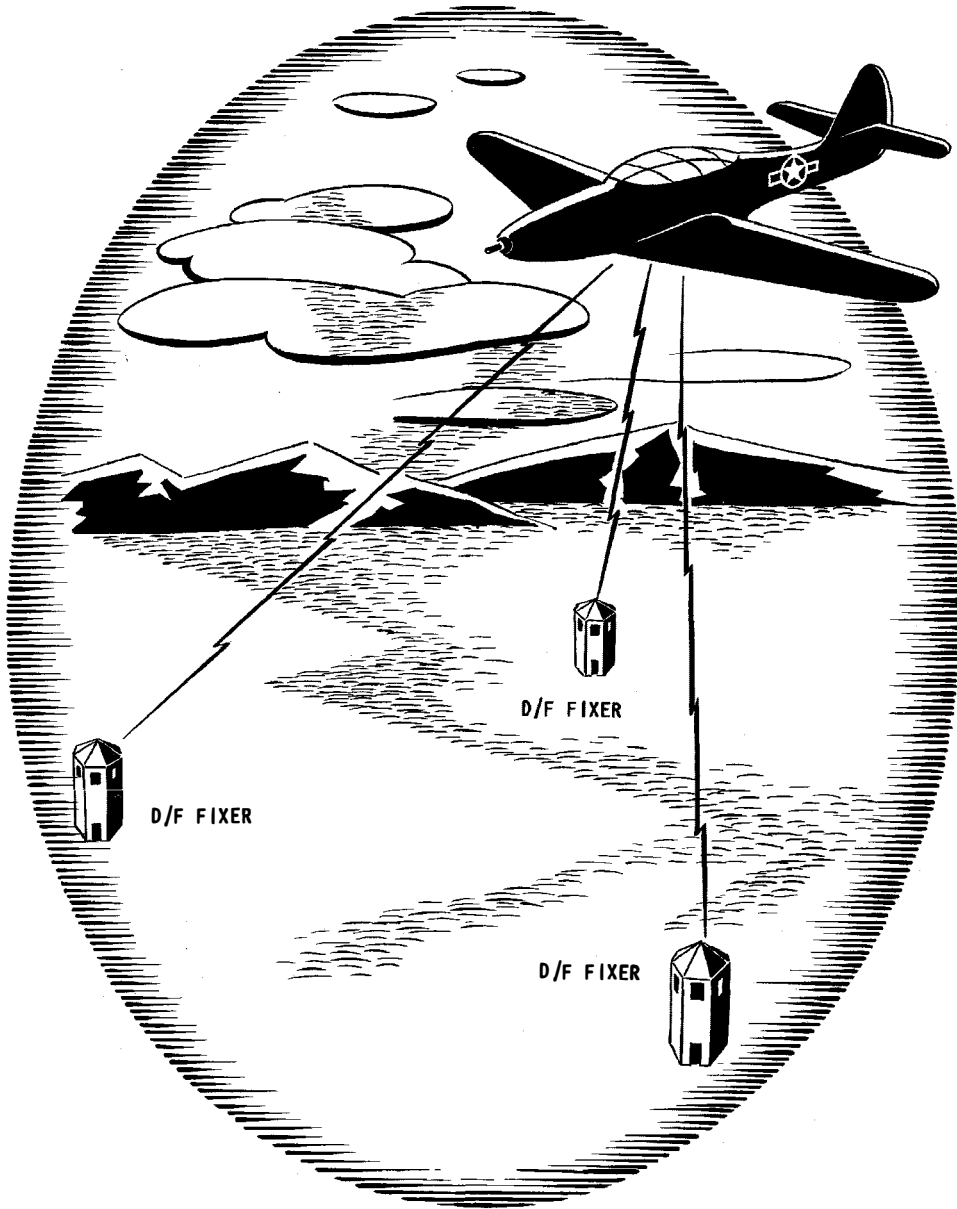

Figure 1 - Model of Typical SCS-2 Installation - Detail View of Plan

RESTRICTED



RESTRICTED





**Illustrations and Descriptions  
Of Complete Radio Sets**

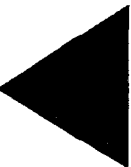



RESTRICTED

CONTROL SET SCR-561

Control set SCR-561 is a sector operations block and central controlling point for control net system SCS-2. The operations block is located near the airfield for operational convenience. This set has telephone communication with the sector transmitting station, sector receiving station, the sector direction finding homing station, direction finding fixer stations, the mobile direction finding station, and the forward relay station or stations. All normal communication with aircraft except homing direction finding work originates at the operations block SCR-561.

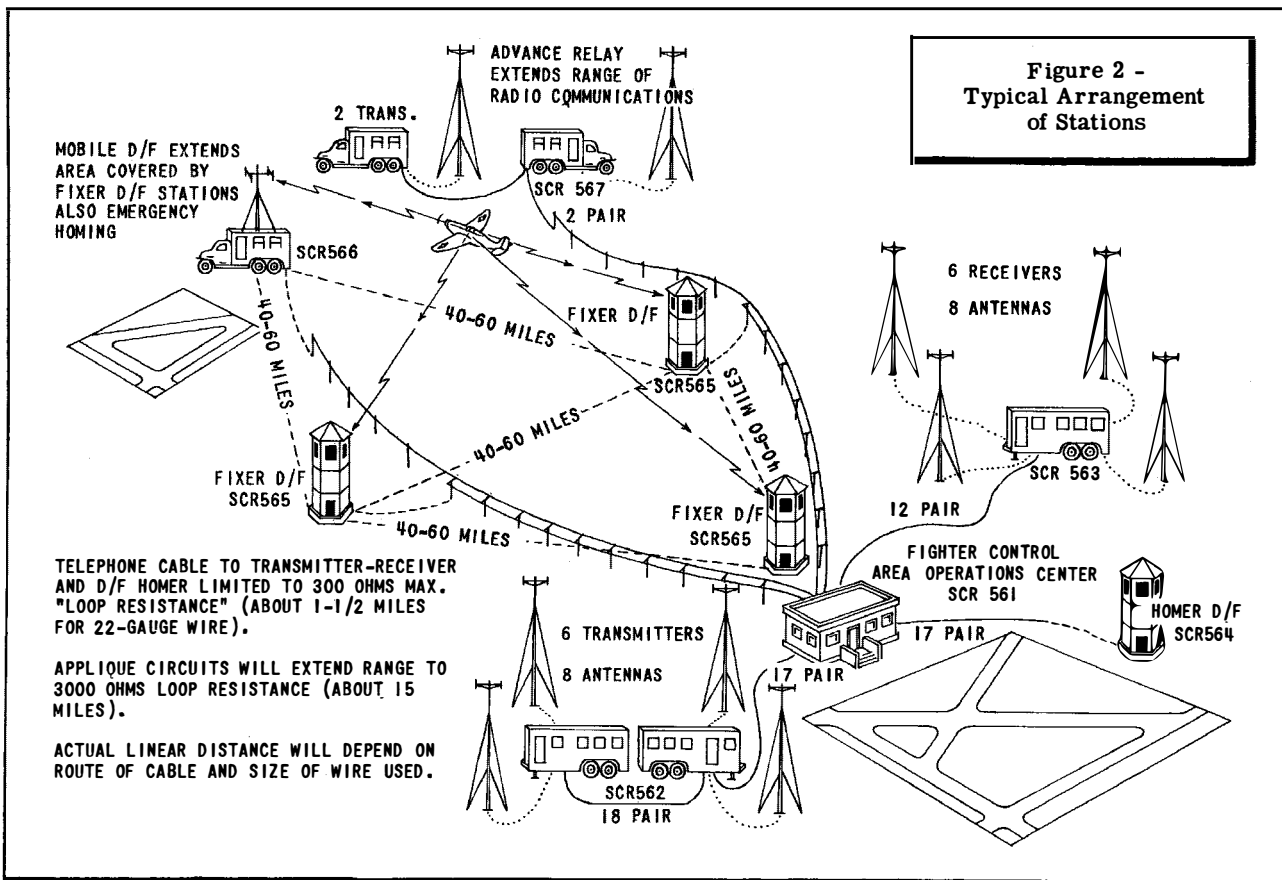

Figure 2 - Typical Arrangement of Stations

MAJOR COMPONENTS

5	RM-25	Control Unit	10	CC-70	Cord, Patching
3	RM-26	Control Unit	7	CD-307	Cord, Extension
1	RM-28	Control Unit	6	DR-11	Reel, 27 in. x 13-3/3 in.
1	PN-2	Fuse Panel	1	FM-40	Frame, Telephone
1	PN-3	Jack Panel	7	HS-19	Head and Chest Set
1	BC-687	Relay Unit	7	HS-23	Head Set
1		AF Oscillator	1	HO-3	Shelter
1		Oscilloscope	7	TS-14	Handset
1		Signal Generator, 18D (Ferris)	8	T-48	Microphone
1		Signal Generator, 22A (Ferris)	1	PE-99	Power Unit
1		Tester, Supreme, #504	6	EE-99	Telephone Repeater
1		Voltmeter, Ballentine, #300	2	EE-8	Telephone
1		Volt Ohmyst	1	TE-48	Tool Equipment
6		Battery, 12 Volt	1	TE-61	Tool Equipment
1		Charger Panel	1	WC-505	Cable, 40 Pair
1		Battery Charger, G.E. Model 6RB33B1	1000 ft	ME-51	Maintenance Equipment
			1		

RADIO SET SCR-562

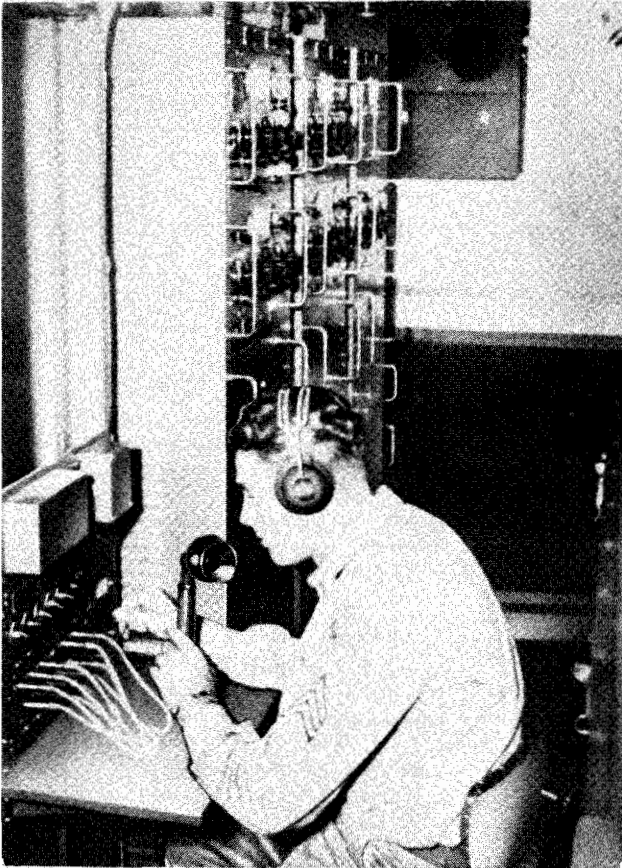

Figure 3 - Transmitter Station Operator  
At the SCR-562

Radio set SCR-562 is a main sector transmitting station (semi-fixed) usually mounted in trailer K-35. A number of these sets have been manufactured without being mounted in this trailer and are installed in any suitable building. Eight antenna equipments RC-81, mounted on four antenna masts AN-56, are used in conjunction with this radio station.

Radio set SCR-562 can be remotely operated from a nearby operating point. The station should be located far enough from the airfield so that the antenna will not interfere with operation of aircraft. The transmitting station is used for the transmission of all communications to aircraft in flight.

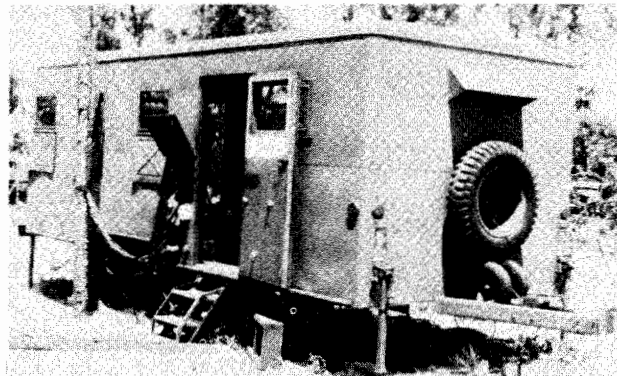

Figure 4 - Transmitter Trailer - SCR-562

MAJOR COMPONENTS

4	AN-56	Antenna Mast	8	DR-11	Reel, 27 in. x 13-3/4 in.
2	RC-80	Monitoring Equipment	2	FM-39	Frame
8	RC-81	Antenna Equipment	4	HS-23	Head Set
2	RM-27	Control Unit	4	TS-14	Handset
2	PN-1	Desk Unit	4	T-48	Microphone
6	BC-640	Radio Transmitter	2	EE-8	Telephone
2		Oscilloscope	2	ME-41	Maintenance Equipment
2		Volt Ohmyst	2	TE-48	Tool Equipment
20	CC-70	Cord, Patching	2	K-35	Trailer
4	CD-307	Cord, Extension	2	K-63	Power Trailer
4	DC-11	Crystal Sets	2	TE-62	Tool Equipment



RESTRICTED

RADIO SET SCR-563

Radio set SCR-563 is a main sector receiving station (semi-fixed) for control net system SCS-2. This station is usually mounted in trailer K-35; however, a number of these sets have been manufactured without this vehicle and may be installed in any suitable building. SCR-563 also includes antenna equipments RC-81 mounted on four antenna masts AN-56. Radio set

SCR-563 contains three frames FM-39 for the assembly of the station operating components. Two of the racks are identical and are called radio receiving equipment RC-76 which controls the complete operation of the station, a frequency meter BC-638, and a fuse panel PN-15, in addition to the equipment in racks RC-77. The receiving station contains six radio receivers BC-639, all of which are connected to the central control unit RM-23.

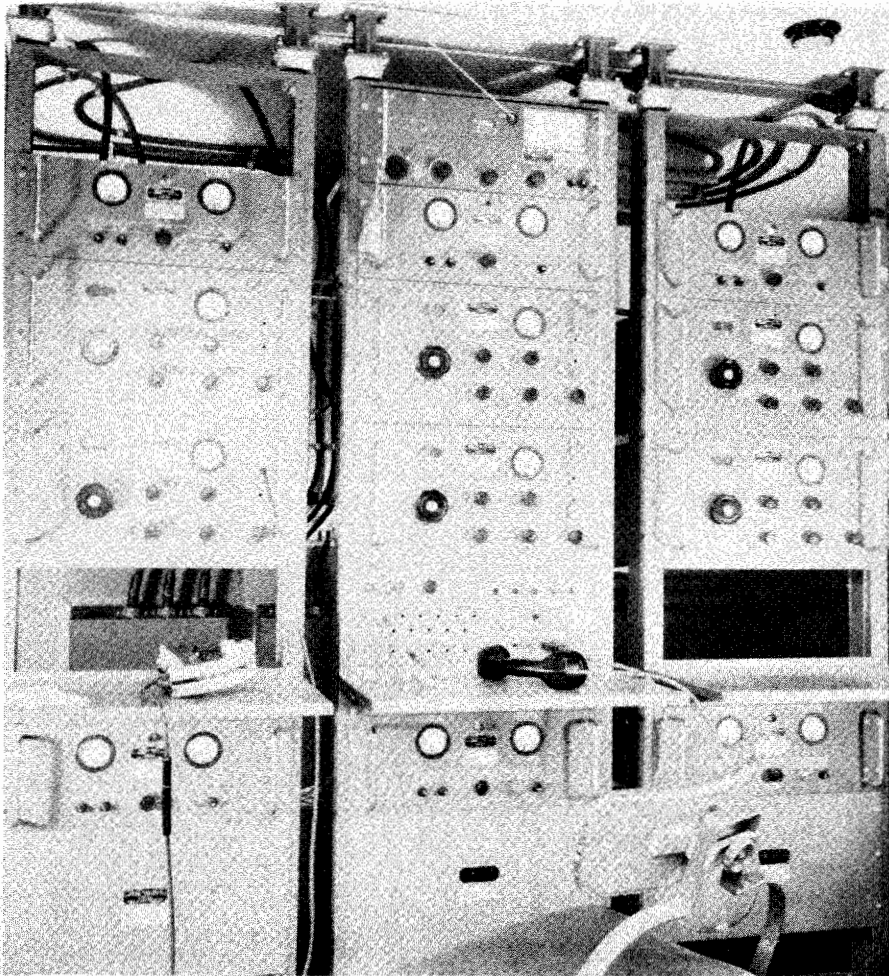

Figure 5 - Interior View of Radio Set SCR-563 (KE-2) Installed in Trailer K-35

MAJOR COMPONENTS

4	AN-56	Antenna Mast	3	CD-307	Cord, Extension
1	RC-76	Radio Receiving Equipment	2	DC-11	Crystal Sets
2	RC-77	Radio Receiving Equipment	3	FM-39	Frame
8	RC-81	Antenna Equipment	3	HS-23	Head Set
1	RM-23	Control Unit	2	TS-14	Handset
3	PN-1	Desk Unit	2	T-48	Microphone
1	PN-4	Socket Panel	1	K-35	Trailer
1	PN-15	Fuse Panel	1	K-63	Power Trailer
1	BC-638	Frequency Meter	1	EE-8	Telephone
6	BC-639	Radio Receiver	1	ME-42	Maintenance Equipment
6	RA-42	Rectifier	1	TE-48	Tool Equipment
1		Tester, Supreme, #504	1	TE-63	Tool Equipment
10	CC-70	Cord, Patching			

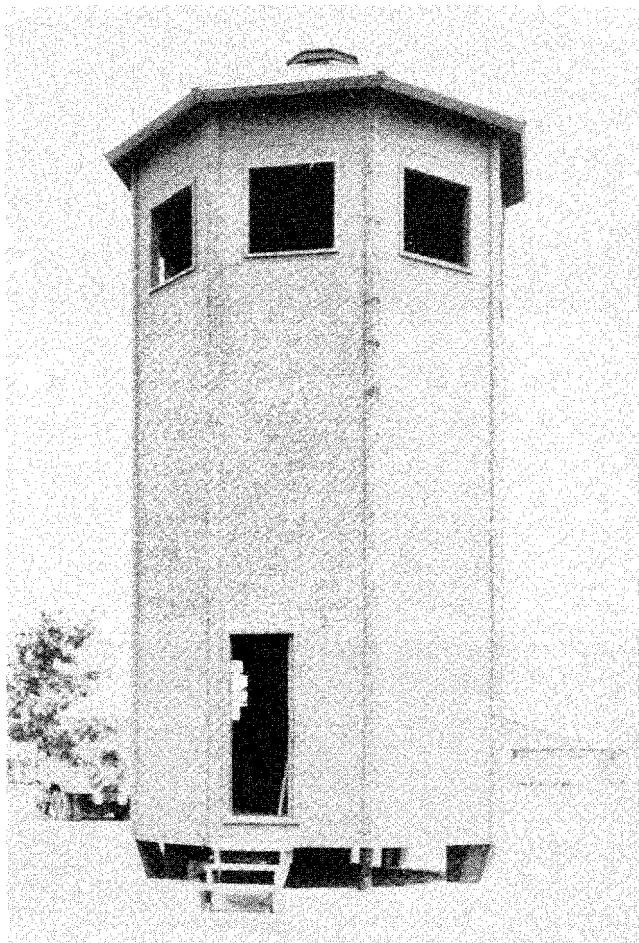

Figure 6 - Tower TR-17  
in Which SCR-564  
is Installed

**RADIO SET SCR-564**

Radio set SCR-564 is a radio direction finding station used for the homing of friendly aircraft, and provides for the following:

a. Determination of direction of the aircraft from the station.

b. Communication with the aircraft by means of a local sector transmitter which the operator of the homing station has at his disposal.

Radio set SCR-564 acts as a homing station by determining the direction of the aircraft from the station with an Adcock direction finding antenna. Thus, if the direction of the aircraft from the station is known, it is possible for the direction finding station operator to direct the pilot to the airfield. Communication with the aircraft is possible through a local sector transmitter station, which is connected by means of telephone lines to the direction finding (homer) station.

**MAJOR COMPONENTS**

1	RC-78	Radio Receiving Equipment
1	RC-82	Antenna Equipment
5	RC-93	Oscillator Test Equipment
1	RM-24	Control Unit
1	PN-1	Desk Unit
1	PN-4	Socket Panel
1	PN-15	Fuse Panel
1	BC-638	Frequency Meter
2	BC-639	Radio Receiver
2	RA-42	Rectifier
2	CD-307	Cord, Extension
2	DC-11	Crystal Sets
1	FM-39	Frame
2	HS-23	Head Sets
2	TS-14	Handset
2	T-48	Microphone
1	PE-99	Power Unit
1	EE-8	Telephone
1	ME-54	Maintenance Equipment
1	TE-74	Tool Equipment
1	TR-17	Tower

RESTRICTED

RADIO SET SCR-565

Radio set SCR-565 is a radio direction finding station for locating the position of aircraft. The operator of radio set SCR-565 takes a bearing from the radio signals of the airplane. This bearing is the direction

of the aircraft from the individual direction finding fixer station. The station operator reports the bearing on the plane. This bearing is the direction of the aircraft from the individual direction finding fixer station. The station operator reports the bearing taken to the operations block by wire telephone.

MAJOR COMPONENTS

1	RC-79	Radio Receiving Equipment	2	DC-11	Crystal Set
1	RC-82	Antenna Equipment	1	FM-39	Frame
1	RC-93	Oscillator Test Equipment	2	HS-23	Head Set
1	PN-1	Desk Panel	1	PE-99	Power Unit
1	PN-6	Switching Panel	1	PE-100	Dynamotor Unit
1	PN-15	Fuse Panel	1	EE-8	Telephone
1	BC-638	Frequency Meter	1	ME-55	Maintenance Equipment
2	BC-639	Radio Receiver	1	TE-65	Tool Equipment
2	RA-42	Rectifier	1	TR-17	Tower
1		Battery Charger, G.E. Model 6RB33B1	2		Battery, 6 Volt
2	CD-307	Cord, Extension	1		Charger Panel

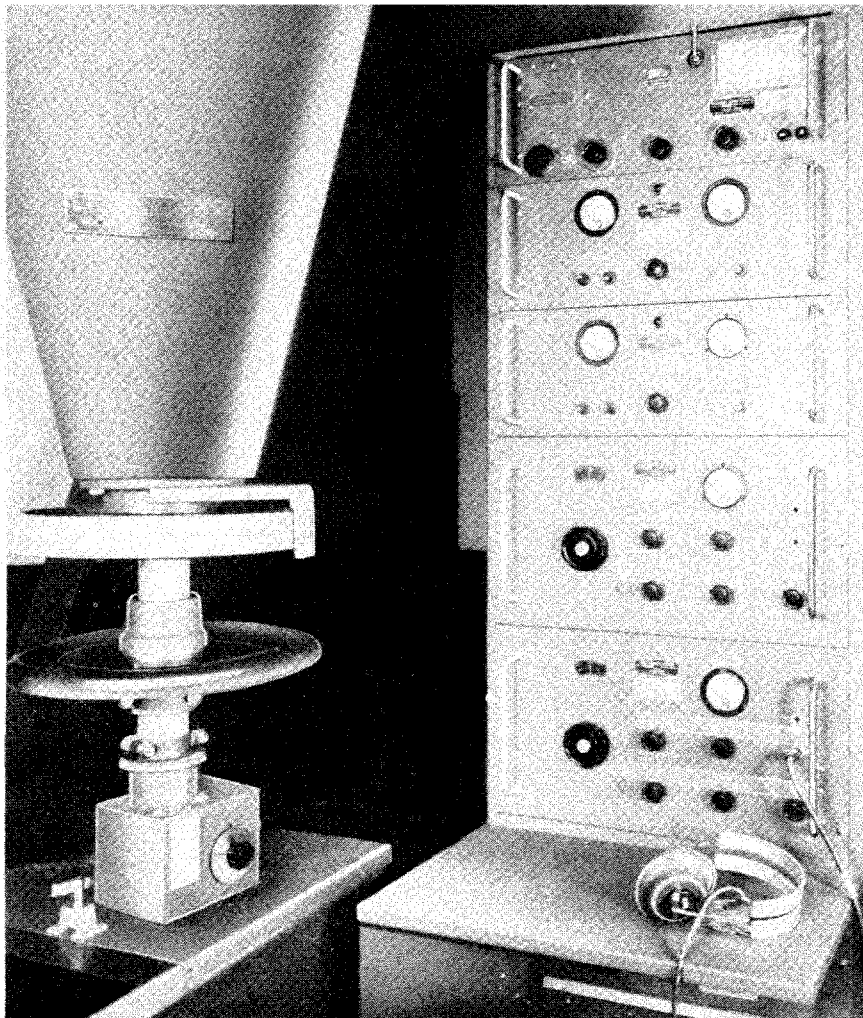

Figure 7 -  
Radio Set  
SCR-565 -  
Operator's  
Position

RESTRICTED

RADIO SET SCR-566

Radio set SCR-566 is a portable direction finding station used to extend the range of the DF (direction finding) system, or in emergencies, to perform the operations of the homer DF (direction finding) station or to replace one of the fixer DF (direction finding) stations. It may also be used as a homing station at a separate airfield. The mobile DF (direction finding) station has all major components mounted on a truck K-53. The station also consists of a gasoline-driven a-c power unit, PE-99 mounted on a two-wheel trailer which is pulled by the station truck, K-53.

MAJOR COMPONENTS

- 1 RC-83 Antenna Equipment
- 1 RC-84 Radio Receiving and Transmitting Equipment
- 1 RC-93 Oscillator Test Equipment
- 1 RM-18 Control Unit
- 1 PN-1 Desk Unit
- 1 PN-5 Fuse Panel
- 1 BC-639 Radio Receiver
- 1 BC-602 Radio Control Unit
- 1 BC-624 & Radio Transmitter-Receiver Unit
- 1 BC-625
- 4 Battery, 12 Volt
- 1 Battery Charger, G.E. Model 6RB33B1
- 2 CD-307 Cord, Extension
- 4 DC-11 Crystal Sets
- 1 FM-39 Frame
- 2 HS-23 Head Set
- 2 T-48 Microphone
- 1 JB-45 Junction Box
- 1 K-53 Truck
- 1 K-63 Power Trailer
- 1 PE-94 Dynamotor Unit
- 1 PE-99 Power Unit
- 1 PE-100 Dynamotor Unit
- 1 EE-8 Telephone
- 1 ME-43 Maintenance Equipment
- 1 TE-66 Tool Equipment
- 2 Battery, 6 Volt
- 1 Charger Panel

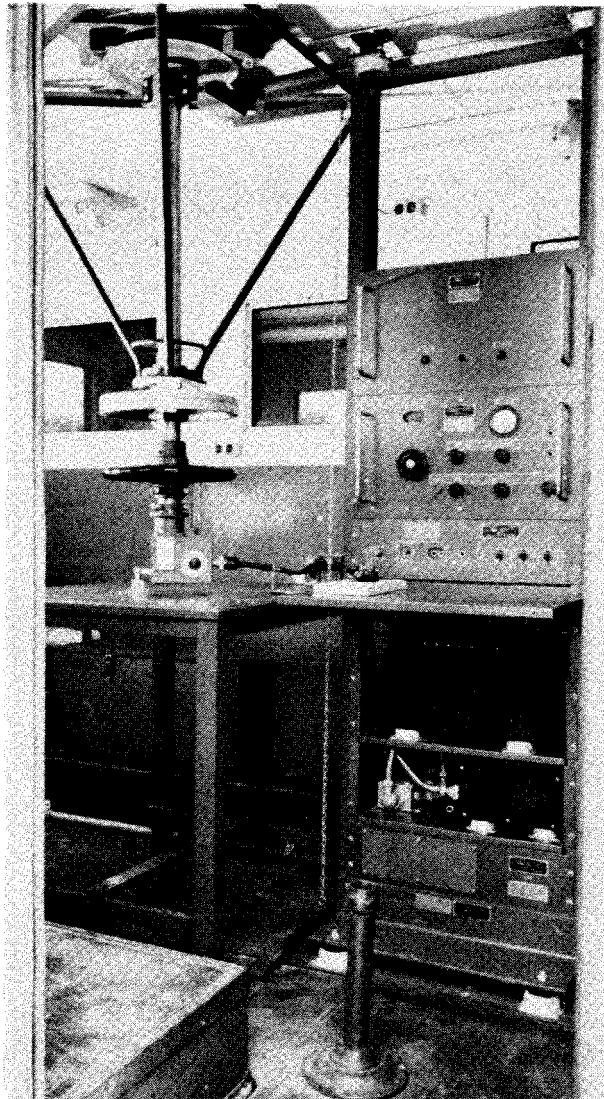

Figure 8 - Interior View of SCR-566 (KE-3)





RESTRICTED

RADIO SET SCR-567

Radio set SCR-567, forward relay station, is a portable radio transmitting and receiving station assembled in two van body trucks K-53. The station

also consists of two two-wheel trailers, gasoline-driven, a-c power units PE-99 and an extratruck to transport the antenna masts and their associated equipment from place to place. This third truck is not considered a component of radio set SCR-567.

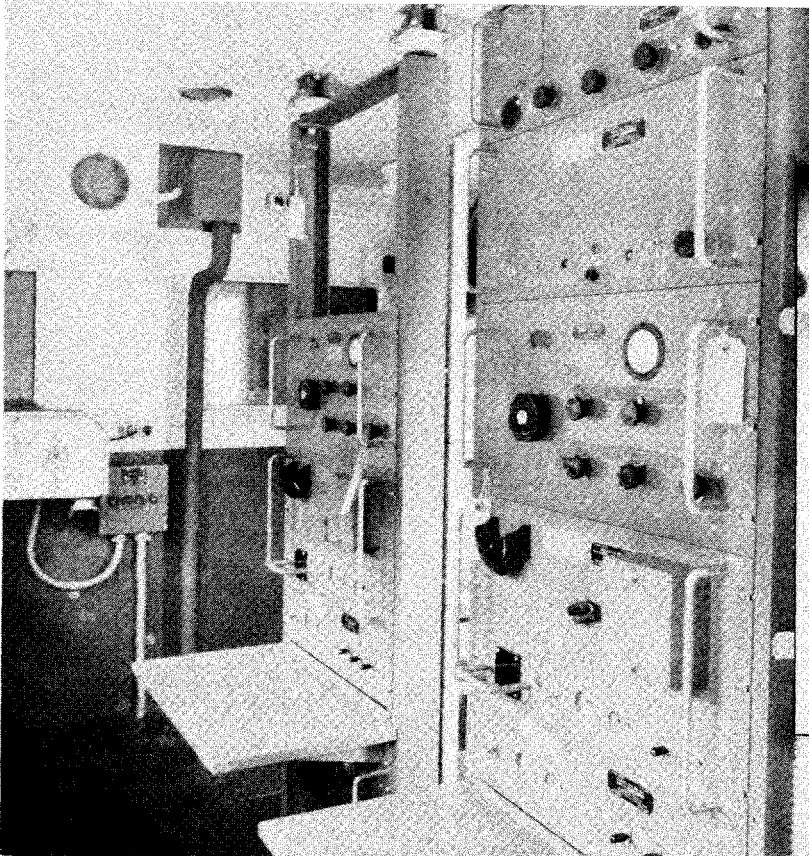

Figure 9 - Interior View of the Transmitting Vehicle of Radio Set SCR-567 (KE-4)

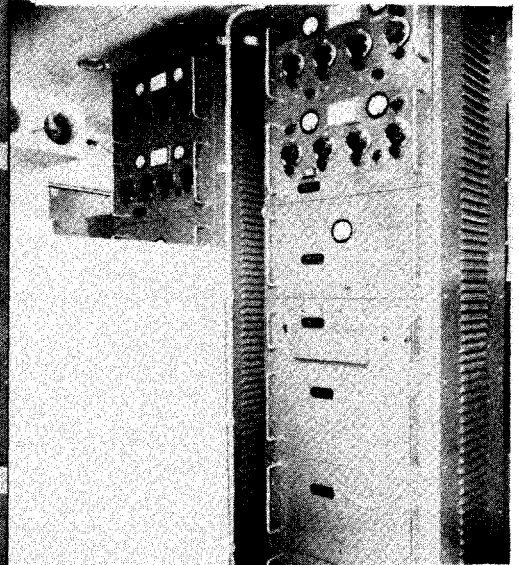

Figure 10 - Interior of the Receiving Vehicle of Radio Set SCR-567 (KE-5)

MAJOR COMPONENTS

2	AN-57	Antenna Masts	1	Battery Charger, G. E. Model #504
2	BC-640	Radio Transmitter		Cord, Extension
2	RC-81	Antenna Equipment	4	DC-11
1	RC-72	Radio Receiving Equipment	4	DR-11
1	RC-86	Radio Receiving Equipment	4	FM-39
1	RC-155	Radio Receiving Equipment	2	HS-23
2	RM-18	Control Unit	4	TS-14
2	PN-1	Desk Unit	2	T-48
1	PN-5	Fuse Panel	4	K-53
1	PN-15	Fuse Panel	2	K-63
1	BC-638	Frequency Meter	2	EE-8
2	BC-639	Radio Receiver	2	ME-44
1	BC-685	Relay Unit	1	ME-45
2	BC-686	Amplifier	1	TE-48
2	RA-42	Rectifier	2	TE-67
1		Oscilloscope	1	TE-68
1		Tester, Supreme, #504	1	Charger Panel
1		Volt Ohmyst	1	

**RADIO SET SCR-572**

Radio set SCR-572 is a mobile operations block (control set) and is used for the same purpose as the fixed operations block SCR-561; however, since radio set SCR-572 is mobile and space is limited, the equipment in this radio set is not as complete as the fixed operations block SCR-561.

**MAJOR COMPONENTS**

1	RC-113	Control Equipment
3	RM-25	Control Unit
2	RM-26	Control Unit
1	RM-28	Control Unit
1	PN-2	Fuse Panel
1	PN-3	Jack Panel
3	BC-687	Relay Unit
1		AF Oscillator
1		Oscilloscope
1		Signal Generator, 18D (Ferris)
1		Signal Generator, 22A (Ferris)
1		Tester, Supreme, #504
1		Voltmeter, Ballentine, #300
1		Volt Ohmyst
4		Battery, 12 Volt
1		Battery Charger, G.E. Model 6RB33B1
3	BD-72	Switchboard
10	CC-70	Patching Cord
10	CD-307	Extension Cord
1	FM-39	Frame
1	FM-40	Frame, Telephone
9	HS-19	Head and Chest Set
10	HS-23	Head Set
7	TS-14	Handset
5	TS-48	Microphone
1	K-63	Power Trailer
1	K-55	Trailer
20	EE-99	Telephone Repeater
1	EE-8	Telephone
1	ME-46	Maintenance Equipment
1	TE-48	Tool Equipment
1	TE-61	Tool Equipment
As req	WC-505	Cable, 50 Pair
1		Charger Panel

**RADIO SET SCR-573-A**

Radio set SCR-573-A is a mobile transmitting station consisting of two BC-640 transmitters and associated equipment. It is connected by telephone lines to the operations block SCR-572. A 75-plywood antenna mast AN-86 is used in conjunction with SCR-573-A.

**MAJOR COMPONENTS**

1	AN-86	Antenna Mast
1	RC-80	Monitoring Equipment
2	RC-81	Antenna Equipment
1	RM-27	Control Unit
1	PN-1	Desk Unit
2	BC-640	Transmitter
1		Oscilloscope
1		Volt Ohmyst
8	CC-70	Patching Cord
2	DC-11	Crystal Set
2	DR-11	Reel, 27 in. x 13-3/4 in.
1	FM-39	Frame
3	HS-23	Head Set
1	TS-14	Handset
2	T-48	Microphone
1	K-53	Truck
1	K-63	Power Trailer
1	EE-8	Telephone
1	ME-47	Maintenance Equipment
1	TE-48	Tool Equipment
1	TE-94	Tool Equipment

Figure 11 - Radio Set SCR-573 (Radio Transmitting Station) - Part of Net Control System SCS-3 Interior View - Showing Radio Transmitters BC-640 and Control Unit RM-27

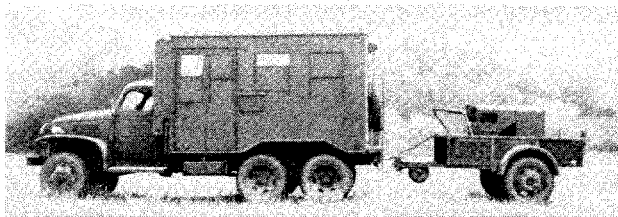
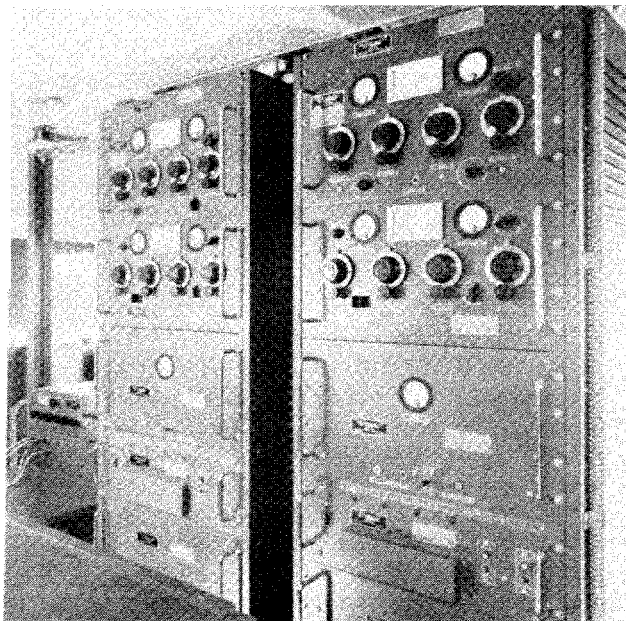

Figure 12 - Radio Set SCR-573 (Radio Transmitting Station) - Part of Net Control System SCS-3 Roadside View - Showing Trailer K-63 Attached to Truck K-53 - Prepared for Traveling

RESTRICTED

RADIO SET SCR-573-B

Radio set SCR-573-B is a mobile transmitting station. The only change made in radio set SCR-573-B from SCR-573-A is that radio set SCR-573-B uses 50-foot plywood antenna mast AN-96 instead of 75-foot antenna mast AN-86.



RADIO SET SCR-574

Radio set SCR-574 is a mobile receiving station. The station includes radio receiving equipment RC-72 and RC-155 assembled in a van body truck K-53. Seventy-five foot plywood antenna mast AN-86 together with antenna equipment RC-81 are used in conjunction with this radio set.

If radio set SCR-574 is used as part of an aircraft control system, it may be operated over suitable telephone lines from a distance up to 90 miles. The station may also be operated locally with manual controls.

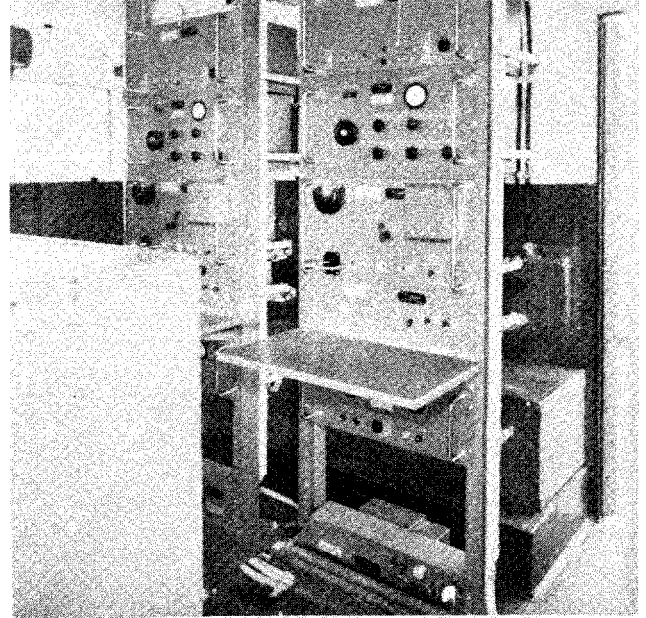

Figure 13 - Radio Set SCR-574 (Radio Receiving Station) - Part of Net Control System SCS-3 Showing Radio Receiving Equipment RC-72

MAJOR COMPONENTS

1	AN-86	Antenna Mast	1	Battery Charger, G.E. Model 6RB33B1
1	RC-72	Radio Receiving Equipment	2	DC-11
2	RC-81	Antenna Equipment	2	DR-11
1	RC-155	Radio Receiving Equipment	2	FM-39
2	RM-18	Control Unit	3	HS-23
2	PN-1	Desk Unit	3	TS-14
1	PN-5	Fuse Panel	3	T-48
1	PN-15	Fuse Panel	2	J-44
1	BC-638	Frequency Meter	1	K-53
2	BC-639	Radio Receiver	1	K-63
2	BC-685	Relay Unit	1	EE-8
2	BC-686	Amplifier	1	ME-48
2	RA-42	Rectifier	1	TE-48
1		Tester, Supreme, #504	1	TE-95
1		Volt Ohmyst	1	
4		Battery, 12 Volt	1	Charger Panel



RESTRICTED

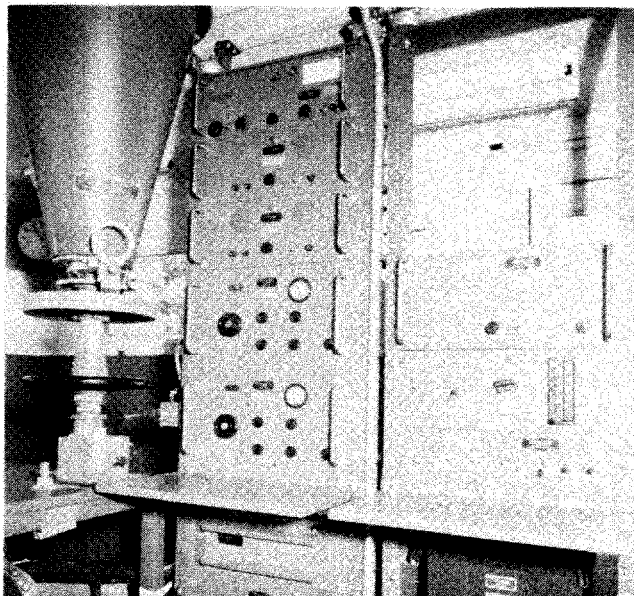

Figure 14 - Radio Set SCR-575 (Radio Direction Finding Station) - Part of Net Control System SCS-3 Interior View - Showing Radio Receiving Equipment RC-79 - Receiving and Transmitting Equipment RC-165, and Antenna Equipment RC-153

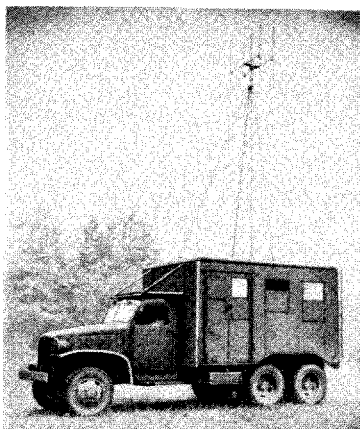

Figure 15 - Radio Set SCR-575 (Radio Direction Finding Station) - Part of Net Control System SCS-3 Roadside View - Showing Antenna Equipment RC-153 Raised in Position

RADIO SET SCR-575

Radio set SCR-575 is a mobile direction finding station mounted in a van body truck K-53. Antenna equipment RC-153 is mounted on top of the truck. Radio receiving-transmitting equipment RC-165 and radio receiving equipment RC-79, with associated equipment are mounted inside this truck. This radio set is somewhat similar to mobile direction finding set SCR-566.

MAJOR COMPONENTS

1	RC-79	Radio Receiving Equipment	1		Battery Charger, G.E. Model 6RB33B1
1	RC-93	Oscillator Test Equipment			
1	RC-153	Antenna Equipment	6	DC-11	Crystal Sets
1	RC-165	Radio Receiving and Transmitting Equipment	2	FM-39	Frame
		Control Unit	3	HS-23	Head Set
1	RM-18	Desk Unit	3	TS-14	Handset
2	PN-1	Fuse Panel	1	JB-45	Junction Box
1	PN-5	Switching Panel	1	J-44	Key
1	PN-6	Fuse Panel	1	JB-29	Junction Box
1	PN-15	Control Panel	1	K-53	Truck
1	PN-25	Frequency Meter	1	K-63	Trailer
1	BC-638	Radio Receiver	1	PE-94	Dynamotor Unit
2	BC-639	Relay Unit	1	PE-100	Dynamotor Unit
1	BC-687	Radio Control Unit	1	EE-8	Telephone
1	BC-602	Radio Transmitter-Receiver	1	I-139	Test Set
1	BC-625 & BC-624	Rectifier	1	ME-49	Maintenance Equipment
2	RA-42	Tester, Supreme, #504	1	TE-48	Tool Equipment
1		Volt Ohmyst	1	TE-96	Tool Equipment
1		Battery, 12 Volt	2		Battery, 6 Volt
4			1		Charger Panel



RESTRICTED

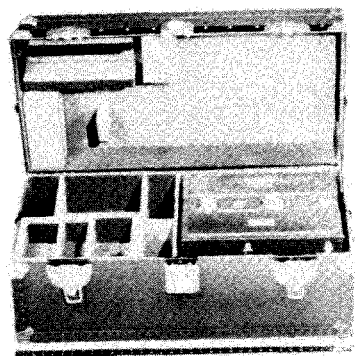

Figure 16 - Chest CH-173-A Unpacked, with Radio Receiver BC-624-A, Radio Transmitter BC-625-A, Master Control Box BC-1175-A, Control Box BC-1171-A (Remote); Control Box BC-1176-A (Remote), Cord CD-809-A, Cord CD-815-A, 2 Field Telephones EE-8-A, Spare Tubes and Tool Kit; Part of Radio Set SCR-624-T1



AIR TRANSPORTABLE RADIO SET SCR-624

Radio set SCR-624 is a complete VHF radio ground station designed to operate on frequencies between 99 and 156 megacycles. This set uses radio receiver BC-624 and radio transmitter BC-625 as means of transmission and reception.

Power is supplied this radio set by rectifier RA-62. Rectifier RA-62 uses an a-c single phase, 40 to 60 cycle power supply at 100 to 130 or 200 to 260 volts for a primary power source.



Figure 17 - Chest CH-173-A Completely Packed, with Radio Receiver BC-624-A, Radio Transmitter BC-625-A, Master Control box BC-1175-A, Control Box BC-1171-A (Remote), Control Box BC-1176-A (Remote), Cord CD-809-A, Cord CD-815-A, 2 Field Telephones EE-8-A, Spare Tubes and Tool Kit; Part of Radio Set SCR-624-T1

MAJOR COMPONENTS

1 Chest	CH-173-A	1 Tool Kit	(Part of IE-12-A Test Equip.)
1 Transmitter	BC-625-A, Part of SCR-522-A	1 Spare Tube Box	One of Each Tube Used
1 Receiver	BC-624-A, Part of SCR-522-A	1 Chest	CH-172-A
1 Rack	FT-244-A, Part of SCR-522-A	1 Rectifier	RA-62-B
1 Case	CS-80-A, Part of SCR-522-A	1 Cord (500 ft, 8 in. Conductor)	CD-810-A
1 Master Control Box	BC-1175-A	1 Cord (25 ft a-c Line)	(Supplied With RA-62-B)
1 Remote Control Box	BC-1171-A	1 Spare Parts Box	One of Each Tube Used +10 Fuses
1 Remote Terminal Box	BC-1176-A	1 Chest	CH-170-A
1 Cord (6 ft, 6 in. Conductor)	CD-809-A	1 Antenna (Half Wave Voltage Fed)	AN-94-A
1 Cord (6 ft, 8 in. Conductor)	CD-815-A	1 Cable (Coaxial H.F.)	WC-549
2 Field Telephone	EE-8-A		

RESTRICTED

RADIO SET SCR-632

Radio set SCR-632 is a local, fixed, transmitting station located one or two miles from the operations block or airfield. It must be far enough away from the airfield so that the antenna will not interfere with flying operations.

Radio set SCR-632 is connected by telephone lines to the operations block. Generally, SCR-632 is the same as radio set SCR-562 except that the former is fixed, whereas, SCR-562 is mounted in trailer K-35. By making a careful comparison of radio set SCR-632 and radio set SCR-562, it will be noted that the types of components in both radio sets are the same; however, there will be fewer components in radio set SCR-632.

Radio set SCR-632 is used for communication with tactical aircraft.

MAJOR COMPONENTS

4	AN-56	Antenna Mast	2	DR-11	Reel, 27 in. x 13-3/4 in.
1	RC-80	Monitoring Equipment	3	FM-39	Frame
8	RC-81	Antenna Equipment	3	HS-23	Head Set
1	RM-27	Control Unit	1	HO-3	Shelter
1	PN-1	Desk Unit	2	TS-14	Handset
6	BC-640	Transmitter	2	T-48	Microphone
1		Oscilloscope	1	PE-99	Power Unit
1		Volt Ohmyst	1	EE-8	Telephone
10	CC-70	Cord, Patching	2	ME-41	Maintenance Equipment
2	CD-307	Cord, Extension	1	TE-48	Tool Equipment
2	DC-11	Crystal Set	1	TE-62	Tool Equipment



RADIO SET SCR-633

Radio set SCR-633 is a local, fixed, receiving station located near the control center but sufficiently separated from the transmitting station to prevent blocking of the receivers. This station must be placed so that the antenna masts will not interfere with flying operations. There is much similarity between radio set SCR-633 and radio set SCR-562. Telephone communication is provided between this radio set and the control center (operations block).

MAJOR COMPONENTS

4	AN-56	Antenna Mast	3	CD-307	Cord, Extension
1	RC-76	Radio Receiving Equipment	2	DC-11	Crystal Set
2	RC-77	Radio Receiving Equipment	7	DR-11	Reel 27 in. x 13-3/4 in.
8	RC-81	Antenna Equipment	3	FM-39	Frame
1	RM-23	Control Unit	3	HS-23	Head Set
3	PN-1	Desk Unit	1	HO-3	Shelter
3	PN-4	Socket Panel	2	TS-14	Handset
1	PN-15	Fuse Panel	2	T-48	Microphone
1	BC-638	Frequency Meter	1	PE-99	Power Unit
6	BC-639	Radio Receiver	1	EE-8	Telephone
6	RA-42	Rectifier	2	TE-48	Tool Equipment
1		Tester, Supreme, #504	1	TE-63	Tool Equipment
10	CC-70	Cord, patching			



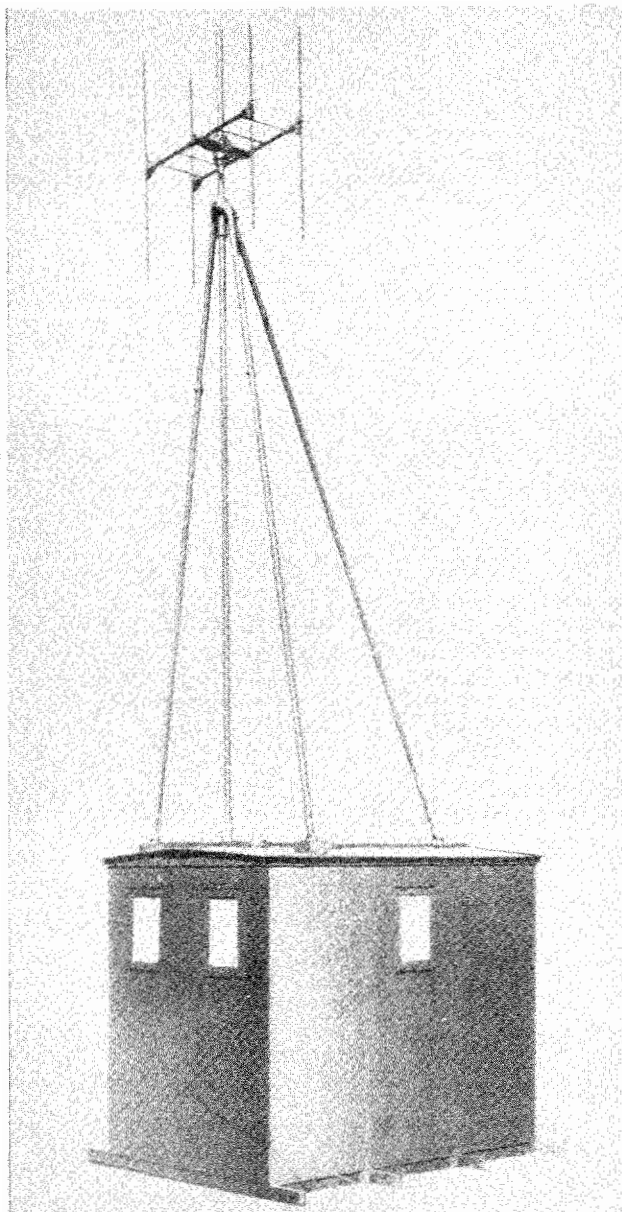
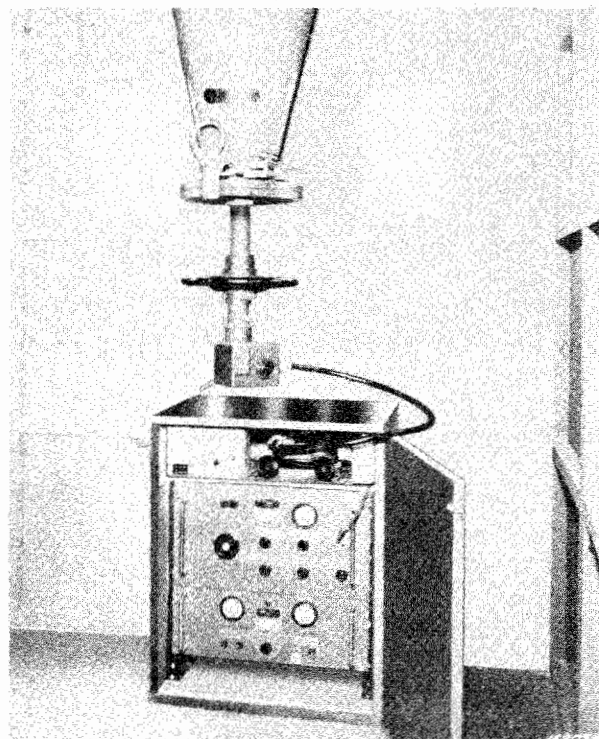

Figure 18 - Radio Set SCR-634-A Rear Three-quarter View - Showing Shelter HO-34-A with Upper Half of Antenna Equipment RC-153-B Attached - Prepared for Operation as a Direction Finding Station

Figure 19 - Interior View - Showing Components of Air Transportable D/F Radio Set SCR-634



**RADIO SET SCR-634**

Radio set SCR-634 is an air-transportable radio set used for locating the position of friendly aircraft.

Power for this radio set is supplied by power unit PE-214.

**COMPONENTS**

1	Antenna Equipment RC-153	2	Cord Extension, CD-307
1	Radio Receiving Equipment RC-229	1	Head Set HS-23
1	Radio Control Unit, RM-38	1	Shelter HO-34
1	Rectifier, RA-42	1	Power Unit PE-214

RESTRICTED

RADIO SET SCR-637

Radio set SCR-637 is a fixed forward relay station used to extend the range of air-to-ground, ground-to-air communication. Telephone communication is provided between this station and the control center (operations block). By means of suitable telephone lines it is possible to remotely control this station up to distances of 90 miles from the control center. Generally speaking, radio set SCR-637 is the same as SCR-567 except that the latter is mobile.

MAJOR COMPONENTS

2	AN-57	Antenna Mast	1		Battery Charger, GE Model 6RB33B1
1	RC-72	Radio Receiving Equipment			
2	RC-81	Antenna Equipment	2	CD-307	Cord, Extension
1	RC-155	Radio Receiving Equipment	4	DC-11	Crystal Set
2	RM-18	Control Unit	4	DR-11	Reel, 27 in. x 13-3/4 in.
2	PN-1	Desk Unit	2	FM-39	Frame
1	PN-5	Fuse Panel	2	HS-23	Head Set
1	PN-15	Fuse Panel	1	HO-3	Shelter
1	BC-638	Frequency Meter	2	TS-14	Handset
2	BC-639	Radio Receiver	2	T-48	Microphone
2	BC-640	Radio Transmitter	1	PE-99	Power Unit
1	BC-685	Relay Unit	1	EE-8	Telephone
2	BC-686	Amplifier	1	ME-44	Maintenance Equipment
2	RA-42	Rectifier	1	ME-45	Maintenance Equipment
1		Oscilloscope	1	TE-48	Tool Equipment
1		Tester, Supreme, #504	1	TE-67	Tool Equipment
1		Volt Ohmyst	1	TE-68	Tool Equipment
4		Battery, 12 Volt	1		Charger Panel



RADIO SET SCR-642

Radio set SCR-642 is a fixed operations block (control set) and is very similar to radio set SCR-572. The primary purpose of this radio set is to provide a center for control of tactical aircraft.

MAJOR COMPONENTS

1	RC-113	Control Equipment	11	CC-70	Cord, Patching
3	RM-25	Control Unit	10	CD-307	Cord, Extension
2	RM-26	Control Unit	1	FM-39	Frame
1	RM-28	Control Unit	1	FM-40	Frame, Telephone
1	PN-2	Fuse Panel	9	HS-19	Head and Chest Set
1	PN-3	Jack Panel	10	HS-23	Head Set
3	BC-687	Relay Unit	1	HO-3	Shelter
1		AF Oscillator	7	TS-14	Handset
1		Oscilloscope	5	T-48	Microphone
1		Signal Generator, #18D (Ferris)	1	PE-99	Power Unit
1		Signal Generator, #22A (Ferris)	20	EE-99	Telephone Repeater
1		Tester, Supreme, #504	1	EE-8	Telephone
1		Voltmeter, Ballentine, #300	1	ME-46	Maintenance Equipment
1		Volt Ohmyst	1	TE-48	Tool Equipment
4		Battery, 12 Volt	1	TE-61	Tool Equipment
1		Battery Charger, G.E. Model 6RB33B1	300 ft	WC-505	Cable, 40 Pair
3	BD-72	Switchboard	1		Charger Panel



RESTRICTED

RADIO SET SCR-643

Radio set SCR-643 is a fixed transmitting station providing communication between a control officer and tactical aircraft. This station is equipped with two BC-640 transmitters and associated equipment. Used in conjunction with this station is a 90-foot steel

antenna mast AN-56 upon which is mounted antenna equipment RC-81. The equipment used with this station corresponds roughly to that used with radio set SCR-573-A, the main difference being that radio set SCR-573-A is mounted in a van body truck K-53 and is provided with antenna mast AN-86 instead of antenna mast AN-56.

MAJOR COMPONENTS

1	AN-56	Antenna Mast	1	FM-39	Frame
1	RC-80	Monitoring Equipment	3	HS-23	Head Set
2	RC-81	Antenna Equipment	1	HO-3	Shelter
1	RM-27	Control Unit	1	TS-14	Handset
1	PN-1	Desk Unit	2	T-48	Microphone
2	BC-640	Radio Transmitter	1	PE-99	Power Unit
1		Oscilloscope	1	EE-8	Telephone
1		Volt Ohmyst	1	ME-47	Maintenance Equipment
8	CC-70	Cord, Patching	1	TE-48	Tool Equipment
2	DC-11	Crystal Sets	1	TE-94	Tool Equipment
2	DR-11	Reel, 27 in. x 13-3/4 in.			



RADIO SET SCR-644

Radio set SCR-644 is a fixed receiving station having similar equipment as mobile radio receiving set SCR-574, except that the latter is mounted in a van body truck K-53. By means of suitable telephone

lines this receiving station can be remotely controlled from distances up to 90 miles from the control center. This radio station is provided with radio receiving equipment RC-72, RC-168 and associated equipment. Telephone communication is provided between this radio set and the control center.

MAJOR COMPONENTS

1	AN-56	Antenna Mast	1		Battery Charger, G.E. Model 6RB33B1
1	RC-72	Radio Receiving Equipment	5	CC-70	Cord, Patching
2	RC-81	Antenna Equipment	2	DC-11	Crystal Set
1	RC-168	Radio Receiving Equipment	2	DR-11	Reel, 27 in. x 13-3/4 in.
2	RM-18	Control Unit	2	FM-39	Frame
1	RM-23	Control Unit	3	HS-23	Head Set
2	PN-1	Desk Unit	1	HO-3	Shelter
1	PN-5	Fuse Panel	3	TS-14	Handset
1	PN-15	Fuse Panel	3	T-48	Microphone
1	BC-638	Frequency Meter	2	J-44	Key
2	BC-639	Radio Receiver	1	PE-99	Power Unit
2	BC-685	Relay Unit	1	EE-8	Telephone
2	BC-686	Amplifier	1	ME-50	Maintenance Equipment
2	RA-42	Rectifier	1	TE-48	Tool Equipment
1		Tester, Supreme, #504	1	TE-95	Tool Equipment
1		Volt Ohmyst	1		Charger Panel
4		Battery, 12-volt			



RESTRICTED

RADIO SET SCR-645

Radio set SCR-645 is a fixed direction finding station and may be used as either a fixer station or a homer station. Generally speaking, the equipment used in this radio set is the same as that used in radio set SCR-575, except that SCR-575 is mounted in truck K-53, and is provided with different antenna equipment than SCR-645. This station serves the same purpose as all other direction finding and homing stations.

MAJOR COMPONENTS

1	RC-79	Radio Receiving Equipment	1		Battery Charger, G.E.
1	RC-93	Oscillator Test Equipment			Model 6RB33B1
1	RC-165	Radio Receiving and Trans-	6	DC-11	Crystal Set
		mitting Equipment	2	FM-39	Frame
1	RC-213	Antenna Equipment	3	HS-23	Head Set
1	RM-18	Control Unit	1	HO-3	Shelter
2	PN-1	Desk Unit	3	TS-14	Handset
1	PN-5	Fuse Panel	1	JB-45	Junction Box
1	PN-6	Switching Panel	1	J-44	Key
1	PN-15	Fuse Panel	1	JB-29	Junction Box
1	PN-25	Control Panel	1	PE-94	Dynamotor Unit
1	BC-638	Frequency Meter	1	PE-99	Power Unit
2	BC-639	Radio Receiver	1	PE-100	Dynamotor Unit
1	BC-687	Relay Unit	1	EE-8	Telephone
1	BC-602	Radio Control Unit	1	I-139	Test Set
1	BC-625 &	Radio Transmitter-	1	ME-49	Maintenance Equipment
	BC-624	Receiver Unit	1	TE-48	Tool Equipment
2	RA-42	Rectifier	1	TE-96	Tool Equipment
1		Tester, Supreme, #504	1	TR-17	Tower
1		Volt Ohmyst	2		Battery, 6 Volt
4		Battery, 12 Volt	1		Charger Panel





**Charts Showing Components  
Of Complete Radio Sets**









RESTRICTED

COMPONENT	OPERATIONS BLOCK, FIXED										OPERATIONS BLOCK, MOBILE									
	551	552	553	554	555	556	557	558	559	560	561	562	563	564	565	566	567	568	569	570
PE-94																				
PE-99																				
PE-100																				
PE-214																				
EE-8	2	2																		
I-139																				
ME-41		2									2									
ME-42			1									1								
ME-43																				
ME-44																				
ME-45																				
ME-46																				
ME-47																				
ME-48																				
ME-49																				
ME-50																				
ME-51	1																			
ME-54				1																
ME-55					1															
TE-48	1	2	1																	
TE-61	1																			
TE-62		2																		
TE-63			1																	
TE-65					1															
TE-66						1														
TE-67																				
TE-68																				
TE-74				1																
TE-94																				
TE-95																				
TE-96																				
TR-17				1	1															
WC-505	1000 FT.																			
BATTERY, 6-VOLT					2	2														2
CHARGER, PANEL	A				A	B	A				A									B
JB-45							1													1
EE-99	6																			

RESTRICTED

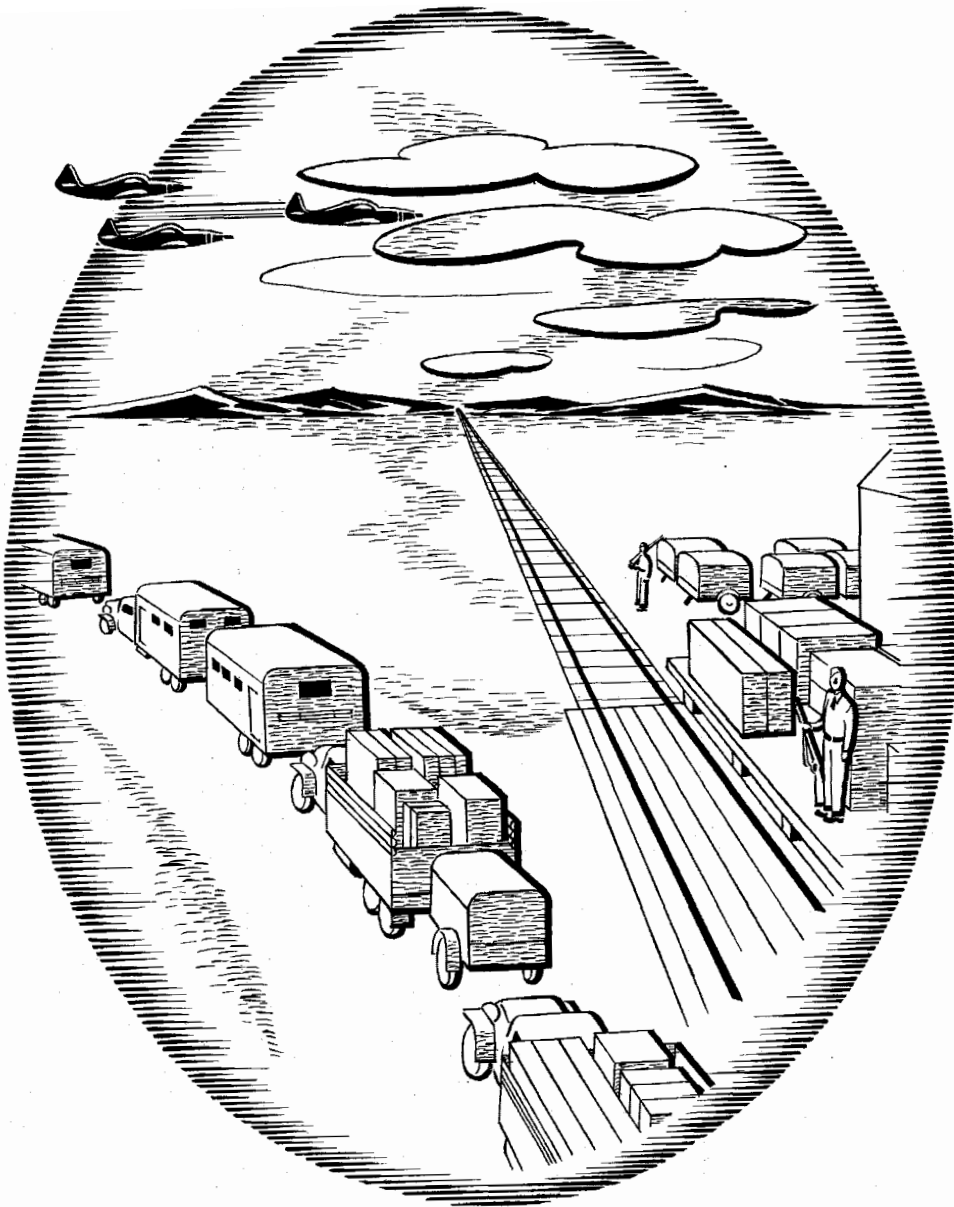





**Illustrations and Descriptions  
Of RC Units**





**RADIO RECEIVING EQUIPMENT RC-72**

Radio receiving equipment RC-72 is part of the receiving station of radio set SCR-567 (advance relay station). This equipment is mounted in truck K-53.

Power for this receiving equipment is furnished by power unit PE-99 or a commercial power source.

**RADIO SETS USED WITH**

Advance Relay Station SCR-567

**COMPONENTS**

1	BC-686	Amplifier
1	RM-18	Control Unit
1	PN-1	Desk Unit
1	FM-39	Frame
1	BC-638	Frequency Meter
1	PN-15	Fuse Panel
1	BC-639	Radio Receiver
1	RA-42	Rectifier
1	BC-685	Relay Unit

All units complete with tubes and spare tubes.

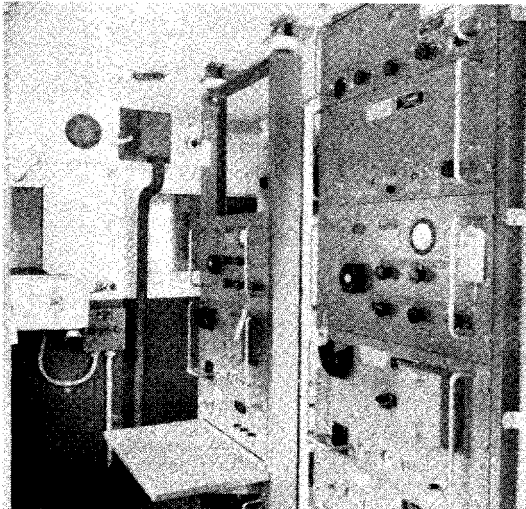

Figure 20 - Radio Receiving Equipment RC-72



**RADIO RECEIVING EQUIPMENT RC-76**

Radio receiving equipment RC-76 is composed of ten units as pictured. The frame holding all components is FM-39. There are two radio receivers BC-639; two rectifiers RA-42, one desk unit PN-1, one socket panel PN-4, one fuse panel PN-15, one control unit RM-23 and one frequency meter BC-638.

A gasoline-driven power supply, power unit PE-99 is used to supply the power necessary to operate the above equipment.

**RADIO SETS USED WITH**

SCR-563      SCR-633

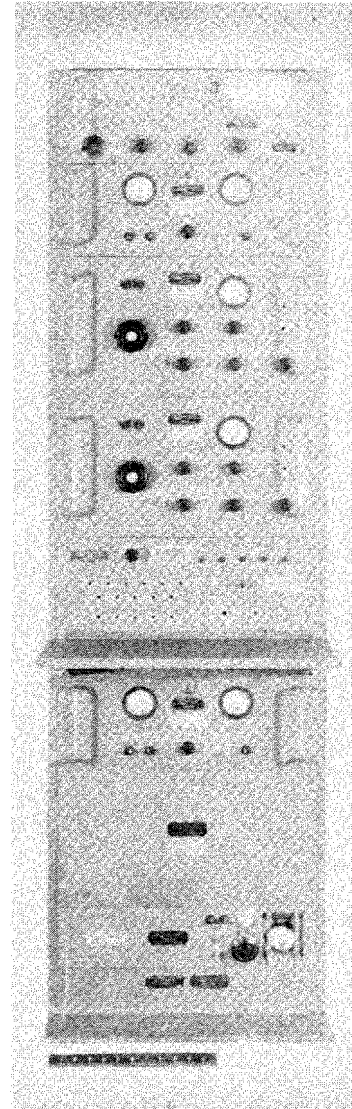

Figure 21 - Radio Receiver Equipment RC-76-A - Front View

**COMPONENTS**

1	RM-23	Control Unit
1	PN-1	Desk Unit
1	FM-39	Frame
1	BC-638	Frequency Meter
1	PN-15	Fuse Panel
1		Harness, Wiring, RH
1		Harness, Wiring, LH
2	BC-639	Radio Receiver
1	RA-42	Rectifier
1	PN-4	Socket Panel
1		Support for Harness

All units equipped with tubes and spare tubes.

★                      ★                      ★                      ★                      ★

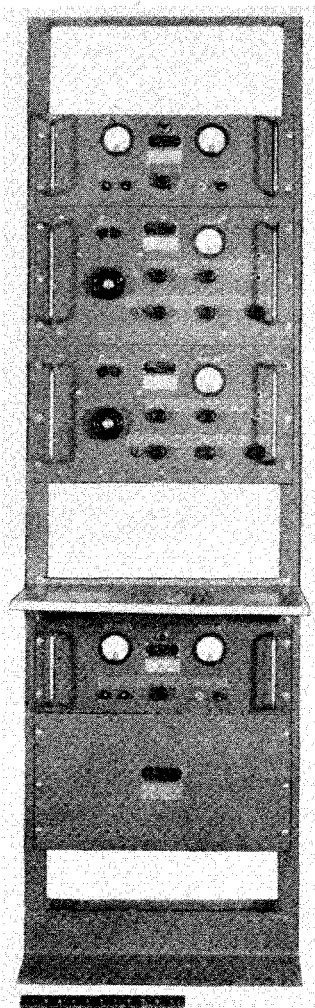

Figure 22 - Radio Receiver Equipment RC-77-A - Front View

**RADIO RECEIVING EQUIPMENT RC-77**

Radio receiving equipment RC-77 is composed of seven units as pictured. The frame holding all components is FM-39.

A gasoline-driven power supply, power unit PE-99 is used to supply the power necessary to operate the above equipment.

**RADIO SETS USED WITH**

SCR-563  
SCR-633

**COMPONENTS**

- |   |        |                |
|---|--------|----------------|
| 1 | PN-7   | Desk Unit      |
| 1 | FM-39  | Frame          |
| 2 | BC-639 | Radio Receiver |
| 2 | RA-42  | Rectifier      |

All units complete with tubes and spare tubes.

**RADIO RECEIVING EQUIPMENT RC-78**

Radio receiving equipment RC-78 is part of radio direction finding and homing station SCR-564.

Power for this equipment is supplied by power unit PE-99, PE-75-D or a commercial power source.

**RADIO SET USED WITH**

SCR-564, Radio Direction Finding and Homing Station  
**COMPONENTS**

- 1 Control Unit, RM-24
- 1 Desk Unit, PN-1
- 1 Frame, FM-39
- 1 Frequency Meter, BC-638
- 1 Fuse Panel, PN-15
- 1 Harness, Wiring
- 2 Radio Receiver, BC-639
- 2 Rectifier, RA-42
- 1 Socket Panel, PN-4
- 1 Support for Harness

All units complete with tubes and spare tubes.

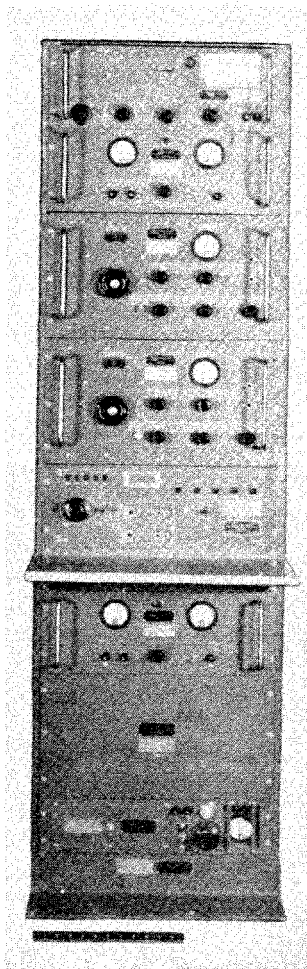

Figure 23 - Radio Receiver Equipment RC-78-A - Front View

**RADIO RECEIVING EQUIPMENT RC-79**

Radio receiving equipment RC-79 is part of radio sets:

SCR-565

SCR-575

SCR-645

Power unit PE-99, PE-75-D or a commercial source is used to supply power to this equipment.

**COMPONENTS**

- 1 Desk Unit, PN-1
- 1 Dynamotor Unit, PE-100
- 1 Frame, FM-39
- 1 Frequency Meter, BC-638
- 1 Fuse Panel, PN-15
- 1 Harness, Wiring
- 2 Radio Receiver, BC-639
- 2 Rectifier, RA-42
- 1 Support for Harness
- 1 Switching Panel, PN-6

All units complete with tubes and spare tubes.

Figure 24 - Radio Receiver Equipment RC-79-A -  
Front View

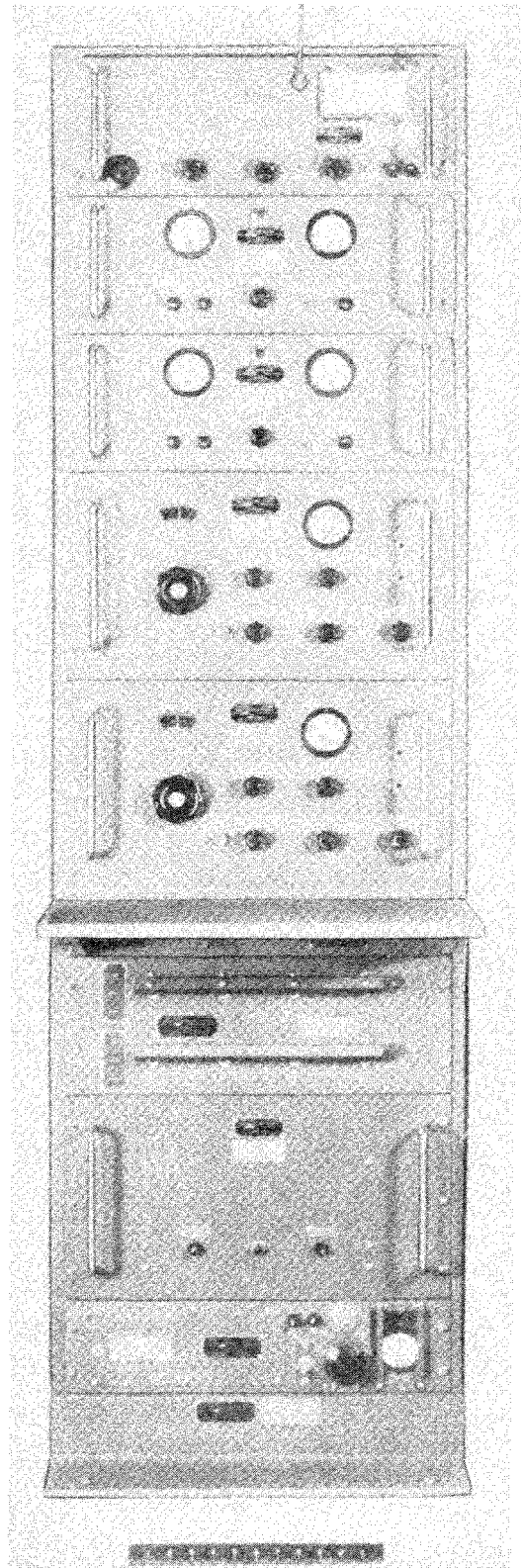

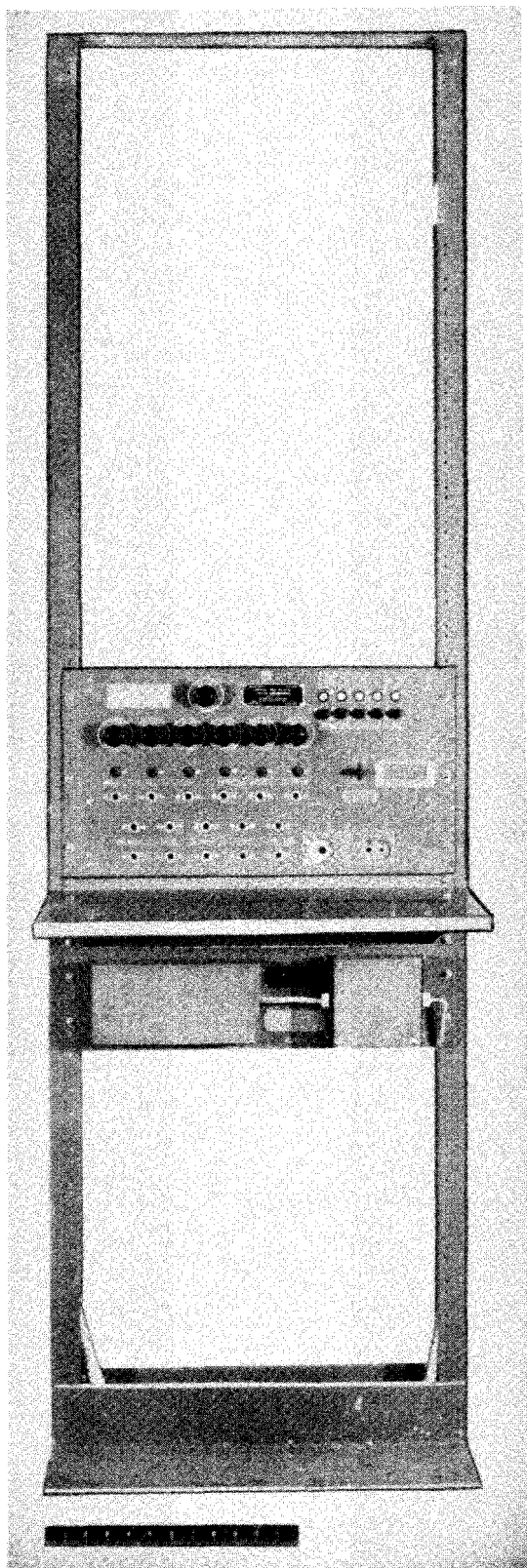

**MONITORING EQUIPMENT RC-80**

Monitoring equipment RC-80 offers an easy method for monitoring the outputs of radio transmitters.

Monitoring equipment RC-80 is used with the following radio sets:

SCR-562

SCR-573

SCR-632

SCR-643

**COMPONENTS**

- 1 Frame, FM-39
- 1 Desk Unit, PN-1
- 1 Control Unit, RM-27
- 1 Buzzer, BZ-8



**Figure 25 - Monitoring Equipment RC-80-A - Front View**



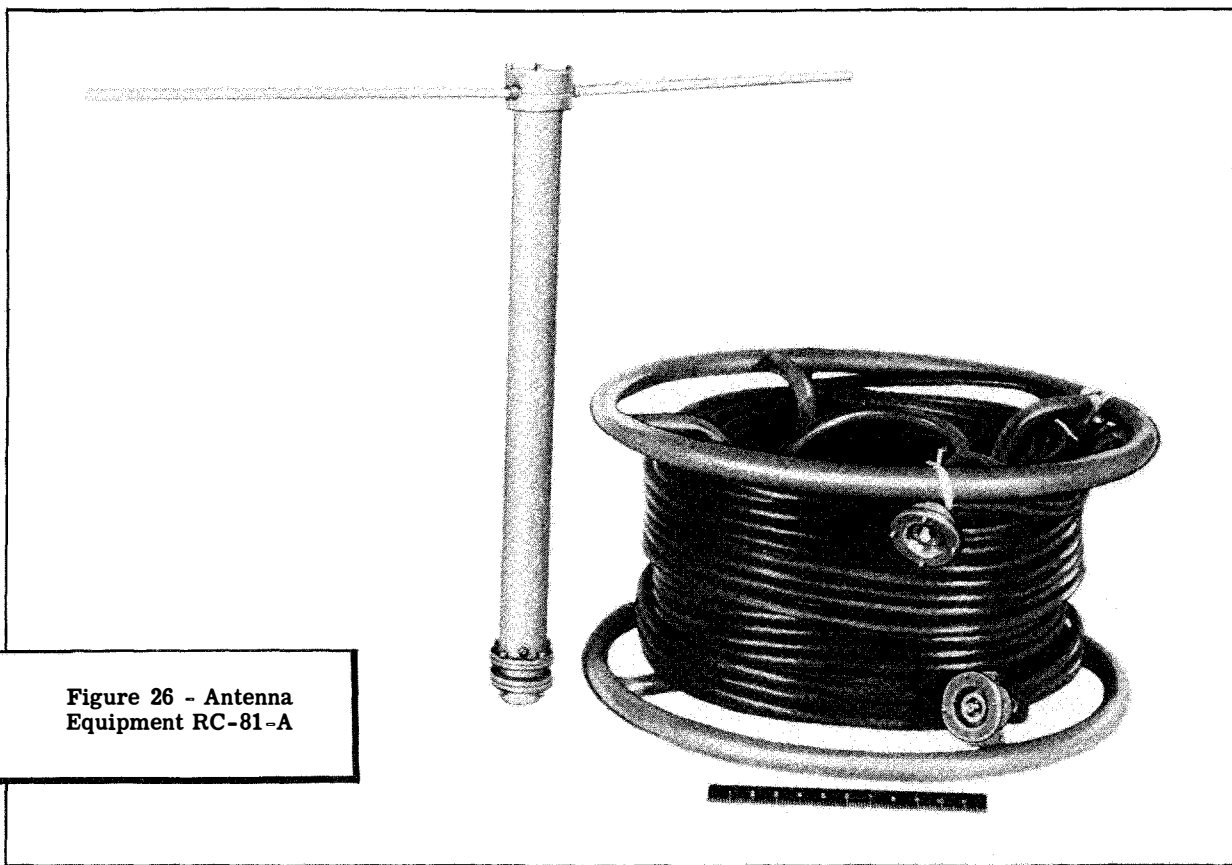

Figure 26 - Antenna Equipment RC-81-A

**ANTENNA EQUIPMENT RC-81**

Antenna equipment RC-81 is composed of antenna dipoles and coaxial cable connections necessary for the erection of antenna masts AN-56, AN-86, AN-96. The AN series is the mast itself and the antenna equipment RC-81 is necessary for complete antenna system.

This antenna equipment is used with the following radio sets:

- |         |         |
|---------|---------|
| SCR-562 | SCR-632 |
| SCR-563 | SCR-633 |
| SCR-567 | SCR-637 |
| SCR-573 | SCR-643 |
| SCR-574 | SCR-644 |

**COMPONENTS**

- 1 Dipole Assembly
- 2 Dipole Rod Assembly, 132 to 156 MC (17-21/32 in.)
- 2 Dipole Rod Assembly, 122 to 146 MC (20-13/32 in.)
- 2 Dipole Rod Assembly, 100 to 124 MC (23-13/32 in.)
- 12 Tubing Lock for Dipole Rod

RESTRICTED

ANTENNA EQUIPMENT RC-82

Antenna equipment RC-82 is a direction finding (DF) antenna system designed for use over a frequency range from 100 to 156 megacycles. The antenna system is used in conjunction with a radio receiver BC-639. A tuned coupling unit is provided to match the antenna to the receiver.

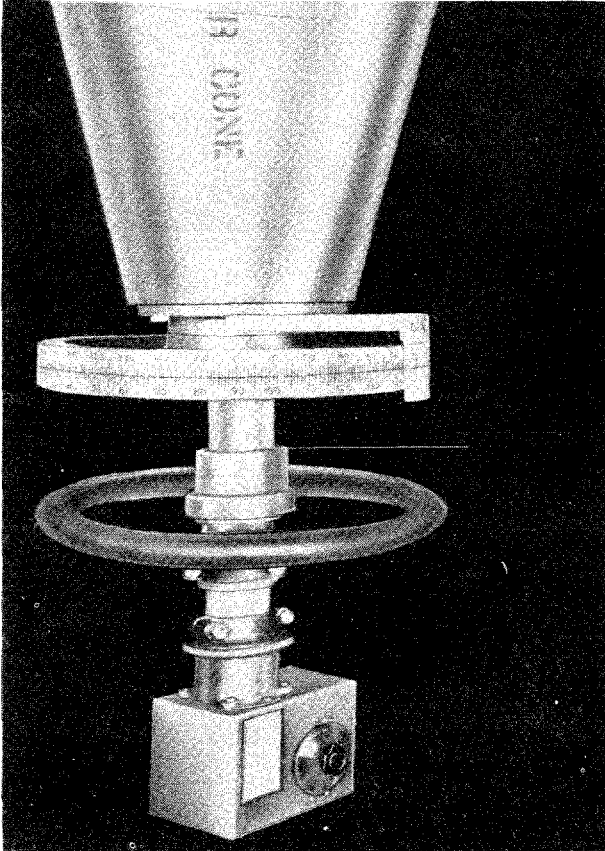

ceiver BC-639. A tuned coupling unit is provided to match the antenna to the receiver.

RADIO SETS USED WITH

SCR-564

SCR-565



Figure 27 - Antenna Equipment RC-82 - Lower Mast Assembly

Figure 28 - Antenna Equipment RC-82-A - Upper Mast Assembly

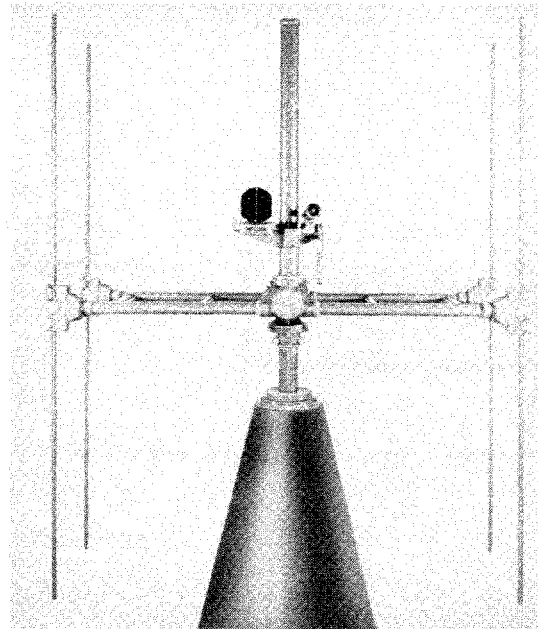

COMPONENTS

- |   |  |
|---|--|
| <ul style="list-style-type: none"> <li>1 Dipole Rod Set. Each set includes:             <ul style="list-style-type: none"> <li>8 Rod, 28 in. with plug on each end</li> <li>8 Rod, 23 in. with plug on each end</li> <li>8 Rod, 21 in. with plug on each end</li> </ul> </li> <li>1 Antenna Frame Assembly (H Frame)</li> <li>2 Coaxial Cable Stub Assembly, 3 ft</li> <li>1 Coupler Assembly</li> <li>1 Cover Assembly (Cap for Sense Rod)</li> <li>1 Dial Assembly</li> <li>1 Disc Assembly To Operate Sense Switch</li> <li>1 Drive Shaft Assembly (18 ft w/Sense Rod and Transmission Line)</li> <li>1 Handwheel Assembly</li> <li>1 Index Bracket</li> <li>1 Index Dial (Cursor)</li> <li>1 Mounting Assembly, Lower cone, includes:             <ul style="list-style-type: none"> <li>1 Baseboard</li> <li>1 Cone</li> <li>1 Bearing Assembly</li> </ul> </li> </ul> | <ul style="list-style-type: none"> <li>1 Mounting Assembly, Upper cone, includes:             <ul style="list-style-type: none"> <li>1 Baseboard</li> <li>1 Cone</li> <li>1 Upper Bearing Assembly</li> <li>1 Lower Bearing Assembly</li> </ul> </li> <li>2 Right Angle Adapter Assembly (For Coaxial Cable Stud)</li> <li>1 Swivel Assembly (Stop for Coupler Assembly)</li> <li>1 Telescope, Compass and spirit level assembled on holders, includes:             <ul style="list-style-type: none"> <li>2 Level, Spirit, Stanley Tool Company #34-4</li> <li>1 Magnetic Compass, Keuffel and Esser #5600</li> <li>1 Magnetic Compass and Spirit Level Holder</li> <li>1 Telescope Model 438, 4 power, Lyman Gun Site Corp.</li> <li>1 Telescope Holder</li> </ul> </li> </ul> |
|---|--|



RESTRICTED

ANTENNA EQUIPMENT RC-83

Antenna equipment RC-83 is a direction finding antenna system designed for use over a frequency range from 100 to 156 megacycles. This antenna equipment is used in conjunction with radio trans-

mitting and receiving equipment RC-84. A tuned coupling unit is provided to match the antenna to the transmitting and receiving equipment.

RADIO SETS USED WITH  
SCR-566



Figure 29 - Antenna Equipment RC-83 - Showing Lower Part of Antenna System

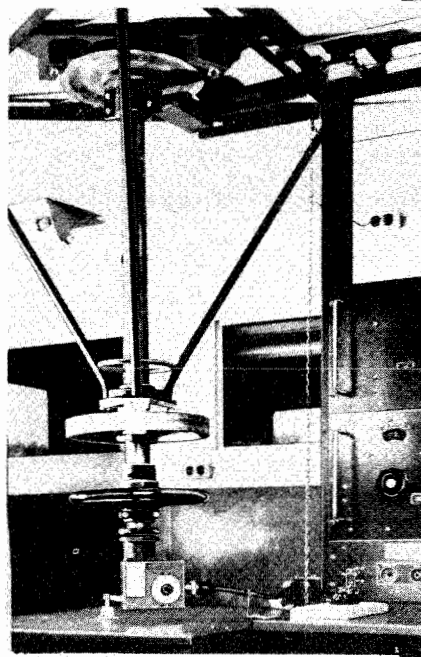
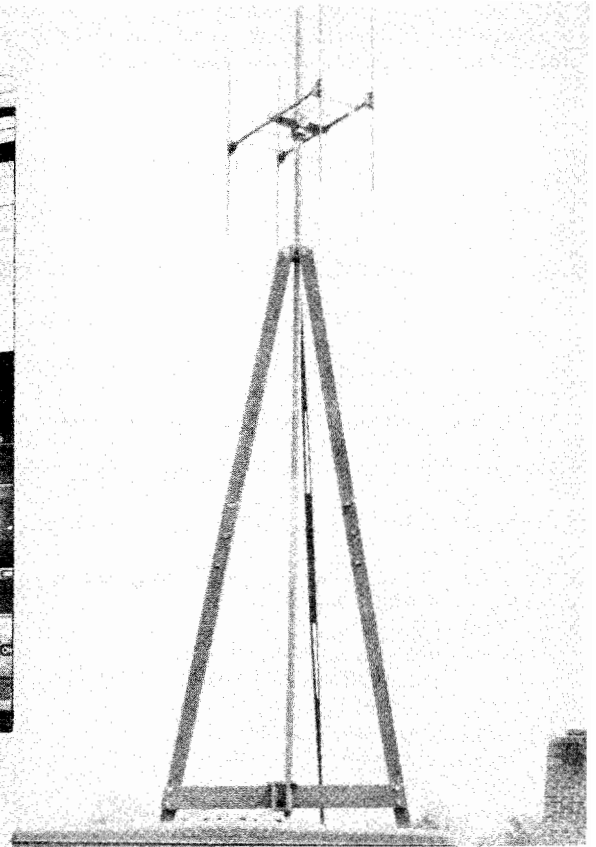

Figure 30 - Antenna Equipment RC-83 - Showing Upper Part of Antenna System Mounted on Truck K-53



COMPONENTS

- |  |   |
|--|---|
| <ul style="list-style-type: none"> <li>1 Dipole Set. Each set includes:                             <ul style="list-style-type: none"> <li>8 Rod, 28 in. with plug in each end.</li> <li>8 Rod, 23 in. with plug in each end.</li> <li>8 Rod, 21 in. with plug in each end.</li> </ul> </li> <li>1 Antenna Guide and Break Assembly</li> <li>1 Antenna Frame Assembly (H Frame)</li> <li>1 Coaxial Cable Connector (JB-45 to Coupler Assembly) 16 in. with Plug PL-P173 on each end.</li> <li>1 Coupler Assembly (Top for Sense Rod)</li> <li>1 Dial Assembly</li> <li>1 Disc Assembly, to operate sense switch</li> <li>1 Drive Shaft Assembly (18 ft With Sense Rod and Transmission Line)</li> <li>1 Handwheel Assembly</li> <li>1 Index Bracket Assembly</li> <li>1 Index, Dial (Cursor)</li> <li>1 Junction Box JB-45-A (Mounted on Table)</li> <li>1 Swivel Assembly (Stop for Coupler)</li> </ul> | <ul style="list-style-type: none"> <li>1 Telescope, Compass and spirit level assembled on holders, includes:                             <ul style="list-style-type: none"> <li>2 Level, Spirit, Stanley Tool Company, No. 34-4 or equal.</li> <li>1 Magnetic, Compass, Keuffel &amp; Esser No. 5600-1/2</li> <li>1 Magnetic, Compass, and spirit level holder</li> <li>1 Telescope, Model 438, 4 power, Lyman Gun Sight Corp., or equal</li> <li>1 Telescope Holder</li> </ul> </li> <li>1 Tripod Assemble, 8 pieces, includes the following, contained in cabinet on front wall:                             <ul style="list-style-type: none"> <li>2 SKF Bearings, Self-aligning</li> <li>1 Adapter</li> <li>2 Rain Caps, Rubber</li> <li>5 Wing Bolts, 1-3/8 in.</li> <li>3 Wing Bolts, 2 in.</li> <li>10 Wing Bolts, 2-1/2 in.</li> <li>4 Wing Bolts, 3-1/4 in.</li> </ul> </li> </ul> |
|--|---|

RESTRICTED

**RADIO RECEIVING AND TRANSMITTING  
EQUIPMENT RC-84**

Radio receiving and transmitting equipment RC-84 is part of mobile homing and direction finding station SCR-566. This equipment is used for air-ground, ground-air communication.

Power for this equipment is supplied by battery-driven dynamotor units PE-94 and PE-100.

**COMPONENTS**

- 1 Cable, Coaxial, (JB-45 to BC-639) with plug on each end
- 1 Cable, Coaxial, (JB-45 to trans-receiver) with plug on each end
- 1 Cable, Shielded (JB-29 to BC-602) with plug on each end
- 1 Cable, Shielded (JB-29 to trans-receiver) with plug on each end
- 1 Cable, Shielded (PE-94 to PN-5) with plug on each end
- 1 Cable, Shielded (Pe-94 to trans-receiver) with plug on each end
- 1 Cable, Shielded (JB-29 to PN-5) with plug on one end
- 1 Cable, Shielded (JB-29 to PN-5) with plug on one end
- 1 Cable, 4 ft 2-conductor, with plug (male)
- 1 Control Unit RM-18
- 1 Desk Panel PN-1
- 1 Dynamotor Unit PE-94 Includes:
  - 4 Shock Mounts, Lord No. 150-PH-10, or equal
- 1 Dynamotor Unit PE-100
- 1 Frame, FM-39
- 1 Fuse Panel, PN-5
- 1 Harness, Wiring
- 1 Junction Box JB-29
- 1 Mounting FT-314 (For Trans-Receiver)
- 1 Mounting FT-316 (For PE-94 & JB-29)
- 1 Radio Control Unit BC-602
- 1 Radio Receiver BC-639
- 1 Support for Harness
- 1 Switch, Power for PE-100, in metal case
- 1 Trans-Receiver Unit; shock mounted; consists of
  - 1 Radio Receiver BC-624
  - 1 Radio Transmitter BC-625
  - 1 Rack FT-244
  - 1 Case CS-80

All units are complete with tubes and spare tubes.

Figure 31 -  
Radio Receiving and Transmitting  
Equipment RC-84-A - Front View

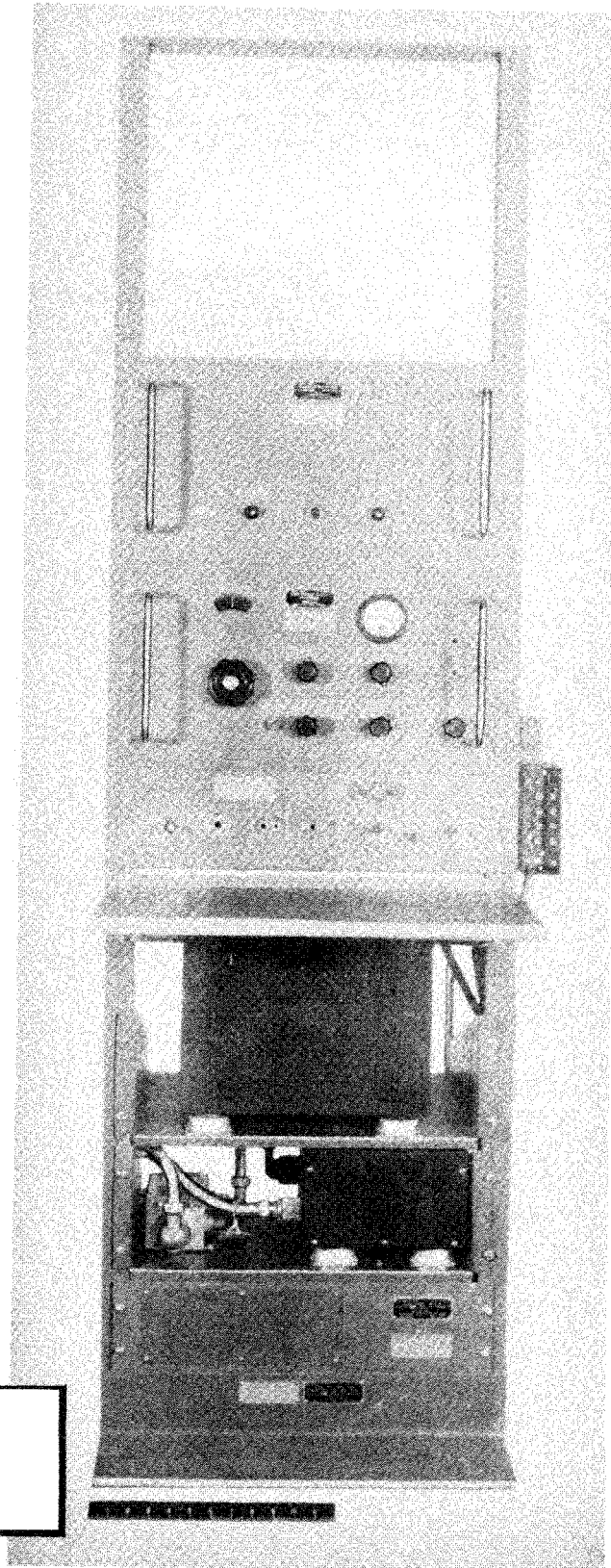

**RADIO RECEIVING EQUIPMENT RC-86**

Radio receiving equipment RC-86 is used in conjunction with the receiving vehicle of radio set SCR-567. This equipment is designed to operate on frequencies between 99 and 156 megacycles.

Power for this receiving equipment is supplied by either commercial power or power unit PE-99.

**COMPONENTS**

- 1 Amplifier BC-686
- 1 Control Unit RM-18
- 1 Desk Unit PN-1
- 1 Frame, FM-39
- 1 Fuse Panel PN-5
- 1 Radio Receiver BC-639
- 1 Rectifier RA-42

All units are complete with tubes and spare tubes.

Figure 32 - Receiving Equipment RC-86 - Rear View of Operator's Equipment

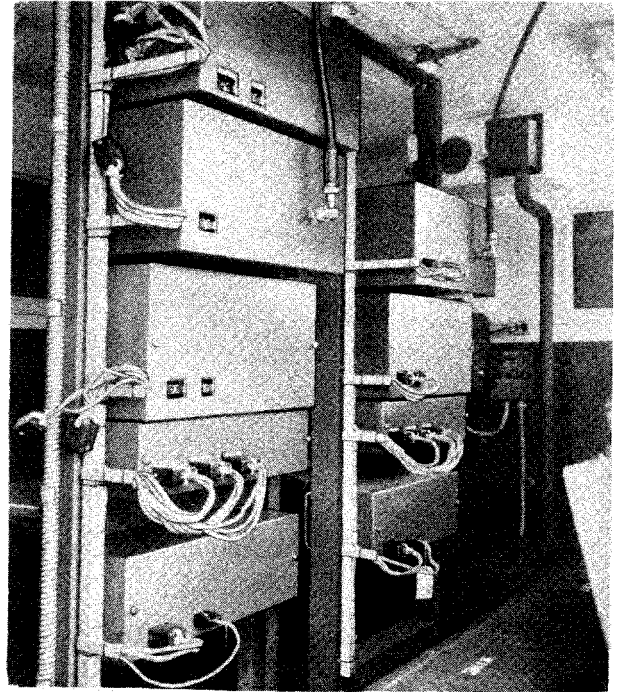

**OSCILLATOR TEST SET RC-93**

Oscillator and test equipment RC-93 is used to calibrate a high frequency DF receiver station electrically after the DF antenna has been aligned mechanically. Electrical calibration is necessary to permit error in

the electrical field surrounding the DF station to be measured. This error, known as site error, is detectable in a DF receiving station as a variation from the true bearing of the received signal. Usually the variation is very small. Large variation will interfere with proper operation of the system.

Power for this equipment is supplied by self-contained dry batteries.

**RADIO SETS USED WITH**

- SCR-564
- SCR-565
- SCR-566
- SCR-575
- SCR-645

**COMPONENTS**

- 1 Radio Transmitter BC-655 (Target) Includes:
  - 1 Antenna, Telescopic (8-5/16 in. to 33-1/2 in.)
  - 1 Battery, Dry cell, 1.5 volts, eveready No. 742
  - 2 Battery, Dry cell, 45 volts, eveready No. 738
- 1 Cover, Synthetic rubber (pliofilm or equal)
- 1 Tripod Ring, Keuffel & Esser No. 5127-C or equal
- 1 Tripod, Keuffel & Esser No. 5174

All units complete with tubes and spare tubes.

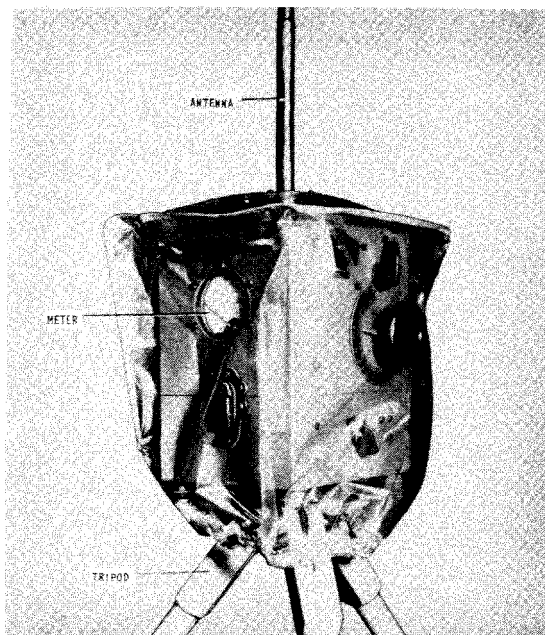

Figure 33 - Oscillator Test Set RC-93

**CONTROL EQUIPMENT RC-113**

Control equipment RC-113 consists of a standard frame FM-39 on which are mounted the relay units, jack panel, fuse panel, telephone distribution frame, line isolation panel and 12 eighty-terminal sockets for circuit connection.

Power for this equipment is supplied by power unit PE-99.

**RADIO SETS USED WITH**

SCR-572  
SCR-642

**COMPONENTS**

- 1 Frame, FM-39
- 1 Frame, FM-4J
- 1 Fuse Panel, PN-2
- 1 Fuse Panel, PN-3
- 1 Relay Unit, BC-687

Figure 34 - Control Equipment  
RC-113-A (Front Panel)

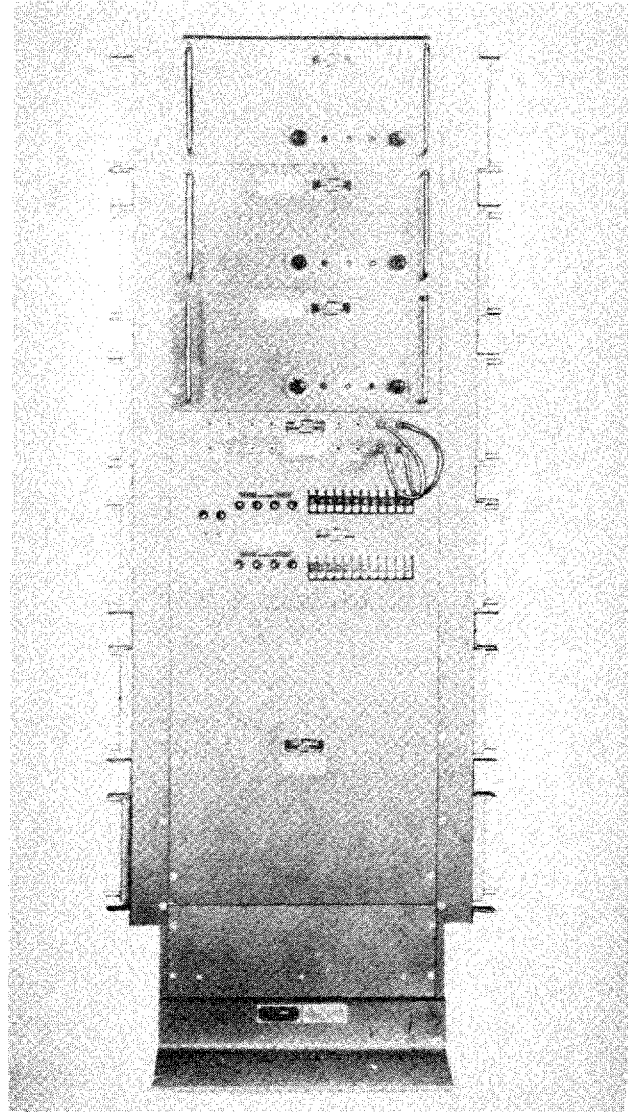

ANTENNA EQUIPMENT RC-153

Antenna equipment RC-153 is a direction finding antenna system designed to operate from 100 to 156 megacycles.

RADIO SETS USED WITH

SCR-575  
SCR-634

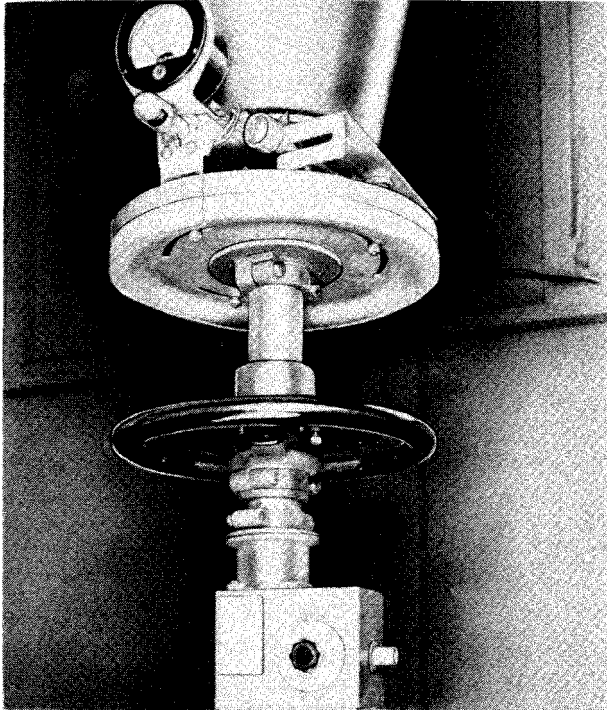
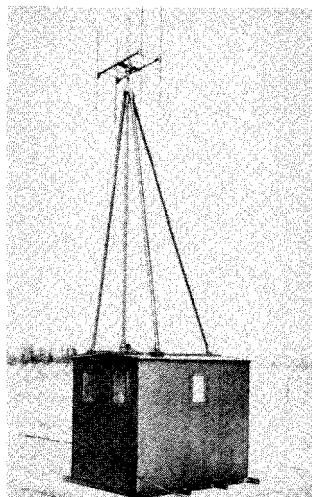

Figure 35 - Antenna Equipment RC-153-B - Part of Radio Set SCR-634-A - For Use With VHF Radio Equipment - Showing Method of Mounting Meter, Dial Lock, Azimuth Scale, Hand Wheel, and Coupling Unit



- COMPONENTS
- 1 Antenna Frame Assembly (H-Frame)
  - 1 Cable, Coaxial, coupler to JB-45
  - 1 Cap, Protective, lower end of drive shaft
  - 1 Catwalk and Fittings (On Top of Van Body)
  - 1 Catwalk Frame (Platform Over Cab)
  - 16 Dipole Rod, 28-in. 8 in use, 8 spare
  - 16 Dipole Rod, 23-in. 8 in use, 8 spare
  - 16 Dipole Rod, 21-in. 8 in use, 8 spare
  - 1 Drive Shaft (Upper)
  - 1 Drive Shaft and Cone Assembly, Includes:
    - 1 Bracket, Support for meter
    - 1 Bearing, Upper, SKF No. 1213, selfaligning, or equal
    - 1 Bearing, Lower, SKF No. 1211, selfaligning, or equal
    - 1 Bearing Flange (On Top of Van Body)
    - 1 Coupler Assembly
    - 1 Cone and Plate Assembly (Mounting)
    - 1 Disc Assembly (Sense Switch)
    - 1 Drive Shaft (Lower)
    - 1 Dial and Hub (Azimuth Scale)
    - 1 Dial Index (Cursor)
    - 1 Gear Assembly (Vernier Drive and Lock)
    - 1 Handwheel and Hub Assembly
    - 1 Swivel Assembly (Stop for Coupler)
    - 1 Meter, Weston Model 301, for sense indication, 0.1 ma. rect. type ac. or equal
    - 1 Resistor, 5000 ohm, 1 watt
  - 3 Hinge Fitting on wood block (support for tripod) one on each side (rear) and one in center (front) of van body top
  - 1 Hinge fitting (on hood of truck) to support antenna in horizontal position
  - 1 Steel Panel, Reinforcing for hood
  - 1 Switch, Push button, on table leg for sense indication
  - 1 Telescope, Compass and spirit level, assembled on holders, includes:
    - 2 Level, Stanley No. 34-4, or equal
    - 1 Compass, Magnetic, Keuffel & Esser No. 5600-1/2 or equal
    - 1 Compass and Level Holder
    - 1 Telescope, Lyman No. 438, or equal
    - 1 Telescope Holder
  - 1 Tripod, Upper bearing and support assembly, includes:
    - 1 Bearing upper, SKF No. 1213, selfaligning, or equal
  - 1 Tripod Leg
  - 2 Tripod Leg
  - 1 Tube, Canvas lined, under truck, for carrying drive shaft
- As Req Wire, Single conductor shielded, from RM-18 to meter

Figure 36 - Rear Three-quarter View - Showing Antenna Equipment RC-153-B Mounted on Shelter HO-34-A

RESTRICTED

RADIO RECEIVING EQUIPMENT RC-155

Radio receiving equipment RC-155 is designed to operate from 99 to 156 megacycles.

Power for this equipment is usually supplied by power unit PE-99.

RADIO SETS USED WITH

- Forward Relay Station SCR-567
- Forward Relay Station SCR-637
- Mobile Receiver Station SCR-574

COMPONENTS

- 1 Amplifier BC-686
- 1 Control Unit RM-18
- 1 Desk Unit PN-1
- 1 Frame, FM-39
- 1 Fuse Panel PN-5
- 1 Harness, Wiring
- 1 Radio Receiver BC-639
- 1 Rectifier RA-42
- 1 Relay Unit BC-685
- 1 Support

All units complete with tubes and spare tubes.



RADIO RECEIVING AND TRANSMITTING EQUIPMENT RC-165

Radio receiving and transmitting equipment RC-165 is designed to operate as ground to air communication equipment on a frequency range from 99 to 156 megacycles.

Power for this equipment is supplied by a battery-driven dynamotor unit PE-94.

RADIO SETS USED WITH

- D/F Homer and Fixer Station SCR-575
- D/F Homer and Fixer Station SCR-645

COMPONENTS

- 1 Cable, Coaxial, (JB-42 to trans-receiver) with plug on each end
- 1 Cable, Shielded, (JB-29 to BC-602) with plug on each end
- 1 Cable, Shielded, (JB-29 to trans-receiver) with plug on each end
- 1 Cable, Shielded, (PE-94 to PN-5) with plug on one end
- 1 Cable, Shielded, (PE-94 to trans-receiver) with plug on each end
- 1 Cable, Shielded, (JB-29 to PN-5) with plug on one end
- 1 Cable, Shielded, (JB-29 to PN-5) with plug on one end
- 1 Cable, 4 ft, 2-conductor, with plug (male)
- 1 Control Unit RM-18
- 1 Control Panel PN-25

- 1 Desk Unit PN-1
- 1 Dynamotor Unit PE-94, Includes:
  - 4 Shock Mounts, Lord No. 150-PH-10
- 1 Frame FM-39
- 1 Harness, Wiring
- 1 Junction Box JB-29
- 1 Mounting FT-314 (For Trans-Receiver)
- 1 Mounting FT-316 (PE-94 and JB-29)
- 1 Relay Unit BC-687
- 1 Support, For wiring
- 1 Trans-Receiver Unit, Consists of:
  - 1 Radio Transmitter BC-624
  - 1 Radio Receiver BC-625
  - 1 Case CS-80
  - 1 Rack FT-244

All units are complete with tubes and spare tubes.



RADIO RECEIVING EQUIPMENT RC-168

Radio receiving equipment RC-168 is designed to receive radio signals from 99 to 156 megacycles.

Power for this equipment is usually supplied by power unit PE-99.

RADIO SETS USED WITH

- Forward relay station SCR-637
- Receiver station SCR-644

COMPONENTS

- 1 Amplifier BC-686
- 1 Control Unit RM-18
- 1 Control Unit RM-23
- 1 Desk Unit PN-1
- 1 Frame FM-39
- 1 Fuse Panel PN-5
- 1 Harness, Wiring
- 1 Radio Receiver BC-639
- 1 Rectifier RA-42
- 1 Relay Unit BC-685
- 1 Support

All units are complete with tubes and spare tubes.

ANTENNA EQUIPMENT RC-213

Antenna equipment RC-213 is an antenna system designed for direction finding operations from 100 to 156 megacycles.

RADIO SETS USED WITH

SCR-645

COMPONENTS

- 1 Antenna Frame Assembly (H-Frame)
- 1 Baseboard
- 1 Cable, Coaxial, coupler to JB-45
- 1 Cap, Protective, for lower end of drive shaft
- 16 Dipole Rod, 28-in., 8 in use, 8 spare
- 16 Dipole Rod, 23-in., 8 in use, 8 spare
- 16 Dipole Rod, 21-in., 8 in use, 8 spare
- 1 Drive Shaft (Upper)
- 1 Drive Shaft and Cone Assembly, Modified for installation in tower TR-17 includes:
  - 1 Bracket, Support for meter
  - 1 Bearing, Upper, SKF No. 1211, selfaligning, or equal
  - 1 Bearing, Lower, SKF No. 1211, selfaligning, or equal
  - 1 Bearing Flange
  - 1 Coupler Assembly
  - 1 Cone and Plate Assembly (Mounting)
  - 1 Disc Assembly (Sense Switch)
  - 1 Drive Shaft (Lower)
  - 1 Dial and Hub (Azimuth Scale)
  - 1 Dial Index (Cursor)
  - 1 Gear Assembly (Vernier Drive and Lock)
  - 1 Handwheel and Hub Assembly
  - 1 Swivel Assembly (Stop for Coupler)
  - 1 Meter, Weston Model 301, for sense indications, 0.1 ma., rect. type ac., or equal.
  - 1 Resistor, 5000-ohm, 1-watt
- 1 Mounting Assembly, Upper cone, includes:
  - 1 Base Board
  - 1 Cone
  - 1 Upper Bearing Assembly
  - 1 Lower Bearing Assembly
- 1 Switch, Push button, on table leg for sense indication
- 1 Telescope, Compass and spirit level, assembled on holders, includes:
  - 2 Level, Stanley No. 34-4 or equal
  - 1 Compass, Magnetic, Keuffel & Esser No. 5600-1/2 or eqgal
  - 1 Compass and Level Holder
  - 1 Telescope, Lyman No. 438 or equal
  - 1 Telescope Holder

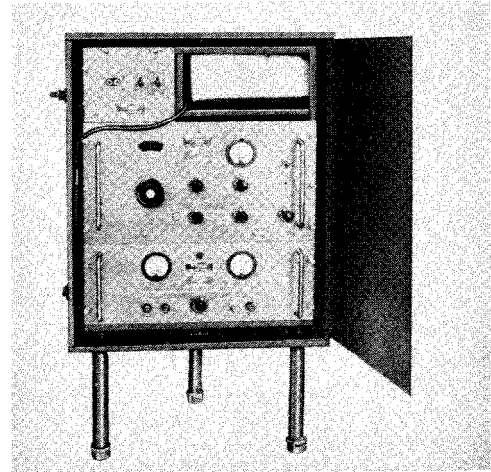

Figure 37 - Radio Receiving Equipment RC-229-A - Part of Radio Set SCR-634-A - Front View - Showing Control Unit RM-38-A, Radio Receiver BC-639-A, and Rectifier RA-42-A, Installed in Cabinet

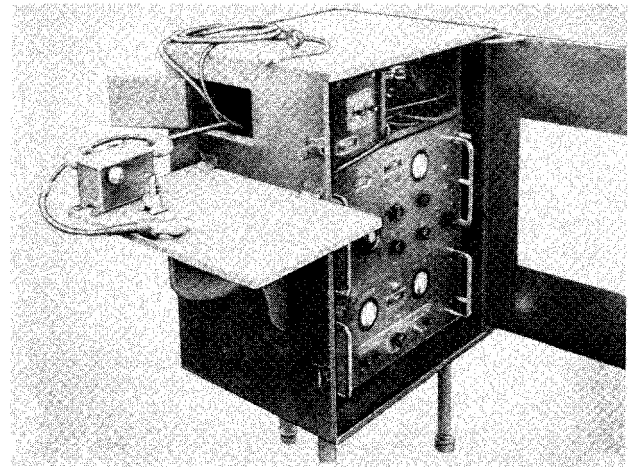

Figure 38 - Radio Receiving Equipment RC-229-A - Part of Radio set SCR-634-A - Front 3/4 View - Showing Junction Box JB-45-A Mounted on Shelf and equipment Shock Mounted Inside of Cabinet

RADIO RECEIVING EQUIPMENT RC-229

This equipment is designed to operate on frequencies between 99 and 156 megacycles. When used in conjunction with an Adcock direction finding antenna this receiving equipment is effectively used for direction finding operations.

Power is supplied by power unit PE-214.

RADIO SETS USED WITH

SCR-634

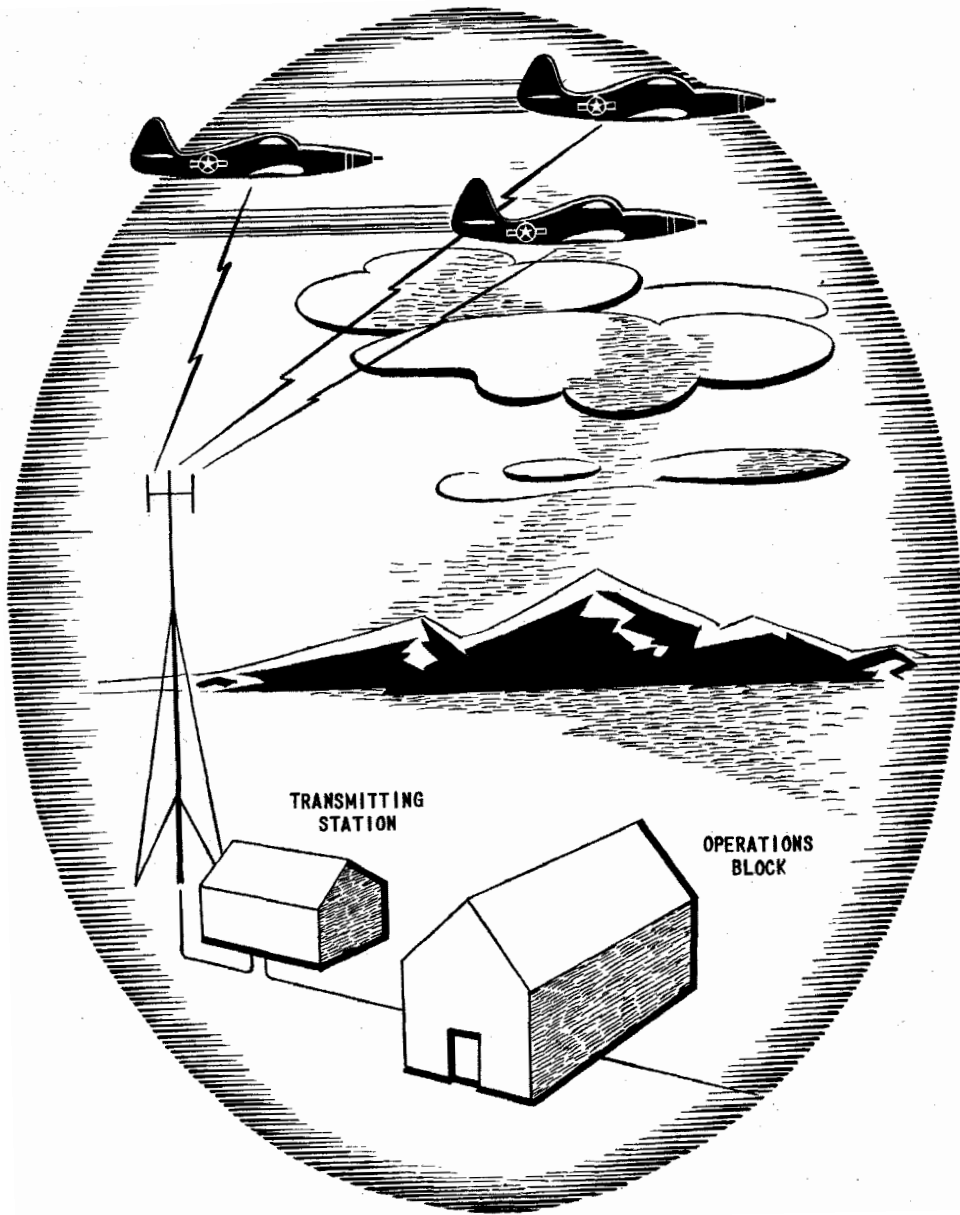





**Illustrations and Descriptions  
Of Major Components**





RESTRICTED

AMPLIFIER BC-686

Amplifier BC-686 is a unit of the relay receiving station and is used for amplification of telephone signals.

RADIO SETS USED WITH

- SCR-567
- SCR-637
- SCR-574
- SCR-644

Equipment used in conjunction with amplifier BC-686:

- 1 Telephone Handset, 100 ohms DC microphone resistance, 300 ohms at 1000 cycles ear-phone impedance.
- 1 Pair of Headphones, 2000 ohms impedance
- 3 Type VT-201 Vacuum Tubes
- 1 Fully Charged 24-Volt DC Power Source (Storage Battery)

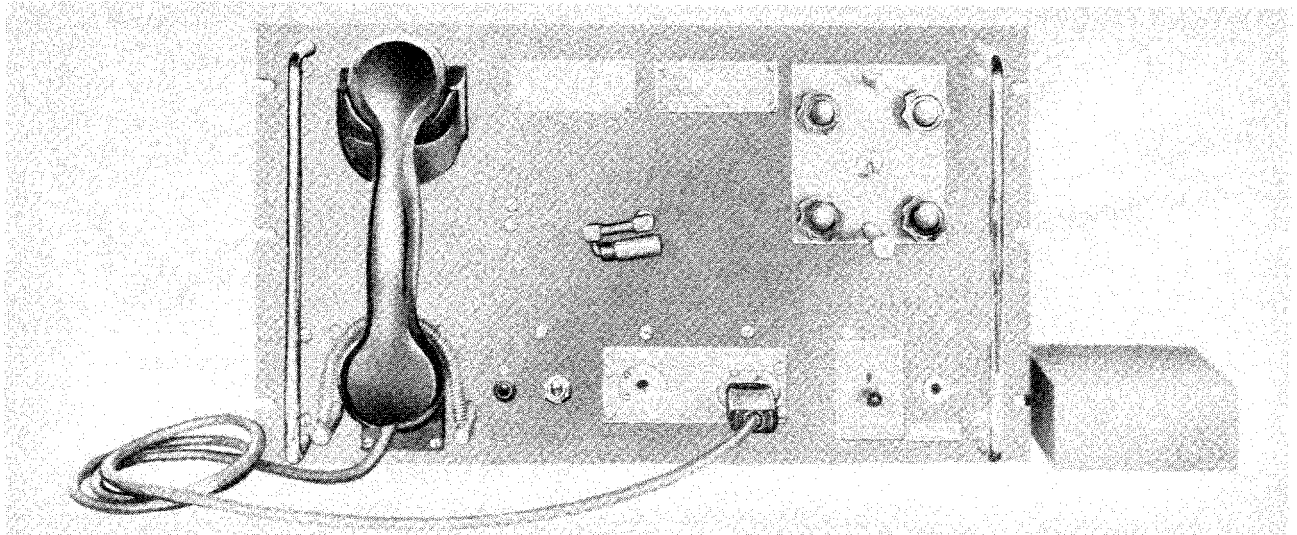

Figure 39 - Amplifier BC-686-A - Front View - Showing Handset TS-14-A

AMPLIFIER PANEL PN-8

Amplifier panel PN-8 is a part of radio transmitter BC-640. It is the final amplifier stage and supplies approximately 50 watts of power to a concentric

cable with a characteristic impedance of 75 ohms. Two type VT-204 tubes are operated class C.

One type VT-94 tube is also included in the amplifier to provide a rectified monitor signal.

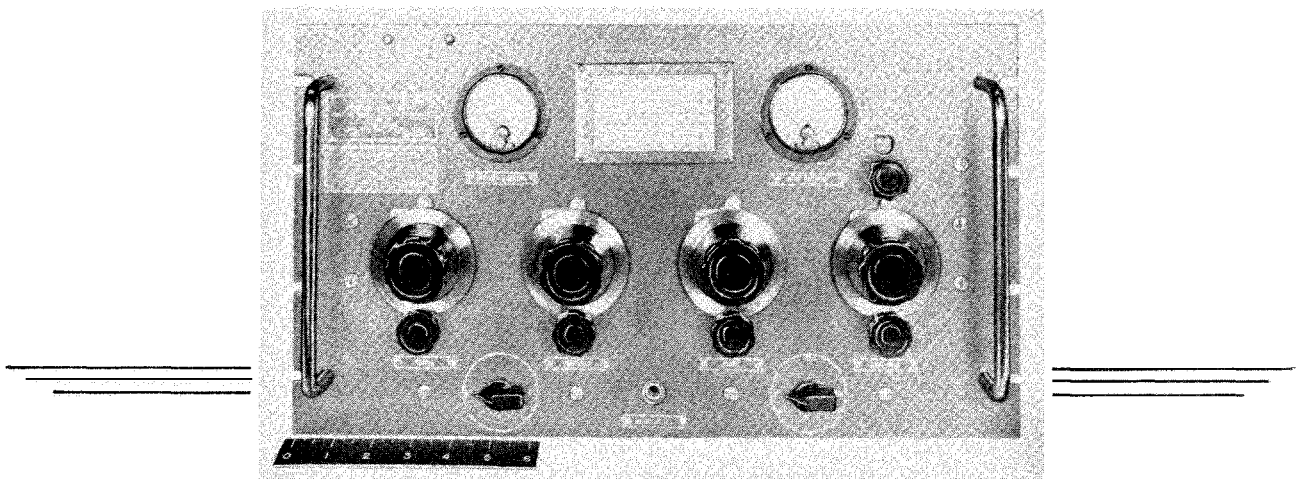

Figure 40 - Amplifier Panel PN-8-A - Part of Radio Transmitter BC-640-A - Front View

RESTRICTED

ANTENNA EQUIPMENT AN-94-A AND  
COAXIAL CABLE WC-549

Antenna mast MA-7-A. This radiator is fed by means of 75-foot coaxial cable, WC-549.

Antenna equipment AN-94-A is a vertical radiator designed to operate on frequencies from 99 to 156 megacycles. This equipment is mounted on an-

RADIO SETS USED WITH  
SCR-624

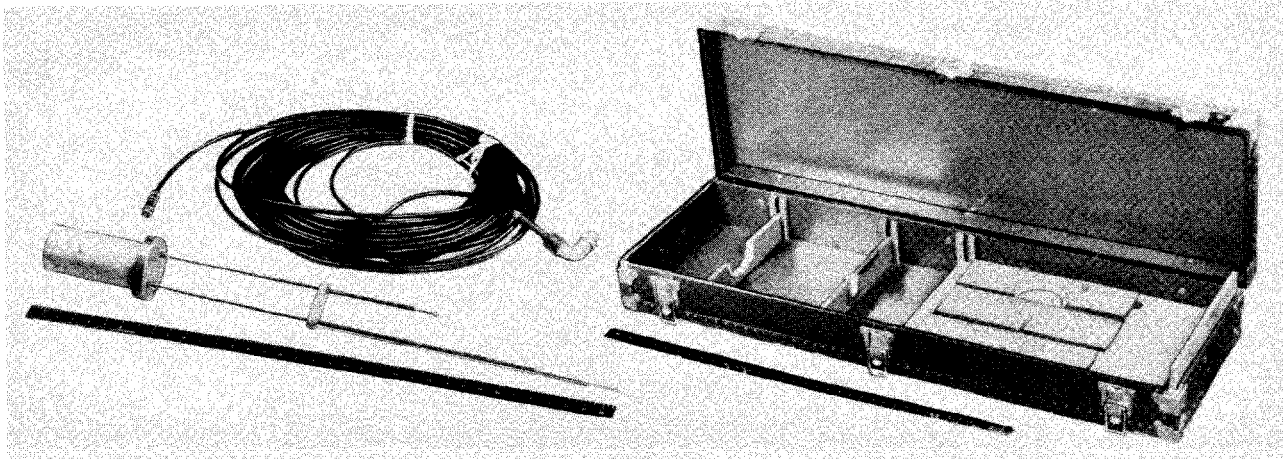

Figure 41 - Antenna AN-94-A and 75-Foot Coaxial Cable WC-549; Chest CH-170 Unpacked Part of Radio Set SCR-624-T1



ANTENNA MAST AN-56

Ninety-foot antenna AN-56 is a tubular steel mast capable of easy assembly and erection in the field by six men. It is designed to support the antenna dipoles and coaxial cable for two antenna equipments RC-81 on a horizontal crossarm or truss fastened to the top of the mast. The mast may be raised or lowered, disassembled, repacked, and shipped with 100 percent of its parts reusable for erection at a new location. The mast, when erected, will withstand high wind velocities and adverse weather conditions.

One antenna AN-56, 90 foot antenna mast packed in the following boxes or crates:

DESCRIPTION	OVERALL SIZE IN INCHES	WEIGHT
Box No. 1 (crate)	188-3/4 x 44-1/4 x 25-1/2	2635 lb
Box No. 2	102-1/4 x 68 x 23-1/2	1067 lb
Box No. 3	140-1/2 x 13-3/4 x 5-7/8	190 lb
Box No. 4	34-3/4 x 27-1/4 x 19-7/8	515 lb
Box No. 5*	35-3/4 x 35-3/4 x 19-7/8	434 lb

\*When maul and winch are included, the gross weight is 554 pounds. Two of each 8 masts have mauls and winches.

Antenna equipment RC-81, two for each mast.

RADIO SETS USED WITH

SCR-562	SCR-633
SCR-563	SCR-643
SCR-632	SCR-644

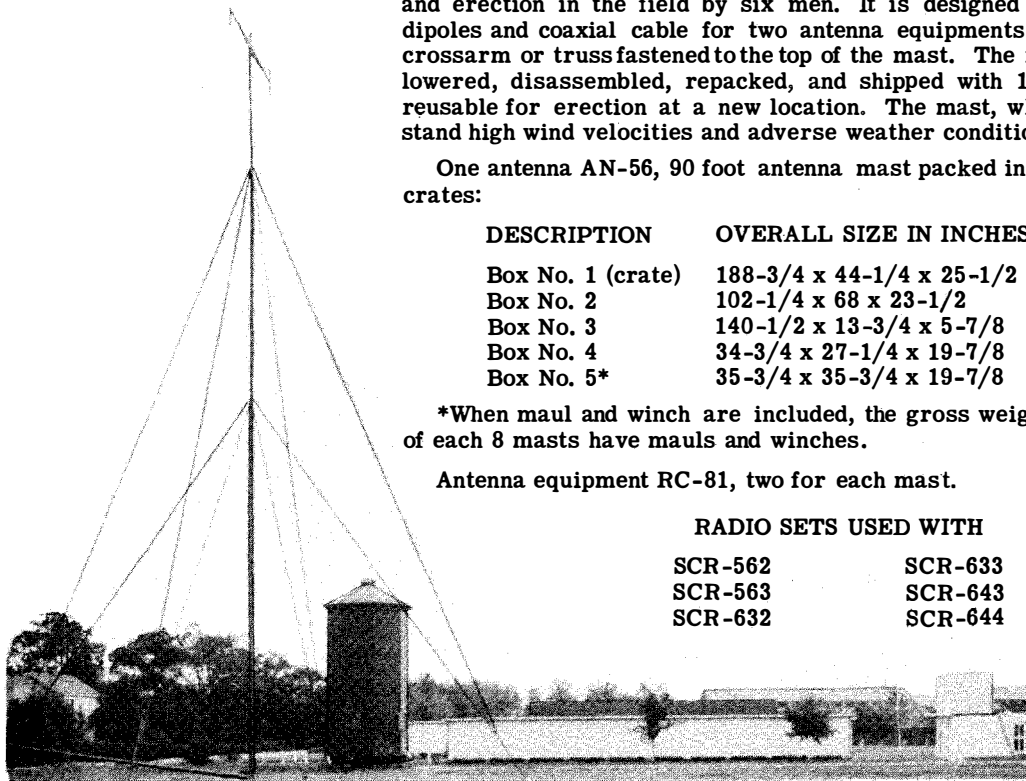

Figure - 42 -  
Antenna AN-56-A

RESTRICTED

ANTENNA MAST AN-57

Fifty-foot antenna AN-57 is a tubular steel mast capable of easy assembly and erection in the field by four men. It is designed to support the antenna dipoles and coaxial cables for two antenna equipments RC-81 on a horizontal crossarm or truss fastened to the top of the mast. The mast may be raised or lowered, disassembled, repacked, and shipped with 100 percent of its parts reusable for erection at a new location. The mast, when erected, will withstand high wind velocities and adverse weather conditions.

Two antenna AN-57, 50-foot antenna masts packed for export shipment in the following boxes:

DESCRIPTION	OVERALL SIZE IN INCHES	WEIGHT
Box No. 1	147-1/8 x 44 x 30	2330#
Box No. 2	83-5/8 x 37-3/4 x 19-1/4	490#
Box No. 3	83-5/8 x 37-3/4 x 19-1/4	490#
Box No. 4	36-5/8 x 32-1/4 x 19-1/4	490#
Box No. 5	36-5/8 x 32-1/4 x 19-1/4	430#
Box No. 6	37-7/8 x 23-1/4 x 19-1/4	275#
Box No. 7	37-7/8 x 24-1/4 x 19-1/4	275#
Box No. 8	139-7/8 x 15-1/4 x 9	241#

RADIO SETS USED WITH

- SCR-567
- SCR-632
- SCR-633
- SCR-643
- SCR-644

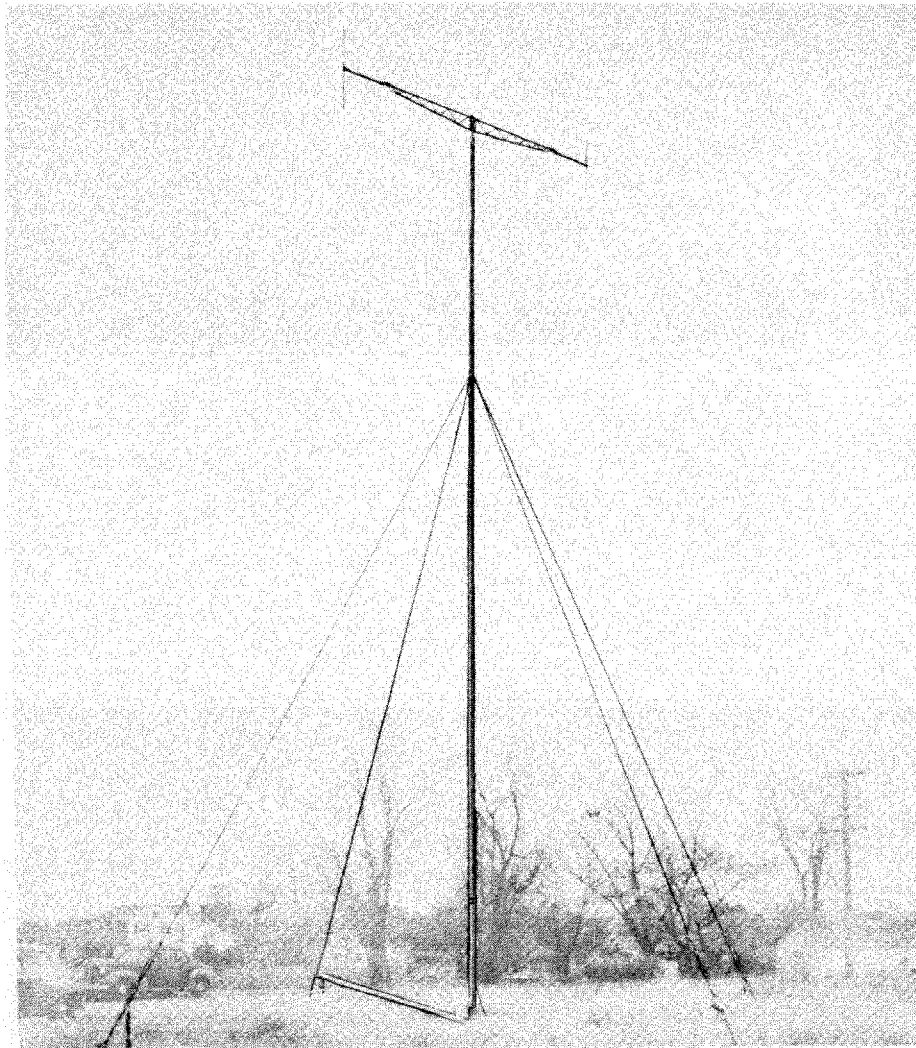

Figure 43 - Antenna AN-57-A - Assembled

RESTRICTED

ANTENNA MAST, MA-7-A

Fifty-foot plywood antenna mast MA-7-A is used to mount a voltage fed half-wave antenna AN-94.

RADIO SETS USED WITH

SCR-624

Figure 44 - Antenna Mast MA-7-A Crated for Shipment; Part of Radio Set SCR-624-A

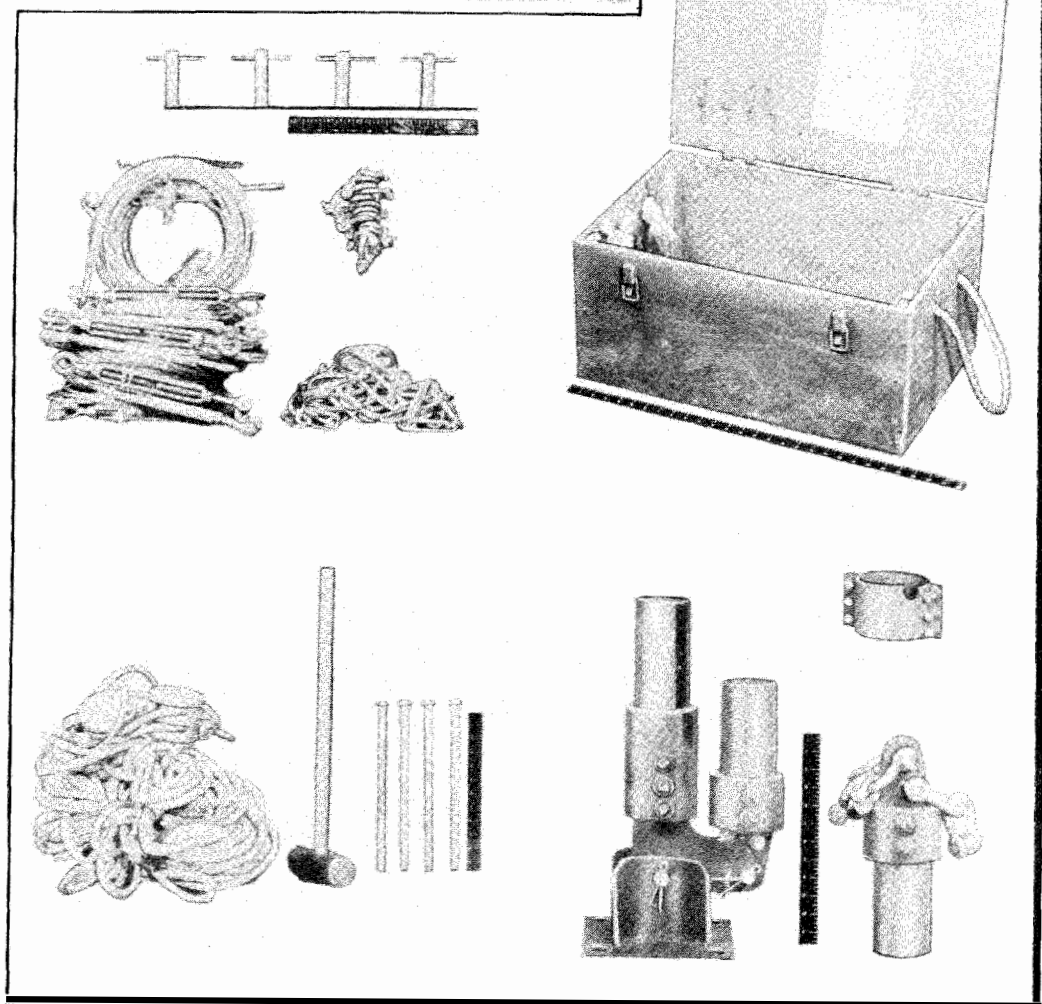
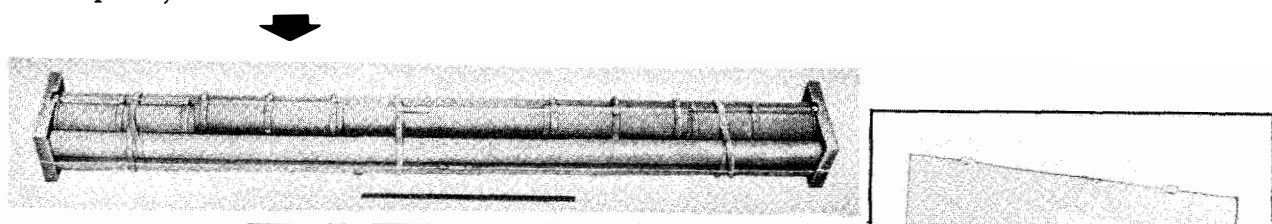

Figure 45 - Stay Box for Antenna Mast MA-7-A, Unpacked; Part of Radio Set SCR-624-T1

RESTRICTED

BATTERY CHARGER AND CHARGER PANEL

Battery charger General Electric Model 6RB33B1 is a 60 cycle, 115 volt tungar rectifier employing tube type General Electric tungar No. 189048.

This charger has a maximum capacity of 6 batteries.

The charger panel assembly serves as a fuse panel and provides an easy method of connecting a bank of

batteries from the operating to the charging position or vice versa.

RADIO SETS USED WITH

- |         |         |
|---------|---------|
| SCR-561 | SCR-573 |
| SCR-565 | SCR-637 |
| SCR-566 | SCR-642 |
| SCR-567 | SCR-644 |
| SCR-572 | SCR-645 |

COMPONENTS (CHARGER)

- 1 Battery Charger G.E. 6RB33B1
- 1 Cord, Two conductor, rubber covered with male plug attached.
- 1 Fuse, Plug type, 15 ampere
- 3 Tube, G.E., tungar 189048

COMPONENTS (CHARGER PANEL)

- 1 Fuse, Plug type, 10 amp. NEC Standard
- 1 Fuse, Plug type, 15 amp. NEC Standard
- 2 Fuse, Plug type, 20 amp. NEC Standard
- 1 Fusetron, Plug type, delayed action, 20 ampere, Bussman No. 720
- 1 Fusetron, Plug type, delayed action, 30 ampere, Bussman No. 730.
- 5 Switch, Toggle, double-pole-double-throw, Cuttler-Hammer No. 8700, without luminous tip.

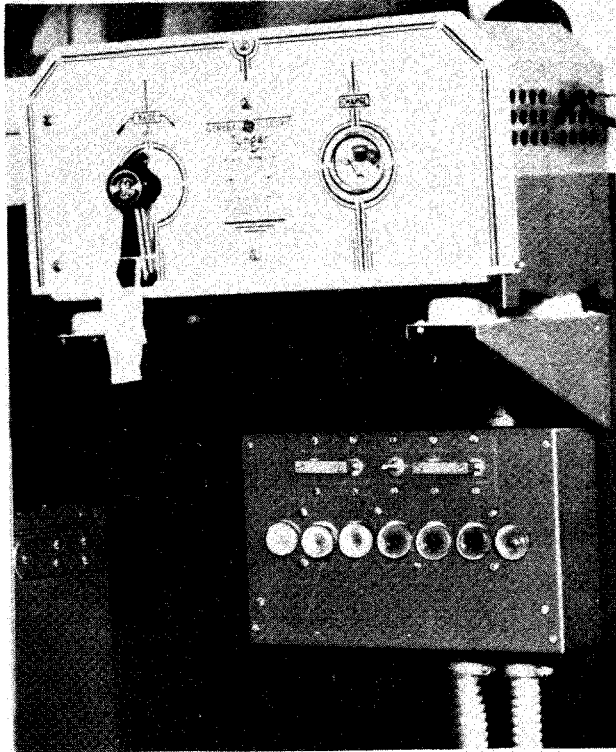

Figure 46 - Battery and Charger Panel

BUZZER, BZ-8

Buzzer BZ-8 is used to give an audible indication that a station is being called.

It is mounted on a full size panel so that it can be placed in a standard frame at any station where the use of a buzzer is considered necessary.

The size of the panel is 19 x 5-7/32 x 2-1/2 inches and the weight is 5 pounds.

RADIO SETS USED WITH

- |         |         |
|---------|---------|
| SCR-561 | SCR-565 |
| SCR-562 | SCR-632 |
| SCR-563 | SCR-573 |
|         | SCR-643 |

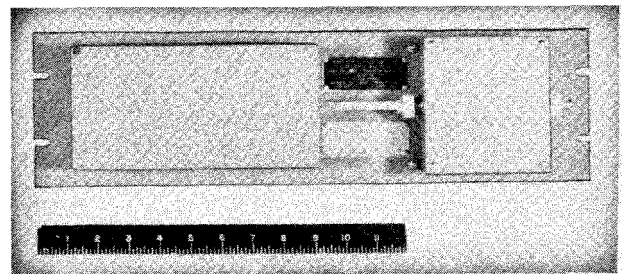

Figure 47 - Buzzer BZ-8-A - Front View

COMMUNICATION PANEL (RECEIVER STATION)

The receiver station communication panel is used as a terminal board for telephone lines and is located on the right side of trailer K-35 in which is mounted receiver station SCR-563.

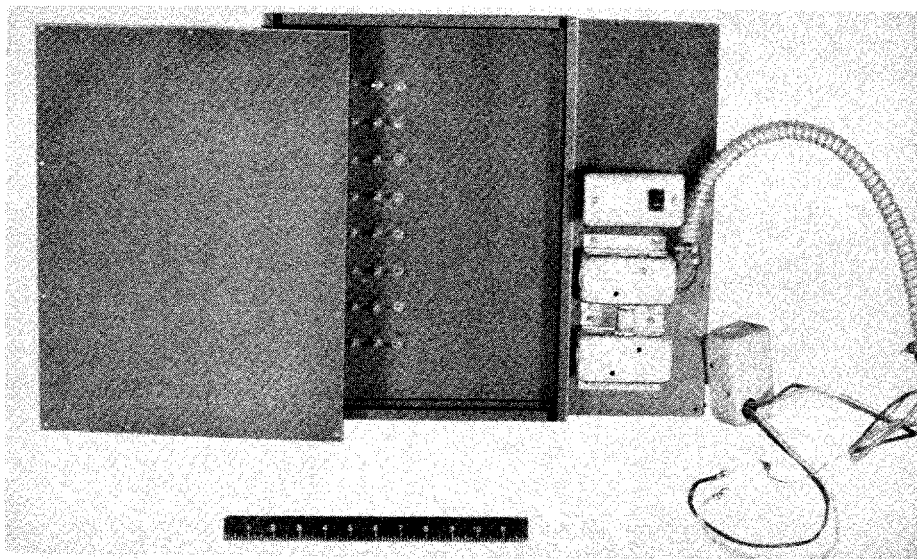

Figure 48 - Receiver Station Communication Panel - Rear View

★  
COMMUNICATION PANEL (TRANSMITTER STATION)

The transmitter station communication panel is used as a terminal board for the telephone lines and is located on the right side of trailer K-35 in which is mounted transmitter station SCR-562. A BX cable containing wires to connect to all the pins on the terminal board runs from the terminal boards along the wall and ceiling to the equipment racks.

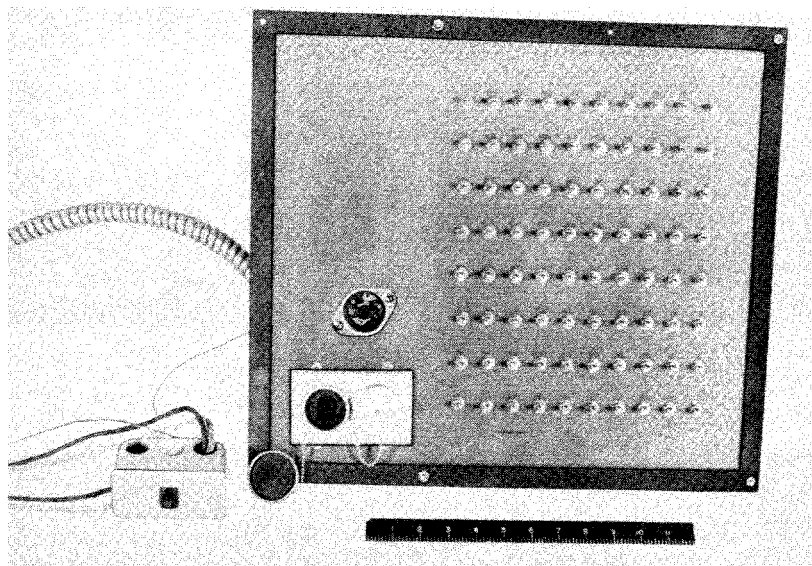

Figure 49 - Transmitter Station Communication Panel - Front View





**CONTROL BOX BC-602**

Radio control box BC-602 is used in conjunction with radio set SCR-522 which includes radio receiver BC-624 and radio transmitter BC-625.

Five red push buttons are the means by which one of four frequency channels may be selected and by which the power is turned on or off. These five push buttons are so interconnected that not more than one can be in the depressed position at any time.

With the T-R-REM switch in the T position, the transmitter is placed in continuous operation; in the R position the receiver is placed in continuous operation; and in the REM position, transmit-receive control is transferred to a press-to-talk push button located at a remote point from control box BC-602.

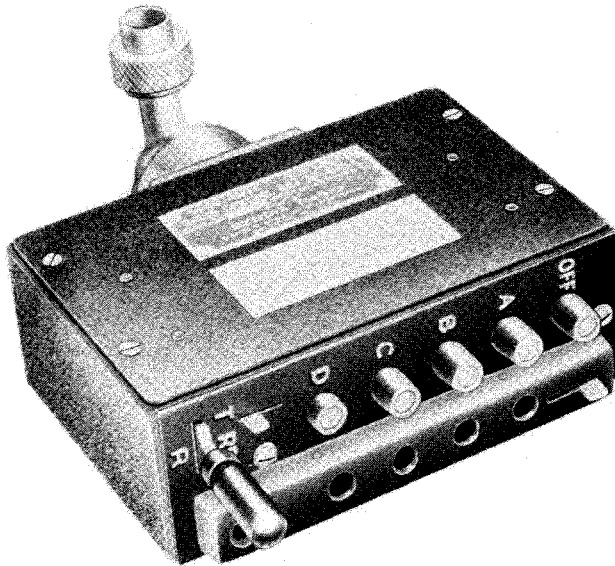

Figure 50 - Radio Control Box BC-602-A - Assembled

**RADIO SETS USED WITH**

SCR-566  
SCR-575

SCR-645  
SCR-624

**CONTROL BOX BC-1176-A, BC-1171-A**

Control Boxes BC-1176-A and BC-1171-A are used for remotely controlling Radio Set SCR-624.

Figure 51 - Remote Control Points for Radio Set SCR-624-T1, Control Box BC-1171-A on Left, Control Box BC-1176-A on Right

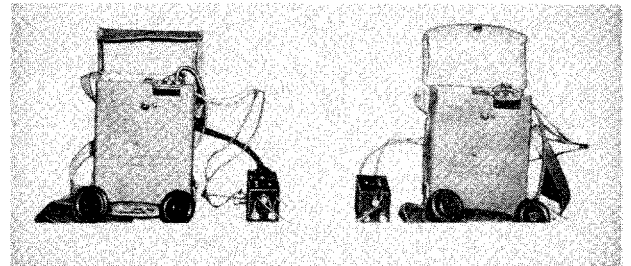

**CONTROL PANEL PN-11**

Control panel PN-11 is a part of radio transmitter BC-640. It contains ON and OFF switches for the plate and filament supplies for all the components of the radio transmitter. The high voltage contactor and two control relays are mounted on the chassis. A

24-volt d-c power supply from a metallic rectifier is also included on the panel to provide low d-c voltage for operating the relays in the transmitter and remote signal lights. All fuses for the transmitter with the exception of the line fuses are located on the back of this panel.

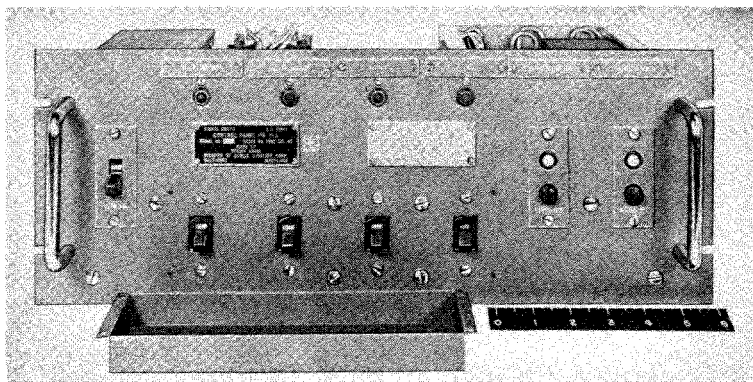

Figure 52 - Control Panel PN-11-A - Part of Radio Transmitter BC-640-A - Front View - Showing Switch Cover Removed

RESTRICTED

CONTROL UNIT RM-18

Control unit RM-18 is used to provide facilities for switching a telephone line among as many as three re-

ceivers and three transmitters. One control unit RM-18 is normally located at mobile DF station (SCR-566) and two control units RM-18 are located at the advance relay stations.

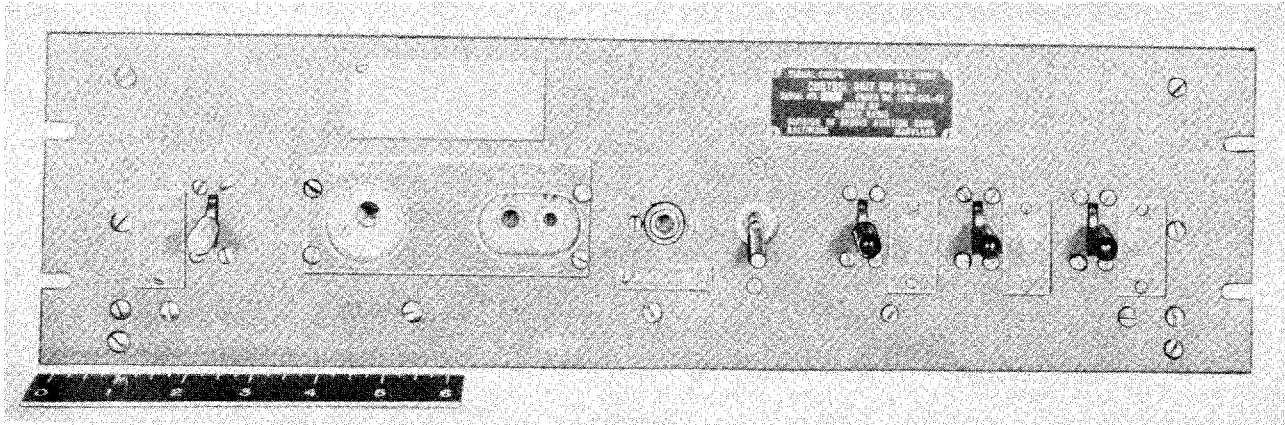

Figure 53 - Control Unit RM-18-A - Front View

COMPONENTS, DIMENSIONS, AND WEIGHTS

The following major components are used with each control unit RM-18 installation:

DESCRIPTION	OVERALL SIZE IN INCHES	WEIGHT
1 Control Unit RM-18	19 x 5 x 9	15.75#
1 Head-set HS-23	-----	0.75#
1 Microphone T-48	-----	---

POWER REQUIREMENTS

Control unit RM-18 requires 12 volts or 24 volts dc for operation, obtained from the station storage battery.

RADIO SETS USED WITH

- SCR-566
- SCR-567
- SCR-574
- SCR-575
- SCR-637
- SCR-644
- SCR-645



**RESTRICTED**

**CONTROL UNIT RM-23**

Control Unit RM-23 is located in a receiver station to provide intercommunication between this station and various other stations in the fighter control net system. This unit is also used for monitoring the outputs of radio receiver BC-639.

1 Head Set HS-23	-----	0.75 lb
1 Microphone T-48	-----	---
1 Frame FM-39	72 x 20-1/2 x 3	121 lb
1 Desk Unit PN-1	20-1/2 x 12-1/4 x 3-1/2	8 lb
1 Buzzer BZ-8	19 x 5-7/32 x 2-1/2	5 lb

**COMPONENTS, DIMENSIONS, AND WEIGHTS**

The following major components are used with each control unit RM-23 installation:

DESCRIPTION	OVERALL SIZE IN INCHES	WEIGHT
1 Control Unit RM-23	19 x 5 x 8-1/2	18.25 lb
5 Patch Cord CC-70 (3-conductor)	15	---

**POWER REQUIREMENTS**

All the power required for the operation of this unit including buzzer BZ-8 is supplied from the control unit RM-25.

**RADIO SETS USED WITH**

SCR-563  
SCR-633  
SCR-644

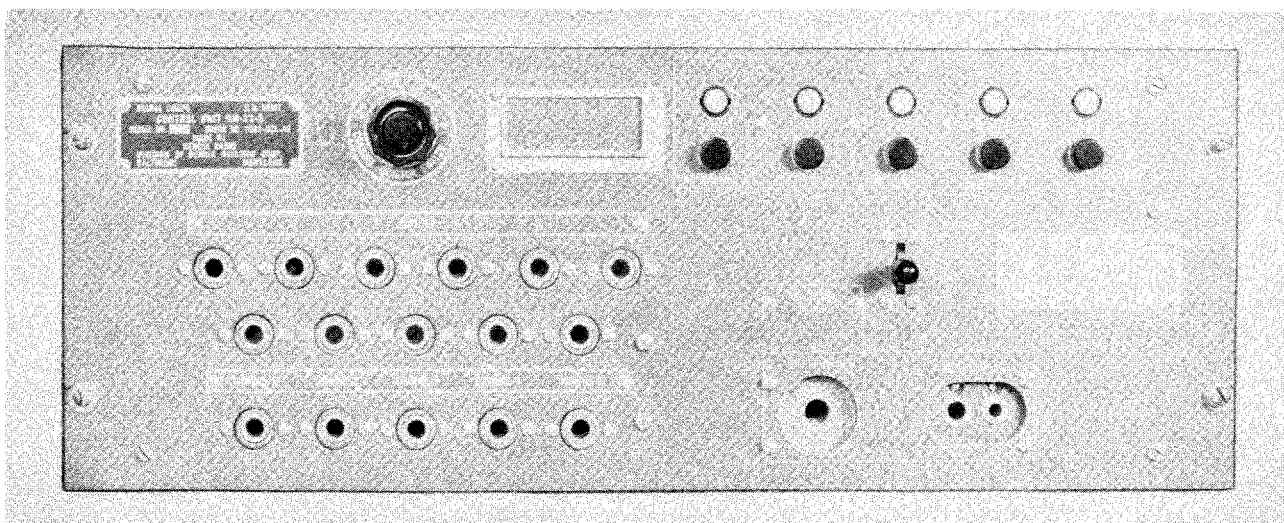

Figure 54 - Control Unit RM-23-A - Front View



**CONTROL UNIT RM-24**

Control unit RM-24 is located in DF sector (homing) station (SCR-564) to provide facilities for intercommunication between the various stations of the control net systems.

1 Microphone T-48	-----	---
1 Frame FM-39	72 x 20-1/2 x 3	121 lb
1 Desk Unit PN-1	20-1/2 x 12-1/4 x 3-1/2	8 lb
1 Buzzer BZ-8	19 x 5-7/32 x 2-1/2	5 lb
1 Fuse Panel PN-15	19 x 5 x 5	24 lb
1 Socket Panel PN-4	19 x 10-1/2 x 2-1/4	7 lb

**COMPONENTS, DIMENSIONS, AND WEIGHTS**

The following major components are used with each control unit RM-24 installation:

DESCRIPTION	OVERALL SIZE IN INCHES	WEIGHT
1 Control Unit RM-24	19 x 5 x 11	20.75 lb
1 Handset TS-14	-----	1.25 lb
1 Head Set HS-23	-----	0.75 lb

**POWER REQUIREMENTS**

All the power required for the operation of this unit, including buzzer BZ-8 is supplied from the control unit RM-25.

**RADIO SETS USED WITH**

SCR-564

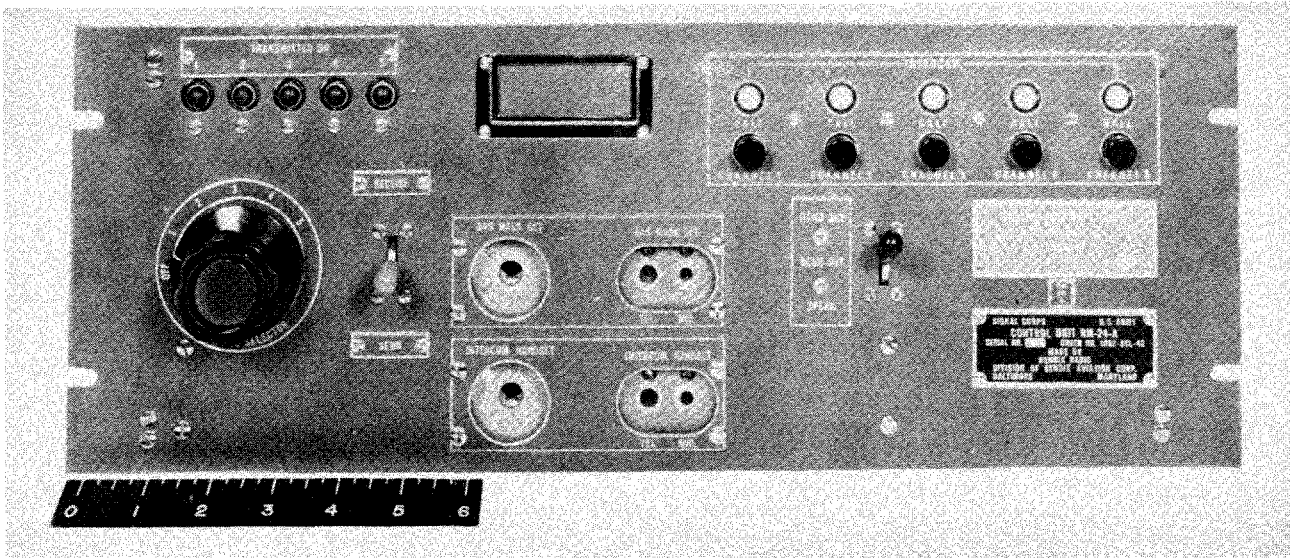

Figure 55 - Control Unit RM-24-A - Front View



**CONTROL UNIT RM-25**

Control unit RM-25 is located at the operations block (control center). This unit provides telephone communication between the operations block and various other stations in the fighter control net system.

**COMPONENTS, DIMENSIONS, AND WEIGHTS**

The following major components are used with each control unit RM-25 installation:

DESCRIPTION	OVERALL SIZE IN INCHES	WEIGHT
1 Control Unit RM-25	20 x 11-1/4 x 11-1/4	44 lb
1 Head set HS-23	-----	0.75 lb
1 Microphone T-48	-----	---
1 Buzzer BZ-8	19 x 5-7/32 x 2-1/2	5 lb

1 50-Pair Cable Ter- 6-1/4 x 3-1/4 x 4  
minated in Plug  
PL-201 (Cable  
Connector) 3 lb

**POWER REQUIREMENTS**

Control unit RM-25 requires power from a 24-volt storage battery. This 24-volt d-c source is obtained from the operations block battery which is connected to control unit RM-25 through distribution panel BD-102. All other power is supplied by the associated equipment with which the control unit RM-25 operates.

**RADIO SETS USED WITH**

- SCR-561
- SCR-562
- SCR-642

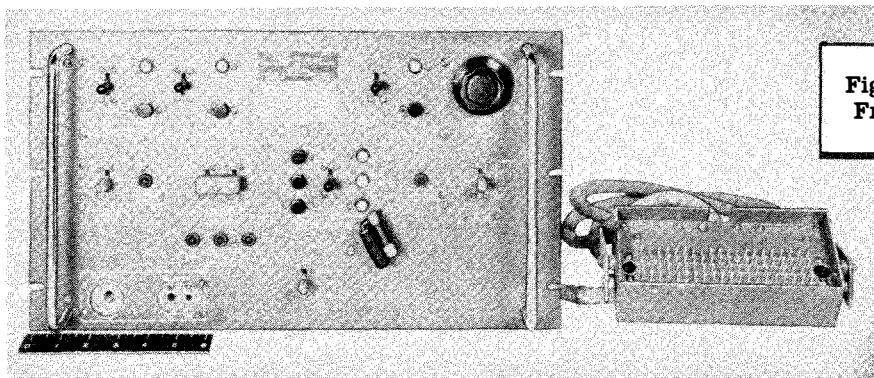

Figure 56 - Control Unit RM-25-A - Front View - Showing Plug PL-198



**CONTROL UNIT RM-26**

Control unit RM-26 is located at the operations block to provide facilities for the following:

Telephone intercommunication between the control unit RM-26 and the control units RM-25 located in the four silence cabins.

To control the local receiver and transmitter station from the RM-26 unit.

To control the relay receiver and transmitter station from the RM-26 unit.

**COMPONENTS, DIMENSIONS, AND WEIGHTS**

The following major components are used with each control unit RM-26 installation:

DESCRIPTION	OVERALL SIZE IN INCHES	WEIGHT
1 Control Unit RM-26	11-7/8 x 8-1/4 x 9-3/4	20 lb
1 Handset TS-14	-----	---

**POWER REQUIREMENTS**

Control unit RM-26 requires power from a 24-volt d-c source. This power is obtained from the operations block 24-volt storage battery. All other power is applied by the associated equipment with which the control unit RM-26 operates.

**RADIO SETS USED WITH**

SCR-561  
SCR-572  
SCR-642

**CONTROL UNIT RM-27**

Control unit RM-27 is located in the transmitter stations to provide telephone intercommunication between transmitter station and various other stations in the fighter control net system.

**COMPONENTS, DIMENSIONS, AND WEIGHTS**

The following major components are used with each control unit RM-27 installation:

DESCRIPTION	OVERALL SIZE IN INCHES	WEIGHT
1 Control Unit RM-27	19 x 11-3/8 x 10-1/2	29 lb
5 Patch Cord CC-70 (3-Conductor With Plug PL-198)	15	---
1 Head Set HS-23 Equipped With Plug PL-68	-----	0.75 lb
3 Radio Transmitter BC-640	72-1/32 x 21-1/8 x 20	515.50 lb
1 Microphone T-48	-----	---
1 Frame FM-39	72 x 20-1/2 x 3	121 lb
1 Desk Unit PN-1	20-1/2 x 2-1/4 x 3-1/2	8 lb
1 Buzzer BZ-8	19 x 5-7/32 x 2-1/2	5 lb

**POWER REQUIREMENTS**

All the power required for the operation of this unit is supplied from the control unit RM-25.

**RADIO SETS USED WITH**

SCR-562  
SCR-573  
SCR-643

Figure 57 - Control Unit RM-26-A -  
Assembled - Showing Plug PL-198

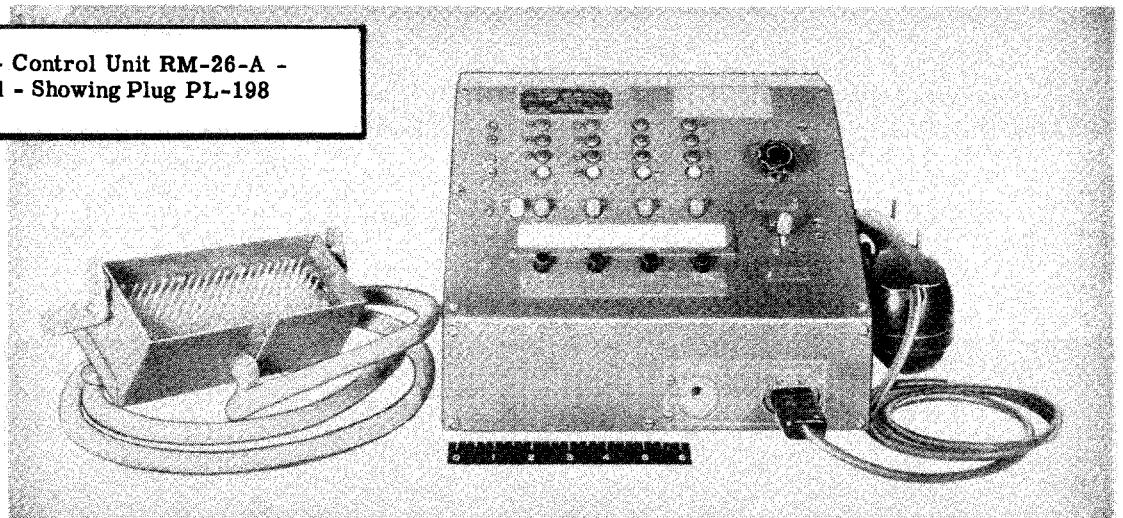

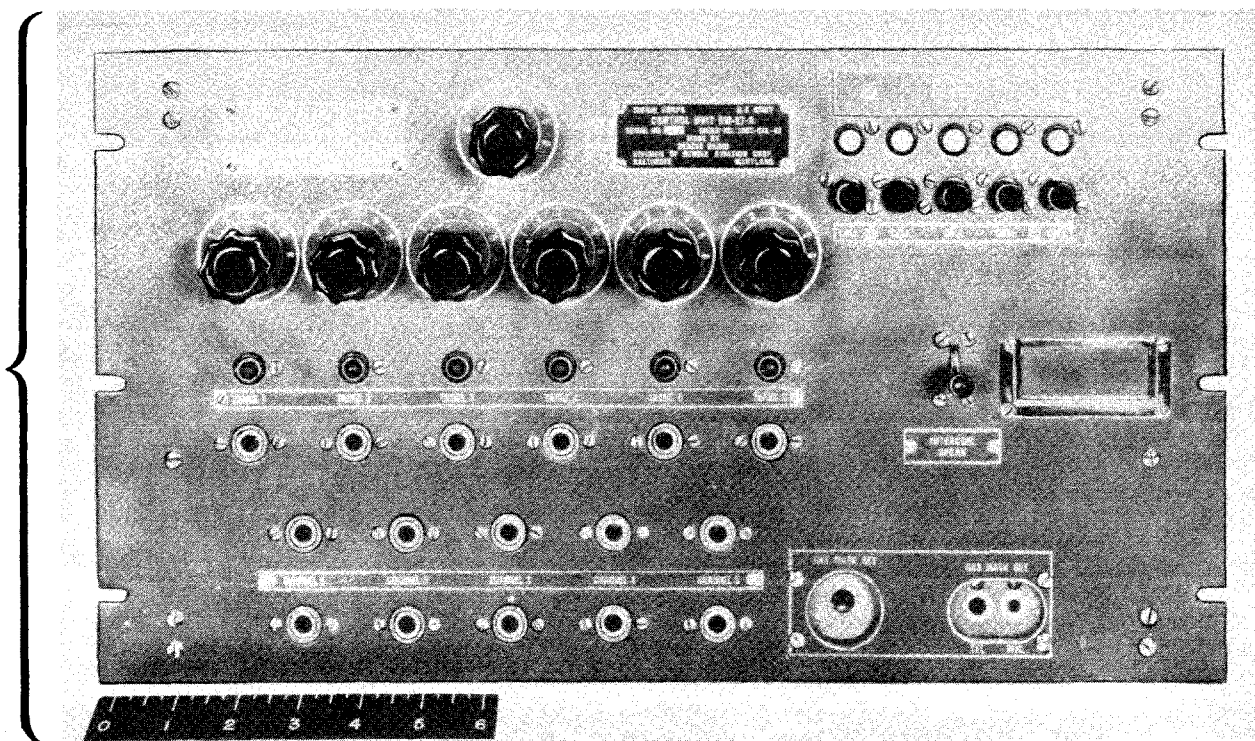

Figure 58 - Control Unit RM-27-A - Front View



**CONTROL UNIT RM-28**

Control unit RM-28 is located at the operations block to provide facilities for the following:

Telephone intercommunication from the operations block to various other stations in the fighter control net system.

Monitoring the relay station lines and the distribution of these lines.

Monitoring the outputs of the five local receivers on each of the five local channels.

**COMPONENTS, DIMENSIONS, AND WEIGHTS**

The following major components are used with each control unit RM-28 installation:

DESCRIPTION	OVERALL SIZE IN INCHES	WEIGHT
1 Control Unit RM-28	14-1/2 x 7-1/2 x 12-1/2	35 lb
1 Handset TS-14	- - - - -	1 lb
10 Patch Cords CC-70	- - - - -	- - -
1 Head Set HS-23	- - - - -	0.75 lb
1 Microphone T-48	- - - - -	- - -

**POWER REQUIREMENTS**

Control unit RM-28 requires power from a 24-volt d-c source. This power is obtained from the operations block 24-volt storage battery.

**RADIO SETS USED WITH**

- SCR-561
- SCR-572
- SCR-642

Figure 59 - Control Unit RM-28-A Monitor Panel - Showing Plug PL-198

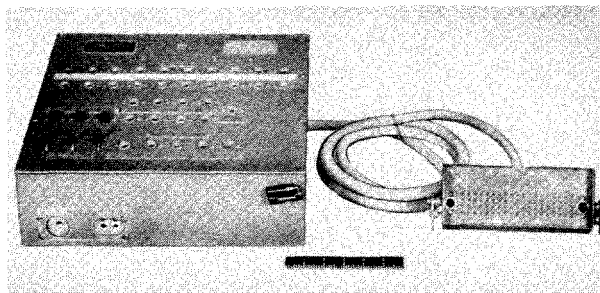

RESTRICTED

CONTROL UNIT RM-38

Control unit RM-38 is used as a switching circuit with radio direction finding station SCR-634.

Figure 60 - Control Unit RM-38-A - Front View

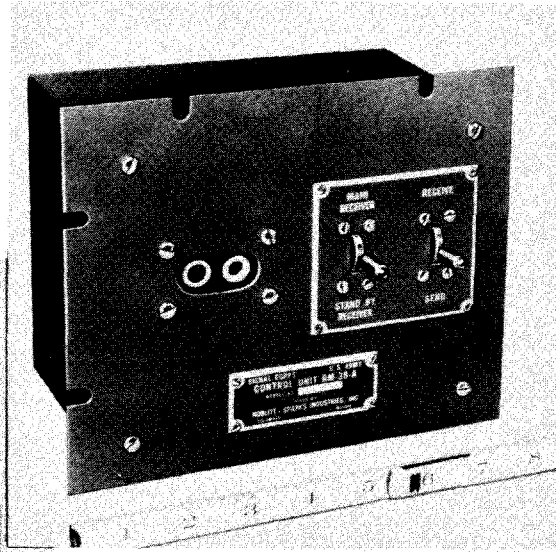
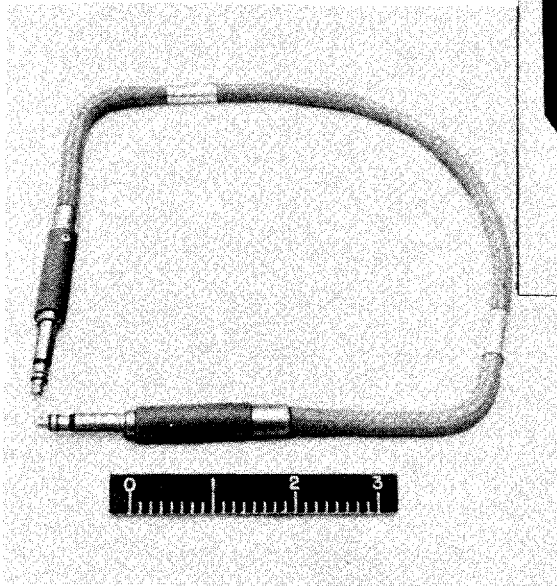

★ ★ ★

Figure 61 - Cord CC-70 - For Use with VHF Radio Equipment

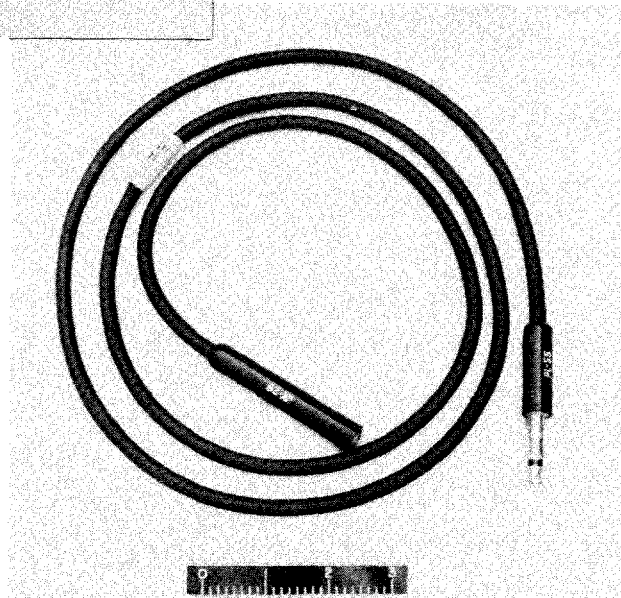

Figure 62 - Cord CD-307-A - For Use with Headset HS-23 and HS-33

★

RESTRICTED

RESTRICTED

### CRYSTAL UNIT DC-11-A

This crystal unit is used in the transmitting and receiving circuits of VHF equipment.

#### RADIO SETS USED WITH

SCR-562  
SCR-563  
SCR-564  
SCR-565  
SCR-566  
SCR-567  
SCR-573  
SCR-574  
SCR-575  
SCR-624  
SCR-632  
SCR-633  
SCR-634  
SCR-637  
SCR-643  
SCR-644  
SCR-645

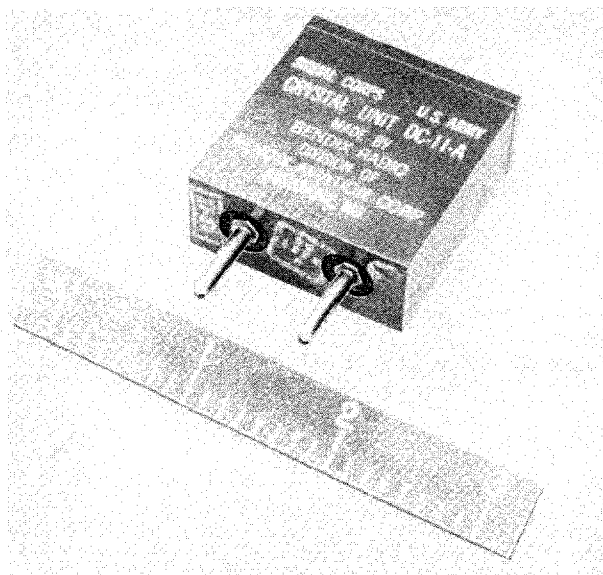

Figure 63 - Crystal Unit DC-11-A



### DISTRIBUTION PANEL BD-102

The distribution panel BD-102 is composed of a cabinet BE-78, frame FM-40, fuse panel PN-2, jack panel PN-3, and a relay unit BC-687 (it is possible to have as many as four relay units BC-687 in the BD-102 when it is necessary).

The cabinet BE-78 into which the distribution panel BD-102 is mounted has the following dimensions: 77-1/4 x 24-1/4 x 24 inches.

#### RADIO SETS USED WITH

SCR-561

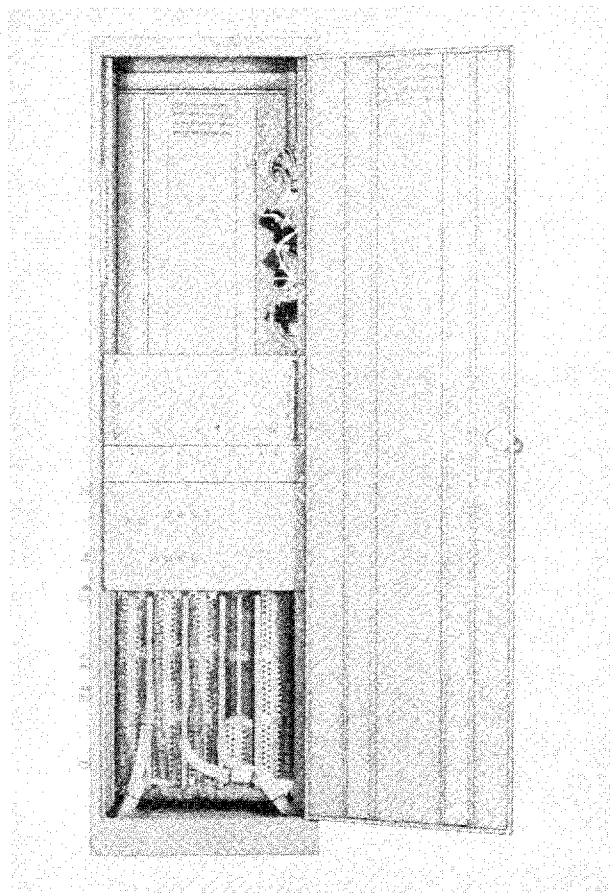

Figure 64 - Distribution Panel BD-102-A - Front View of Assembly - Showing Cabinet BE-78-A Door Open



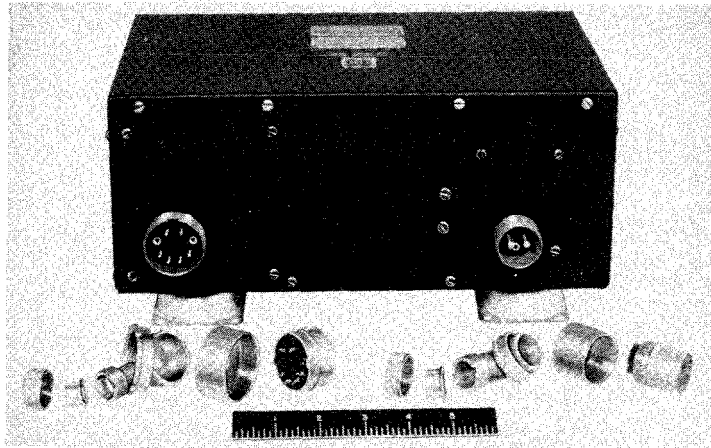

Figure 65 - Dynamotor Unit PE-94-A - Outlet Side - Showing Cable Connectors Unassembled

**DYNAMOTOR UNIT PE-94**

Dynamotor unit PE-94 is the power source for radio set SCR-522. A primary power source of 22 to 32 volts dc is required to operate this dynamotor unit. The output voltages are 300 volts, 150 volts and 13 volts dc.

The overall dimensions of the unit are 12-25/32 x 8-27/32 x 6-15/64 inches and the weight is 37 pounds.

**RADIO SETS USED WITH**

- SCR-566
- SCR-575
- SCR-645



**DYNAMOTOR UNIT PE-100**

Dynamotor unit PE-100 is a source of high voltage for the operation of frequency meter BC-638 or radio receiver BC-639. This unit uses a 6-volt storage battery as a primary power source. The output voltage is 210 volts dc.

closed by a dust proof cover which is held fast to the chassis by two thumbscrews at the rear of the unit.

The dynamotor is controlled from a separate switch located on a PN-6 switch panel included with each installation.

The size of the dynamotor unit PE-100 is 19 x 10-1/2 x 6 inches (overall) and weighs 24 pounds.

**RADIO SETS USED WITH**

- SCR-566
- SCR-567
- SCR-575
- SCR-645

Dynamotor unit PE-100 consists essentially of a dynamotor, hash filter and an audio filter. It is mounted on a shelf-type chassis with a front panel for rack mounting. Included on the panel are two fuses and an indicator lamp. Both fuses and lamp are replaceable from the front panel. The chassis is en-

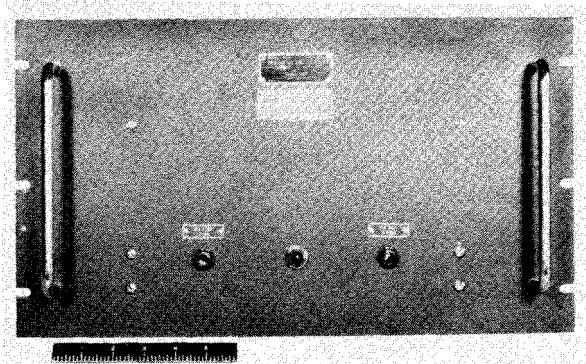

Figure 66 - Dynamotor Unit PE-100-A - Front View

FREQUENCY METER BC-638

Frequency meter BC-638 is a crystal controlled signal generator with a frequency range of 100 to 156 megacycles (3 meters to 1.92 meters). It is tone modulated approximately 30 percent at 1000 cycles.

COMPONENTS, DIMENSIONS, AND WEIGHTS

Frequency meter BC-638 consists of the following components:

DESCRIPTION	OVERALL SIZE IN INCHES	WEIGHT
1 Frequency Meter, BC-638 complete with a-c power supply, tubes, crystals, and antenna.	7 x 19 x 11-1/2	35 lb
1 Dynamotor Unit PE-100 - - - Described in a separate instruction book (for operation from 6-volt d-c source supply)		

POWER REQUIREMENTS

The primary power supply requirements are as follows:

- 110-120 volt, 50/60 cycle, single-phase ac, 30 watts
  - 220-250 volt, 50/60 cycle, single-phase ac, 30 watts
- Tap normally set for 220-volt operation.

Figure 67 - Frequency Meter BC-638-A - Operation Position

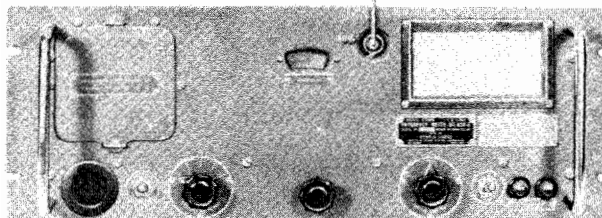

The frequency meter may also be operated from a 6-volt storage battery in connection with a PE-100 dynamotor unit.

RADIO SETS USED WITH

SCR-563	SCR-575
SCR-564	SCR-633
SCR-565	SCR-637
SCR-567	SCR-644
SCR-574	SCR-645

FUSE PANEL PN-2

Fuse panel PN-2 is located directly below jack panel PN-3 in distribution panel BD-102 which is part of the sector operations block SCR-561. All units in the operations block using battery power are connected to this panel for their power. The retard coils (used for supplying voltage to the intercommunication line between the silence cabins, sector D/F transmitting station and receiving station) and the 50-ohm resistors used in the forward relay station circuit of control unit RM-28 are also located on fuse panel PN-2.

The size of this unit is 19 x 19-1/2 x 10-1/4 inches and it weighs 18 pounds.

RADIO SETS USED WITH

SCR-561
SCR-572
SCR-642

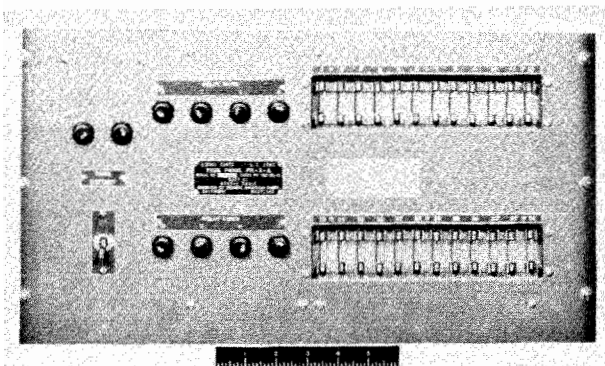

Figure 68 -  
Fuse Panel PN-2-A -  
Part of Distribution Panel BD-102-A -  
Front View

FUSE PANEL PN-5

Fuse panel PN-5 is used as a terminal board for interconnection purposes. This panel fits in the frame FM-39 and is located at the bottom of the frame.

Fuse panel PN-5 is 19 x 4-5/8 x 2-1/2 inches and it weighs 15 pounds.

This panel will be a part of the following:

- SCR-566
- SCR-567
- SCR-574
- SCR-575
- SCR-637
- SCR-644
- SCR-645

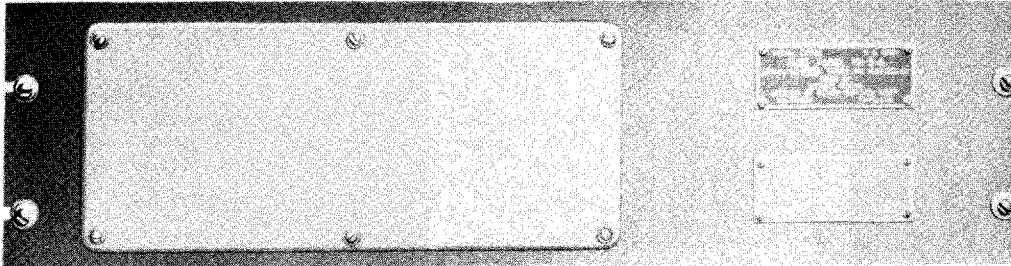
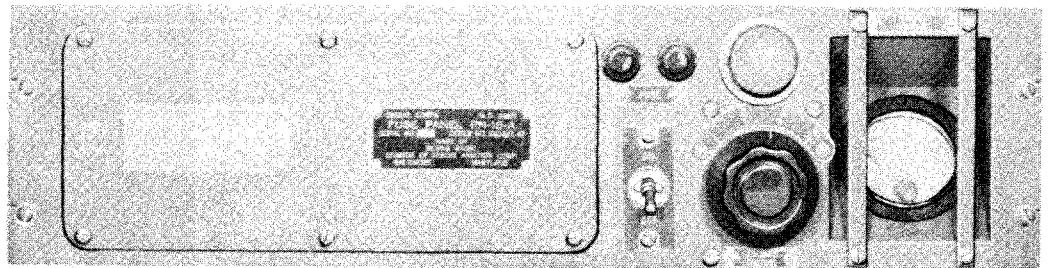

Figure 69 - Fuse Panel PN-5-A - Front View

Figure 70 - Fuse Panel PN-15-A - Front View



FUSE PANEL PN-15

Fuse panel PN-15 provides for connections to the telephone lines and power circuits. The telephone connections from the various terminals on fuse panel PN-15 are connected to those on the telephone connection block.

This panel also contains a transformer with which it is possible to maintain a constant voltage supply, even though the line voltage may fluctuate from 110 to

125 volts, or from 220 to 250 volts when used on a high voltage line.

Fuse panel PN-15 is 5 x 19 x 5 inches and its weight is 24 pounds.

RADIO SETS USED WITH

- |         |         |
|---------|---------|
| SCR-563 | SCR-575 |
| SCR-564 | SCR-633 |
| SCR-565 | SCR-637 |
| SCR-567 | SCR-644 |
| SCR-574 | SCR-645 |

HANDSET TS-14

This handset is used in conjunction with amplifier BC-686-A.

RADIO SETS USED WITH

- |         |         |         |
|---------|---------|---------|
| SCR-561 | SCR-572 | SCR-633 |
| SCR-562 | SCR-573 | SCR-637 |
| SCR-563 | SCR-574 | SCR-642 |
| SCR-564 | SCR-575 | SCR-643 |
| SCR-567 | SCR-632 | SCR-645 |

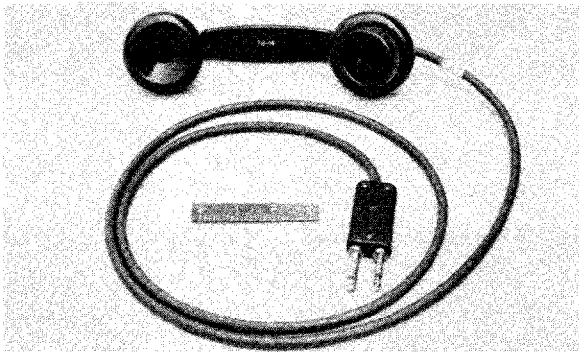

Figure 71 - Handset TS-14 with Cord CC-348 and Plug PL-204

HEAD SET HS-23

This head set is used for the reception of radio signals in a majority of VHF equipment.

RADIO SETS USED WITH

SCR-561	SCR-574
SCR-562	SCR-575
SCR-563	SCR-632
SCR-564	SCR-633
SCR-565	SCR-634
SCR-566	SCR-637
SCR-567	SCR-642
SCR-572	SCR-644
SCR-573	SCR-645

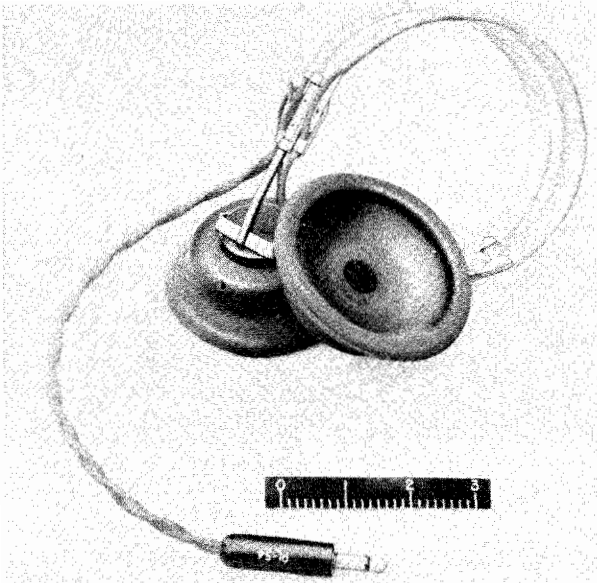

Figure 72 - Head Set HS-23 ★ ★ ★ ★

JACK BOX BC-629

JACK BOX BC-630

Jack boxes BC-629 and BC-630 are used with transmitter receiver BC-624 and BC-625.

In general, jack boxes BC-629 and BC-630 provide for the connections between the junction box and the microphone, head set and gun-switch terminals. A terminal strip inside the jack boxes is equipped with the necessary lugs, and complete wiring information is etched on the inside of the jack box covers.

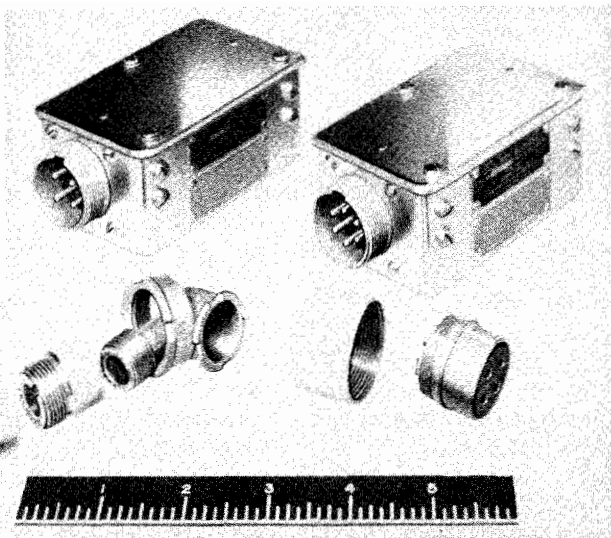

Figure 73 - Jack Box BC-629-A, Jack Box BC-630-A - Assembled - Showing Cable Connector Construction

wiring information is etched on the inside of the jack box cover.

Jack box BC-631 is very similar in construction to jack boxes BC-629 and BC-630.

The size of jack box BC-631 is 4-1/16 x 2-29/64 x 1-61/64 inches.

JACK BOX BC-631

Jack box BC-631 is used with transmitter-receiver combination BC-624 and BC-625. In general, jack box BC-631 provides for the connections between the junction box and the microphone, head set and gun-switch terminals. A terminal strip inside the jack box is equipped with the necessary lugs and complete

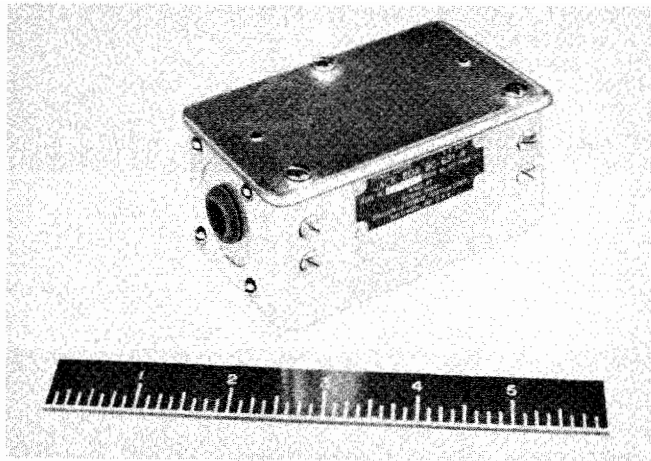

Figure 74 - Jack Box  
BC-631-A -  
Assembled

★  
JACK PANEL PN-3

Jack panel PN-3 is 19 x 8-3/4 x 3-1/2 inches and its weight is 5-1/2 pounds.

Jack panel PN-3 is a component of distribution panel BC-102 and is used in special cases when there is trouble in relay unit BC-687.

RADIO SETS USED WITH

SCR-561

SCR-572

SCR-642

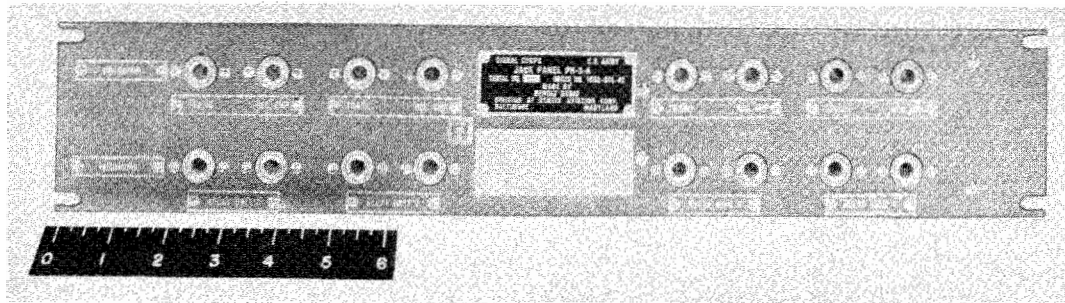

Figure 75 - Jack Panel PN-3-A - Front View

★  
JUNCTION BOX JB-29

Junction box JB-29 is equipped with eight sockets as shown and is used with transmitter-receiver combination BC-624 and BC-625. Mounting feet are provided on the bottom of the junction box.

The size of junction box JB-29 is 8-15/32 x 4-1/8 x 2-7/16 inches and it weighs approximately 2 pounds.

RADIO SETS USED WITH

SCR-566

SCR-575

SCR-645

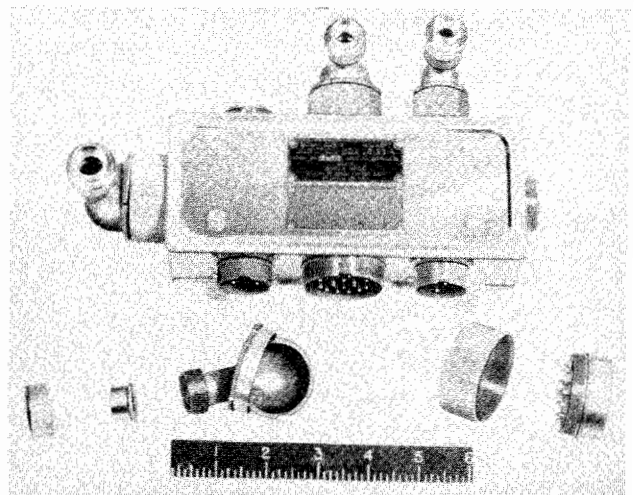

Figure 76 - Junction Box JB-29-A - Assembled -  
Showing Cable Connector Construction

### JUNCTION BOX JB-45

Junction box JB-45 is an automatic antenna switching device used to change the antenna from the receiver to the transmitter or vice versa.

This junction box JB-45 is used with the following radio sets:

- SCR-566
- SCR-575
- SCR-645

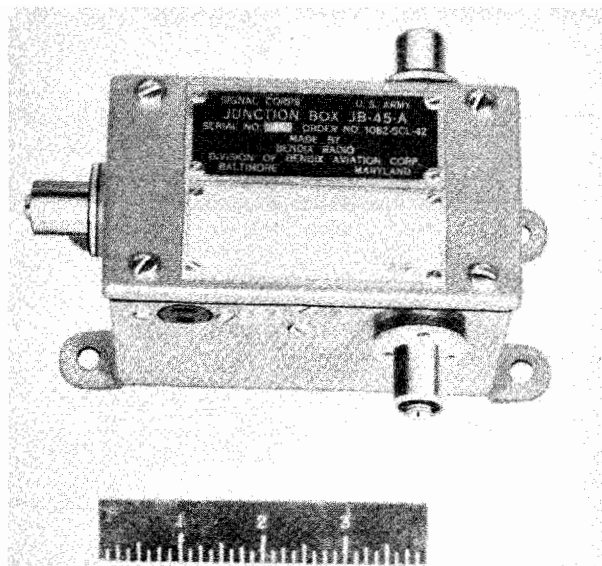

Figure 77 - Junction Box JB-45-A - Assembled

---

★

### MICROPHONE T-48

This microphone is used to modulate the outputs of transmitting units used with VHF equipment.

#### RADIO SETS USED WITH

- SCR-561
- SCR-562
- SCR-563
- SCR-564
- SCR-566
- SCR-567
- SCR-572
- SCR-573
- SCR-574
- SCR-575
- SCR-632
- SCR-633
- SCR-637
- SCR-642
- SCR-643
- SCR-644
- SCR-645

Figure 78 -  
Microphone T-48  
With Cord CD-588  
and Plug PL-68

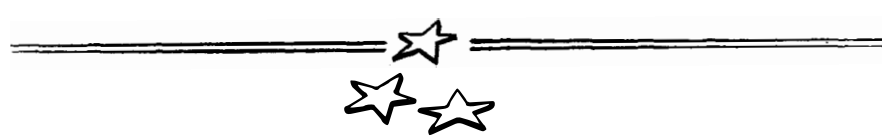
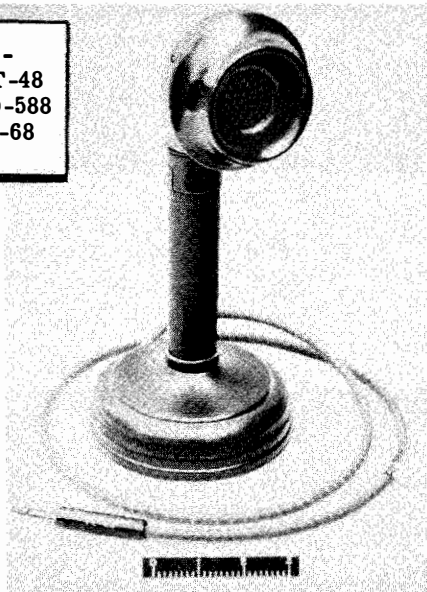

RESTRICTED

### MODULATOR PANEL PN-10

The modulator panel PN-10 is a part of radio transmitter BC-640. This modulator provides high level plate modulation for the final power amplifier. It uses two type VT-94 tubes in the input as a push-pull voltage amplifier stage. Two VT-175 tubes follow as a push-pull driver stage driving two type VT-

217 tubes as a class B modulator. A VT-94 tube is used as a 1000 cycle audio-oscillator for test of modulation or to key the transmitter. The output power is sufficient to provide 100 per cent voice or 1000 cycle tone modulation. Input facilities are provided for either remote or local voice input and are selected by a switch on the front of panel.

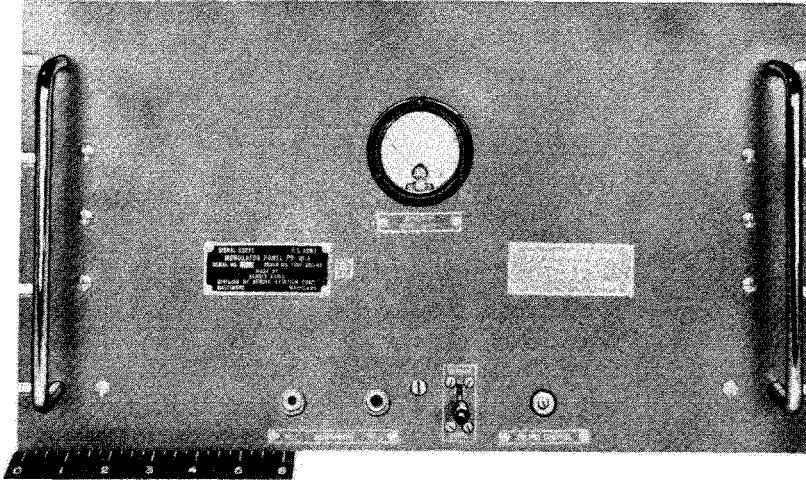

Figure 79 - Modulator Panel  
PN-10-A - Part of Radio Transmitter  
BC-640-A - Front View

---

★

### OSCILLATOR PANEL PN-9

Oscillator panel PN-9 is a part of radio transmitter BC-640 and provides the RF to drive the final amplifier at the output frequencies. The final frequencies are obtained by multiplication from crystals whose frequencies lie within the range from 5555.5 to 8666.6 KCS.

The type VT-175 metal tube is used as the oscillator operating on the fundamental frequency of the crystal. The oscillator feeds a type VT-100 tube used as a tripler which in turn drives a type VT-204 tube also operated as a tripler. This second tripler also drives a type VT-204 tube operated as a doubler, and the doubler drives a type VT-204 which is operated as a straight intermediate power amplifier. The power output of this intermediate amplifier is approximately 15 watts.

Figure 80 - Oscillator Panel  
PN-9-A - Part of Radio  
Transmitter BC-640-A -  
Front View

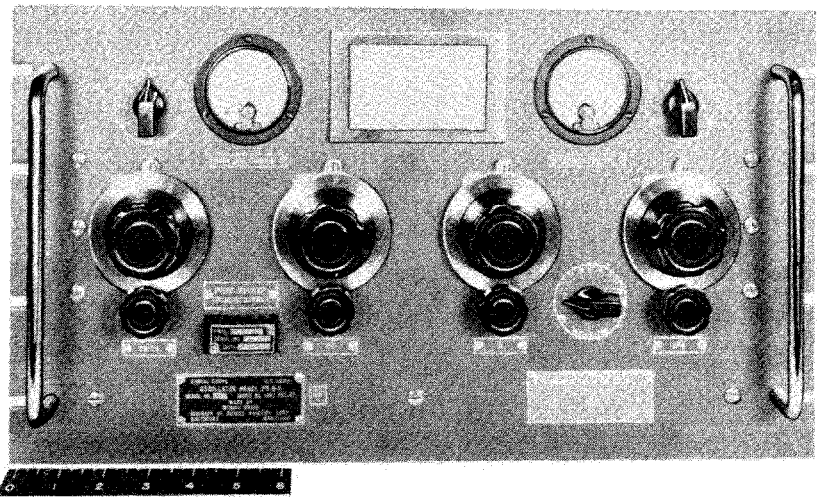

---

★

RESTRICTED

RESTRICTED

### POWER CONTROL PANEL PN-13

The power control panel PN-13 controls the line input voltage to the radio transmitter BC-640. On this panel are mounted the line fuses, main switch, voltmeter, and variable ratio transformer (Variac).

This transformer is controlled from the front of the panel. Provisions have been made so that simply changing the line terminal connection at the rear of the panel either 110/125 or 220/250 volt single phase service can be used. All other equipment of the transmitter station is maintained at 230 volts from the power control panel.

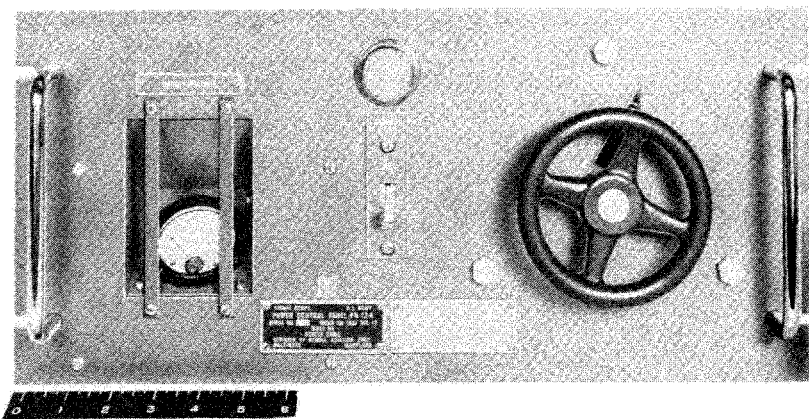
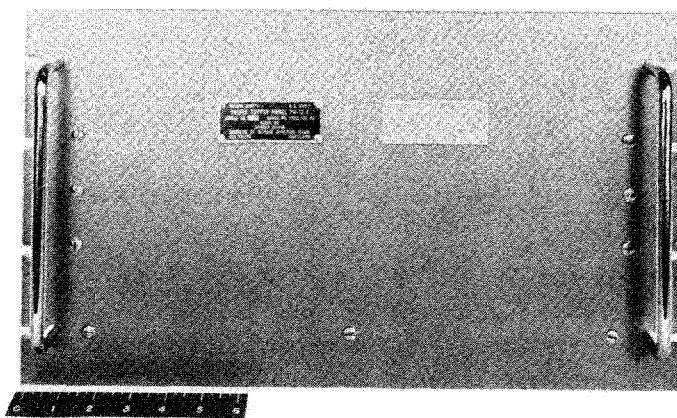

Figure 81 - Power Control Panel PN-13-A - Part of Radio Transmitter BC-640-A - Front View



Figure 82 - Power Supply Panel PN-12-A - Part of Radio Transmitter BC-640-A - Front View



### POWER SUPPLY PANEL PN-12

Two power supply panels PN-12 are part of the radio transmitter BC-640. One panel supplies plate current for the amplifier PN-8 and the oscillator panel PN-9, while the second power panel supplies plate current for the modulator panel PN-10. All filament current is obtained from individual filament transformers mounted on the amplifier, oscillator, and modulator panels. Each power supply panel uses four type VT-145 rectifier tubes and delivers approximate terminal potentials of 315, 395, and 800 volts dc.



RESTRICTED

Figure 83 - Power Unit PE-75-D - Flywheel Side

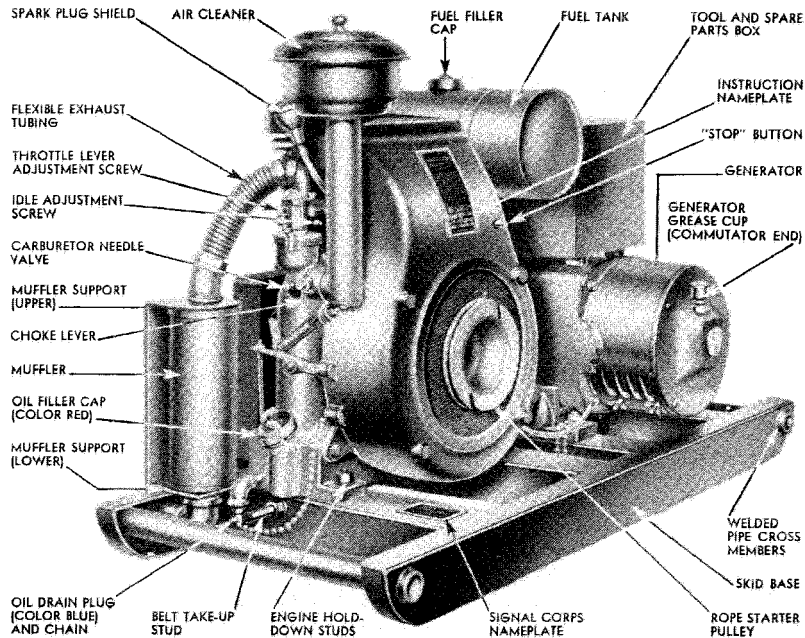

POWER UNIT PE-75-D

Power unit PE-75-D is a 2500 watt, gasoline-driven, alternating current generator set of the manual starting type and is designed to generate 120 volts, single phase, 60 cycle current.

Power unit PE-75-D can be used as a substitute for power unit PE-99 and because of its compact size it is usually used for overseas installations.

DIMENSIONS AND WEIGHT

The overall dimensions of this unit are: 36 inches long, 19-1/2 inches wide, by 26-1/2 inches high. This power unit weighs 440 pounds.

RADIO SETS USED WITH

SCR-562	SCR-566	SCR-573	SCR-575
SCR-563	SCR-567	SCR-574	SCR-634

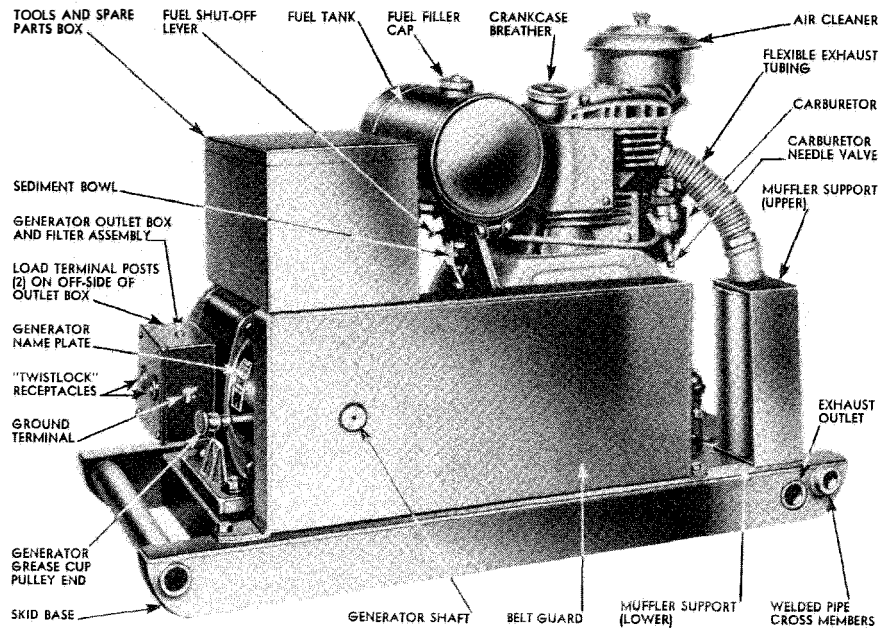

Figure 84 - Power Unit - PE-75-D - Drive Side



RESTRICTED

**RESTRICTED**

**POWER UNIT PE-99**

Power unit PE-99 is a complete, self-contained, mobile, air-cooled power unit and is used extensively as a source of power for the fighter control net systems described herein. The power output of this unit is approximately 75 KVA.

This power unit consists of the following components:

1. One engine generator assembly with integral lubricating, cooling and fuel system, mounted on a portable skid base.

2. Remote control, electric starting.

3. Six-volt starting battery with cables.

4. Enclosed, mounted control panel.

5. A hood enclosing the engine.

6. Radio shielding equipment.
7. Muffler and flexible exhaust tube.
8. One remote control and one power cable on a cable reel.
9. One set of spare parts.
10. One set of tools.

**RADIO SETS USED WITH**

SCR-561	SCR-632
SCR-562	SCR-633
SCR-563	SCR-637
SCR-564	SCR-642
SCR-565	SCR-643
SCR-566	SCR-644
SCR-567	SCR-645

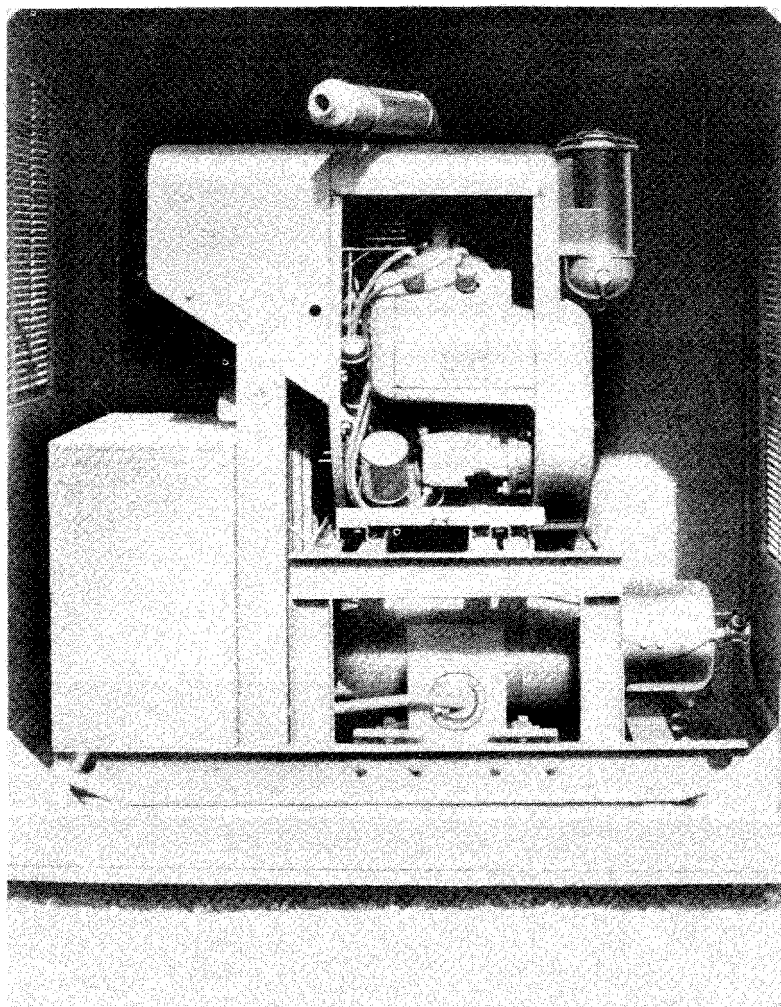

**Figure 85 - Power Unit PE-99**

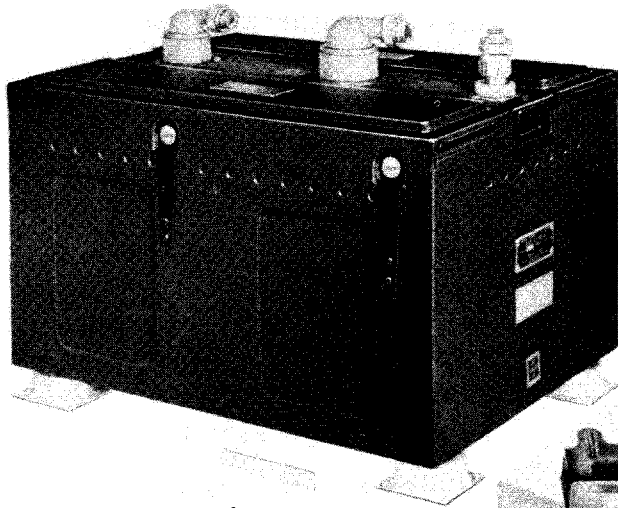

Figure 86 - Radio Receiver BC-624 and Radio Transmitter BC-625 Installed in Case CS-80

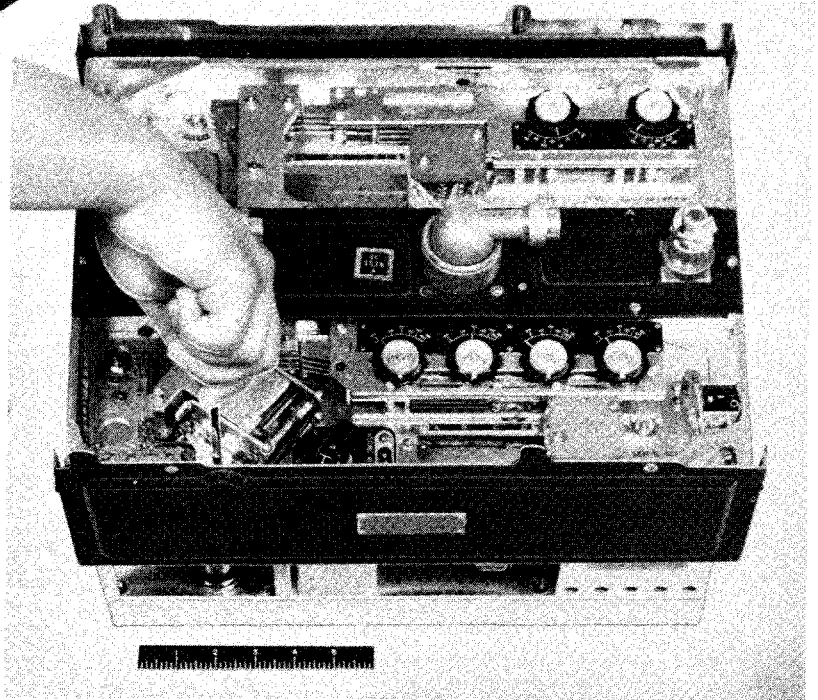

Figure 87 - Radio Receiver BC-624 and Radio Transmitter BC-625 With Covers Removed

**RADIO RECEIVER BC-624 AND RADIO TRANSMITTER BC-625**

Radio receiver BC-624 and radio transmitter BC-625 are a low power, crystal controlled transmitter-receiver combination with a frequency range of 99 to 156 megacycles. This transmitter-receiver combination has an output of approximately 12 watts and is used primarily as an airborne transmitter-receiver. The mobile direction finding and homing equipment in most of the VHF ground equipment is equipped with this equipment. The tuning of the transmitter-receiver (BC-625, BC-624) is accomplished by a push button control box BC-602. Any of four frequency channels may be selected by simply pressing one of four buttons on this control box. This operation automatically tunes both the receiver and the transmitter. The four frequency channels of this

equipment are designated channel A, channel B, channel C, and channel D. Channels A, B, and C are used for voice communication and channel D is used for transmitting a periodic signal modulated by a 1000 cycle note, which is used for direction finding operations. Channel D may also be used for voice communication during the period that this tone modulated signal is not being transmitted.

Radio receiver BC-624 and radio transmitter BC-625 installed in case CS-80 weighs approximately 50 pounds. Power is supplied by a 28-volt dynamotor unit PE-94.

**RADIO SETS USED WITH**

SCR-566  
SCR-575

SCR-624  
SCR-645

**RESTRICTED**

**RADIO RECEIVER BC-639**

Radio receiver BC-639 is designed for reception of radiosignals on the ultra-high frequency band from 100 to 156 megacycles (1.92 to 3 meters). Complete coverage of the band is accomplished without switching by using a slow-motion drive dial. The receiver is used at ground stations for reception of both radio-telephone communication and direction finding signals from aircraft.

**COMPONENTS, DIMENSIONS, AND WEIGHTS**

DESCRIPTION	OVERALL SIZE IN INCHES	WEIGHT
1 Radio Receiver BC-639 (Complete With Tubes)	19 x 10-1/2 x 13-1/4	36 lb
Used in conjunction with either of the following:		
1 Rectifier RA-42	19 x 7 x 8-5/8	26 lb
1 Dynamotor Unit PE-100	19 x 10-1/2 x 6	23 lb

**POWER REQUIREMENTS**

The power input to the receiver from the power supply unit is as follows:

180/210 Volts dc, 60 MA (210 volts normal power)  
6.3 Volts, 3.5 A, ac or dc

**RADIO SETS USED WITH**

SCR-563	SCR-567	SCR-634
SCR-564	SCR-574	SCR-637
SCR-565	SCR-575	SCR-644
SCR-566	SCR-633	SCR-645

**RADIO TRANSMITTER BC-640**

Radio transmitter BC-640 is designed to provide a modulated signal, on any frequency between 99 to 156 MCS. This transmitter has sufficient power to permit communication with ground stations 11.5 miles distant and with aircraft 135 miles distant when the aircraft is at an altitude of 10,000 feet. The distance ranges described above are considered conservative for reasonably level country. Under certain conditions of terrain or altitude the range will be substantially greater. In very hilly or mountainous country, the range will probably be reduced, and reflection effects might be expected which would give rise of zones of low signal strength.

**POWER REQUIREMENTS**

The primary power supply requirements are as follows:

110 - 125v, 50/60 cycle, single-phase, ac, 900 watts  
or  
220 - 250v, 50/60 cycle, single-phase, ac, 900 watts

**RADIO SETS USED WITH**

SCR-562  
SCR-567  
SCR-573  
SCR-632  
SCR-637  
SCR-643

Figure 89 - Radio Transmitter BC-640-A  
Front View of Assembly

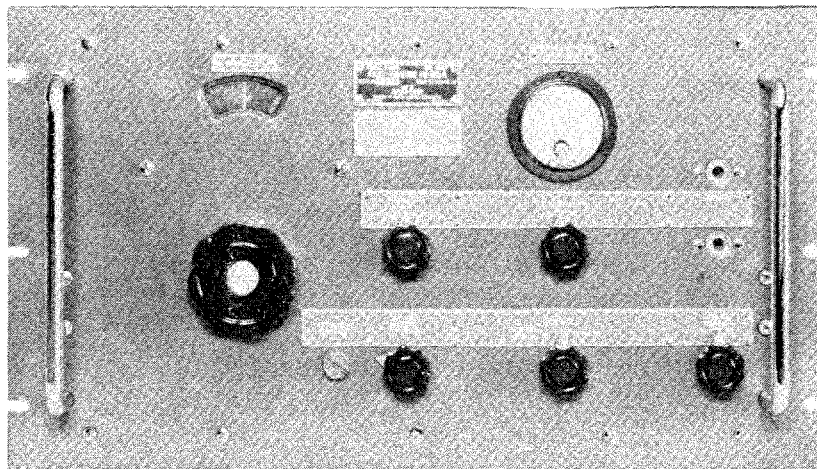

Figure 88 - Radio Receiver BC-639-A - Front View

RESTRICTED

### RECTIFIER RA-42

Rectifier RA-42 is a power supply unit to supply plate and filament power to receiver BC-639. The unit consists essentially of a power transformer, a rectifier tube (VT-206-A), a choke input filter circuit, a voltmeter, and a milliammeter.

The unit operates on an input from 200/250 volts ac, 50/60 cycles, 60 watts. The variable input is made possible by the use of a six-position switch connected to taps on the power transformer. This rectifier may also be operated on 110 volts.

This rectifier has an output of 210 volts  $\pm 5$  percent, 60MA, dc for the high voltage supply and 6.3 volts, 3.5A, ac for the heater supply of the receiver.

The overall dimensions of this unit are: 7 x 19 x 8-5/8 inches and the weight is 26 pounds.

### RADIO SETS USED WITH

SCR-563  
SCR-564  
SCR-565  
SCR-567  
SCR-574  
SCR-575  
SCR-633  
SCR-634  
SCR-637  
SCR-644  
SCR-645

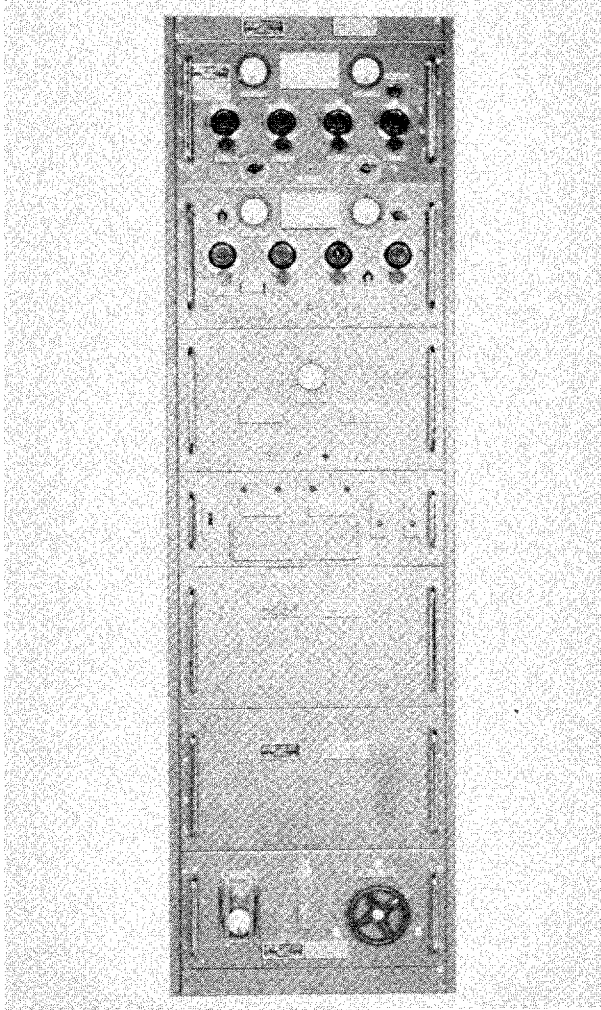
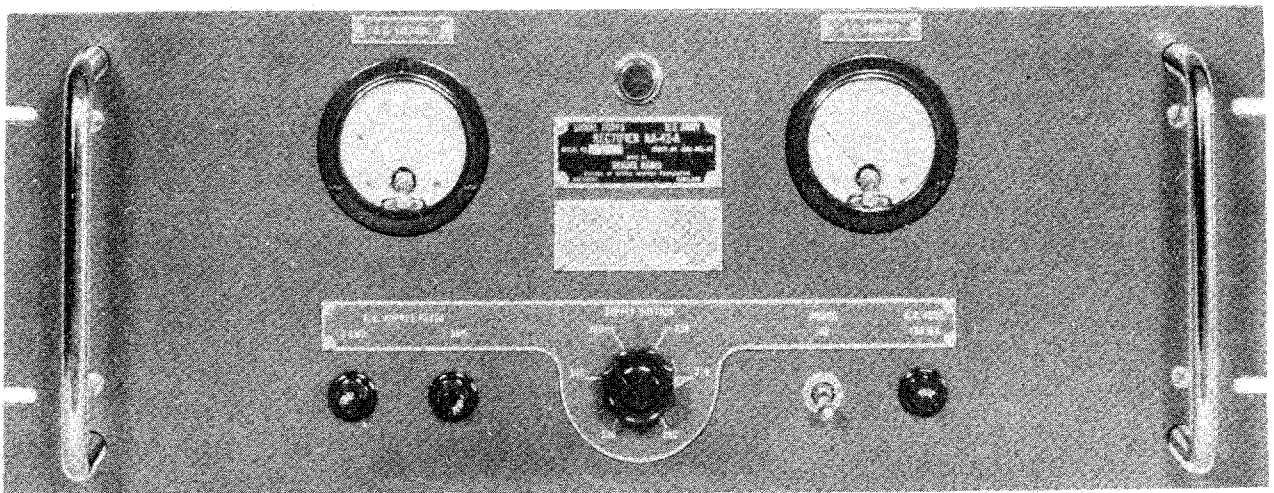

Figure 90 - Rectifier RA-42-A - Front View



RESTRICTED

**RECTIFIER RA-62**

Rectifier RA-62 is a full wave rectifier using an a-c, single phase, 40 to 60 cycle power source at 100 to 130 or 200 to 260 volts.

**RADIO SETS USED WITH**

**SCR-624**

**Figure 91 - Chest CH-172-A Unpacked - With Rectifier RA-62 - Spare Tubes, Fuses, Hand Crank, and 25 Foot AC Line Cord; Part of Radio Set SCR-624-A**

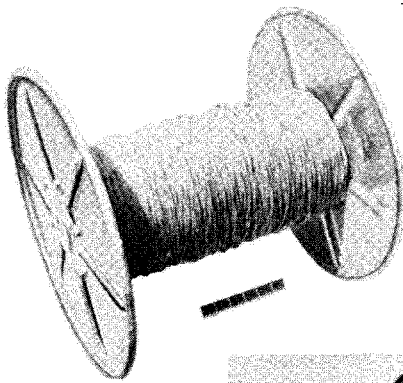
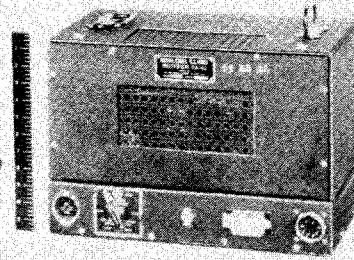
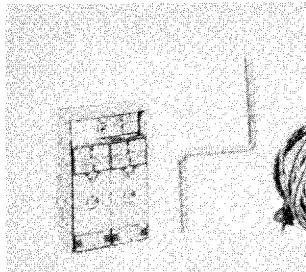
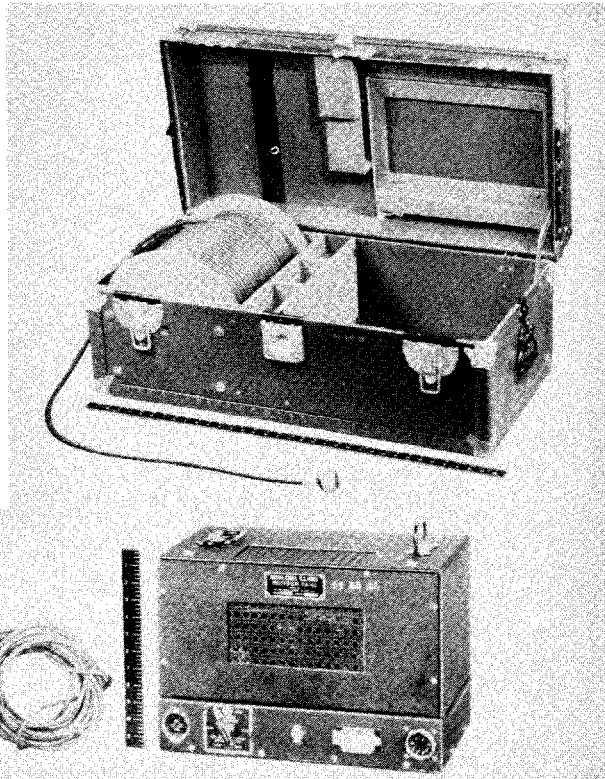

★  
← **Figure 92 - Reel DR-5 With Wire W-110-B**

**REEL DR-5**

Reel DR-5 may be substituted for reel DR-11 when the latter is not available.

**RADIO SETS USED WITH**

- SCR-561
- SCR-562
- SCR-563
- SCR-567
- SCR-573
- SCR-574
- SCR-632
- SCR-633
- SCR-637
- SCR-643
- SCR-644

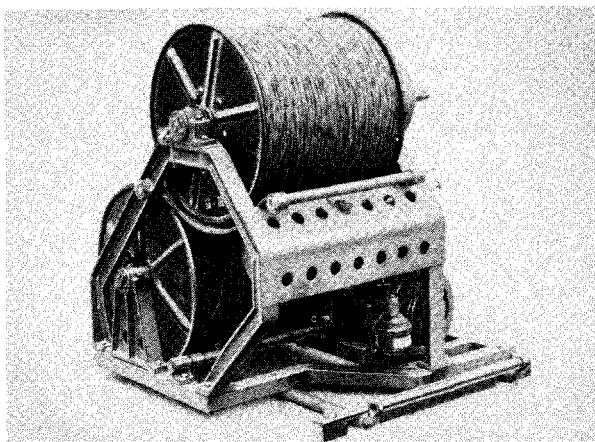

← **Figure 93 - Reel Unit RL-26-A With Reels DR-5 - Rear View - Showing Top Reel Cradle**

Figure 94 - Relay Unit  
BC-685-A - Front View

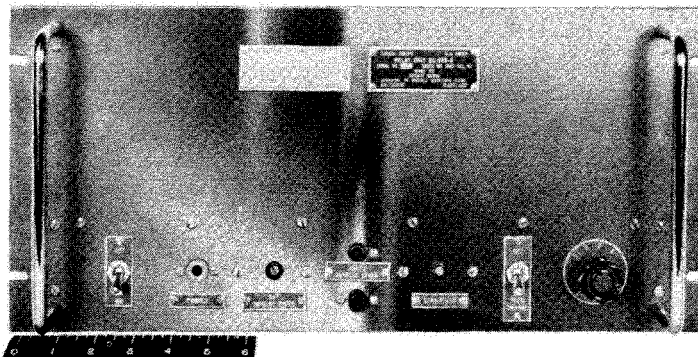

RELAY UNIT BC-685

Relay unit BC-685 is designed to operate with relay unit BC-687 to interpret the code signals transmitted by relay unit BC-687 over a single channel, two-wire telephone line and convert these signals into automatic switching operations.

COMPONENTS, DIMENSIONS, AND WEIGHTS

DESCRIPTION	OVERALL SIZE IN INCHES	WEIGHT
1 relay unit BC-685	19 x 14-1/4 x 8-3/4	46 lb
6 tubes, VT-201-C	- - - - -	- -
6 tubes, VT-214	- - - - -	- -
1 24-volt d-c power source	- - - - -	- -

RADIO SETS USED WITH

SCR-567	SCR-574	SCR-637	SCR-644
---------	---------	---------	---------



RELAY UNIT BC-687

Relay unit BC-687 is designed to operate with relay unit BC-685 to provide automatic switching of radio apparatus over a standard two-wire telephone line.

COMPONENTS, DIMENSIONS, AND WEIGHTS

The following major components are used with each relay unit BC-687:

DESCRIPTION	OVERALL SIZE IN INCHES	WEIGHT
1 relay unit, BC-687	19 x 12-1/2 x 9	- -
4 tubes, VT-201-C	- - - - -	- -
1 24-volt, d-c power source	- - - - -	- -

RADIO SETS USED WITH

SCR-561	SCR-572	SCR-575	SCR-642	SCR-645
---------	---------	---------	---------	---------

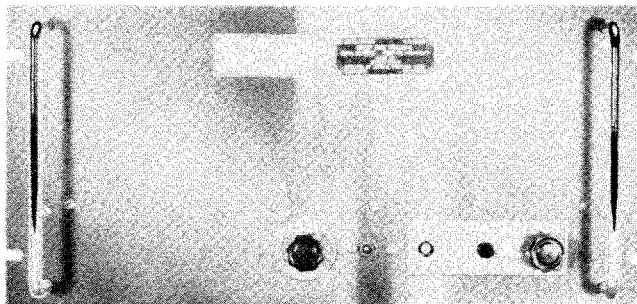

Figure 95 - Relay Unit  
BC-687-A - Part of  
Distribution Panel  
BD-102-A - Front View

RESTRICTED

### SHELTER HO-3

Shelter HO-3 is a prefabricated shelter for power unit PE-99. This shelter may be assembled in a very short time and may be completely dismantled without injury to its parts.

#### RADIO SETS USED WITH

SCR-561  
SCR-564  
SCR-565  
SCR-632  
SCR-633  
SCR-637  
SCR-642  
SCR-643  
SCR-644  
SCR-645

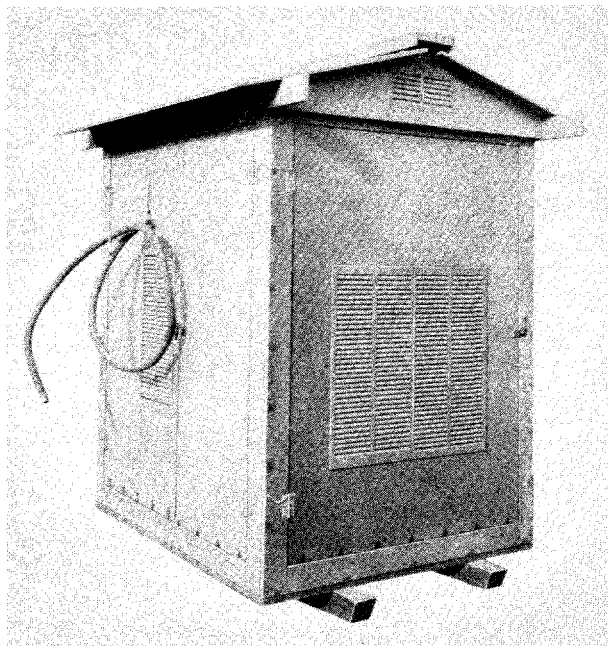

Figure 96 - Shelter HO-3



### SHELTER HO-34

Shelter HO-34 is a prefabricated shelter used to house air-transportable D/F station SCR-634. This shelter may be repeatedly dismantled and erected without damage to its parts.

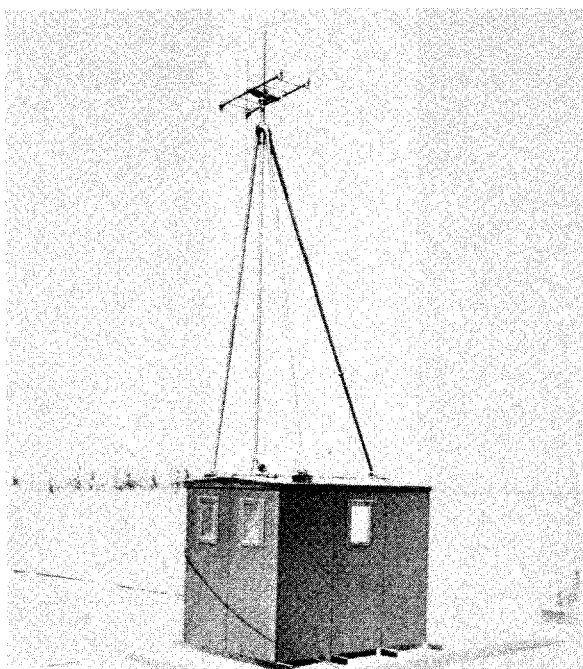

Figure 97 - Shelter HO-34  
With Antenna Mounted on Top



RESTRICTED

SOCKET PANEL PN-4

Socket panel PN-4 is used for interconnection between the power source and rack assembly.

This panel will be located in frame FM-39 in the following radio sets:

SCR-563                      SCR-564                      SCR-633

Socket panel PN-4 is 10-1/2 x 19 x 3-1/8 inches in size and it weighs 7 pounds.

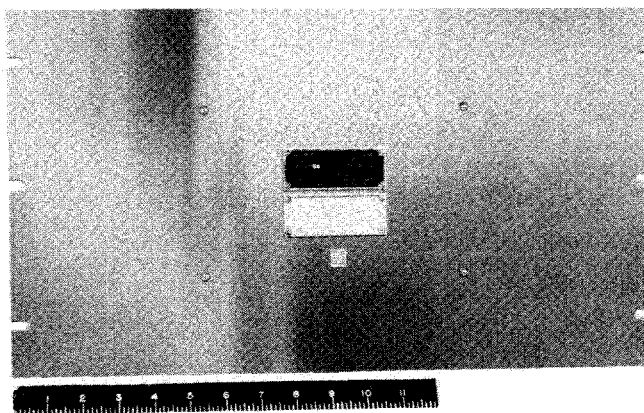

Figure 98 - Socket Panel PN-4-A - Front View



SWITCHING PANEL PN-6

Switching panel PN-6 is a panel containing equipment for switching either of the two radio receivers BC-639 from battery to line operation.

This panel is 19 x 7 x 5 inches and it weighs 8-1/2 pounds. It is located in frame FM-39 with the following radio sets:

SCR-565                      SCR-575                      SCR-645

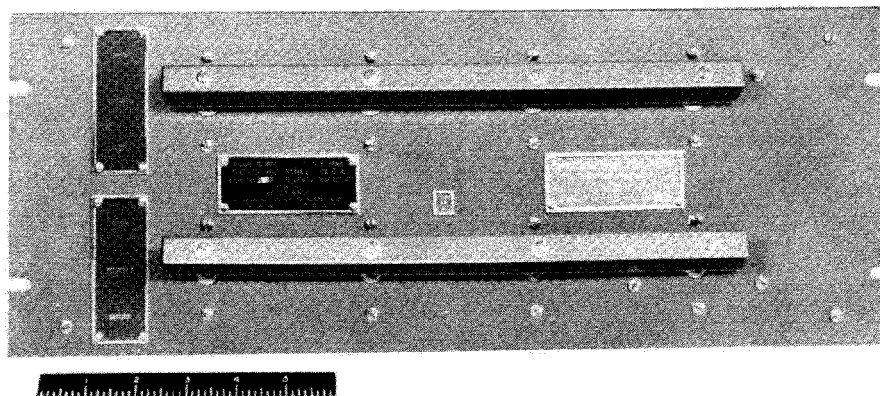

Figure 99 - Switching Panel PN-6-A - Front View

**RESTRICTED**

**TARGET TRANSMITTER BC-655**

Radio transmitter BC-655 is part of oscillator and test equipment RC-93.

**FREQUENCY RANGE**

The frequency range of the transmitter is continuously variable from 17.5 MCS to 162 MCS, in three bands as follows:

BAND	FREQUENCY RANGE
1	17.5 to 40
2	34 to 80
3	71 to 162

**POWER REQUIREMENTS**

The transmitter operates directly from a 1.5 volts, 160 MA A-battery and a 90-volt, 5.2 MA B-battery (two 45-volt batteries connected in series). The batteries are located in the lower compartment of the transmitter case.

**RADIO SETS USED WITH**

- SCR-564
- SCR-565
- SCR-566
- SCR-575
- SCR-645
- SCR-634

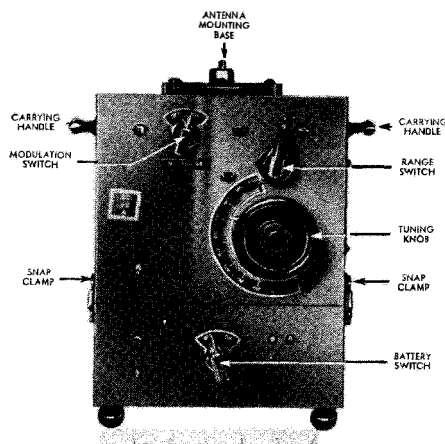

**Figure 100 -  
Target Transmitter  
BC-655**

**TELEGRAPH KEY J-44**

The key illustrated is a manufacturer's substitute for key J-44.

**RADIO SETS USED WITH**

- SCR-574
- SCR-575
- SCR-644
- SCR-645

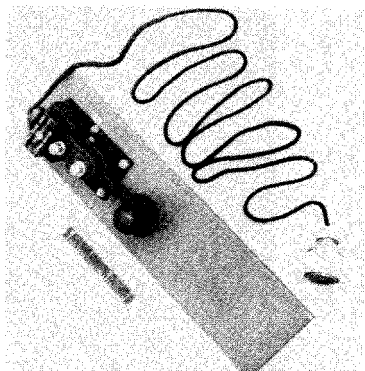

**Figure 101 -  
Telegraph Key**

**TELEPHONE EE-8A**

Telephone EE-8A is a field telephone using either local or common battery as a source of power.

**RADIO SETS USED WITH**

- |         |         |         |         |         |
|---------|---------|---------|---------|---------|
| SCR-561 | SCR-565 | SCR-573 | SCR-633 | SCR-644 |
| SCR-562 | SCR-566 | SCR-574 | SCR-637 | SCR-645 |
| SCR-563 | SCR-567 | SCR-575 | SCR-642 | SCR-624 |
| SCR-564 | SCR-572 | SCR-632 | SCR-643 |         |



**Figure 102 -  
Telephone EE-8-A -  
Front Three-  
quarter View**

TELEPHONE REPEATER EE-99

Telephone repeater EE-99 is a two-way amplifier used to improve communication over long-wire telephone transmission lines. The long lines to the forward relay transmitting and receiving stations usually employ this amplifier when it is used in conjunction with VHF equipment.

The circuit of this repeater consists of two identical amplifiers; one amplifying in one direction, and the other in the opposite direction. Each of these amplifiers has two stages of amplification, employing a pentode tube VT-146 (IN5-GT) followed by a beam power tetrode tube VT-221 (3Q5-GT). The maximum gain of the repeater is about 60 db for an output power level up to plus 15 db.

Power for this equipment is supplied by a 2.5-volt and 90-volt dry battery, or by a 12-volt battery operated synchronous full-wave vibrator, a step-up transformer and a filter.

RADIO SETS USED WITH

SCR-561

SCR-572

SCR-642

Figure 103 - Telephone Repeater EE-99-T3 - Covers Open

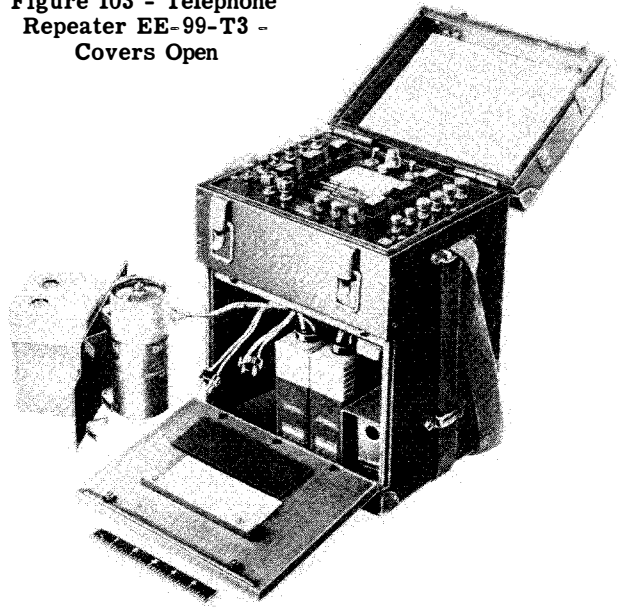

TELEPHONE SWITCHBOARD BD-72

Switchboard BD-72 is a portable, monocord, magneto-telephone switchboard, having a capacity of 12 lines. A line terminal strip is provided as an integral part of the switchboard in order that incoming lines may be directly connected to the binding posts.

This switchboard is used with radio sets SCR-573 and SCR-642.

RADIO SETS USED WITH

SCR-573

SCR-642

Figure 104 - Telephone Switchboard BD-72-A - (Front View of Assembly)

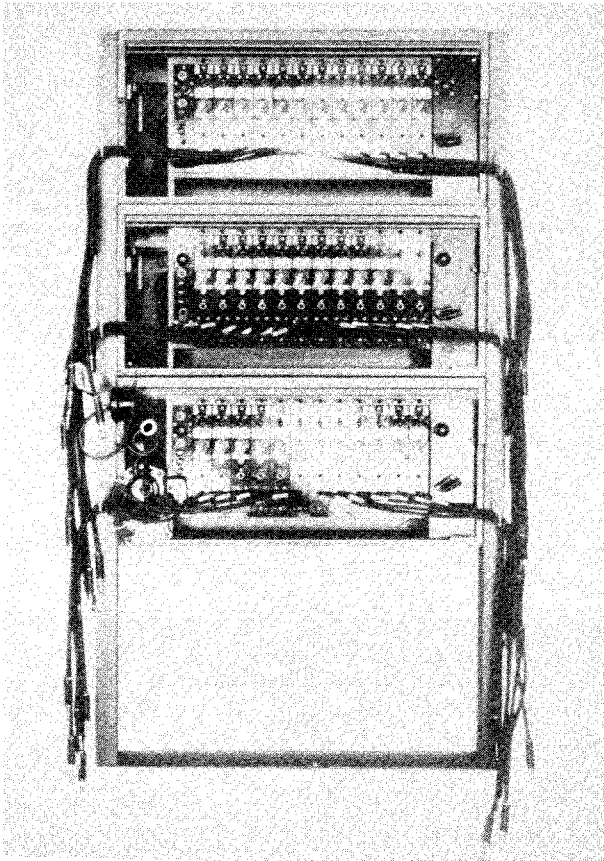

Figure 105 - Tester 504-A (Supreme Instruments Corporation)



RESTRICTED

TOWER TR-17

Tower TR-17 is a prefabricated three-story, octagonal building capable of easy assembly in the field. It is designed to house radio set SCR-564, DF homing station, or radio set SCR-565, DF fixer station. Tower TR-17 is so constructed that if it should become necessary to move the station to a new location, all but the concrete base may be salvaged.

All parts for tower TR-17 are packed in 13 export boxes. The boxes are designed and constructed to

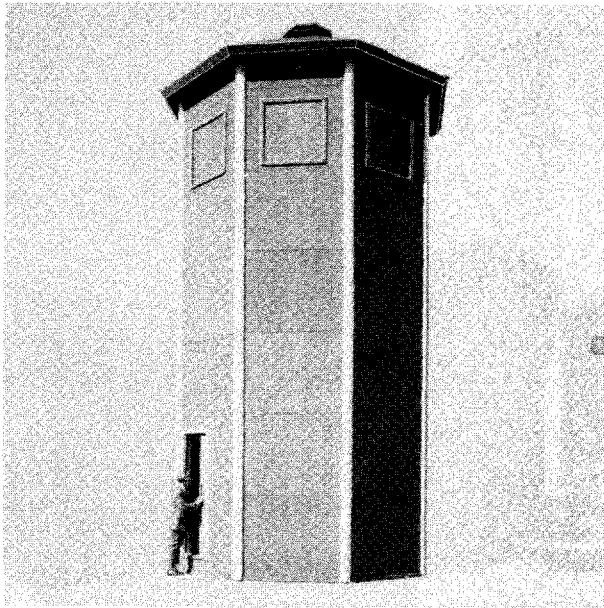

Figure 106 - Tower TR-17

permit unpacking the parts without destroying the boxes. The size of each of these boxes is as follows:

Height 30 ft, 7-5/8 in.  
Width of Side 5 ft, 9-1/4 in.  
Largest Dia. 15 ft  
Between Flats 12 ft

RADIO SETS USED WITH

SCR-564  
SCR-565  
SCR-645



TRAILER K-35

Trailer K-35 is used to house the main sector transmitting station SCR-562 and the main sector receiving station SCR-563.

These trailers are equipped with fluorescent lighting fixtures, 61 110-volt a-c outlets, and motor-driven ventilators in addition to the regular SCR-562 or SCR-563 equipment.

RADIO SETS USED WITH

SCR-562  
SCR-563

Figure 107 - Trailer K-35 (Drawbar Type)  
Front Curbside View

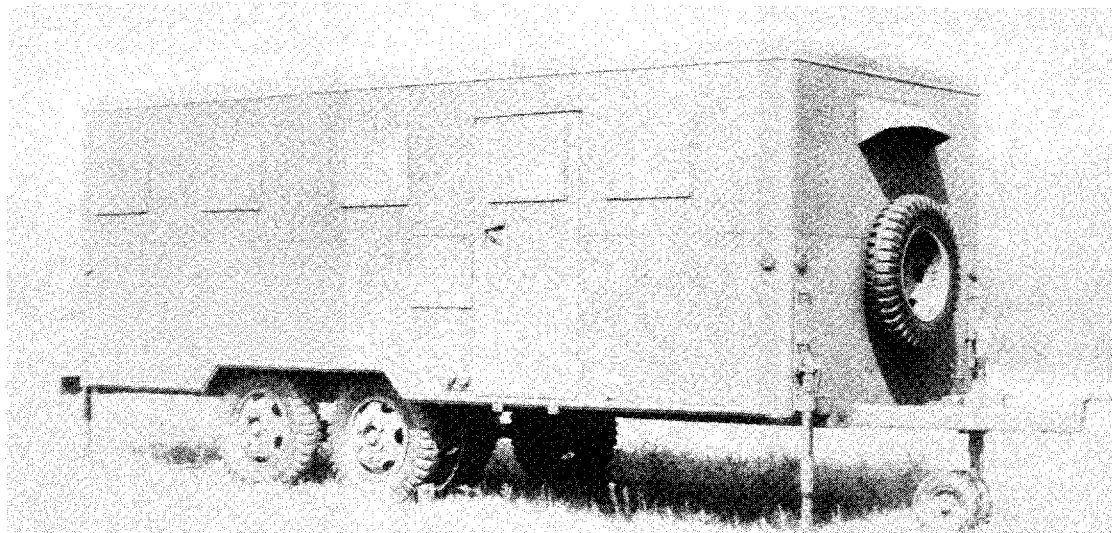

**TRAILER K-63**

This trailer is used to carry power unit PE-99 when the power unit is used with mobile equipment.

**RADIO SETS USED WITH**

- SCR-562
- SCR-563
- SCR-566
- SCR-567
- SCR-573
- SCR-574
- SCR-575



Figure 108 - Trailer K-63 - Rear View - Showing Installation of Power Unit PE-99-A

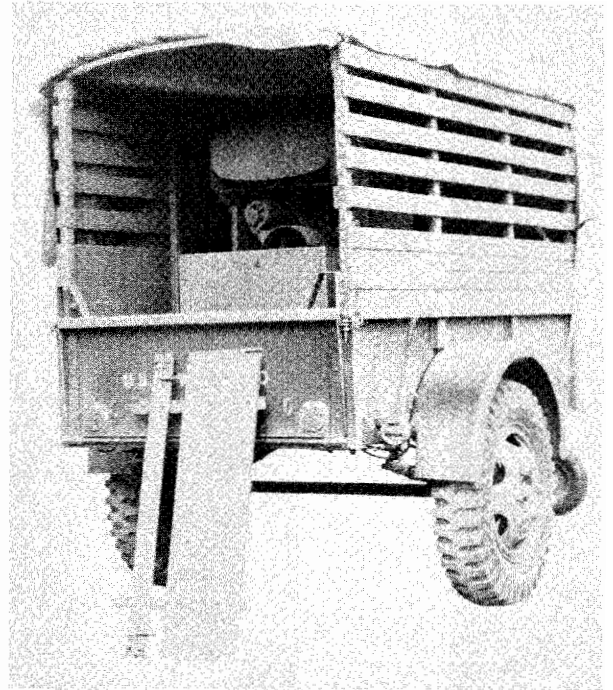

**TRUCK K-53**

Truck K-53 is a standard army truck which has proved adaptable for use with the VHF systems.

This truck K-53 is used for mounting different types of SCR radio sets. When one of these trucks is used for mounting a particular SCR radio set the number is changed as follows:

- Radio set SCR-562 is located in truck KE-1
- Radio set SCR-563 is located in truck KE-2
- Radio set SCR-566 is located in truck KE-3
- Radio set SCR-567 is located in trucks KE-4 and -5.

**RADIO SETS USED WITH**

- SCR-566
- SCR-567
- SCR-573
- SCR-574
- SCR-575

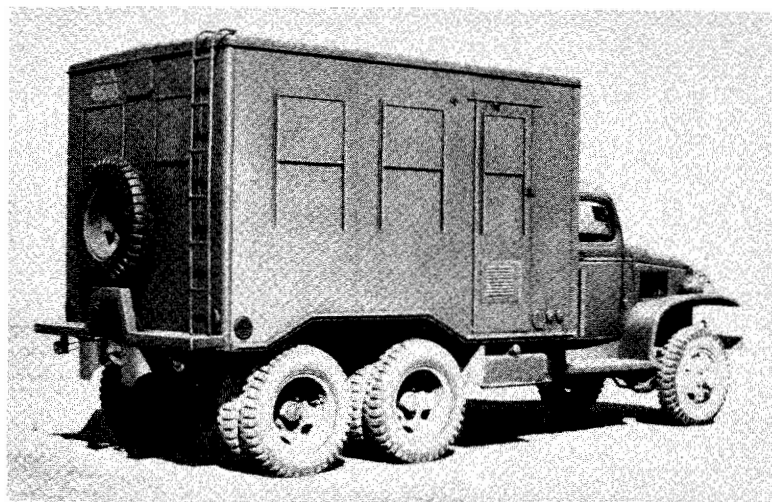

Figure 109 - Truck K-53 - Curbside Three-quarter View

RESTRICTED



Figure 110 - Volt Ohmyst Junior (RCA-Stock Number 165)





**Vacuum Tubes  
Used In VHF Equipment**







RESTRICTED

EQUIPMENT AND VACUUM TUBE COMPLEMENTS

AMPLIFIER BC-686

VT-201 65L6

AUDIO FREQUENCY OSCILLATOR,  
HEWLETT PACKARD 205-A

VT-66 6F6  
VT-114 5T4  
VT-184 VR-90

FREQUENCY METER BC-638

VT-117 6SK7  
VT-202 9002  
VT-203 9003  
VT-206-A 5V4-G  
VT-213-A 6L5-G  
VT-215 6E5

OSCILLOSCOPE CATHODE RAY, 3 in., RCA 155-A

VT-80 80  
AP1/906-P1  
6C6  
884

RADIO RECEIVER BC-624

VT-135 12J5-GT  
VT-169 12C8  
VT-202 9002  
VT-203 9003  
VT-207 12AH7-GT  
VT-209 12S67

RADIO RECEIVER BC-639

VT-103 6SQ7  
VT-152 6K6-GT  
VT-202 9002  
VT-203 9003  
VT-211 6SG-7

RADIO TRANSMITTER BC-625

VT-118 832  
VT-134 12A6  
VT-198 6G6G  
VT-199 6S57

RADIO TRANSMITTER BC-640

VT-94 6J5  
VT-100 807  
VT-145 5Z3  
VT-175 1613  
VT-204 HK-24-G  
VT-217 811

RADIO TRANSMITTER BC-655

VT-124 1A5-GT  
VT-212 958

RECTIFIER RA-42

VT-206-A 5V4-G

RECTIFIER RA-62

VT-244 5U4-G  
VT-126-B 6X5-GT

RELAY UNIT BC-685

VT-201-C 25LG  
VT-213-A 6L5-G

RELAY UNIT BC-687

VT-210-C 25L6

SIGNAL GENERATOR, FERRIS 18-D

VT-121 955  
VT-139 VR-150  
VT-184 VR-90  
VT-197-A 5T3QT  
VT-213-A 6L5-G

SIGNAL GENERATOR, FERRIS 22-A

VT-76 76  
VT-94 6J5  
VT-121 955  
VT-184 VR-90  
VT-197-A 5Y3QT

TELEPHONE REPEATER EE-99

VT-146 IN5-GT  
VT-221 6Q5-GT

TESTER, SUPREME

71-A

VOLTMETER, BALLANTINE #300-A

VT-90 6H6  
VT-91 6J7  
VT-116 6SJ7  
CD2005

VOLT-OHMYST JR.

VT-126 6X5  
VT-152 6K6-GT



RESTRICTED

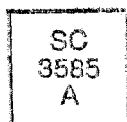

RESTRICTED

VACUUM TUBES USED IN VHF EQUIPMENT

TUBE	COMMERCIAL NO.	EQUIPMENT TUBES ARE USED WITH
VT-66	6F6	Audio Frequency Oscillator, HP-205-A
VT-76	76	Signal Generator, Ferris 22-A
VT-80	80	Oscilloscope Cathode Ray, 3 in. RCA 155-A
VT-90	6H6	Voltmeter, Ballentine #300-A
VT-91	6J7	Voltmeter, Ballentine #300-A
VT-94	6J5	Transmitter, BC-640; Signal Generator, Ferris 22-A
VT-100	807	Transmitter, BC-640
VT-103	6SQ7	Radio Receiver, BC-639
VT-114	5T4	Audio Frequency Oscillator, HP-205-A
VT-115	6L6	Signal Generator, AF, HP-205-A
VT-116	6SJ7	Voltmeter, Ballentine #300-A
VT-117	6SK7	Frequency Meter BC-638
VT-118	832	Transmitter BC-625
VT-121	955	Signal Generator, Ferris 22-A Signal Generator, Ferris 18-D
VT-124	1A5-GT	Target Transmitter BC-655
VT-126	6X5	Volt-Ohmyst Jr., Rectifier RA-62 Voltmeter, Ballentine #300-A
VT-134	12A6	Transmitter, BC-625
VT-135	12J5GT	Receiver, BC-624
VT-139	VR-150	Signal Generator, Ferris 18-D
VT-145	5Z3	Transmitter, BC-640
VT-146	IN5-GT	Telephone Repeater, EE-99
VT-152	6K6GT	Receiver, BC-639 Volt-Ohmyst Jr.
VT-169	12C8	Receiver, BC-624
VT-175	1613	Transmitter, BC-640
VT-184	VR-90	Signal Generator, Ferris 22-A Audio Frequency Oscillator, HP 205-A Signal Generator, Ferris 18-D
VT-197-A	5Y3QT	Signal Generator, Ferris 18-D Signal Generator, Ferris 22-A
VT-198	6G6G	Transmitter, BC-625
VT-199	6S57	Transmitter, BC-625
VT-201	25L6	Amplifier, BC-686
VT-201-C		Relay Unit, BC-685 Relay Unit, BC-687
VT-202	9002	Frequency Meter, BC-638 Receiver, BC-624 Receiver, BC-639
VT-203	9003	Frequency Meter, BC-638 Receiver, BC-624 Receiver, BC-639
VT-204	HK-24-G	Transmitter, BC-640
VT-206-A	5V4-G	Frequency Meter, BC-638 Rectifier, RA-42
VT-207	12AH7-GT	Receiver, BC-624
VT-209	12S67	Receiver, BC-624
VT-211	6SG7	Receiver, BC-639
VT-212	958	Target Transmitter, BC-655
VT-213-A	6L5-G	Frequency Meter, BC-638 Signal Generator, Ferris 18-D
VT-214		Relay Unit, BC-685
VT-215	6E5	Frequency Meter, BC-638
VT-217	811	Transmitter, BC-640
VT-221	3Q5-GT	Telephone Repeater, EE-99
	AP1/906-P1	Oscilloscope Cathode Ray, 3 in. RCA 155-A
	6C6	Oscilloscope Cathode Ray, 3 in. RCA 155-A
	884	Oscilloscope Cathode Ray, 3 in. RCA 155-A
	CD2005	Voltmeter, Ballentine #300-A
VT-244	5U4-G	Rectifier RA-62
	71-A	Tester, Supreme 504-A

