

1/4
1/4
4
113
TM
1944

TM 9-1725

WAR DEPARTMENT TECHNICAL MANUAL

U.S. Dept. of Army

ORDNANCE MAINTENANCE

Ordnance Engine Model R975-C (Continental)



WAR DEPARTMENT

27 JANUARY 1944

FOR ORDNANCE PERSONNEL ONLY

WAR DEPARTMENT TECHNICAL MANUAL

**TM 9-1725*

ORDNANCE MAINTENANCE

**Ordnance Engine Model R975-C4
(Continental)**



WAR DEPARTMENT

27 JANUARY 1944

**This manual includes pertinent information from TB 1700-4, dated 1 January 1942
and TB 1700-24, dated 15 May 1943.*

Digitized by 

Original from
UNIVERSITY OF CALIFORNIA

WAR DEPARTMENT
Washington 25, D. C., 27 January 1944

TM 9-1725, Ordnance Maintenance: Ordnance Engine Model R975-C4 (Continental), is published for the information and guidance of all concerned.

[A.G. 300.7 (29 Sep 43)
O.O.M. 461/(TM 9) Rar. Ars. (28 Jan 44)]

BY ORDER OF THE SECRETARY OF WAR:

G. C. MARSHALL,
Chief of Staff.

OFFICIAL:

J. A. ULIO,
Major General,
The Adjutant General.

DISTRIBUTION: R 9 (4); Bn 9 (2); C 9 (5).

(For explanation of symbols, see FM 21-6.)

CONTENTS

U113
.2
TM 9-1725
1944
★ ★

| | Paragraphs | Pages |
|---|------------|---------|
| CHAPTER 1. INTRODUCTION | 1- 2 | 4- 7 |
| CHAPTER 2. ENGINE DESCRIPTION AND DATA | 3- 4 | 8- 29 |
| CHAPTER 3. DISASSEMBLY OF ENGINE INTO SUBASSEMBLIES | 5-10 | 30- 81 |
| CHAPTER 4. DISASSEMBLY, CLEANING, IN- SPECTION, REPAIR, AND ASSEM- BLY OF SUBASSEMBLIES | 11-74 | 82-193 |
| SECTION I. Introduction | 11-14 | 82- 85 |
| II. Front crankcase section and front main bearing support | 15-18 | 86- 88 |
| III. Main crankcase section | 19-22 | 88-100 |
| IV. Cylinders, valves, and valve oper- ating mechanisms | 23-26 | 100-113 |
| V. Pistons | 27-30 | 113-117 |
| VI. Crankshaft and master rod | 31-34 | 117-136 |
| VII. Articulated rods and knuckle pins | 35-37 | 136-140 |
| VIII. Crankshaft gear assembly | 38-40 | 140-141 |
| IX. Diffuser section | 41-44 | 141-162 |
| X. Rear crankcase section | 45-48 | 162-171 |
| XI. Oil pump | 49-53 | 171-178 |
| XII. Rear crankcase section subas- semblies | 54-62 | 179-186 |
| XIII. Ignition harness | 63-65 | 186-190 |
| XIV. Flywheel and fan | 66-69 | 190-192 |
| XV. Miscellaneous subassemblies | 70-74 | 192-193 |
| CHAPTER 5. ASSEMBLY OF SUBASSEMBLIES .. | 75-79 | 194-245 |
| CHAPTER 6. TESTS AND ADJUSTMENTS | 80-83 | 246-248 |
| CHAPTER 7. FITS AND TOLERANCES | 84-90 | 249-258 |
| CHAPTER 8. TOOLS | 91-92 | 259-261 |
| REFERENCES | | 262-263 |
| INDEX | | 264-271 |

**ORDNANCE MAINTENANCE – ORDNANCE ENGINE
MODEL R975-C4 (CONTINENTAL)**

CHAPTER 1

INTRODUCTION

| | Paragraph |
|--|------------------|
| Scope | 1 |
| Modification work order (MWO) and major unit assembly replacement record | 2 |

I. SCOPE.

a. The instructions contained in this manual are for the information and guidance of personnel charged with the maintenance and repair of the Continental R975-C4 Tank Engine. These instructions are supplementary to field and technical manuals prepared for the using arms. This manual does not contain information which is intended primarily for the using arms, since such information is

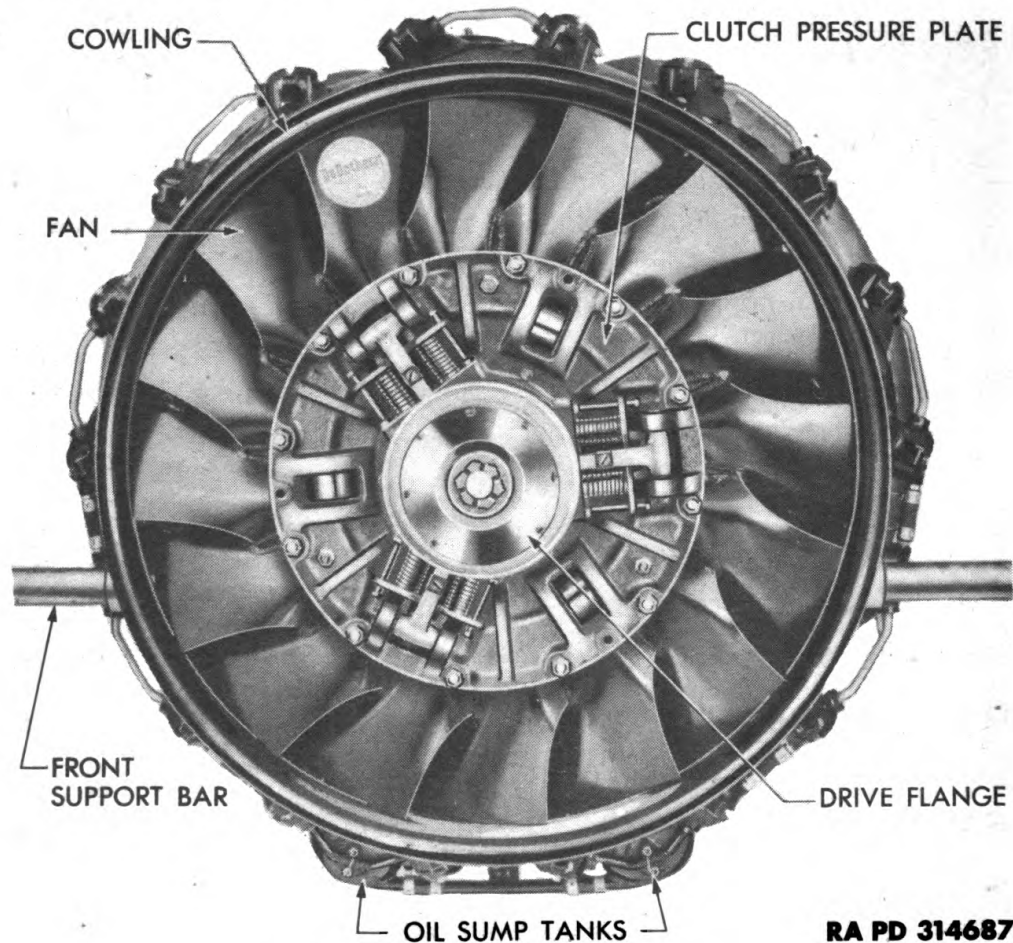

RA PD 314687

Figure 1 – Front View of Engine

INTRODUCTION

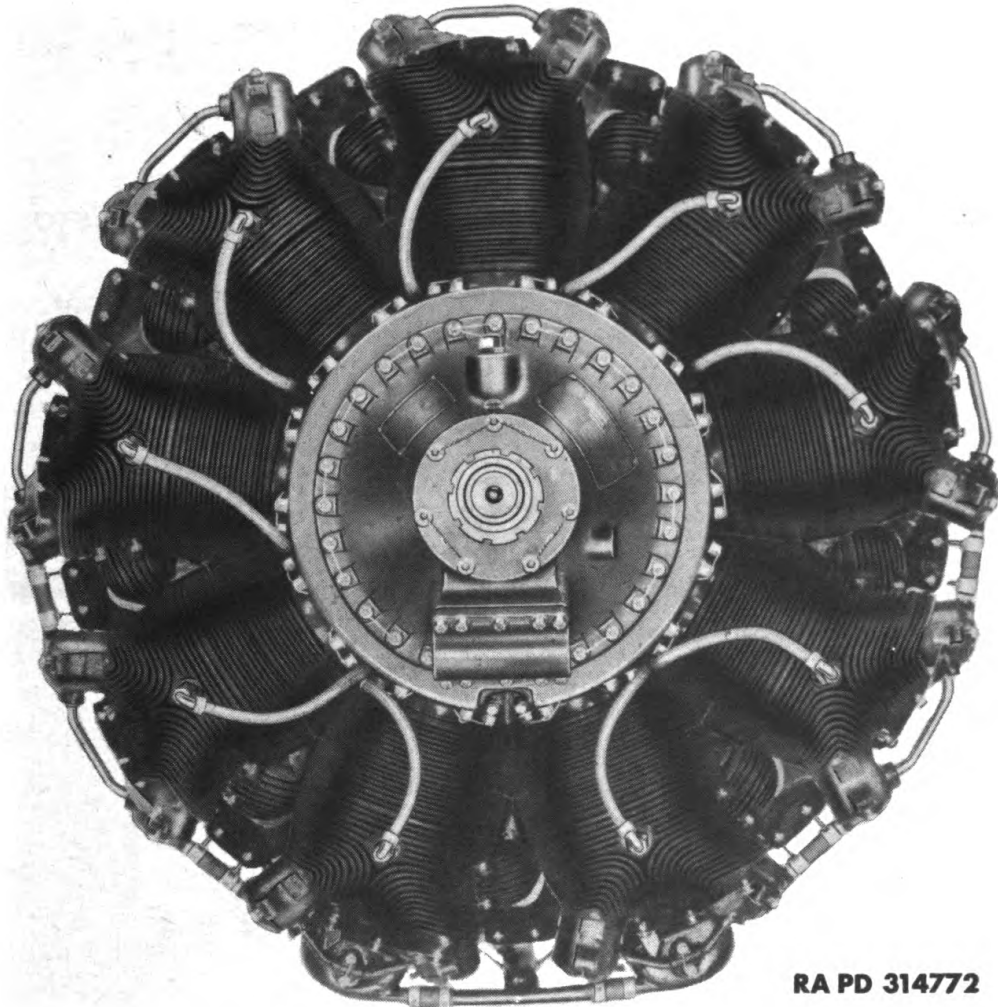

RA PD 314772

Figure 2 – Front View of Engine with Cowling, Clutch, Flywheel, Fan, and Engine Front Support Bar Removed

available to ordnance maintenance personnel in 100-series TM's or FM's.

b. This manual contains a description of, and procedure for the disassembly, cleaning, inspection, repair, and assembly of this engine and its components, except accessories such as carburetor, magneto, starter, generator, and fuel pump. TM's covering these accessories are listed in paragraph 62 of this manual.

2. MODIFICATION WORK ORDER (MWO) AND MAJOR UNIT ASSEMBLY REPLACEMENT RECORD.

a. **Description.** Every vehicle is supplied with a copy of AGO Form No. 478 which provides a means of keeping a record of each MWO completed or major unit assembly replaced. This form in-

**ORDNANCE MAINTENANCE – ORDNANCE ENGINE
MODEL R975-C4 (CONTINENTAL)**

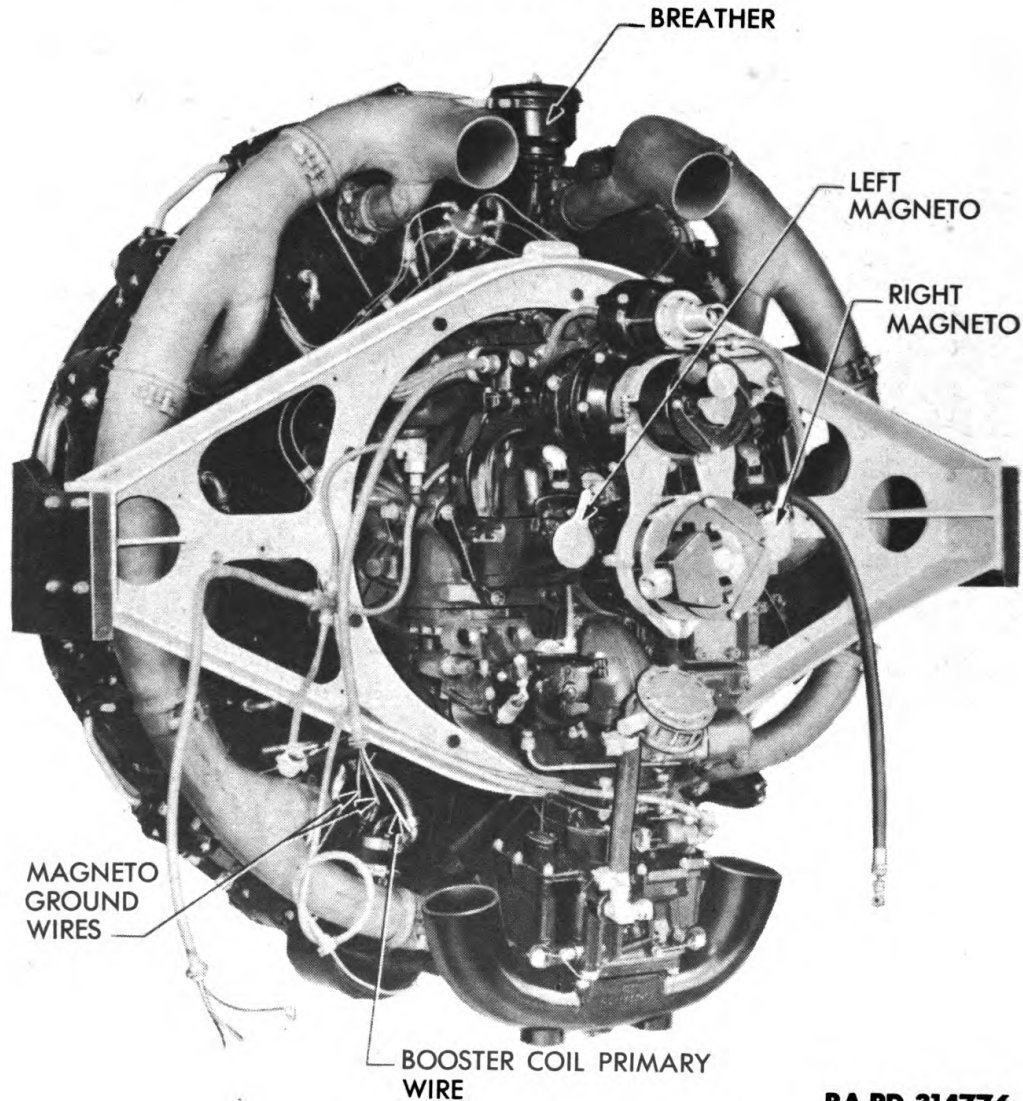

RA PD 314776

Figure 3 – Left Rear View of Engine

cludes spaces for the vehicle name and U. S. A. Registration Number, instructions for use, and information pertinent to the work accomplished. It is very important that the form be used as directed and that it remain with the vehicle until the vehicle is removed from service.

b. Instructions for Use. Personnel performing modifications or major unit assembly replacements must record clearly on the form a description of the work completed and must initial the form in the columns provided. When each modification is completed, record the date, hours and/or mileage, and MWO number. When major unit assemblies, such as engines, transmissions, and transfer cases, are re-

INTRODUCTION

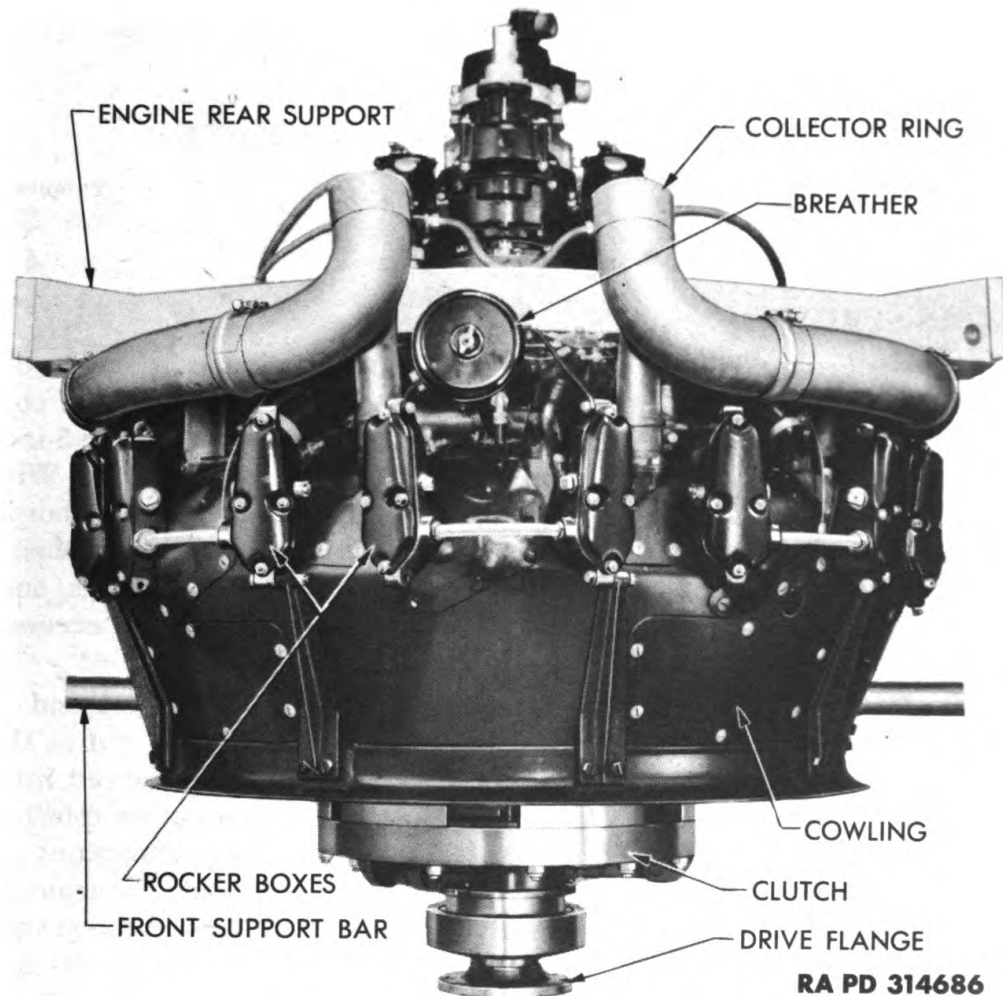

Figure 4 – Top View of Engine

placed, record the date, hours and/or mileage and nomenclature of the unit assembly. Minor repairs and minor parts and accessory replacements need not be recorded.

c. Early Modifications. Upon receipt by a third or fourth echelon repair facility of a vehicle for modification or repair, maintenance personnel will record the MWO numbers of modifications applied prior to the date of AGO Form No. 478.

**ORDNANCE MAINTENANCE – ORDNANCE ENGINE
MODEL R975-C4 (CONTINENTAL)**

CHAPTER 2

ENGINE DESCRIPTION AND DATA

| | Paragraph |
|-------------------|-----------|
| Description | 3 |
| Data | 4 |

3. DESCRIPTION.

a. General. The Model R975-C4 Tank Engine is a single-row, 9-cylinder, static radial, air-cooled type engine, operating on the conventional 4-stroke cycle. The engine has a 5-inch bore and a 5.5-inch stroke with a total piston displacement of 973 cubic inches. With a compression ratio of 5.7 to 1, the engine develops a brake horsepower of 485 at 2,400 revolutions per minute. The main components of the engine are the crankcase, cylinder and valve assemblies, connecting rod and crankshaft assemblies, accessory drives and accessories, and the ignition, fuel, and lubricating systems.

b. Designations. Throughout this manual the flywheel end of the engine is designated as the "front", and the accessory end as the "rear." The "right" and "left" sides of the engine are as viewed from the rear. Horizontal and vertical positions of the engine are referred to with respect to the position of the crankshaft. Directions of rotation are determined by looking from the rear toward the front of the engine, or in the case of side drives, by looking toward the crankshaft. The cylinders are numbered in a clockwise direction, the top cylinder being number one. Following this designation, the firing order of the cylinders is 1, 3, 5, 7, 9, 2, 4, 6, 8.

c. Crankcase.

(1) **GENERAL.** The crankcase is the main body around which the engine is built. It is composed of five flanged, cast aluminum-alloy sections secured together by studs, flat washers, and nuts, fastened with lock wire. The five components are the front, front main bearing support, main, diffuser, and rear crankcase sections.

(2) **FRONT CRANKCASE SECTION.** The front crankcase section is a conical-shaped casting which houses the main thrust ball bearing and the mounting clamp for the engine front support bar (fig. 5). The front cover, which serves as a retainer for the main thrust bearing, is mounted to the front crankcase section over seven studs. The cover is secured to this section by flat washers and castellated nuts fastened with lock wire.

(3) **FRONT MAIN BEARING SUPPORT.** This section is a flat, aluminum-alloy casting which serves as a bulkhead between the front and main crankcase sections and supports the roller-type front main bearing (fig. 5).

ENGINE DESCRIPTION AND DATA

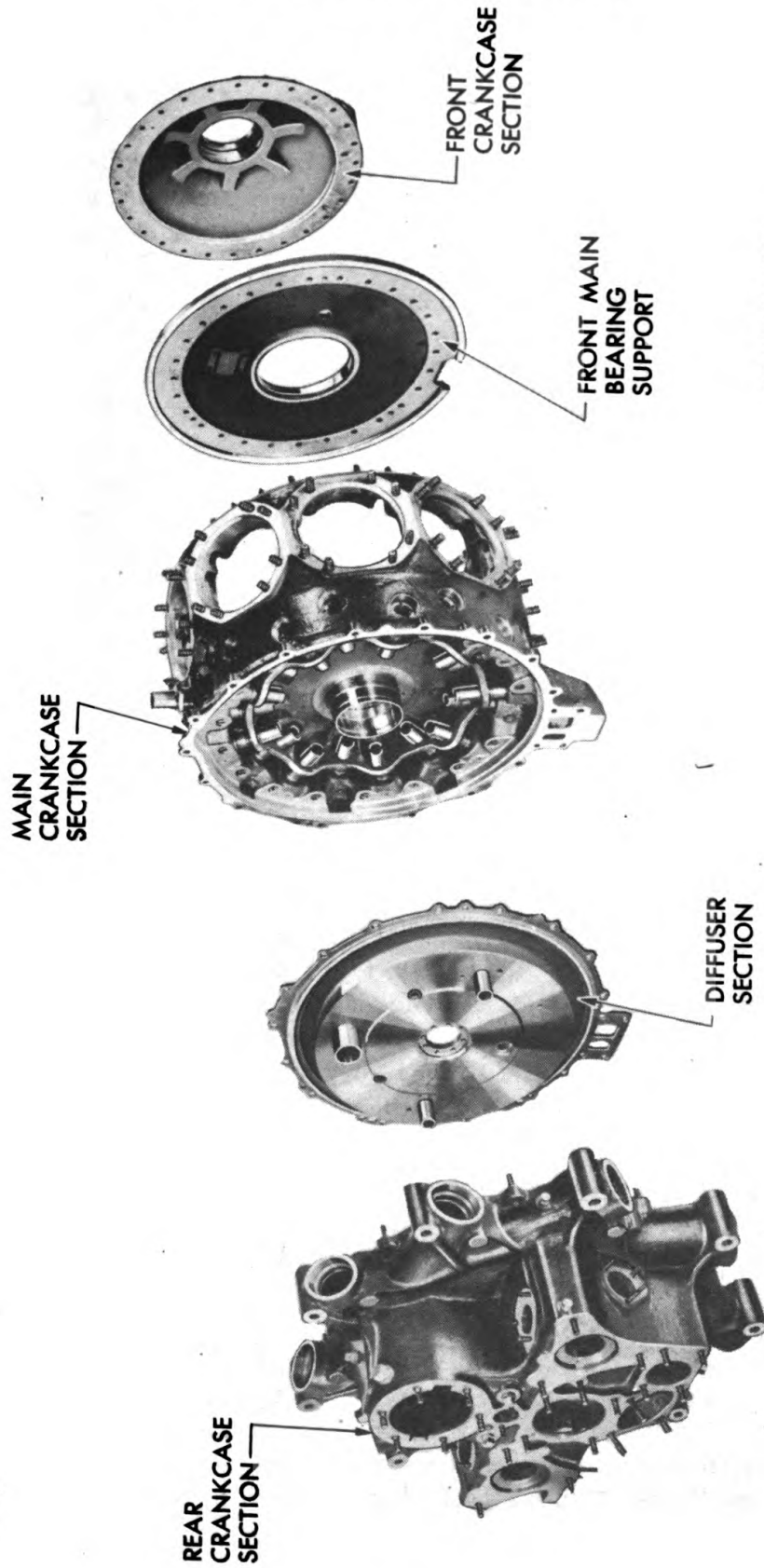

RA PD 314785

Figure 5 — Crankcase Sections

**ORDNANCE MAINTENANCE — ORDNANCE ENGINE
MODEL R975-C4 (CONTINENTAL)**

(4) **MAIN CRANKCASE SECTION.** The main crankcase section casting has cylinder mounting pads and hold-down studs to support the cylinder assemblies. The section also supports the rear main bearing, and houses the cam ring, valve tappets and rollers, and valve tappet guides (fig. 5). The front crankcase section and front main bearing support are secured to the main crankcase section over studs anchored in the main section forward flange. The sections are attached by means of flat washers and castellated nuts installed over the studs. The tightened nuts are fastened with lock wire.

(5) **DIFFUSER SECTION.** The crankcase diffuser section is a flat casting which separates the main crankcase area from the diffuser and distribution chambers in the rear crankcase section (fig. 5). The diffuser section supports the diffuser ring, diffuser impeller and the drive mechanism, starter gear, two accessory drive idler gears, and the accessory drive gears. The directional vanes of the impeller aid in better distribution of the fuel mixture through the troughs in the diffuser ring, into the fuel induction tubes, and then into the cylinders. Three bushings project from the rear of the diffuser section. These bushings support those portions of the starter gear and accessory drive shafts which pass through the distribution chamber. The shafts extend through the distribution chamber to the rear crankcase section.

(6) **REAR CRANKCASE SECTION.** The rear crankcase section supports the accessory drive shafts and provides mounting pads for the various engine accessories. The forward end of the rear crankcase section forms the rear wall of the diffuser and distribution chambers and provides connections for the fuel induction tubes. Mounting bosses for the rear engine support are cast integral with the fuel induction tube connections. The diffuser and main crankcase sections are mounted over studs in the rear crankcase section forward flange, and are secured to the rear section by plain washers and castellated nuts mounted over the studs. The tightened nuts are fastened with lock wire.

(7) **CRANKCASE BREATHER.** A crankcase breather system is provided for engine ventilation. A breather is attached to the rocker boxes of two cylinders by means of clamps and bolts (fig. 3). The breather is connected to openings in the main and rear crankcase sections by hose.

d. Cowling. The cowling is made up of three sections, the upper and lower segments, and the cowling ring (fig. 241). The cowling ring is attached to the engine, and the cowling sections are attached to the ring and to mounting bosses on cylinder rocker boxes. The cowling and intercylinder baffles attached to the cowling give direction to the air passing over the engine and help cool the engine.

ENGINE DESCRIPTION AND DATA

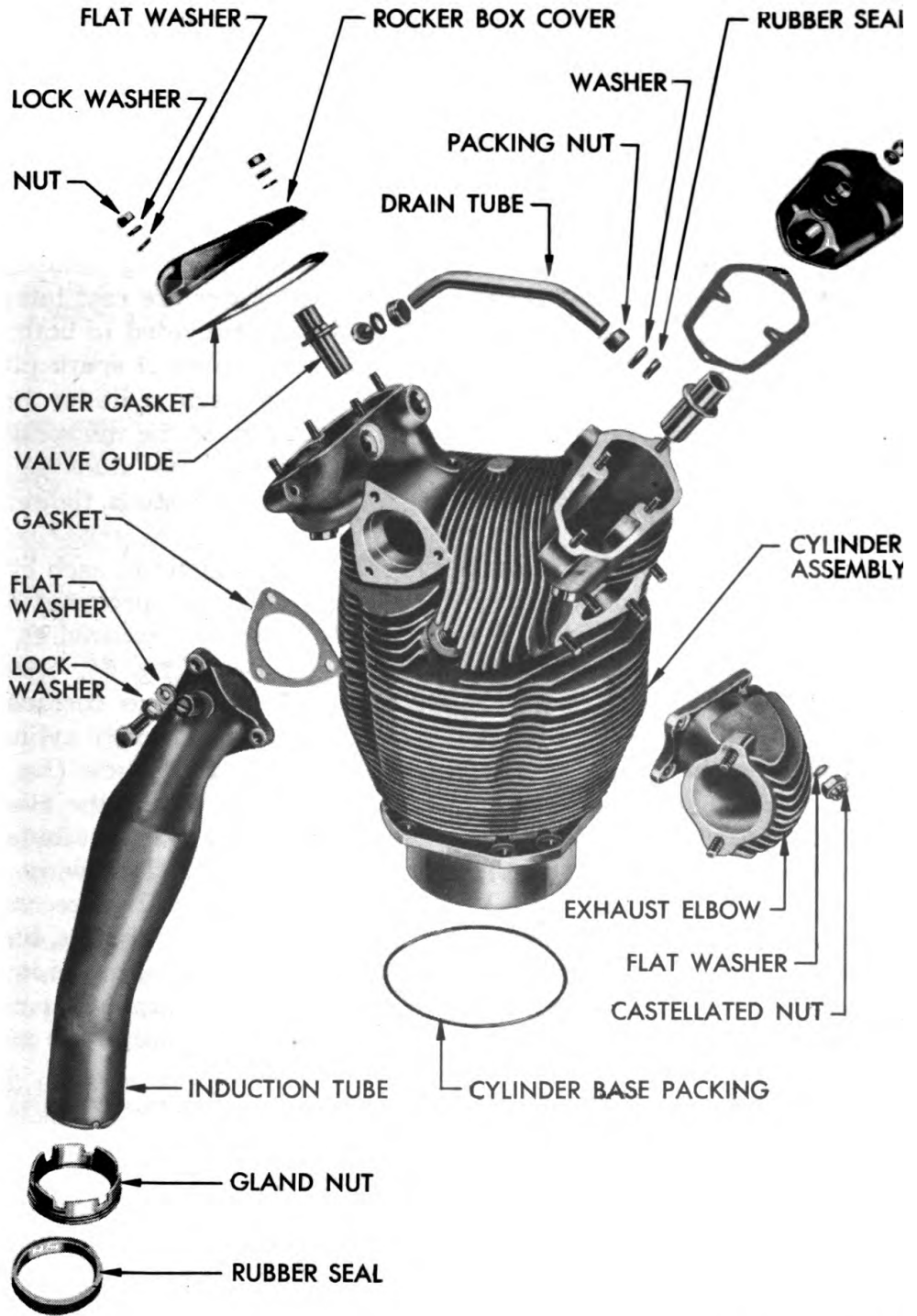

RA PD 31480C

Figure 6 - Cylinder Disassembled

**ORDNANCE MAINTENANCE — ORDNANCE ENGINE
MODEL R975-C4 (CONTINENTAL)****e. Cylinders.**

(1) **GENERAL.** Each of the nine cylinders in the engine consists of a cast aluminum head, cast aluminum cooling muff, and forged steel barrel.

(2) **CYLINDER HEADS AND BARRELS.** Both the cast aluminum cylinder heads and muffs are finned to promote rapid cooling. The fins are cast integral with the heads and muffs. The cylinder muff is shrunk onto the steel cylinder barrel, after which the head is screwed onto the barrel over barrel threads treated with sealing compound to prevent leakage. Two rocker arm support boxes are cast integral with each cylinder head (fig. 6). Openings are provided in both the front and rear of each cylinder head for the insertion of spark plugs, and there is an intake and exhaust port in each cylinder head. Cylinders are secured to cylinder mounting pads on the main crankcase section by cylinder barrel flanges installed over studs in the mounting pads. Hold-down nuts are installed on the studs, tightened, and fastened securely.

(3) **INTAKE AND EXHAUST PORTS.** The intake port in each cylinder faces the rear of the cylinder. Intake ports are provided with three tapped screw holes. Fuel induction tubes are secured to the ports with cap screws installed through these holes (fig. 6). Use of cap screws is made possible by phosphor bronze wire threads in the screw holes. Exhaust ports face the side of each cylinder. These ports are machined to receive a finned exhaust elbow (fig. 6), and are equipped with four mounting studs over which the elbows are installed. The elbows are secured by flat washers, and castellated nuts which are tightened and fastened securely with lock wire.

(4) **VALVE GUIDES AND VALVE SEAT INSERTS.** Bronze valve guides are shrunk into bosses cast integral with the cylinders, inside the valve ports (fig. 6). Valve seat inserts are shrunk into the inside of each cylinder head at an angle, providing a hemispherical combustion chamber within the cylinder. Intake valve inserts are made of bronze; exhaust valve seats are made of steel.

(5) **ROCKER BOXES.** Each rocker box has four studs over which rocker box covers are installed. Covers are secured to the boxes by flat washers, lock washers, and nuts (fig. 6). Bosses are cast at both the front and rear ends of each rocker box. The engine cowling is mounted to these bosses (par. 3 d). Push rod housing connections are screwed into the rear under side of the rocker box housings.

f. Pistons, Piston Pins, and Rings.

(1) **PISTONS.** Forged aluminum alloy pistons are of the full-trunk type (fig. 7). The under side of all piston heads is ribbed to provide increased strength and promote quicker cooling.

(2) **PISTON PINS.** Steel piston pins are of the full-floating type,

ENGINE DESCRIPTION AND DATA

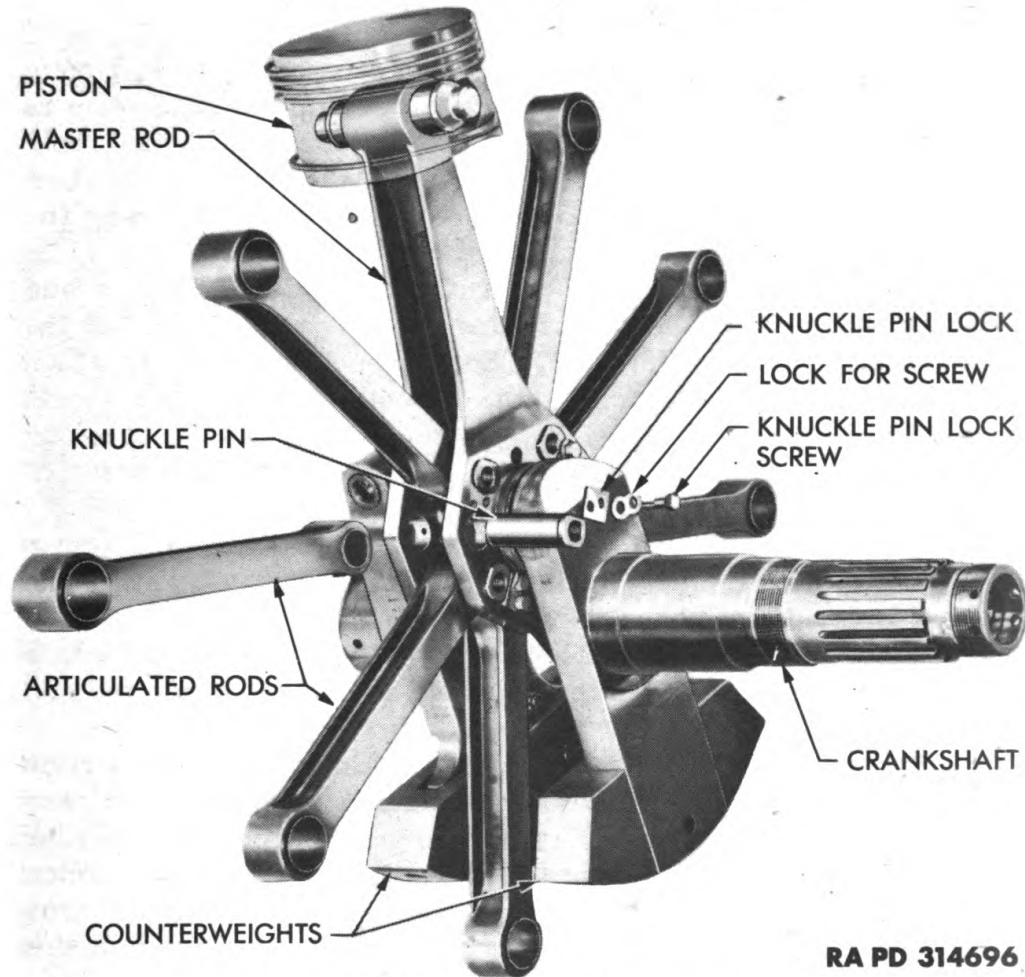

RA PD 314696

Figure 7 – Crankshaft, Connecting Rods, Piston, and Knuckle Pin Assembly

and are positioned in the pistons by soft aluminum plugs (fig. 109). The plugs are held in place by the cylinder walls.

(3) **PISTON RINGS.** Five piston rings are used in each piston, three compression rings (one of which is a chrome-plated ring), and one oil ring above, and one below the piston pin (fig. 7). The top compression ring is chrome-plated. The next two compression rings are taper-faced to provide easier seating of the rings in the cylinder barrels.

g. Valve Operating Mechanisms.

(1) **GENERAL.** Each intake and exhaust valve operating mechanism consists of a valve tappet roller, valve tappet, tappet guide, push rod, push rod housing, and rocker arm assembly (fig. 235). The valves are actuated through these mechanisms by a cam ring (fig. 235) which is rotated by means of a train of gears. As the cam rotates, the cam lobes raise the valve tappets which raise the push rods. The push rods, in turn, operate the rocker arms which open the valves.

**ORDNANCE MAINTENANCE – ORDNANCE ENGINE
MODEL R975-C4 (CONTINENTAL)**

(2) **CAM.** The circular cam (fig. 235) is secured to the rear main bearing extension by the cam hub bearing support. The cam is driven through a train of gears by the crankshaft gear. The crankshaft gear turns a pinion gear on the front of the starter drive shaft which, in turn, meshes with the spur gear on the cam, causing the cam to rotate.

(3) **VALVE TAPPETS AND TAPPET GUIDES.** Valve tappets and valve tappet guides are located around the rear outside wall of the main crankcase section (fig. 75). Each tappet has a roller which rides the cam lobes and moves the tappet. Each tappet moves through its closely fitted guide. Each tappet has a socket and spring at the push rod end to provide a seat for the ball end of the push rod (fig. 235).

(4) **PUSH RODS.** Push rods consist of a heat-treated seamless steel tube, and two stemmed, hardened steel balls. The stems of the balls are pressed into the ends of the tube. One ball end of each push rod fits into valve tappet socket, and the other ball end into a similar socket incorporated in the adjusting screw at the push rod end of each rocker arm (fig. 235).

(5) **ROCKER ARMS** (fig. 236). Rocker arms are of one-section machined steel forgings. They are mounted on a double roller bearing. The inner bearing race is clamped in the rocker box by a through bolt. The valve end of the rocker arm is forked to carry a roller. The roller operates on a hub and pin riveted into the rocker arm. When moved, the rocker arm contacts the valve stem through this roller and moves the valve. Tappet clearance is adjusted by an adjusting screw and adjusting screw lock nut at the push rod end of the rocker arm.

(6) **VALVES AND SPRINGS** (fig. 108). Intake and exhaust valves are machined, heat-resistant steel forgings. The exhaust valves have a hollow stem containing sodium which serves as a valve coolant. The intake valve stem is solid and slightly smaller in diameter than the exhaust valve stem. Three valve springs over each valve stem are seated on a washer at the base of each rocker box. These springs are held in place by a shouldered washer secured in position by a split lock on the valve stem.

h. Connecting Rod Assemblies.

(1) **GENERAL.** The nine pistons in the engine are connected to the crankshaft by means of a master rod and eight articulated rods (fig. 7).

(2) **MASTER ROD.** The master rod is connected to the No. 1 cylinder piston pin and the crankshaft crankpin (fig. 7). The rod is finish-machined from H-section, forged, chrome-nickel steel. The master rod has a steel-backed, silver-lead bearing in the crankshaft

ENGINE DESCRIPTION AND DATA

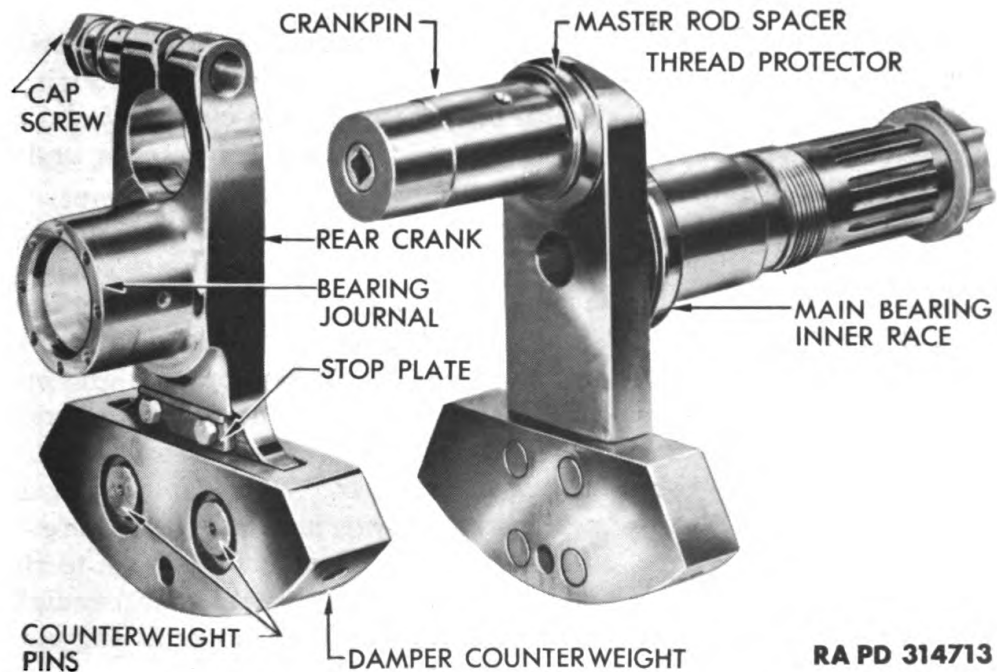

Figure 8 – Crankshaft Sections

end, and a bronze bushing in the piston pin end. The master rod has widened flanges at the crankshaft end. These flanges are bored to receive the articulated rod knuckle pins which connect the articulated rods to the master rod.

(3) **ARTICULATED RODS** (fig. 7). Articulated, or connecting rods, are also finish-machined from H-section, forged chrome-nickel steel. The rods are connected to the piston by piston pins and to the master rod by knuckle pins. The piston pin and knuckle pin bushings in the ends of the articulated rods are of bronze.

i. Crankshaft.

(1) **GENERAL.** The crankshaft is a two-piece, single-throw, counterbalanced assembly, machined from nickel-steel forgings. The crankshaft consists of a front and a rear section. Each crankshaft section has a crankcheek and counterweight. The rear section counterweight is the dynamic damper designed to minimize crankshaft vibration (fig. 8). The crankcheek and counterweight in both sections have an alining hole. An alining bar is installed through these holes when crankshaft sections are being assembled to insure proper alignment (fig. 134).

(2) **FRONT CRANKSHAFT SECTION.** The front section consists of the crankshaft, the front crankcheek with its counterweight, and the crankpin. The front end of the crankshaft is splined (S.A.E. spline No. 30) to receive the flywheel hub. The front end is also threaded for the thrust bearing retaining nut. The front crankcheek has an

**ORDNANCE MAINTENANCE – ORDNANCE ENGINE
MODEL R975-C4 (CONTINENTAL)**

extension below the centerline of the shaft proper to support a steel counterweight. The crankpin has an oil passage drilled through it lengthwise. There is also a small oil passage in the clamping end of the front crankshaft section. Oil squirts through this passage under pressure to the cylinder walls as the crankshaft revolves.

(3) **REAR CRANKSHAFT SECTION.** The rear crankshaft section consists of the rear crankcheek with the dynamic damper counterweight, and the rear main bearing journal (fig. 8). The rear crankcheek is bored to receive the crankpin. It is also bored and tapped to receive the clamping cap screw, and is slotted at the top crankpin end to permit the clamping action of the cap screw. The crankshaft rear main bearing journal is hollow and is fitted with a screwed-in plug at the front, and a pressed-in plug at the rear. The crankshaft gear is secured to the end of the rear main bearing journal by cap screws.

(4) **DYNAMIC DAMPER.** The dynamic damper is mounted to the rear crankshaft section. The damper consists of a steel counterweight hung on an extension of the rear crankcheek by two loose fitting pins. The loose fit permits a limited travel of the weight with reference to the crankcheek extension. The ends of the pins are flanged so that they can be removed from the pin holes only when the pin holes line up with the crankcheek extension holes. A steel stop plate bolted to the crankcheek extension prevents the holes from lining up except during disassembly.

j. Accessory Drive Mechanism (fig. 9).

(1) **CRANKSHAFT GEAR.** Engine accessories such as the generator, tachometer, fuel pump, magnetos, oil pump, etc., are driven through a train of gears by the crankshaft gear. The crankshaft gear is attached to the rear end of the crankshaft and is housed between the diffuser and main crankcase sections (fig. 210). The gear incorporates a flexible spring drive which provides a cushion effect to protect the accessories and the impeller from acceleration load.

(2) **STARTER DRIVE GEAR.** The crankshaft gear meshes directly with the starter drive gear (fig. 9). The starter gear is the upper of the two gears driven by the crankshaft gear. The starter drive gear is splined on the starter shaft which extends through the diffuser to the rear crankcase section and also carries the starter shaft gear at the rear (fig. 185). The starter drive gear is retained on the starter shaft by the starter shaft bolt which passes through the entire length of the starter shaft and carries the cam driven pinion gear on its forward end.

(3) **GENERATOR IDLER GEAR.** The starter shaft gear (fig. 185) meshes with the generator idler gear (fig. 177). This gear is mounted on the generator idler gear shaft in the rear crankcase section. The generator idler gear, in turn, meshes with the generator intermediate

ENGINE DESCRIPTION AND DATA

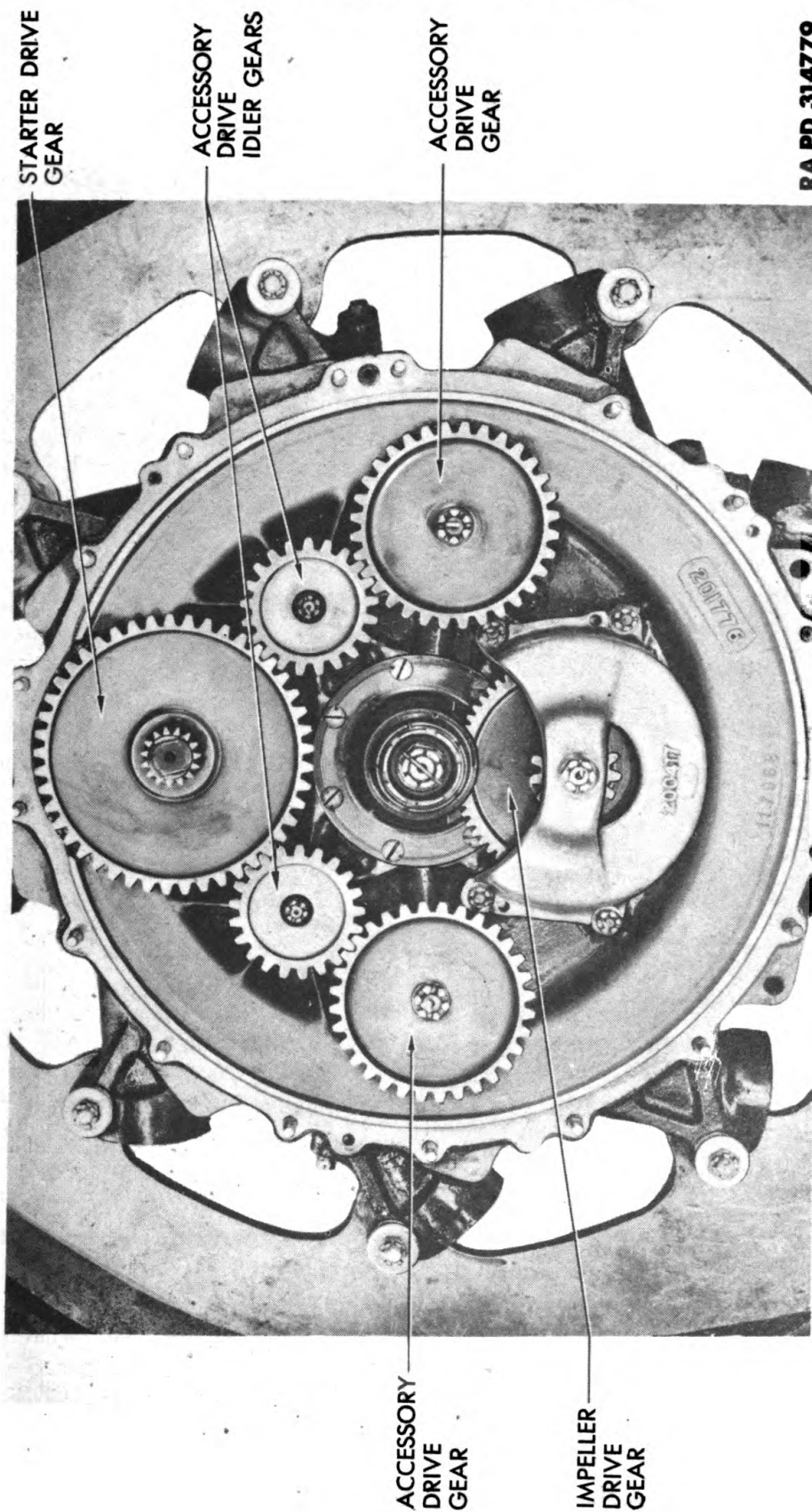

RA PD 314779

Figure 9 -- Accessory Drive Mechanism

**ORDNANCE MAINTENANCE – ORDNANCE ENGINE
MODEL R975-C4 (CONTINENTAL)**

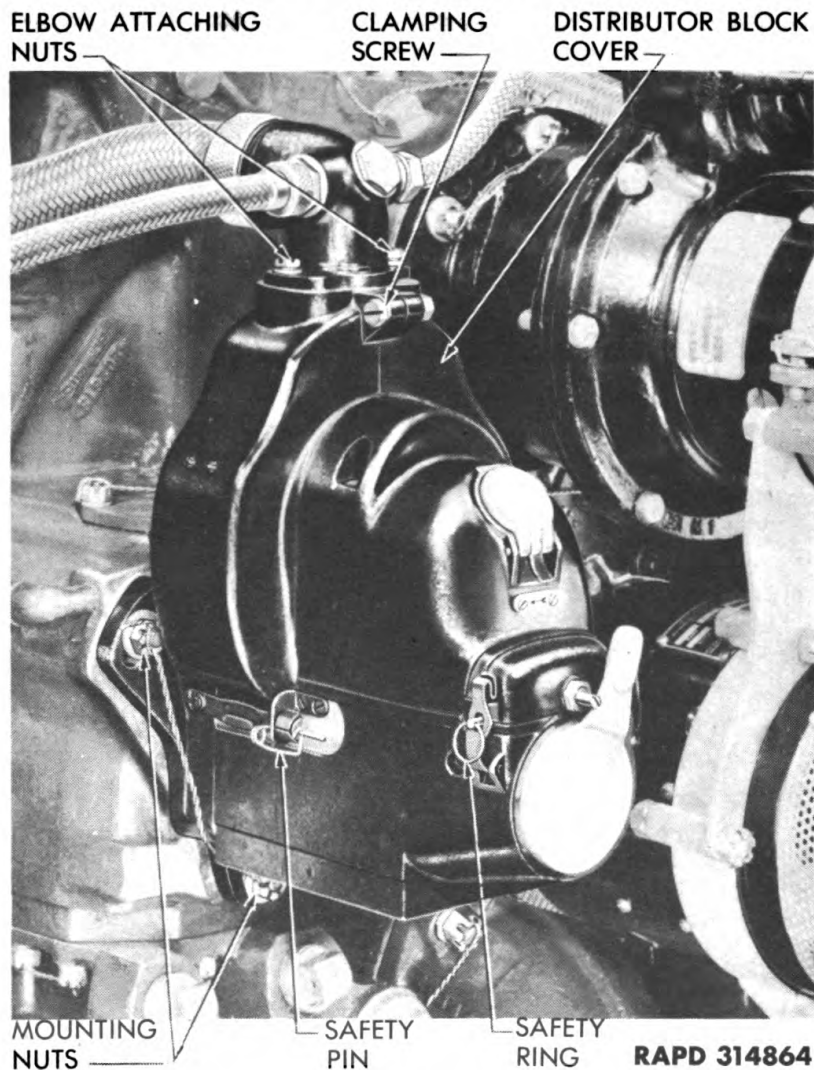
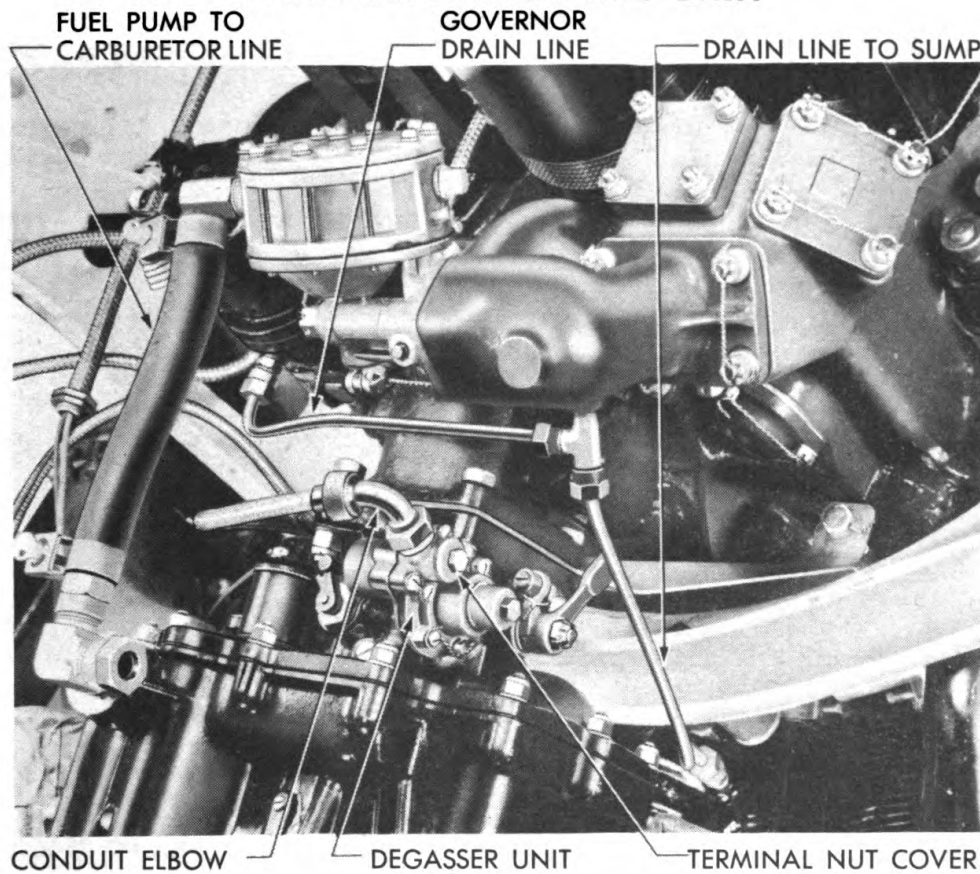

Figure 10 – Magneto Installed

gear which meshes with the generator drive gear and operates the generator.

(4) **ACCESSORY DRIVE GEARS.** The starter drive gear meshes with two accessory idler gears which, in turn, mesh with and drive two accessory drive gears (fig. 9). These drive gears are keyed to the forward ends of the accessory drive shafts which extend through the diffuser to the rear crankcase section.

(5) **RIGHT ACCESSORY DRIVE SHAFT.** A gear integral with the right accessory drive shaft operates the tachometer and three-way accessory drive. The tachometer and three-way accessory drive, in turn, drives the tachometer drive and the three-way accessory drive. The gear at the forward end of the tachometer and three-way accessory drive operates the tachometer drive. The gear at the rear end of

ENGINE DESCRIPTION AND DATA

RA PD 314685

Figure 11 – Fuel Pump Mounted

the tachometer and three-way accessory drive operates the three-way drive which, in turn, operates the fuel pump. Two additional openings in the three-way housing are available for driving other accessories. The right magneto is also driven by the right accessory drive shaft. The magneto drive gear is splined to a coupling attached to the rear end of the accessory drive shaft.

(6) **LEFT ACCESSORY DRIVE SHAFT.** A gear integral with the left accessory drive shaft operates the oil pump gear which drives the oil pump drive shaft and operates the oil pump mounted to the rear crankcase section. The left magneto is also driven by the left accessory drive shaft. The magneto drive gear is splined to a coupling at the rear end of the accessory drive shaft.

(7) **IMPELLER DRIVE GEAR.** The crankshaft gear (subpar. (1), above) also drives the impeller drive gear (fig. 9) through the medium of the smaller gear of a pair supported by an intermediate shaft bracketed to the front wall of the diffuser section. As the smaller gear turns the shaft, it causes the impeller drive gear to turn. This gear meshes with the impeller shaft gear to drive the impeller.

**ORDNANCE MAINTENANCE – ORDNANCE ENGINE
MODEL R975-C4 (CONTINENTAL)**

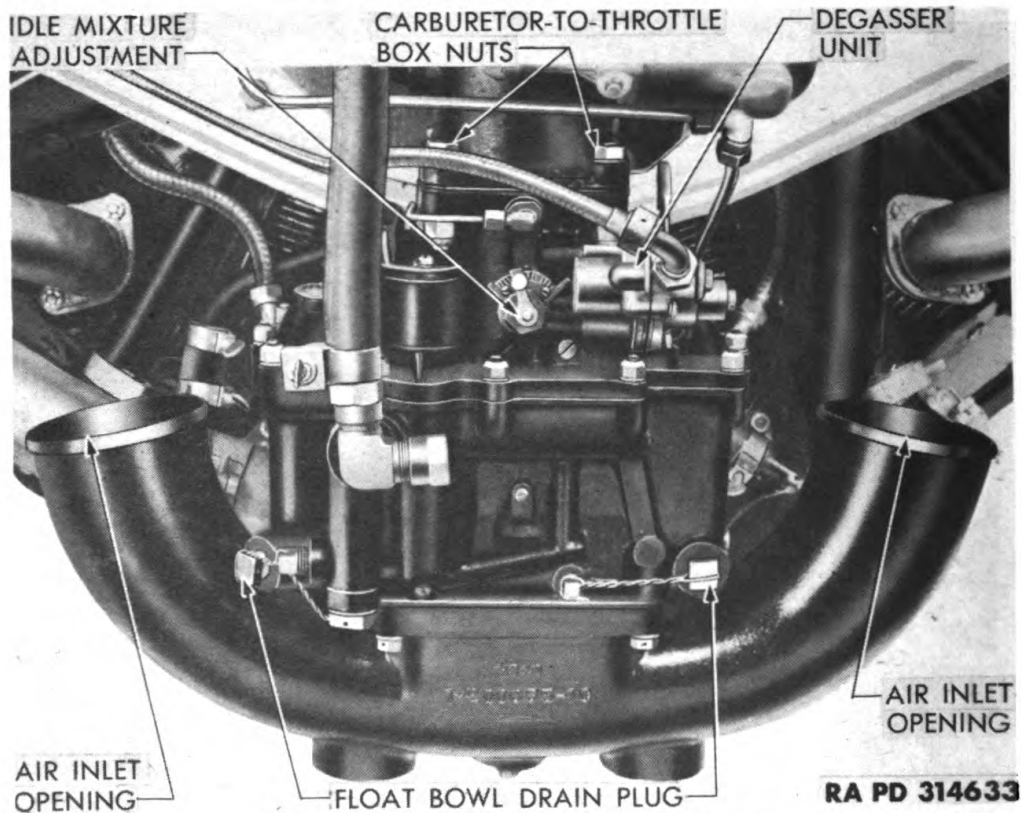

Figure 12 – Carburetor Mounted

k. Ignition System.

(1) **GENERAL.** This system provides the ignition which fires the spark plugs and ignites the fuel mixture in each cylinder. The ignition system consists of the ignition harness (fig. 192), and magnetos (fig. 3).

(2) **IGNITION HARNESS** (fig. 192). A shielded harness attached to the outside of the main crankcase section carries rubber-insulated ignition wires to the base of each cylinder. Individual shielded conduits carry the wires from the shielded harness to the shielded spark plugs.

(3) **MAGNETOS.** Ignition is furnished by two magnetos mounted on the rear crankcase section (fig. 10). The right-hand magneto fires the front spark plugs; the left-hand, the rear spark plugs. The magnetos turn at $1\frac{1}{8}$ crankshaft speed.

l. Fuel System.

(1) **GENERAL.** The principal parts of the fuel system are the fuel pump, carburetor, air horn, governor and throttle box, diffuser section, and induction tubes. Fuel for operating the engine is pumped from the fuel tank to the carburetor where it is mixed with air drawn in through the engine breathers and air horn. The fuel mixture is

ENGINE DESCRIPTION AND DATA

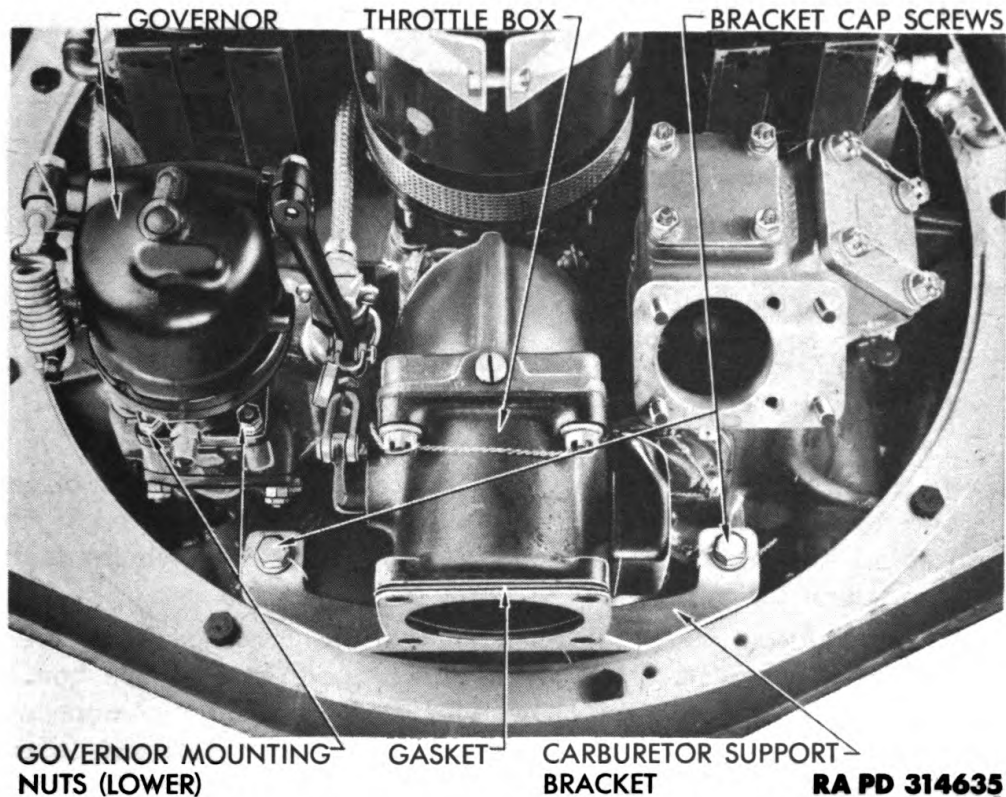

Figure 13 – Governor and Throttle Box

drawn by suction from the carburetor through the throttle box and governor (which controls the flow of the fuel mixture), through the carburetor elbow and rear crankcase section to the impeller. The impeller picks up the mixture and forces it through the directional vanes of the diffuser section to the distribution chamber. From here the mixture is forced under pressure, through induction tubes, into the cylinders and combustion chambers.

(2) **FUEL PUMP.** The fuel pump is mounted by means of an adapter attached to the three-way mounting pad on the accessory housing (fig. 11). The fuel pump is of the diaphragm type and controls the pressure of the fuel delivered to the carburetor. The pump is operated through a train of gears driven by the crankshaft gear.

(3) **CARBURETOR.** The carburetor is of the single, Venturi type mounted to an adapter elbow attached to the rear crankcase section and supported by a carburetor support bracket (fig. 13). The carburetor is fed from a single float chamber, incorporates a needle-type mixture control, and has an automatic fuel shut-off. The carburetor is also equipped with a built-in degasser which shuts off the flow of gas when the engine is decelerated quickly.

(4) **AIR HORN.** Air is inducted into the carburetor through breathers and an air horn. The breathers are air intakes in the vehicle itself. The air horn is bolted to the bottom of the carburetor

**ORDNANCE MAINTENANCE — ORDNANCE ENGINE
MODEL R975-C4 (CONTINENTAL)**

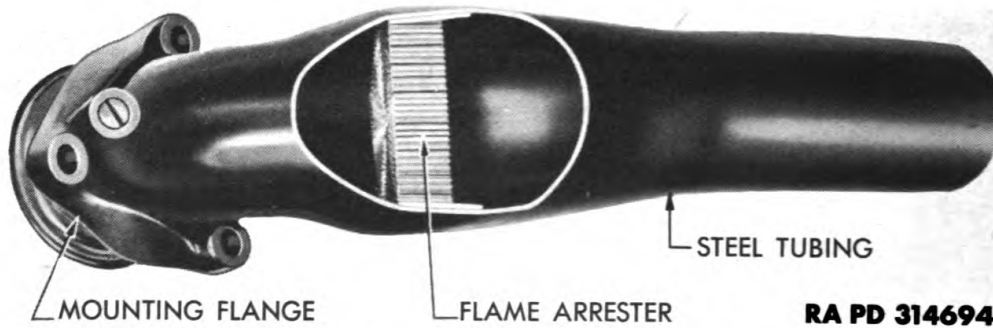

Figure 14 — Fuel Induction Tube

by four cap screws (fig. 12), and feeds air into the bottom of the carburetor. A suction line, between the carburetor throttle body and bottom of the air horn, picks up any raw gasoline which might accumulate in the air horn.

(5) **GOVERNOR AND THROTTLE BOX.** The governor is mounted on the oil pump accessory drive mounting pad; the throttle box to the carburetor adapter elbow (fig. 13). The governor is connected to the throttle box by linkage from the governor control arm to the throttle box valve arm (fig. 13). The governor is regulated to control the flow of fuel from the throttle box to prevent over-speeding the engine. It is of the fly-ball type and is driven at engine speeds. As the engine speed increases, the centrifugal force of the weights overcomes the tension of a spring, closing the valve in the throttle box. If engine revolutions per minute are below the set speed, spring tension overcomes the force of the flyweights, allowing the valve in the throttle box to open, thus increasing fuel flow to the engine and increasing engine speed.

(6) **DIFFUSER ASSEMBLY.** The diffuser, or impeller mechanism, speeds the delivery of the fuel mixture under pressure to the engine cylinders. The mechanism consists of the impeller, diffuser ring, and the diffuser and distribution chambers (fig. 158).

(7) **FUEL INDUCTION TUBES.** Fuel induction tubes are made of seamless steel tubing (fig. 14) and are joined to the distribution chamber by means of a rubber seal and gland nut. The flanged end of each tube is secured to the cylinder head, at the intake port, by three cap screws. A flame arrester designed to prevent backfire flames from entering the distribution chamber is incorporated into each fuel induction tube (fig. 14).

m. Engine Lubrication System.

(1) **GENERAL.** All moving contact surfaces of the engine, except ball and roller bearings, are lubricated by a pressure oil system. Ball and roller bearings are lubricated by splash.

ENGINE DESCRIPTION AND DATA

RA PD 314648

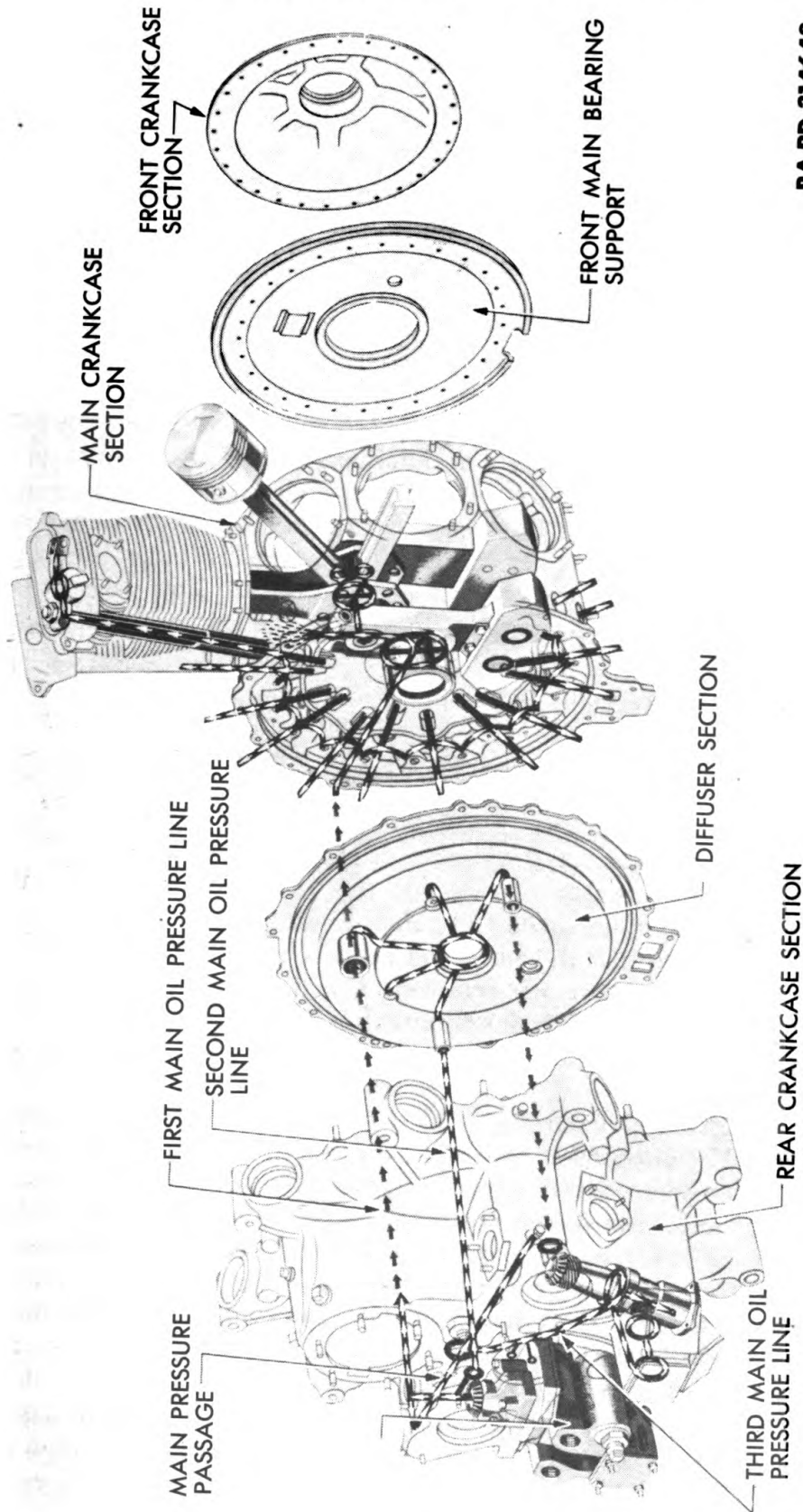

**ORDNANCE MAINTENANCE – ORDNANCE ENGINE
MODEL R975-C4 (CONTINENTAL)**

(2) **OIL PUMP** (fig. 184). Pressure feed, dry sump engines such as the R975-C4, require at least two oil pumps. One delivers oil to the engine, the other removes oil from the engine sump and returns it to the oil supply tank. Both oil pumps are combined in a single unit. Oil is pumped in by the pressure pump section and delivered to the engine at a pressure controlled by the adjustable relief valve. After the oil has performed its lubricating functions, it drains to a small sump at a low point in the crankcase. The scavenger pump section of the pump removes oil from the sump through a passage in the rear case. The capacity of the scavenger section of the pump is approximately 25 percent greater than the pressure pump. This assures removal of oil from the sump as fast as it accumulates. The outlet of the scavenger section of the pump delivers the oil back to the oil supply tank.

(3) **MAIN PRESSURE PASSAGE.** Oil is drawn from the external oil tank through an oil strainer in the oil pump and is forced under pressure into a passage in the crankcase rear section. This passage is the main supply for all oil pressure lines and is called the main pressure passage (fig. 15).

(4) **FIRST MAIN OIL PRESSURE LINE** (fig. 15).

(a) *Valve Mechanism.* Oil flows under pressure from the main pressure passage through a drilled hole to the main crankcase section. This hole terminates in an annular passage which runs completely around the main crankcase section. The hole through to the annular passage is known as the first main oil pressure line (fig. 15). Oil is forced from the annular passage to the valve tappet guides. When valve tappet oilholes index the guide holes, lubrication is forced into the tappets, through the push rod sockets and hollow push rods, to the rocker arms and rocker arm bearings, in the rocker boxes. Excess oil in the rocker boxes drains through oil drain pipes connected to the rocker boxes, and through the push rod housings and crankcase to the oil sump.

(b) *Camshaft Assembly.* Oil from the first main oil pressure line (fig. 15) also passes through a pressed-in tube in the main crankcase section to an annular groove in the crankshaft rear main bearing support. Oil flows under pressure from this groove, through drilled passages to the rear main bearing, and on into the hollow bearing journal from which a drilled hole conducts it to the hollow crankpin. Oil passes through the crankpin holes to the master rod bearing, and thence to the knuckle pins and knuckle pin bushings. Any excess oil on the knuckle pins is thrown off the pins and helps to splash-lubricate the cylinder walls, pistons, and piston pins. Cylinder walls, pistons, and piston pins are also lubricated by oil which flows through a spray hole in the rear end of the crankpin.

ENGINE DESCRIPTION AND DATA

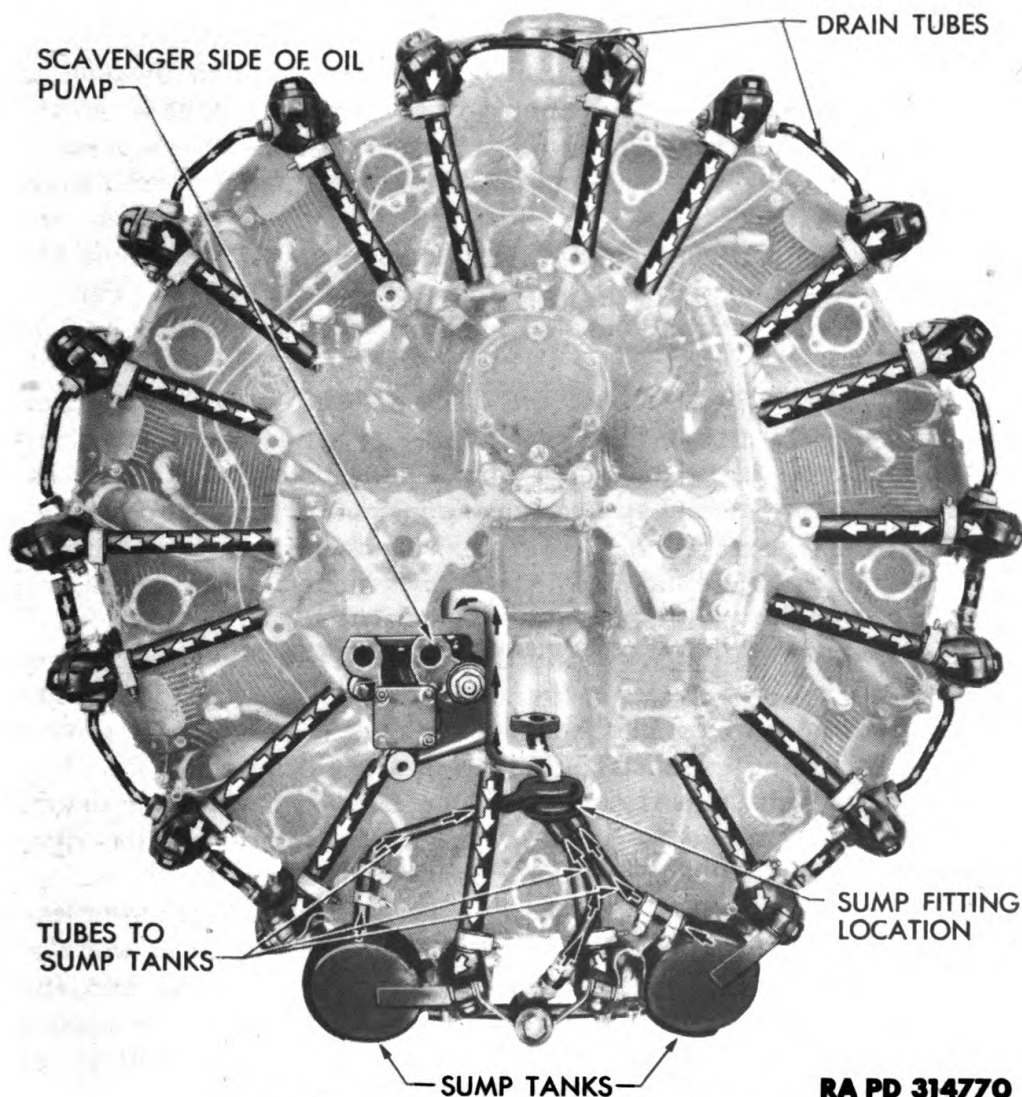

RA PD 314770

Figure 16 – Oil Scavenger System

(c) *Cam Assembly.* Oil flows from the annular groove in the crankshaft rear main bearing support, through a groove in the cam hub bearing support, and lubricates the cam hub bearing. Oil from the cam and cam hub bearing helps to oil the valve tappets and valve tappet guides.

(d) *Front Main and Thrust Bearings.* These bearings receive a sufficient amount of lubrication by splash. Oil from the main crankcase section lubricates the main bearing, and oil passing through the bearing into the front crankcase section lubricates the thrust bearing.

(5) SECOND MAIN OIL PRESSURE LINE.

(a) *General.* The second main oil pressure line consists of a hole drilled from the first main oil line to the left accessory shaft bushing and through the length of the accessory shaft (fig. 15). Oil flowing

**ORDNANCE MAINTENANCE – ORDNANCE ENGINE
MODEL R975-C4 (CONTINENTAL)**

under pressure from the main pressure passage, through the second main oil pressure line, lubricates the accessory drive mechanism in the diffuser section, and two gear bushings in the rear crankcase section.

(b) *Left Accessory Drive Gear Bushing.* From the second main oil pressure line (fig. 15), oil flows under pressure through two holes in the forward part of the left accessory drive shaft, and fills an annular groove on the outside diameter of the shaft. The oil lubricates the shaft front bushing and passes into a drilled hole in the diffuser section casting.

(c) *Accessory Drive Mechanism.* The hole in the diffuser section conducts oil to a groove parallel with the circumference of the impeller shaft hole in the diffuser section. The groove is sealed at assembly by the impeller shaft bearing support, and supplies oil through radially drilled passages in the diffuser section casting, to the accessory drive idler gears, impeller drive gear bushings, starter shaft, and the right accessory drive shaft.

(d) *Right Accessory Drive Shaft Bushings.* Oil flows from one of the radially drilled passages in the diffuser section casting to the right accessory drive bushing in the diffuser section. An annular groove within the bushing conducts the oil to a hole in the right accessory drive shaft. This hole is similar to the hole in the left accessory drive shaft. Oil flows the length of the shaft to lubricate the right accessory drive shaft bushing in the rear crankcase section.

(e) *Starter Shaft Rear Bushing.* Oil flows from another of the radially drilled passages in the diffuser section casting to an annular recess formed between the starter shaft forward bushing and the starter shaft. From this recess, the oil passes through the starter shaft rear bushing and through a longitudinal groove at the top of the bushing, lubricating the starter shaft rear bushing. Oil escaping from the bushing lubricates the generator, idler, and drive gears by splash.

(6) **THIRD MAIN OIL PRESSURE LINE.**

(a) *General.* The third main oil pressure line consists of a hole drilled directly across the rear main crankcase section casting (fig. 15). Two outlets lead from this line. One leads to an annular groove on the outside diameter of the generator drive gear support. The other leads down to the generator support pad. Oil flowing under pressure from the main pressure passage through the third main oil pressure line lubricates the accessory drive mechanisms in the rear crankcase section.

(b) *Generator Idler Gear Shaft and Bushing.* Oil flows through a drilled passage in the generator idler gear shaft which cuts into the main pressure passage. It flows out of a hole drilled in the forward part of the shaft to lubricate the generator idler gear shaft and bushing.

ENGINE DESCRIPTION AND DATA

(c) *Generator Drive Gear Shaft and Bushing.* Oil flows from the third main oil pressure line (fig. 15) through a drilled hole in the rear crankcase casting, which conducts the oil to the generator drive gear support. One of two holes in the support leads the oil to the generator drive gear shaft and bushing.

(d) *Tachometer and Fuel Pump Drive Gear Shaft and Bushings.* A second hole drilled through the generator drive gear support conducts lubrication to another drilled passage leading to the tachometer and fuel pump adapter. The oil lubricates the tachometer and fuel pump drive gear shaft and bushing.

(7) **OIL SCAVENGER SYSTEM** (fig. 16). Oil drains into the main crankcase section from the other crankcase sections through indexing holes and slots, and to the sump fitting in the rear bottom of the main crankcase section. Oil in the front crankcase section drains to the sump fitting in the forward bottom part of the main crankcase section. The oil is picked up from the sump fitting by the scavenger section of the oil pump and drawn through a passage, which runs through the main, diffuser, and rear crankcase sections. The pump forces the oil back to the oil supply reservoir in the vehicle. Oil which has drained down to the sump tanks is drawn up through tubes to the sump fittings.

4. DATA.

a. General.

| | |
|---------------------------------------|--|
| Make | Continental |
| Model | R975-C4 |
| Type | Single-row, static-radial, air-cooled |
| Number of cylinders | 9 |
| Bore and stroke | 5.00 x 5.50 |
| Piston displacement | 973 cu in. |
| Compression ratio | 5.7 to 1 |
| Rated bhp | 485 @ 2,400 rpm |
| Governed speed | 2,300 rpm |
| Crankshaft rotation (from rear) | Clockwise |
| Crankshaft spline size | S.A.E. No. 30 |
| Mounting bracket: | |
| Diameter of circle | 23 ³ / ₈ in. |
| Number of bolts | 9 |
| Size of bolts | 7 ¹ / ₁₆ in. |
| Dry weight of engine (basic) | 750 lb |
| b. Valves. | |
| Timing | (set at 0.070 in. cold) |
| Intake opens | 8° B.T.C. |
| Intake closes | 34° A.B.C. |

**ORDNANCE MAINTENANCE – ORDNANCE ENGINE
MODEL R975-C4 (CONTINENTAL)**

Exhaust opens 56° B.B.C. (+ or - 4°)
 Exhaust closes 19° A.T.C.
 Valve clearance, service 0.006 in., cold

c. Cylinder Temperatures.

Cylinder head temperature
 Normal maximum 450° F.
 Maximum, for short periods 500° F.
 Cylinder barrel temperature, maximum 350° F.

d. Ignition.

(1) MAGNETOS.

Make Scintilla
 Type VAG9DFA
 Rotation Counterclockwise
 Speed 1.125 to 1
 Firing position, right magneto at full advance fires at 29° B.T.C.
 Firing position, left magneto at full advance fires at 26° B.T.C.

(2) SPARK PLUGS. Champion 63S

(3) GENERATOR.

Make Bendix-Eclipse
 Model 31

(4) STARTER.

Make Delco-Remy
 Model 1108685

(5) BOOSTER COIL.

Make Delco-Remy
 Model 1115482
 Make Auto-Lite
 Model BC-400

e. Fuel System.

(1) CARBURETOR.

Make Stromberg
 Model NA-R9G

(2) FUEL PUMP.

Make AC
 Model GP-11972

(3) GOVERNOR.

Make Pierce
 Model Ma1522

(4) PRIMER.

Make CMC
 Priming system connections 1/8-in. standard pipe

(5) FUEL SPECIFICATION. U. S. Army 2-103A

Octane rating 80

ENGINE DESCRIPTION AND DATA

Fuel pressure 3½ to 5 lb
 Carburetor connection ½-in. standard pipe

f. Lubrication System.

Oil pump Continental
 Oil consumption, @ rated power 0.025 lb per bhp per hr
 Oil inlet and outlet connections ¾-in. standard pipe
 Oil flow 14-22 lb/min/
 Oil pressure @ 2,400 rpm 75 lb + or - 5 lb
 Oil pressure at idling speed (800 rpm) 35 lb + or - 5 lb
 Oil specification:
 Viscosity, above 32° F. S.A.E. 50
 Viscosity, below 32° F. S.A.E. 30

**ORDNANCE MAINTENANCE — ORDNANCE ENGINE
MODEL R975-C4 (CONTINENTAL)**

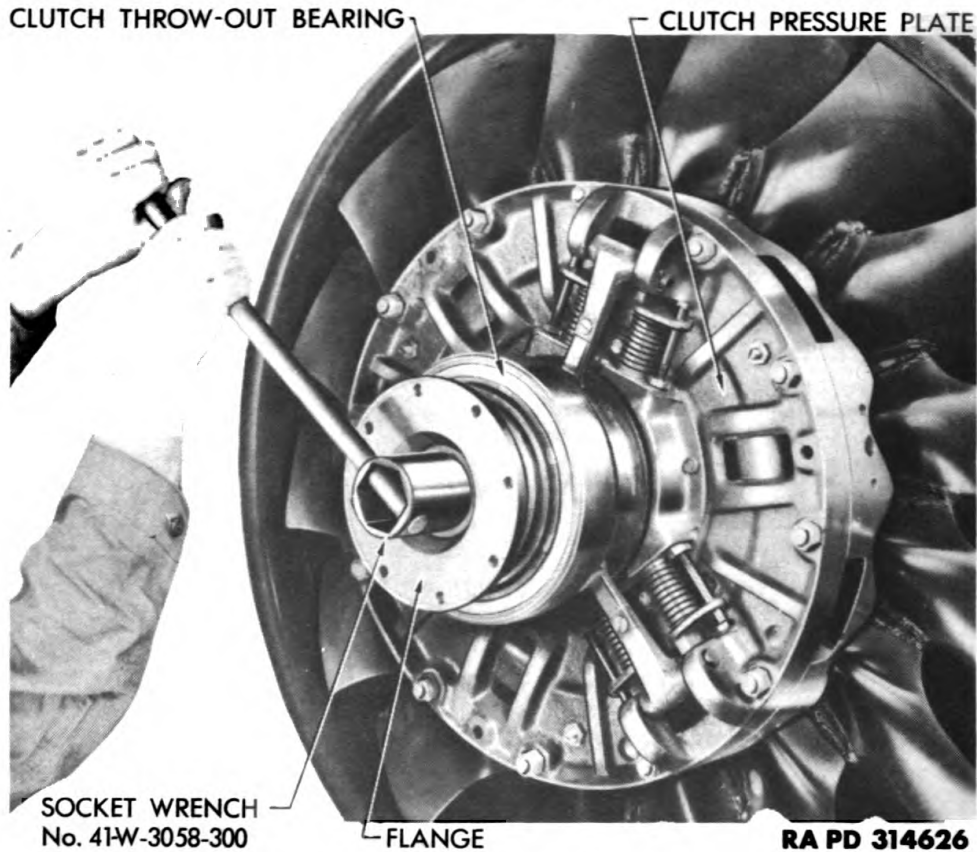

Figure 17 — Removing Clutch Spindle Flange Retaining Nut

CHAPTER 3

DISASSEMBLY OF ENGINE INTO SUBASSEMBLIES

| | Paragraph |
|---|-----------|
| Preliminary instructions | 5 |
| Clutch, flywheel, and fan removal | 6 |
| Accessories, removal | 7 |
| Engine supports, collector ring, and cowling, removal | 8 |
| Front and main crankcase sections, removal | 9 |
| Rear crankcase and diffuser sections, removal | 10 |

5. PRELIMINARY INSTRUCTIONS.

a. Mount Engine on Stand. Install engine on a suitable rotating mounting stand.

b. Clean Exterior of Engine. Plug all openings to interior of engine. Remove all dirt and grease from exterior of engine with dry-cleaning solvent or with steam. Do not steam-clean engine except just before disassembly as remaining steam condensation might cause rust.

DISASSEMBLY OF ENGINE INTO SUBASSEMBLIES

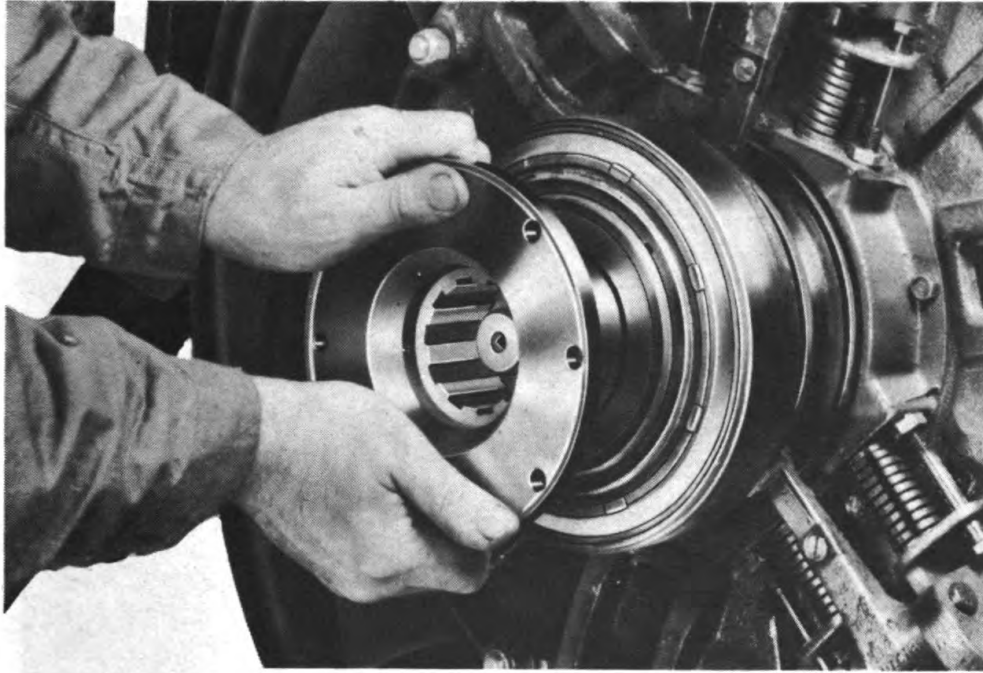

RA PD 314768

Figure 18 – Removing Clutch Spindle Flange

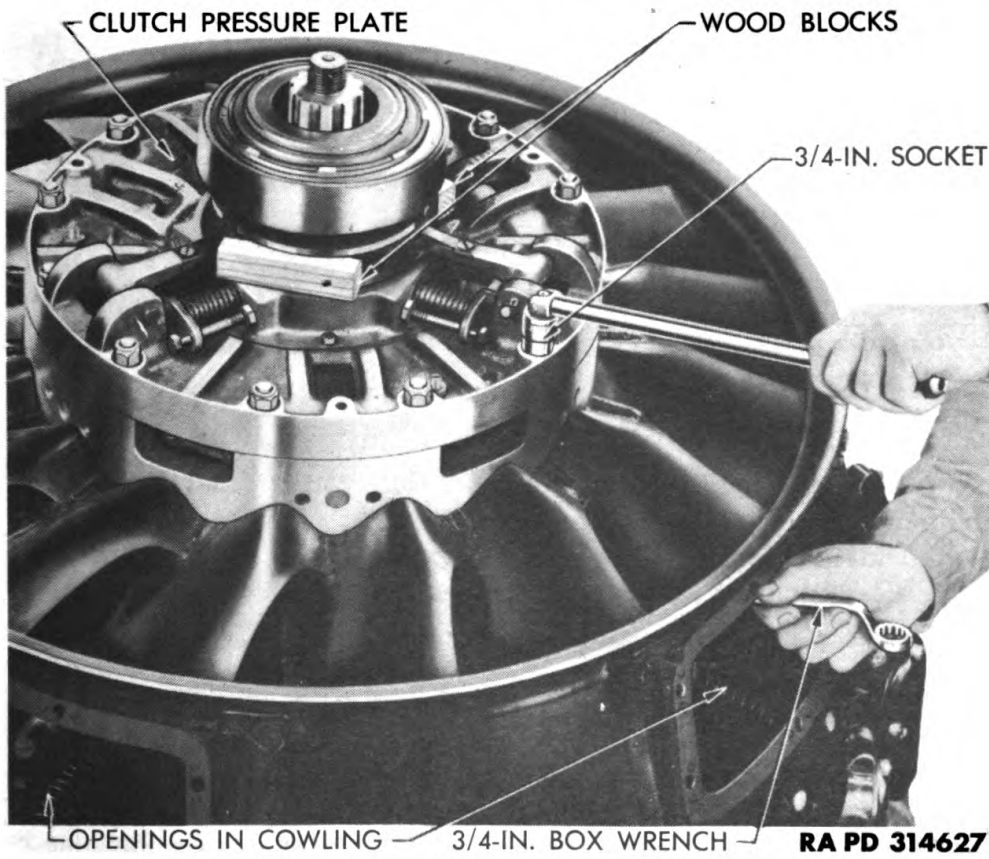

Figure 19 – Removing Clutch Pressure Plate Retaining Nuts

**ORDNANCE MAINTENANCE – ORDNANCE ENGINE
MODEL R975-C4 (CONTINENTAL)**

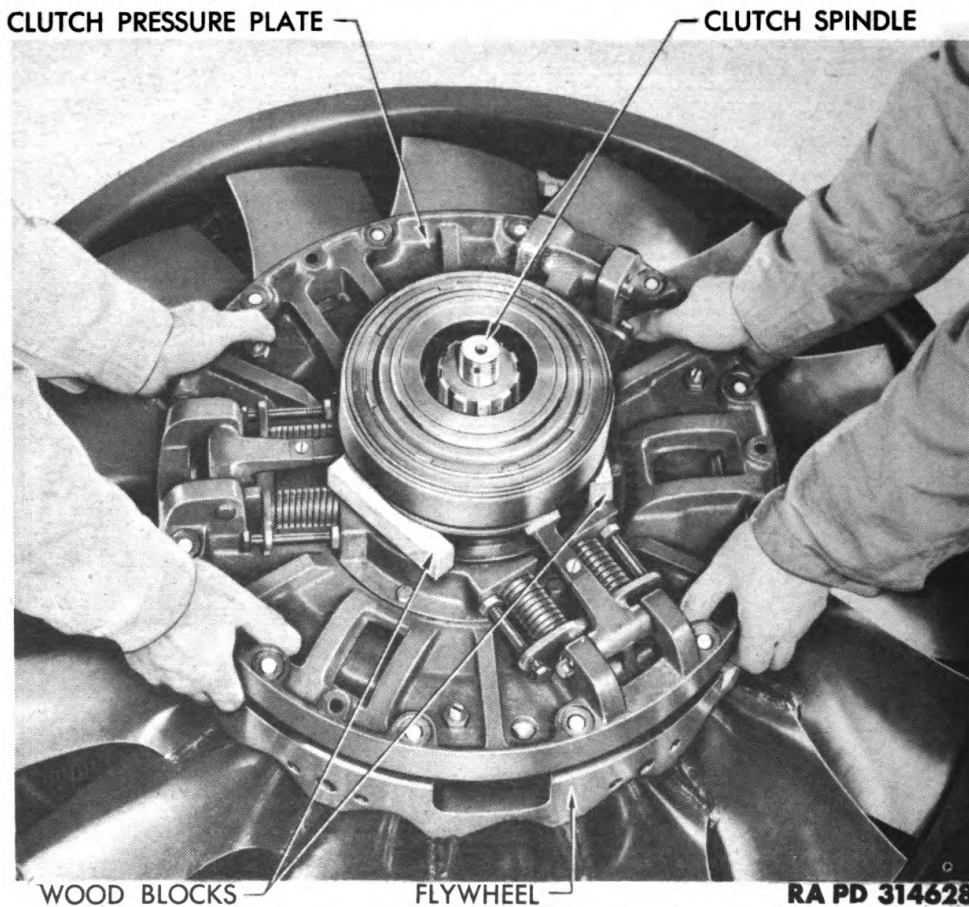

Figure 20 – Removing Flywheel Ring and Clutch Pressure Plate

As subassemblies are removed from engine, place them on a wooden, or composition top inspection bench covered with paper to prevent possible damage to engine parts.

6. CLUTCH, FLYWHEEL, AND FAN REMOVAL.

a. **Remove Clutch Spindle Flange.** Pull cotter pin from flange retaining nut, and remove nut (fig. 17), using wrench (41-W-3058-300). Pull flange straight off clutch spindle (fig. 18). If necessary, use a standard bearing puller to remove flange.

b. **Remove Flywheel Ring and Pressure Plate.** With screwdriver, loosen six Dzus fasteners from each of four covers attached to engine cowling (fig. 19). Remove four covers. Insert two snug fitting wood blocks between clutch throw-out bearing flange and face of pressure plate. Reach through cover openings, one at a time, with $\frac{3}{4}$ -inch wrench and hold bolt heads (fig. 19). Loosen 12 nuts on bolts which hold flywheel ring and pressure plate to flywheel. Remove nuts. Install jack screws through three holes in flywheel ring. Turn

DISASSEMBLY OF ENGINE INTO SUBASSEMBLIES

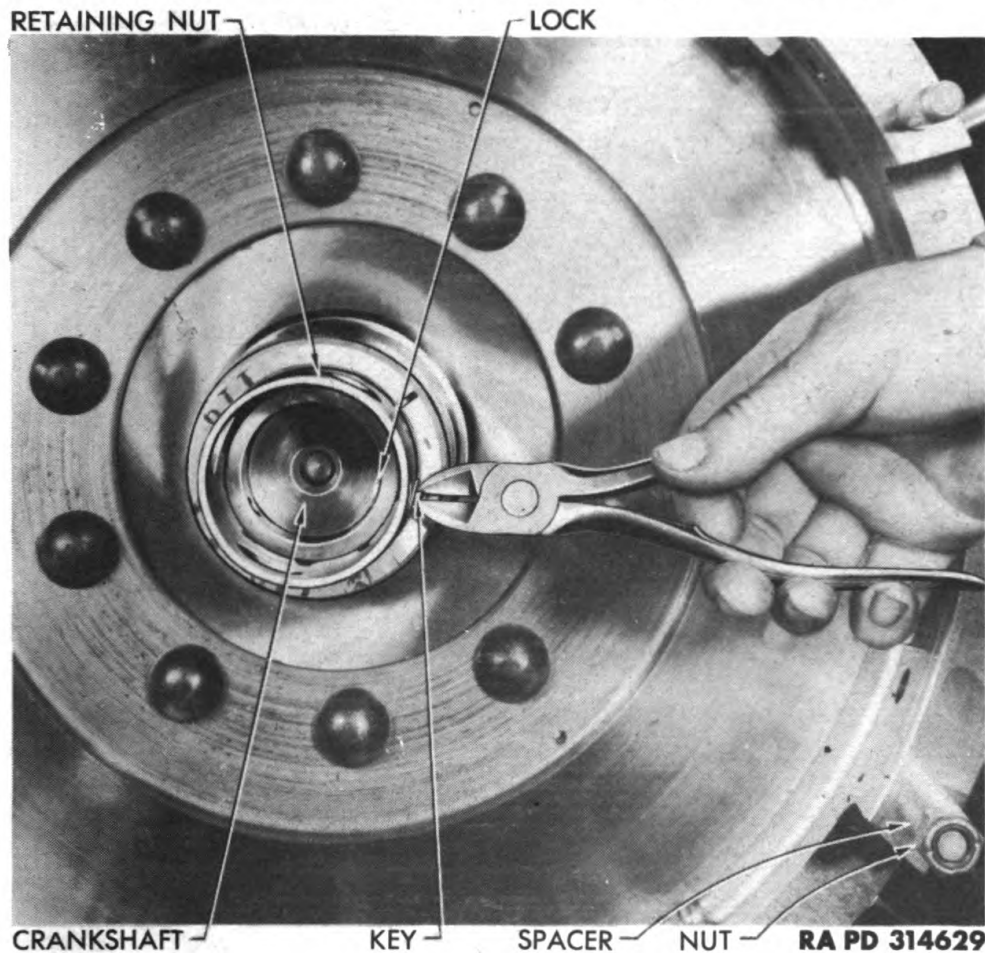

Figure 21 – Removing Cotter Pin from Front Cone Nut Retaining Pin

screws in to separate flywheel ring and pressure plate from flywheel. Lift flywheel ring and pressure plate assembly from engine (fig. 20). The clutch spindle, driven disks, and drive plate, may come out with the pressure plate assembly, so handle carefully to prevent damaging any of these parts.

c. Remove Clutch Parts. If these parts did not come out with the pressure plate, remove clutch outer driven disk. Prick-punch clutch drive plate and flywheel to insure alinement during reassembly (fig. 251). Remove drive plate, inner driven disk, and clutch spindle.

d. Remove Flywheel and Fan Assembly. Remove cotter pin from the retaining pin which locks the front cone nut on crankshaft, and remove washer and retaining pin (fig. 21). Insert bar through holes in front cone nut; loosen and remove nut (fig. 22) and split cone. Using a lifting eye (fig. 23), or with the help of another person, lift or slide flywheel and fan assembly off crankshaft splines (fig. 24). Screw protector cap on threads at end of crankshaft.

**ORDNANCE MAINTENANCE – ORDNANCE ENGINE
MODEL R975-C4 (CONTINENTAL)**

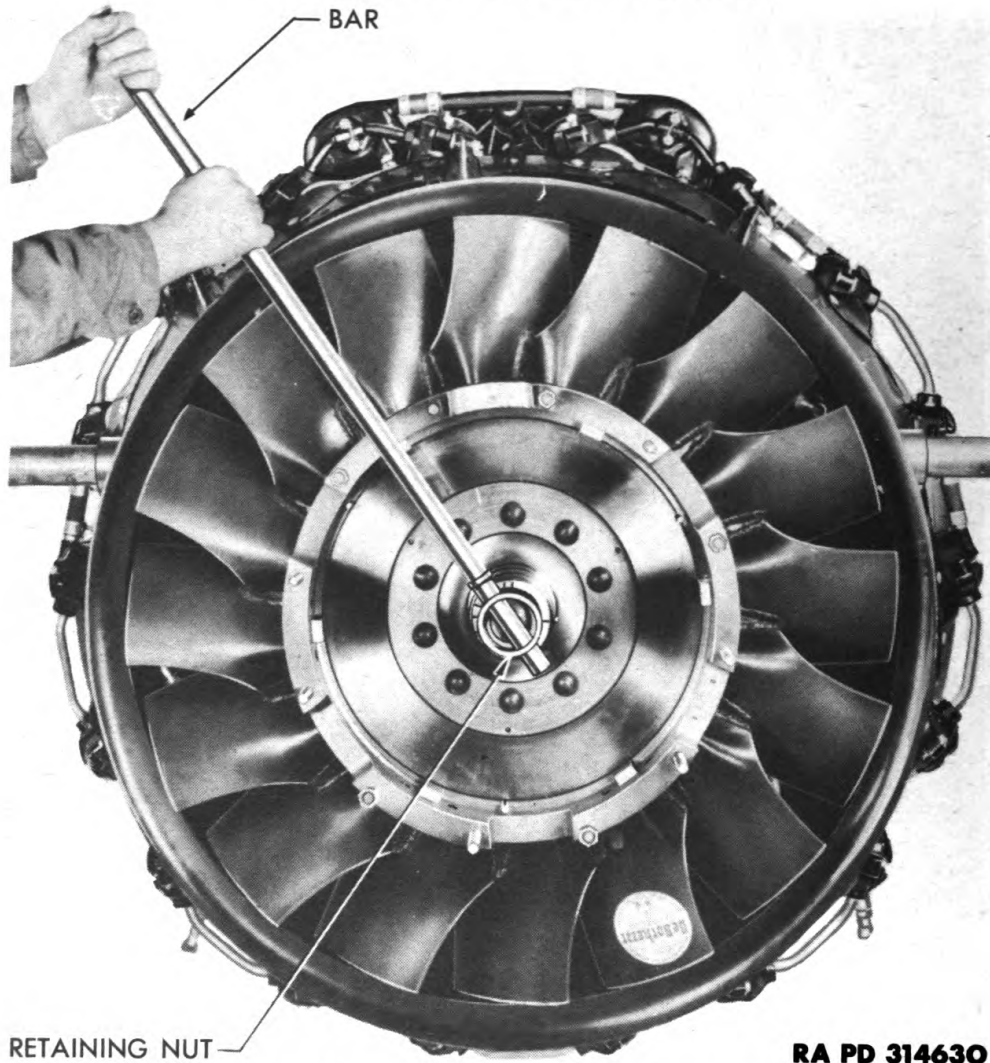

RA PD 314630

Figure 22 – Removing Flywheel Front Cone Nut

7. ACCESSORIES, REMOVAL.

a. Remove Fuel and Drain Lines. Start at rear of engine. Loosen clamps at both ends of hose connecting fuel pump and carburetor. Remove hose (fig. 11). Disconnect fittings at each end of drain line running from governor to fuel pump adapter elbow. Remove drain line (fig. 11). Disconnect fittings at each end of drain line running from fuel pump adapter elbow to sump. Remove drain line (fig. 11).

b. Remove Conduit at Carburetor. Loosen elbow nut on conduit elbow, and pull conduit back. Unscrew and remove upper cap from degasser unit (fig. 11). Remove nut, lock washer, and plain washer which secure wire terminal to terminal post. Remove terminal from post. Pull out wire. Remove clip holding conduit to rear engine support and slip conduit off wire (fig. 11). **CAUTION: Rein-**

DISASSEMBLY OF ENGINE INTO SUBASSEMBLIES

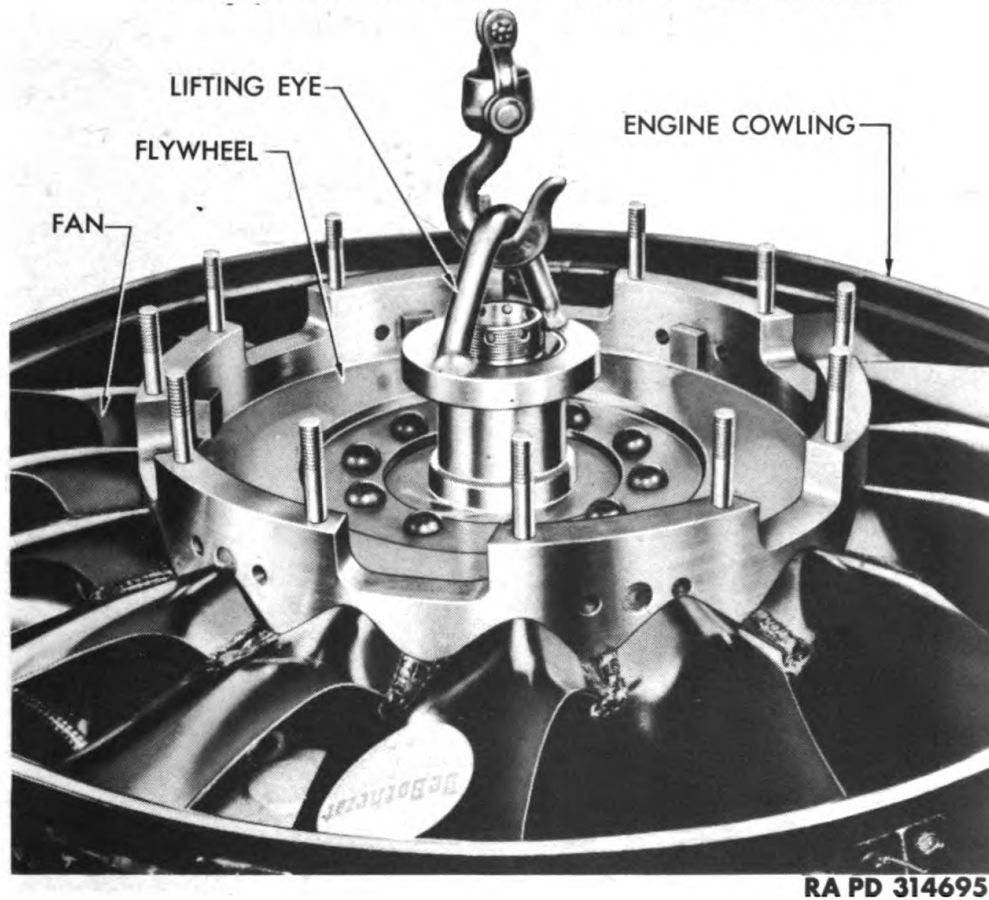

Figure 23 – Removing Flywheel and Fan Assembly with Lifting Eye

stall plain washer, lock washer, and nut on terminal post. Replace upper cap on degasser unit so that these will remain with carburetor assembly.

c. Remove Fuel Pump. Cut and remove safety wires. Remove four nuts and washers from studs which hold fuel pump adapter elbow to mounting pad for three-way accessory drive housing (fig. 25). Remove fuel pump and elbow from engine as an assembly. Pull fuel pump drive gear from square adapter on drive gear shaft, to eliminate the possibility of the gear falling out and being damaged.

d. Remove Carburetor. Cut and remove lock wire from carburetor attaching nuts. Support carburetor adequately, and remove four nuts, and flat washers from bolts holding carburetor to throttle box (fig. 12). Remove carburetor and composition gasket.

e. Remove Carburetor Support Bracket. Cut and remove safety wires from two cap screws holding carburetor support bracket to each side of rear crankcase section (fig. 13). Remove cap screws and washers. Remove bracket and composition gasket from throttle box.

**ORDNANCE MAINTENANCE — ORDNANCE ENGINE
MODEL R975-C4 (CONTINENTAL)**

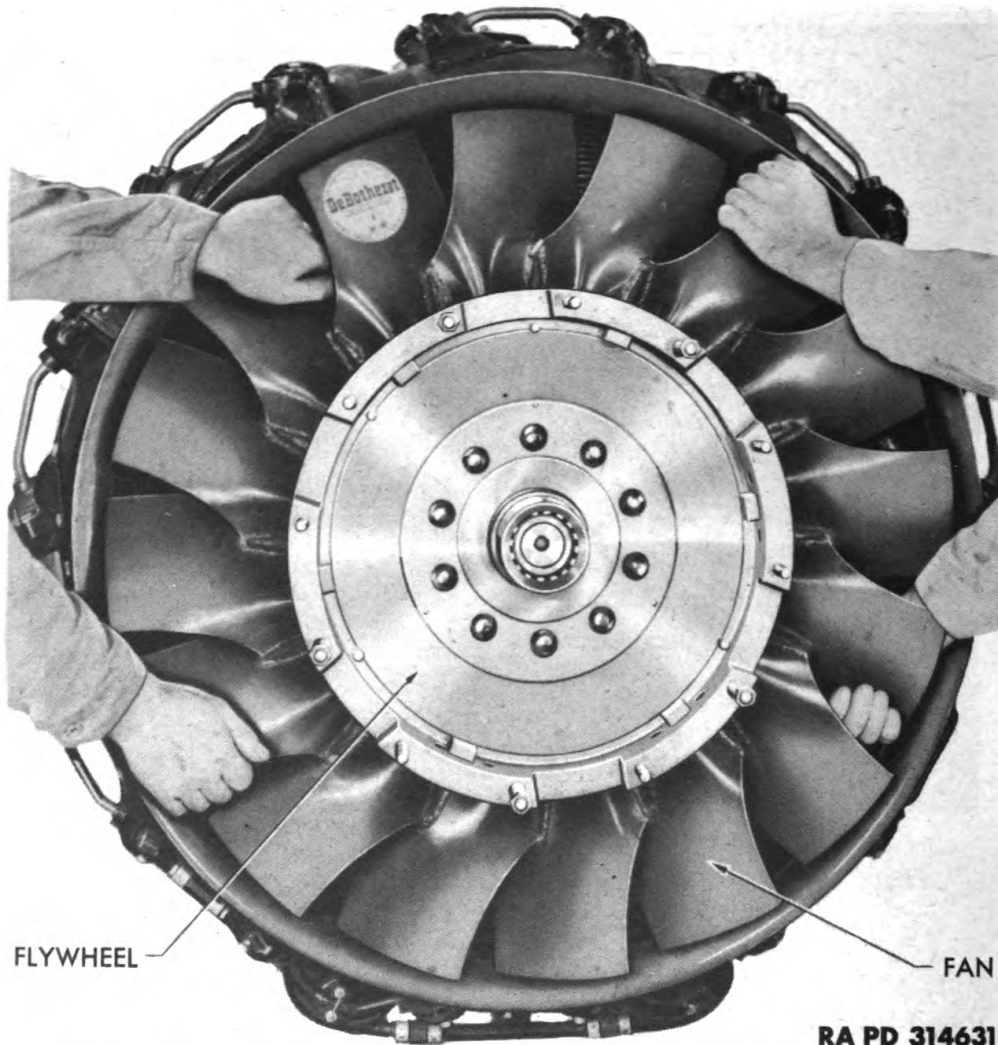

Figure 24 — Removing Flywheel and Fan Assembly

f. Remove Throttle Box. Remove cotter pin from lower clevis pin of linkage connecting governor and throttle box. Pull out clevis pin and remove washer (fig. 26). Cut and remove safety wires. Remove four nuts and washers from studs which secure throttle box to carburetor elbow. Lower throttle box and gasket, and remove from studs on carburetor elbow.

g. Remove Magneto Shielding. Cut both magneto ground wires and the primary booster coil wire as close to loose terminal ends as possible (fig. 3). Unscrew nut attaching shielding to left magneto outer elbow (fig. 27). Remove shielding from over three cut wires. Coil left magneto ground wire, and attach coil to left magneto elbow. Unscrew nuts attaching inner elbow shielding to both magnetos (fig. 27). Pull right magneto ground wire and primary booster coil

DISASSEMBLY OF ENGINE INTO SUBASSEMBLIES

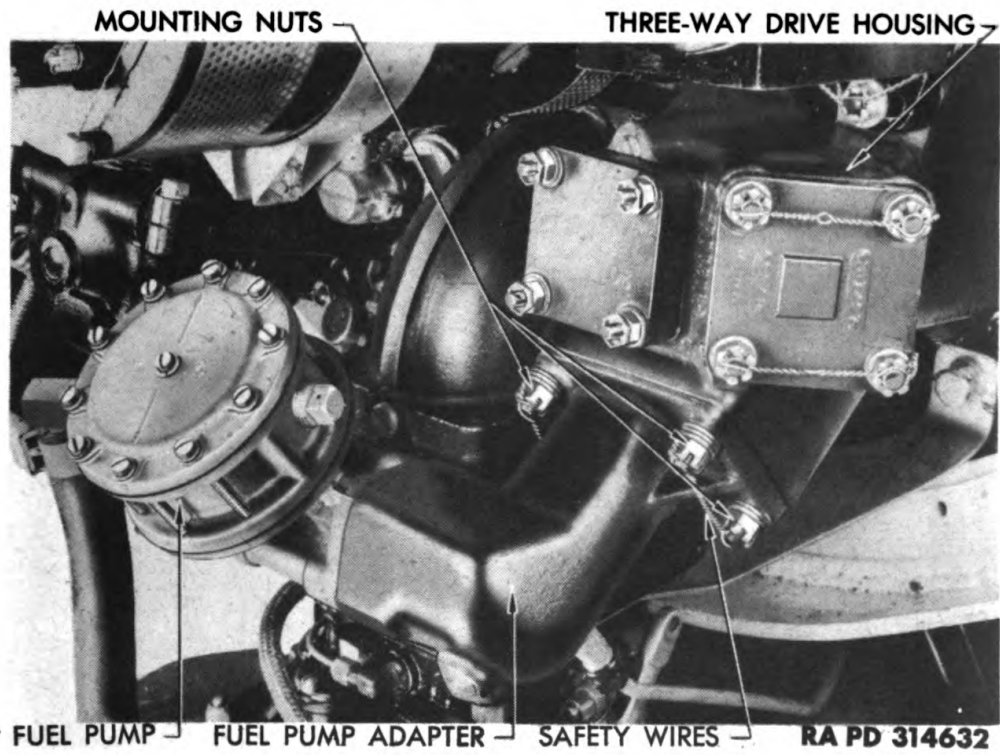

Figure 25 – Fuel Pump

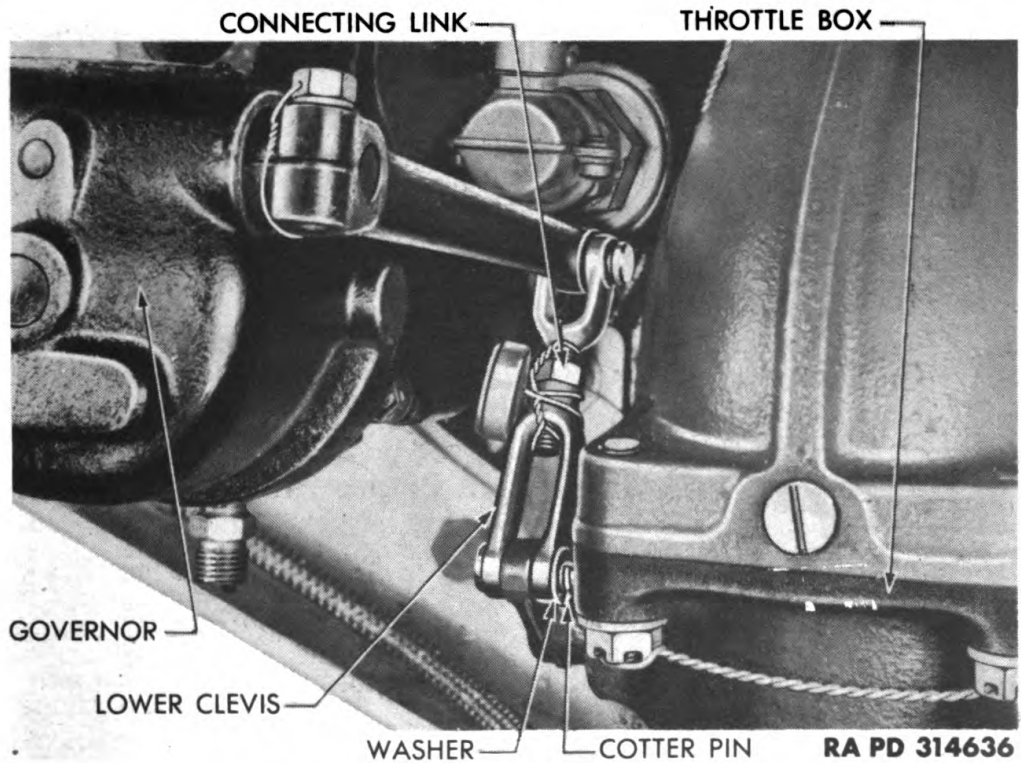

Figure 26 – Governor Linkage

ORDNANCE MAINTENANCE – ORDNANCE ENGINE
MODEL R975-C4 (CONTINENTAL)

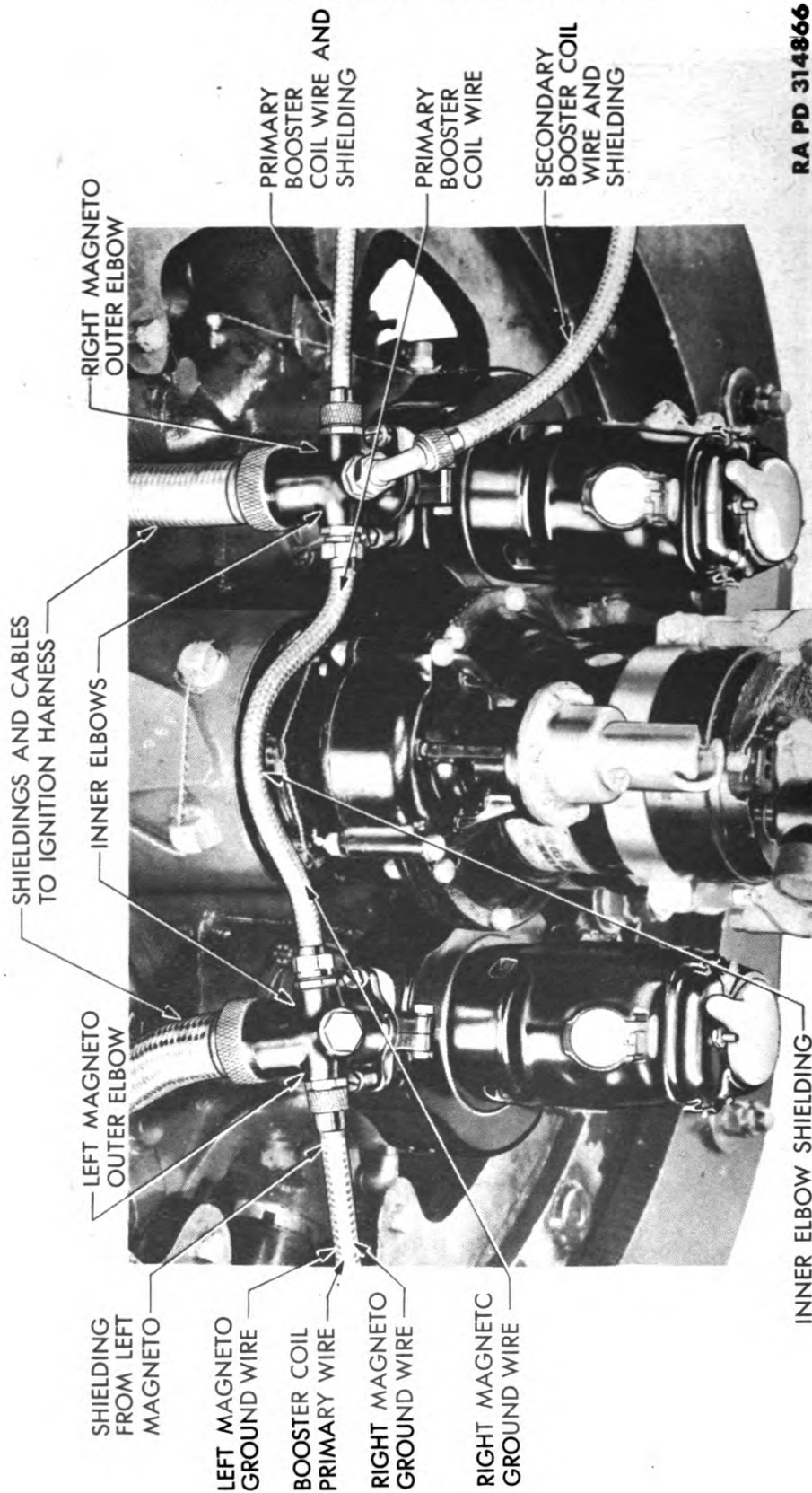

Figure 27 – Magneto and Booster Coil Shielding

DISASSEMBLY OF ENGINE INTO SUBASSEMBLIES

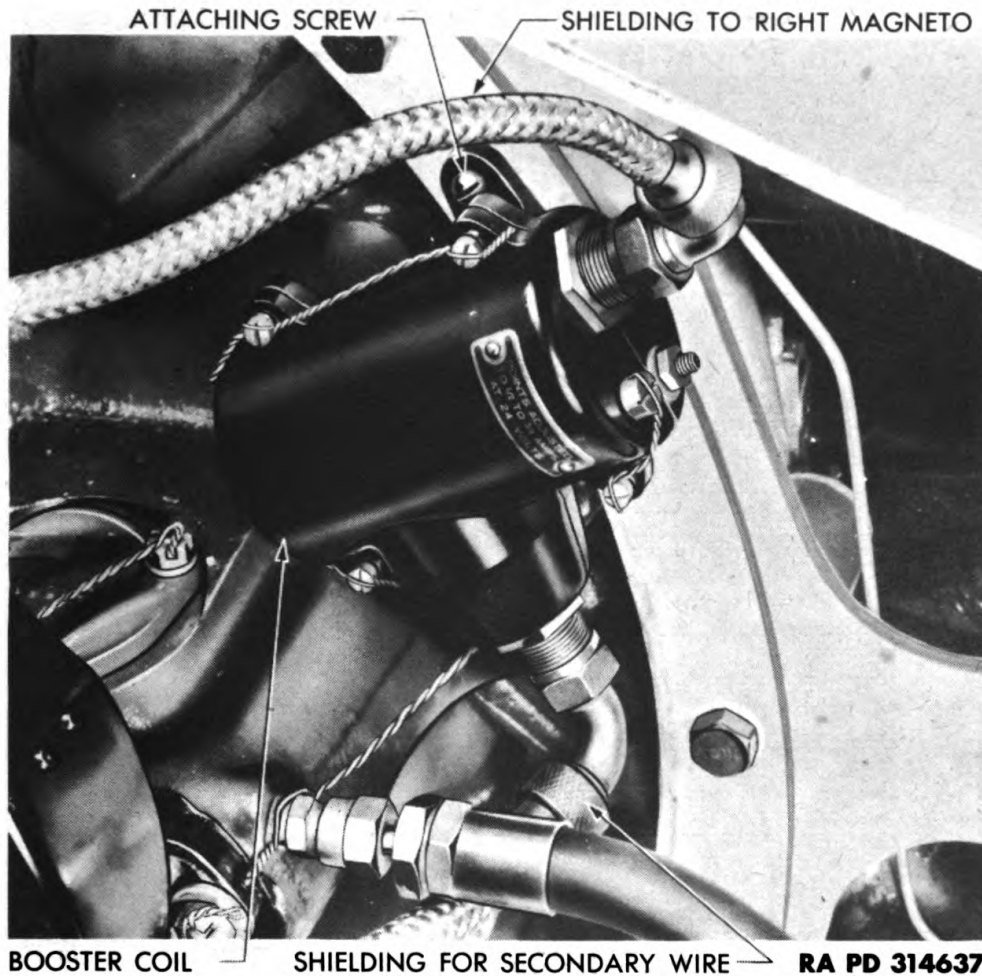

Figure 28 – Booster Coil

wire through left magneto elbow. Remove inner elbow shielding. Coil right magneto ground wire and attach coil to right magneto elbow. Unscrew nut attaching shielding for primary booster coil wire to right magneto outer elbow (fig. 27), and knurled nut attaching shielding to booster coil (fig. 28). Pull primary wire through right magneto elbow and remove shielding. Coil primary wire and attach to booster coil.

h. Remove Booster Coil. Unscrew nut holding shielding for secondary booster coil wire to booster coil (fig. 28). Disconnect shielding elbow from coil, by unscrewing elbow hexagonal nut and pulling out elbow and cigarette connector. Remove connector from end of secondary wire. Unscrew nut attaching shielding for secondary wire to front of right magneto elbow (fig. 27). Slide off shielding. Coil secondary wire, and attach coil to right magneto elbow. Remove two fillister-head screws holding booster coil to engine support. Remove screws and toothed lock washers; remove coil (fig. 28).

i. Remove Starter. Remove cotter pins from eight nuts which

**ORDNANCE MAINTENANCE — ORDNANCE ENGINE
MODEL R975-C4 (CONTINENTAL)**

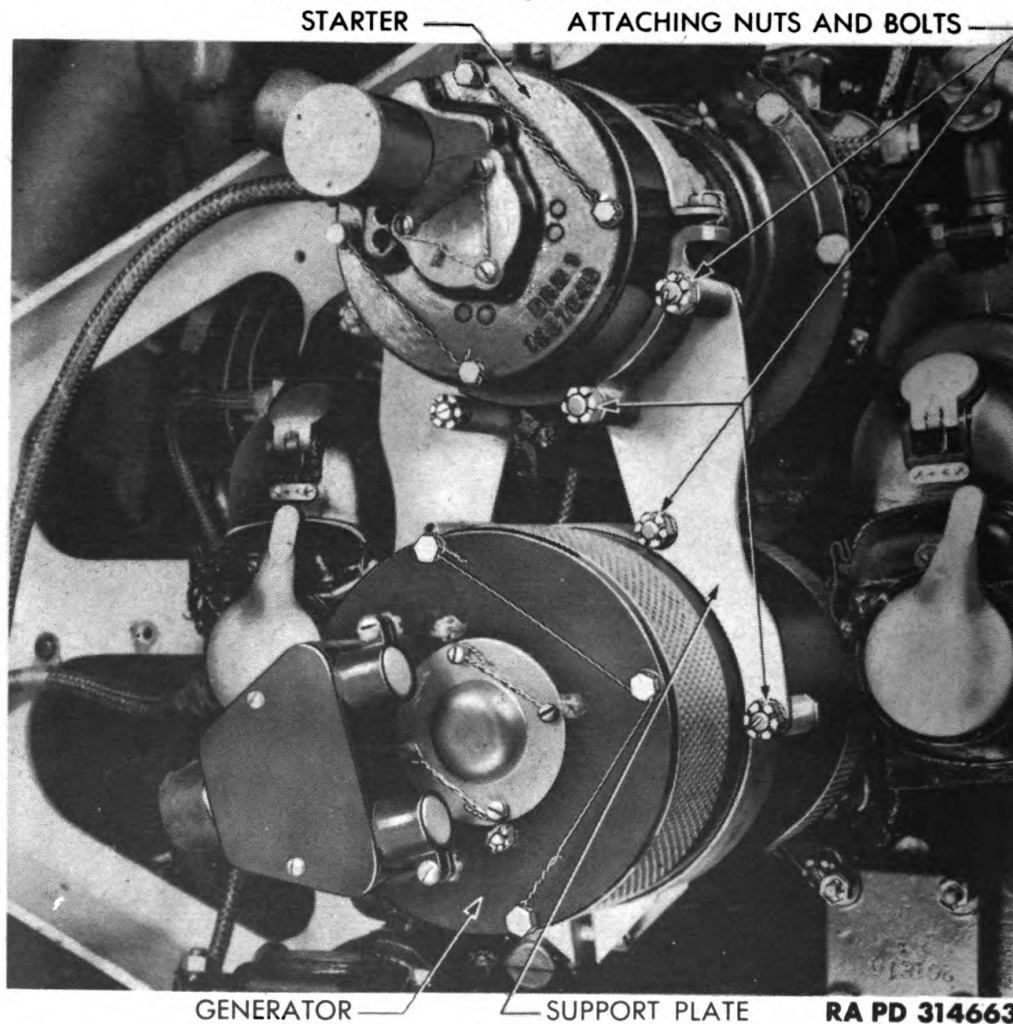
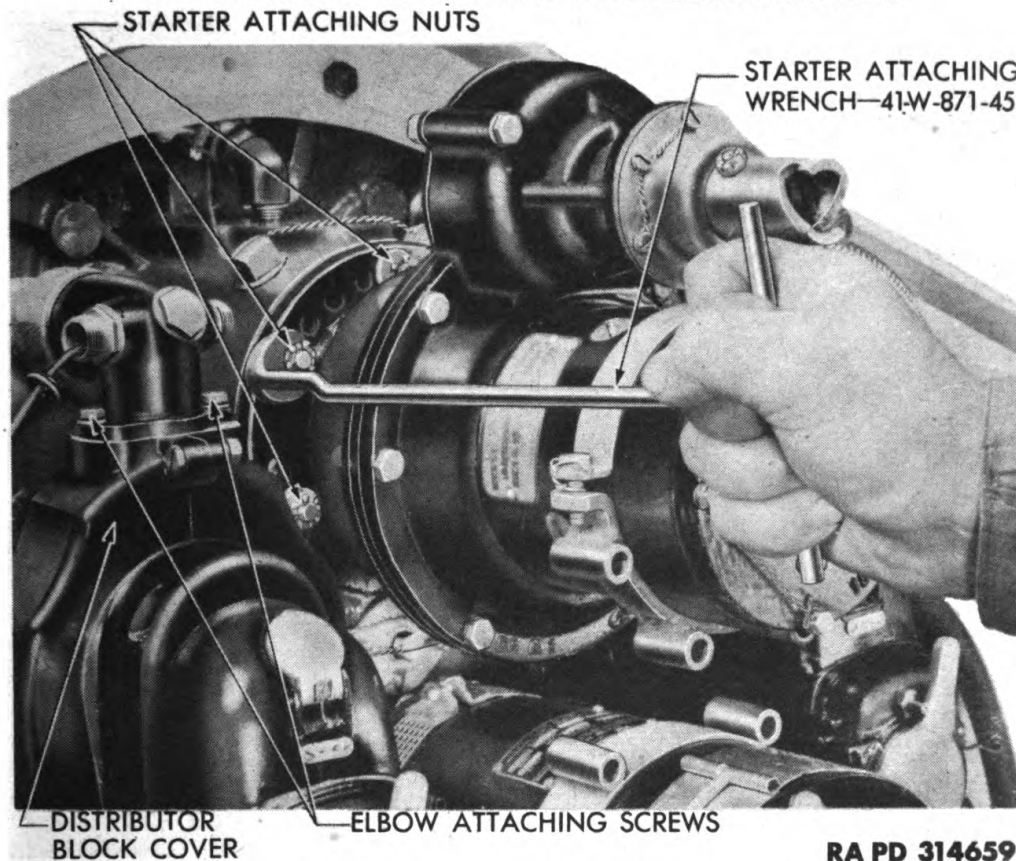

Figure 29 — Starter-generator Support Plates

hold starter-generator support bracket side plates to support bands (fig. 29). Remove the nuts, washers, and bolts; then remove side plates. Cut and remove safety wires from six hold-down nuts which hold starter on mounting studs. Remove nuts (fig. 30) using wrench (41-W-871-45), and supporting starter. Remove plain washers and lift off starter. Install cover plate over starter opening, and secure it in place with two or three hold-down nuts turned fingertight.

j. Remove Magneto Distributor Block Covers. Remove two cap screws, lock washers, and flat washers, holding conduit elbow to top of each magneto distributor block cover (fig. 30). Remove safety pins from cover locking clamps on each side of each magneto (fig. 10). Push clamps on side of each cover in and down to release cover. Remove two nuts, lock washers, and bolts that clamp the two halves of each distributor block cover together. Lift cover halves from each magneto.

DISASSEMBLY OF ENGINE INTO SUBASSEMBLIES

RA PD 314659

Figure 30 – Removing Starter Attaching Nuts

k. Remove Magnetos. Pull magneto distributor blocks out at top and lift from magnetos. Slide up rubber grommet from both magnetos, and disconnect secondary booster coil wire from right magneto. Disconnect ground wire from both magnetos. Cut and remove safety wires. Remove three nuts and flat washers which secure each magneto to rear of crankcase (fig. 10). Remove both magnetos.

l. Remove Generator. Cut and remove safety wires from four nuts securing generator to generator support pad. Remove four nuts (fig. 32), using wrench (41W-636-550). Remove washers from studs and pull generator from generator support pad. Remove gasket from generator support pad.

m. Remove Generator Support Pad. Try to work support pad off studs and dowel. If support cannot be worked off, use a flat pry bar. **CAUTION:** *Keep gasket between bar and face of generator support pad to prevent damaging the pad when prying.* Lift support pad off gasket crankcase studs and dowel. Remove gasket. Install cover on generator opening. Secure cover with two nuts tightened fingertight.

n. Remove Governor. Remove four palnuts, plain nuts, and washers holding governor to oil pump. Pull governor straight off oil

**ORDNANCE MAINTENANCE – ORDNANCE ENGINE
MODEL R975-C4 (CONTINENTAL)**

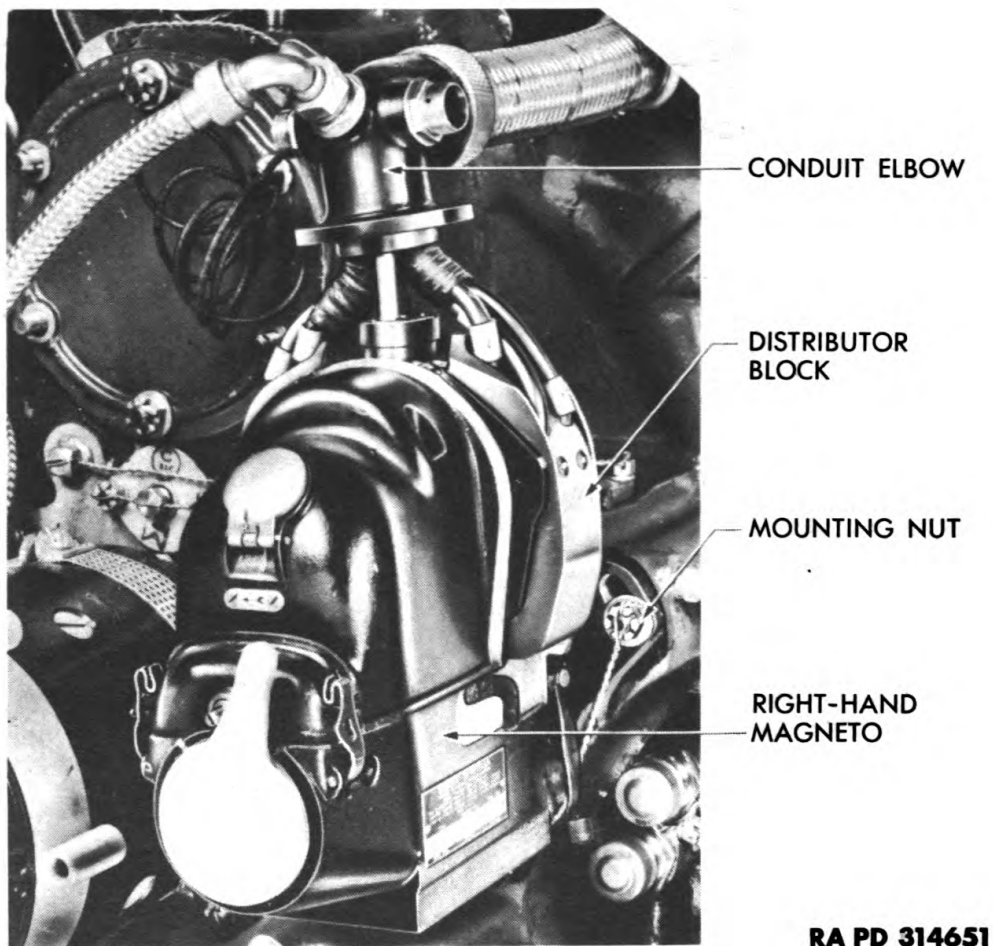

RA PD 314651

Figure 31 – Magneto Conduit Elbow Removed

pump studs. Install cover on opening and secure in place with two nuts tightened fingertight. Figure 34 shows engine with accessories removed and opening covers installed.

**8. ENGINE SUPPORTS, COLLECTOR RING, AND COWLING,
REMOVAL.**

a. Suspend Engine from Sling. Attach engine sling to rocker arm hub bolt nuts. Remove four nuts and bolts which secure each end of rear engine support to engine mounting stand (fig. 34). Lift engine straight up until both front and rear supports clear engine mounting stand.

b. Remove Engine Rear Support. Remove cotter pins from nine engine support ring nuts (fig. 34). Remove nuts, washers, and

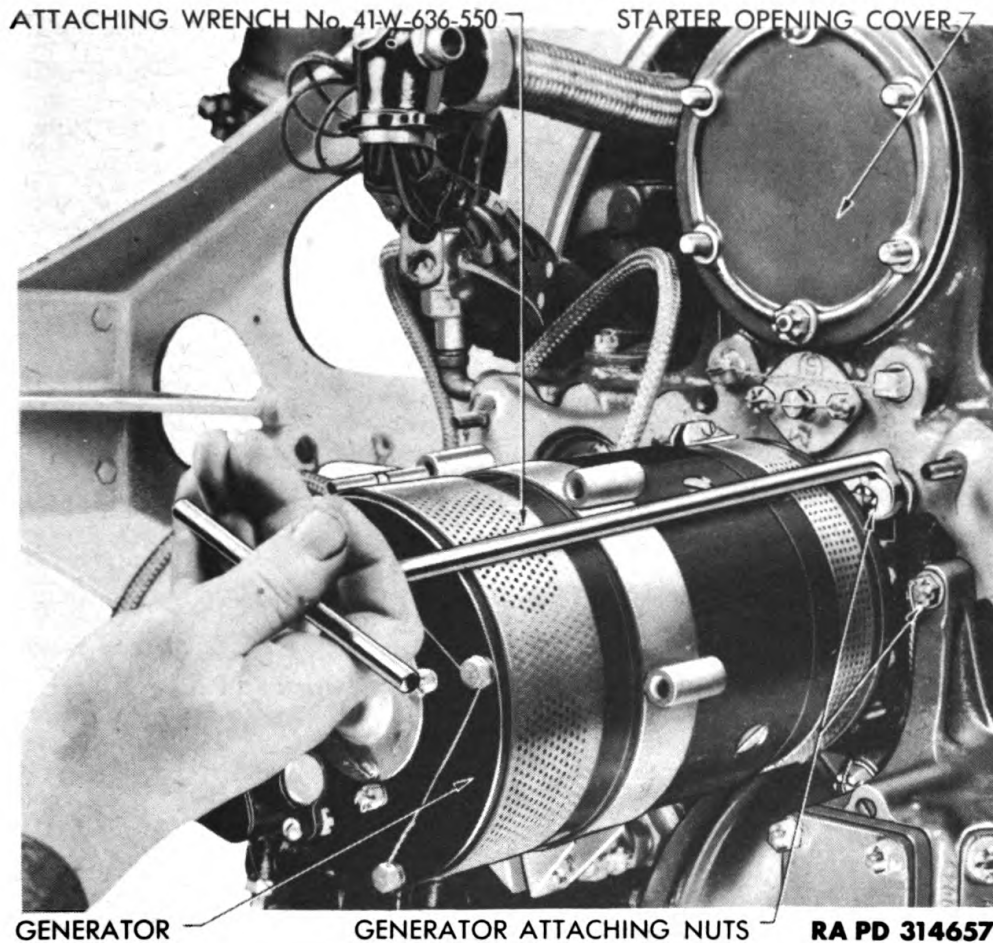
DISASSEMBLY OF ENGINE INTO SUBASSEMBLIES**Figure 32 – Removing Generator**

bolts, at nine points around support ring to disconnect support from engine. Engine is now suspended from sling.

c. Remove Exhaust Collector Ring. Cut and remove safety wires from two nuts which secure collector ring segments to studs on each cylinder exhaust elbow. Remove nuts, and washers. There are 10 nuts for the left ring segment and 8 for the right. Remove exhaust collector ring segments from exhaust elbows as assemblies (fig. 35). Remove and discard copper gaskets at exhaust elbows. Lower engine to disassembly stand. Fasten engine to stand and remove sling.

d. Remove Engine Front Support Bar. Cut and remove safety wires from 10 stud nuts on support bar center clamp at front of engine (fig. 36). Loosen nuts on studs and slide bar out from either side of clamp.

e. Remove Cowling. Loosen three Dzus fasteners which secure each of the nine cylinder head baffles to engine cowling (fig. 37).

**ORDNANCE MAINTENANCE – ORDNANCE ENGINE
MODEL R975-C4 (CONTINENTAL)**

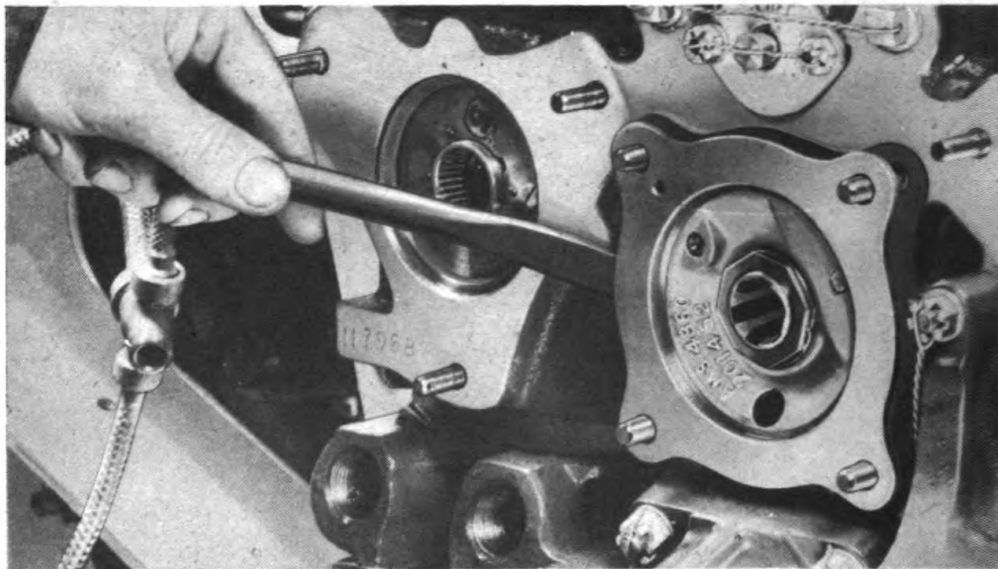

RA PD 314769

Figure 33 – Removing Generator Support Pad

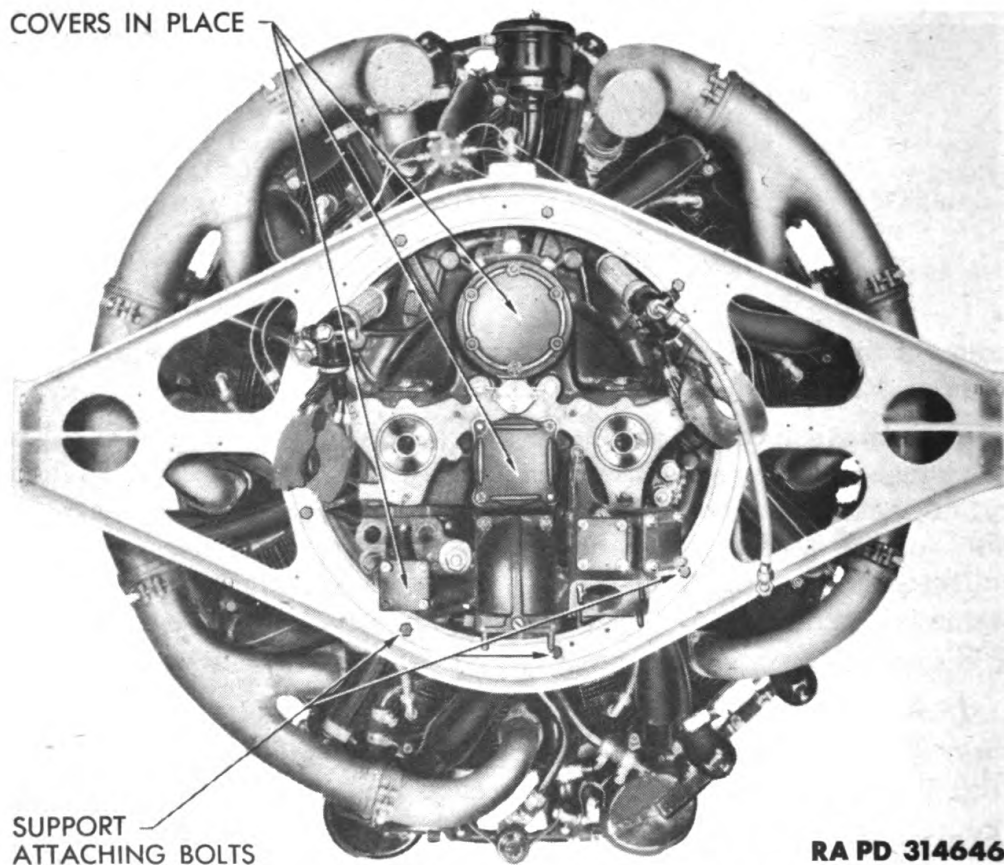

RA PD 314646

Figure 34 – Engine Rear Support Attachment

DISASSEMBLY OF ENGINE INTO SUBASSEMBLIES

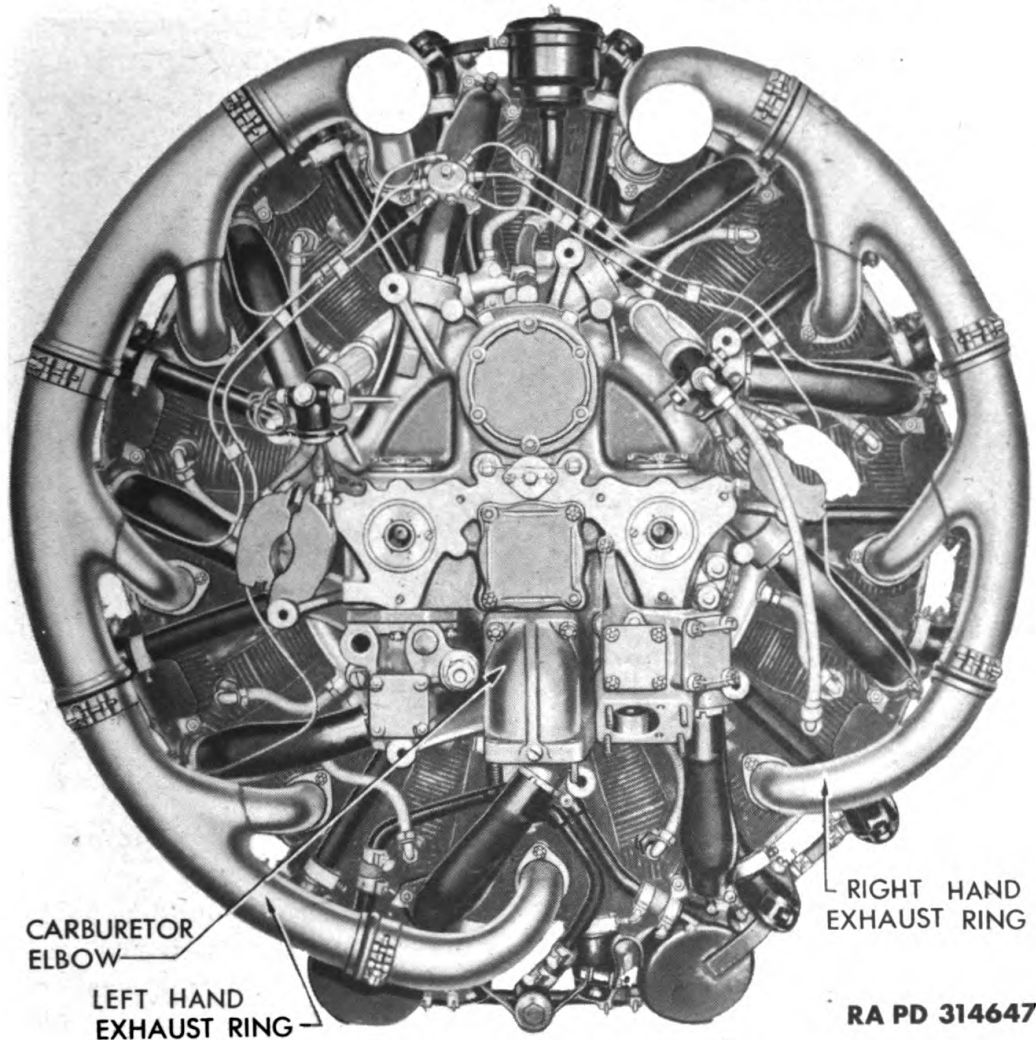

Figure 35 – Exhaust Collector Ring

Loosen the fasteners by turning them counterclockwise $\frac{1}{2}$ turn. The cowling is now disconnected from the baffles. Loosen two Dzus fasteners which secure each intercylinder baffle to cowling (fig. 37). Spring baffles outward to release fasteners from cowling. Remove cotter pins from seven nuts on bolts securing cowling to engine. Remove nuts, flat washers, and bolts. Raise cowling straight up off engine.

f. **Drain Oil.** With engine in upright position, drain oil from engine by taking plug out of drain housing located between the sump tanks (fig. 39).

9. FRONT AND MAIN CRANKCASE SECTIONS, REMOVAL.

a. Remove Sump Assembly.

(1) **REMOVE TANK ASSEMBLY.** Loosen six hose clamps which

**ORDNANCE MAINTENANCE — ORDNANCE ENGINE
MODEL R975-C4 (CONTINENTAL)**

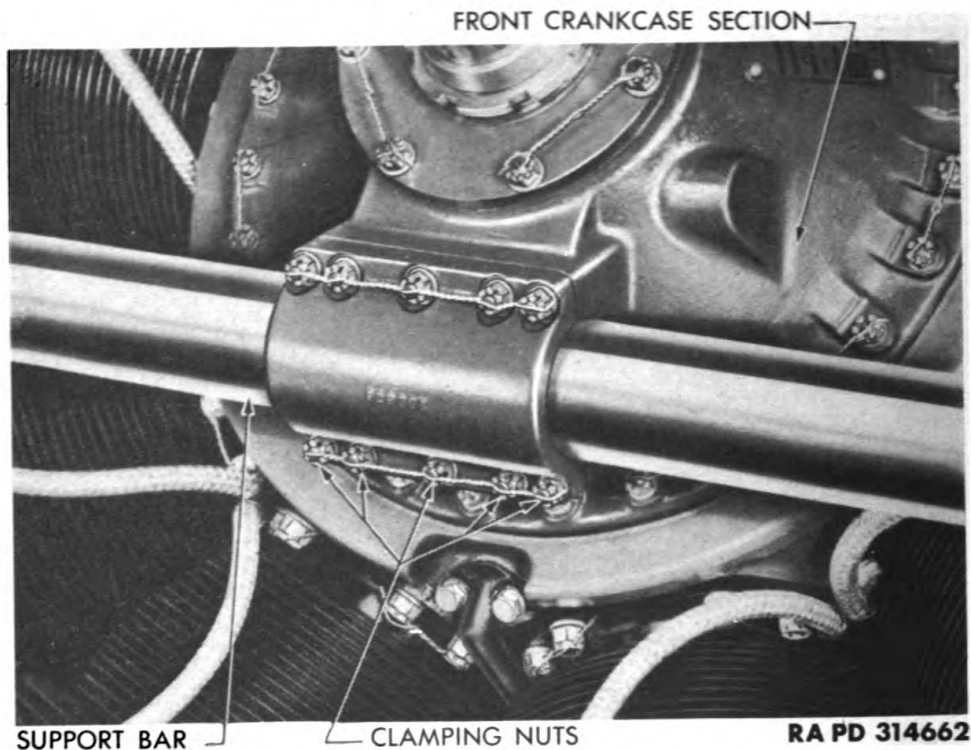

Figure 36 — Engine Front Support Bar and Mounting Clamp

secure three connecting hose running from connecting pipes between sump tanks and main sump fitting in bottom of main crankcase section (fig. 39). Remove cotter pins, nuts, bolts and spacing washers that hold sump tanks to rear of rocker boxes on the No. 5 and No. 6 cylinders. Cut and remove safety wires. Take off two nuts which hold each sump tank to drain tubes located between the cylinders. Remove nut and washer from studs which hold each sump tank to cylinder heads. Lift off sump tanks.

(2) **REMOVE SUMP SPIDER.** Cut safety wire, and remove two cap screws and flat washers which hold drain tube running from front of the main crankcase section to spider assembly (fig. 38). Pull drain tube forward from between the baffles and remove. Unscrew cap and remove washer from bottom of spider assembly. Slide spider assembly from fitting in bottom of main crankcase section.

b. Remove Front Spark Plugs. Elbow connectors are located at the spark plug end of each ignition wire front conduit. Loosen locking nut at spark plug end of each elbow connector, and pull cigarette connector out of each spark plug. Cover each cigarette connector immediately with suitable protector (fig. 40). Remove spark plugs from cylinders, using 1-inch deep socket wrench.

c. Disconnect Baffle Attaching Springs. Pull hooked end of in-

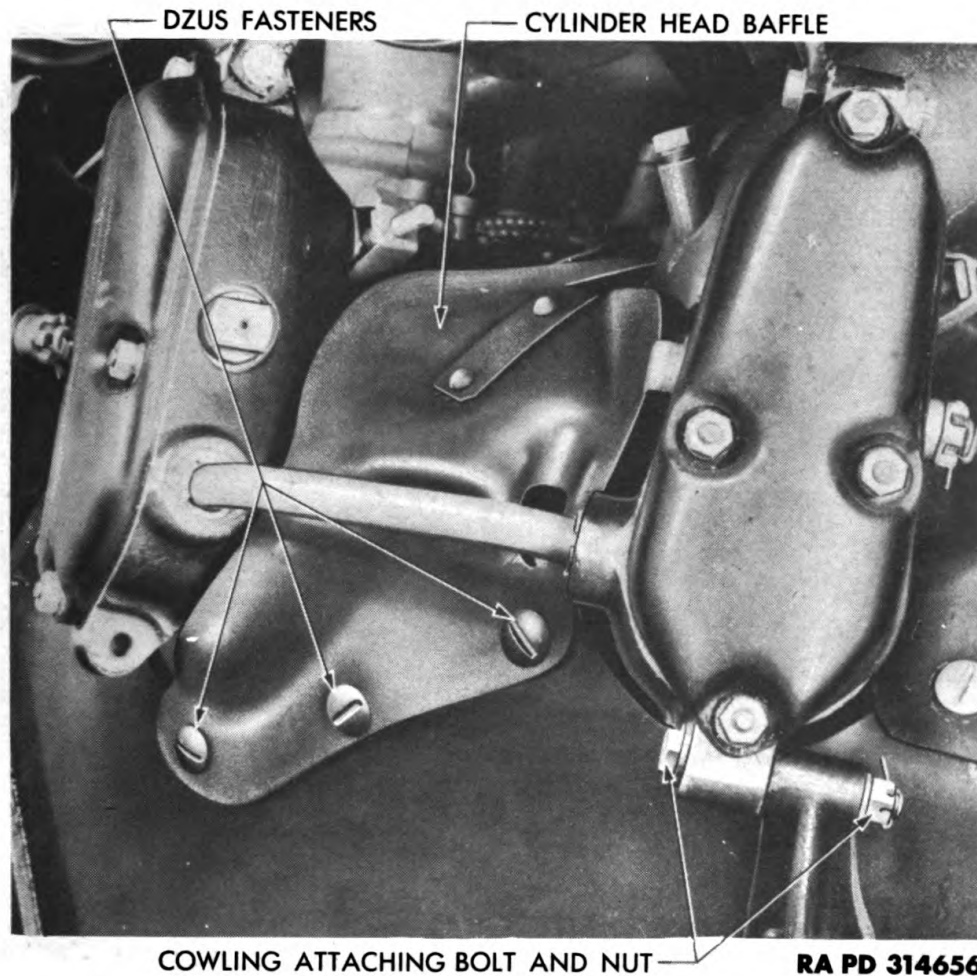
DISASSEMBLY OF ENGINE INTO SUBASSEMBLIES**Figure 37 – Engine Cowling Attachments**

tercylinder baffle attaching spring out over attaching bracket, and disconnect spring from bracket (fig. 41). Spring remains attached to baffle. Lift bracket out from between cylinders (fig. 42). Perform this operation for each of nine intercylinder baffles.

d. Remove Primer System. Loosen connecting nut that holds each primer system line to cylinder head. Loosen clamp nuts, and remove clamps that hold each primer line to the fuel induction tube. Cut and remove safety wires. Remove two screws and washers which hold distributor assembly for primer system to No. 1 induction tube (fig. 43). Remove primer system from engine as an assembly.

e. Remove Crankcase Breather. Loosen four hose clamps on hose which connect breather to front and rear crankcase sections (fig. 44). Remove two nuts, flat washers, and bolts which secure breather to rocker boxes on the No. 1 cylinder. Remove breather from engine.

**ORDNANCE MAINTENANCE – ORDNANCE ENGINE
MODEL R975-C4 (CONTINENTAL)**

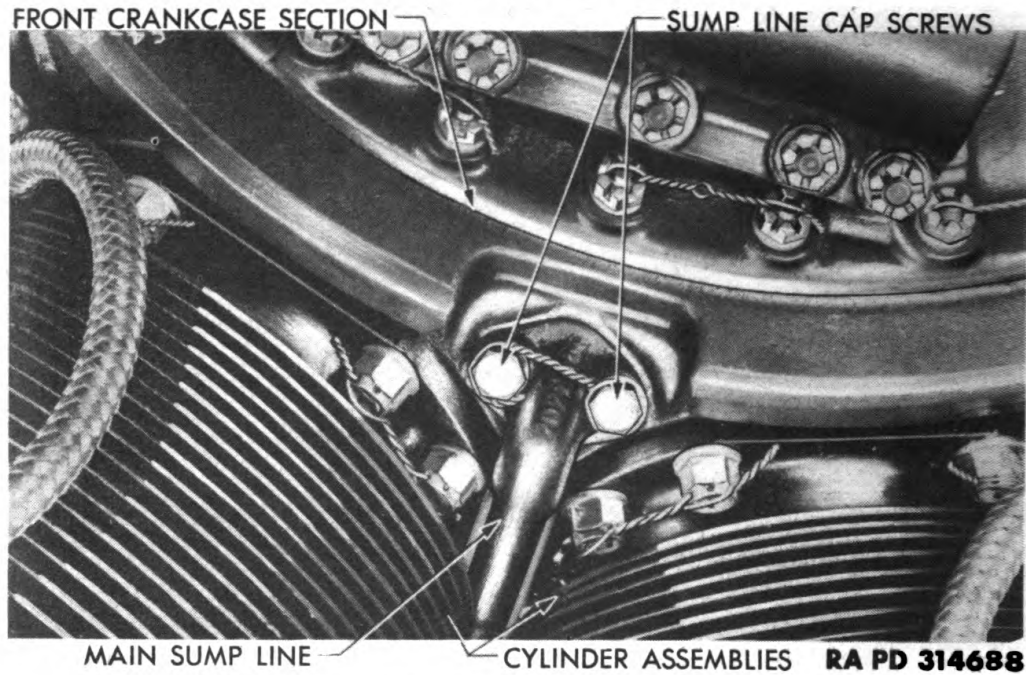

Figure 38 – Sump Drain Tube Connection at Main Crankcase Section

f. Remove Rocker Box Covers. Remove four stud nuts, lock washers, and flat washers that hold each rocker box cover to rocker box (fig. 4). Lift cover and gasket from studs on rocker box. Where two covers are connected together by a drain tube, remove both covers at the same time. Do not disconnect rubber drain tube unless it needs to be replaced. If design of engine mounting stand permits, turn engine around so that all oil will be drained from each rocker box.

g. Remove Rocker Arm Assemblies. Make sure valve being worked on is in closed position, or rotate crankshaft with timing bar (par. 73 m), until valve is in closed position. Break loose all rocker arm adjusting screw lock nuts (fig. 45). Pull cotter pin from rocker arm hub bolt nut. Holding bolt head (fig. 46), remove nut and washer. Slide bolt and washer from rocker box. Lift out rocker arm assembly. Remove other rocker arm assemblies in same way.

h. Remove Push Rods and Housings. Push rods are free after rocker arms are removed. Lift push rods out of push rod housings which connect each rocker box to a push rod adapter in the main crankcase (fig. 47). Each housing is attached to its rocker box and adapter by two hose and three clamps. Loosen hose clamp nearest the rocker box, using wrench (41-W-1986); then loosen hose clamp nearest crankcase. Slide the clamp and hose nearest rocker box away

DISASSEMBLY OF ENGINE INTO SUBASSEMBLIES

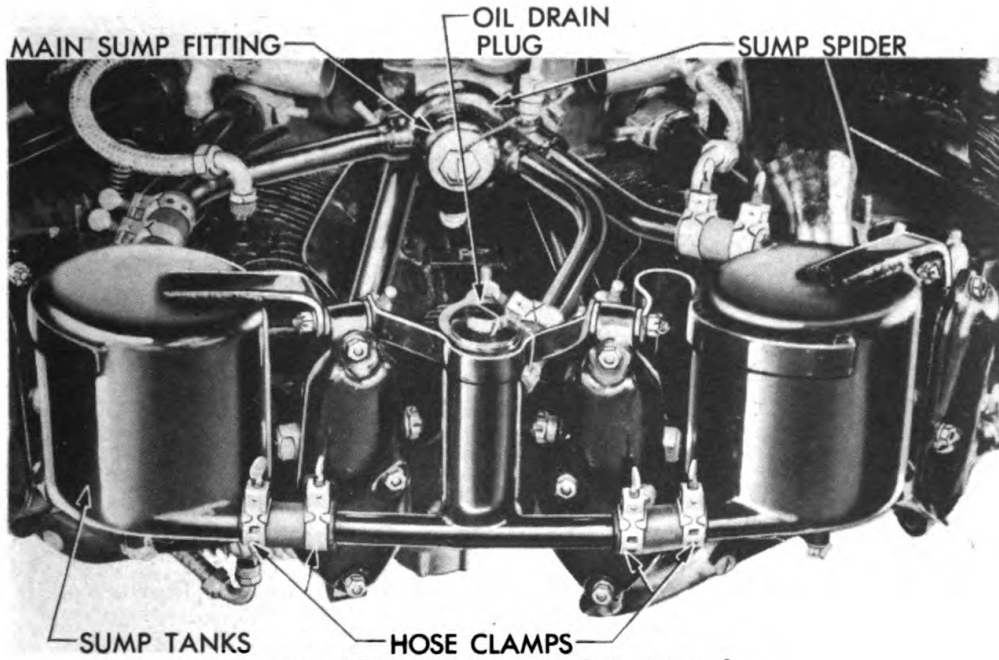

1. Rear View Oil Sump and Drain Tanks

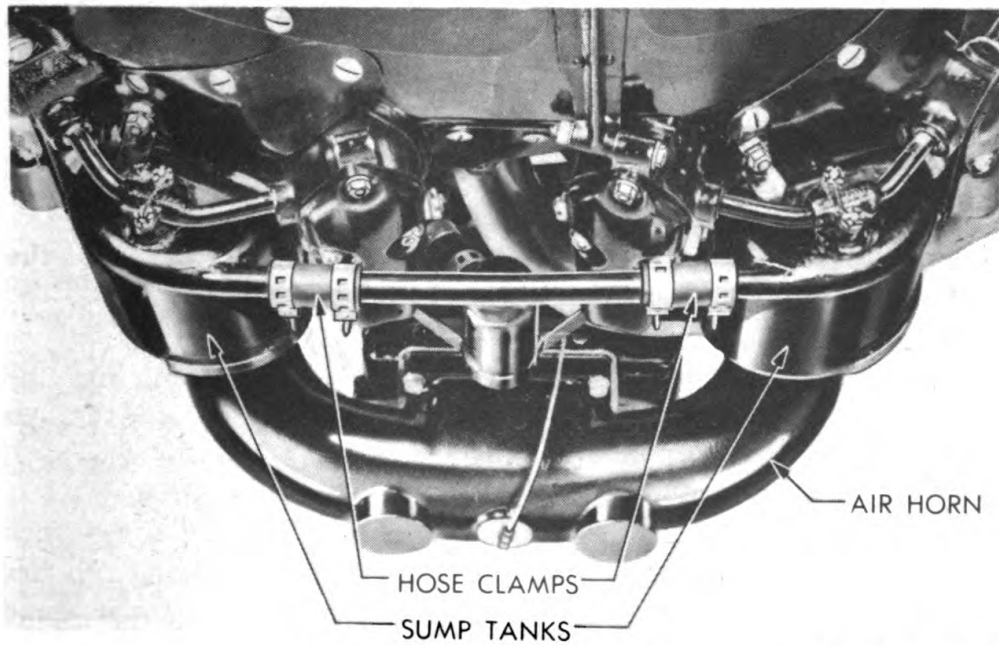

2. Front View Sump and Tanks

RA PD 314774

Figure 39 – Oil Sump

**ORDNANCE MAINTENANCE – ORDNANCE ENGINE
MODEL R975-C4 (CONTINENTAL)**



**Figure 40 – Installing Protector on Front Spark Plug
Cigarette Connector**

from the box and over the push rod housing. Raise the end of the housing nearest the rocker box and pull the housing assembly off the push rod adapter. Remove all push rod housings in same way.

i. Remove Push Rod Sockets and Springs. Reach into the crankcase opening with a piece of wire. Insert end of wire through hole in push rod socket and spring, and pull them both out (fig. 49). Remove socket and spring for each push rod in same way.

j. Remove Cylinder Head Baffles. Remove the cap screw, lock washer, and flat washer that hold each cylinder head baffle to cylinder head, and remove baffle (fig. 50). Remove all nine baffles in same way. *NOTE: The cap screw removed also serves as an attaching screw for the fuel induction tube secured to cylinder head.*

k. Remove Fuel Induction Tubes. Unscrew gland nut at inner end of each fuel induction tube (fig. 51) using wrench (41-W-1537).

DISASSEMBLY OF ENGINE INTO SUBASSEMBLIES



RA PD 314655

Figure 41 – Unhooking Intercylinder Baffle Attaching Spring

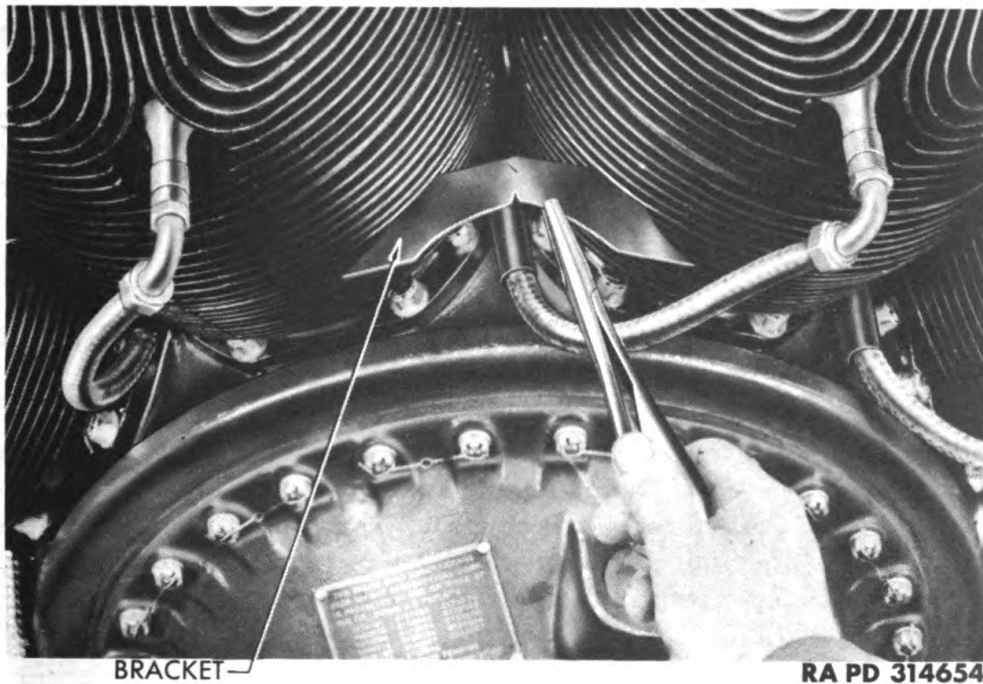

RA PD 314654

Figure 42 – Removing Baffle Spring Bracket

**ORDNANCE MAINTENANCE — ORDNANCE ENGINE
MODEL R975-C4 (CONTINENTAL)**

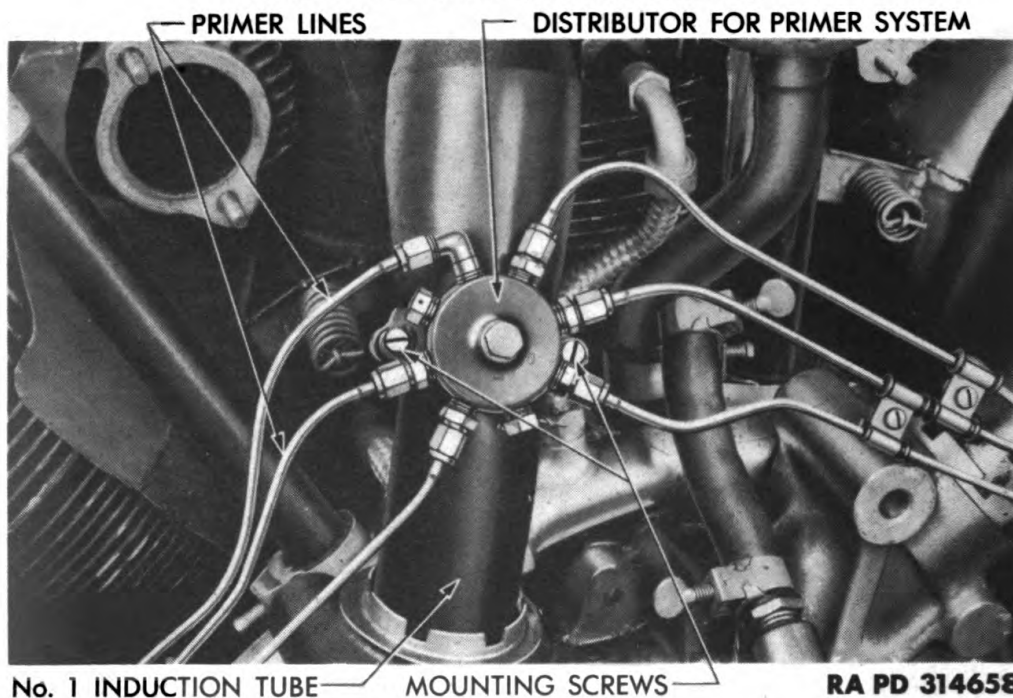

Figure 43 — Primer Distributor Bracket Mounted

Slide nut back on each tube. Loosen remaining two cap screws, lock washers, and flat washers, holding each induction tube to cylinder head (fig. 50). Pull tube out of recess in rear crankcase section. Remove rubber seal from each recess and install seal on end of each induction tube. Remove and discard induction tube flange gaskets.

l. Remove Rear Spark Plugs. Follow procedure outlined in subparagraph 9 b, above. **CAUTION:** *Be sure to install protectors on spark plug cigarette connectors as soon as connectors are removed from plugs.*

m. Remove Intercylinder Baffle Assemblies. Lift up each baffle assembly until it clears the cylinder exhaust elbow, and remove assembly from between cylinders. Make sure that baffle retaining springs do not catch on engine parts.

n. Loosen Starter Shaft Nut. Remove cover from starter opening (par. 7 i). Insert cloth in opening under starter shaft to prevent cotter pin or pieces of the cotter pin from dropping into rear crankcase section. Pull cotter pin from starter shaft nut (fig. 52). Break loose starter shaft nut. It is much easier to loosen starter shaft nut at this time. Retighten nut fingertight. Remove cloth, and reinstall starter cover. **NOTE:** *This operation is necessary only when the crankcase sections are to be separated.*

o. Remove Cylinder and Piston Assemblies.

(1) **REMOVE REAR CYLINDER ATTACHING NUTS.** Cut and remove

DISASSEMBLY OF ENGINE INTO SUBASSEMBLIES

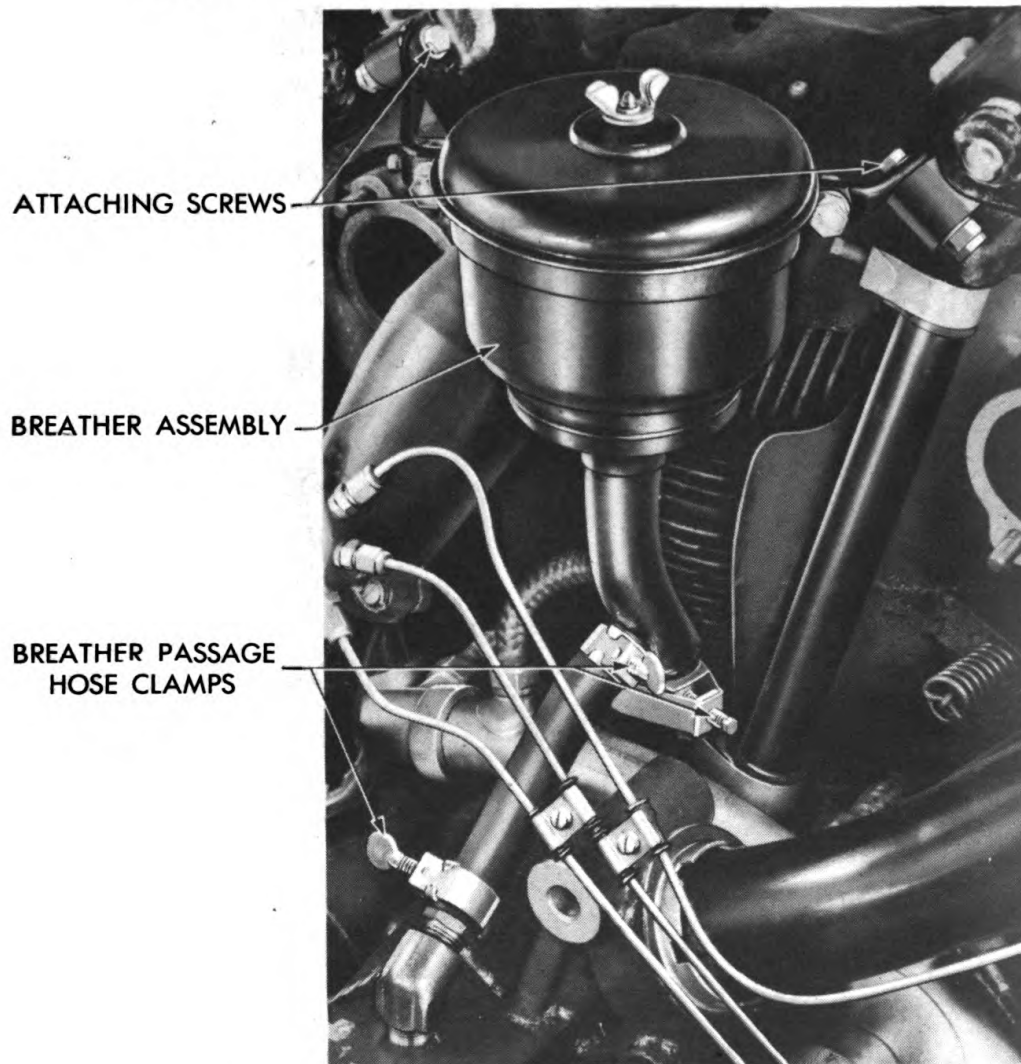

RA PD 314664

Figure 44 – Crankcase Breather Mounting

safety wires from eight attaching nuts on each cylinder. Remove four attaching nuts from studs at rear of each cylinder (fig. 53) using a special wrench supplied for this operation.

(2) **REMOVE NO. 2 CYLINDER ASSEMBLY.** Rotate engine crankshaft until No. 2 piston is at top center. Using same wrench, loosen and remove four attaching nuts from studs in front of No. 2 cylinder. Pull cylinder assembly from studs on cylinder mounting pads in main crankcase section. **CAUTION: Do not remove any other cylinder assemblies at this time.**

(3) **REMOVE NO. 2 PISTON ASSEMBLY.** Remove aluminum plugs from both ends of No. 2 piston pin (fig. 54). Tap piston pin out of piston with light hammer (fig. 55) using drift (41-D-1541-75) and supporting piston. Lift piston assembly from articulated connecting

**ORDNANCE MAINTENANCE – ORDNANCE ENGINE
MODEL R975-C4 (CONTINENTAL)**

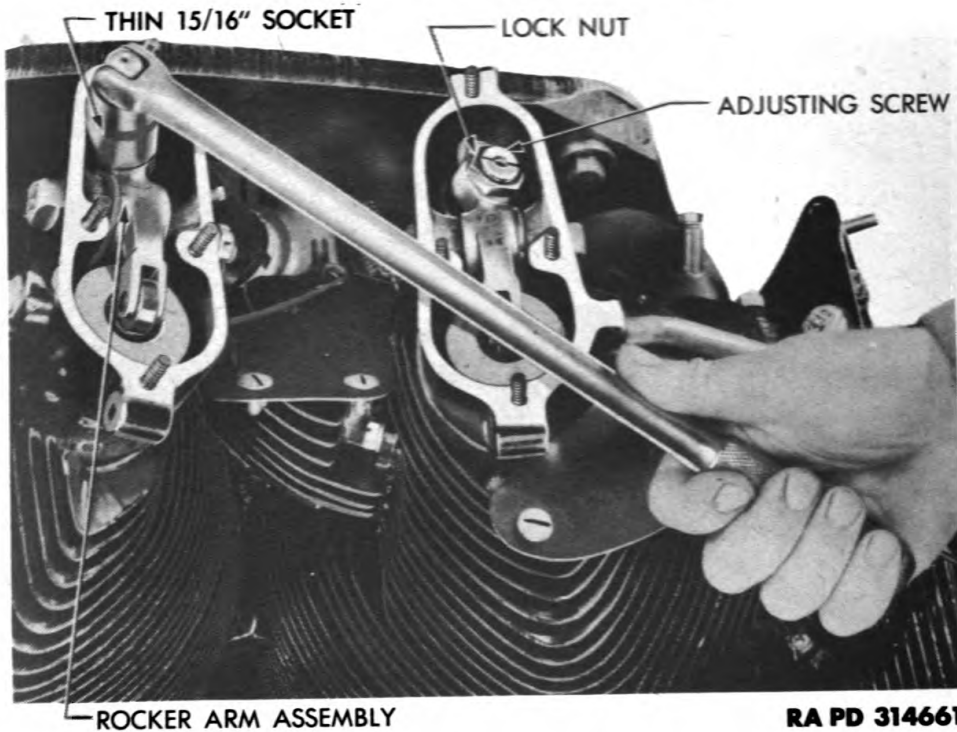

Figure 45 – Loosening Rocker Arm Adjusting Screw Lock Nut

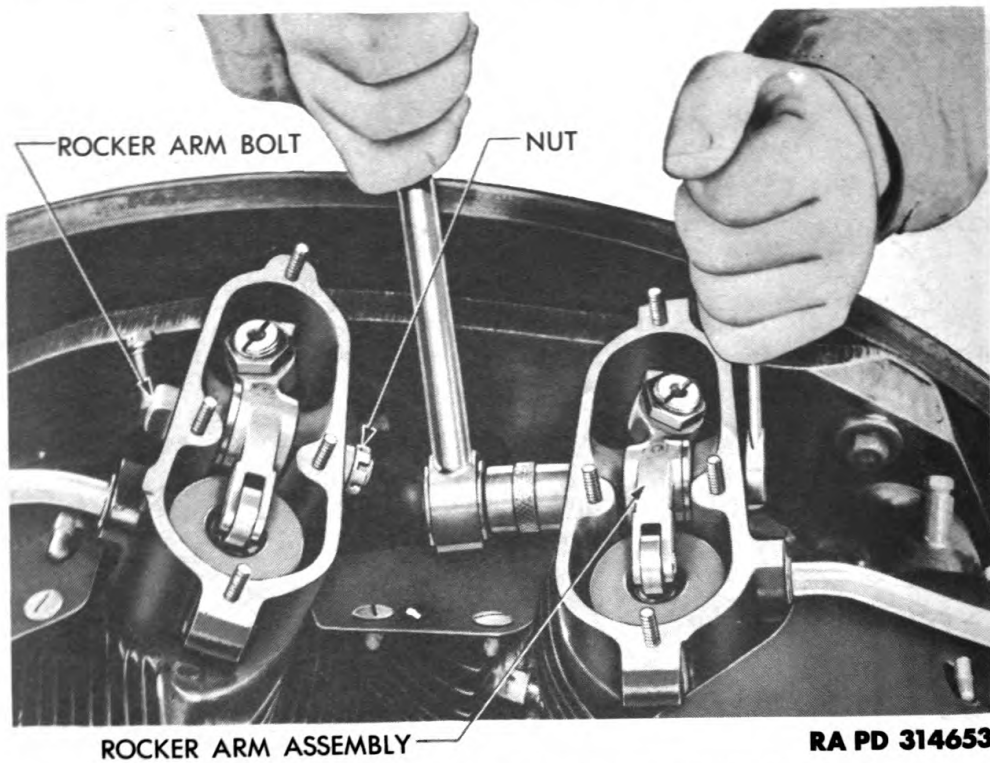
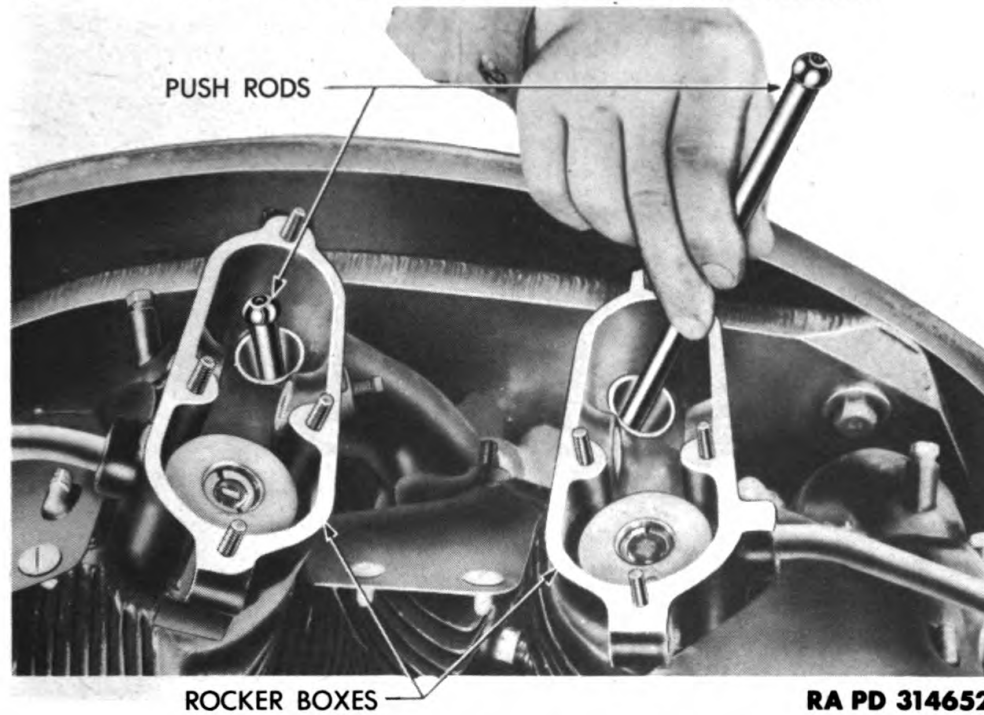

Figure 46 – Removing Rocker Arm Hub Bolts

DISASSEMBLY OF ENGINE INTO SUBASSEMBLIES



RA PD 314652

Figure 47 – Removing Push Rod

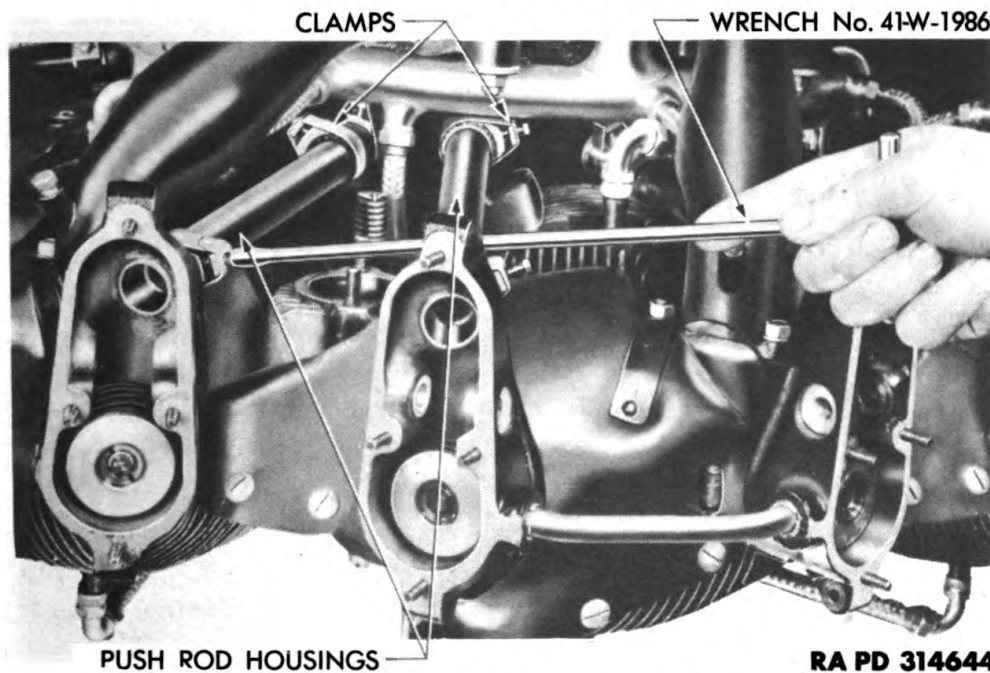

RA PD 314644

Figure 48 – Loosening Push Rod Housing Clamp

rod, and install rod protector on cylinder hold-down studs (fig. 56). If a rod protector is not available, use the cylinder lower oil seal.

(4) REMOVE REMAINING CYLINDER AND PISTON ASSEMBLIES. Repeat the procedure outlined in subparagraphs (2) and (3) above,

**ORDNANCE MAINTENANCE – ORDNANCE ENGINE
MODEL R975-C4 (CONTINENTAL)**

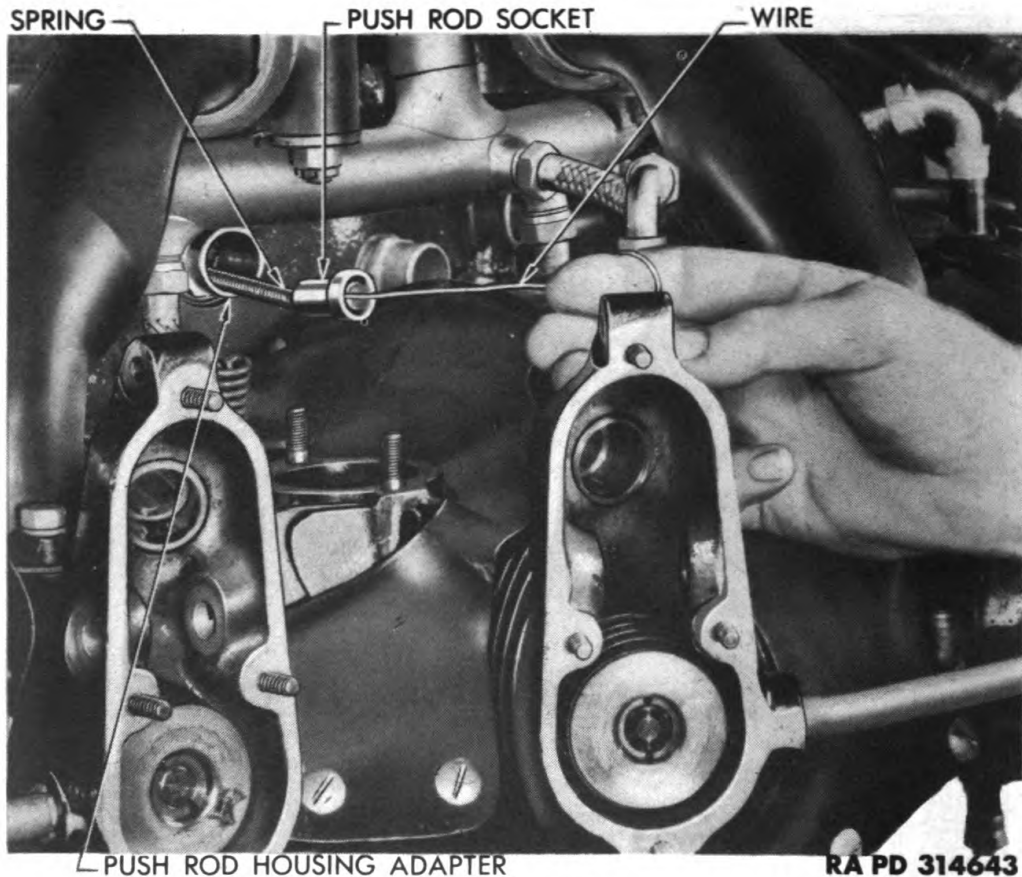

Figure 49 – Removing Push Rod Socket and Spring

for the No. 3 cylinder, then for the No. 4, etc., until all cylinder assemblies have been removed. Install rod protectors for each rod as soon as piston is removed. **CAUTION:** *The No. 1 cylinder, in which the master rod operates, must be removed last.*

p. Remove Split Brass Cone. Remove protecting cap from threaded end of crankshaft. Insert screwdriver in split brass cone on shaft. Spread cone, and lift cone off shaft (fig. 58).

q. Remove Thrust Bearing Retaining Nut. Install special wrench (41-W-871-35) on thrust bearing retaining nut. Turn nut off shaft while holding crankshaft stationary with timing bar, or another suitable bar (fig. 59).

r. Remove Front Crankcase Section. Cut and remove safety wires from 7 nuts holding front crankcase section cover to front crankcase section (fig. 59). Remove nuts and flat washers. Lift off cover, laminated shim, and oil slinger (fig. 60). Cut and remove safety wires from 28 nuts holding front crankcase section to center section (fig. 60). Remove nuts and flat washers. Using a special

DISASSEMBLY OF ENGINE INTO SUBASSEMBLIES

INDUCTION TUBE MOUNTING SCREWS

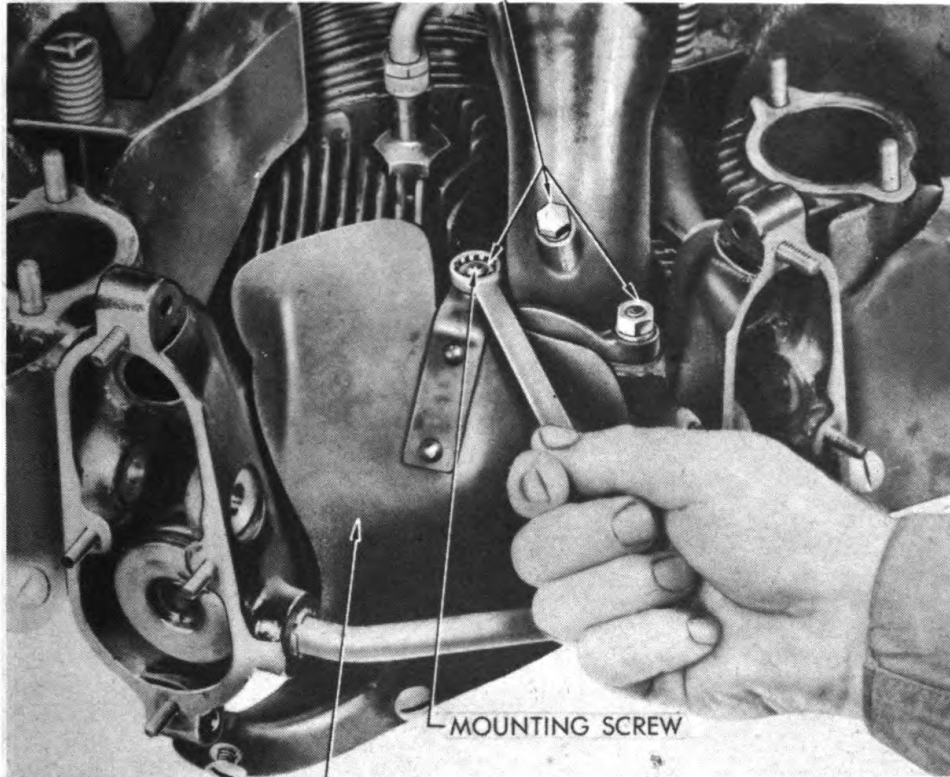

CYLINDER HEAD BAFFLE

RA PD 314642

Figure 50 – Removing Cylinder Head Baffle Attaching Cap Screw

SPANNER WRENCH No. 41W-1537

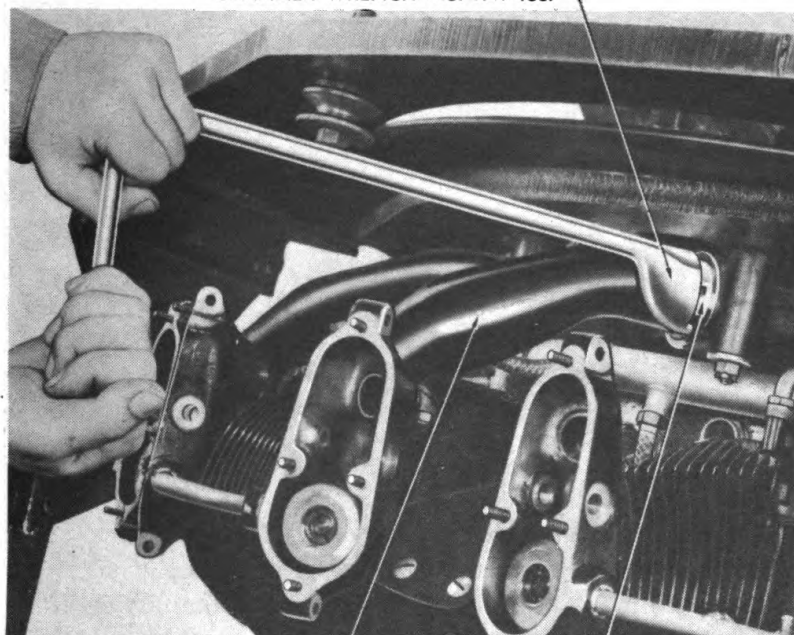

INDUCTION TUBE

GLAND NUT

RA PD 314641

Figure 51 – Removing Fuel Induction Tube Gland Nut

**ORDNANCE MAINTENANCE – ORDNANCE ENGINE
MODEL R975-C4 (CONTINENTAL)**

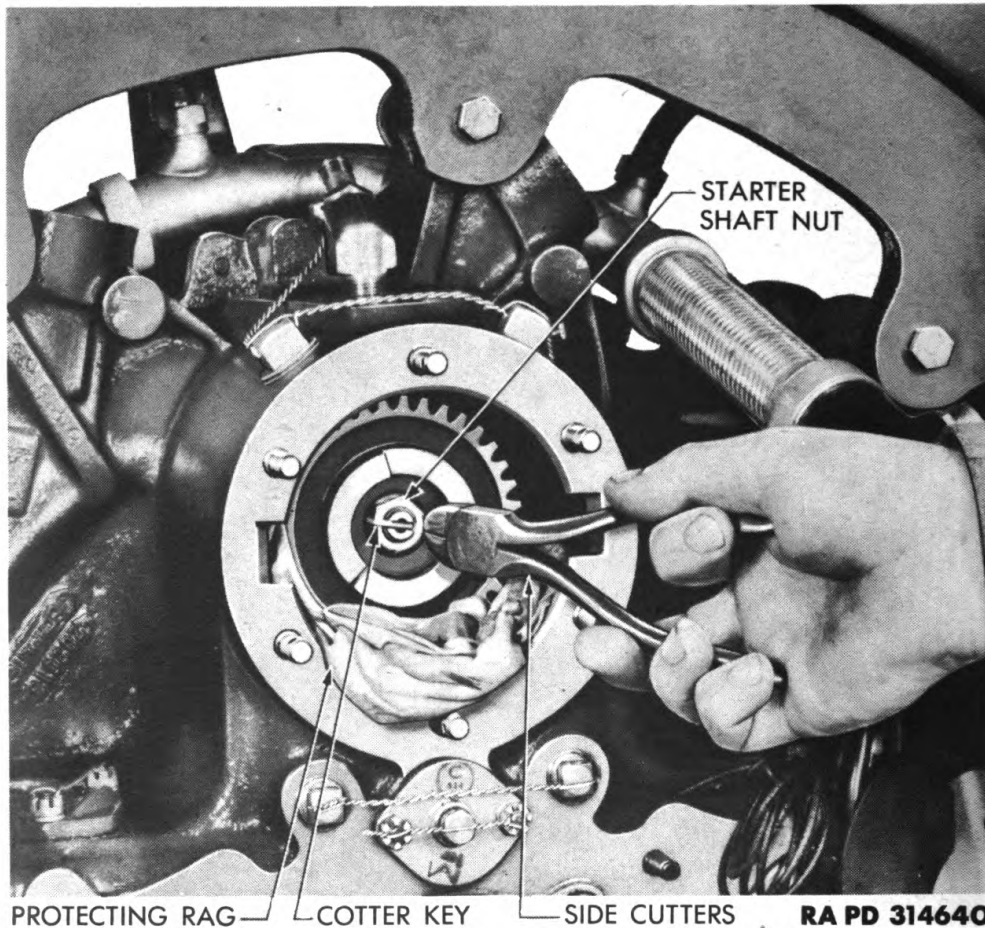

Figure 52 – Removing Cotter Pin from Starter Shaft Nut

puller supplied for this operation, remove front section (including thrust bearing) from studs on main crankcase section (fig. 61).

s. Remove Front Main Bearing Support. Slide spool-like spacer from crankshaft (fig. 62). Pull front main bearing support from studs on main crankcase section (fig. 62), using three pullers (41-P-2906-280), and exerting equal pressure on each. Lift front main bearing outer race and roller assembly from inner race. Inner race remains on crankshaft (fig. 63). Handle bearing with care to avoid loss of rollers. Wrap bearing in oiled paper until ready to service or install. Reinstall thread protector on end of crankshaft (fig. 63).

t. Remove Articulated Rods. Working through top (front) of main crankcase section, bend down screw locks which secure articulated rod knuckle pin locks (fig. 64). Turn crankshaft so that counterweights are exactly opposite knuckle pins to be removed. Remove two cap screws, screw locks, and knuckle pin locks. Insert threaded end of puller (41-P-2941-125) into knuckle pin (fig. 65). Install

DISASSEMBLY OF ENGINE INTO SUBASSEMBLIES

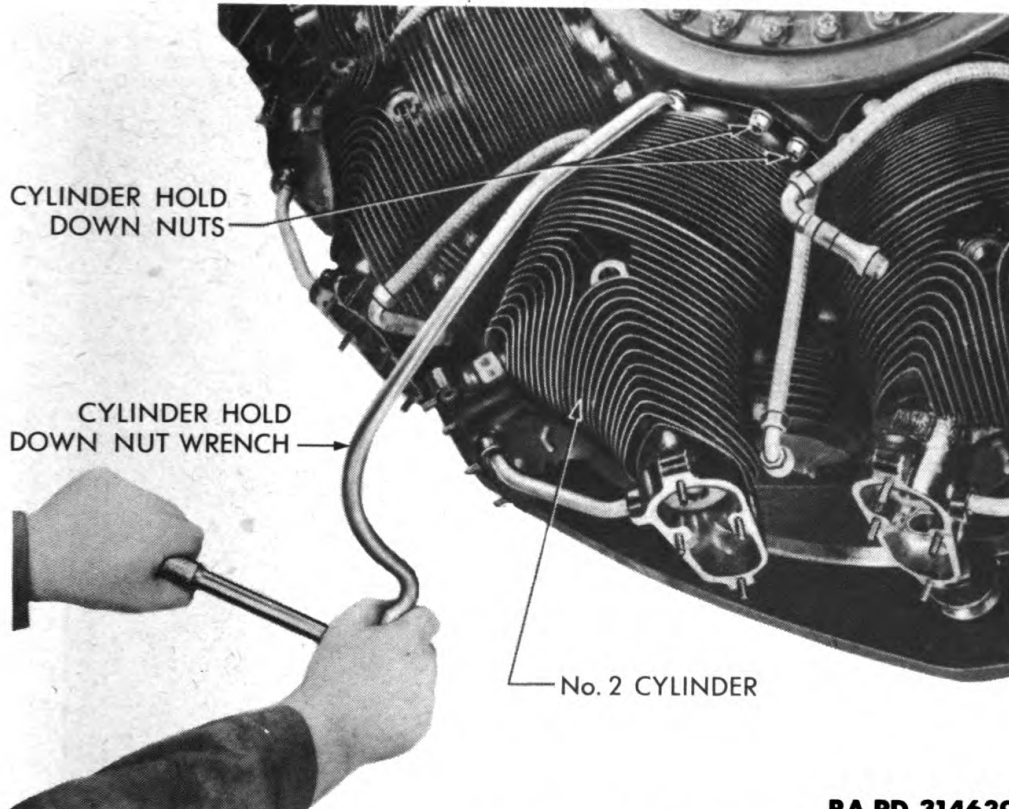

RA PD 314639

Figure 53 – Loosening Cylinder Attaching Nuts

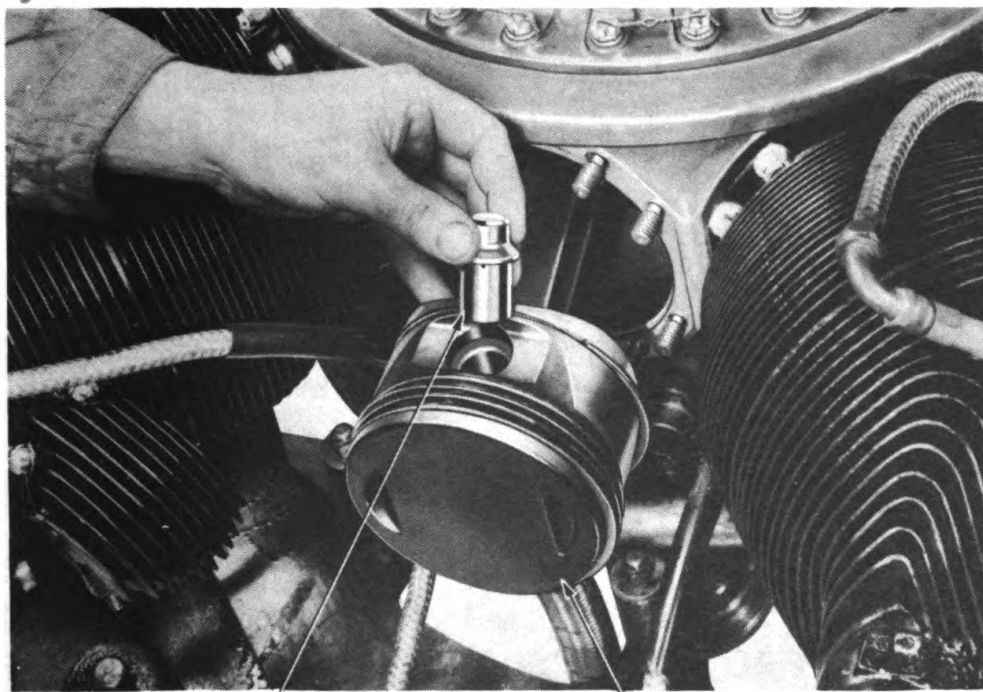

RA PD 314650

Figure 54 – Removing Piston Pin Plug

**ORDNANCE MAINTENANCE – ORDNANCE ENGINE
MODEL R975-C4 (CONTINENTAL)**

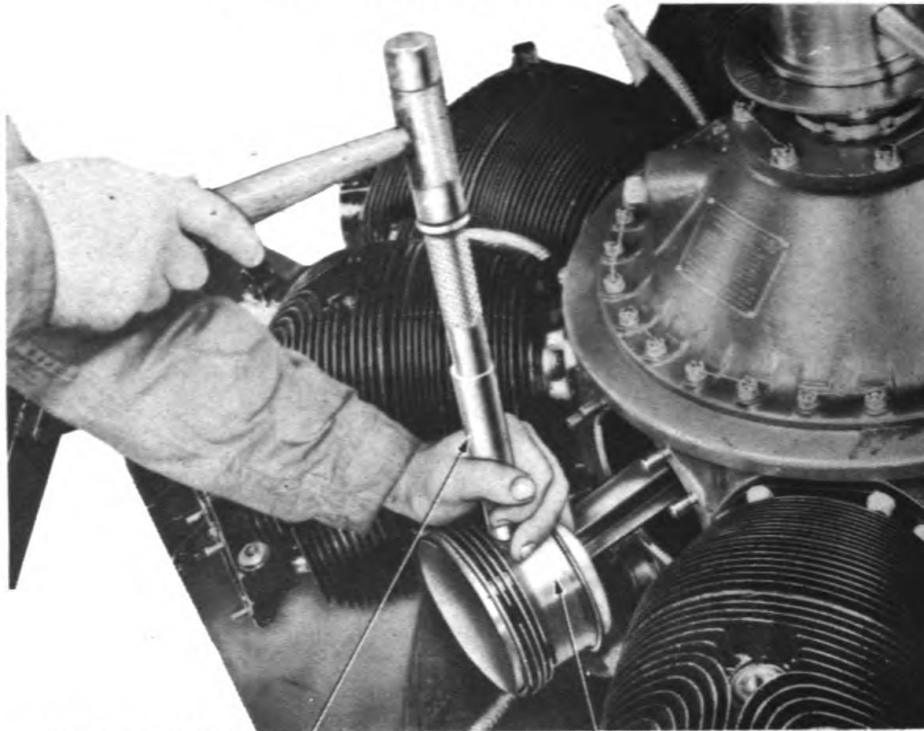

PISTON PIN DRIFT

No. 2 PISTON

RA PD 314638

Figure 55 – Driving Out Piston Pin Using Drift 41-D-1541-75

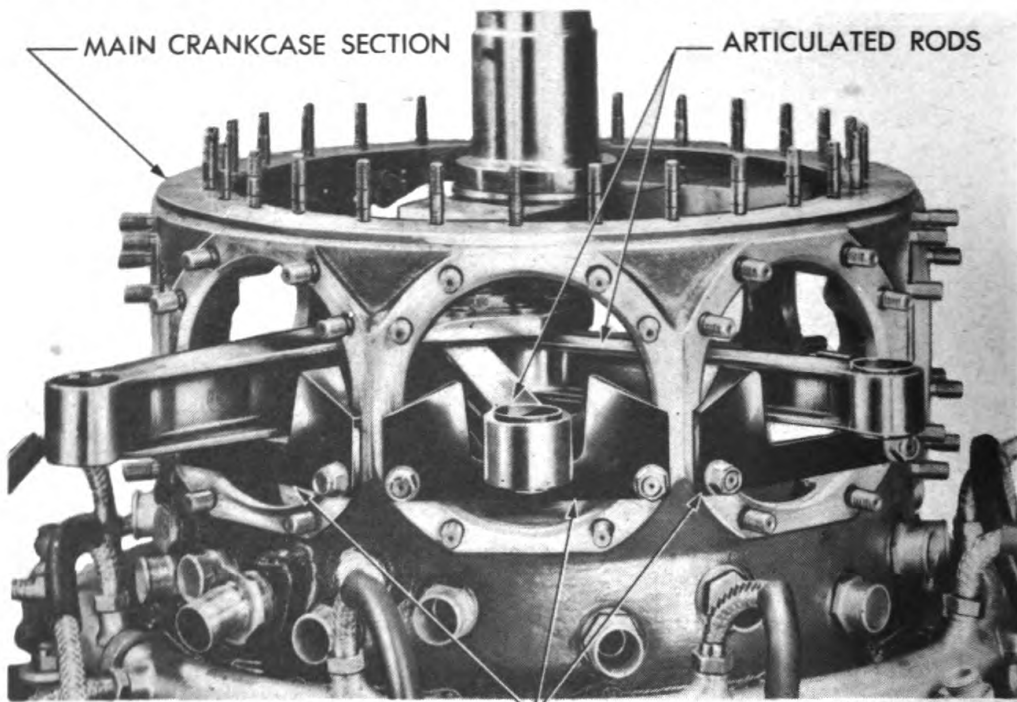

MAIN CRANKCASE SECTION

ARTICULATED RODS

PROTECTORS FOR RODS

RA PD 314693

Figure 56 – Connecting Rod Protector

DISASSEMBLY OF ENGINE INTO SUBASSEMBLIES

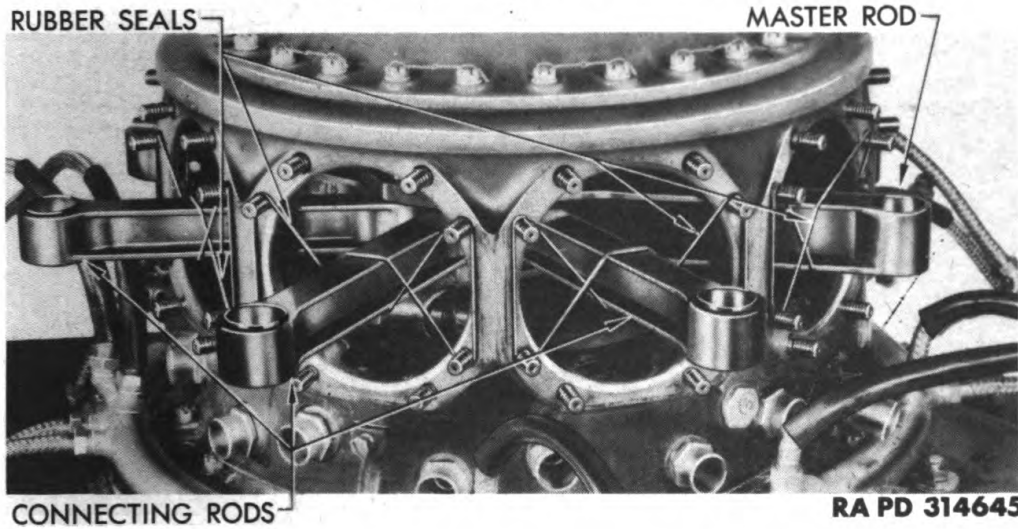

Figure 57 – Cylinder Seal Used as Rod Protector

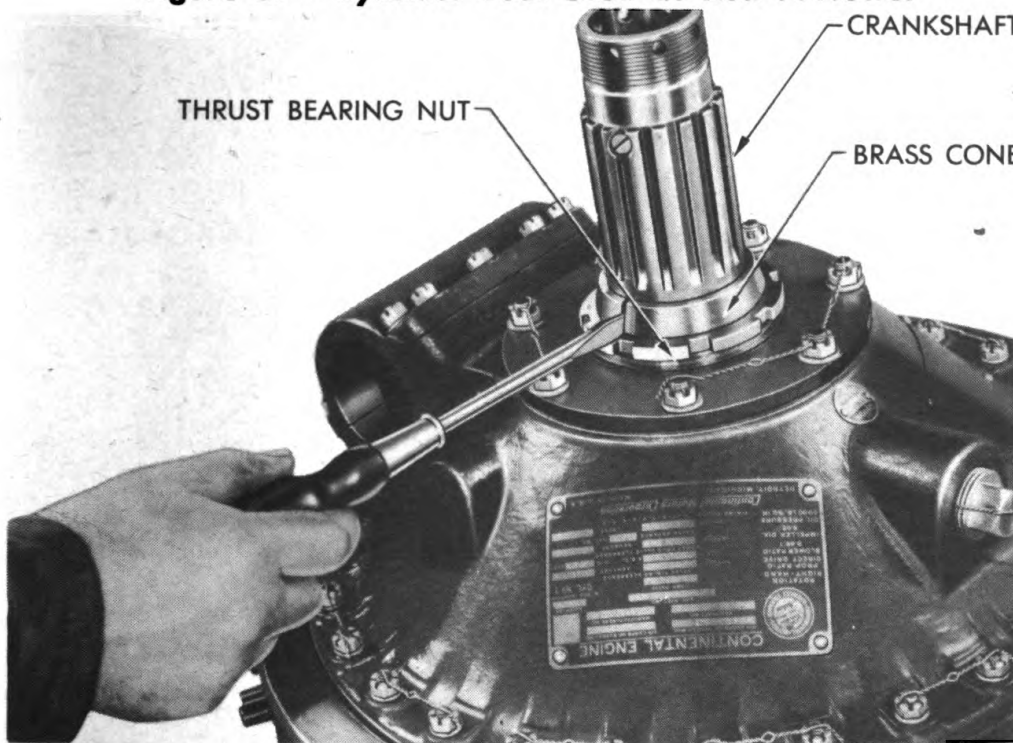

Figure 58 – Removing Split Brass Cone from Crankshaft

bar, or ratchet, on puller. Hold head of puller (fig. 66) and master rod in a fixed position. Turn puller. As knuckle pin clears master rod flange (fig. 66), remove articulated rod. Repeat this operation for each knuckle pin and articulated rod.

u. Remove Ignition Harness. Cut and remove safety wires from four nuts that hold ignition harness bracket to studs on crankcase.

**ORDNANCE MAINTENANCE – ORDNANCE ENGINE
MODEL R975-C4 (CONTINENTAL)**

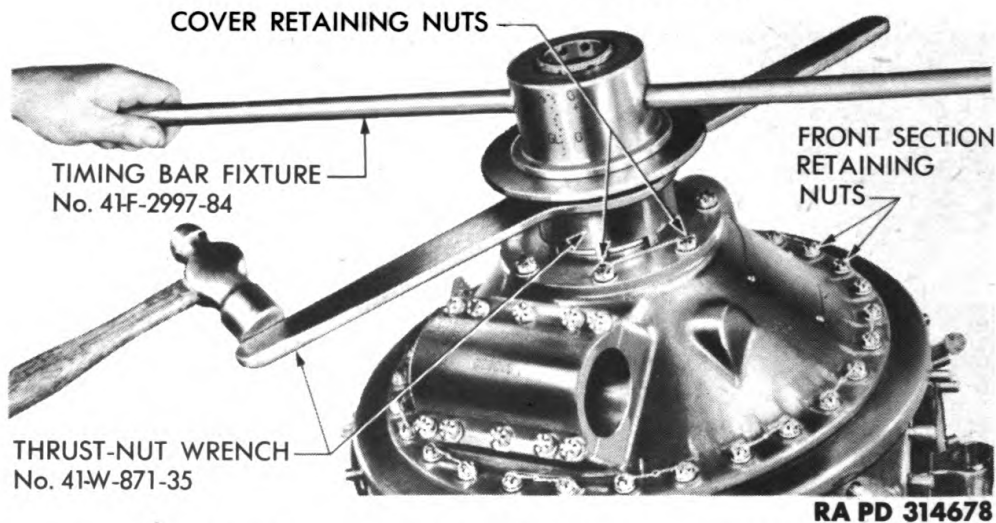

Figure 59 – Removing Thrust Bearing Retaining Nut

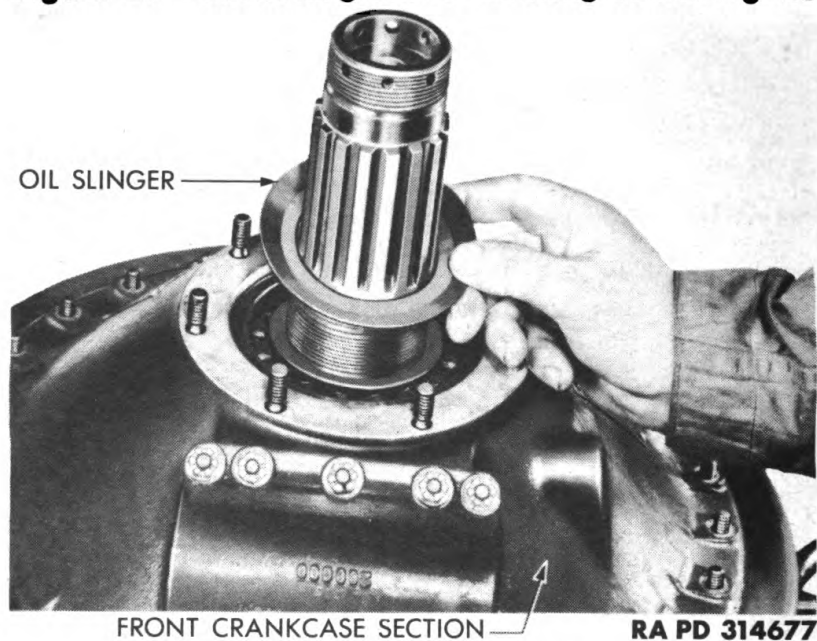
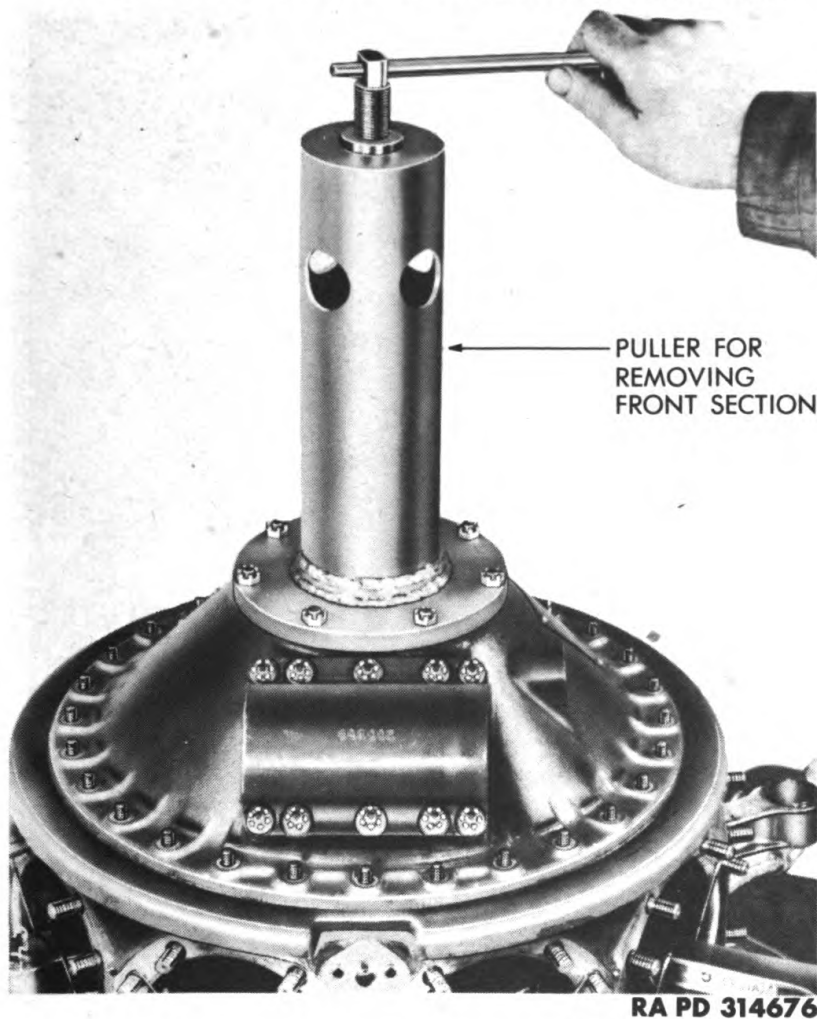

Figure 60 – Removing Oil Slinger

Remove nuts (fig. 67), using a wrench. Unscrew knurled nut that holds the two sections of the harness together (fig. 68). Lift harness from engine, being careful not to catch ignition blocks on engine stand as harness is removed.

v. Remove Main Crankcase Section.

(1) **REMOVE BY LIFTING.** Cut and remove safety wires from 16 remaining nuts that hold main crankcase section to rear section. Remove nuts and flat washers. Lift main section, including crankshaft, from rear section studs (fig. 69).

DISASSEMBLY OF ENGINE INTO SUBASSEMBLIES

RA PD 314676

Figure 61 – Removing Front Crankcase Section

(2) **REMOVE WITH LIFTING EYE.** When using a lifting eye to remove the main crankcase section, remove the front and main sections as an assembly and separate them later. Separating the sections after removal prevents damage to the rear main bearing. After removing cylinder assemblies (subpar. o above), remove ignition harness and main section attaching nuts (subpars. u through v (1), above). Attach lifting eye. Remove crankcase front and main sections as an assembly (fig. 70). Proceed with disassembly steps (subpars. p through t, above).

w. Remove Crankshaft Gear. Cut and remove lock wire from eight square-headed cap screws (fig. 71). Remove cap screws, and pull gear assembly from rear end of crankshaft.

x. Remove Crankshaft Assembly. Screw a nut onto each of the four corner cylinder hold-down studs on the No. 9 cylinder pad to protect the stud threads. Place main crankcase section on bench with

**ORDNANCE MAINTENANCE — ORDNANCE ENGINE
MODEL R975-C4 (CONTINENTAL)**

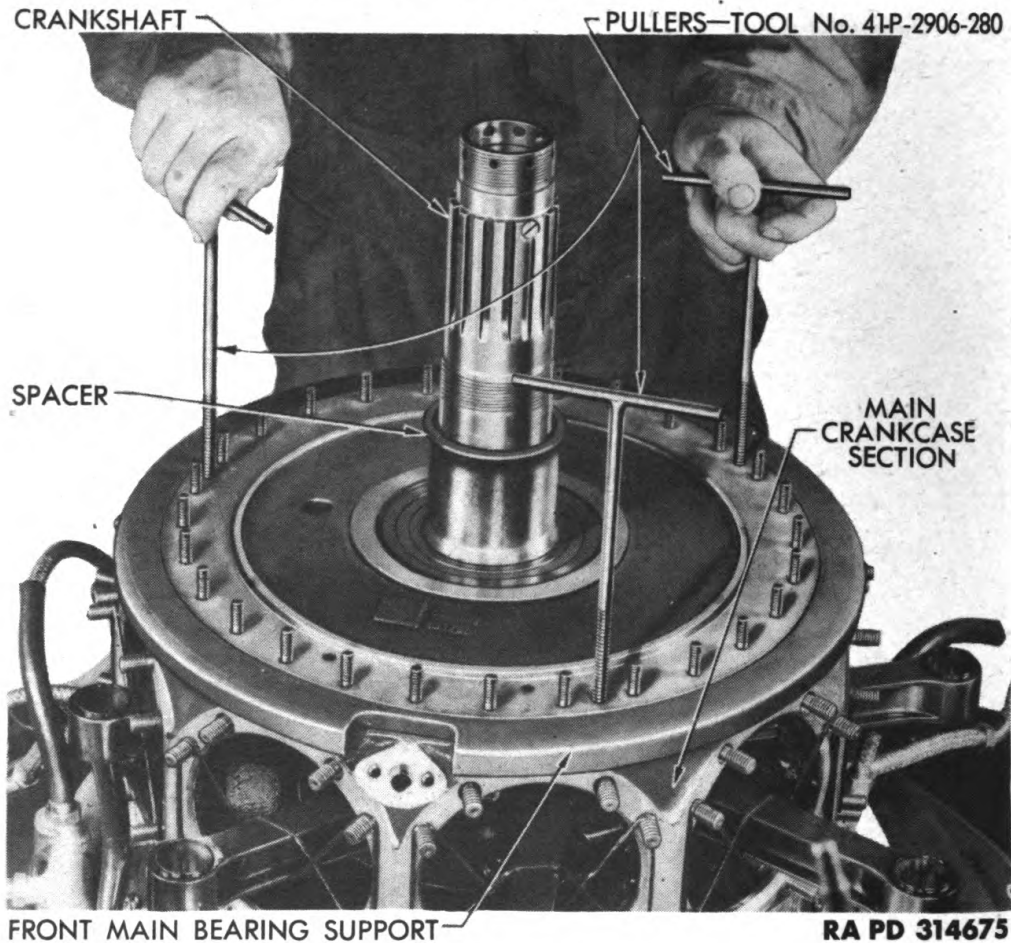

Figure 62 — Removing Front Main Bearing Support

the No. 9 cylinder opening at the bottom. Rotate the crankshaft until the counterweights are opposite the No. 8 cylinder opening. Hold master rod as near to center of No. 1 cylinder opening as possible. Pull and lift assembly out of front of crankcase section twisting it slightly to the right, to allow rear crank journal to slide out of the journal bearing (fig. 72).

y. Remove Sump Drain Pipe and Fitting. Insert bar through holes in sump fitting and unscrew fitting from crankcase (fig. 92). Remove rubber seal from nipple connecting sump fitting to crankcase.

z. Remove Cam. Pull two cotter pins that lock cam hub bearing support to rear main bearing (fig. 73). With wrench (41-W-871-31), turn bearing support loose. Remove support and lift out cam (fig. 74). Remove spacer from under cam.

aa. Remove Valve Tappets. Push each valve tappet in lower row toward center of case. Use magnetized file, or screwdriver, and pull

DISASSEMBLY OF ENGINE INTO SUBASSEMBLIES

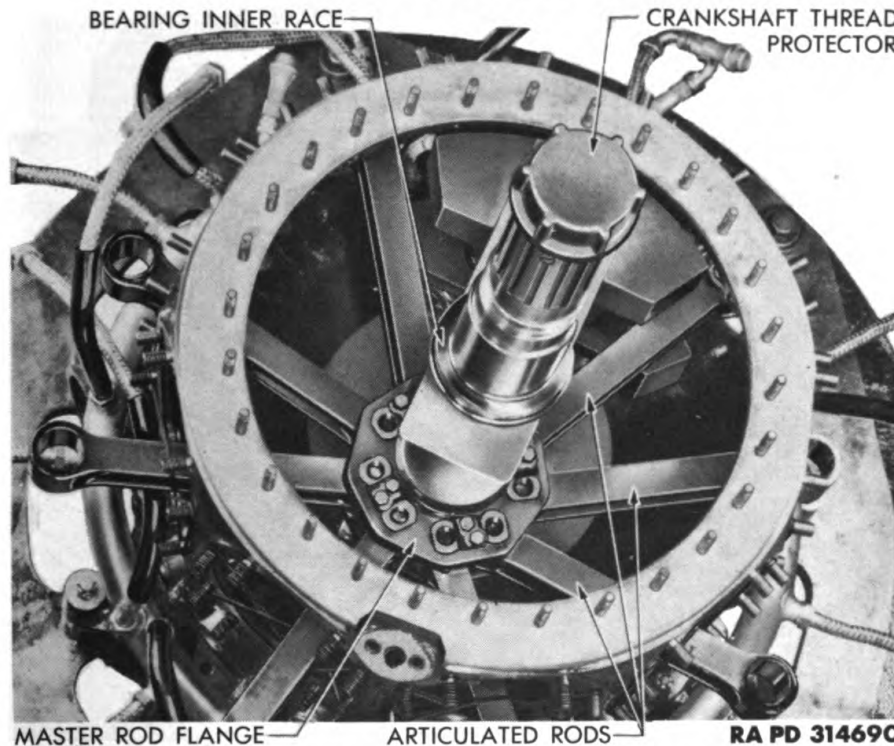

Figure 63 – Interior of Main Crankcase Section Prior to Removal of Articulated Rods

roller pin and roller from tappets (fig. 75). Slide roller pin out from inner end of tappet. Push each tappet through tappet guide and remove from case. Push tappets in upper row toward center of case and remove roller pins. Remove rollers and tappets from case.

ab. Remove Push Rod Housing Adapters. Unscrew and remove the 18 push rod housing adapters (fig. 76). Remove seal from under each adapter.

ac. Tappet Guides and Rear Main Bearing. These items are shrunk into the crankcase, and should not be removed unless they need to be replaced (par. 21 d (2)).

10. REAR CRANKCASE AND DIFFUSER SECTIONS, REMOVAL.

a. Remove Starter Gear and Shaft. Remove starter shaft nut already loosened (par. 9 n). Working from the rear of the rear crankcase section, pull starter shaft from bushing in rear section (fig. 77). Working from front of diffuser section, pull starter gear from bushing in diffuser section (fig. 78). **CAUTION:** *When starter shaft nut is removed, both starter gear and shaft are loose. Be sure that neither assembly falls out of the crankcase section.*

b. Remove Accessory Drive Gears. Remove cotter pins from accessory drive gear nuts. Use a fiber block to keep gears from turn-

**ORDNANCE MAINTENANCE – ORDNANCE ENGINE
MODEL R975-C4 (CONTINENTAL)**

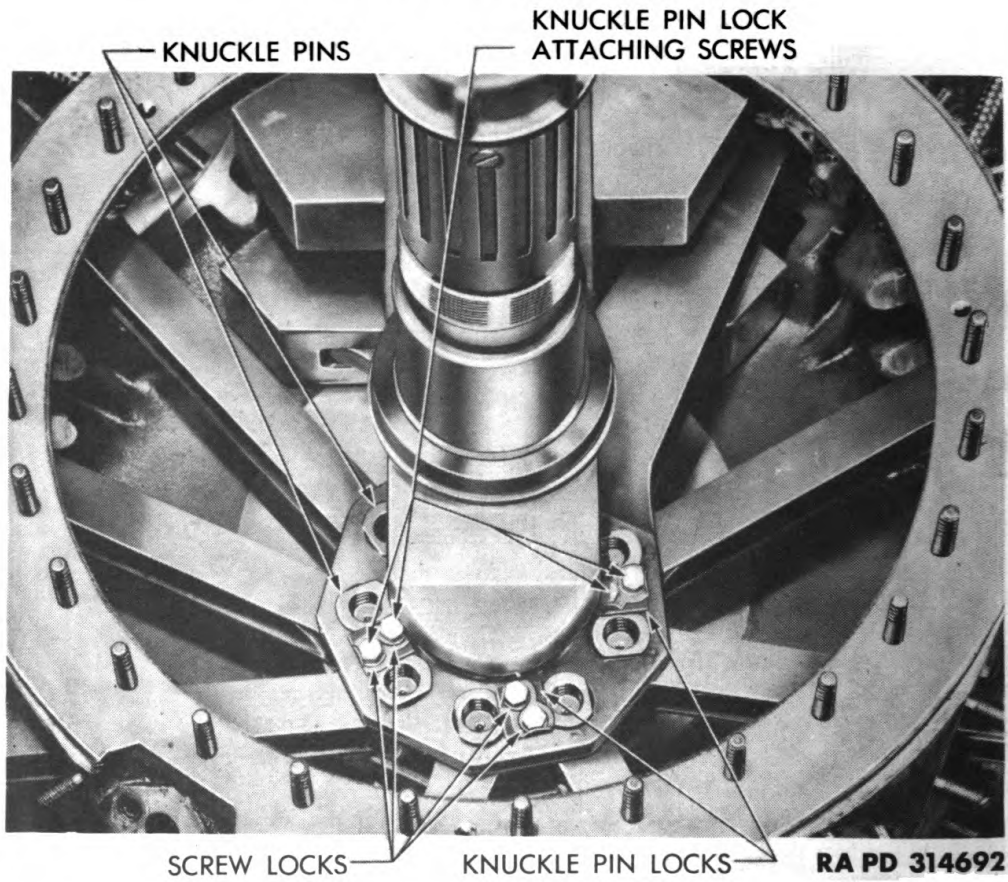

Figure 64 – Knuckle Pin Locks and Bolts

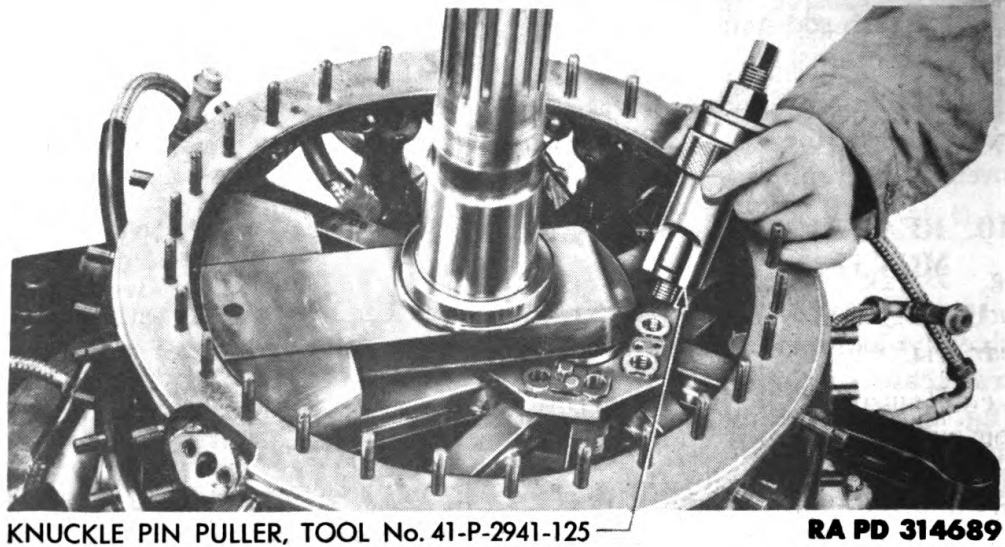
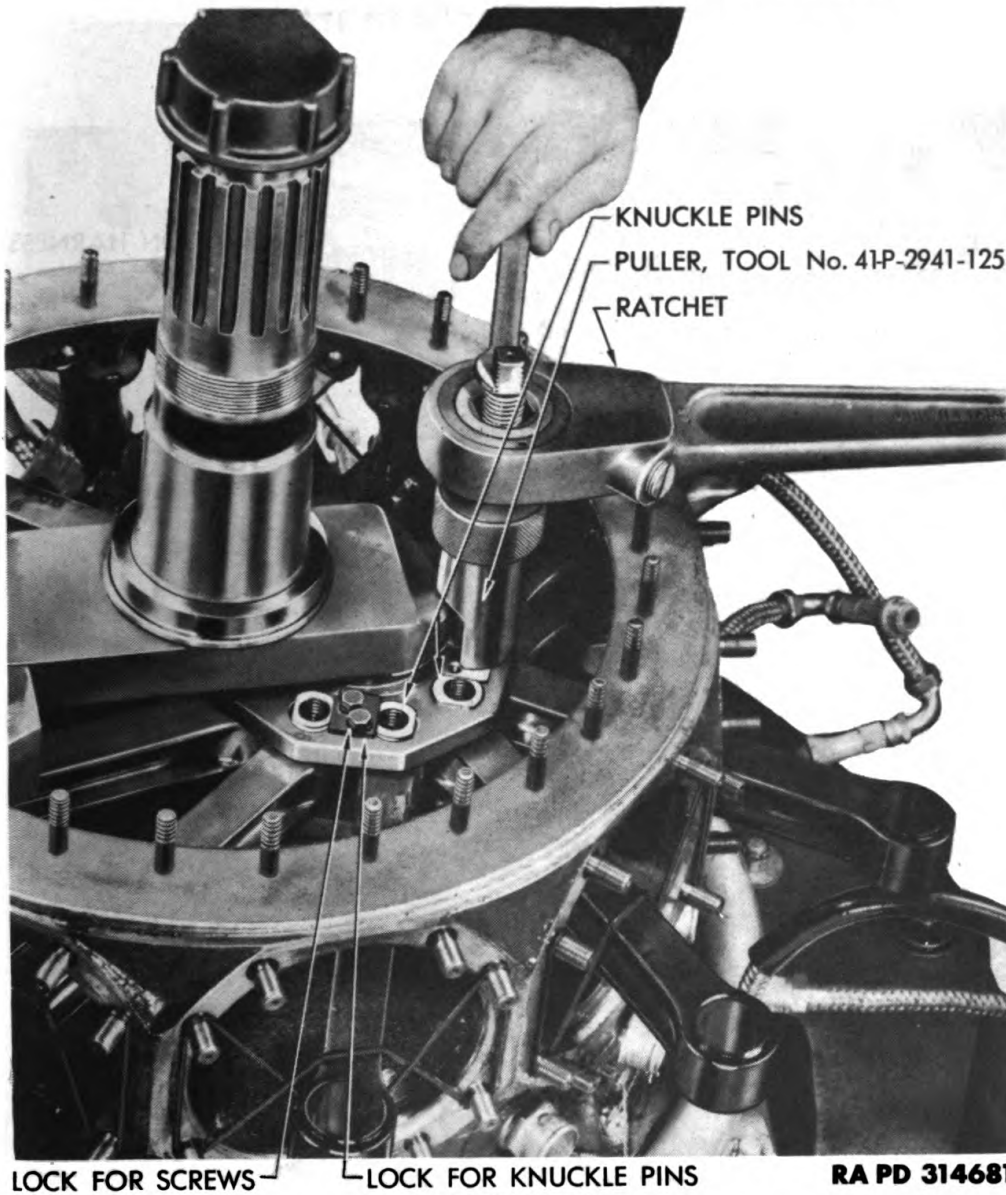

Figure 65 – Installing Knuckle Pin Puller

DISASSEMBLY OF ENGINE INTO SUBASSEMBLIES



RA PD 314681

Figure 66 – Removing Knuckle Pin

ing. Break nuts loose with socket wrench (fig. 79). Remove nuts and pull gears from shafts. **CAUTION:** *Remove Woodruff keys from gear shafts before proceeding further.*

c. Removing Diffuser Section from Rear Crankcase Section. Remove cotter pins from two nuts by accessory drive gear shaft which hold diffuser section to rear crankcase section (fig. 80). Remove nuts and flat washers. Install three pullers (41-P-2906-280) through tapped holes in diffuser section flanges (fig. 81). Turn pullers, and separate diffuser and rear crankcase sections. Perform this operation

**ORDNANCE MAINTENANCE – ORDNANCE ENGINE
MODEL R975-C4 (CONTINENTAL)**

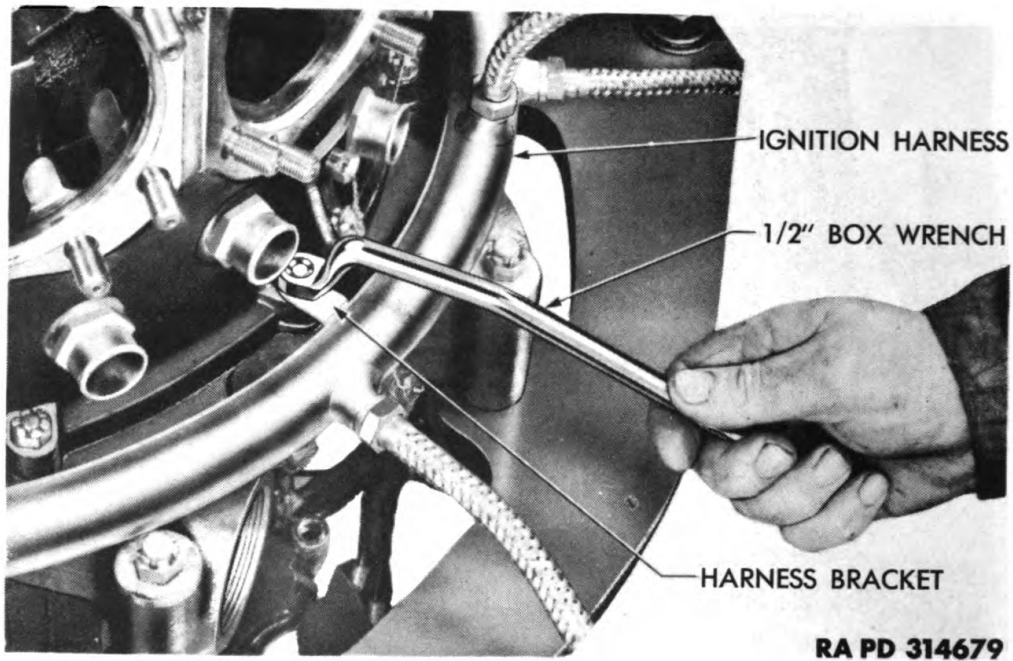

Figure 67 – Removing Ignition Harness Bracket Nuts

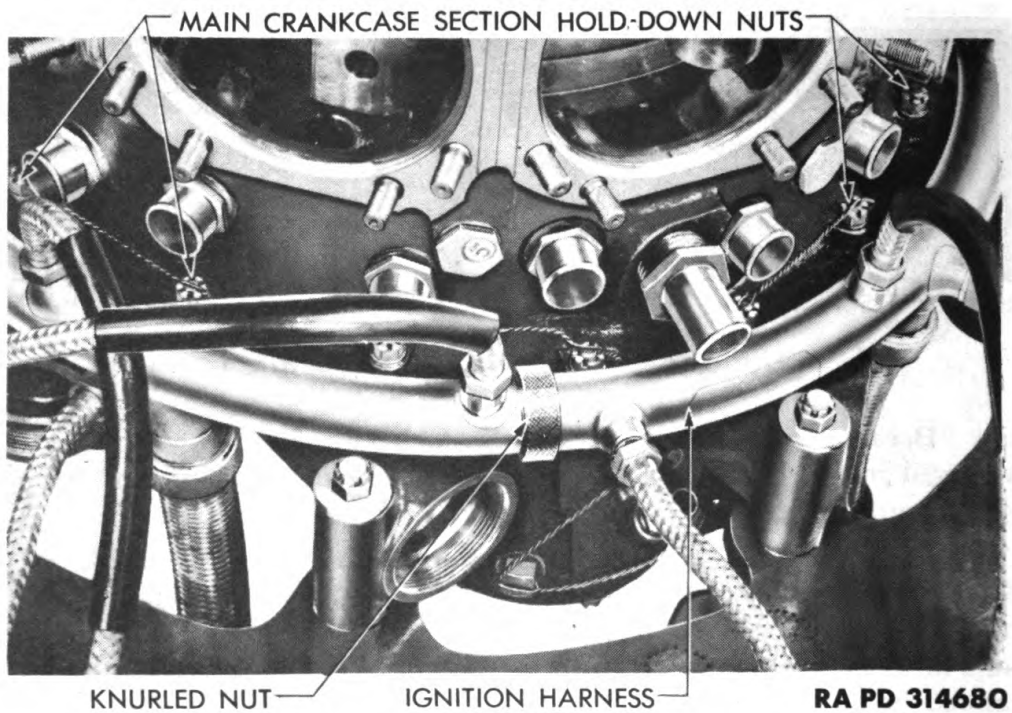

Figure 68 – Knurled Nut Holding Ignition Harness Together

DISASSEMBLY OF ENGINE INTO SUBASSEMBLIES

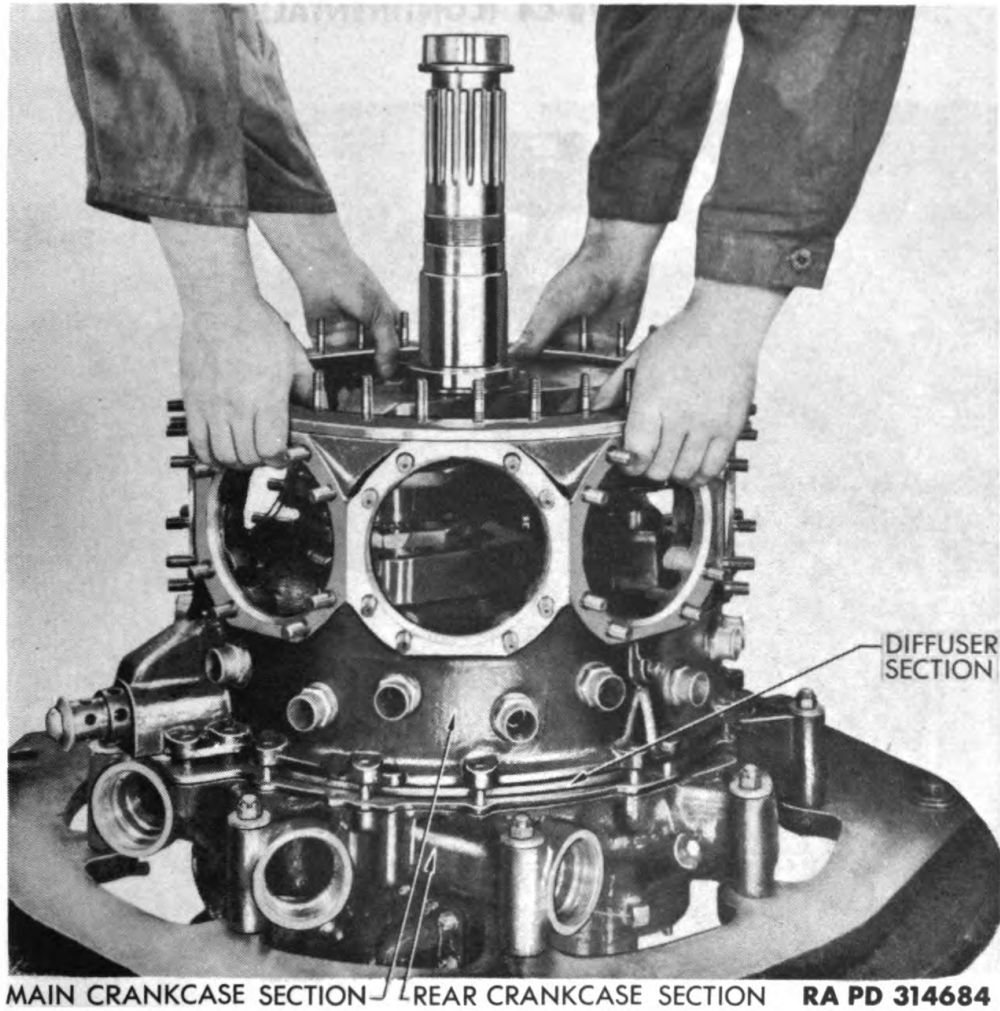

Figure 69 – Removing Main Crankcase Section

carefully so as not to break off the diffuser section flanges. Remove diffuser section from rear section (fig. 82).

d. Remove Rear Crankcase Section. Remove nuts from bolts holding rear crankcase section to mounting stand, and place rear section on inspection bench.

ORDNANCE MAINTENANCE – ORDNANCE ENGINE
MODEL R975-C4 (CONTINENTAL)

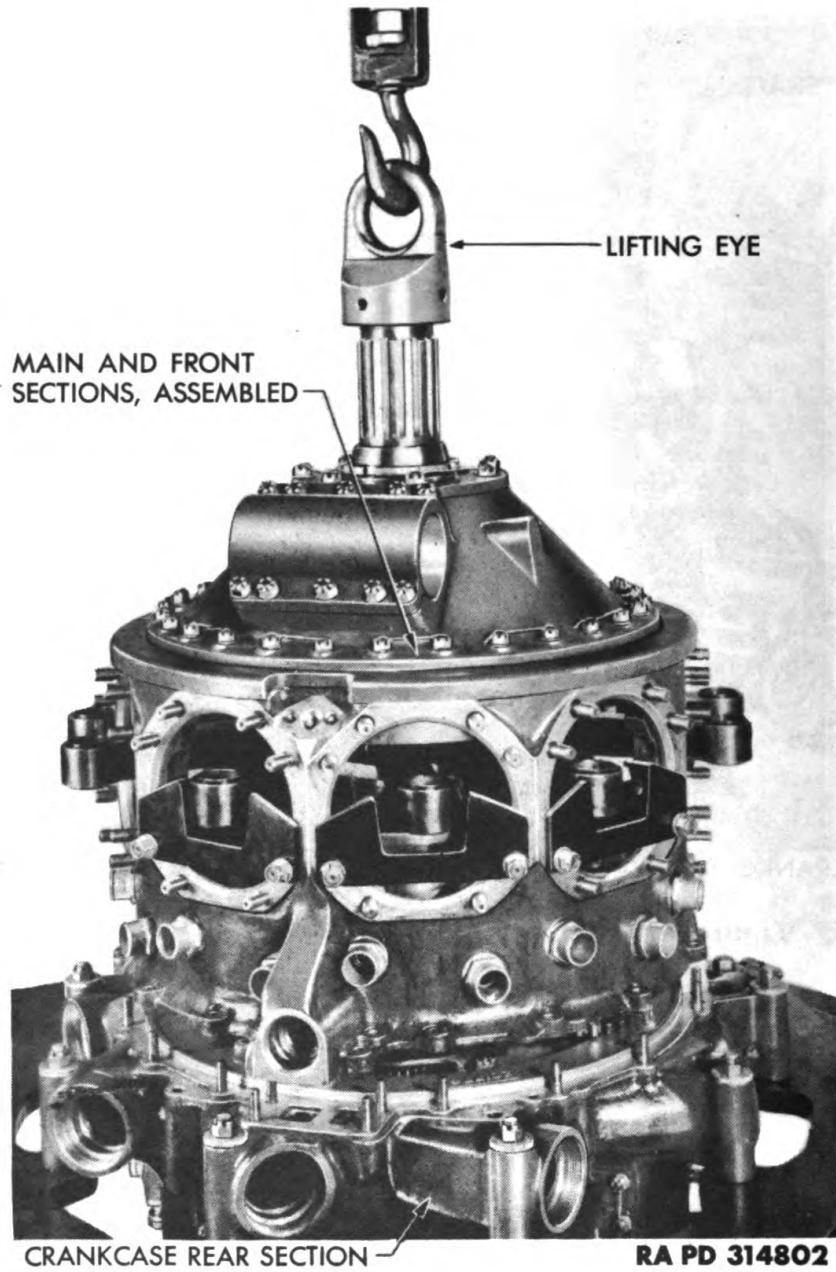

Figure 70 – Removing Main Crankcase Section with Lifting Eye 41-E-615

DISASSEMBLY OF ENGINE INTO SUBASSEMBLIES

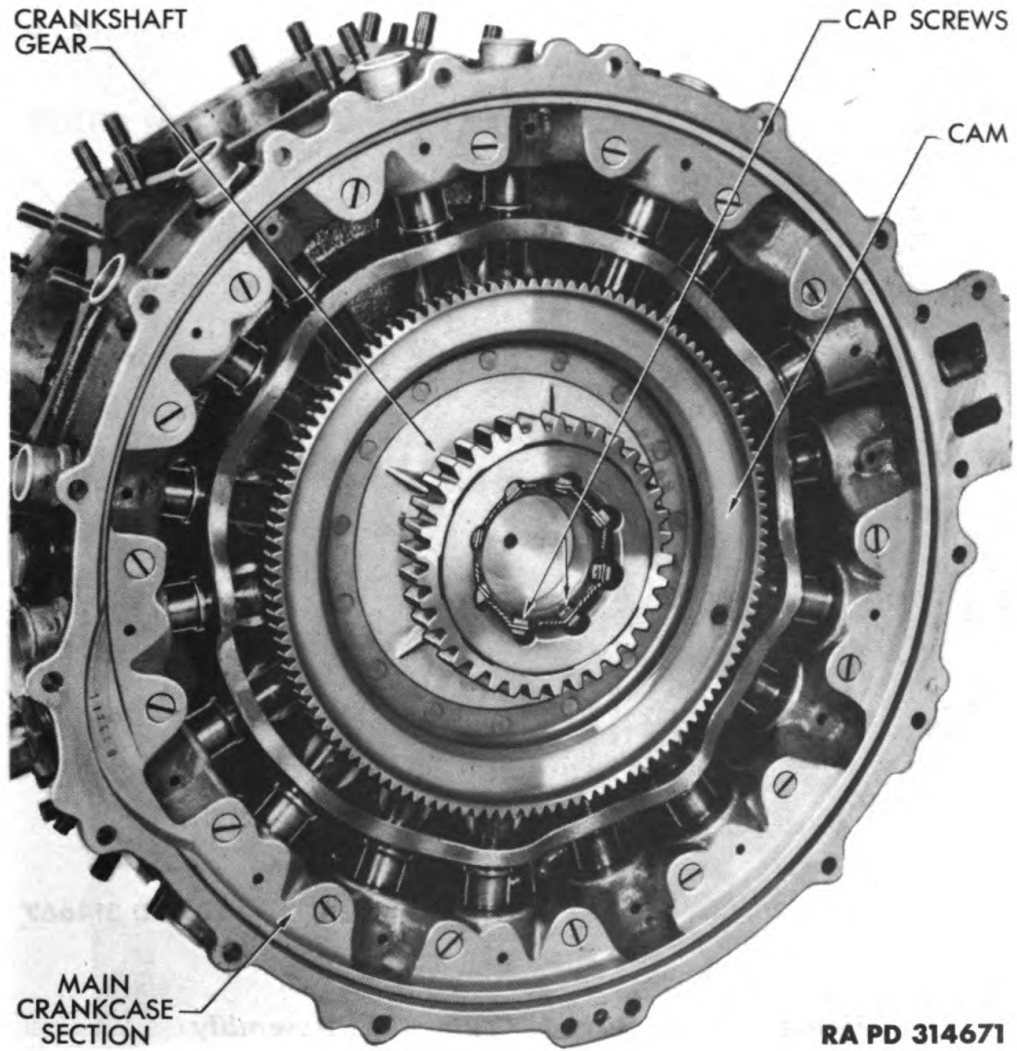

Figure 71 – Main Crankcase Section before Removal of Crankshaft Gear

ORDNANCE MAINTENANCE – ORDNANCE ENGINE
MODEL R975-C4 (CONTINENTAL)

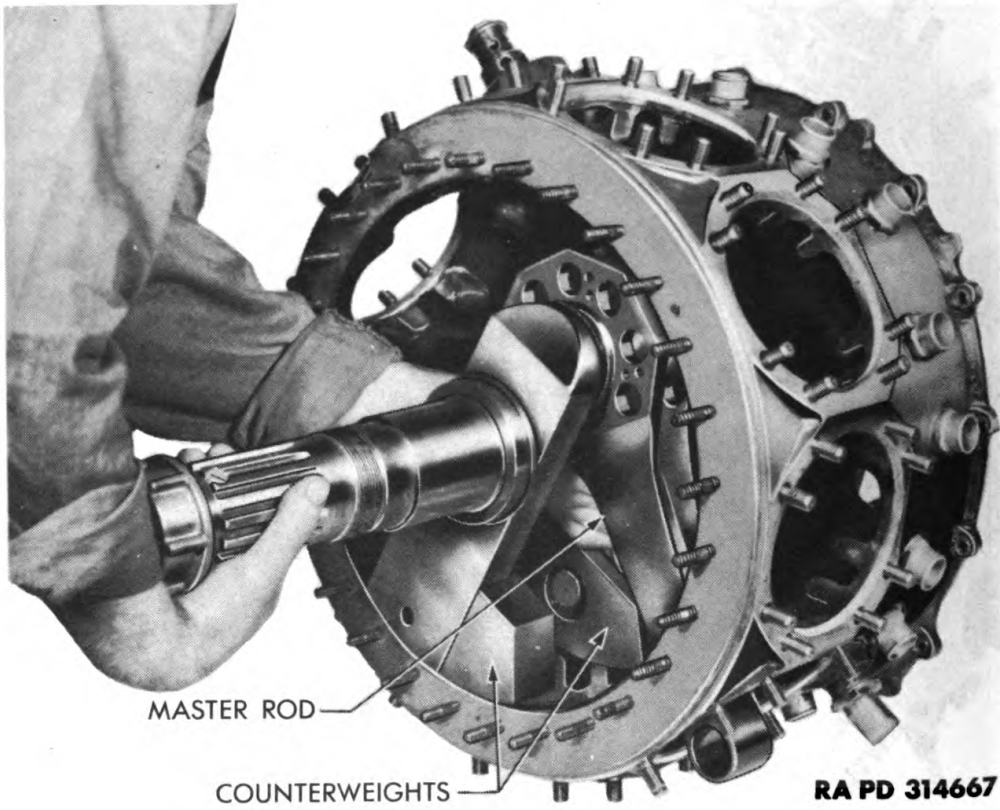
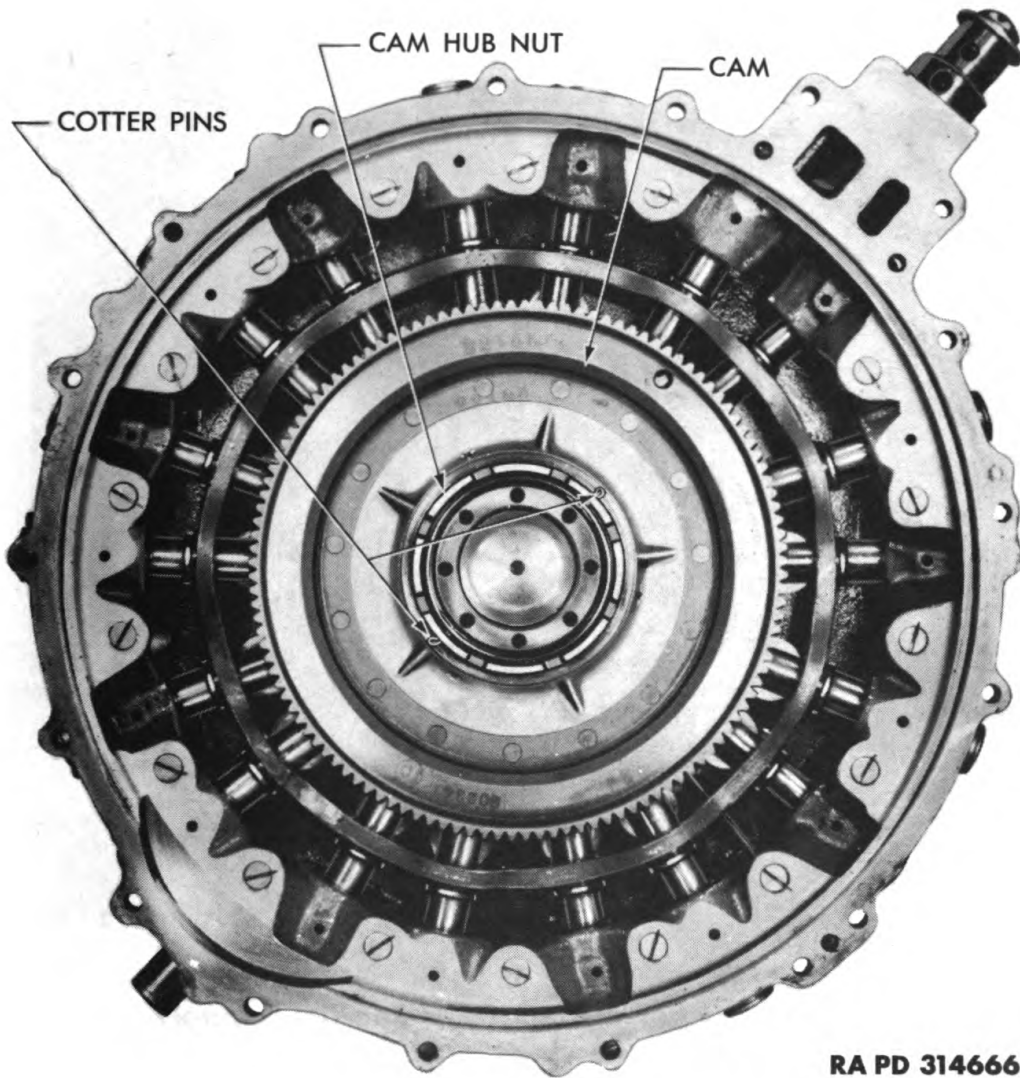

Figure 72 – Removing Crankshaft Assembly

DISASSEMBLY OF ENGINE INTO SUBASSEMBLIES



RA PD 314666

Figure 73 – Cotter Pins in Cam Hub Bearing Support

**ORDNANCE MAINTENANCE – ORDNANCE ENGINE
MODEL R975-C4 (CONTINENTAL)**

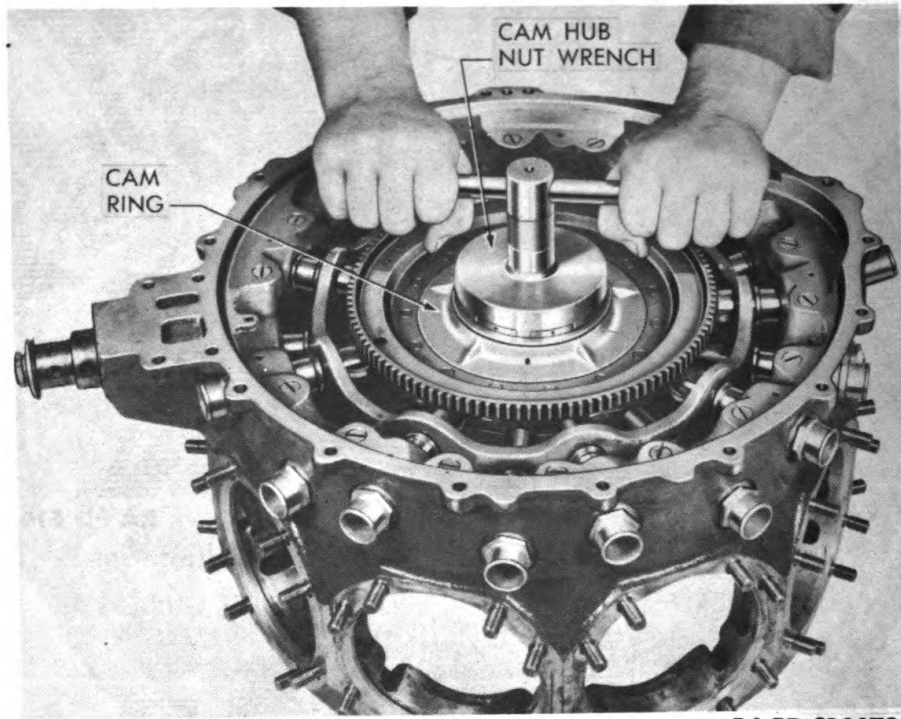

RA PD 314672

**Figure 74 – Removing Cam Hub Bearing Support
Using Wrench 41-W-871-31**

DISASSEMBLY OF ENGINE INTO SUBASSEMBLIES

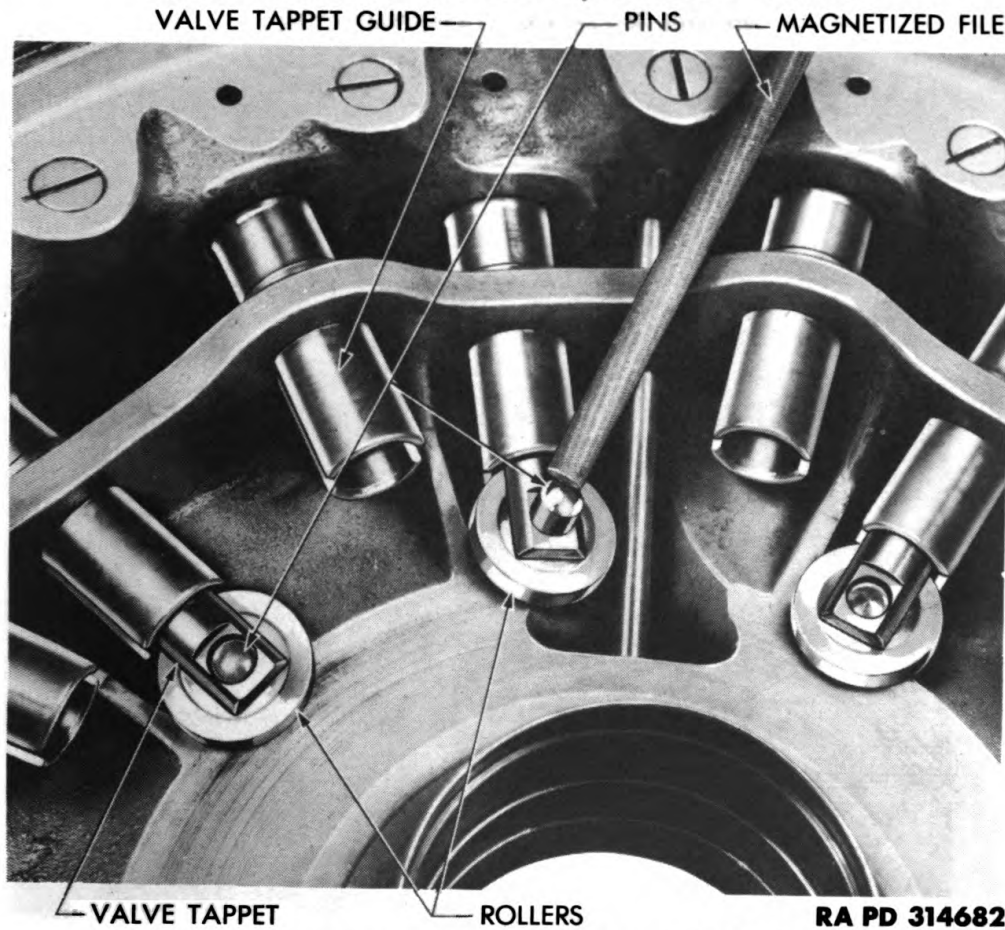

RA PD 314682

Figure 75 – Removing Valve Tappet Roller Pins

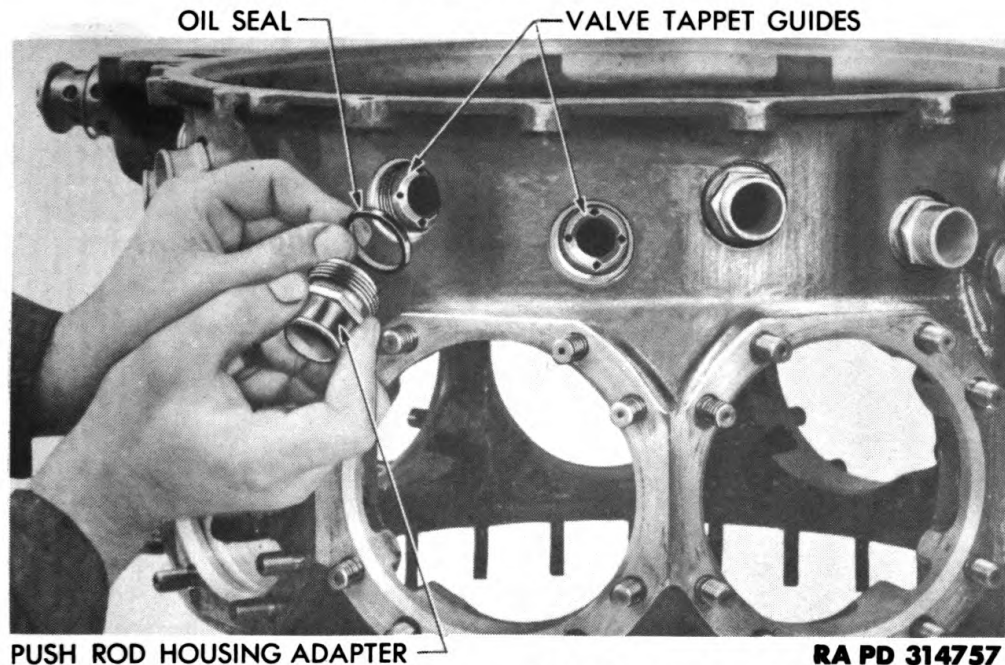

RA PD 314757

Figure 76 – Removing Push Rod Housing Adapters

ORDNANCE MAINTENANCE — ORDNANCE ENGINE
MODEL R975-C4 (CONTINENTAL)

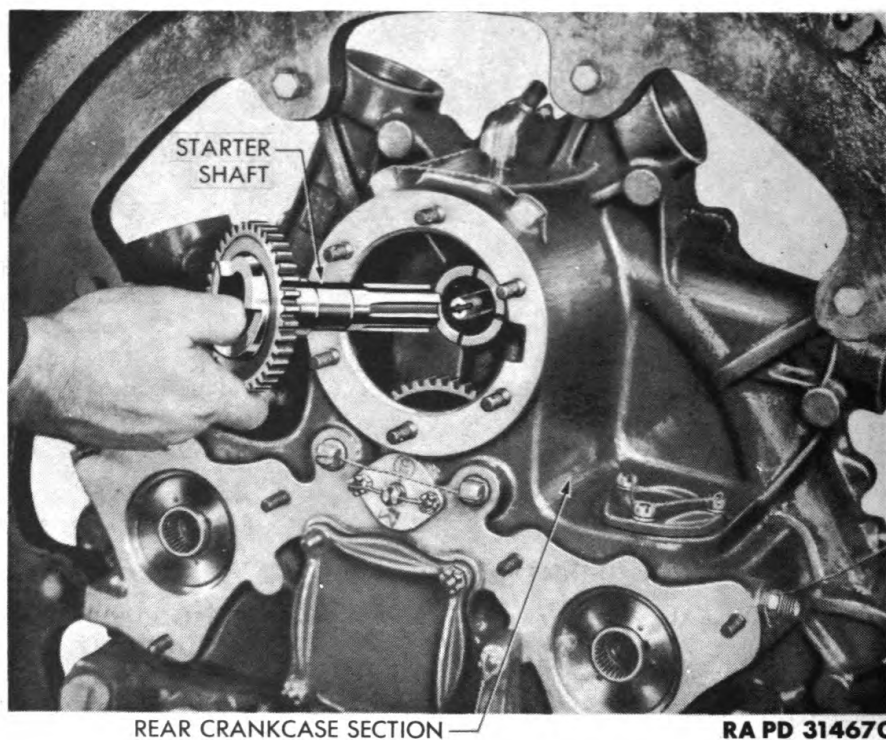

Figure 77 — Removing Starter Shaft

DISASSEMBLY OF ENGINE INTO SUBASSEMBLIES

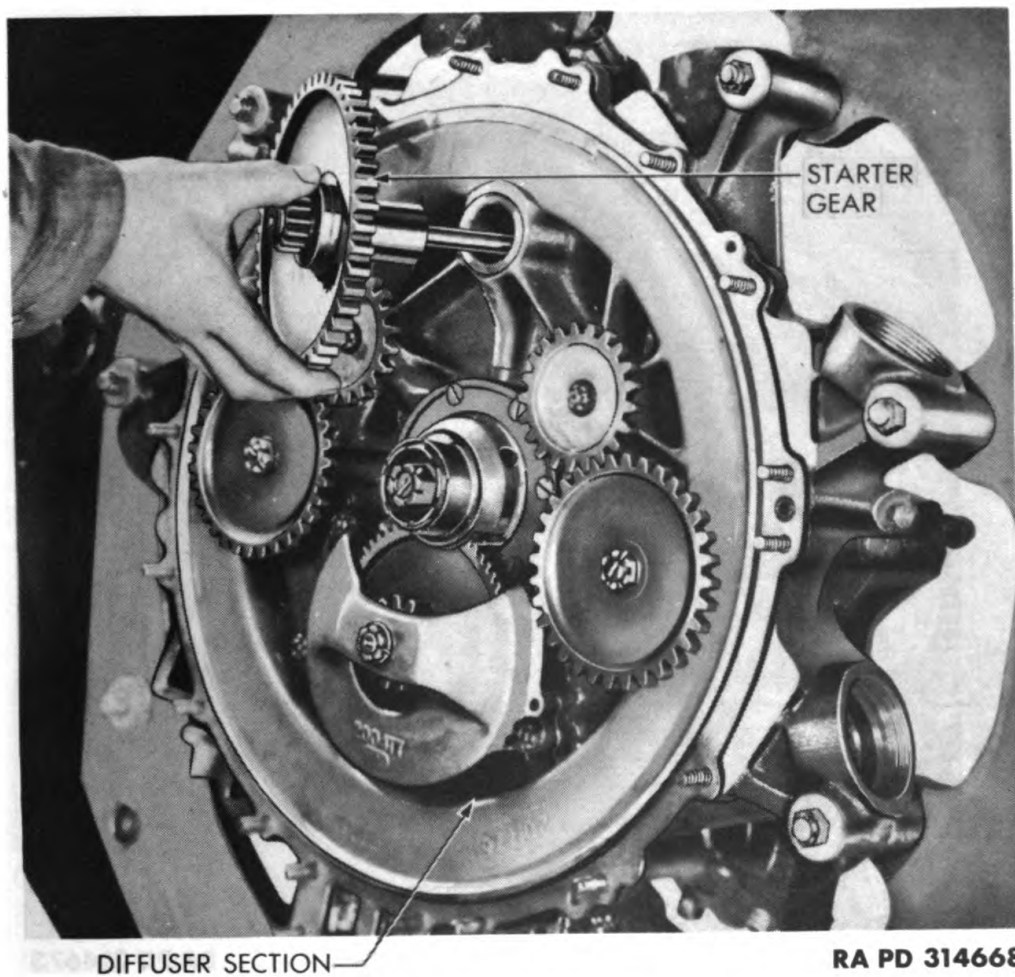

Figure 78 – Removing Starter Gear

ORDNANCE MAINTENANCE – ORDNANCE ENGINE
MODEL R975-C4 (CONTINENTAL)

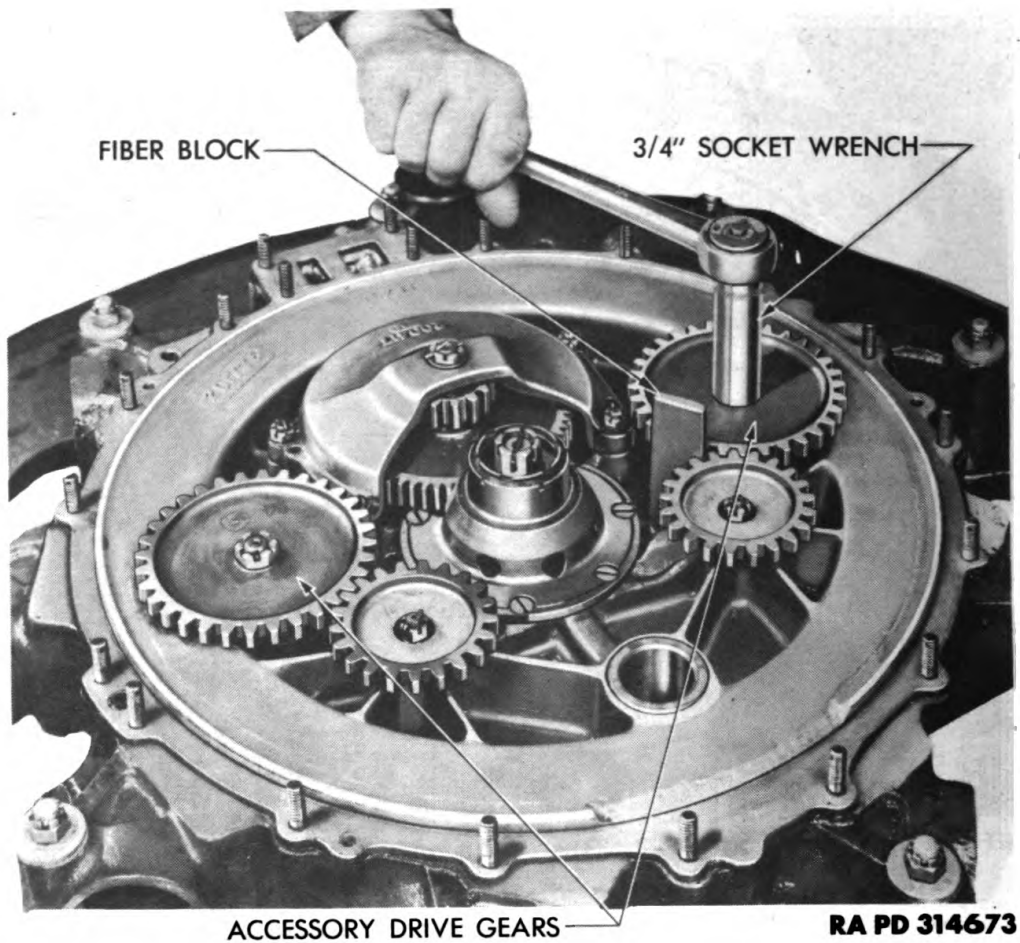

Figure 79 – Removing Accessory Drive Gears

DISASSEMBLY OF ENGINE INTO SUBASSEMBLIES

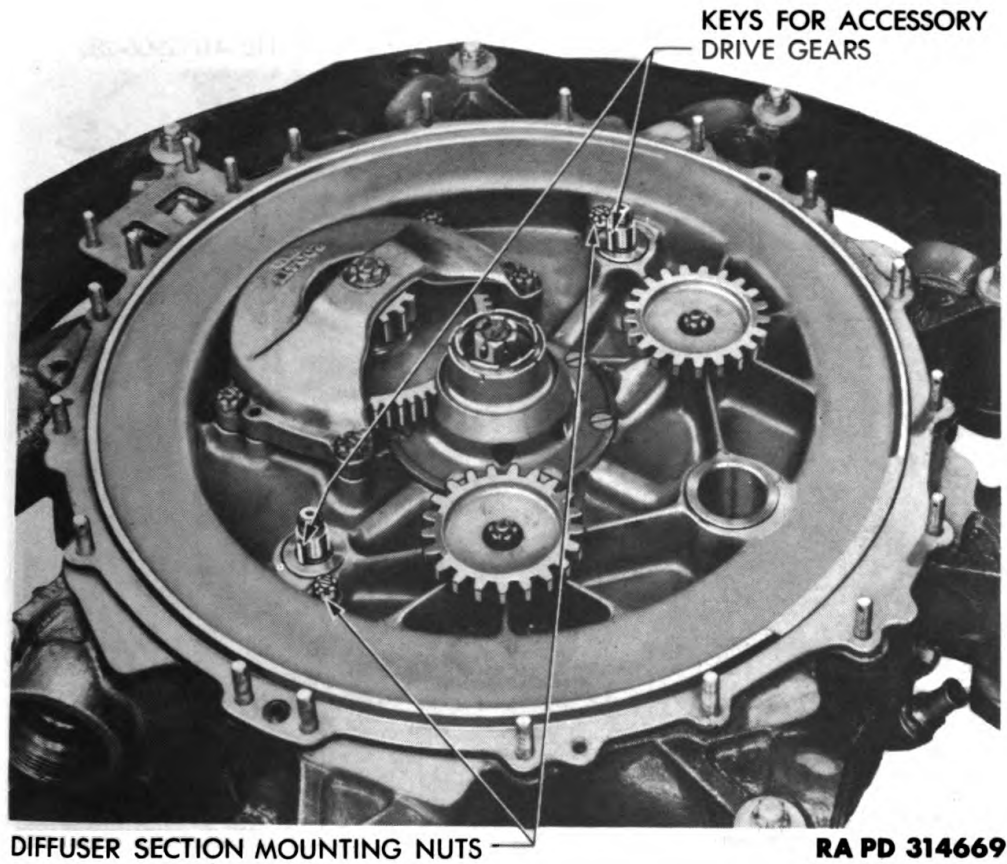

Figure 80 – Diffuser Section Mounting Nuts

ORDNANCE MAINTENANCE – ORDNANCE ENGINE
MODEL R975-C4 (CONTINENTAL)

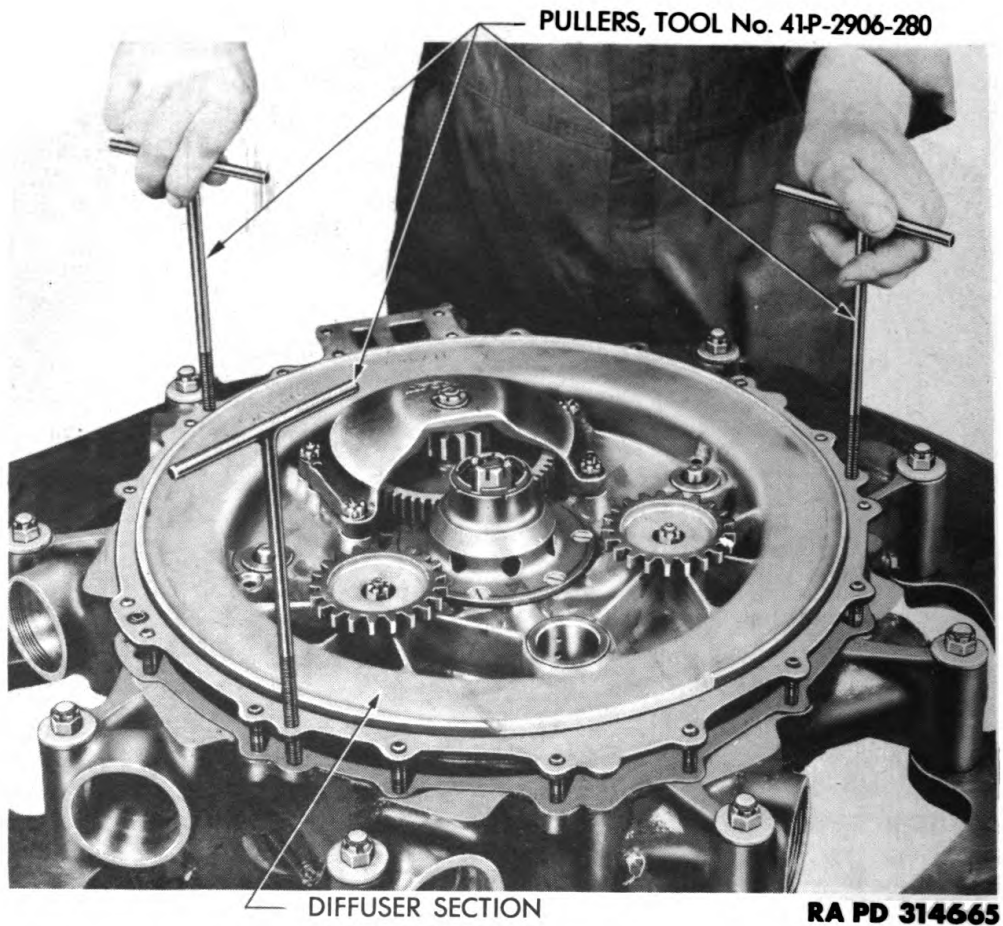

Figure 81 – Separating Diffuser Section from Rear Section

DISASSEMBLY OF ENGINE INTO SUBASSEMBLIES

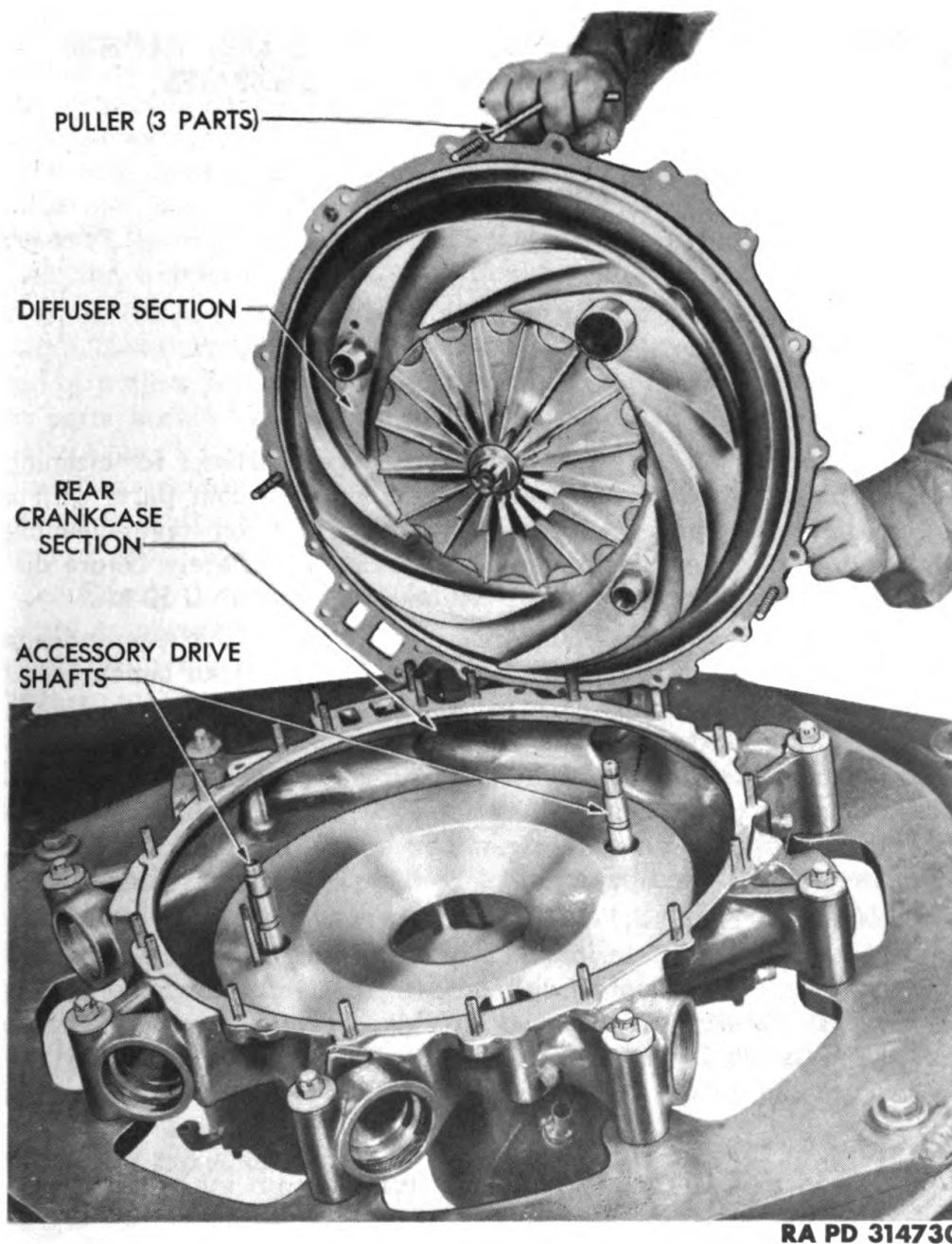

Figure 82 – Removing Diffuser Section

**ORDNANCE MAINTENANCE — ORDNANCE ENGINE
MODEL R975-C4 (CONTINENTAL)**

CHAPTER 4

**DISASSEMBLY, CLEANING, INSPECTION, REPAIR,
AND ASSEMBLY OF SUBASSEMBLIES**

Section I

INTRODUCTION

| | Paragraph |
|------------------|------------------|
| Cleaning | 11 |
| Inspection | 12 |
| Repair | 13 |
| Assembly | 14 |

11. CLEANING.

a. General. Use dry-cleaning solvent as a degreaser for cleaning engine parts. After dry-cleaning solvent is used, coat parts with a film of light oil to prevent corrosion or rusting. When steam-cleaning the engine or engine assemblies, clean them immediately before disassembly. For list of approved cleaners, refer to SNL K-1.

b. Antifriction Bearings. Abrasive dirt in bearing assemblies is difficult to remove, so place bearings on perfectly clean bench either before or after cleaning. Clean bearings in dry-cleaning solvent. Slosh bearings around in the cleaner. Revolve bearings by hand while bearing assembly is submerged to remove all grease, oil, or dirt. Relubricate bearing after washing and draining. To relubricate, spin bearings slowly by hand in clean new engine oil. Wrap cleaned, oiled bearings in oiled paper, or place them in a dustproof container.

c. Oil-impregnated Bearings. Clean engine parts in which oil-impregnated bearings are installed by immersing in dry-cleaning solvent. Refill bearing pores with oil after each cleaning and before re-use. To impregnate bearings quickly, heat a quantity of fresh engine oil to 60° C. (140° F.), and submerge the part containing the bearing in the oil for a period of 15 minutes.

12. INSPECTION.

a. Inspection Before Cleaning. Give parts an initial inspection before cleaning, as dirt and deposits often indicate difficulties or imperfections which would not be visible if the part is clean.

b. Magnaflux Inspection. Have steel parts given a magnaflux inspection. Do not have either ball or roller bearings magnafluxed. The magnaflux machine operator must be a trained specialist.

c. Table of Limits. Use the Table of Limits exclusively to determine whether worn parts should be replaced. The table contains wear limits beyond which parts should not be used.

DISASSEMBLY, CLEANING, INSPECTION, REPAIR, AND ASSEMBLY OF SUBASSEMBLIES

13. REPAIR.

a. **Standard Practice.** Certain repair instructions are standard such as those applying to replacement of studs, polishing and reconditioning of bearing or bushing surfaces, repainting housings, installation of liners, and bushings with the use of heat or dry ice, removal of scratches, nicks, and burs, and replacement of synthetic rubber oil seals and hose connections. The standard practices will not be repeated under detailed repair instructions unless there is a deviation from the standard.

b. **Drive or Push Fit Parts.** Where possible, assemble all parts with a drive or push fit with the aid of heat or dry ice, or both. The use of pullers is not recommended for the removal of drive or push fit parts because of the nature of the materials involved. Use of pullers may cause damage, and necessitate reaming new holes and installing oversize parts. When using heat and ice for installations, use oil or graphite grease to facilitate assembly. **CAUTION:** *Do not heat or cool parts excessively.*

c. **Emery Cloth.** Do not use emery cloth in reconditioning engine parts, as abrasive particles are difficult to remove and injurious if allowed to remain. Emery cloth may also cause scratches which may develop into cracks.

d. **Identification Numbers.** Use care when marking position numbers on parts. Locate numbers in the area the manufacturer used when the engine was assembled originally.

e. **Machining Dimensions.** Where maximum and minimum limits on any dimension are given in the text or in the Table of Limits, attempt to obtain the mean dimension between the two limits.

f. **Replacement of Studs.** Use great care in the replacement of steel studs in aluminum or magnesium alloy parts. Studs must be removed without injury to the part in which the stud is set.

(1) Remove studs with stripped outside threads with stud driver or small pipe wrench. Apply pressure on the handle of the tool used so that there will be no tendency to bend the stud. Back the stud out slowly to avoid overheating of the threads. Any thread lubricant or sealing material used when the stud was installed is probably congealed. Rapid withdrawal of the parts may damage the housing threads.

(2) To remove studs broken off at or near the base, drill out center section of the stud where size permits, and install square shanked stud remover. Back stud out carefully, using a wrench of the proper size.

(3) Clean housing threads prior to installing new stud. Use tap of correct size for this operation. Handle new taps carefully, as they usually cut oversize. If the tap appears to be cutting material away instead of just cleaning out the threads, withdraw it and use an older

**ORDNANCE MAINTENANCE – ORDNANCE ENGINE
MODEL R975-C4 (CONTINENTAL)**

tool. Rough edges or burs on a tap may also cause it to cut oversize. Inspect all taps for evidence of rough edges or burs.

(4) If a stud was removed because it was loose, install next oversize stud. Oversizes of 0.003 inch, 0.007 inch, and 0.012 inch are supplied. Identify studs by machining on the end driven into housing. Examine removed stud for size. Install next oversize stud available. If the removed stud was broken and is not being replaced merely because of loose fit, install replacement stud of same size.

(5) Apply a small amount of thread lubricant to the threads on all studs before installation.

(6) Before installing a stud, be sure it is the correct part, and insert right end in housing.

(7) Be sure relief hole in bottom of stud bore is clear to prevent hydraulic action when stud is driven. Hydraulic action may result in cracking the case.

(8) When driving the stud, feed it in carefully until threads are meshing properly. Turn stud in slowly and steadily until it is approximately in position. Use torque-indicating T-handle in conjunction with the stud driver. Do not tighten stud to exceed torque limit specified in the Table of Limits.

(9) Do not turn studs in rapidly. Threads may overheat and seize or be damaged.

g. Removal of Scratches. Remove scratches on engine parts as follows:

(1) Handle parts carefully to prevent scratching.

(2) Remove small scratches in comparatively hard metals with crocus cloth. Keep cloth wet with clean kerosene. Clean off a sufficient amount of material to eliminate all traces of the original scratch. Use a fine stone if necessary to completely remove deep scratches.

(3) Do not clean or polish the glazed surfaces of bushings unless necessary to clean up scratches or scoring, or to provide specified running clearances.

(4) Be sure to remove all nicks or burs when stoning gear teeth. Stoning alters tooth profile and forms flat spots. Any alteration of the contour on a gear tooth imposes heavy loads on the remaining high spots and may lead to failure. Do not attempt to remove nicks, burs, galling, or pitting below normal tooth surface. Replace severely pitted or damaged gears.

h. Spare Part Installation. Inspect spare parts to make sure that oil passages are clear.

i. Machining Oilite Bushings. Never ream, scrape, bore, or hand-burnish an oilite-type bushing. Reaming, scraping, or hand-burnishing seals the pores and prevents proper seepage of lubrication through bushing pores. Broach bushings to size.

**DISASSEMBLY, CLEANING, INSPECTION, REPAIR, AND
ASSEMBLY OF SUBASSEMBLIES****14. ASSEMBLY.**

a. Cleaning Parts. Clean every part thoroughly with dry-cleaning solvent before installation. Oil part thoroughly. **CAUTION:** *Never use a cloth rag to wipe dust or dirt from parts. Lint from the rag may clog oil lines or filters.*

b. Pre-oiling. When an engine is started, it may require several turns before the oil pump delivers a supply of lubricant to the farthest points. For this reason, coat all parts with oil prior to assembly.

c. Torque Wrenches. Use a suitable torque-indicating wrench when tightening any parts for which torque values are specified (Table of Limits).

d. Standard Replacements. Always replace gaskets, hose, clamps, lock wire, rubber oil seals, cotter pins, palnuts, and bolt head locking straps.

e. Cotter Pin and Lock Wire Installation. Select cotter pins and lock wire to fit snugly in drilled holes in which they are used. When cotter pin is used to lock a castellated nut, set the locked end of the pin inside the castellation; not outside or across it. Unless otherwise specified, one tab of the cotter pin should be bent up and over flat against the top of the bolt or stud. The other tab should be bent down against the side of the nut. Twist lock wire evenly and draw it up tightly. Loose lock wiring may vibrate enough during engine operation to wear the wire through.

f. Castellated Nut Installation. Never back off a nut to line up castellations with the safe-tying hole drilled in a bolt or stud. If the nut must be tightened excessively, or the specified torque limit exceeded, use a new washer or a new nut.

g. Free Movement of Parts. When building up a subassembly, check for free movement after each moving part is installed and secured. See that the part turns freely with no binding, rubbing, or interference. If difficulty is noted, disassemble, locate, and correct difficulty; then reassemble.

h. Assembly Order. Lock all bolts, nuts, and other parts requiring it as the assembly progresses. Do not wait until subassembly is completely built up. Some of the nuts may be missed. Complete every assembly before leaving a job. As soon as each subassembly is completed, plug all external openings and leave them plugged until necessary to open them. This will prevent dropping nuts, washers, and palnuts into the subassembly accidentally, and damaging the engine when it is operated. Guard against small pieces of lock wire getting into the engine when trimming ends with side cutters.

ORDNANCE MAINTENANCE – ORDNANCE ENGINE
MODEL R975-C4 (CONTINENTAL)

Section II

FRONT CRANKCASE SECTION AND FRONT MAIN
BEARING SUPPORT

| | Paragraph |
|-----------------------------|-----------|
| Disassembly | 15 |
| Cleaning | 16 |
| Inspection and repair | 17 |
| Assembly | 18 |

15. DISASSEMBLY.

a. **Remove Front Thrust Bearing.** With a soft hammer, tap thrust ball bearing from crankcase front section. No other disassembly is required.

16. CLEANING.

a. Remove gasket compound from front main bearing support and front crankcase section matching surfaces. Remove sludge from breather hole in crankcase section. Clean all parts of the assembly with dry-cleaning solvent, dry with compressed air, and coat with light film of engine oil. When drying thrust bearing, be sure to blow air stream through bearing at right angles to bearing races so as not to spin the races.

17. INSPECTION AND REPAIR.

a. **Front Crankcase Section.** Using a magnifying glass, inspect front crankcase section and lower half of engine support bar mounting clamp for cracks (fig. 222). Inspect front and rear machined surfaces for nicks or burs. Remove nicks and burs with a fine stone, and polish with crocus cloth. Check for loose rivets on name plate and data plate. Replace any loose rivets found. Inspect front crankcase studs for tightness, condition of threads, evidence of stretching, and for squareness. Remove and replace damaged studs (par. 13 f).

b. **Front Section Cover.** Inspect front section cover for condition of casting and of machined surfaces. Replace cracked cover. Check cover on surface plate for warpage, if galls are found on the front cover bearing race that rides on roller bearing. Replace warped cover.

c. **Thrust Bearing Nut.** Inspect the thrust bearing nut for burs, cracks, and thread condition. If nut is damaged at all, replace it. Remove oil seal rings from thrust nut, and place them in the opening in the front cover. Measure oil seal ring gaps. Gaps should measure between 0.003 and 0.006 inch. Replace ring if gap for either ring exceeds 0.006 inch.

DISASSEMBLY, CLEANING, INSPECTION, REPAIR, AND ASSEMBLY OF SUBASSEMBLIES

d. **Front Cover Shim.** Inspect front cover laminated shim (fig. 222) for breaks. Replace shim if any breaks are found.

e. **Thrust Bearing.** After cleaning bearing (par. 16 a), inspect the condition of balls and races with a magnifying glass. Turn bearing assembly slowly to check for pits, smoothness, flat spots, or excessive wear. Replace bearing if cracks, chips, or pits are found. If bearing assembly is satisfactory, oil thoroughly and wrap it in oiled paper to protect it from dust until assembled into engine.

f. **Main Bearing Support.**

(1) **FRONT MAIN BEARING SUPPORT** (fig. 222). Inspect front main bearing support for cracks, and replace if damaged. Check fit of front main bearing support to the front and main crankcase sections by placing one section on top of the other. Check the front main bearing support parting flanges for nicks, burs, and roughness. Remove burs and rough spots with fine stone. Examine oil deflector plate for cracks around the flange, and check the condition of the lock wire on the four retaining screws. If the deflector is cracked, replace it. If the lock wire is broken, replace it, and check the tightness of the retaining screws.

(2) **FRONT MAIN BEARING.** Inspect the surfaces of the outer race of the front main bearing for scoring and galling. Remove slight scores and galls with fine stone. Do not attempt to remove heavy scores or galls, but replace race and roller assembly. Check rollers for pits and flat spots, by testing operation of rollers on inner race still installed on the crankshaft. If rollers are pitted, or have flat spots, replace bearing assembly. For removal of front main bearing inner race, refer to paragraph 31 i.

(3) **FRONT MAIN BEARING SUPPORT RING** (fig. 222). Remove any rough spots from front main bearing support ring with crocus cloth. Insert bearing in ring and check clearance. If clearance exceeds 0.0015 inch, replace support ring. Drill out ring pins and drive ring from support. Drive ring out evenly from both sides. Heat bearing support to 250° F., and freeze new support ring in dry ice, or ice water, if dry ice is not available. Center ring in support making certain that it is flush with the edges of the support at both sides. Allow support to cool. Drill three holes from 0.186 to 0.187 inch in diameter through the ring and into bearing support. Drill holes to a depth of from 0.560 to 0.590 inch. Space holes midway between old pin holes, and drill them at an angle of approximately 20 degrees to the face of the support. Pins should be several thousandths of an inch larger than the holes to provide a drive fit. Drive pins into holes until heads of pins are slightly below face of ring. Remove any nicks and burs around pin holes, and polish with crocus cloth. Place ring support in lathe, and center it from the outside flange, so that as the

**ORDNANCE MAINTENANCE – ORDNANCE ENGINE
MODEL R975-C4 (CONTINENTAL)**

support ring is bored, it will be concentric with flange. Bore ring diameter to between 5.5116 and 5.5126 inches for proper bearing fit. If bearing clearance is within limits, check support ring to see that it is tight in support. If ring is loose, install new pins. Drill new pin holes midway between present pins and proceed as explained above.

18. ASSEMBLY.

a. The front crankcase and front main bearing support are not assembled at this time. For assembly procedure, refer to chapter 5.

Section III

MAIN CRANKCASE SECTION

| | Paragraph |
|-----------------------------|------------------|
| Disassembly | 19 |
| Cleaning | 20 |
| Inspection and repair | 21 |
| Assembly | 22 |

19. DISASSEMBLY.

a. The main crankcase assembly has already been completely disassembled except for the rear main bearing, and valve tappet

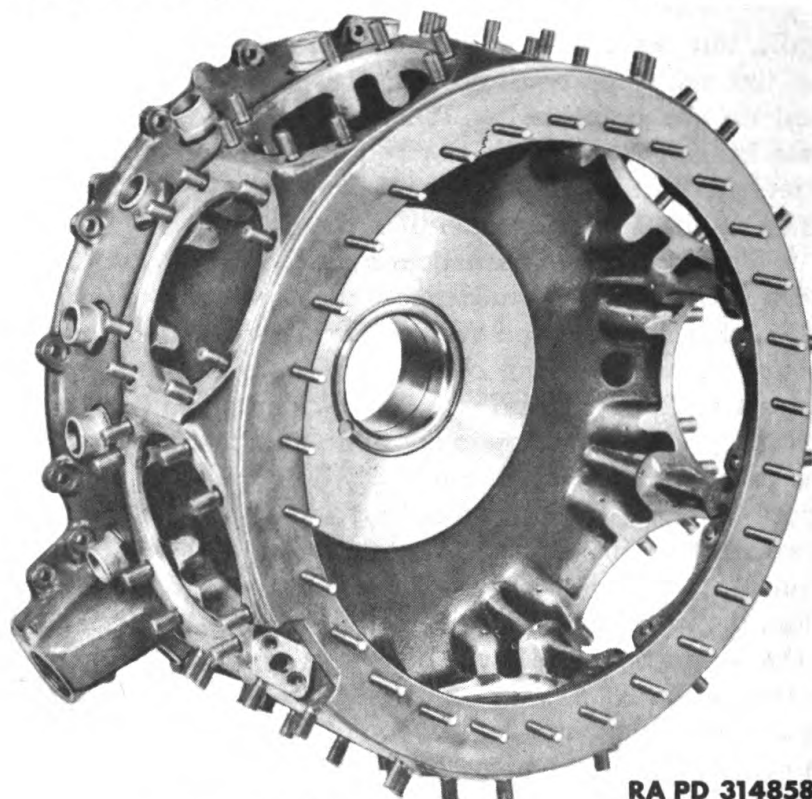

RA PD 314858

Figure 83 – Main Crankcase Section

**DISASSEMBLY, CLEANING, INSPECTION, REPAIR, AND
ASSEMBLY OF SUBASSEMBLIES**

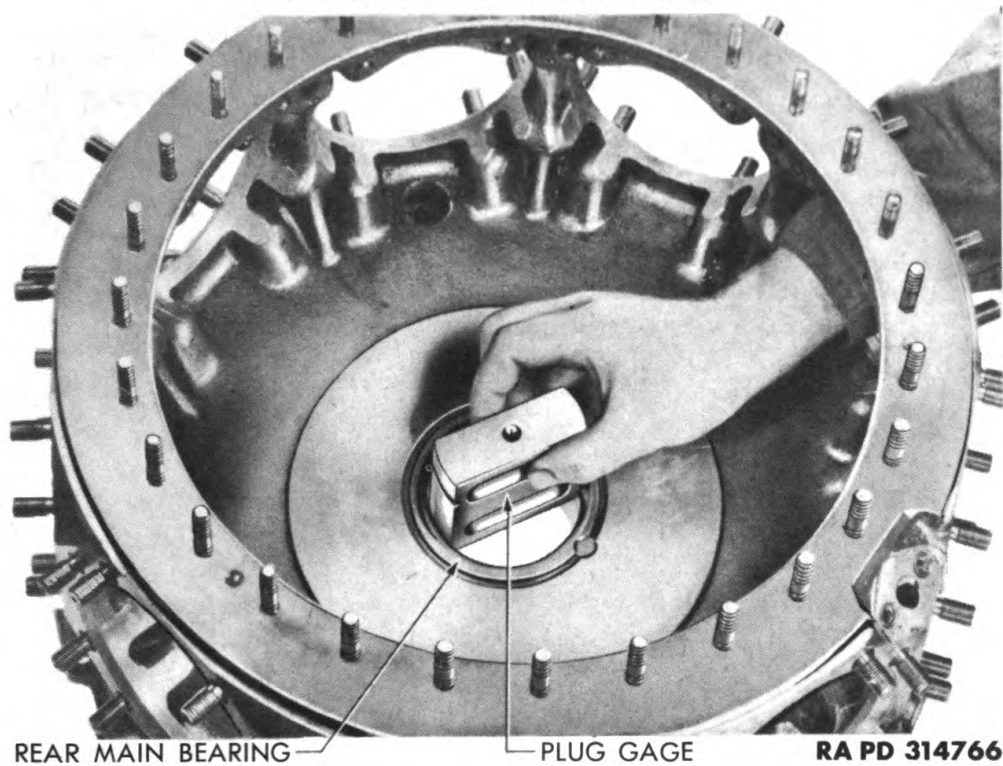

Figure 84 – Checking Rear Main Bearing Diameter

guides, which should not be removed unless it is necessary to replace them. If one or more valve tappet guides and the rear main bearing need replacing, replace them at the same time. This will necessitate heating the case only once.

20. CLEANING.

a. Steam-clean the main crankcase section. Clean the case and valve operating mechanism parts with dry-cleaning solvent. Coat parts with thin film of engine oil.

21. INSPECTION AND REPAIR.

a. **Main Section Casting.** Inspect main section casting for cracks. Pay particular attention to intercylinder webs, cylinder pads, tappet guide webs, and flanges (fig. 83). Replace main section if it is cracked or for any reason unserviceable. Inspect all flanges and machined surfaces for nicks, burs, or roughness. Remove nicks or burs with a fine stone, and polish with crocus cloth. Using a dial indicator mounted on pilot at main bearing, check case for concentricity at the front and rear flanges. Replace case if it is out of round more than 0.003 inch. Check studs for tightness and thread condition. Replace loose, or worn, studs (par. 13 f). Inspect pressed-in oil line for tightness and condition. Blow out line with compressed air. Blow out

ORDNANCE MAINTENANCE — ORDNANCE ENGINE
MODEL R975-C4 (CONTINENTAL)

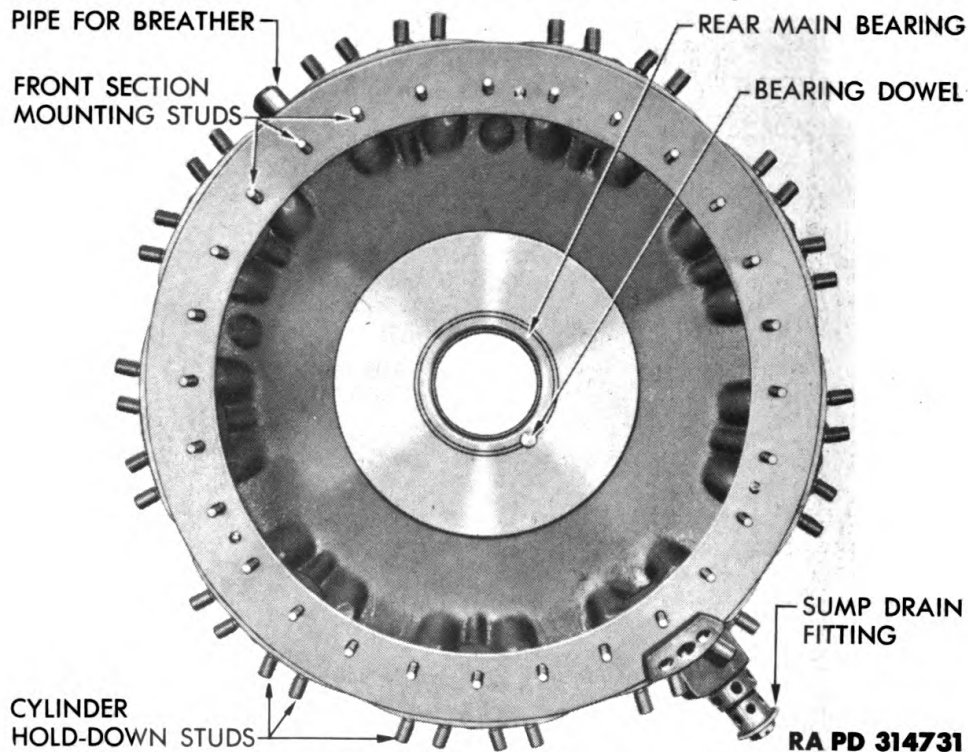

Figure 85 — Rear Main Bearing Dowel

tappet guide oil drain holes to make certain they are clear.

b. Rear Main Bearing. Inspect rear main bearing for looseness. Check surface of bearing for scoring or indications of wear. Inspect the condition of the threads of the cam hub bearing support. Measure the diameter of the rear main bearing with micrometer or plug gage (fig. 84). If diameter does not measure between 3.2215 and 3.2225 inches or if bearing is scored or otherwise damaged, replace bearing. If bearing does not have to be replaced, check the dowel which locks the bearing to the crankcase (fig. 85). If dowel is loose, knock it out with punch, and press in an oversize dowel. After the oversize dowel has been installed, peen the main bearing flange slightly over the head of the dowel.

c. Replace Rear Main Bearing.

(1) REMOVE BEARING. Place crankcase section in oven and heat to 300° F. Remove crankcase section from oven. Slide out bearing and dowel. Select and check fit of new bearing. Refer to the Table of Limits for proper bearing and bore dimensions. If the inside diameter of the bearing bore is oversize, use an oversize bearing, and ream the bearing bore to the proper size to receive oversize bearing.

(2) INSTALL BEARING. Shrink new bearing with dry ice or ice water. Place crankcase in oven and heat to 300° F. Remove crank-

**DISASSEMBLY, CLEANING, INSPECTION, REPAIR, AND
ASSEMBLY OF SUBASSEMBLIES**

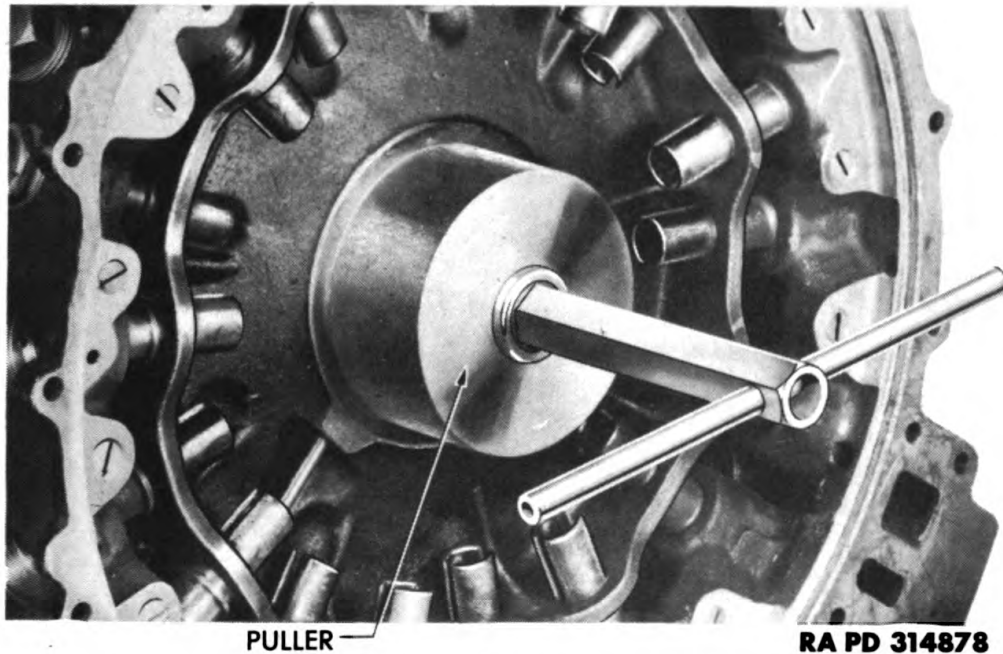

PULLER

RA PD 314878

**Figure 86 – Seating Rear Main Bearing with Puller
(Replacer) 41-R-2373-675**

case from oven. Install pilot in bearing locking dowel hole. Slide bearing into position so that cutaway for bearing dowel fits over pilot. Using bearing puller, carefully press bearing into position so that the bearing flange is shouldered on the front face of the crankcase section (fig. 86). Be sure the threads on the outside diameter of bearing are not damaged. Remove pilot. Drive a new dowel pin into position. Use an oversize dowel pin, if necessary, to secure a tight press fit. Allow crankcase section to cool. Peen the bearing flange slightly over head of dowel to secure dowel in place. Plug oilholes in bearing with paraffin. Install front crankcase section. Install reamer fixture supports (41-F-2994-21) in main crankcase and front crankcase sections and install reamer (fig. 87). Ream bearing to between 3.2215 and 3.225 inches (fig. 88). Remove reamer and supports. Remove front crankcase section. Smooth up inside diameter of bearing with crocus cloth. Clean paraffin from oilholes and clean out passages with compressed air.

d. Valve Tappet Guides.

(1) **INSPECT VALVE TAPPET GUIDES.** Using inside micrometer, or special plug gage, measure inside diameter of valve tappet guides (fig. 89). Replace any guide if it is worn beyond allowable limits (0.6876 to 0.6883 inch). Check guides for cracks, alinement, and tightness in crankcase section. Replace guide if it is loose or cracked.

ORDNANCE MAINTENANCE — ORDNANCE ENGINE
MODEL R975-C4 (CONTINENTAL)

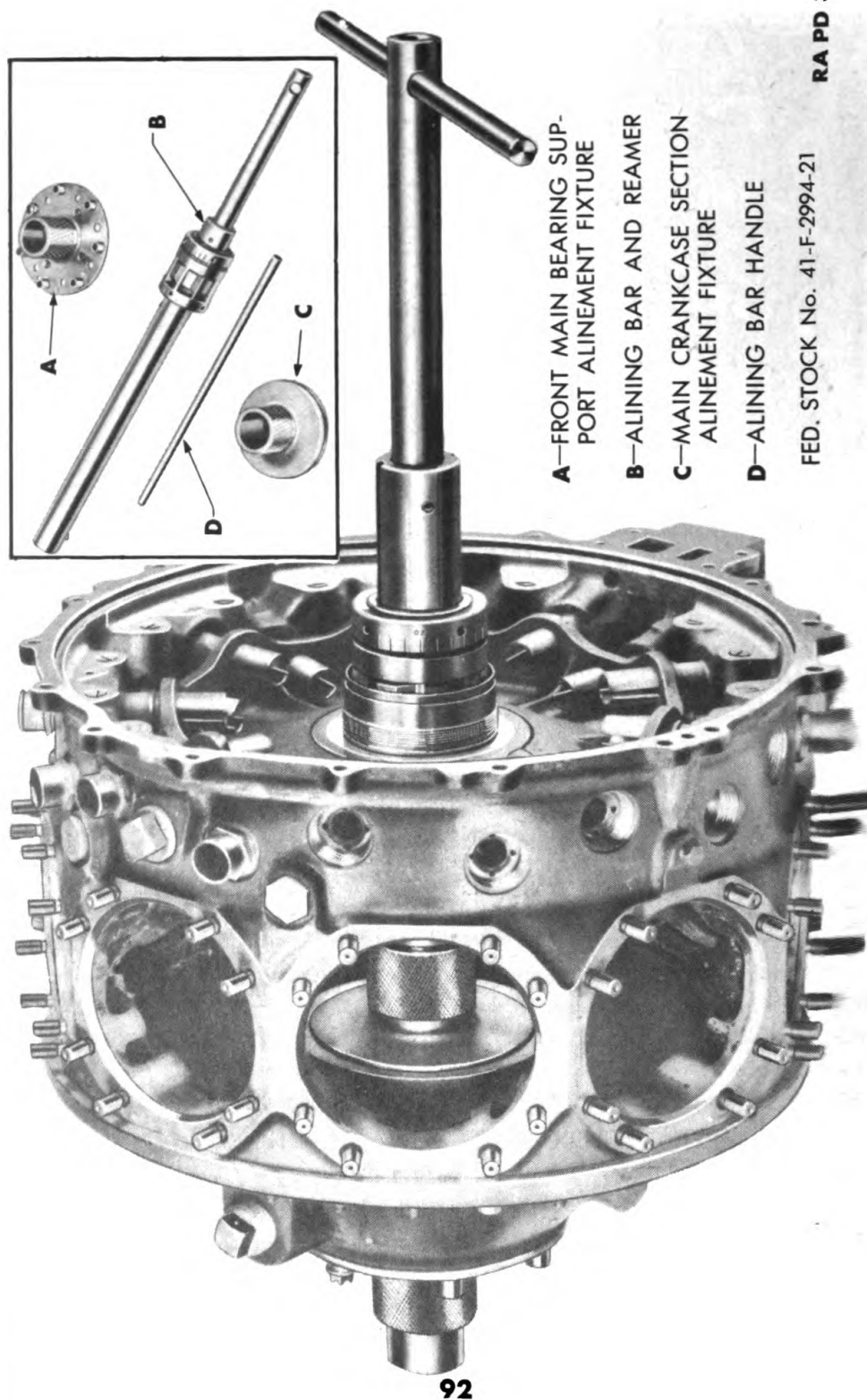
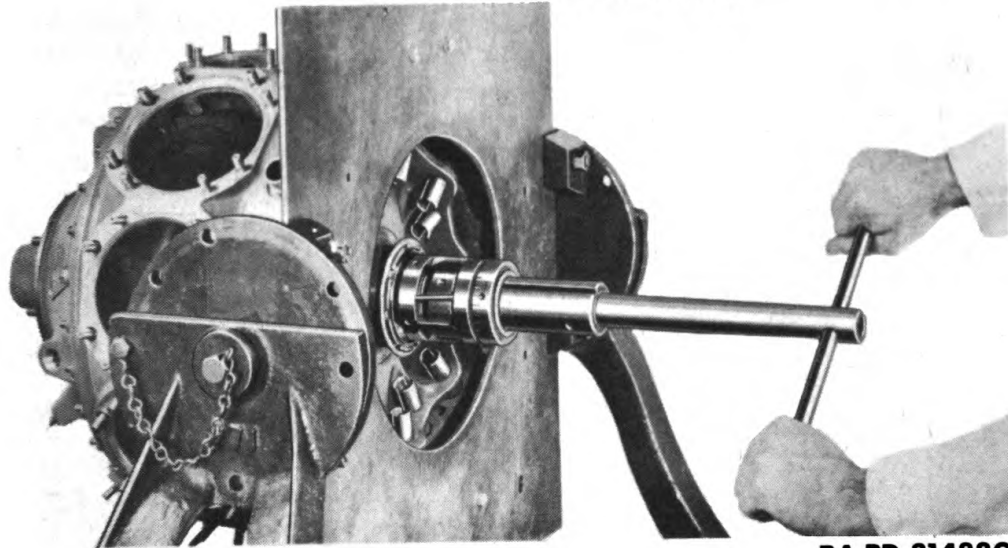

Figure 87 — Fixtures and Reamer Installed for Reaming Rear Main Bearing

**DISASSEMBLY, CLEANING, INSPECTION, REPAIR, AND
ASSEMBLY OF SUBASSEMBLIES**



RA PD 314880

**Figure 88 – Reaming Rear Main Bearing
Using Fixture 41-F-2994-21**

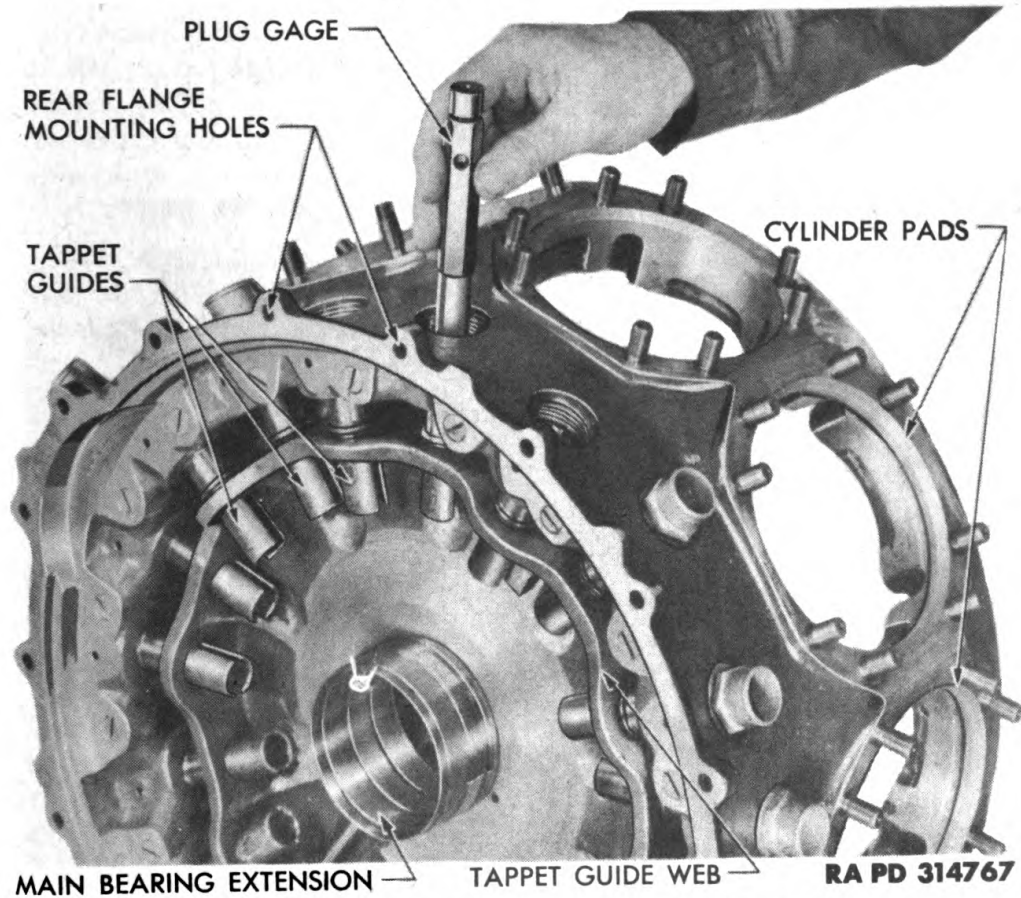

RA PD 314767

Figure 89 – Measuring Valve Tappet Guide

Generated on 2016-07-09 10:10 GMT / http://hdl.handle.net/2027/uc1.b3243961
Public Domain, Google-digitized / http://www.hathitrust.org/access_use#pd-google

**ORDNANCE MAINTENANCE – ORDNANCE ENGINE
MODEL R975-C4 (CONTINENTAL)**

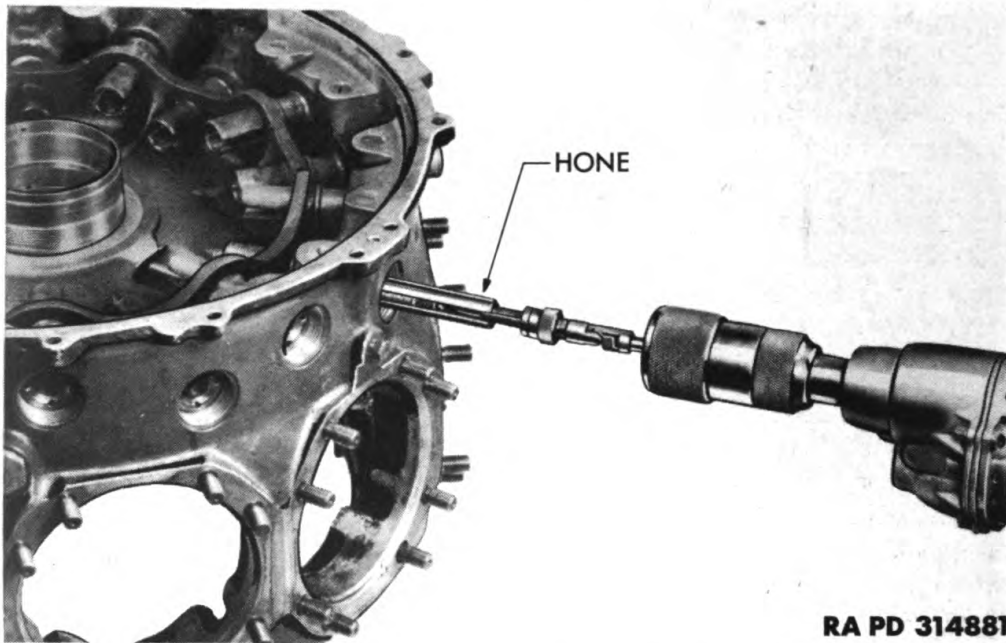

RA PD 314881

Figure 90 – Honing Valve Tappet Guide

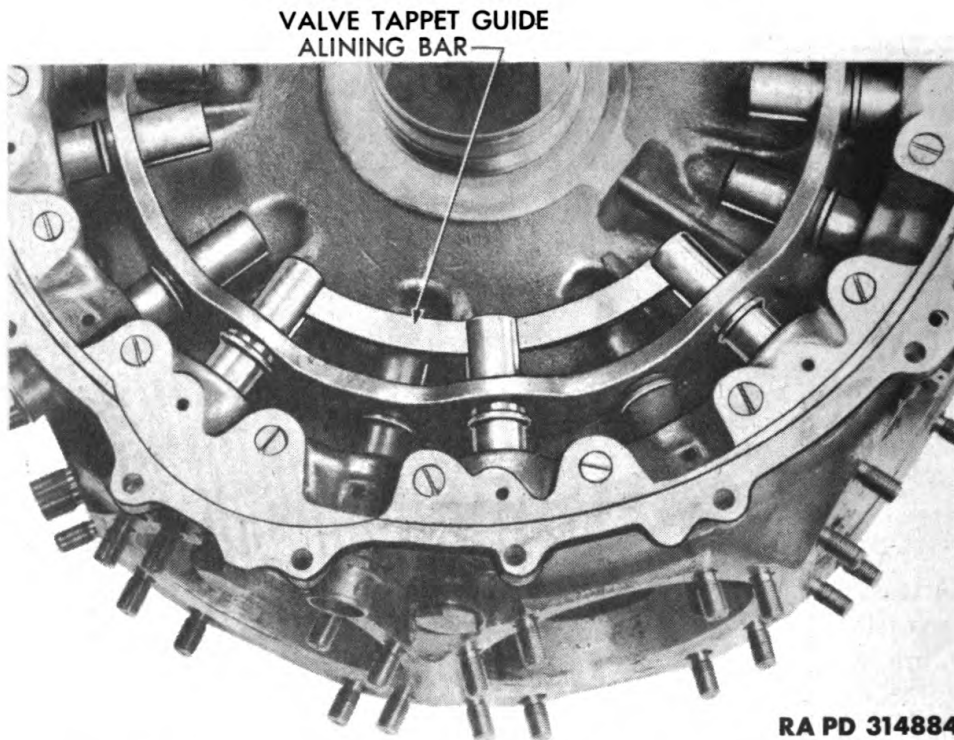

RA PD 314884

Figure 91 – Valve Tappet Guide Alining Bar 41-B-332

DISASSEMBLY, CLEANING, INSPECTION, REPAIR, AND ASSEMBLY OF SUBASSEMBLIES

Examine inner surfaces of guides for scores. Smooth out slight scores with special hone (fig. 90) or crocus cloth wrapped around tool. Check all guides for cleanliness of oilholes.

(2) **REPLACE VALVE TAPPET GUIDES.** Drill out valve tappet guide until a shell approximately 0.015 inch thick remains. Break out remaining shell, being extremely careful not to mar the guide bore in the crankcase. Pick replacement guide. Shrink guide in dry ice or ice water. Place crankcase section in oven and heat to 300° F. Replace guides with rear main bearing if bearing needs to be replaced (par. 19 a). Remove crankcase from oven, and insert guide in guide opening. Aline slots at the inner end of the guide with alining bar (41-B-332) (fig. 91). Be sure that the guide flange is bottomed in its recess.

e. **Valve Tappets** (fig. 235). Inspect sliding surfaces of valve tappets for wear or scoring. Check tappets for cracks, especially around roller pin holes. Inspect rollers and roller pins very carefully for cracks, pits, or flat spots. Check condition of push rod sockets. Pay particular attention to the push rod seat in the socket. See that oilhole through the socket is clear and not obstructed. Inspect push rod socket springs. See that the springs are not broken, that they are of the proper length, and have proper tension. At a length of 2.18 inches, spring tension should be between 7.74 and 9.46 pounds. If tension is less than 6 pounds, replace spring. Replace any unserviceable parts.

f. Cam Hub and Ring Assembly.

(1) **INSPECT CAM HUB, RING, AND GEAR** (fig. 235). Inspect cam hub and ring assembly for cracks. Replace assembly if cracks are found. Check rivets to see that they are tight. If loose rivets are found, install new ones. Inspect cam lobes for wear and evidences of pounding. If lobes are worn or damaged, replace assembly. Examine gear by magnaflux for cracks, and visually for worn or broken teeth. Replace worn or damaged gears. Examine outer surface of hub bearing support for wear, burs, and condition of threads on the inside diameter of support. Clean up light burs and rough spots with fine stone, and polish with crocus cloth. Check cam hub bearing spacer for burs, roughness, and uniform thickness. Replace any unserviceable part. Check smoothness of cam bearing inner surfaces. Measure inside diameter of bearing with micrometer, or plug gage. Clearance between cam hub and cam hub bearing should measure between 0.0015 and 0.0045 inch, tight fit. If clearance is not between these limits, replace bearing. If inside diameter of bearing is greater than permissible limits (Table of Limits) or surface is scored, replace bearing.

(2) **REMOVE CAM BEARING.** Insert cam ring in lathe with cam

**ORDNANCE MAINTENANCE – ORDNANCE ENGINE
MODEL R975-C4 (CONTINENTAL)**

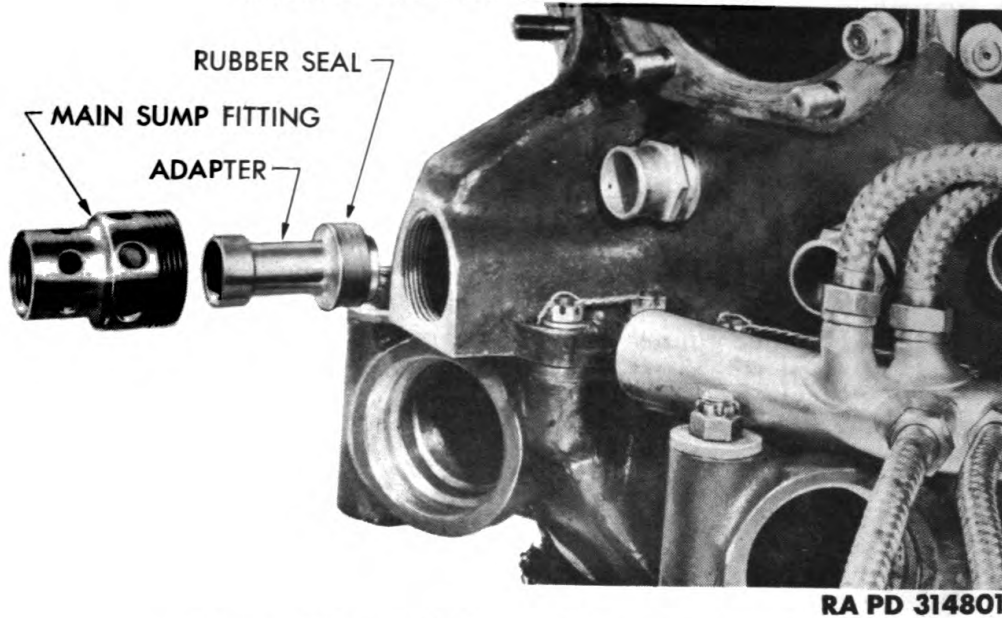

RA PD 314801

Figure 92 – Oil Sump Fitting Removed

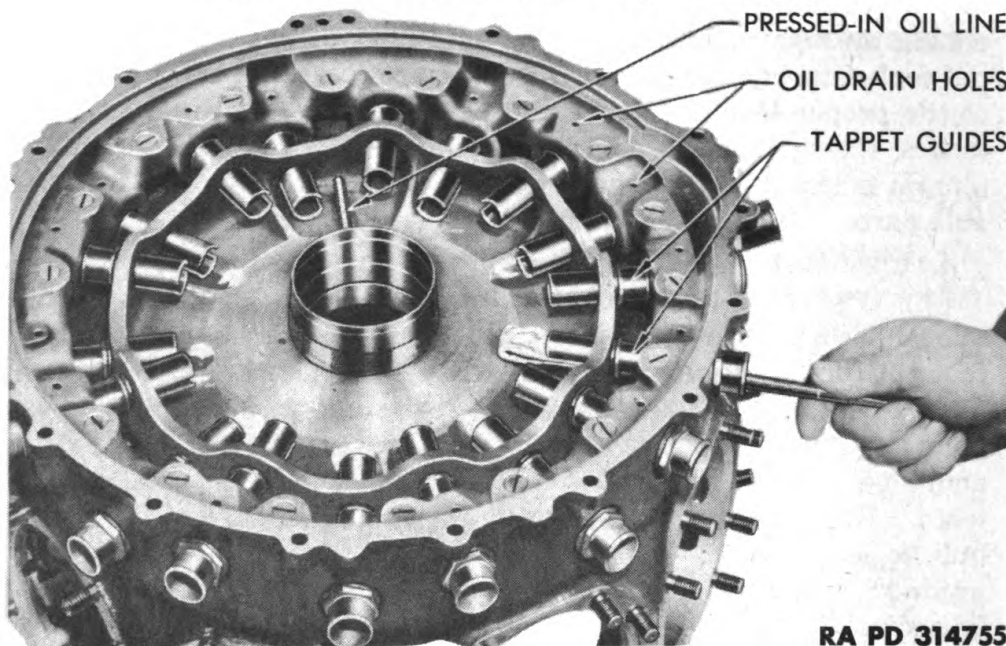

RA PD 314755

Figure 93 – Cleaning Valve Tappet Guide

side against fixture. Center assembly in lathe. Make all centering adjustments from the pitch line of the gear teeth. To do this, place a 0.184-inch diameter pin between any two teeth of the external gear. After centering assembly, bore out bearing so as to leave a shell approximately 0.015 inch thick. Break out thin shell, being careful not to damage cam hub bore. After removing bearing, drive out hub bearing pins. Polish the inside diameter of the hub especially around the pin holes.

**DISASSEMBLY, CLEANING, INSPECTION, REPAIR, AND
ASSEMBLY OF SUBASSEMBLIES**

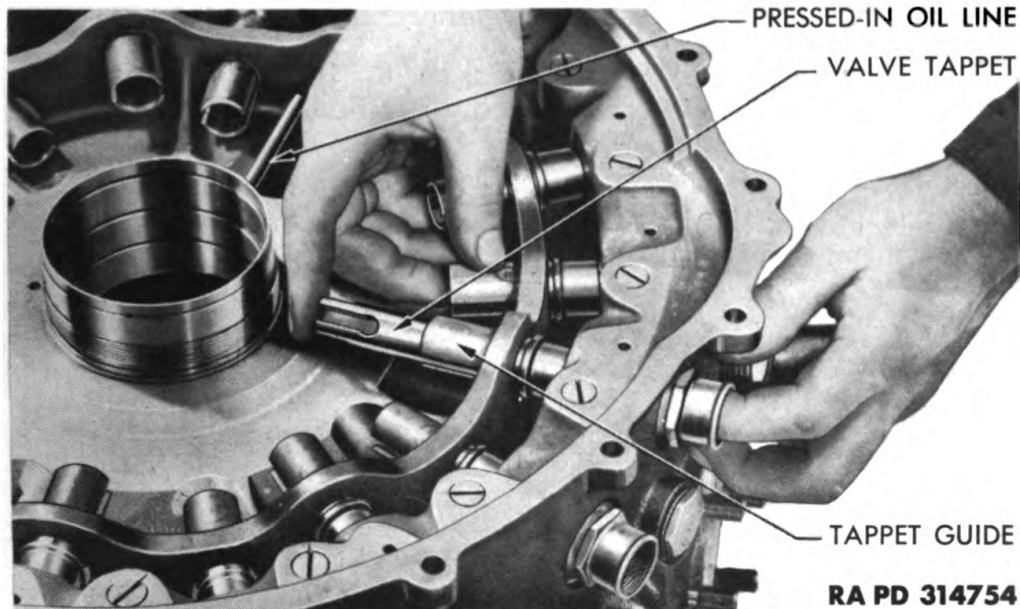

Figure 94 – Testing Valve Tappet Fit

(3) **INSTALL CAM BEARING.** Heat the cam hub in hot oil for 15 minutes. Relieve the entering edge of the steel-back bearing with a file, and smooth with fine emery cloth. Place a light coating of oil on the steel back. Remove hub from hot oil, and with the oilholes in the bearing lined up with the oilholes in the hub, within $\frac{1}{16}$ of an inch, press in bearing to within $\frac{1}{32}$ inch from the counterbore in the long end of the hub. Pack all oilholes with paraffin to prevent chips from entering oil passages. Drill a 0.183-inch hole through bearing at each of three pin hole locations in hub. Drill hole at an angle of 20 degrees. Drive 0.186-inch pin in each pin hole, and peen metal around pin holes lightly to secure pins. Set up cam assembly in lathe as previously explained. Bore out bearing to an inside diameter of from 3.8745 to 3.8755 inches.

22. ASSEMBLY.

a. Install Sump Fitting. Place new rubber seal on fitting nipple and fitting in crankcase (fig. 92). Place bar through holes in fitting and screw fitting into crankcase.

b. Install Push Rod Housing Adapters (fig. 76). Place new rubber seal on push rod housing adapters. Position end of adapters over crankcase opening and screw adapters into crankcase. After screwing each adapter into case, run finger through adapter to make sure rubber seal is properly positioned.

c. Install Valve Tappets. Wrap clean cloth around a rod of suitable size, insert in tappet guide openings, and clean them out thoroughly (fig. 93). Make certain that each valve tappet is clean, and insert it in its matching guide (fig. 94). Tappets should fit so that

**ORDNANCE MAINTENANCE – ORDNANCE ENGINE
MODEL R975-C4 (CONTINENTAL)**

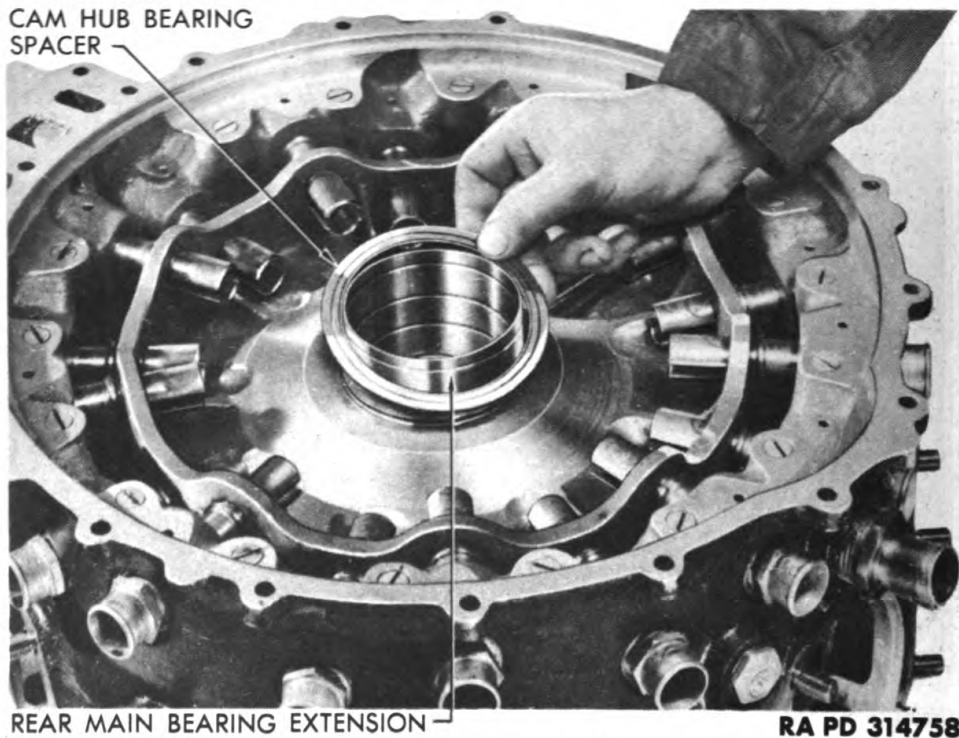

Figure 95 – Installing Cam Hub Bearing Spacer

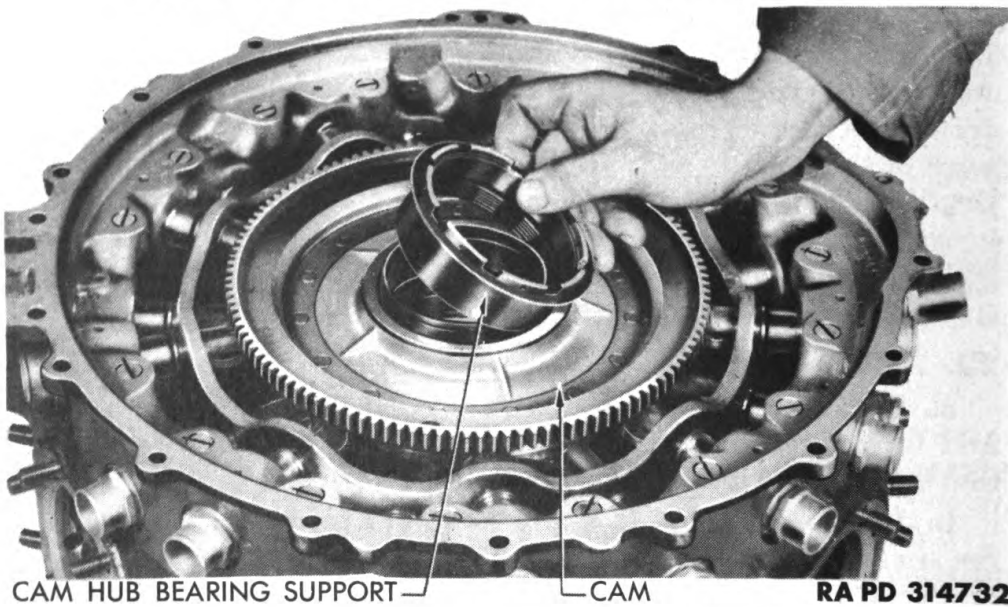

Figure 96 – Installing Cam Hub Bearing Support

when they are tapped lightly with finger, they will slide back or forth from one end of the guide to the other. If any tappet will not slide back and forth in guide, polish inside of tappet guide with crocus cloth to remove any roughness. After checking the fit of tappets, re-

**DISASSEMBLY, CLEANING, INSPECTION, REPAIR, AND
ASSEMBLY OF SUBASSEMBLIES**

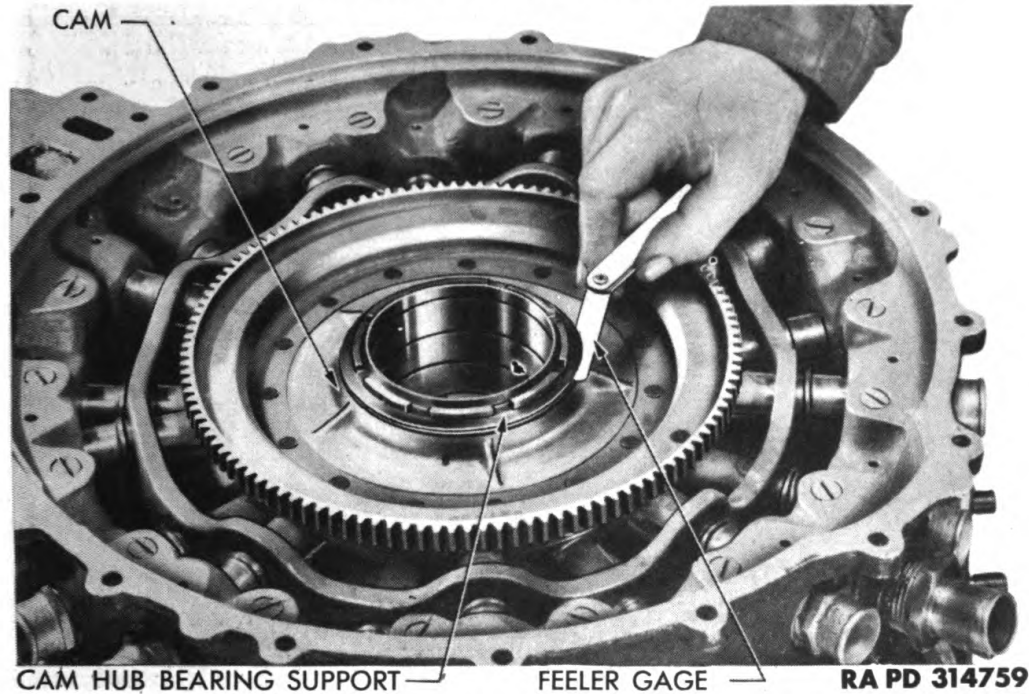

Figure 97 — Measuring End Play of Cam Using Gage 41-G-400

move them one at a time, and oil tappets and tappet guides. Reinstall each tappet in the guide in which it was fitted, and move them towards the center of the crankcase until the roller pin holes are clear of the guides. Insert rollers and push pins through rollers and tappets (fig. 75). Slide tappets outward until roller pins are supported in guides.

d. Install Cam Assembly.

(1) **INSTALL AND CHECK CLEARANCE.** Place spacer for cam hub bearing over main bearing extension (fig. 95). Place cam ring on spacer. Install cam bearing support on rear main bearing extension (fig. 96), and tighten support with wrench. Check the clearance between the cam bearing support and the upper face of the cam bearing with a feeler gage (fig. 97). Clearance should measure between 0.003 and 0.005 inch, loose fit. If clearance exceeds 0.008 inch, replace bearing.

(2) **ADJUST TAPPET ROLLERS.** Check position of cam lobes against tappet rollers. If rollers do not ride squarely on lobes, change the cam hub bearing spacer (fig. 95). If spacer is too thick, grind it to proper thickness. If spacer is too thin, replace with one of proper thickness. Spacer is of proper thickness when tappet rollers ride squarely on cam lobes.

(3) **COMPLETE INSTALLATION.** Using a $\frac{5}{64}$ -inch drill, bore two holes in rear main bearing extension to line up with holes in cam hub

ORDNANCE MAINTENANCE — ORDNANCE ENGINE
MODEL R975-C4 (CONTINENTAL)

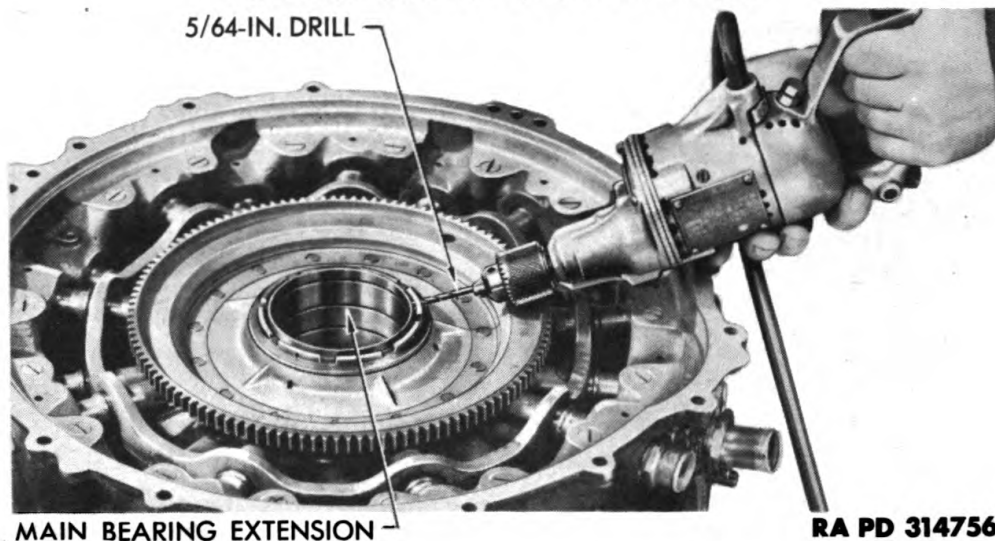

RA PD 314756

Figure 98 — Drilling Main Bearing Extension for Cotter Pins

bearing support (fig. 98). The holes should be directly opposite each other and not closer to another hole than $\frac{5}{8}$ inch. Remove cam bearing support and cam ring, and break any sharp edges from holes drilled in rear main bearing extension. Clean all drillings from crankcase, bearing support, and cam ring. Lubricate all parts with light engine oil and reinstall. Insert two cotter pins through cam hub bearing support and through bearing extension. Cut off and remove ends of cotter pins. Cotter pins must not extend through bearing support more than $\frac{1}{4}$ inch. Spread cotter pins, and bend prongs to follow radius of rear main bearing extension so that they will clear crankshaft when it is installed. Cover main crankcase assembly to protect it from dust until ready to install on diffuser and rear crankcase sections.

Section IV

CYLINDERS, VALVES, AND VALVE OPERATING MECHANISMS

| | Paragraph |
|-----------------------------|-----------|
| Disassembly | 23 |
| Cleaning | 24 |
| Inspection and repair | 25 |
| Assembly | 26 |

23. DISASSEMBLY.

a. **Remove Oil Seals.** If oil seal ring on lower side of cylinder mounting flange has not been removed, remove and discard it at this time. Remove oil seal ring from each cylinder as it is disassembled.

**DISASSEMBLY, CLEANING, INSPECTION, REPAIR, AND
ASSEMBLY OF SUBASSEMBLIES**

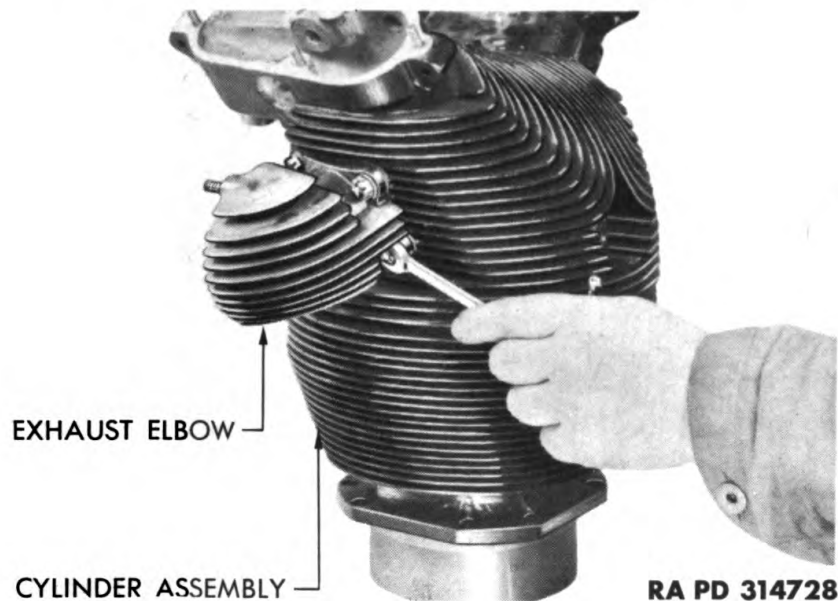

Figure 99 – Removing Exhaust Elbow

b. Remove Exhaust Elbows. Cut and remove safety wire from four nuts securing exhaust elbow to cylinder studs. Remove nuts and flat washers, and lift off exhaust elbow. Remove all exhaust elbows in same way (fig. 99).

c. Remove Valve Springs.

(1) **USING FIXTURE.** Place cylinder assembly over valve assembly stand (41-S-4988-77) (fig. 100). Lower fixture bar until valve springs are compressed. Remove split valve lock. Raise fixture bar and release compression on valve springs. Lift off valve spring outer washer and the three valve springs. Ordinarily, the inner valve spring washer remains in cylinder. Remove washer and springs for valve in all other cylinders in same way.

(2) **USING COMPRESSOR.** Place cylinder assembly over wood block. Install valve spring compressor (41-C-2559-25) on one of the rocker boxes by inserting compressor pin through rocker arm hub bolt holes (fig. 101). Pull down on compressor lever until cam action of lever holds valve springs compressed. Remove split valve lock (fig. 101). Raise up compressor lever and release valve springs. Take compressor off rocker box. Remove valve spring outer washer and the three valve springs. Remove other valve springs in same way.

d. Remove Valves. Remove and discard circket from upper end of each valve stem (fig. 102). Hold both cylinder valves so they cannot slide out through valve guides, and lift cylinder from assembly block. Lay cylinder on its side. Before withdrawing valves from valve guides, inspect each valve stem to make certain it is free from

ORDNANCE MAINTENANCE — ORDNANCE ENGINE
MODEL R975-C4 (CONTINENTAL)

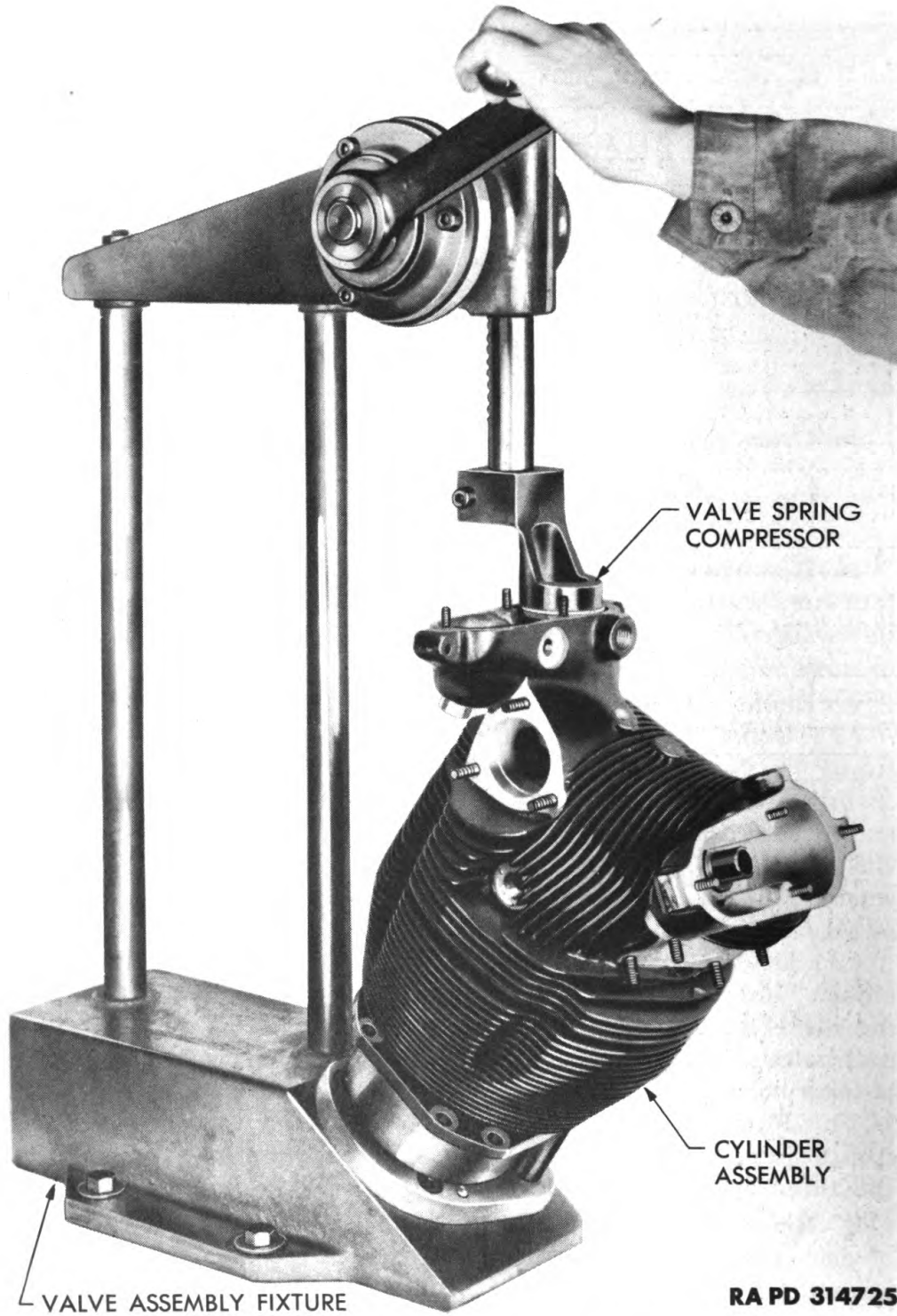

Figure 100 — Compressing Valve Spring in Valve Assembly Fixture

**DISASSEMBLY, CLEANING, INSPECTION, REPAIR, AND
ASSEMBLY OF SUBASSEMBLIES**

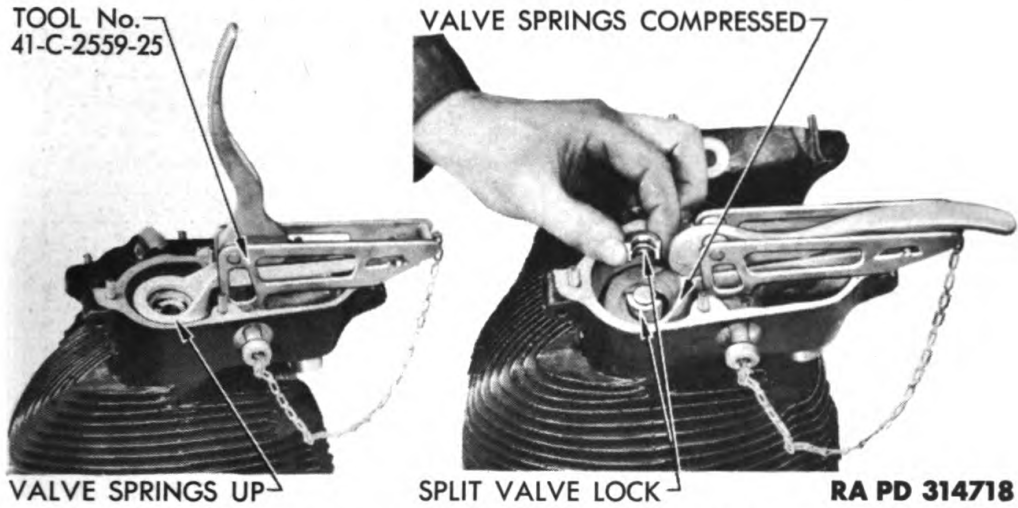

Figure 101 – Removing Valve Lock with Compressor Tool

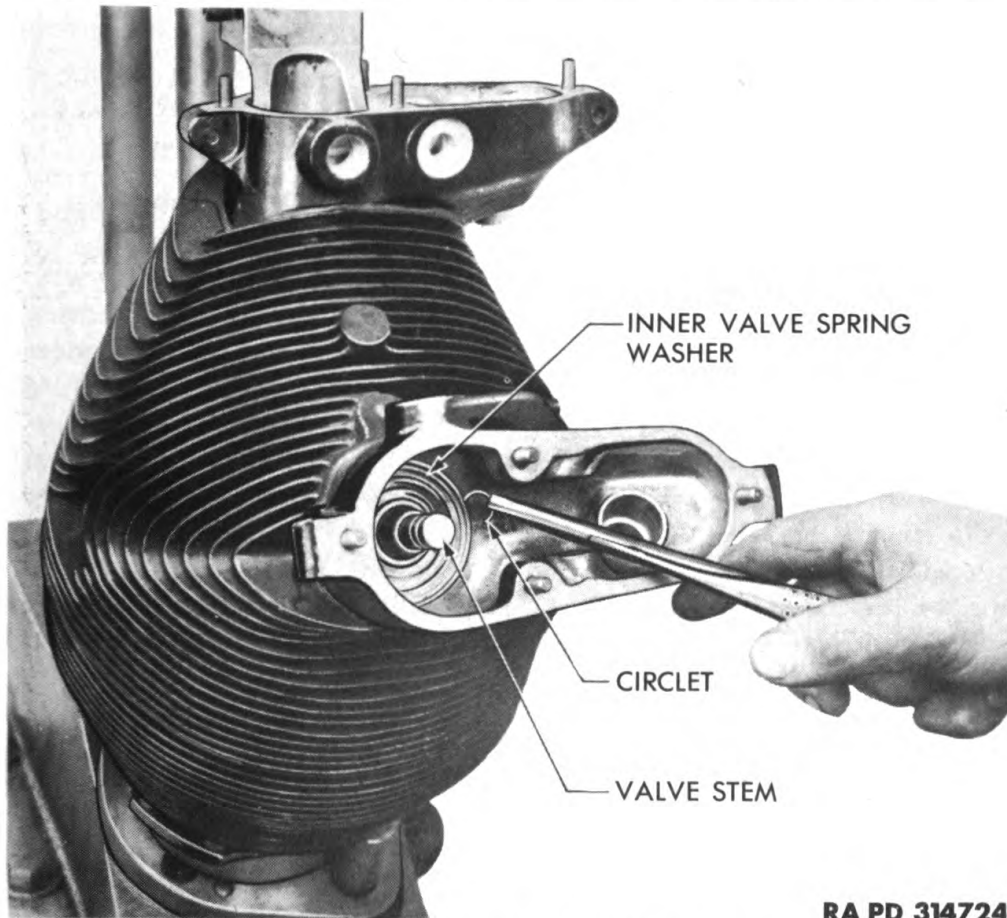

Figure 102 – Removing Ciriclet from Valve Stem

ORDNANCE MAINTENANCE — ORDNANCE ENGINE
MODEL R975-C4 (CONTINENTAL)

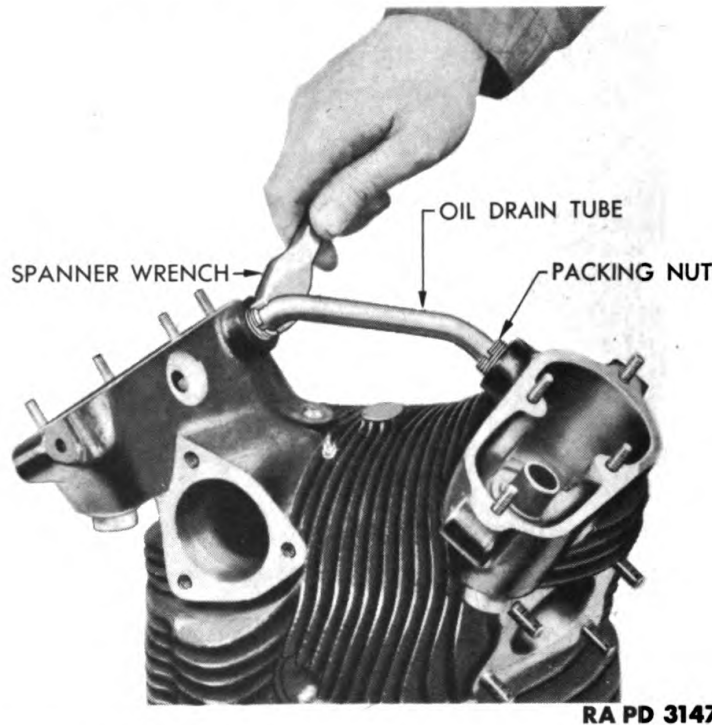

Figure 103 — Loosening Packing Nut on Drain Tube

burs, or other damage. If any valve stem is damaged, clean it up with fine stone before withdrawing the stem from valve guide. Withdraw valves from guides one at a time. Remove valves from all cylinders in same way. Tag each valve with the number of the cylinder from which it is removed.

e. Remove Oil Drain Tubes. Remove any oil drain tube between cylinder rocker boxes which shows evidence of damage or leakage at the seals. Loosen packing nuts at both ends of drain tube (fig. 103) with spanner wrench. Slide packing nuts, seals, and washers up on tube. Slide tube into one rocker box to disengage other end of tube (fig. 104). Rotate tube and pull end out of other rocker box. Clean out rubber seal or fragments of seal from recess in rocker box.

(1) **CYLINDER AND HEAD ASSEMBLY.** Do not attempt to remove cylinder head from cylinder barrel.

24. CLEANING.

a. Steam-clean each cylinder assembly to remove grease and dirt. Clean all disassembled parts in dry-cleaning solvent. Be sure to coat parts with light engine oil after drying to prevent parts from rusting. Remove carbon from interior of cylinders. Clean rocker arm bearings with dry-cleaning solvent, and dry with air hose. Coat bearings with light cylinder oil. Be sure to clean dirt from between fins of cylinder

**DISASSEMBLY, CLEANING, INSPECTION, REPAIR, AND
ASSEMBLY OF SUBASSEMBLIES**

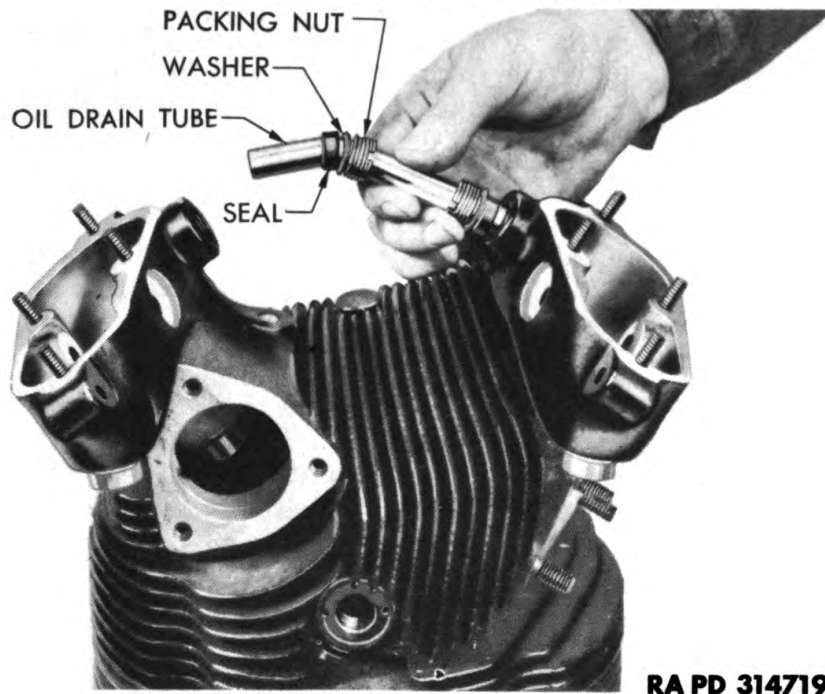

RA PD 314719

Figure 104 – Removing Rocker Box Drain Tube

heads and mufflers, and exhaust elbow fins. Polish carbon from heads of all valves and valve stems, using a wire brush.

25. INSPECTION AND REPAIR.

a. Rocker Box Assemblies.

(1) **ROCKER BOX COVERS.** Inspect rocker box covers (fig. 105) for warped parting surface, burrs, and cracks. Replace cracked rocker box covers. If parting surface of any cover is burred, clean up rough spots with fine stone, and polish with crocus cloth.

(2) **OIL DRAIN TUBES.** Inspect oil drain tubes for cracks, bends, dents, and leaks. Replace damaged tubes.

(3) **PUSH ROD HOUSING CONNECTORS.** Inspect push rod housing connectors. If any connector is bent or damaged, replace the cylinder.

(4) **ROCKER ARMS AND ROCKER ARM BEARINGS** (fig. 236). Examine rocker arms for cracks, scratches, nicks, and chafing. Check rocker arm rollers for cracks, flat spots, and fit on roller pin. If roller appears to be loose on pin, check with dial indicator. If looseness exceeds 0.0025 inch, loose fit, replace roller. Check to see that roller pin is tight in arm. Inspect rocker arm threads at the adjusting screw for burring and general condition. Inspect adjusting screws and lock nuts for cracks and thread condition. Inspect push rod ball socket in adjusting screws for wear. Replace arm assembly if rocker arm is cracked, or if rocker arm rollers are cracked, have flat spots, or are loose. If threads of adjusting screws are burred, dress threads

**ORDNANCE MAINTENANCE – ORDNANCE ENGINE
MODEL R975-C4 (CONTINENTAL)**

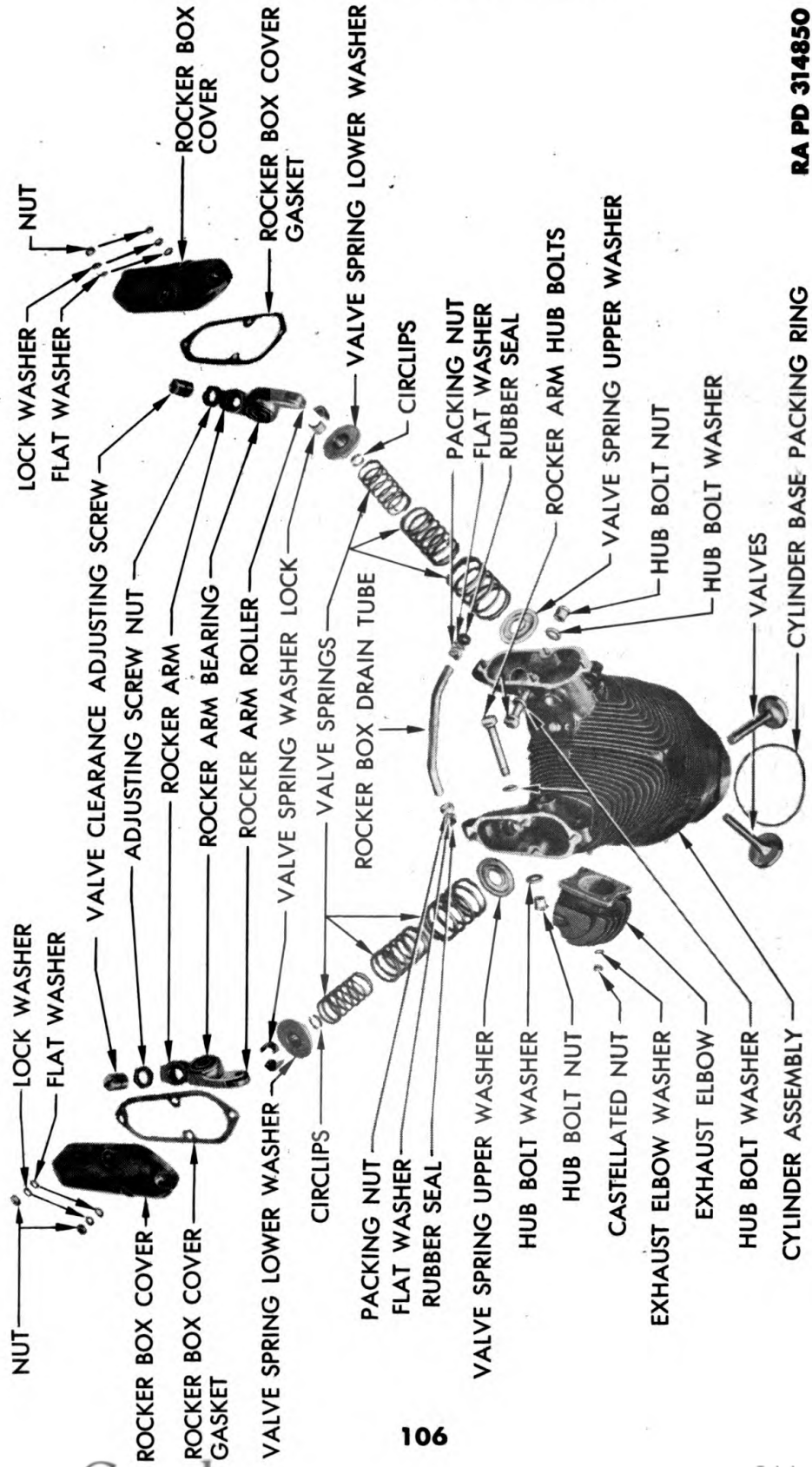

Figure 105 – Cylinder – Disassembled

Generated on 2016-07-09 10:23 GMT / <http://hdl.handle.net/2027/uc1.b3243961>
Public Domain, Google-digitized / http://www.hathitrust.org/access_use#pd-google

DISASSEMBLY, CLEANING, INSPECTION, REPAIR, AND ASSEMBLY OF SUBASSEMBLIES

with fine stone. If push rod ball socket in any adjusting screw is worn, replace adjusting screw. If push rod ball socket is burred, polish it with crocus cloth. Make sure oilhole leading from adjusting screw opening through length of rocker arm is clear. Check tightness of rocker arm bearings. Replace bearing if it is so loose it can be pushed out by hand, if it is rough, or if it has flat spots. Check for flat spots or roughness by rotating bearing slowly. To replace bearing, heat rocker arm in oil bath at 250° F., and remove bearing. Place rocker arm in arbor press, with chamfered end of bearing bore facing up. Press new bearing into bore.

(5) **ROCKER ARM HUB BOLTS.** Give rocker arm hub bolts magna-flux inspection for cracks. Replace cracked bolts. Inspect hub bolts for scores and thread condition. Check fit of bolts in rocker box and hub bearing support holes. Clean up nicks and burrs on bolts and threads with fine stone. Install new spacing washers when assembling hub bolts and rocker boxes.

b. Push Rod Assemblies (fig. 235).

(1) **PUSH RODS.** Inspect push rods for cracks and cleanliness of oilholes. Inspect ball ends for cracks, looseness in the rod, and wear. Replace cracked rods. Check rods for bends by rolling rods on surface plate. Tap slightly bent push rods with a light rawhide mallet, until they are straight, checking straightness on surface plate. Polish ball ends with crocus cloth. If ball end fits loosely in rod, replace rod assembly. Clean out oilholes. Inspect push rod springs. Replace broken springs, or springs which do not have the compression prescribed. At a length of 2.18 inches, spring pressure should be between 7.74 and 9.46 pounds.

(2) **PUSH ROD HOUSINGS.** Inspect push rod housings for dents and cracks. Replace cracked housings. Straighten slight dents in push rod housings by placing a metal rod of the proper size and shape inside housing, and hammering out dents. Do not reduce wall thickness appreciably. Replace all push rod housing hose, hose connections, and hose clamps.

c. Cylinders.

(1) **MOUNTING SURFACES.** Inspect the parting surface on each rocker box, exhaust elbow mounting pad, and fuel induction tube flange mounting for scratches, nicks, and for high spots around the rocker box and exhaust elbow studs (fig. 105). Remove nicks, burrs, or high spots with fine stone, and polish with crocus cloth.

(2) **MOUNTING STUDS.** Inspect rocker box and exhaust elbow mounting studs for straightness, tightness, evidence of stretching, and condition of threads. Replace any loose or damaged mounting stud. Follow standard procedure for replacing studs (par. 13 f).

(3) **ROCKER ARM HUB BOLT BOSSES.** Inspect rocker arm hub

**ORDNANCE MAINTENANCE – ORDNANCE ENGINE
MODEL R975-C4 (CONTINENTAL)**

bolt bosses for cracks, nicks, or burs (fig. 104). Clean up nicks or burs, with a fine stone, and polish with crocus cloth. Check inside diameter of rocker hub bolt holes for wear.

(4) **CYLINDER HEADS** (fig. 105). Inspect all cylinder heads internally and externally for cracks. Look for cracked or broken fins. If cylinder head is cracked, replace cylinder. Rework cracked or broken fins by profiling the metal to depth of crack, provided crack does not extend into cylinder head dome, and only a small amount of metal needs to be removed. Replace any cylinder in which a fin crack extends into the head dome, or in which an appreciable area of fin metal must be removed to make the repair.

(5) **VALVE GUIDES**. Inspect valve guides for tightness in cylinder head, backing out, cracks, and scoring of the inside diameter. With micrometer or special plug gage, measure inside diameter of valve guides for wear, out of round, or bellling out at the ends (fig. 106). Measure guide diameter at two locations, 90 degrees from each other, at each end of guide, to determine out of round condition. Replace guides which are damaged, worn beyond allowable limits, or are out of round. Intake guides should have an inside diameter measuring between 0.530 and 0.531 inch; exhaust guides an inside diameter measuring between 0.6235 and 0.6245 inch. To replace guide, drill guide until a shell approximately 0.015 inch thick remains. Break out shell, being careful not to damage guide retaining hole. Various sized replacement guides are provided. Select replacement guide, and ream retaining hole so that the guide will fit the hole tightly. Heat the cylinder to 300° F. Freeze the guide. Install guide in retaining hole making sure that it is properly seated. Allow cylinder to cool. Ream inside diameter of guide to fit valve stem. Clean guide bore with crocus cloth, and reseal valve seats (subpar. (6)*b*, below). *NOTE: Replacement of valve guides is normally a manufacturer's operation performed at time of cylinder barrel replacement.*

(6) **EXHAUST AND INTAKE VALVE SEAT INSERTS.**

(a) *Inspect Valve Seat Inserts.* Inspect valve seat inserts in all cylinders for pitting, burning, and to see that they are concentric with their valve guide. Reseat or replace any severely pitted or burned insert.

(b) *Reseat Valve Seat Inserts.* Place cylinder in suitable re-seating fixture. Locate grinding wheel pilot in valve guide to insure proper relation between insert and valve guide angles. Dress insert with grinding wheel very accurately to an angle of 45 degrees. After reseating insert, check concentricity of seat with a blue gage and Prussian Blue. The gage must be constructed so that it checks the angles of the valve seat insert and the valve guides.

(c) *Replace Valve Seat Inserts.* Replace any insert which cannot be resealed to fit. Replace insert by mounting cylinder in drill

**DISASSEMBLY, CLEANING, INSPECTION, REPAIR, AND
ASSEMBLY OF SUBASSEMBLIES**

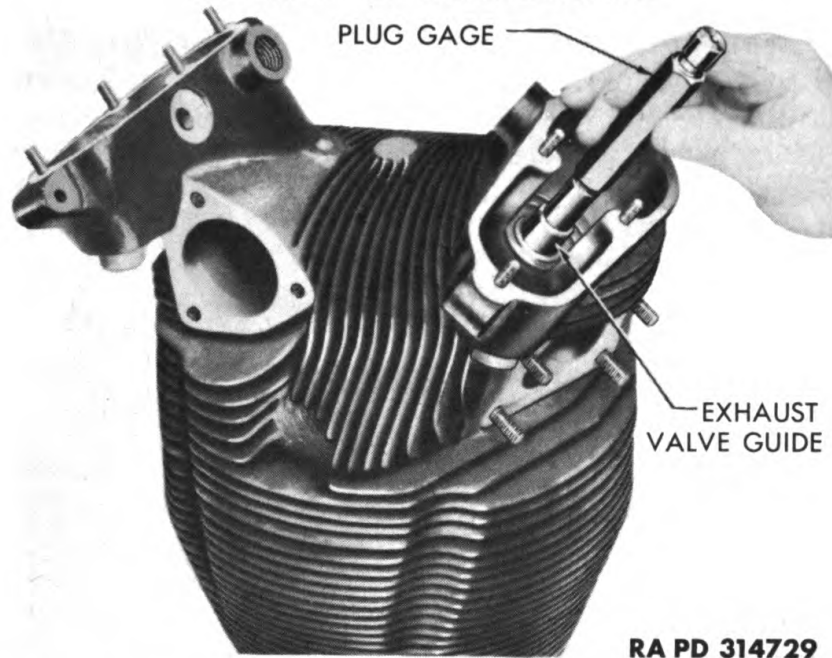

Figure 106 – Measuring Valve Guide Using Gage 41-G-254-285

press fixture. Attach it with the hold-down clamps. Position cylinder by means of cradle lock nuts, adapter clamps, and indexing pins, so that valve seat boring tool is vertical when inserted in the guide. Adjust the seat cutter so that it will remove all but a thin shell on the outer diameter of the seat. Break out the remaining shell, and clean up the seat recess. Measure the diameter of the seat recess and the outside diameter of the replacement valve seat. Refer to Table of Limits for desired shrink fit. Bore out seat recess to accommodate nearest oversize seat. Seats are furnished in four oversizes ranging from 0.010 to 0.040 inch. Place cylinder in oven, and heat it to not more than 400° F., for 1 hour. Install new valve seat on inserting tool with puller and handle, and chill seat to 20° F., for approximately 20 minutes. Remove cylinder from oven, and insert new seat. Pull seat into place with inserting tool. Do not remove tool until cylinder head has cooled sufficiently to grip seat. Remove inserting tool and allow cylinder to cool in air. Face new valve seats after installation as explained in subparagraph (b) below.

(7) VALVES.

(a) Inspect Valves. Have intake valves magnafluxed for cracks. Inspect exhaust valves for cracks, visually. Inspect valve heads and faces for pitting, scoring, burning, wear, and warpage, and valve faces for thin edges. Check valve stems for nicks, burs, and warpage. Measure diameter of each stem with micrometer to make sure that the diameter is uniform over the entire length of the stem, and that

**ORDNANCE MAINTENANCE – ORDNANCE ENGINE
MODEL R975-C4 (CONTINENTAL)**

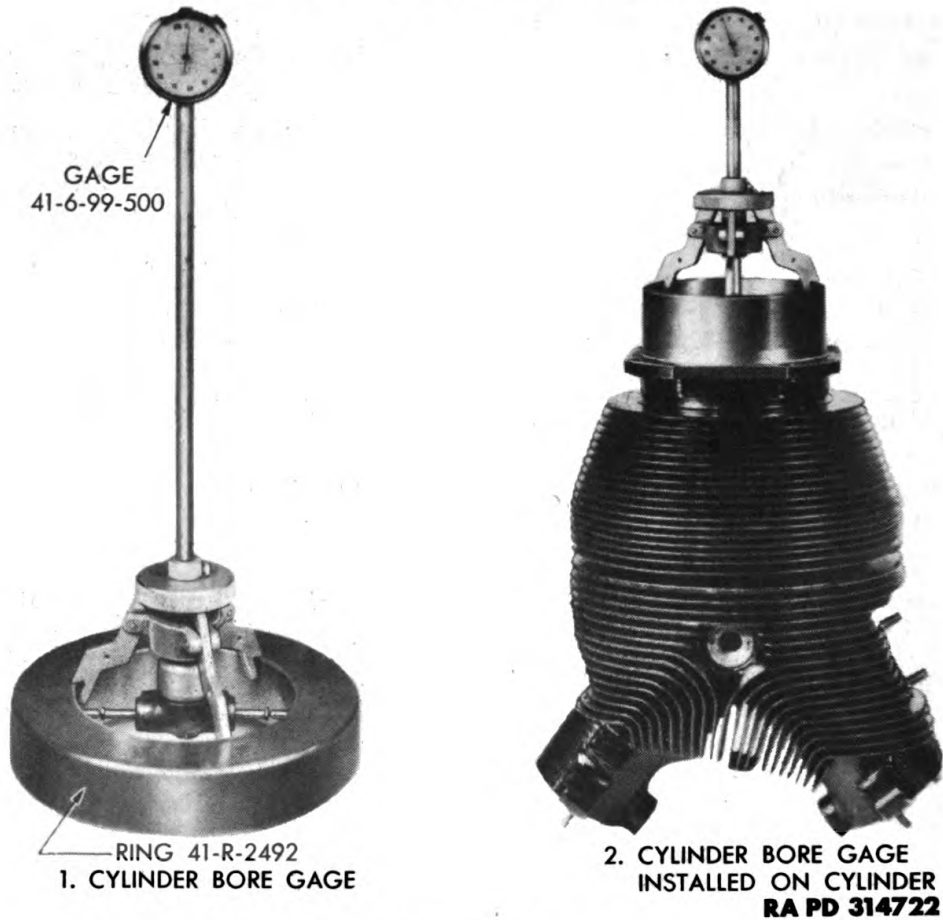

Figure 107 – Checking Cylinder Bore Diameter

it is the proper size to fit the valve guide. Intake valve stem diameters should measure between 0.5282 and 0.5287 inch; exhaust valve stems between 0.6195 and 0.6200 inch. Remove all nicks and burs from valve with a fine stone. If valve head or face is badly warped, burned, or worn too thin to reface, replace them. Bury old sodium-filled valves in the ground to avoid possible fires or injury to personnel. Never include sodium-filled valves with other parts turned in for salvage or disposal as scrap. If valve is slightly pitted, scored, or burned, reface the valve.

(b) *Reface Valves.* Place valve in refacing machine, set to grind valve face to an angle of from 44 degrees to 44 degrees 15 minutes. Grind face of valve, being sure not to remove any more metal than necessary. Reface valve very accurately. Check valve for face angle with dial indicator, or other suitable gage. When refacing the valve, if the edges of the face are ground too thin, replace the valve. **CAUTION:** Exhaust valve stems are filled with sodium which is inflammable in presence of water. Use extreme care when disposing of discarded exhaust valve.

DISASSEMBLY, CLEANING, INSPECTION, REPAIR, AND ASSEMBLY OF SUBASSEMBLIES

(8) **VALVE SPRINGS, WASHERS, AND LOCKS** (fig. 108). Inspect valve springs for cracks, scores, pitting, and breakage. Test the tension of each spring in a valve spring tension testing machine. Discard any outer spring with a tension less than 90 pounds, at a spring height of 1.34 inches; any intermediate spring with a tension less than 69 pounds, at a height of 1.40 inches; and any inner spring with a tension less than 35 pounds, at a height of 1.32 inches (Table of Limits). Give valve spring washers a magnaflux inspection for cracks. Inspect washers visually for burs and excessive wear. Inspect valve spring locks for cracks, burs, and wear. Replace unserviceable springs, washers, or locks.

(9) **CYLINDER BARRELS**. Inspect exterior of cylinder barrels for bent, scratched, or broken skirts or fins. Inspect cylinder mounting flange for cracks, nicks, and warpage. Replace any cylinder with a bent or cracked skirt, or with barrel fins broken at the root of the fin. Replace any cylinder with a cracked or warped flange.

(10) **CYLINDER BORES**. Inspect the inside diameter of the cylinder barrel in all cylinders for corrosion, scores, ring wear, and out-of-round condition. Measure cylinder bore diameter with cylinder bore gage (41-G-99-500) and ring (41-R-2492) (fig. 107). Cylinder barrels are of the choke type and are approximately 0.009 inch smaller at the top than at the bottom, to compensate for the increased expansion of the upper part of the bore at operating temperatures. For this reason, measure the bore at room temperature (70° F.) parallel to the piston pin, and 90 degrees to the piston pin $8\frac{1}{2}$, $8\frac{1}{4}$, 8, $7\frac{3}{4}$, $7\frac{1}{4}$, $6\frac{3}{4}$, $5\frac{3}{4}$, $5\frac{1}{4}$, $4\frac{3}{4}$, $4\frac{1}{4}$, $3\frac{3}{4}$, $3\frac{1}{4}$, $2\frac{3}{4}$, $2\frac{1}{4}$, $1\frac{3}{4}$, $1\frac{1}{4}$, and $\frac{3}{4}$ inches from the bottom of the cylinder. The difference between the reading for the $8\frac{1}{2}$ inch measurement and the $\frac{3}{4}$ inch measurement gives the choke. Measure the choke for each cylinder. If cylinder choke is less than 0.004 inch, but is worn irregularly, hone bore until irregularities have been cleaned up. If choke is worn beyond the allowable limits and cannot be cleaned up to within the allowable limits, replace cylinder.

(11) **EXHAUST ELBOWS**. Examine exhaust elbows for cracks, erosion, and condition of fins (fig. 99). Replace damaged elbows. Inspect parting surfaces for nicks, burs, and warpage. Remove nicks and burs from parting surfaces with fine stone and polish with crocus cloth. Replace elbow if parting surface is warped.

(12) **SPARK PLUG INSERTS**. Check spark plug inserts for tightness and condition of threads. If any spark plug insert is cracked, damaged, or loose, do not attempt to replace it, but replace cylinder. Replacing spark plug inserts is a difficult, complicated procedure and should not be attempted.

(13) **SUMP AND SUMP DRAIN TUBES** (fig. 242). Inspect oil sump assembly, particularly at mounting flange locations. Check sump

**ORDNANCE MAINTENANCE — ORDNANCE ENGINE
MODEL R975-C4 (CONTINENTAL)**

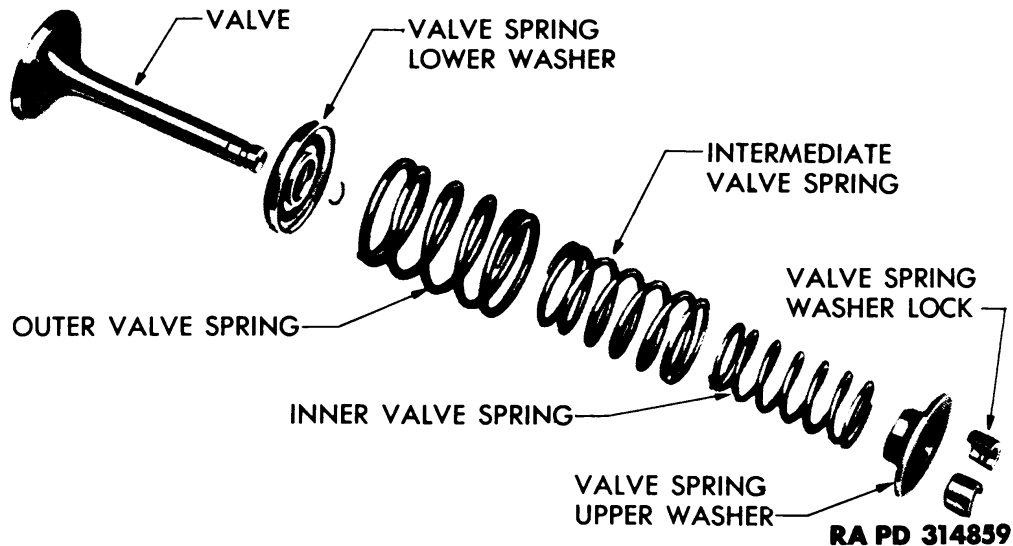

Figure 108 — Valve Assembly — Disassembled

tanks with pressure, if possible, for leaks, dents, and other damage. Inspect connecting tubes for leaks, dents, and damage. Replace damaged tanks or tubes. Replace all attaching hose and hose clamps.

(14) **FUEL INDUCTION TUBES.** Inspect induction tubes for cracks, bends, dents, and leakage holes along the welded seam (fig. 14). Plug one end of tubes and apply air pressure to the other end. Check the welded seam. Straighten tubes that are not badly bent, or dented. Replace tubes that are cracked, badly dented, or which leak. Inspect flame arrestor for condition. Blow compressed air through the length of the tube to clean out any foreign matter lodged in the flame arrestor. Examine mounting flanges for cracks, warpage, and condition of finished surfaces. Replace tubes which have badly warped, cracked, or scratched flanges. Check condition of cap screw mounting holes. Remove slight nicks and burrs from machined surfaces with a fine stone. Remove and discard old rubber seal from end of induction tube. Remove gland nut and inspect it for condition of threads, and for bent or mutilated conditions. If nut is damaged, install new nut. Install new rubber seal on end of tube at this time.

(15) **PRIMER SYSTEM** (fig. 244). Disconnect primer connecting lines from distributor. Blow compressed air through lines to make sure they are clear, and that there are no sharp bends to obstruct openings. Check each line for leaks and loose fittings. Blow compressed air through distributor to make sure openings are clear. Inspect primer elbows which attach to each cylinder head. Blow compressed air through fittings to make sure passages are clear. Put gasket sealing compound on primer elbow threads and reinstall elbows in cylinder heads. Replace lines on distributor.

**DISASSEMBLY, CLEANING, INSPECTION, REPAIR, AND
ASSEMBLY OF SUBASSEMBLIES**

26. ASSEMBLY.

a. Install Oil Drain Tubes. Install each oil drain tube removed. Place new rubber seal, washer, and packing nut on each end of tube (fig. 104). Insert one end of tube in rocker box. Rotate tube to line up other end with opening in other rocker box. Center tube between rocker boxes. Push seals and washers into place and start packing nuts carefully by hand (fig. 103). Be very careful not to cross the threads. Tighten nuts (fig. 103) with spanner wrench.

b. Install Valves. Apply engine oil liberally to valve stems (fig. 108). Insert intake and exhaust valves in position in their respective guides. While holding valves, place cylinder assembly on valve assembly fixture or block. Make sure lower valve spring retaining washer is in place in cylinder head. Install circket on upper end of both valve stems. Position three valve springs around each stem with upper ends in retaining washer. Compress valve springs (par. 23 c). Insert split valve locks. Release spring compressor carefully. Install remainder of valves in same way.

c. Install Exhaust Elbows. Position elbow on cylinder mounting flange studs, and install four washers and nuts. Tighten nuts securely, and secure with lock wire (fig. 99). Secure the two top nuts together and the two bottom nuts together. Install exhaust elbows on remaining cylinders. Place each cylinder assembly on clean bench, and cover to protect it from dust until installed in engine.

Section V

PISTONS

| | Paragraph |
|-----------------------------|-----------|
| Disassembly | 27 |
| Cleaning | 28 |
| Inspection and repair | 29 |
| Assembly | 30 |

27. DISASSEMBLY.

a. Remove Piston Rings. Using piston ring tool, remove five piston rings from each piston (fig. 114). Unless rings are in unusually good condition, replace them after piston inspection. As the piston pin and articulated rod for each piston assembly was removed during engine disassembly, all parts are now disassembled.

28. CLEANING.

a. Scrape carbon accumulations from piston heads, being careful not to scratch piston. Polish piston skirt with crocus cloth to remove

**ORDNANCE MAINTENANCE – ORDNANCE ENGINE
MODEL R975-C4 (CONTINENTAL)**

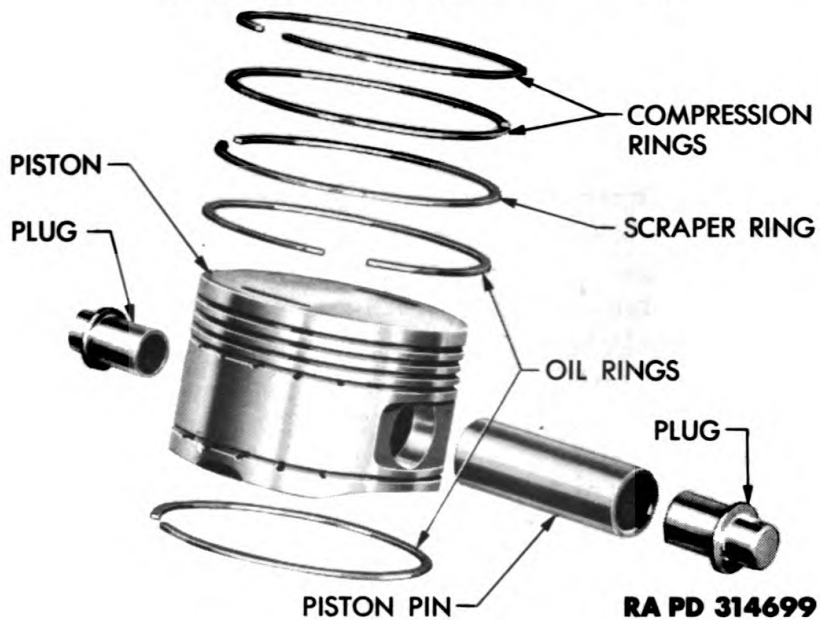
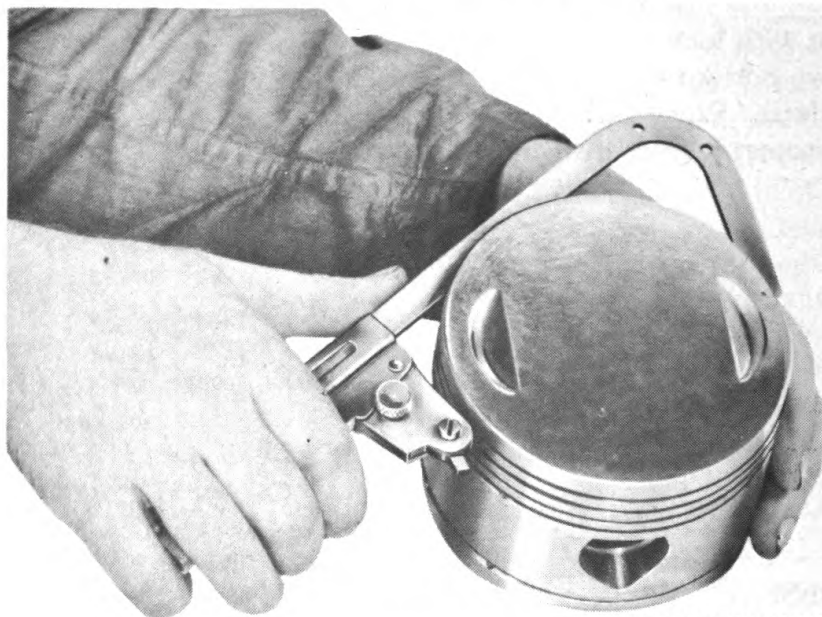

Figure 109 – Piston Assembly – Disassembled



**Figure 110 – Cleaning Piston Ring Grooves with Ring Groove
Cleaner 41-C-2155**

carbon and rough spots. Clean piston ring grooves with ring groove cleaner (fig. 110), or fold piece of crocus cloth over double, then fold again. Insert folded edge of crocus cloth in grooves, and run cloth around grooves to polish carbon from them. Keep cloth wet. Remove carbon from oilholes in ring grooves. Clean out inside of pis-

**DISASSEMBLY, CLEANING, INSPECTION, REPAIR, AND
ASSEMBLY OF SUBASSEMBLIES**

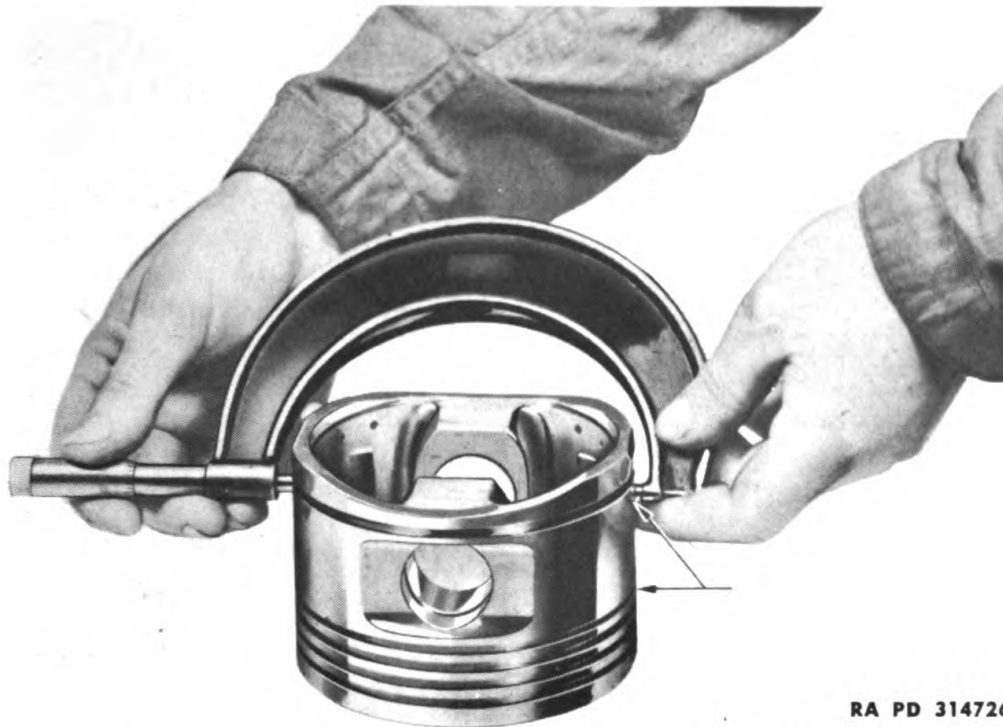

RA PD 314726

Figure 111 – Measuring Piston Diameter Using Caliper 41-C-307



RA PD 314867

**Figure 112 – Measuring Piston Ring Side Clearance Using
Gage 41-G-400**

**ORDNANCE MAINTENANCE – ORDNANCE ENGINE
MODEL R975-C4 (CONTINENTAL)**



**Figure 113 – Measuring Piston Ring Gap Using Gage 41-G-400
and Ring 41-R-2492**

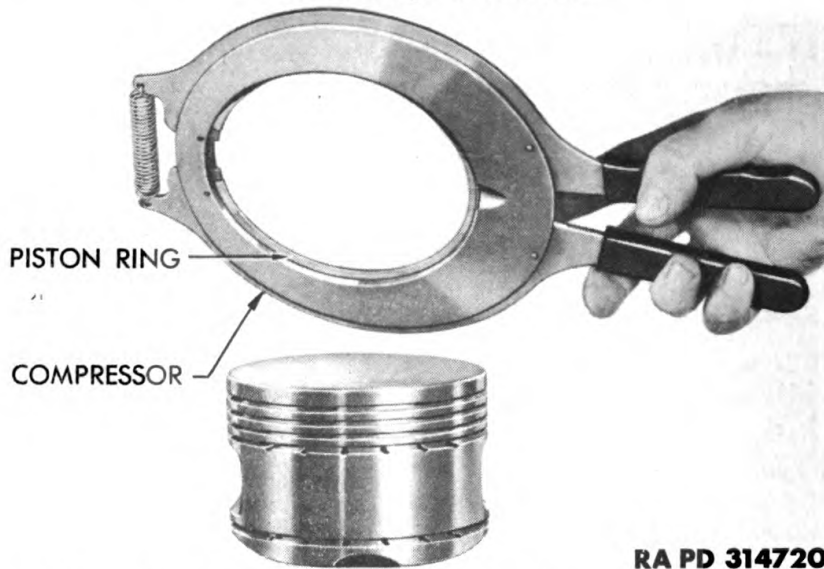

Figure 114 – Installing Piston Rings Using Applier 41-A-329-500

tons. Clean all other parts of assembly with dry-cleaning solvent, and dry with air hose. Coat parts with lubricating oil.

29. INSPECTION AND REPAIR.

a. Pistons. Insert pistons for scores, cracks, and erosion. Replace heavily scored, cracked, or eroded pistons. Clean up light scores with fine stone and polish piston surfaces with crocus cloth and kero-

**DISASSEMBLY, CLEANING, INSPECTION, REPAIR, AND
ASSEMBLY OF SUBASSEMBLIES**

sene. Measure piston diameters 90 degrees from piston pin holes at top and bottom of skirt and at top ring gland (fig. 111). Replace piston if worn beyond allowable limits. The diameter of the piston at the skirt should measure between 4.974 and 4.976 inches; and between 4.966 and 4.968 inches at the top ring gland.

Check piston ring grooves with new piston rings, and measure side clearance with feeler gage (fig. 112). Replace piston if side clearance exceeds allowable clearance for any ring groove. Side clearance for the No. 1 (top) ring should measure between 0.005 and 0.007 inch, loose fit; for the No. 2 ring, between 0.004 and 0.0055 inch, loose fit; and for the Nos. 3, 4, and 5 rings between 0.0025 and 0.004 inch, loose fit. Clean piston pin holes with crocus cloth. Inspect condition of piston pin plugs, and replace worn plugs.

b. Piston Pins. Inspect piston pins for cracks, scores, straightness, and flat spots. Replace cracked, bent, or badly scored pins. Clean up slightly scored pins with fine stone. Measure diameter of pin with micrometer. Replace pin if diameter is less than prescribed limit. Piston pin diameters should measure between 1.2475 and 1.2480 inches.

c. Piston Rings. When piston has been removed, always install new rings. Before installing rings in pistons, check ring fit in ring gage, and measure gap with 5-inch feeler gage (fig. 113). Gap should measure between 0.025 and 0.031 inch.

30. ASSEMBLY.

a. Install Piston Rings. Using piston ring compressor, install piston rings. The top ring is marked "CHROME." The two tapered compression rings are marked "TOP 2 AND 3." The two oil control rings are marked "UP-Z," and these two rings are interchangeable. Install each ring in proper piston ring groove with the surface marked "TOP" or "UP" towards piston head. After rings are installed in each piston, check side clearance in groove. Place pistons on clean bench in proper numerical order. The number of the cylinder in which the piston is to be installed is stamped on the bottom of each piston. The engine number is stamped at the top of each piston.

Section VI

CRANKSHAFT AND MASTER ROD

| | Paragraph |
|-----------------------------|------------------|
| Disassembly | 31 |
| Cleaning | 32 |
| Inspection and repair | 33 |
| Assembly | 34 |

ORDNANCE MAINTENANCE – ORDNANCE ENGINE
MODEL R975-C4 (CONTINENTAL)

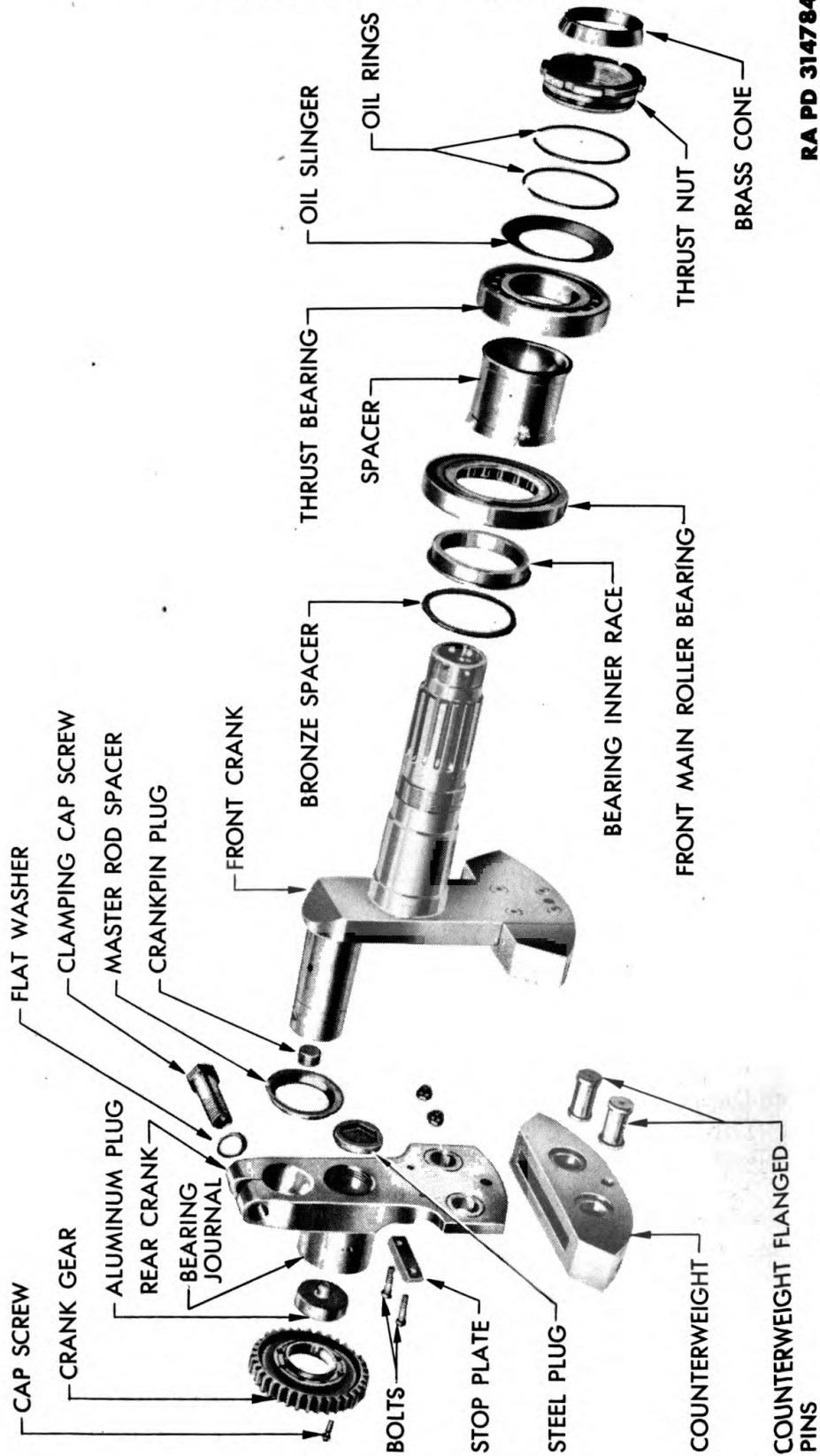

RA PD 314784

Figure 115 – Crankshaft Assembly – Disassembled

**DISASSEMBLY, CLEANING, INSPECTION, REPAIR, AND
ASSEMBLY OF SUBASSEMBLIES**

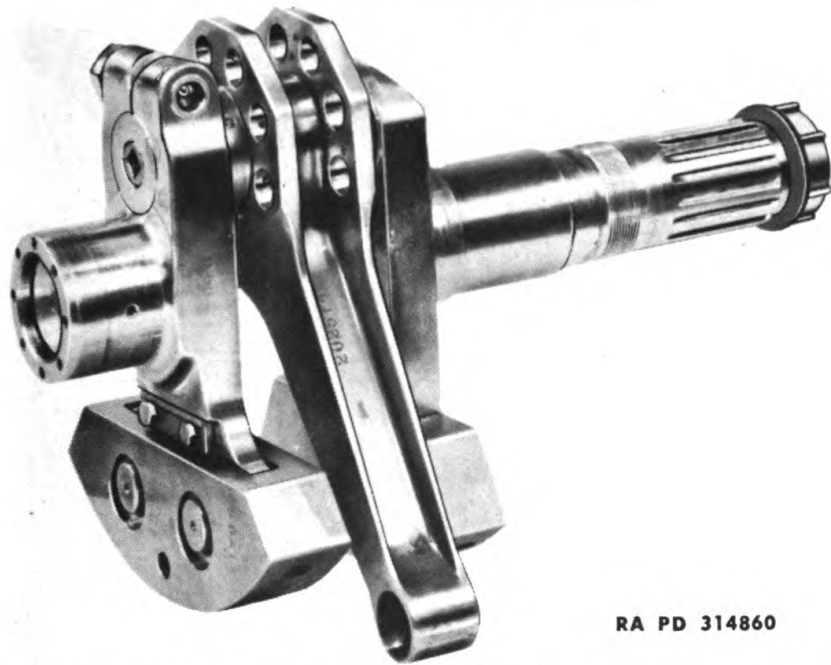

RA PD 314860

Figure 116 – Crankshaft and Master Rod Assembly

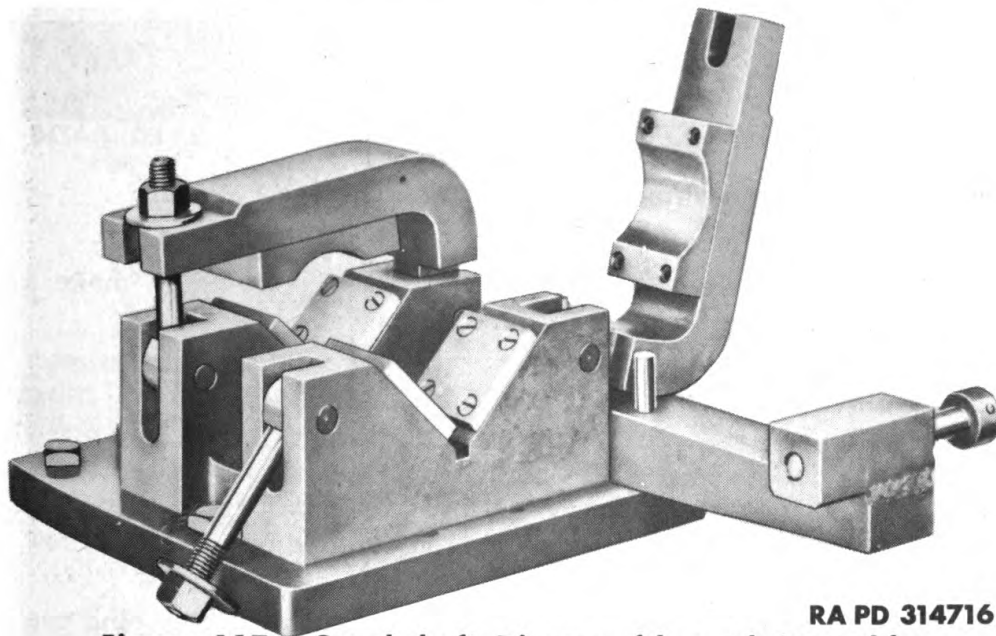

RA PD 314716

**Figure 117 – Crankshaft Disassembly and Assembly
Fixture 41-S-4932**

31. DISASSEMBLY.

a. **Measure Bearing Journal.** Before disassembling crankshaft and master rod assembly, measure diameter of rear main bearing journal with micrometer. Take measurement at this time to insure

ORDNANCE MAINTENANCE – ORDNANCE ENGINE
MODEL R975-C4 (CONTINENTAL)

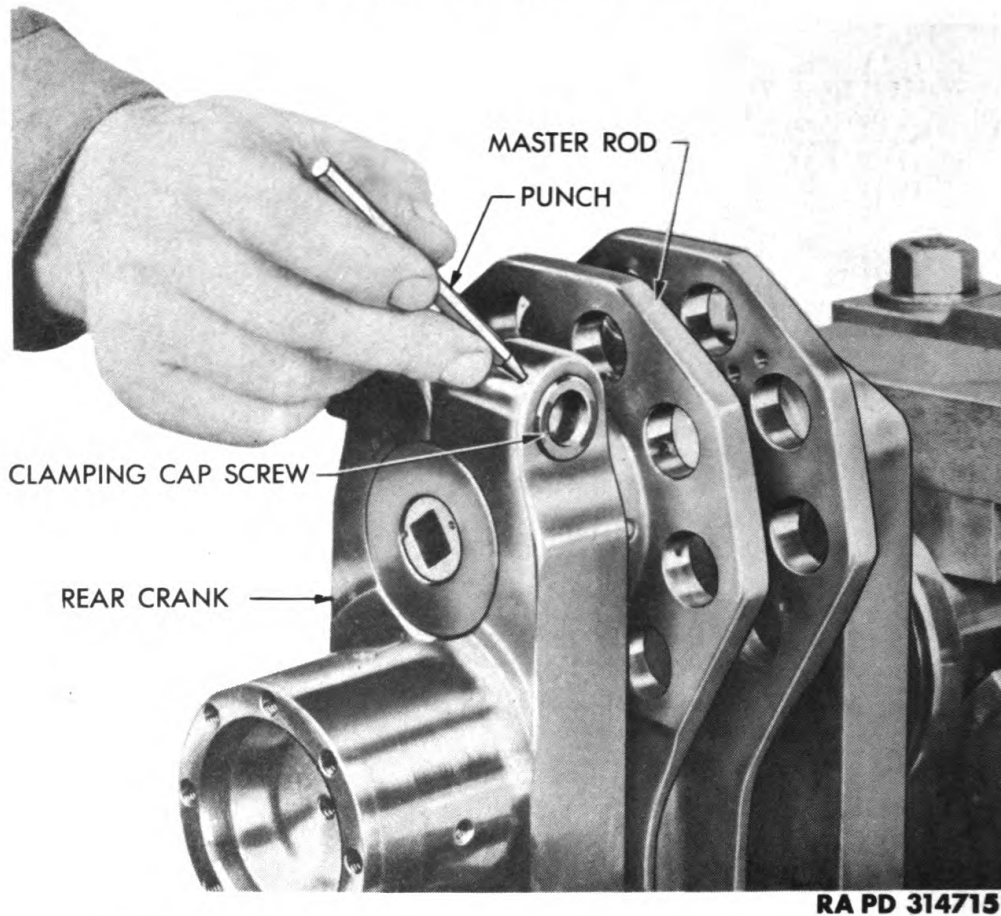

RA PD 314715

Figure 118 – Checking Cap Screw Cotter Pin Hole

correct readings. Measure the journal at four points, and make a note of diameter size, and out-of-round condition.

b. Remove Clamping Cap Screw. Clamp crankshaft and master rod assembly into crankshaft assembly and disassembly stand (41-S-4932) (fig. 117). Remove cotter pin from clamping cap screw at rear of assembly. Insert pin punch into cotter pin hole to make certain that all of cotter pin was removed, and that hole is entirely clear (fig. 118). Using a wrench, remove clamping cap screw (fig. 119). Lift off washers.

c. Remove Rear Crank. Install spreader through clamping cap screw holes and spread rear crank (fig. 120). Slide rear crank assembly off crankpin. Remove spreader, and reinstall cap screw loosely so as not to damage threads.

d. Remove Master Rod. Inspect surface of crankpin to make sure that there are no nicks, burs, or any foreign matter on the surface, so as not to damage the master rod bearing when removing the

**DISASSEMBLY, CLEANING, INSPECTION, REPAIR, AND
ASSEMBLY OF SUBASSEMBLIES**

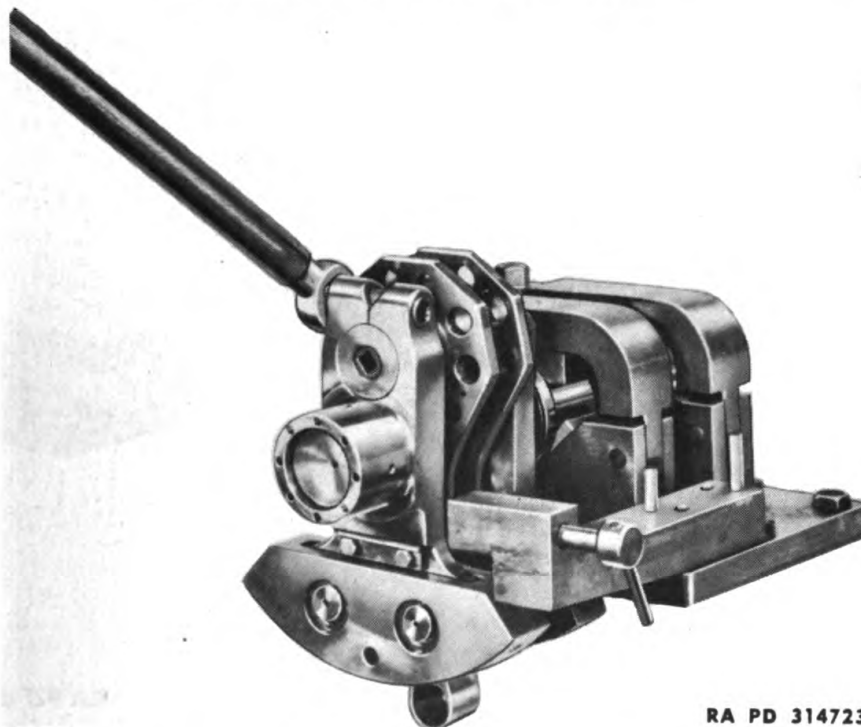

RA PD 314723

Figure 119 – Removing Clamping Cap Screw

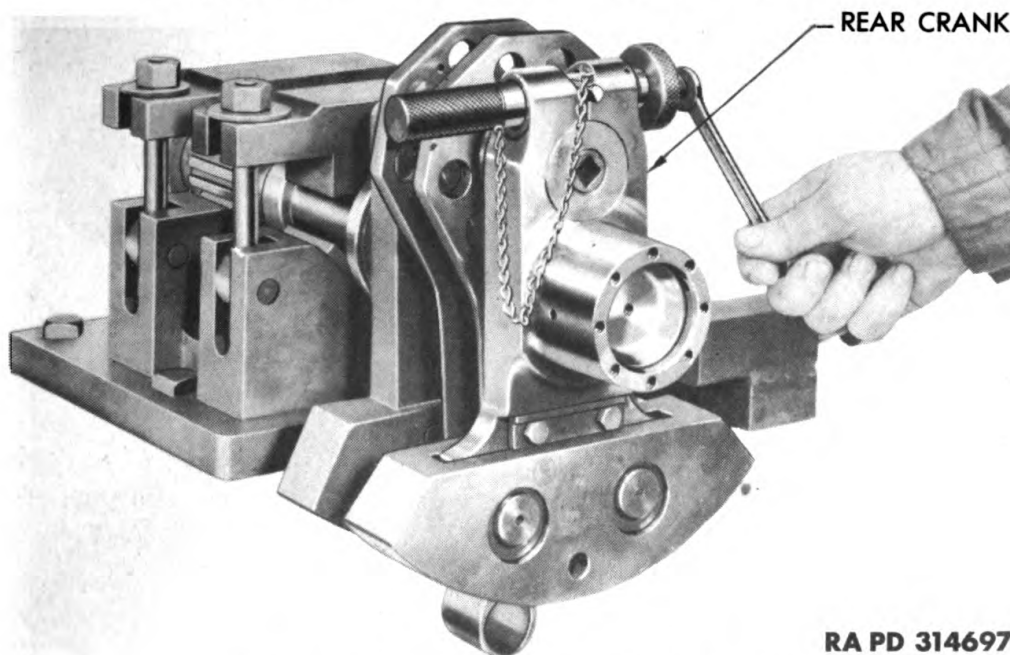

RA PD 314697

Figure 120 – Spreading Rear Crank

**ORDNANCE MAINTENANCE – ORDNANCE ENGINE
MODEL R975-C4 (CONTINENTAL)**

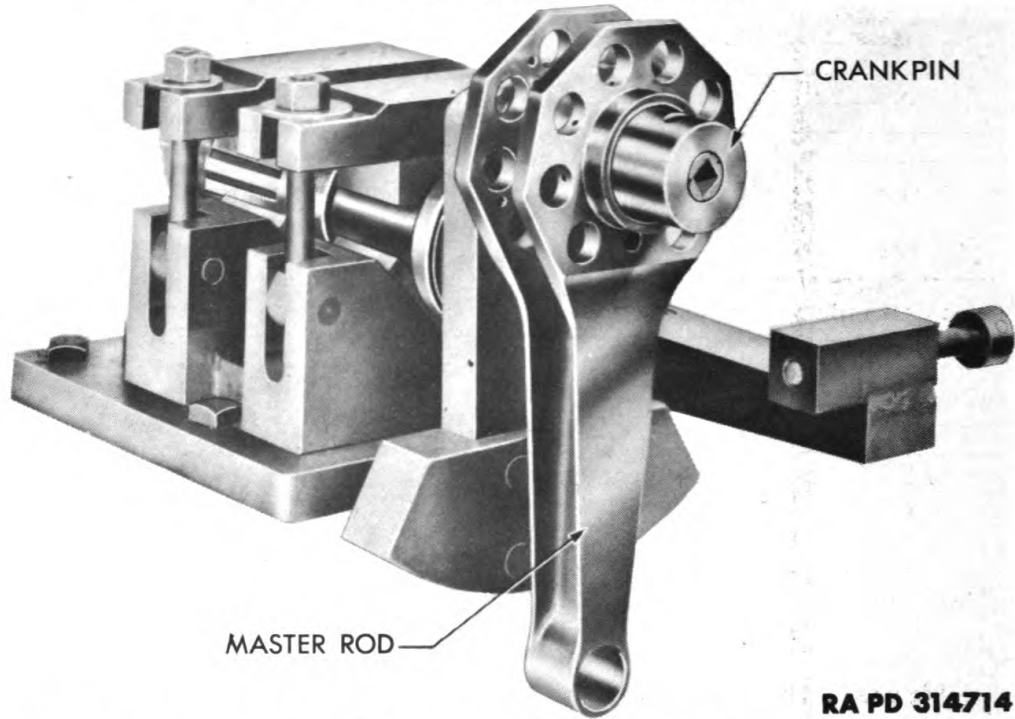

RA PD 314714

Figure 121 – Master Rod Ready for Removal from Crankshaft

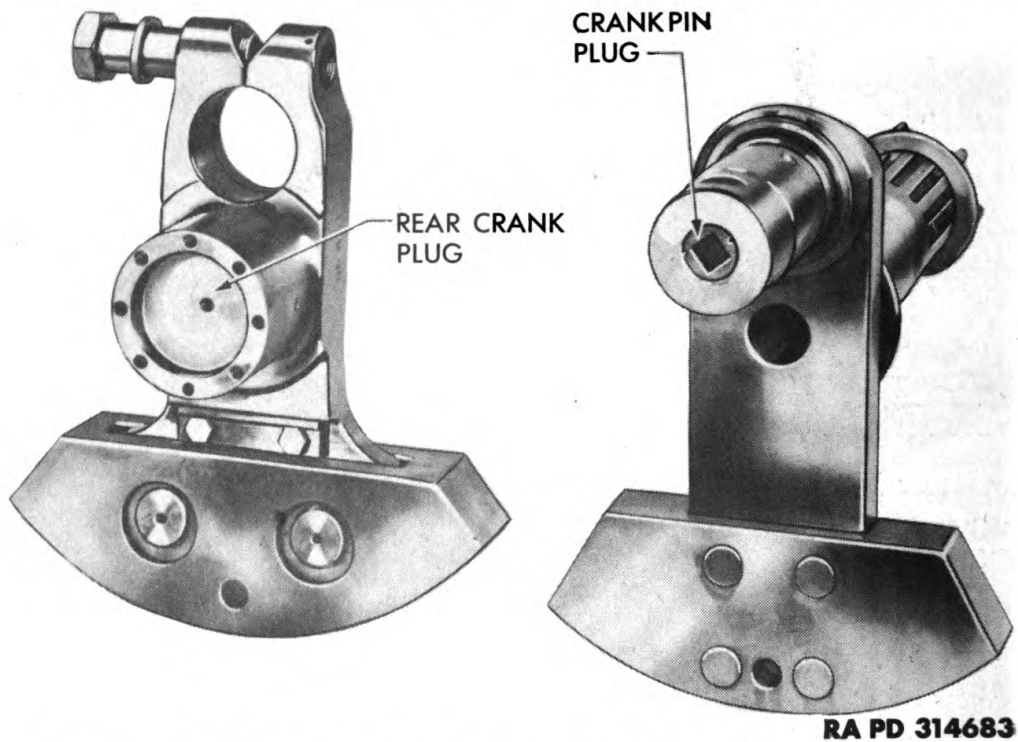

RA PD 314683

Figure 122 – Front and Rear Crank Sections, Showing Plugs

**DISASSEMBLY, CLEANING, INSPECTION, REPAIR, AND
ASSEMBLY OF SUBASSEMBLIES**

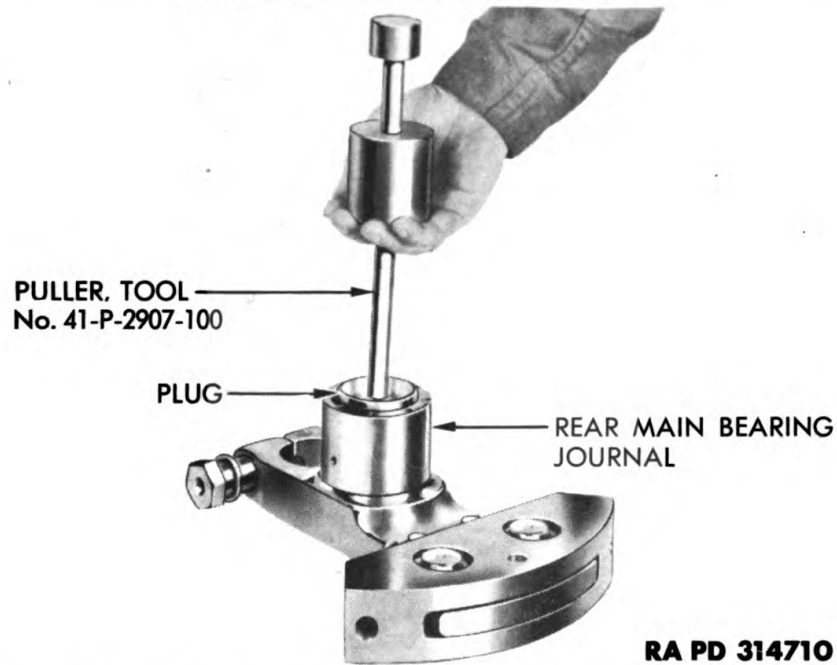

Figure 123 – Removing Rear Main Bearing Journal Plug

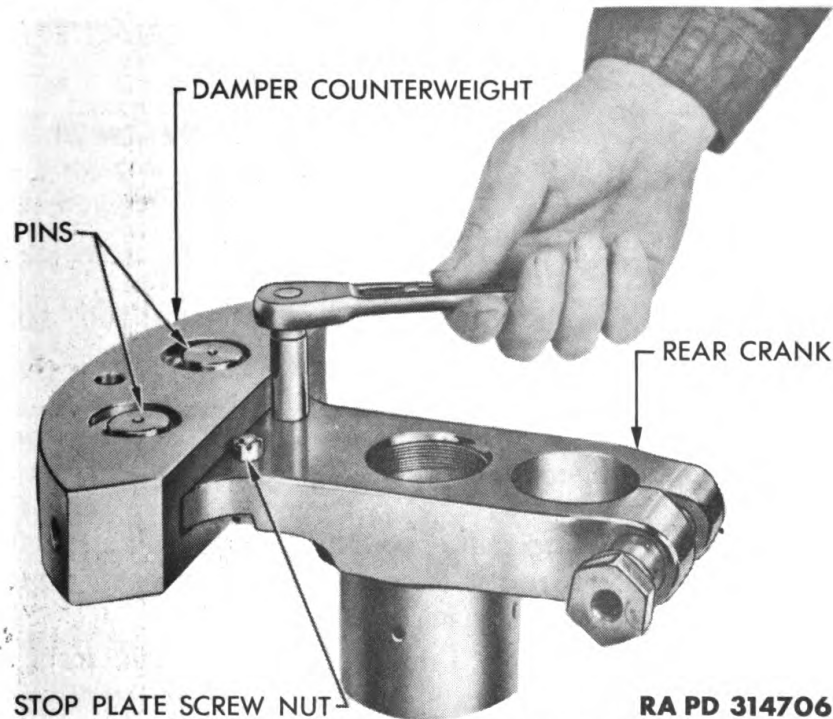

Figure 124 – Loosening Nuts Securing Rear Crank Stop Plate Bolts

rod (fig. 121). Clean off the crankpin, and if necessary, smooth up nicks and burs with fine stone. Slide the master rod off the crankpin.

e. Remove Master Rod Spacer. Pour oil heated to 400°F., over

**ORDNANCE MAINTENANCE — ORDNANCE ENGINE
MODEL R975-C4 (CONTINENTAL)**

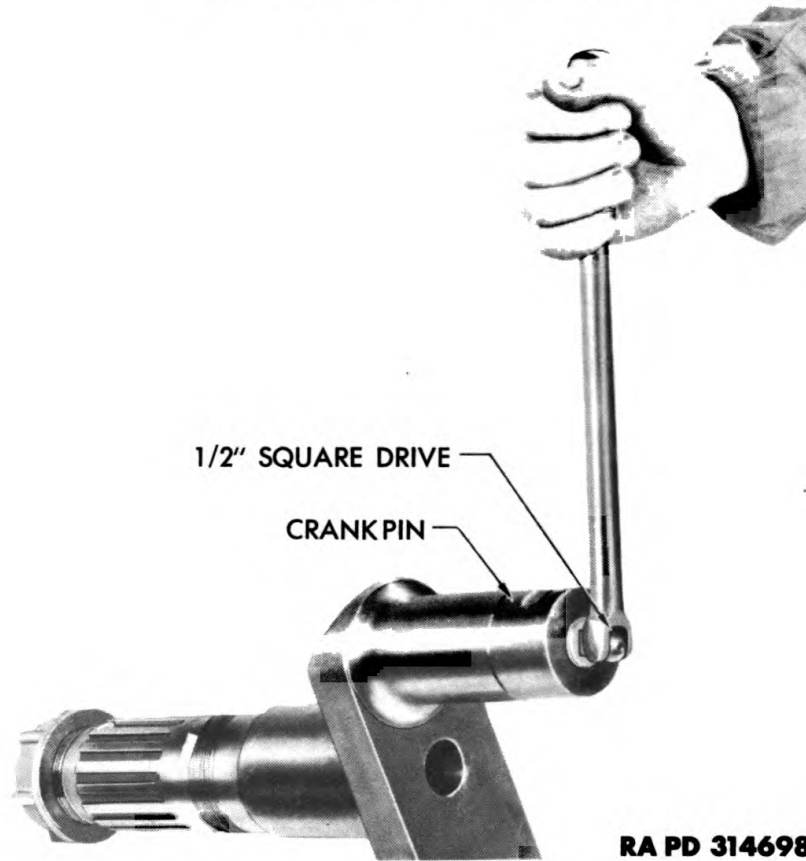

Figure 125 — Removing Crankpin Plug

master rod spacer on crankpin, and remove spacer (fig. 115).

f. Remove Rear Crank Plug. Using puller (41-P-2907-100), remove plug from rear main bearing journal in rear crank (figs. 122 and 123) and unscrew front plug in rear crank (fig. 115).

g. Remove Dynamic Damper. Remove cotter pins from two nuts and bolts holding damper counterweight stop plate to rear crank. Loosen and remove nuts (fig. 124). Turn crank over and lift out stop plate. Slide damper counterweight up on crank until flanged pins are opposite wider openings in crank. Push out flanged pins and remove damper counterweight from crank.

h. Install Crankshaft Front End in Vise. Remove front crank from assembly and disassembly stand. Place front crank counterweight in vise covered with soft brass jaws.

i. Remove Front Main Bearing Inner Race and Spacer. Remove thread protector from front end of front crankshaft section. Remove front main bearing inner race from crankshaft. Slip loose-fitted bronze spacer from crankshaft.

**DISASSEMBLY, CLEANING, INSPECTION, REPAIR, AND
ASSEMBLY OF SUBASSEMBLIES**

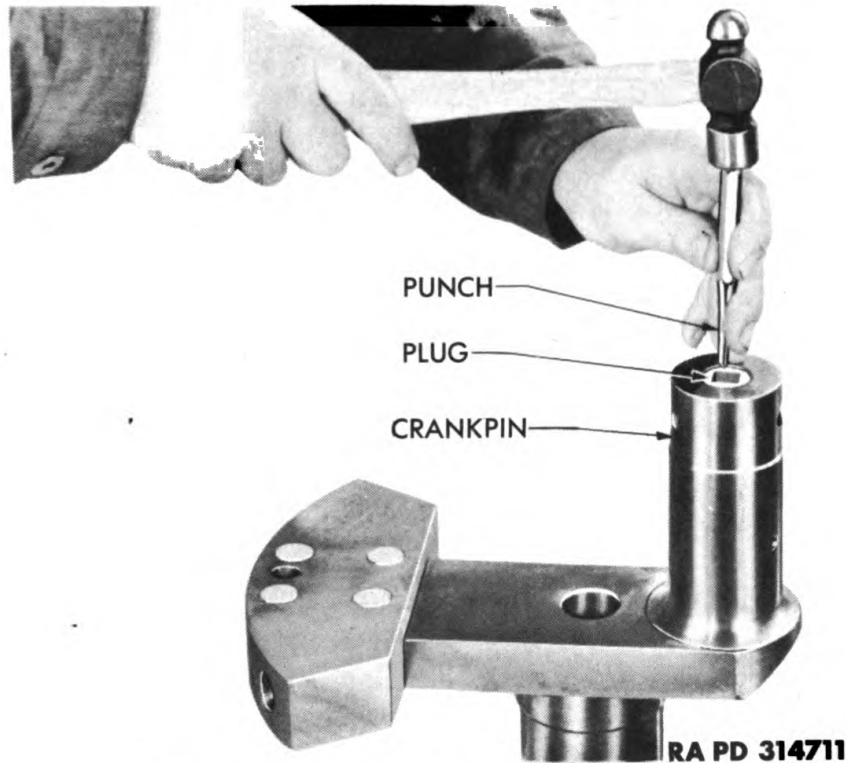

Figure 126 – Staking Crankpin Plug

j. Remove Crankpin Plug from Crankpin. Using square wrench, remove plug from rear of crankpin (fig. 125). Crankshaft disassembly is now completed.

32. CLEANING.

a. Clean crankshaft front section carefully, and clean oil sludge and residue from plug bore. Clean drilled oil passage in crankpin thoroughly. Clean out bearing lubricating hole in front end of crankshaft, using a stiff wire. Clean rear crank, and clear out oil passage in rear main bearing journal. Clean four oilholes to rear main bearing, and oilhole to crankpin. Cover master rod bearing with protector, and clean master rod with dry-cleaning solvent. As each part is cleaned, coat it with a light film of lubricating oil and place it on inspection bench.

33. INSPECTION AND REPAIR.

a. Crankshaft Front End. Have crankshaft sections magnafluxed. Inspect front section shaft threads and splines for nicks and wear. Inspect crankshaft for cracks, nicks, scores, and galling. Inspect thrust and front main bearing locations for galling. Note the condition of the front crankcheek and extension. Check the front counterweight for condition and tightness of rivets. Inspect crank-

**ORDNANCE MAINTENANCE — ORDNANCE ENGINE
MODEL R975-C4 (CONTINENTAL)**

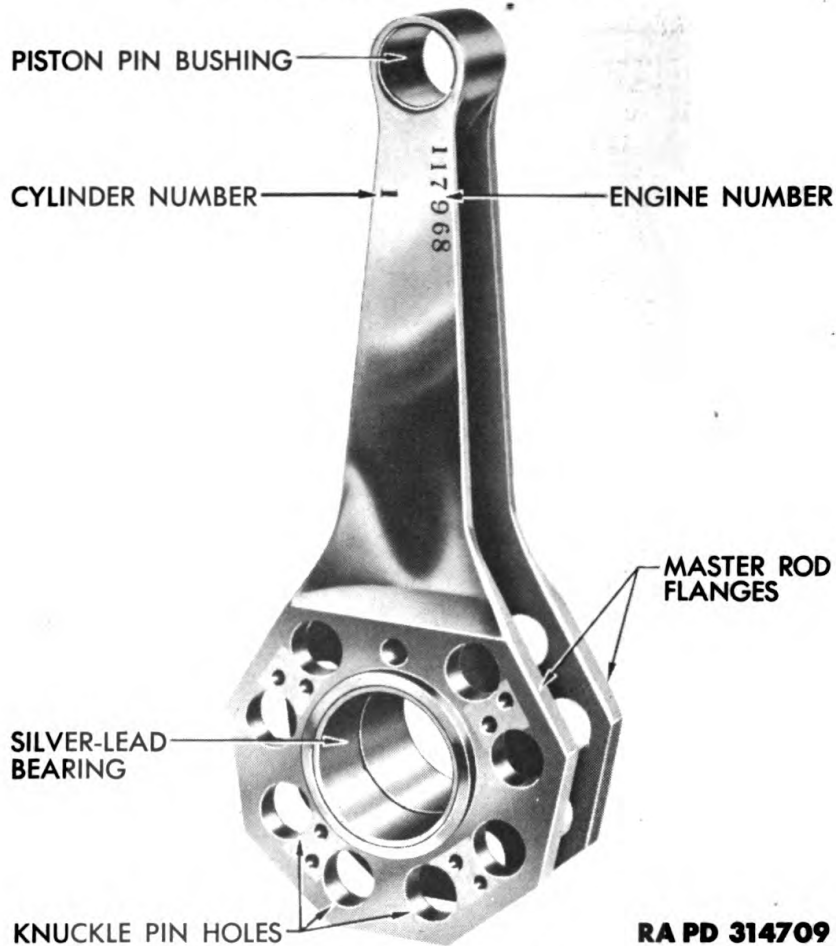
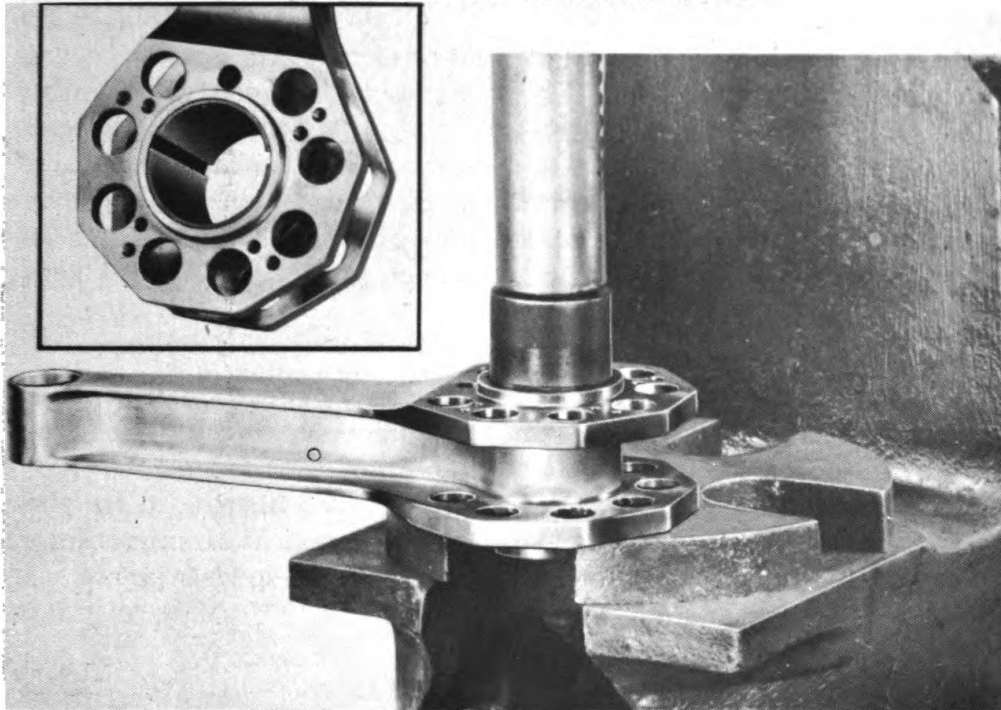

Figure 127 — Master Rod

pin for any evidence of burning. Measure the diameter of the crankshaft front end and crankpin for size and out-of-round condition. Replace entire crankshaft assembly if crankshaft is cracked, or otherwise damaged; if diameter is less than prescribed (Table of Limits), or if it is out of round more than 0.002 inch. The crankshaft sections are assembled in balance. If one section is replaced, replace other section also with a balanced assembly. If front end of crankshaft is out of round less than 0.002 inch, hone off high spots. If shaft threads are badly worn or damaged, replace entire assembly. Dress off rough spots with fine stone, and polish with crocus cloth. Reinstall thread protector over threads. If condition of plug bore in shaft and plug is satisfactory, reinstall plug. Tighten plug securely and stake to crankpin in two places with prick punch (fig. 126).

b. Rear Crank. Have rear crank magnafluxed for cracks. Replace entire crankshaft assembly if rear crank is cracked, or badly damaged. Inspect crank for scratches, nicks, and burs. Inspect in-

**DISASSEMBLY, CLEANING, INSPECTION, REPAIR, AND
ASSEMBLY OF SUBASSEMBLIES**



**Figure 128 – Pressing Out Slotted Master Rod Bearing
Using Plug 41-P-2115-500** RA PD 314873

side diameter of crankpin hole for scratches, burs, and chafing. Examine clamping cap screw hole threads for evidence of pulling. Check condition of clamping cap screw threads. Remove light nicks and burs with fine stone, and polish with crocus cloth. Dress threads with fine stone. Inspect rear main bearing journal for roughness and clearness of oil passages, and condition of the crankshaft gear retaining screw hole threads. If out-of-round condition was discovered when rear main bearing journal was measured (par. 31 a), remove high spots with fine stone and polish with crocus cloth. Inspect crank-cheek extension for condition. Replace entire assembly if any major part is damaged. Freeze rear plug and reinstall in rear of rear main bearing journal. Screw front plug into front of rear crank. Heat master rod spacer in hot oil, and reinstall over crankpin with the spacer radius against the crankpin radius.

c. Dynamic Damper. Magnaflux dynamic damper and damper pins for cracks. Check pins for roughness, wear, condition of flanges, and out-of-round condition. Replace cracked damper and unserviceable pins. Inspect dynamic damper stop plate, stop plate bolts, and nuts. Smooth off slight rough spots or burs. Replace badly damaged parts.

d. Front Main Bearing. Using a magnifying glass, inspect front bearing rollers for flat spots or pits. Replace roller assembly if rollers

**ORDNANCE MAINTENANCE — ORDNANCE ENGINE
MODEL R975-C4 (CONTINENTAL)**

are pitted or have flat spots. Place roller assembly on inner race, and rotate roller assembly to see that it turns smoothly in race. If assembly does not rotate smoothly, replace roller assembly. Inspect inner bearing race, and replace if damaged. Replace bronze bearing spacer if it is warped or burred. Install bronze spacer and inner bearing race on crankshaft. Place roller assembly in outer race. Wrap this assembly in waxed paper and place on bench until needed when reassembling engine.

e. Master Rod.

(1) **MASTER ROD.** Magnaflux master rod for cracks. Inspect rod for nicks, burs, and condition of knuckle pin holes and lock plate screw holes. Replace rod if unserviceable condition is found.

(2) **MASTER ROD BEARING.** Check master rod bearing to see that it is tight in rod. Inspect bearing surface for scores. With micrometer, check inside diameter of bearing at four equally spaced points. If bearing is severely scored, if diameter exceeds 2.3137 inches, or if it is out of round, replace bearing.

(3) **REPLACE MASTER ROD BEARING.**

(a) *Remove Bearing.* Drill out bearing locking pin. Slot bearing with brooch, shaper, slotter, key seater, or mill. Tap out master rod bearing with drift, or install collar and plug (41-P-2115-500), and press out in arbor press. The slots in the bearing will cause the bearing to collapse and drop out of rod. Clean and polish master rod bore with crocus cloth. Check inside diameter of master rod bore against outside diameter of replacement bearing. Refer to Table of Limits for correct shrinkage. The importance of this fit cannot be overemphasized. Check dimensions at room temperature.

(b) *Install Bearing.* Heat master rod to 450°F. Shrink new bearing in dry ice or ice water, if ice is not available. Insert new bearing in rod. Be sure that bearing oilholes line up with master rod oilholes. Allow master rod to cool to room temperature.

(c) *Install Locking Pin.* Using a $\frac{3}{16}$ -inch drill, drill through the locking pin hole in master rod and through bearing. Tap locking pin into place. Using a staking tool, peen master rod metal over locking pin to secure the pin. Seal oilholes with paraffin to prevent metal from entering oil passages.

(d) *Ream Master Rod Bearing.* Install knuckle pins and locating pins in master rod (fig. 129). Install alining plugs in bearing and piston pin bushing. Place master rod in alining and boring machine (fig. 129). Insert alining bars through bearing and bushing holes to aline holes. Secure master rod in machine. Remove alining bar and the plug from the bearing bore, and install boring bar. Lock rod in position and ream inside diameter of bearing. Bearing should have an inside diameter of between 2.312 and 2.3137 inches. Remove

**DISASSEMBLY, CLEANING, INSPECTION, REPAIR, AND
ASSEMBLY OF SUBASSEMBLIES**

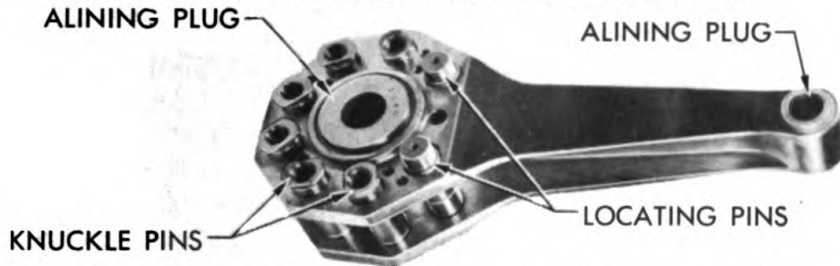

1. Master Rod with Knuckle Pins, Locating Pins, and Alining Plug Installed

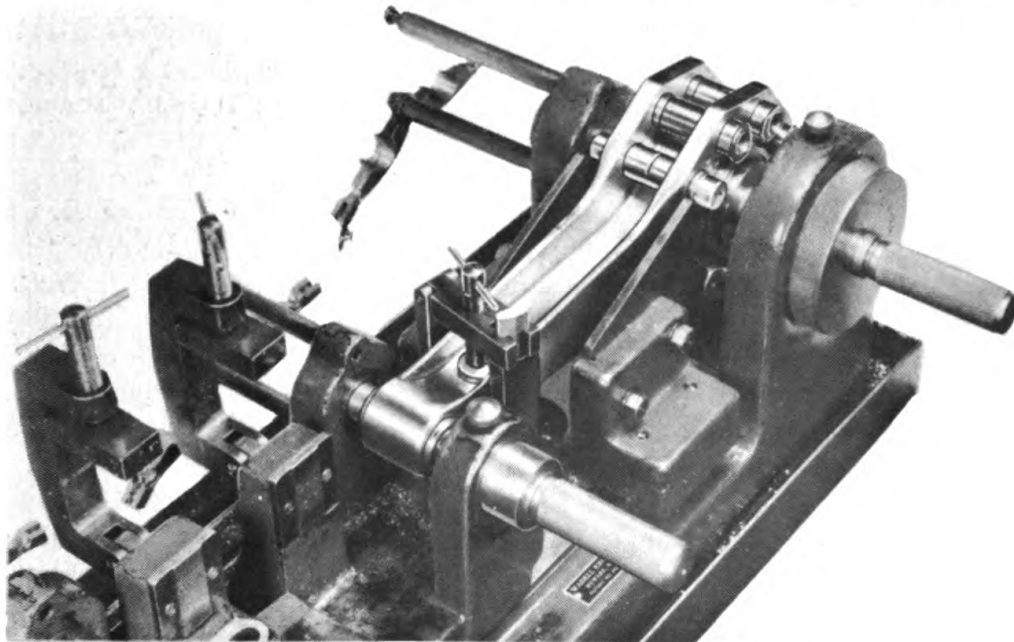

2. Lining Up Bearing Hole in Boring Machine

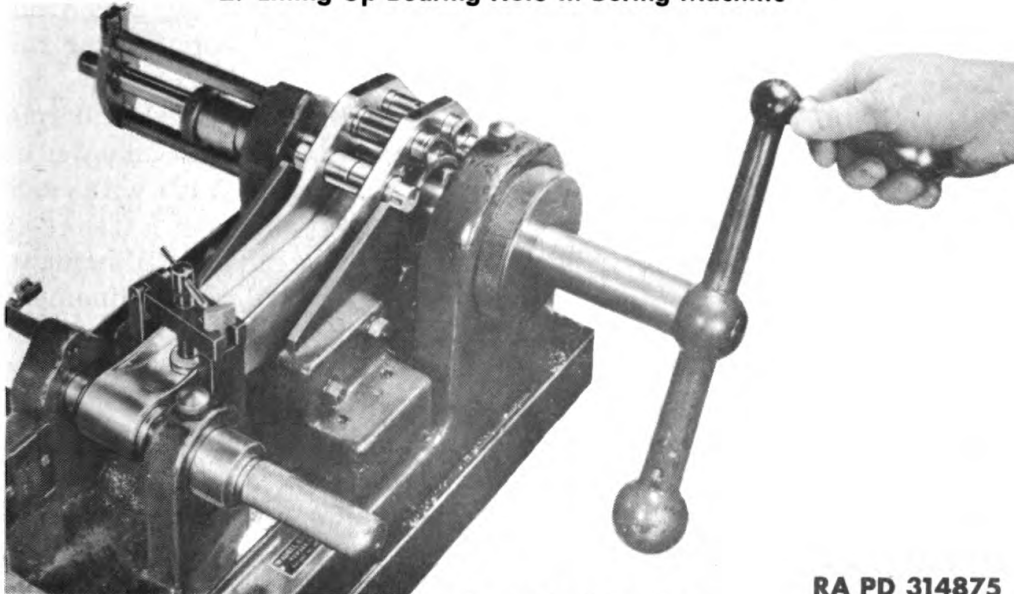

3. Reaming Master Rod Bearing

**Figure 129 – Reaming New Bearing in Master Rod Using
Fixture 41-F-2987-425**

**ORDNANCE MAINTENANCE – ORDNANCE ENGINE
MODEL R975-C4 (CONTINENTAL)**

master rod from machine. Remove plug from piston pin bushing. Break all sharp edges from bearing. Remove paraffin from oilholes and blow out oilholes with compressed air to clear passages.

(4) **PISTON PIN BUSHING.** Examine piston pin bushing in master rod to see that it is tight in rod and free from scores. Check diameter with micrometer or plug gage. If bushing is loose, badly scored, or worn beyond 1.2505 inches in diameter replace bushing.

(5) **REPLACE PISTON PIN BUSHING.**

(a) *Remove Bushing.* Insert small end of arbor press plug into bushing. Place base of rod on arbor press table and insert collar in base. Support rod over collar so that plug extends through bushing and into collar. Press out old bushing. Remove plug and rod. Clean up master rod bushing bore and remove all burs.

(b) *Install Bushing.* Place bushing on small end of plug and screw cap on plug. Place end of rod over collar, and insert large end of plug through rod bore so that it extends into collar. Locate split in bushing in extreme end of rod at an angle of 45 degrees to the center line of rod channel. Install rod in arbor press, and press down on plug cap until the pressed-in plug bottoms against the collar. Remove the plug and collar. Install rod in arbor press and press broaching bar through bushing to expand it into rod.

(c) *Ream Bushing.* Place knuckle pins, locating pins, and alining plug in master rod bearing. Plug in bushing and place master rod in alining and boring machine. Install alining bars (fig. 129). Lock rod into position in machine. Remove alining bar from newly installed bushing, and install reaming fixture. Ream bushing to between 1.2495 and 1.2505 inches. Remove rod from machine. Remove plug from bearing and knuckle pins and remove locating pins from master rod flange.

(d) *Spin Bushing Ends.* Use spinning tool in drill press, and spin over ends of master rod bushing until they bottom against chamfer at each end of bushing. Ends of bushing should come flush with ends of master rod.

(6) **CHECK MASTER ROD TWIST.** Check master rod for alinement, and for twist in relation to the crankpin (fig. 130), using alinement stand (41-S-4977) and the proper sized alining bars (par. 92), a dial indicator, and feeler gage set. Insert arbor in each knuckle pin hole in master rod, one at a time. Check alinement of each hole. If mis-alinement, twist of master rod, or misalinement of knuckle pin holes exceeds 0.004 inch for every 6 inches, in any instance, replace rod. Do not attempt to straighten master or articulated rods.

34. ASSEMBLY.

a. **Install Dynamic Damper.** Position dynamic damper with "anti-prop" end facing up the same as rear crank rear main bearing

**DISASSEMBLY, CLEANING, INSPECTION, REPAIR, AND
ASSEMBLY OF SUBASSEMBLIES**

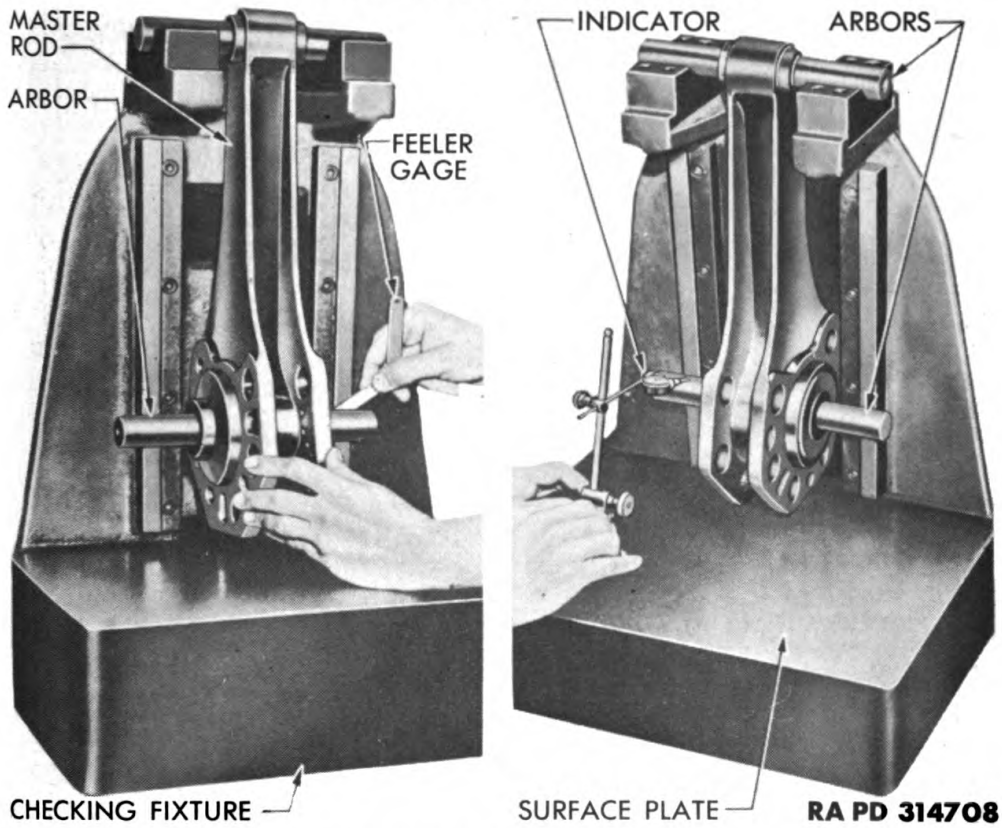

Figure 130 – Checking Master Rod Twist

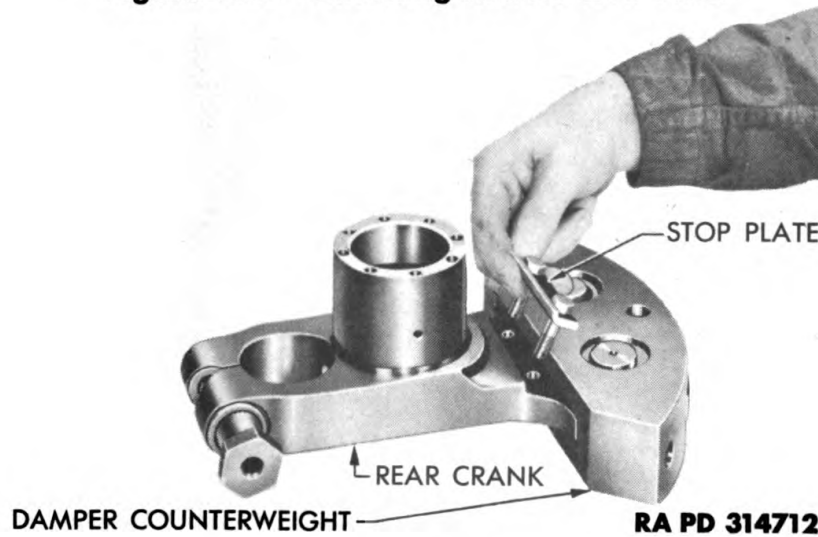
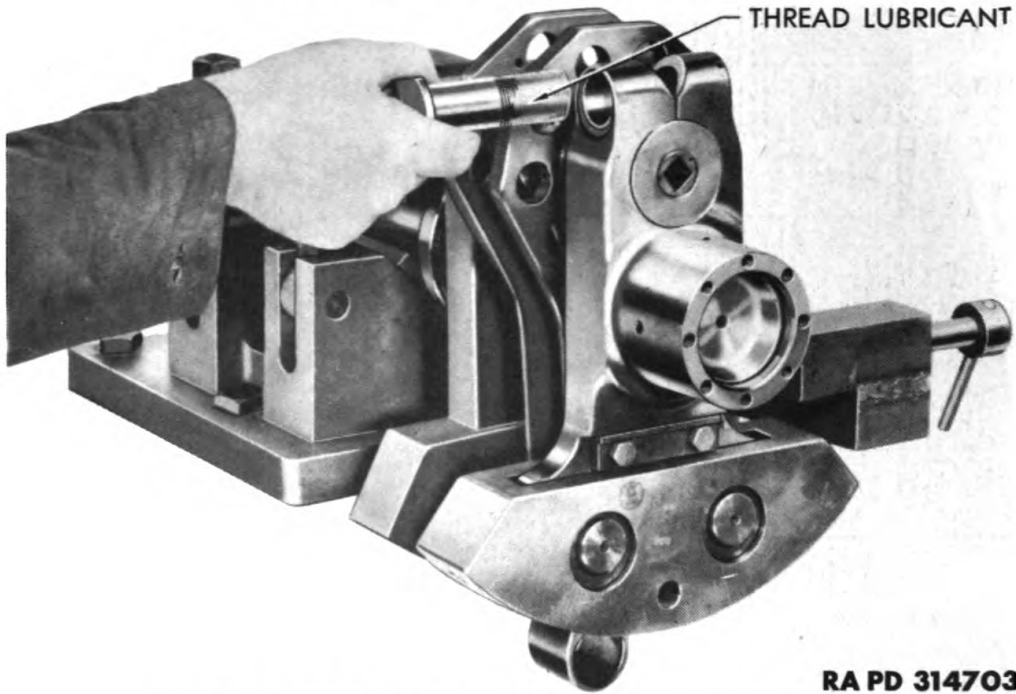

Figure 131 – Installing Stop Plate

journal. Line up damper counterweight holes with rear crank extension holes. Insert counterweight pins. Center pins in counterweight and install counterweight stop plate and bolts (fig. 131). Secure plate in place by tightening two nuts securely on bolts. Secure nuts with cotter pins.

**ORDNANCE MAINTENANCE — ORDNANCE ENGINE
MODEL R975-C4 (CONTINENTAL)**



RA PD 314703

Figure 132 — Installing Clamping Cap Screw

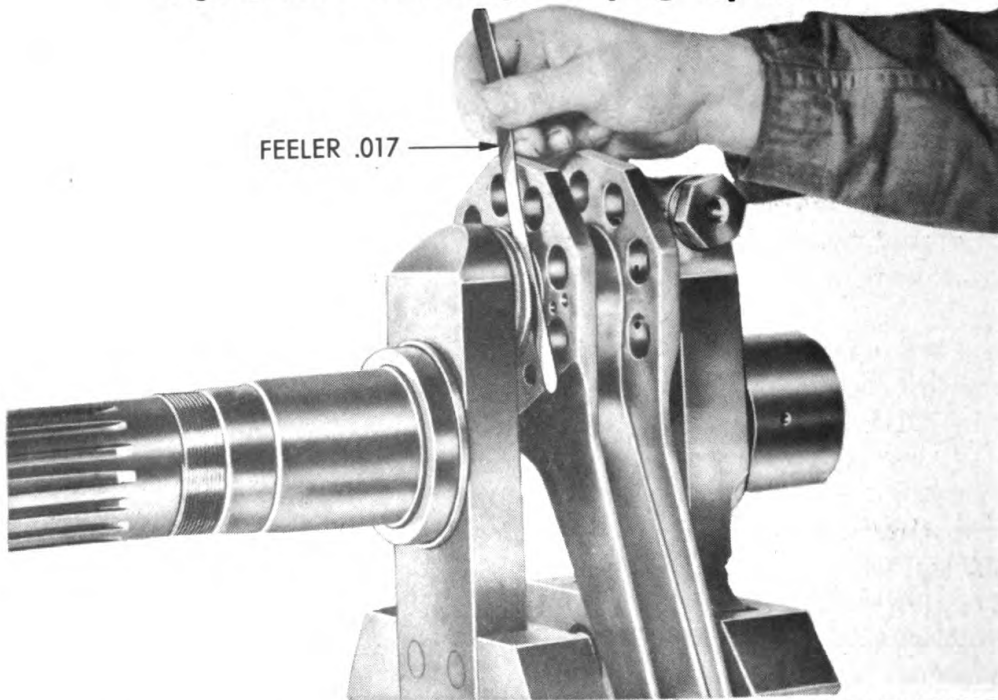

RA PD 314705

Figure 133 — Checking Master Rod End Play Using Gage 41-G-400

**DISASSEMBLY, CLEANING, INSPECTION, REPAIR, AND
ASSEMBLY OF SUBASSEMBLIES**

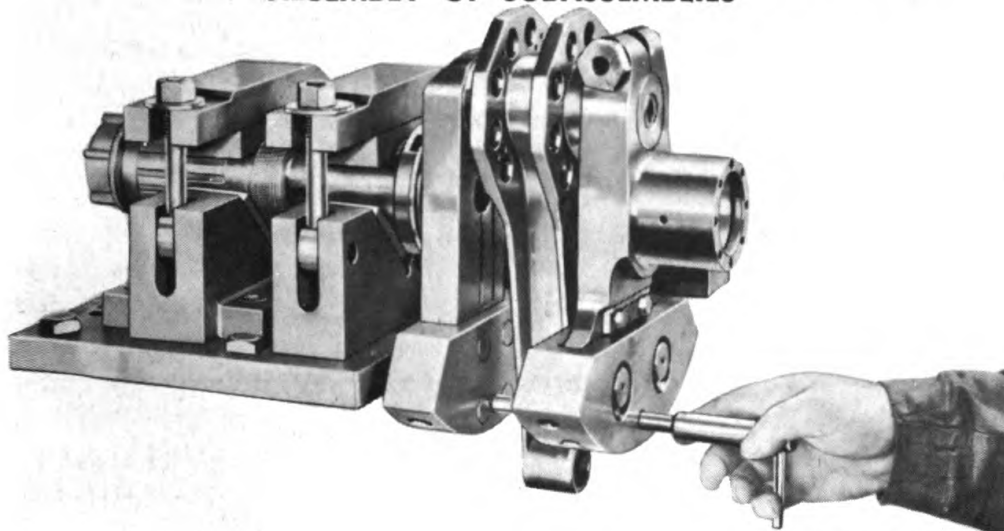

RA PD 314704

**Figure 134 – Alining Crankshaft Sections Using Alining Bar
41-B-150-25**

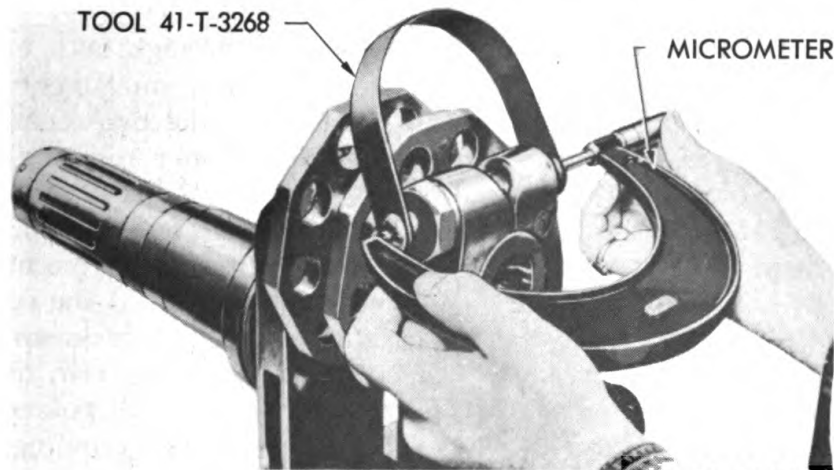

RA PD 314901

Figure 135 – Measuring Clamping Cap Screw

b. Install Master Rod. Place front crankshaft section in assembly stand. Make certain there is no foreign matter on crankpin. Cover crankpin with oil and apply oil liberally to master rod bearing. Slide master rod on crankpin with holes for knuckle pin locks facing front, or flywheel end (fig. 121).

c. Install Rear Crank. Wipe all oil from the crankpin beyond master rod flange. Remove clamping cap screw from rear crank. Spread cheeks of rear crank (fig. 120). With counterweights lined up as closely as possible, slide rear crank onto crankpin. Coat clamping cap screw with thread lubricant (fig. 132). Insert washer, screw in crank, and tighten screw fingertight.

**ORDNANCE MAINTENANCE — ORDNANCE ENGINE
MODEL R975-C4 (CONTINENTAL)**

d. **Check Master Rod End Play.** With feeler gage, check end play between master rod flange and master rod spacer (fig. 133). The 0.017-inch feeler gage should fit between the flange and cheek; the 0.019-inch feeler gage should not. Move rear crank to provide proper amount of end play as indicated by feeler gages.

e. **Line Up Cranks.** From tool kit, select line-up bar that fits alinement holes in cranks securely. Insert bar through alinement holes in counterweight and dynamic damper (fig. 134). Remove alining bar.

f. **Measure Length of Clamping Cap Screw.** Before tightening rear crank cap screw which is now fingertight, measure the length of the screw by placing the stretch measuring tool (41-T-3268) on cap screw. Measure over tool with micrometer (fig. 135). Tighten cap screw with wrench and wrench extension (fig. 119) until cap screw is increased in length from 0.005 to 0.007 inch. The stretch is determined by the length of the cap screw before and after tightening. Check the alinement of the two crankshaft sections with the alining bar at intervals while tightening the cap screw, and after screw is tightened completely. Do not leave the bar through both counterweights while the screw is being tightened. Any movement of the rear section will cause the bar to bend. When the two sections are in line again, measure the end play of the master rod (fig. 133). When end play is adjusted correctly, secure cap screw with cotter pin (fig. 136). If the original cotter pin holes do not line up, drill a new hole in cap screw. The new hole must be removed from all other adjacent holes by at least $\frac{1}{4}$ inch, center to center. If the specified amount of stretch makes this impossible, reduce the thickness of the cap screw washer as much as 0.010 inch by grinding from one side or both sides of the washer. Grind carefully so that all points of the washer will bear evenly on the cap screw head. After grinding, break all sharp edges to within $\frac{1}{64}$ inch, and check for interference on the fillet under the cap screw head. Install cotter pin from inside. Be sure pin is pushed in as far as it will go (fig. 136). Cut cotter pin so pin does not protrude more than $\frac{1}{4}$ inch, and spread pin prongs around circumference of rear crank.

g. **Check Run-out of Shaft.** Remove crankshaft assembly from assembly stand and install on alinement fixture (fig. 137) or alinement rollers (41-R-2660). Install dial indicator so that it contacts smooth shaft surface between flywheel splines and extreme front end threads. Rotate shaft one complete revolution. If run-out indication on dial exceeds 0.004 inch, remove assembly from alinement fixture and reinstall in assembly stand. Loosen clamping cap screw, and recheck shaft alinement (subpar. f, above). Retighten clamping cap screw. Again place assembly in alinement fixture, or rollers, and

**DISASSEMBLY, CLEANING, INSPECTION, REPAIR, AND
ASSEMBLY OF SUBASSEMBLIES**

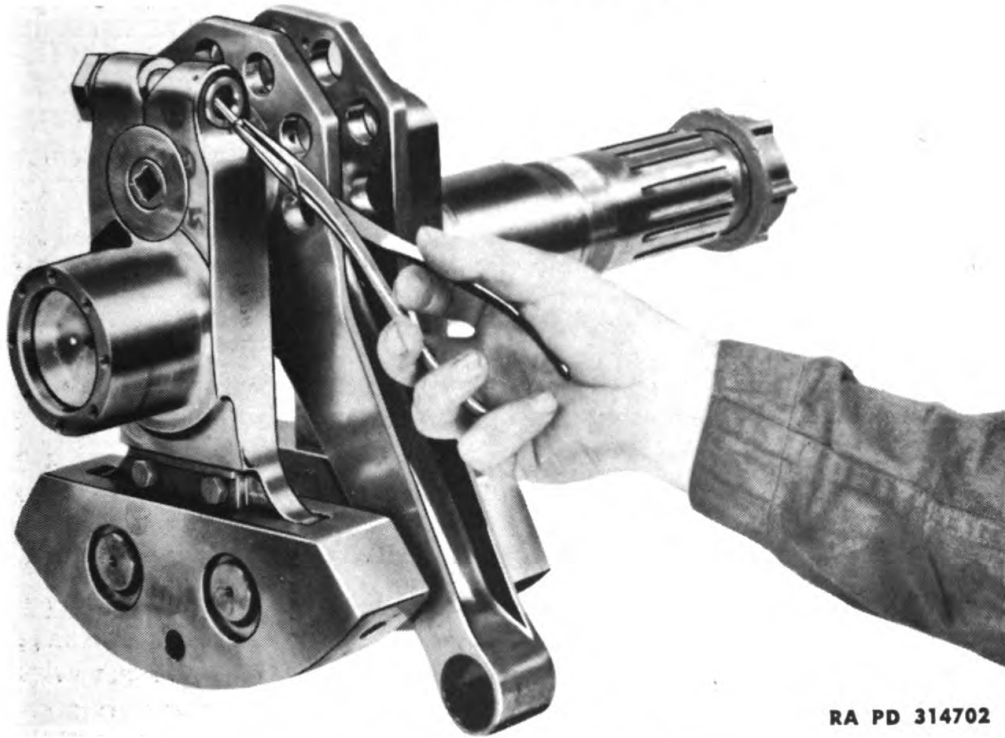

RA PD 314702

Figure 136 – Installing Cotter Pin for Clamping Cap Screw

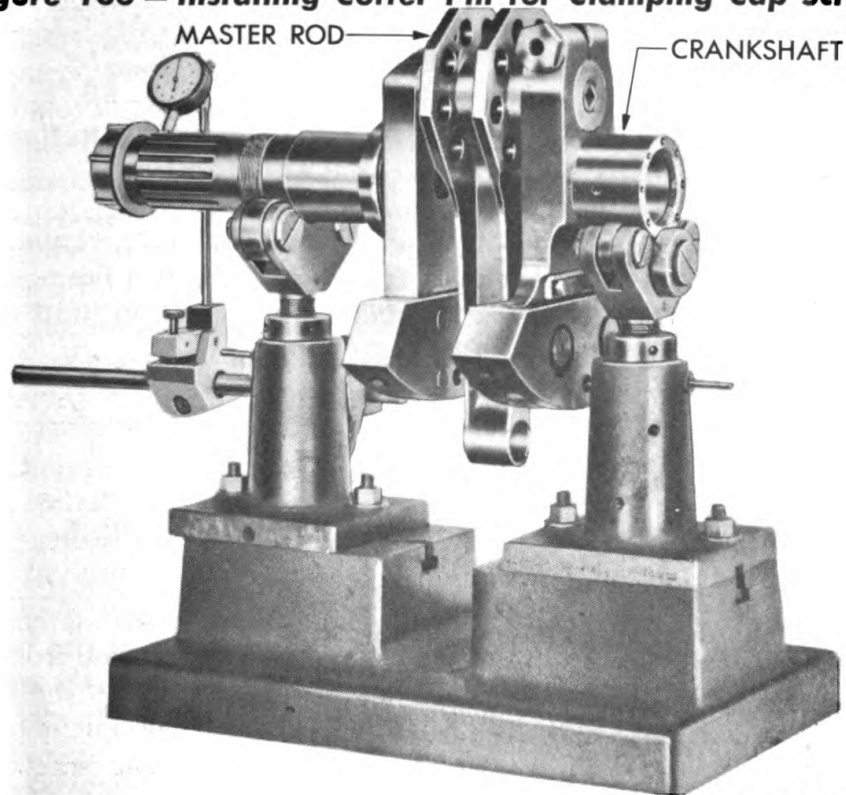

RA PD 314855

Figure 137 – Crankshaft in Alinement Fixture

ORDNANCE MAINTENANCE — ORDNANCE ENGINE
MODEL R975-C4 (CONTINENTAL)

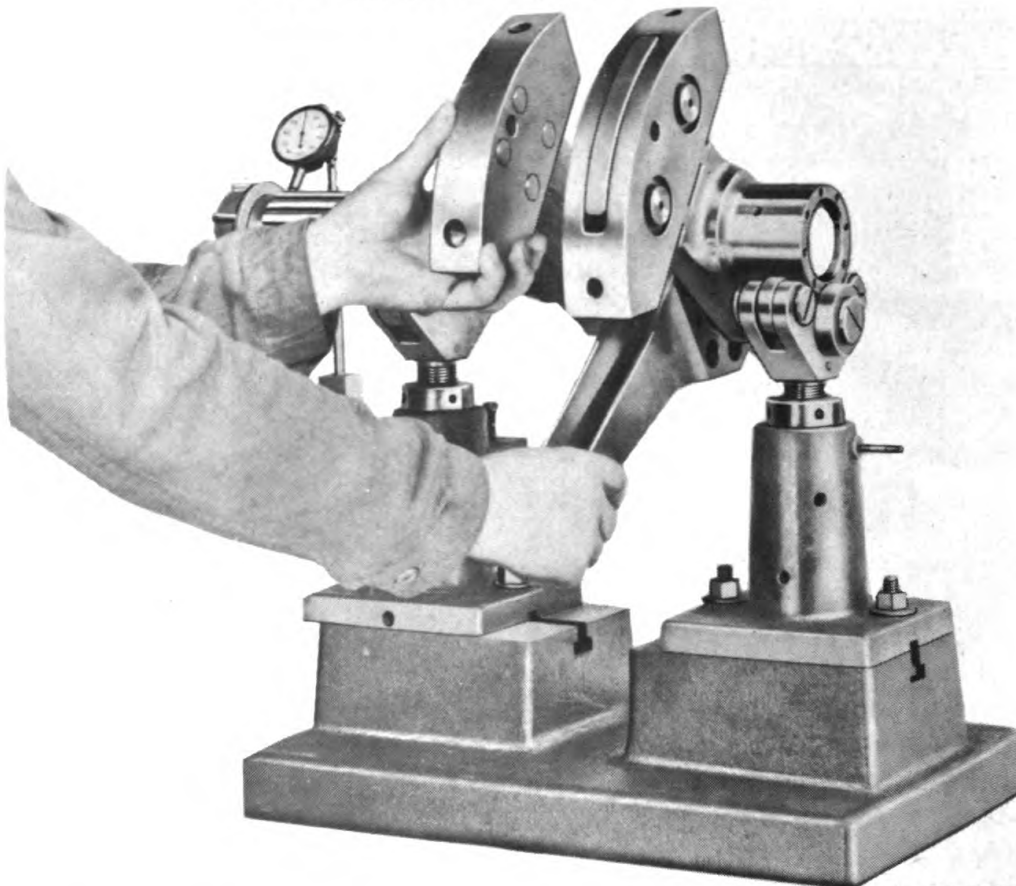

RA PD 314701

**Figure 138 — Checking Crankshaft Run-out Using Rollers
41-R-2660 and Indicator 41-I-100**

check run-out. If run-out is not within prescribed limits, replace entire crankshaft assembly. If run-out is within prescribed limits, place crankshaft assembly on bench, and cover to keep it clean until ready to reinstall in engine.

Section VII

ARTICULATED RODS AND KNUCKLE PINS

| | Paragraph |
|--|------------------|
| Disassembly | 35 |
| Cleaning, inspection, and repair | 36 |
| Assembly | 37 |

35. DISASSEMBLY.

a. Articulated rods and knuckle pins are already removed from main crankcase assembly (par. 9 t).

**DISASSEMBLY, CLEANING, INSPECTION, REPAIR, AND
ASSEMBLY OF SUBASSEMBLIES**

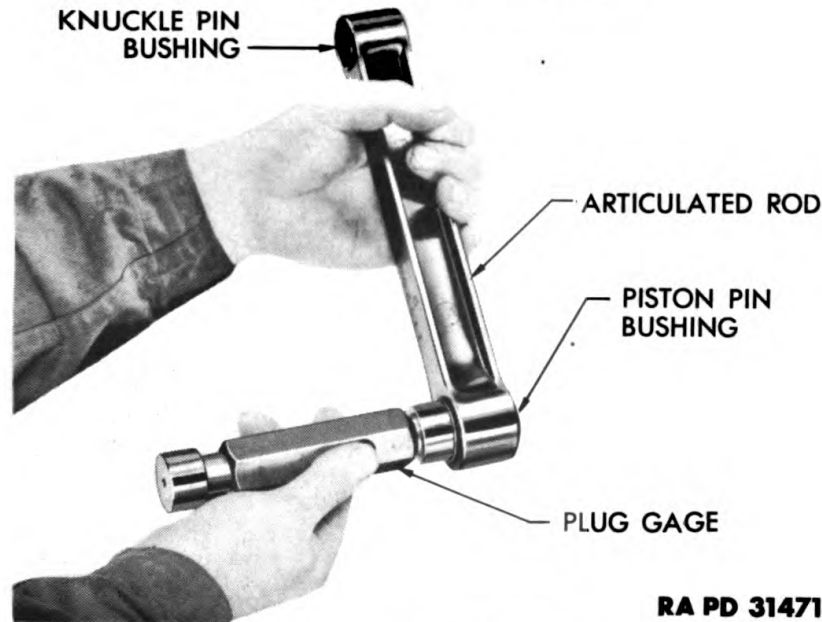

RA PD 314717

Figure 139 – Checking Articulated Rod Bushing

36. CLEANING, INSPECTION, AND REPAIR.

a. Articulated Rods. Clean articulated rods with dry-cleaning solvent, and coat with light film of engine oil. Have rods given a magnaflux inspection for cracks. Inspect rods for nicks and burs. Replace cracked or badly damaged rods. Remove slight burs or nicks with fine stone. Examine knuckle pin and piston pin bushings for scores and wear. Measure inside diameter of rod bushings with micrometer or plug gage (fig. 139). If bushings are greater in diameter than noted below, replace bushings. Follow same procedure to replace bushings (figs. 140 and 141) used to replace piston pin bushings in master rod (par. 33 e (5) (a) and (c)). Both the piston pin and knuckle pin bushings must be reamed at the same time if both are replaced. Ream the piston pin bushing to a diameter between 1.2495 and 1.2505 inches, and knuckle pin bushings to a diameter between 0.8765 and 0.8772 inches. To permit bushing to fit in master rod flange, cut off the ends. Insert cutting tool in drill press spindle. Place rod in press and cut ends of bushing. Knuckle pin bushings should measure from 1.378 to 1.382 inches in length, and piston pin bushings from 1.448 to 1.452 inches. Place rods in alignment stand (49-S-4977), and check for twist (par. 33 e (6)). If any rod is out of alignment more than 0.004 inch in 6 inches, replace rod. Do not attempt to straighten rod. Match all articulated rods in assembly for weight. Replace any rod weighing more or less than weight specified in Table of Limits. Place rods on clean bench in order. Rods are marked in I-section with weight, engine number, and cylinder number. Use correct rod in each cylinder assembly.

**ORDNANCE MAINTENANCE – ORDNANCE ENGINE
MODEL R975-C4 (CONTINENTAL)**

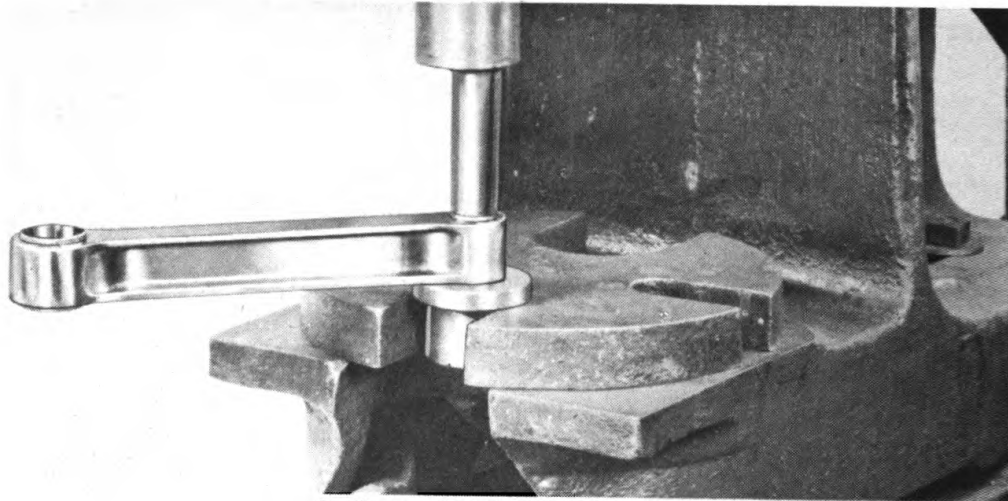

1. Removing Bushing

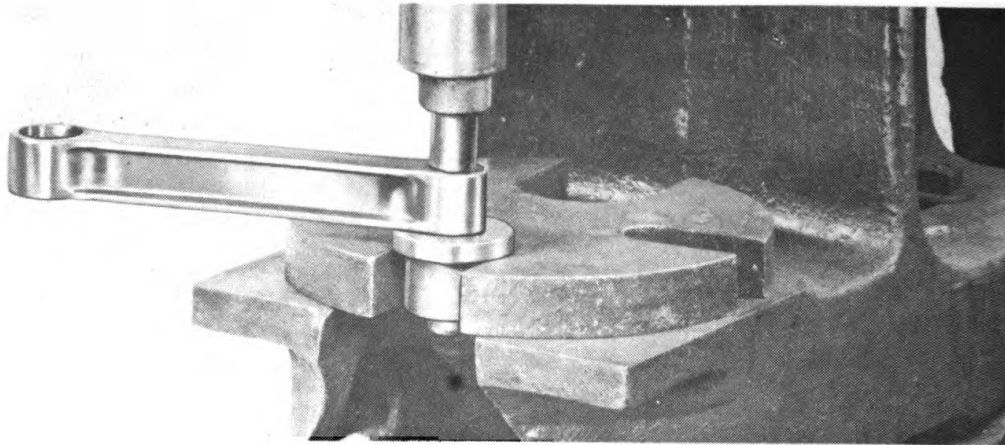

2. Installing Bushing

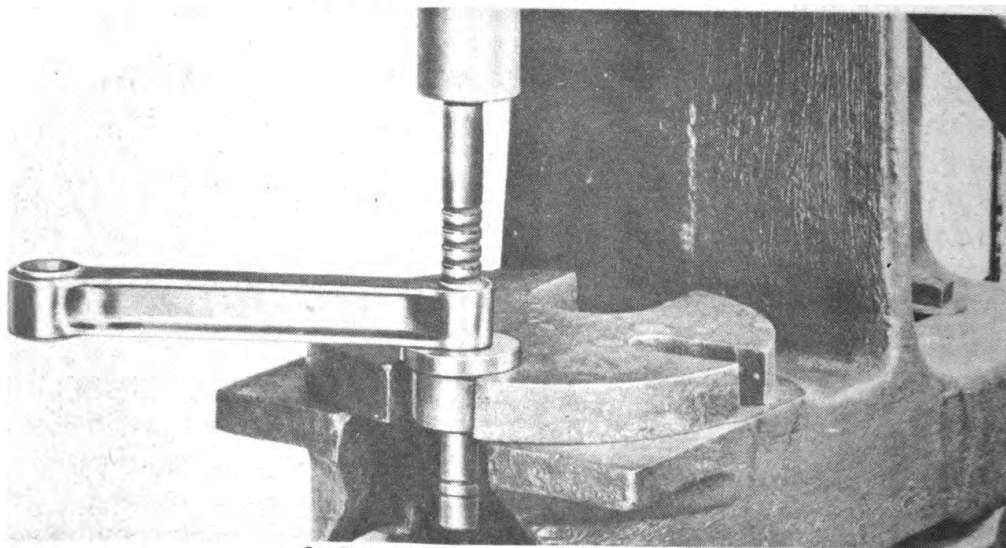

3. Broaching Bushing

RA PD 314868

**Figure 140 – Replacing Articulated Rod Bushing Using
Tool Set 41-T-3539-8**

**DISASSEMBLY, CLEANING, INSPECTION, REPAIR, AND
ASSEMBLY OF SUBASSEMBLIES**

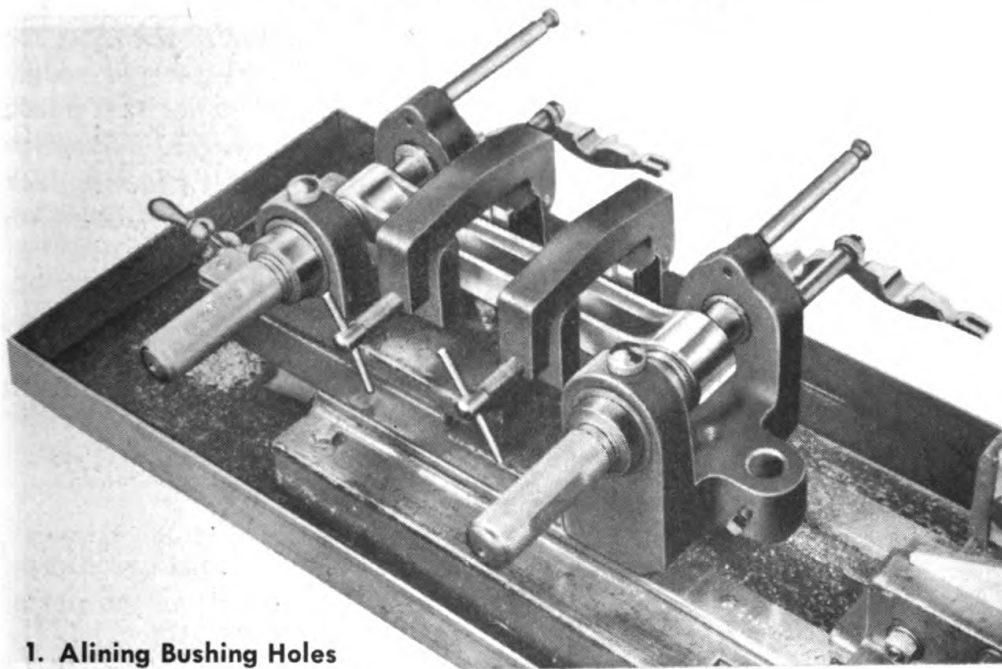

1. Alining Bushing Holes

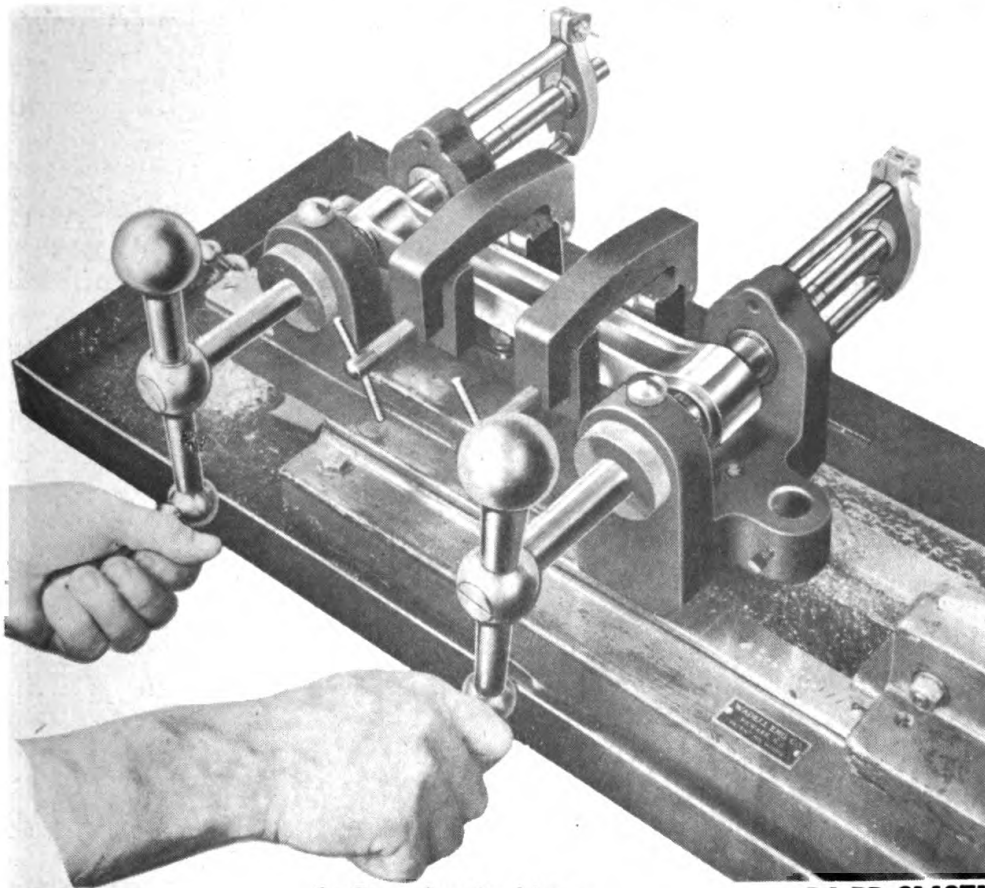

2. Reaming Bushings

RA PD 314871

**Figure 141 — Reaming Articulated Rod Bushings Using
Fixture 41-F-2987-425**

Digitized by

Google

**ORDNANCE MAINTENANCE – ORDNANCE ENGINE
MODEL R975-C4 (CONTINENTAL)**

b. **Knuckle Pins.** Give knuckle pins magnaflux inspection for cracks. Replace cracked pins. Inspect pins also for scores or roughness. Smooth scored or scratched pins with a fine stone, and polish with crocus cloth. Clean out knuckle pin oil passages. Examine knuckle pin lock plates for burs, cracks, or warpage, and examine lock plate screws for burred or damaged threads. Replace any unserviceable parts.

37. ASSEMBLY.

a. Articulated rods and knuckle pins are not assembled at this time. Place them on clean bench and cover them until ready to install.

Section VIII

CRANKSHAFT GEAR ASSEMBLY

| | Paragraph |
|--|-----------|
| Disassembly | 38 |
| Cleaning, inspection, and repair | 39 |
| Assembly | 40 |

38. DISASSEMBLY.

a. Remove spring retainer from crankshaft gear assembly. Pry out each spring with its two pins. Turn hub within gear until gear lugs are no longer engaged in hub slots. Separate hub and gear. Place parts on bench for cleaning and inspection.

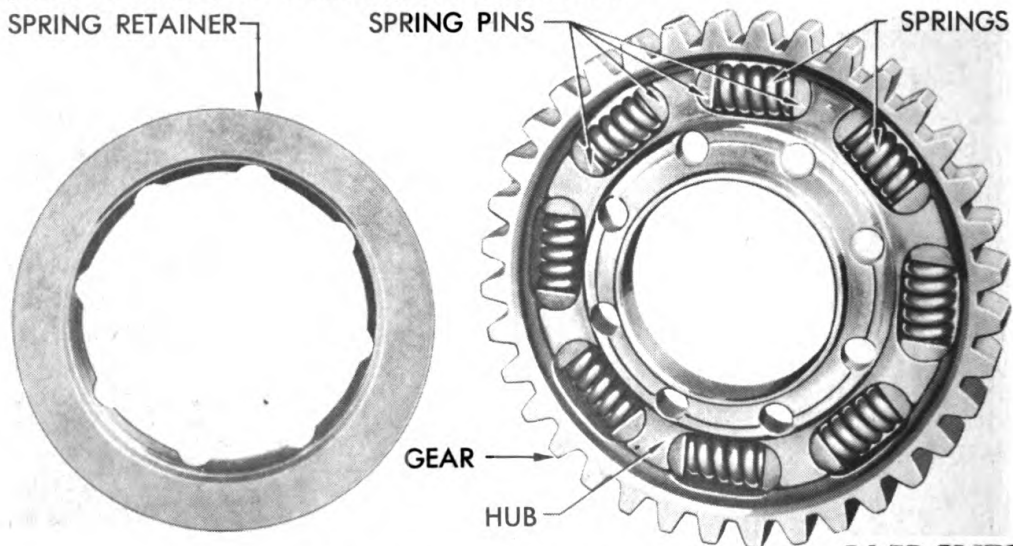

Figure 142 – Crankshaft Gear Assembly

RA PD 314707

**DISASSEMBLY, CLEANING, INSPECTION, REPAIR, AND
ASSEMBLY OF SUBASSEMBLIES**

39. CLEANING, INSPECTION, AND REPAIR.

a. Clean assembly parts with dry-cleaning solvent, and coat with light film of oil. Magnaflux gear for cracks. Inspect gear for burs and broken or worn teeth; inspect for cracked or badly damaged gear. Remove slight nicks and burs with fine stone, and polish with crocus cloth. Examine hub and lugs for nicks and burs. Check condition of screw holes in hub. Dress up nicks and rough spots. Smooth up spring retainer if it is found to be rough. Check springs for condition, and measure spring tension. Replace broken springs, or springs which do not have at least 170 pounds of tension at a spring length of 0.713 inch.

40. ASSEMBLY.

a. **Assemble Crankshaft Gear.** Insert hub in gear, and turn gear until lugs are held in hub slots. Insert pins in end of each spring, and push spring with pins into position (fig. 142). Place retainer on gear assembly, alining cut-outs with screw holes. Place crankshaft gear assembly on bench and cover to protect it from dust until reinstalled.

Section IX

DIFFUSER SECTION

| | Paragraph |
|-----------------------------|------------------|
| Disassembly | 41 |
| Cleaning | 42 |
| Inspection and repair | 43 |
| Assembly | 44 |

41. DISASSEMBLY.

a. **Remove Idler Gears.** Place diffuser section in fixture on bench with impeller side down (fig. 143). Remove cotter pins from retaining nuts securing idler gears to shaft. Remove in order, nuts, flat washers, long bronze spacer, idler gears, and inner spacing washers (fig. 144).

b. **Remove Impeller Drive Gear Shaft Support.** Remove cotter pin from nut on impeller drive gear shaft, and cotter pins from nuts holding shaft support to crankcase (fig. 145). Remove five nuts, one from gear shaft, and four from gear shaft support. Lift support off studs and shaft. Pull key out of top of impeller shaft. Shaft and gear will remain with diffuser section. *NOTE: It is important to remove key at this time to prevent possibility of key dropping down with the impeller drive gear into bearing after impeller has been removed.*

**ORDNANCE MAINTENANCE – ORDNANCE ENGINE
MODEL R975-C4 (CONTINENTAL)**

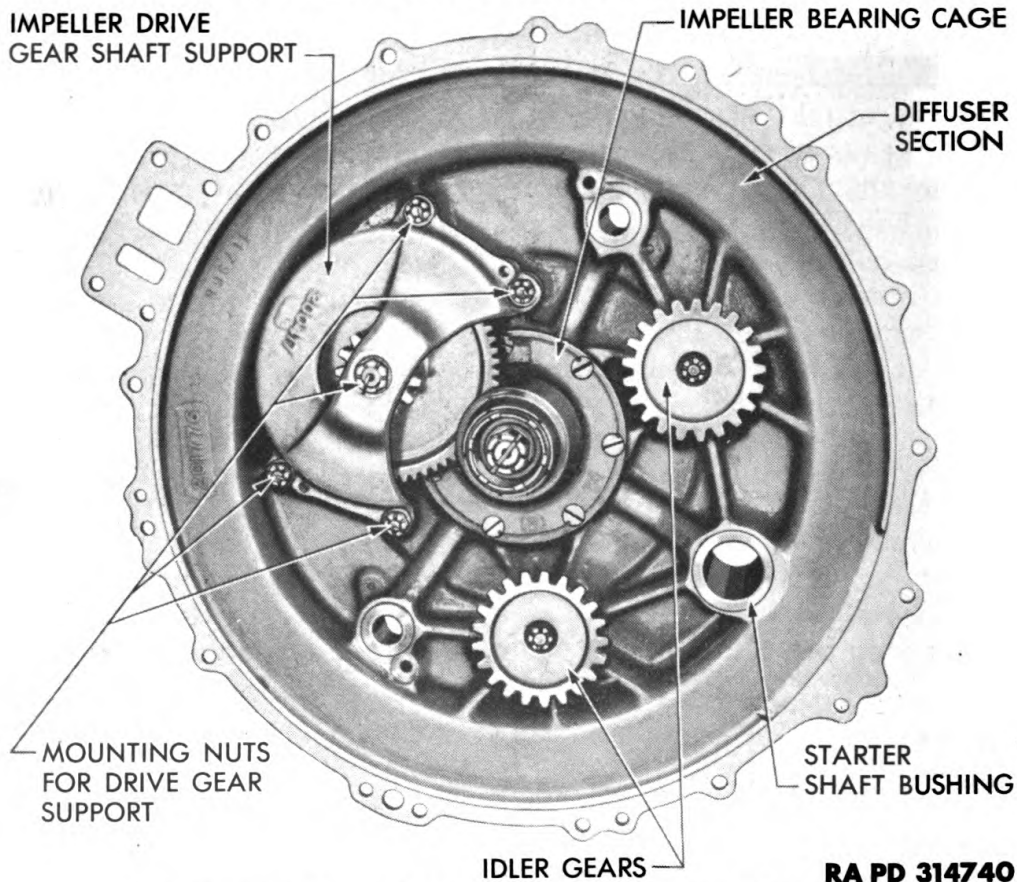

Figure 143 – Diffuser Section – Front Side

c. Remove Impeller. Place mounting fixture block No. 2 (fig. 146) in jaws of vise. Mount diffuser section in fixture with impeller up, and with nut on other end of impeller shaft seated properly in fixture hexagonal recess. Remove circlip and lock from nut on impeller shaft (fig. 147). Remove impeller retaining nut (fig. 148). Install puller on impeller. Pull impeller from shaft (fig. 149).

d. Remove Impeller Drive Gear and Shaft. Push impeller drive gear shaft up through diffuser section. At same time, hold drive gear and bushing from below. Upper end of shaft, before removal, is shown in figure 145. Remove diffuser section from fixture; turn section over and reinstall on same fixture.

e. Remove Impeller Bearing Cage. With screwdriver, take out seven slotted screws that hold impeller bearing cage to diffuser section (fig. 150). Lift out cage assembly (fig. 151). Oil seals, rings, and shims ordinarily will come out with cage. If they do not, remove them from cage. Remove gasket.

f. Disassemble Impeller Bearing Cage. Place fixture block No. 1 in vise with dowels pointing up (fig. 146). Mount cage assembly in

**DISASSEMBLY, CLEANING, INSPECTION, REPAIR, AND
ASSEMBLY OF SUBASSEMBLIES**

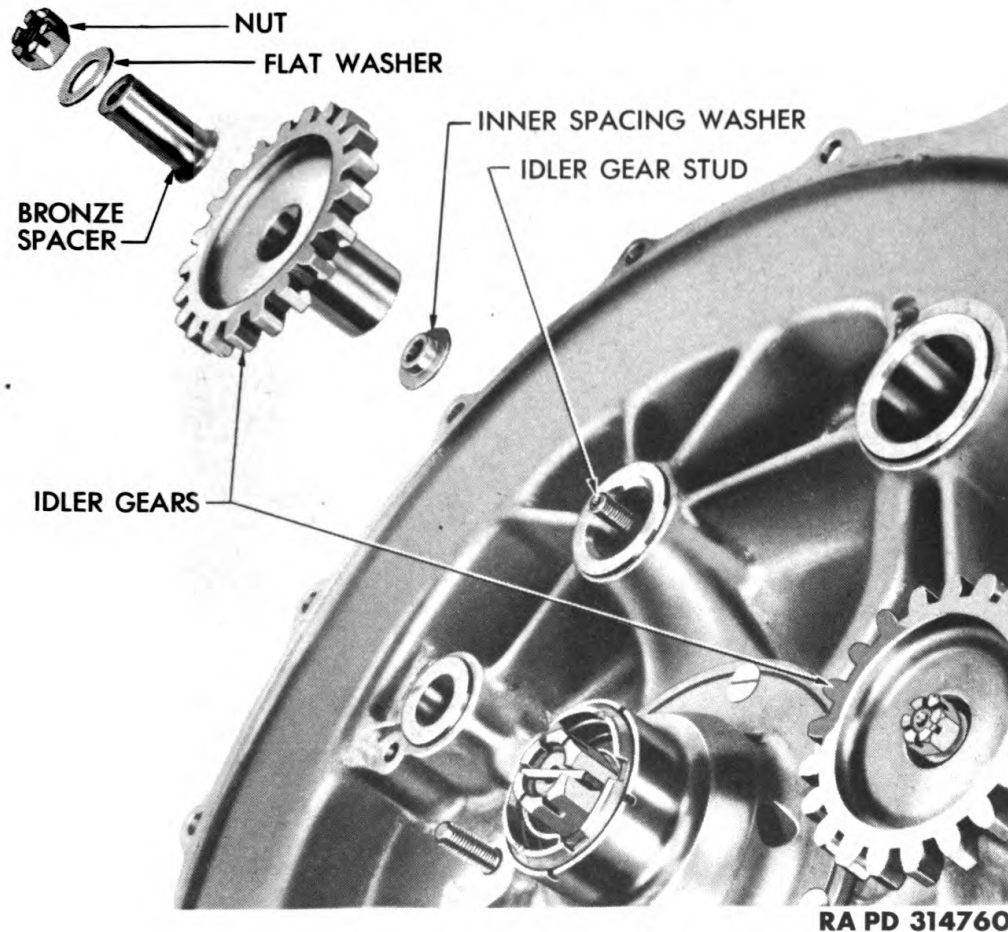

Figure 144 – Idler Gear Assembly – Disassembled

fixture with splined end of shaft in fixture spline and cage over two dowels (fig. 152). Remove circlip and lock. Unscrew nut from impeller shaft. Remove large circlip holding thrust nut to bearing cage (fig. 157). Using special wrench, remove thrust nut (fig. 152). Remove assembly from fixture. While holding cage, tap bearing thrust nut end of shaft and drive out shaft (fig. 157). One thrust bearing will come out with shaft. Using bearing puller, pull the other thrust bearing off shaft. Push other thrust bearing out of cage.

g. Remove Impeller Oil Seal Cage. Cut and remove safety wires from eight screws which hold oil seal cage to diffuser section. Remove eight screws. Lift off cage, paper gasket, copper shim, and second paper gasket (fig. 158). Remove the accessory drive shaft rubber seals and spacers (fig. 200).

h. Remove Diffuser Ring. Remove two screws that hold diffuser ring to diffuser section (fig. 160). Slide ring up and off bushings.

**ORDNANCE MAINTENANCE – ORDNANCE ENGINE
MODEL R975-C4 (CONTINENTAL)**

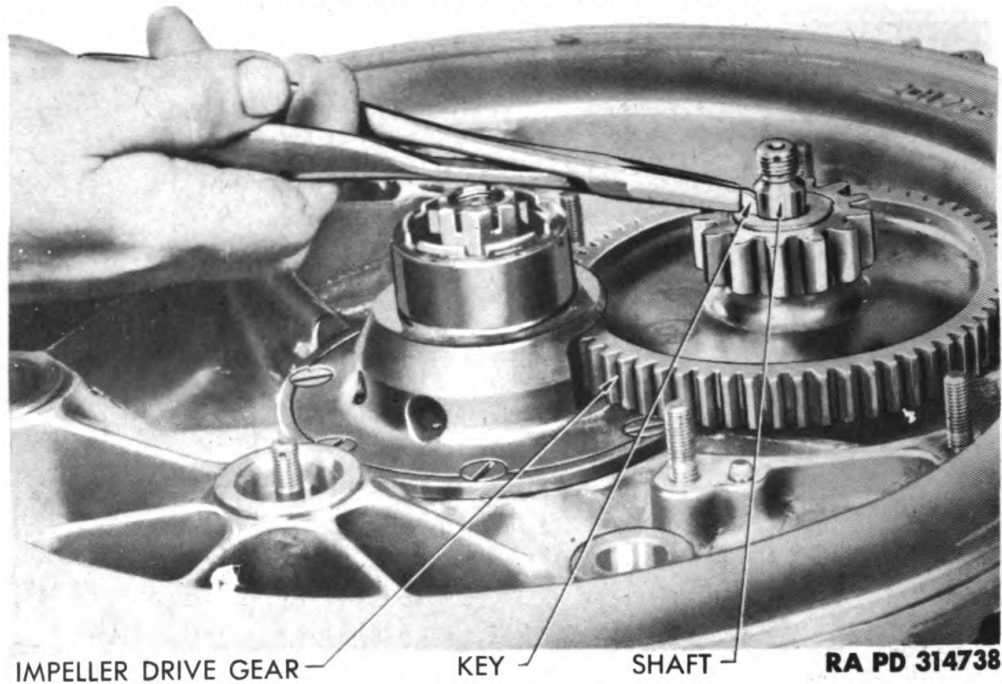

Figure 145 – Removing Key from Impeller Driver Gear Shaft

FIXTURES FOR HOLDING DIFFUSER ASSEMBLY

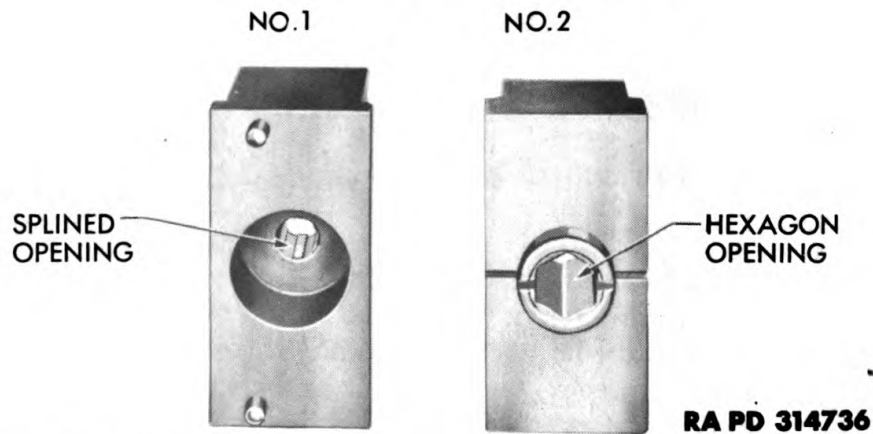

Figure 146 – Mounting Fixtures for Overhaul of Diffuser Section

42. CLEANING.

a. Clean all parts in dry-cleaning solvent, and coat with lubricating oil. Blow out all the oil passages in section to make sure they are clear. Clean all oilholes leading to bushings with compressed air.

43. INSPECTION AND REPAIR.

a. **Inspect Diffuser Section.** Check entire section for cracks or other indications of damage (fig. 153). Check points where pullers are attached during removal, to see that pullers have not damaged section. Check machined flanges at rim and bearing cages for scratches, burs, or roughness. Smooth scratches, burs, or rough spots

**DISASSEMBLY, CLEANING, INSPECTION, REPAIR, AND
ASSEMBLY OF SUBASSEMBLIES**

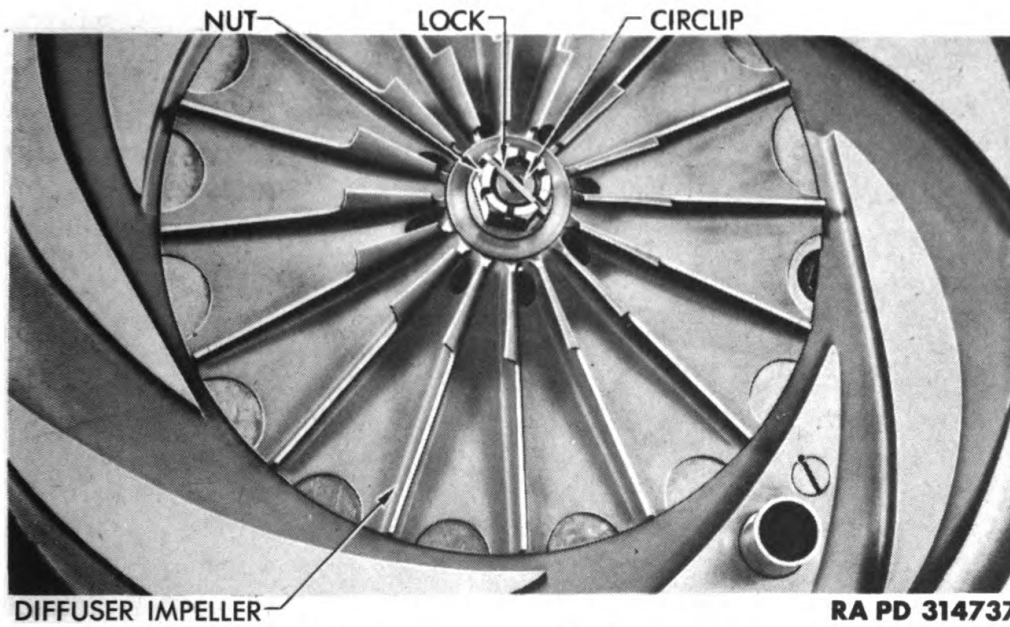

Figure 147 – Impeller Shaft Nut and Lock

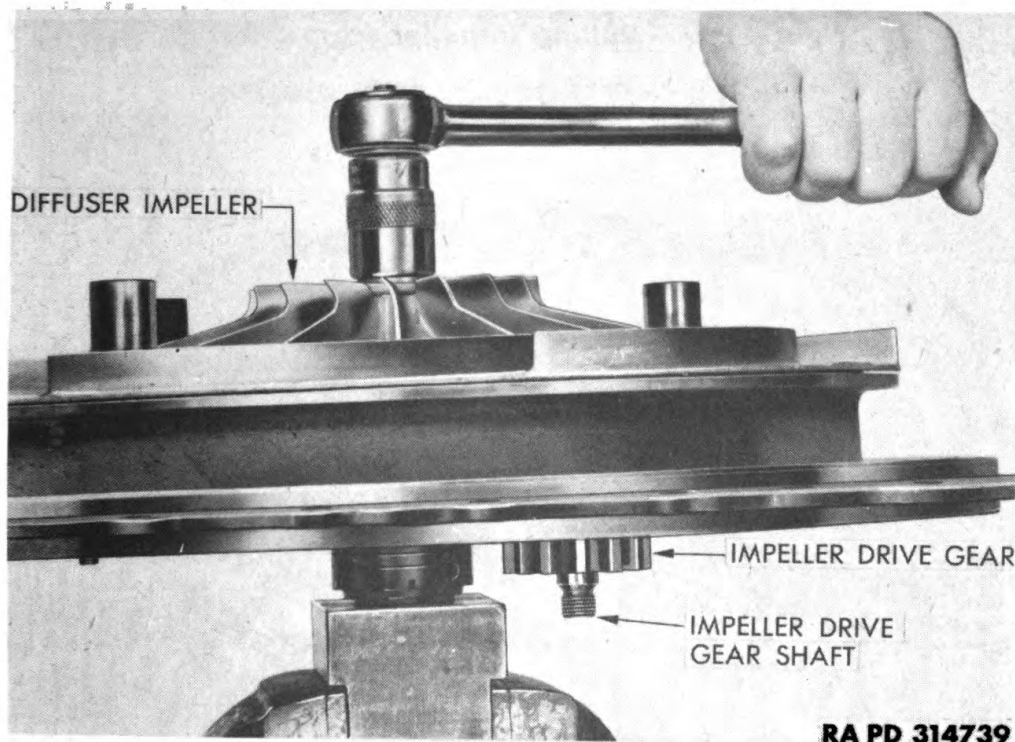
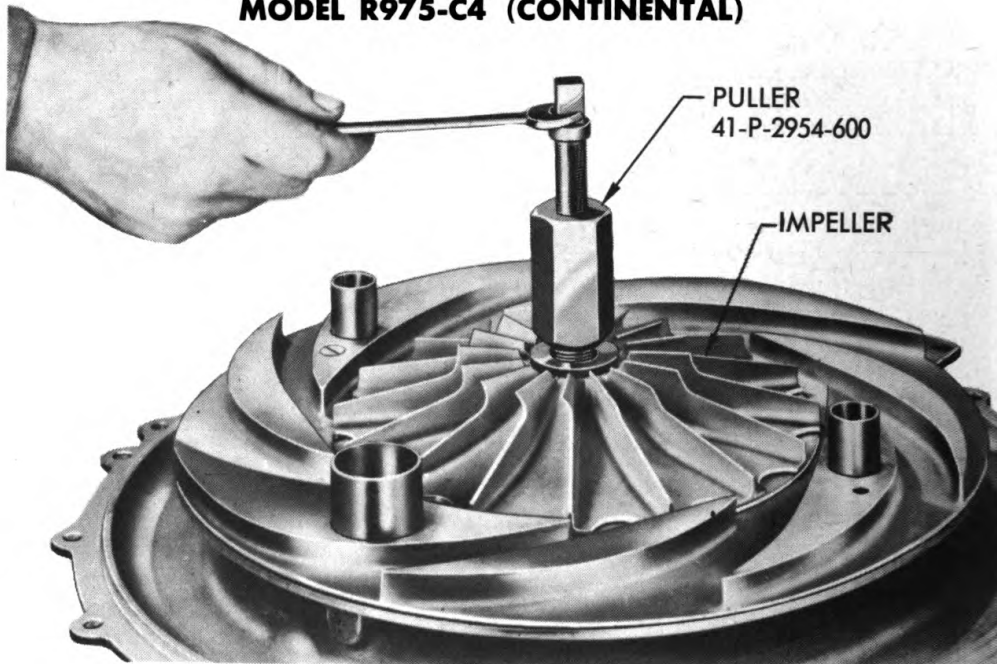

Figure 148 – Removing Impeller Shaft Nut

with fine stone, and polish with crocus cloth. Inspect all studs for tightness and thread condition. Replace any unserviceable part. Idler gear studs are removed by inserting a square drive in stud head and unscrewing studs. Inspect inner surfaces of accessory and starter

**ORDNANCE MAINTENANCE – ORDNANCE ENGINE
MODEL R975-C4 (CONTINENTAL)**



RA PD 314735

Figure 149 – Pulling Impeller from Shaft

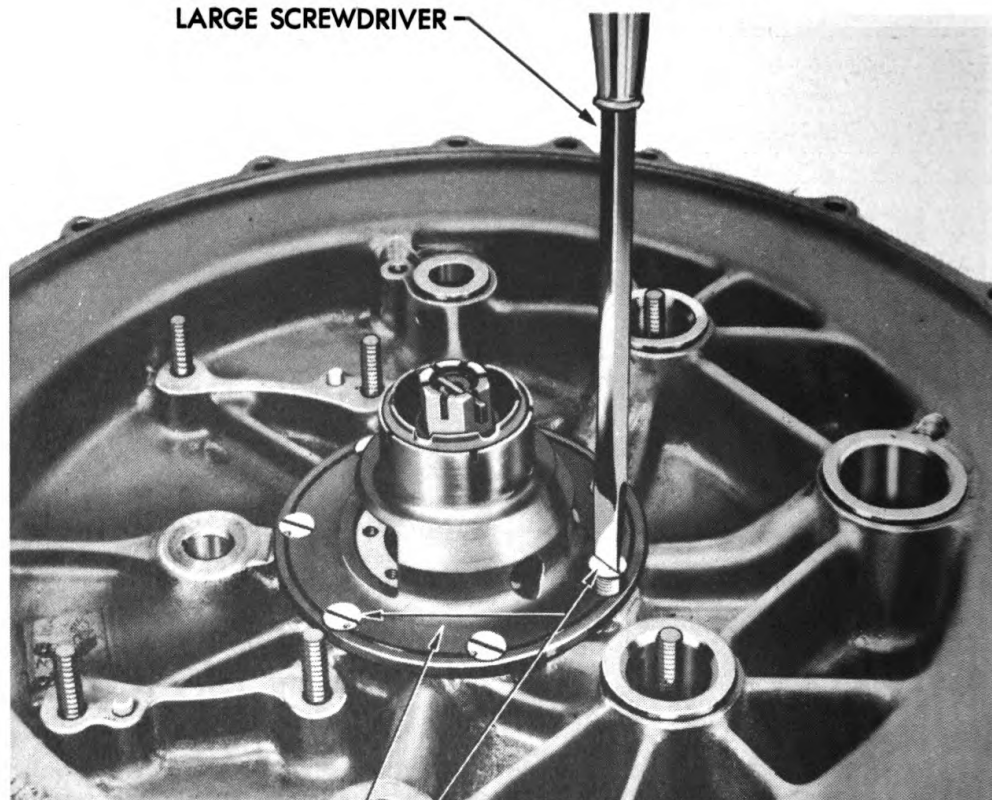

RA PD 314762

Figure 150 – Removing Bearing Cage Retaining Screws

**DISASSEMBLY, CLEANING, INSPECTION, REPAIR, AND
ASSEMBLY OF SUBASSEMBLIES**

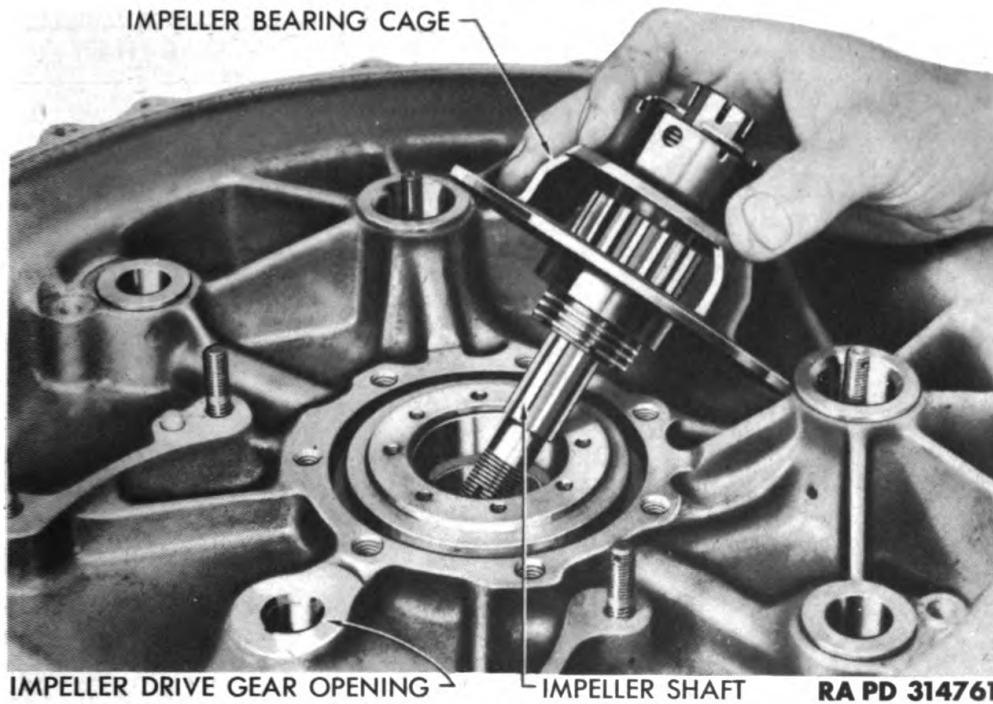

Figure 151 – Removing Bearing Cage

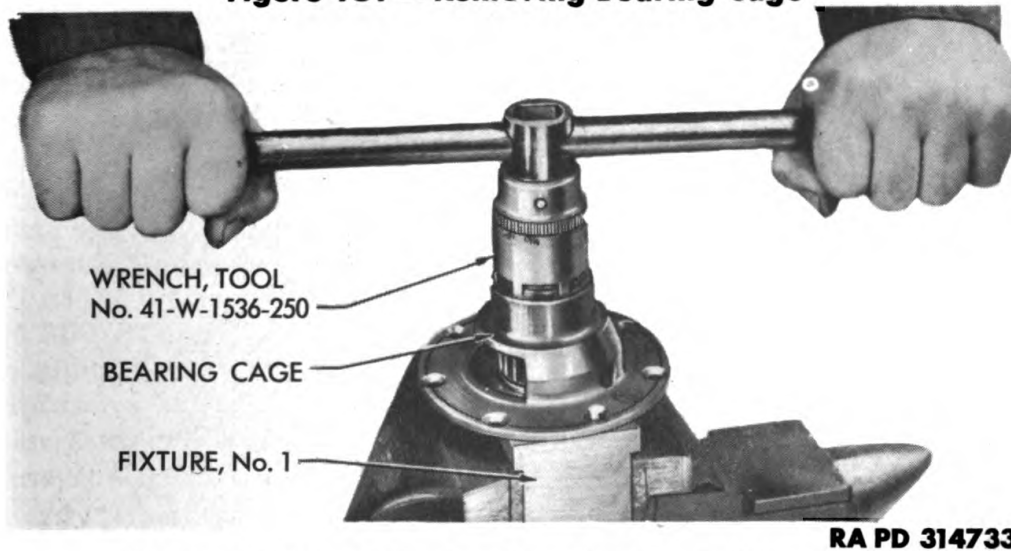

Figure 152 – Removing Impeller Cage Thrust Nut

shaft bushings for smoothness, freedom from scratches and scores, and condition of oil grooves. Check inside diameter of bushings with micrometers or plug gages (fig. 154). If bushings are worn beyond maximum permissible diameters, replace bushings.

The diameter of the starter shaft bushing in the diffuser section should measure between 1.3745 and 1.3755 inches. The accessory

**ORDNANCE MAINTENANCE — ORDNANCE ENGINE
MODEL R975-C4 (CONTINENTAL)**

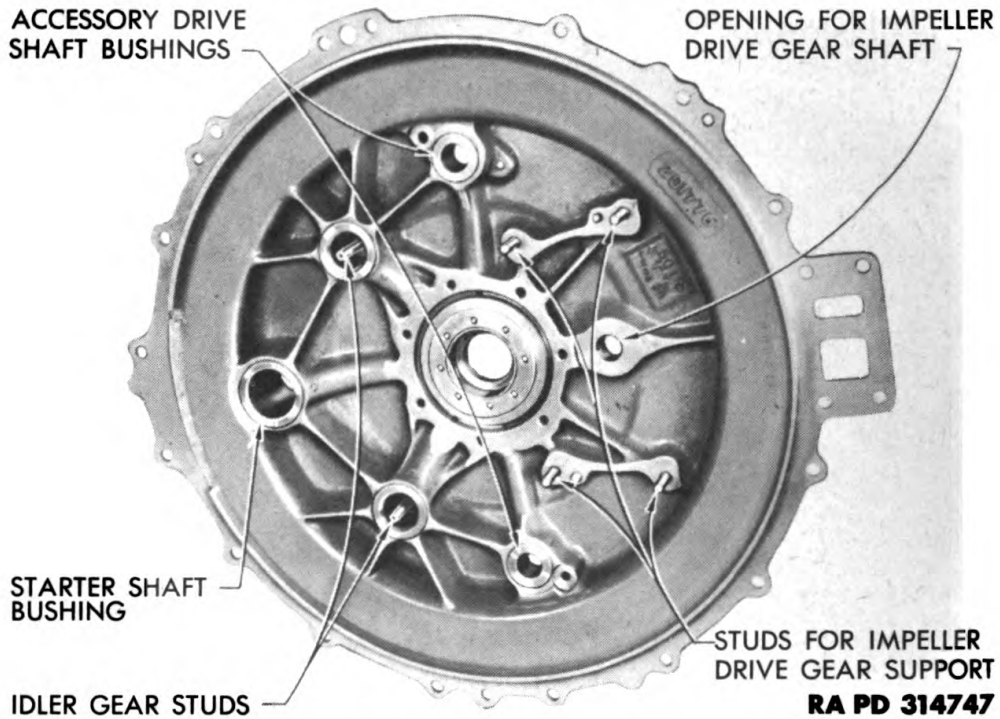

Figure 153 — Diffuser Section with Parts Removed

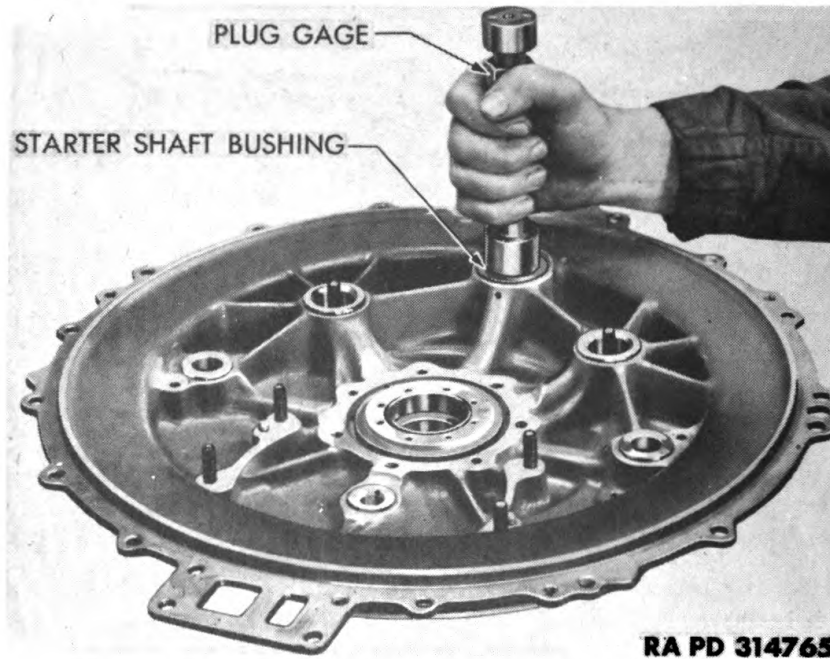

Figure 154 — Checking Starter Shaft Bushing

**DISASSEMBLY, CLEANING, INSPECTION, REPAIR, AND
ASSEMBLY OF SUBASSEMBLIES**

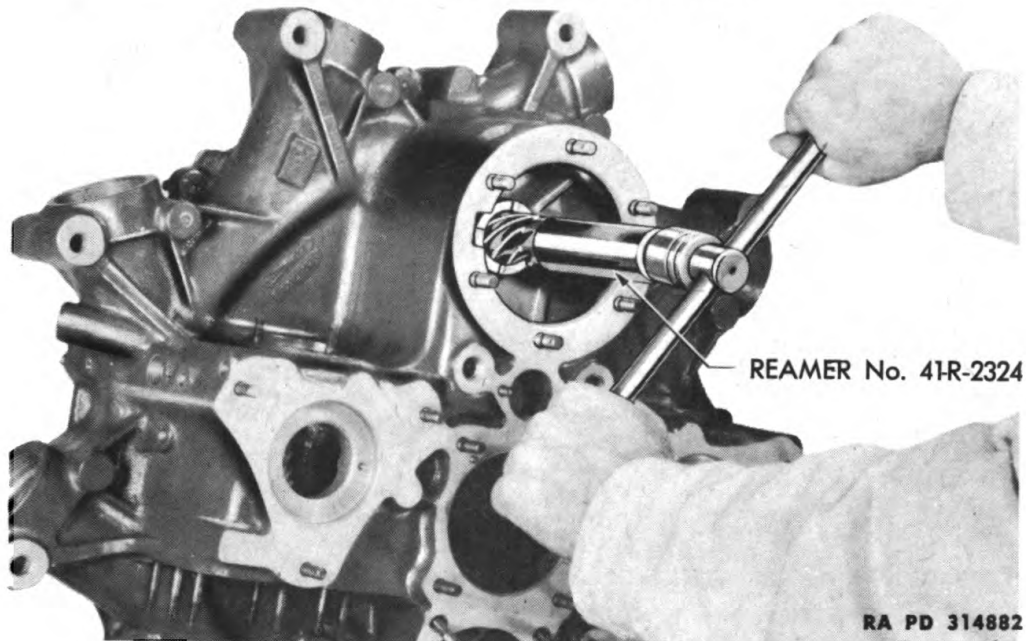

Figure 155 – Line Reaming Starter Shaft Bushings

drive shaft bushings in the diffuser section should measure between 0.7395 and 0.7405 inches.

b. Replace Diffuser Section Bushings.

(1) If bushing in diffuser section is replaced, replace corresponding bushing in rear crankcase section.

(2) **REMOVE STARTER SHAFT BUSHINGS.** Tap out bushing locking pins in both diffuser and rear crankcase sections. Drill out bushings until a shell approximately 0.015 inch thick remains. Break out remaining shells. Clean up bushing bores.

(3) **INSTALL BUSHINGS.** Heat diffuser and rear crankcase sections to 300°F., and shrink replacement bushings. Press new bushings into bushing bores. Make sure bushing flanges bottom against bosses in diffuser and rear crankcase sections. Using pilot on drill, bore locking pin holes. Install locking pins. Drill oilholes through bushings to line up with oil passages.

(4) **REAM BUSHINGS.** Assemble diffuser section to rear crankcase section. Mount sections in vise, and install alining fixture supports (41-F-2987-210) in crankcase sections. Install reamer and alining bar (41-R-2324) through bushing holes, and install alining fixture supports through starter gear opening in rear crankcase section (fig. 155). Line ream bushings to limits specified (subpar. a above). Remove reamer, alining bar, and support fixtures.

(5) **CHECK END CLEARANCE.** Install starter gear and check end clearance of gear. If clearance is less than 0.050 inch, cut bushing end flange to provide end clearance between 0.013 and 0.045 inch

ORDNANCE MAINTENANCE – ORDNANCE ENGINE
MODEL R975-C4 (CONTINENTAL)

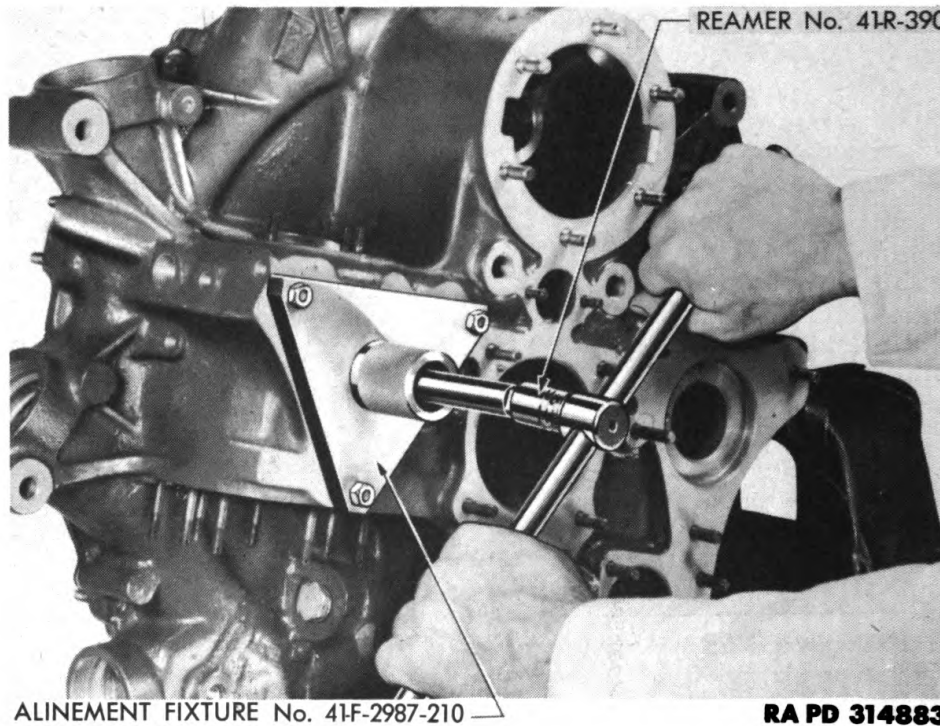

Figure 156 – Line Reaming Accessory Drive Shaft Bushings

loose fit. Remove starter gear. Remove diffuser and rear crankcase sections from vise. Separate cases. Break all sharp edges from bushings, and polish with crocus cloth.

(6) **REPLACE ACCESSORY DRIVE SHAFT BUSHINGS.** Follow the procedure specified (subpar. (1) above), for replacing starter shaft bushings. If either accessory drive shaft bushing in the diffuser or rear crankcase section, is replaced, corresponding bushing in rear crankcase section, or diffuser must be replaced. After bushings are installed, remove headless screw and plug from bushing boss in diffuser section. Screw bushing drill tool into oil pressure passage. Drill oil-hole through bushing. Remove tool and clean holes. Assemble cases; place them in vise covered with soft brass jaws, and line ream bushings to limits specified (subpar. a, above). Attach support fixture (41-F-2987-210) to accessory drive shaft opening in rear crankcase section. Install reamer (41-R-390), and line ream bushings in both crankcase sections. After reaming bushings, remove support fixture, separate cases, break all sharp edges from bushings, and polish with crocus cloth. Bur and clean out oil passages. Install new lead plug and headless screw in bushing boss in diffuser section. Stake screw.

(7) **REPLACE IDLER GEAR BUSHING.** *NOTE: It is seldom necessary to replace idler gear bushings as they are subjected to little wear. Aside from cleaning, they require no servicing.* Screw stud out of

**DISASSEMBLY, CLEANING, INSPECTION, REPAIR, AND
ASSEMBLY OF SUBASSEMBLIES**

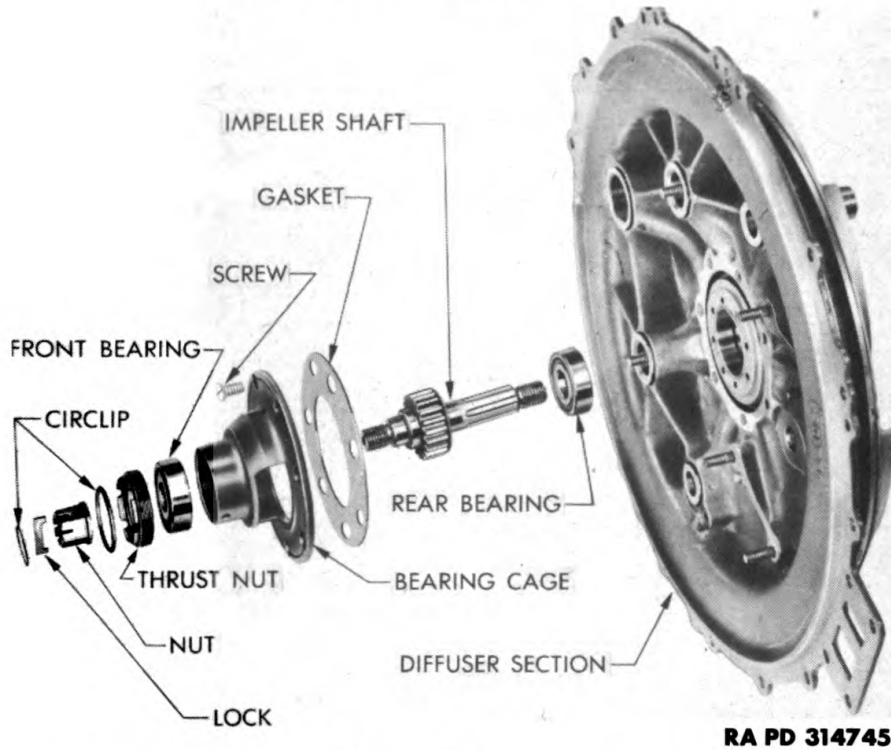

RA PD 314745

Figure 157 – Impeller Bearing Cage – Disassembled

impeller side of diffuser section with square drive. Turn drive bar counterclockwise. Bore out bushing until shell approximately 0.015 inch thick remains. Break out remaining shell and be careful idler gear stud threads are not damaged in the procedure. Clean up bushing bore. Check inside diameter of bore with outside diameter of bushing to be installed. Select fit within prescribed limits of 0.001 to 0.003 inch. Heat diffuser section, and press new bushing into place. Using fixture and reamer, ream bushing, being careful not to strike bottom of bore. The bushing diameter should measure between 0.9995 and 1.0005 inches. Remove reamer and fixture, and break all sharp edges. Apply gasket compound to the head of threads of idler gear stud and replace stud. Tighten stud securely.

c. Diffuser Ring. Inspect diffuser ring (fig. 158) for cracks, burs, or warpage. Remove slight burs with fine stone. Replace cracked or warped ring.

d. Impeller. Check impeller on a surface plate for warpage. Inspect it also for bent or broken blades, or other indications of damage (fig. 158). Inspect condition of splines. Replace impeller if damage is found.

e. Oil Seal Cage. (fig. 158). Inspect inside diameter of cone very closely for scores, scratches, or any indication of roughness. Check

ORDNANCE MAINTENANCE – ORDNANCE ENGINE
MODEL R975-C4 (CONTINENTAL)

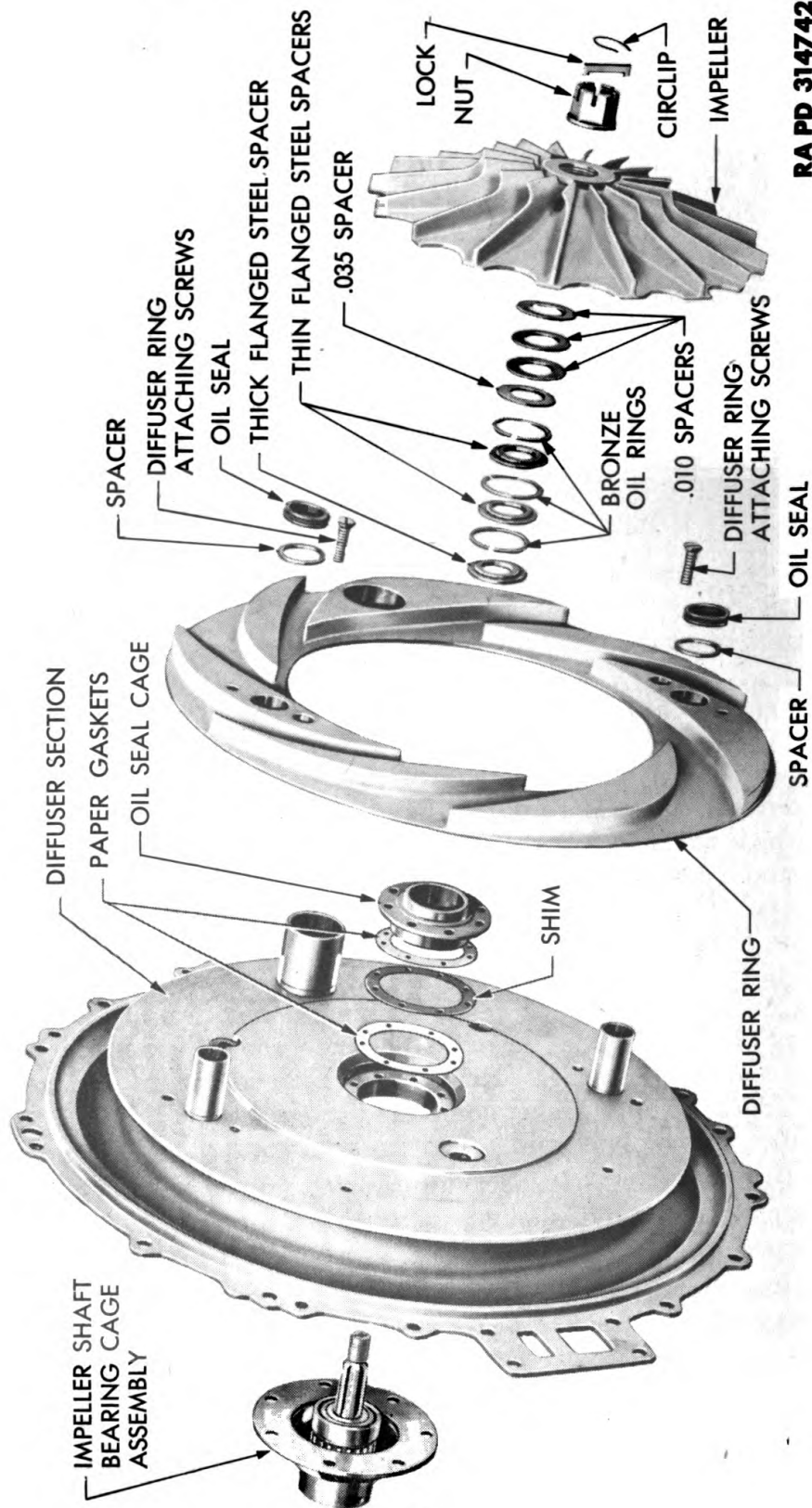

RA PD 314742

Figure 158 — Impeller, Diffuser Ring, and Oil Cage — Disassembled

**DISASSEMBLY, CLEANING, INSPECTION, REPAIR, AND
ASSEMBLY OF SUBASSEMBLIES**

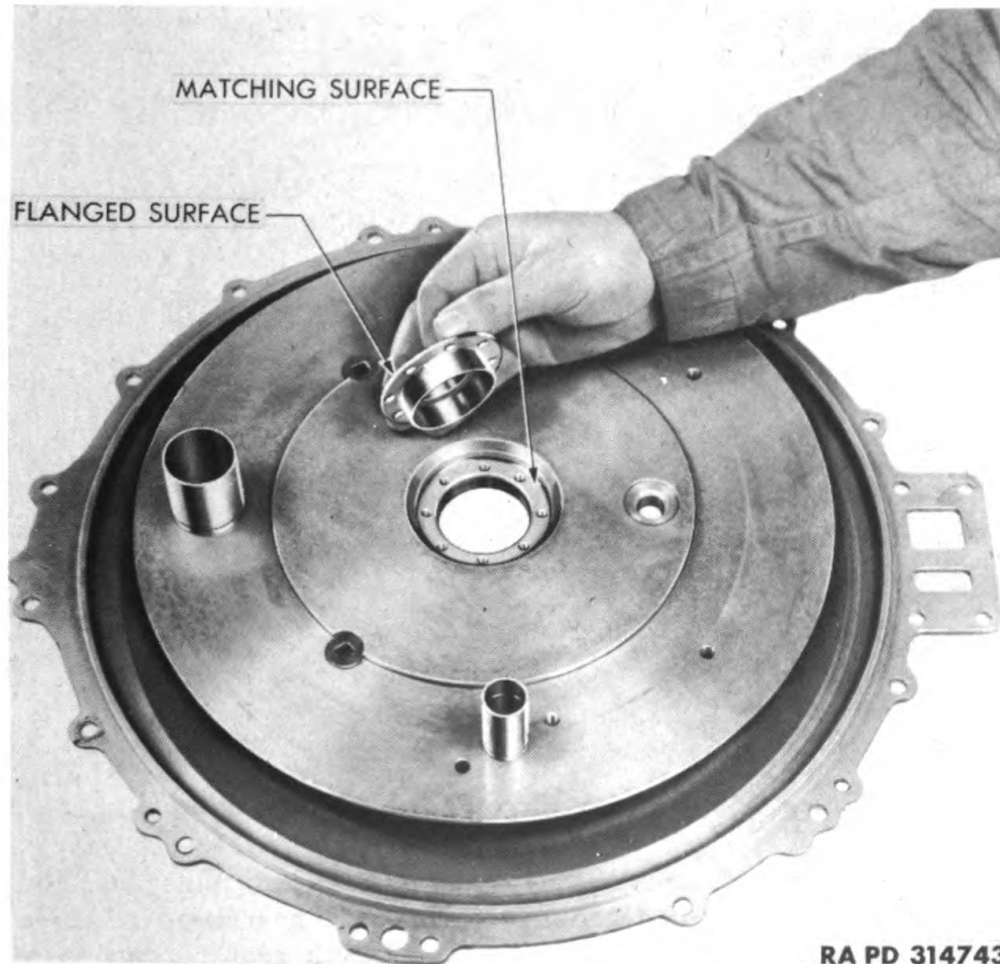

RA PD 314743

Figure 159 – Oil Seal Cage Flange

outside diameter and flange surfaces for smoothness. Check for evidence of oil seal ring wear and scoring on smallest inside diameter. Replace cage if any surface is found to be damaged.

f. **Impeller Shaft Assembly** (fig. 157). Clean bearings thoroughly in dry-cleaning solvent. Dry them with compressed air blown through the races, but be careful not to spin bearing races. Oil bearings, and rotate them by hand to check for flat spots, roughness, or damage. Replace bearings if damaged. Inspect shaft and gear assembly by the magnaflux method for cracks, for condition of splines, threads, and gear teeth. Replace shaft and gear assembly if any damage is apparent. Inspect bearing cage for cracks or other evidence of damage. Inspect condition of thrust nut. Replace any unserviceable parts.

g. **Impeller Drive Gear Assembly** (fig. 163). Inspect drive gear support for cracks and for general condition. Inspect shaft for scores,

**ORDNANCE MAINTENANCE — ORDNANCE ENGINE
MODEL R975-C4 (CONTINENTAL)**

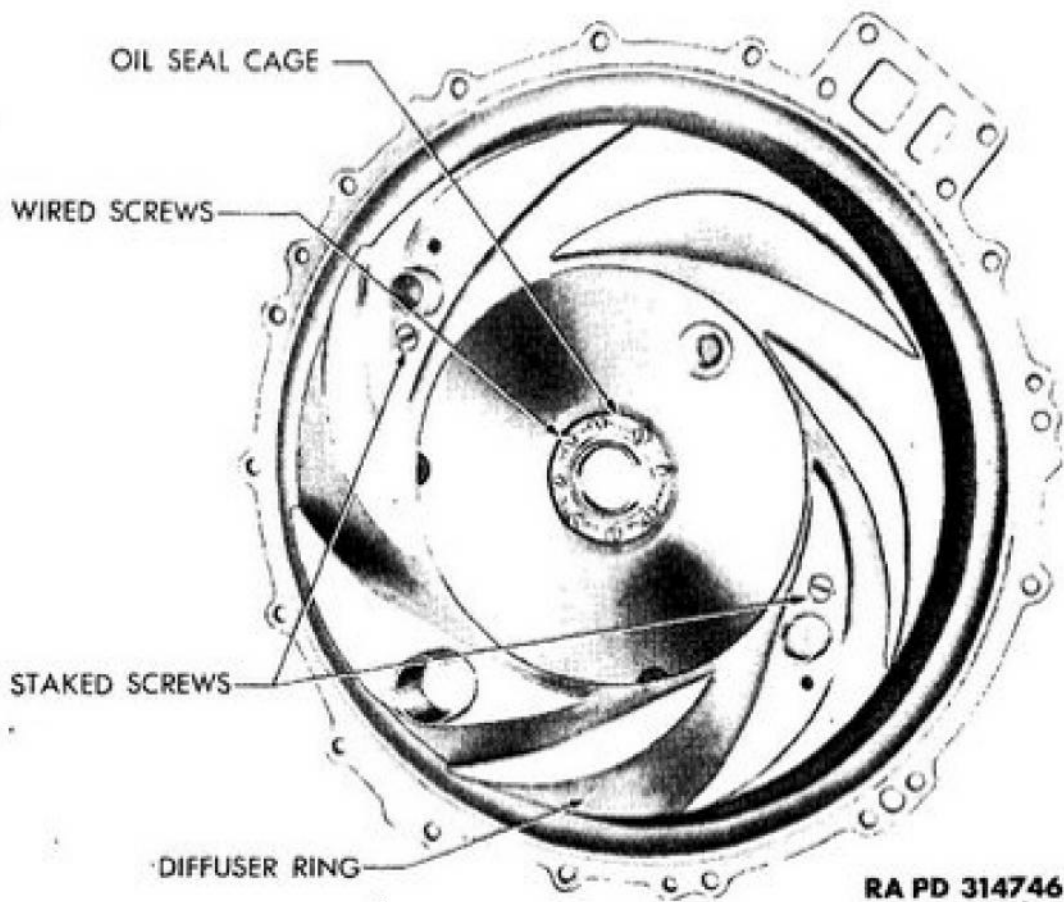

Figure 160 — Staked Screws for Diffuser Ring

burs, or out-of-round condition. Inspect gear by magnaflux method for broken, worn, or damaged teeth. Replace gear support, drive shaft, or gear, if they are unserviceable. Check gear bushing very carefully for scores, scratches, burs, or roughness, and for good condition of oil grooves. If any of these conditions exist, replace gear. Measure inside diameter with telescopic micrometer. If inside diameter is worn beyond permissible limits, replace gear. The diameter should be between 1.1250 and 1.1255 inches. Inspect bearing journal very carefully for scores, scratches, roughness, wear, or out-of-round condition. Replace bearing if any of these conditions are found. Check bearing diameter with micrometer. If diameter exceeds allowable limits (Table of Limits) replace bearing. Diameter should measure between 1.220 and 1.1215 inches.

h. Idler Gear Assembly (fig. 144). Inspect idler gear by magnaflux method for broken, cracked, or worn teeth. Inspect thrust washers for scores, burs, roughness, or wear. Replace any unserviceable parts.

i. Accessory Drive Gears. Inspect gears by magnaflux method for cracks, broken teeth, scores, or wear. Replace gears if any unserviceable parts are found.

ASSEMBLY, CLEANING, INSPECTION, REPAIR, AND
ASSEMBLY OF SUBASSEMBLIES



RA PD 314741

Figure 161 - Installing Lock in Impeller Drive Shaft

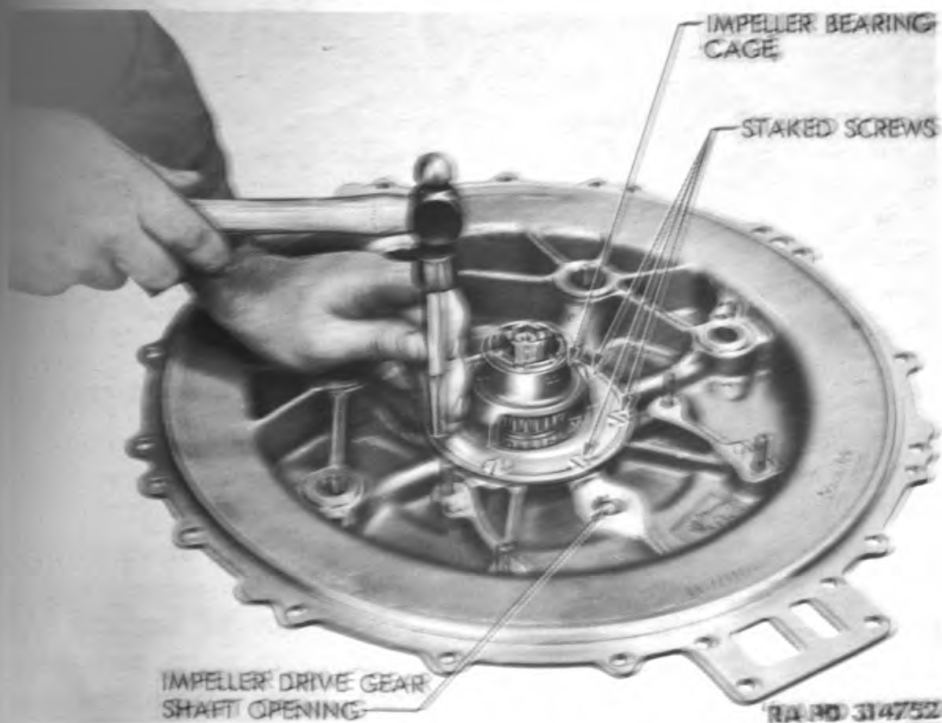

RA PD 314752

Staking Impeller Bearing Cage Screws

**ORDNANCE MAINTENANCE – ORDNANCE ENGINE
MODEL R975-C4 (CONTINENTAL)**

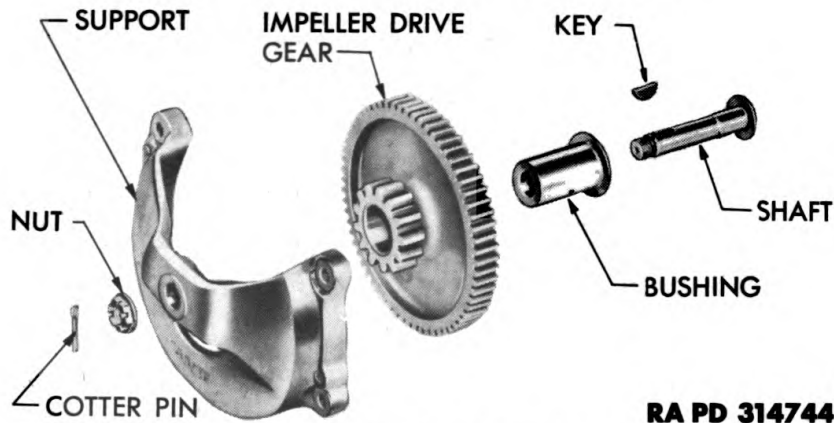

RA PD 314744

Figure 163 – Impeller Drive Gear – Disassembled

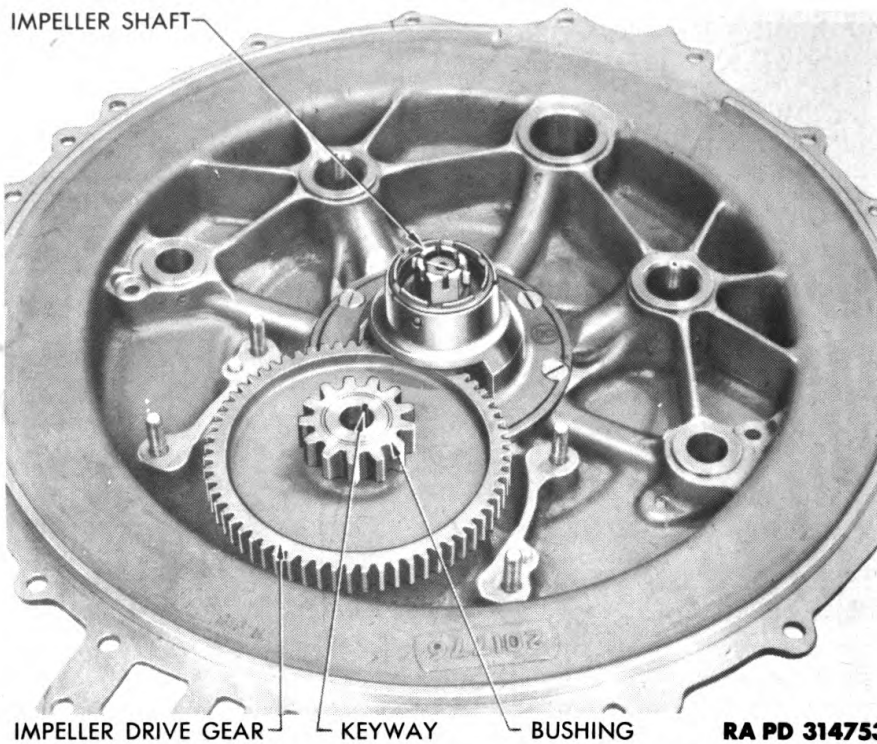

RA PD 314753

Figure 164 – Positioning Impeller Drive Gear

44. ASSEMBLY.

a. **Install Oil Seal Cage.** Lap the flanged surface on cage to the matching surface on the diffuser section to insure a perfect contact between the two surfaces (fig. 159). Make sure all lapping compound is removed after this operation. Install in order, new paper gasket, copper shim, another new paper gasket, then the cage (fig. 158). Mounting holes for installing these parts are unequally spaced to insure correct installation. Install and tighten eight attach-

**DISASSEMBLY, CLEANING, INSPECTION, REPAIR, AND
ASSEMBLY OF SUBASSEMBLIES**

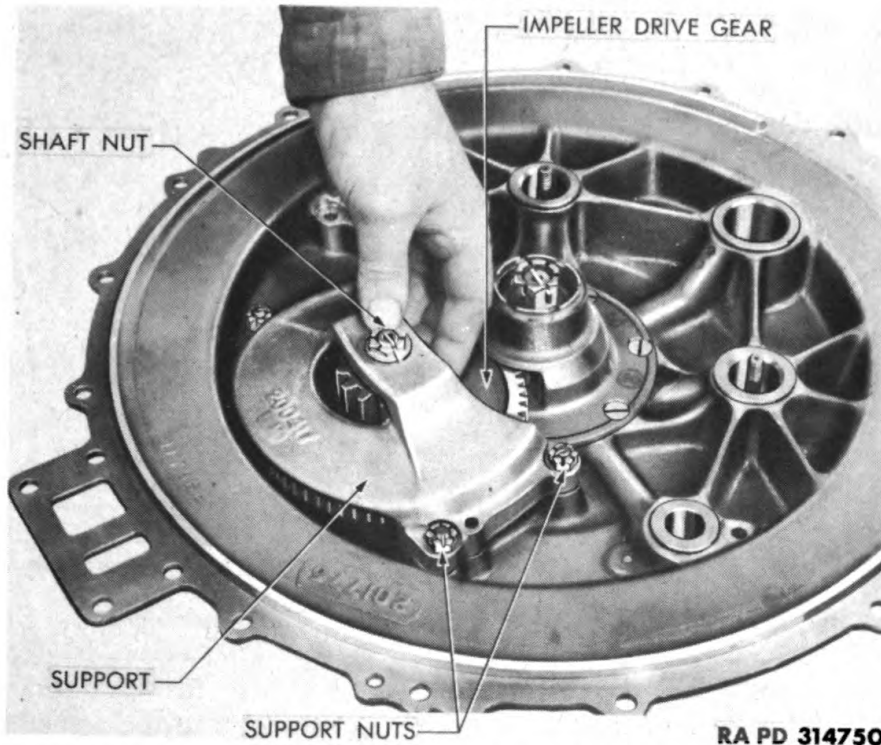
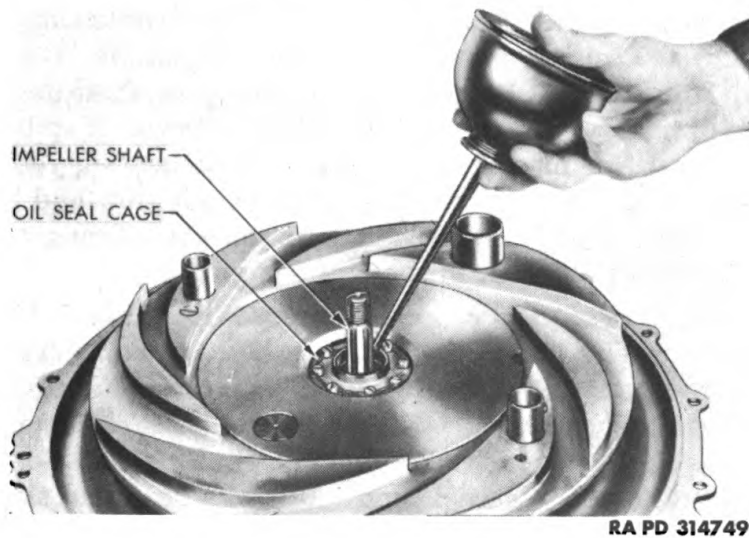

Figure 165 – Checking End Play in Impeller Drive Gear Shaft



**Figure 166 – Oiling Between Impeller Drive Shaft and
Oil Seal Cage**

ing screws. Wire them together in groups of three, three, and two (fig. 160).

b. Install Diffuser Ring. Slide diffuser ring in place over bushings in diffuser section. Be sure that the ring is installed all the

**ORDNANCE MAINTENANCE — ORDNANCE ENGINE
MODEL R975-C4 (CONTINENTAL)**

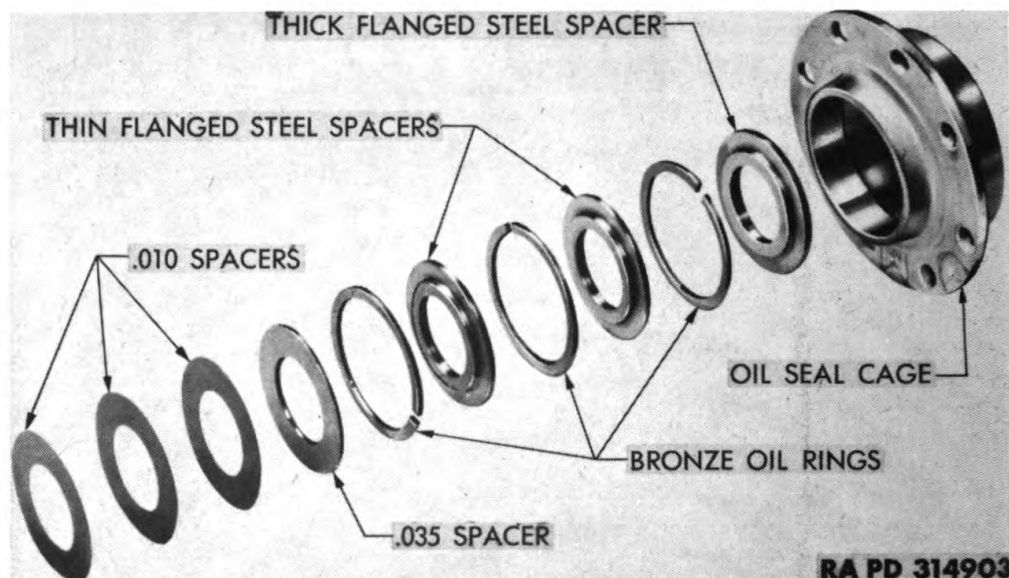

Figure 167 — Oil Seal Rings — Disassembled

way, and makes good contact with diffuser section. Install and tighten two mounting screws, and stake the ring to the slot in the screws.

c. **Assemble Impeller Bearing Cage.** Using an arbor press, press impeller bearing on splined end of impeller shaft. Place side marked "GEAR SIDE" towards gear (fig. 157). Place shaft with bearing in bearing cage. Position assembly in fixture block No. 1 with splined end of shaft in fixture. Place upper bearing over shaft and into cage. Place end of bearing marked "GEAR SIDE", down. Tap bearing into place with soft hammer if necessary. Install bearing retaining nut, and tighten with special wrench. Install shaft nut, and tighten securely to 1,100 to 1,200 inch-pounds of torque. Using tool (41-T-3217-100), install old lock in shaft nut (fig. 161).

d. **Install Bearing Cage.** Place diffuser section in fixture with front side of section up. Using a new gasket, position cage and gear assembly over gasket on front side of diffuser section. Have gear teeth opening in cage face impeller drive gear shaft opening (fig. 162). Install seven slotted screws that hold cage to diffuser section. Tighten screws securely with screwdriver. Stake screws to slot in cage (fig. 162).

e. **Install Impeller Drive Gear** (fig. 163). Lubricate all parts thoroughly before assembling. Place bearing in impeller drive gear (flanged side down). Position gear and bearing over shaft opening, with keyway pointed exactly toward impeller shaft (fig. 164). Push shaft up from under side of diffuser section. Line up shaft keyway with bearing keyway. Place key in position in two keyways. Put support over gear and shaft, making sure that shaft and journal are

**DISASSEMBLY, CLEANING, INSPECTION, REPAIR, AND
ASSEMBLY OF SUBASSEMBLIES**

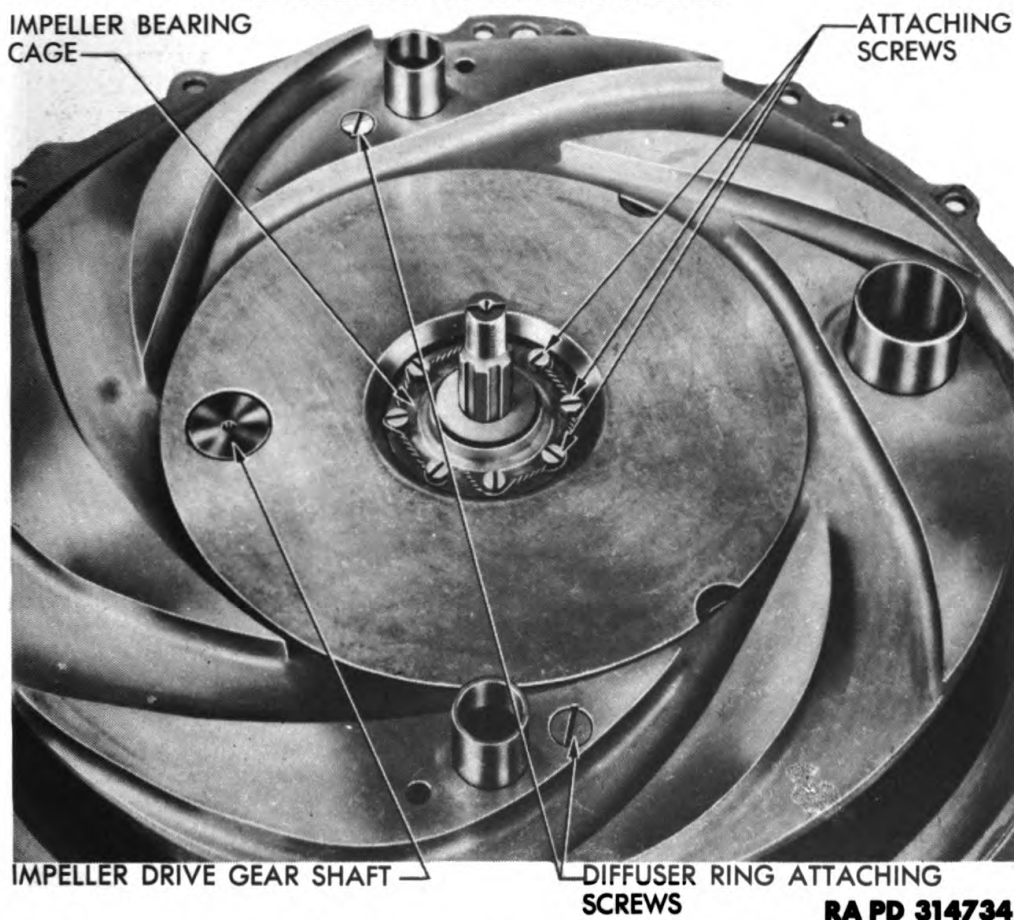
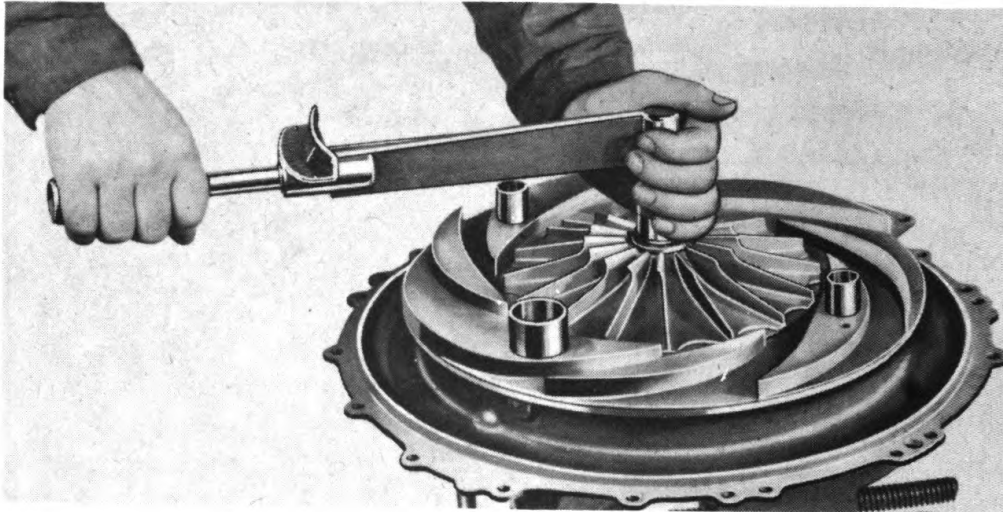

Figure 168 – Diffuser Section with Oil Rings Installed

positioned so that key enters support keyway. Do not drive support into place. Install shaft nut on end of shaft. Tighten nut finger-tight. Install four washers and nuts on studs that hold support to diffuser section. Tighten shaft nut to 1,100 to 1,200 inch-pounds of torque. Check gear operation by rotating gear through one complete revolution. The gear must run freely. If the gear does not operate freely, it indicates improper assembly of impeller shaft, damaged bushings, or improperly machined bushings. If gear does not operate freely, disassemble impeller gear drive and inspect bushings. Replace damaged or improperly machined bushings. Reassemble gear drive. Again check gear operation. If it does not operate freely, and proper assembly has been made, remove and replace the assembly. When a check of the gear operation shows that the gear is operating freely, raise the gear with your fingers to see that it has slight end play (fig. 165). When assembly is complete, tighten and secure the four nuts on the diffuser section studs with cotter pins. Put a cotter pin through nut on end of impeller shaft and fasten it securely.

**ORDNANCE MAINTENANCE – ORDNANCE ENGINE
MODEL R975-C4 (CONTINENTAL)**



RA PD 314764

Figure 169 – Tightening Impeller Retaining Nut Using Wrench 41-W-3631

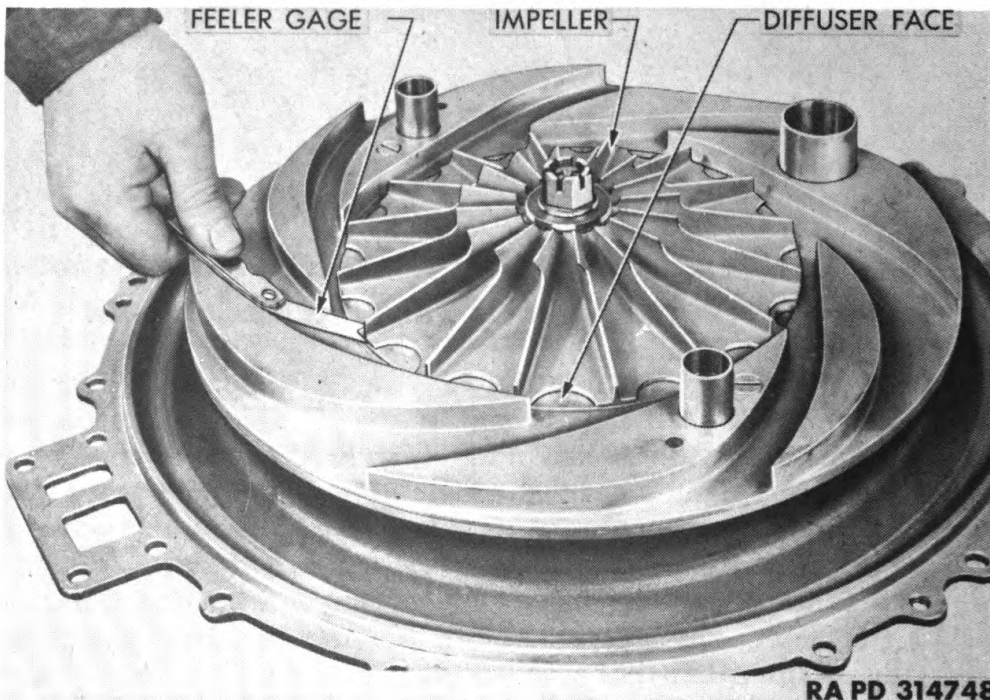

RA PD 314748

Figure 170 – Checking Impeller End Play Using Gage 41-G-400

f. **Install Oil Rings.** Place diffuser section with impeller side up in special mounting block No. 2. Squirt a liberal amount of engine oil between impeller drive shaft and oil seal cage (fig. 166). Install thick-flanged steel spacer with large diameter down, over shaft and in oil cage (fig. 167). Next, install, in order, over shaft, new bronze oil ring, thin-flanged steel spacer with large diameter down, another

**DISASSEMBLY, CLEANING, INSPECTION, REPAIR, AND
ASSEMBLY OF SUBASSEMBLIES**

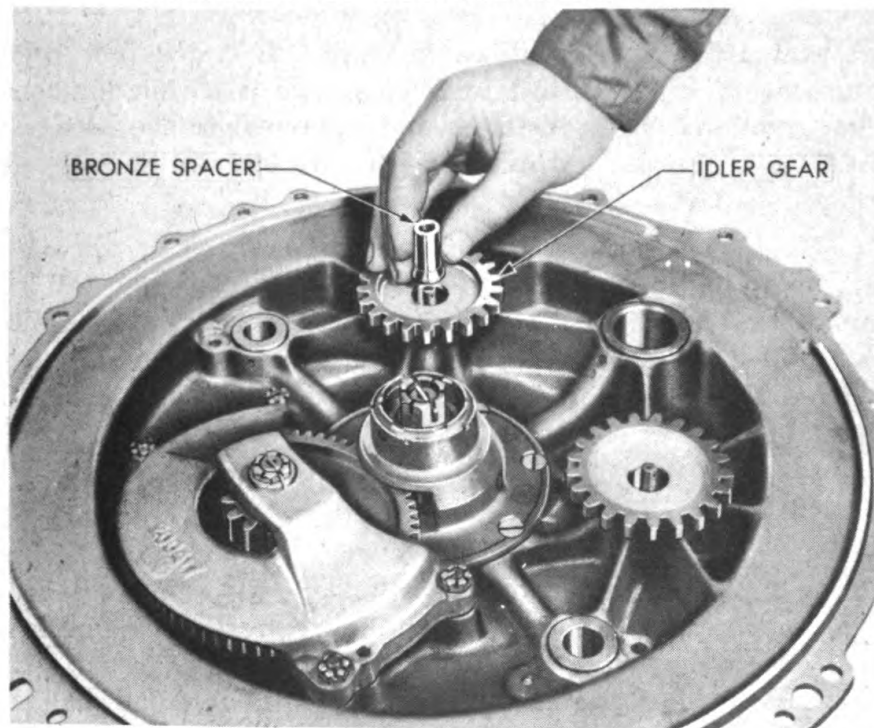

RA PD 314751

Figure 171 – Installing Idler Gear Spacer

new bronze oil ring, a second thin-flanged steel spacer with large diameter down, a third bronze oil ring, and finally, a plain flat washer (0.035 inch thick), and the same number of 0.010-inch spacers as were removed in disassembly. Figure 168 shows diffuser section with oil rings installed.

g. Install Impeller. Slide impeller down over splined end of shaft. Tap impeller down as close as possible to hub with soft hammer. Install retaining nut, and tighten it from 1,100 to 1,200 inch-pounds of torque (fig. 169).

h. Check Impeller Clearance. With feeler gage (fig. 170), check clearance between face of impeller and face of diffuser section at several points around the circumferences. Clearance should be between 0.020 and 0.030 inch. If clearance is greater than 0.030 inch, remove a sufficient number of 0.010-inch shims from the impeller shaft to bring the clearance within the prescribed limits. If the clearance is less than 0.020 inch, install the necessary number of 0.010-inch shims to the impeller shaft to bring the clearance within the prescribed limits. To change the number of shims on impeller shaft, remove shaft nut, pull impeller from shaft, and change the number of shims as required. Reinstall impeller and shaft nut. Tighten nut to from 1,100 to 1,200 inch-pounds of torque. Recheck clearance to make

**ORDNANCE MAINTENANCE — ORDNANCE ENGINE
MODEL R975-C4 (CONTINENTAL)**

sure that it falls within allowable limits. If it does not, repeat procedure again, and readjust until clearance is within limits, and impeller retaining nut is installed and tightened to the proper tension. Install lock in shaft and nut slot. Secure lock in place by installing circlip in nut (fig. 158).

i. Replace Lock at Rear of Impeller Shaft. Lift diffuser section from mounting block, and with impeller side down, reinstall in fixture. Remove old lock from nut at bearing cage end of impeller shaft. Install new lock (fig. 161) using a special tool. The old lock will be battered by the force applied when the impeller was installed. Install new circlip in nut (fig. 157).

j. Install Idler Gears. Lubricate idler gears and bushings. Install inner spacer over idler gear stud. Then, in order, install gear, long bronze spacer with bell end down (fig. 171), flat washer, nut, and cotter pin. Install other idler gear in same way. With fingers, check gears for perceptible end play and for free rotation. Check impeller drive and idler gears for end play with feeler gage set. End play for accessory idler gears should be from 0.011 to 0.050 inch. If gears do not have the proper amount of end play, and/or, do not rotate freely, check idler gear studs to make sure they have been driven to the proper depth. Check the spacer under the idler gear to make sure the correct spacer has been used. When proper adjustments have been obtained, place diffuser section assembly on bench. Cover assembly for protection from dirt and dust until ready to reinstall in engine.

Section X

REAR CRANKCASE SECTION

| | Paragraph |
|-----------------------------|------------------|
| Disassembly | 45 |
| Cleaning | 46 |
| Inspection and repair | 47 |
| Assembly | 48 |

45. DISASSEMBLY.

a. Remove Cover Plates. Remove two nuts tightened finger-tight, and remove cover plates installed on starter and generator openings when starter and generator were removed (fig. 35).

b. Remove Carburetor Elbow. Cut and remove safety wires from four nuts securing carburetor inlet elbow to rear crankcase section

**DISASSEMBLY, CLEANING, INSPECTION, REPAIR, AND
ASSEMBLY OF SUBASSEMBLIES**

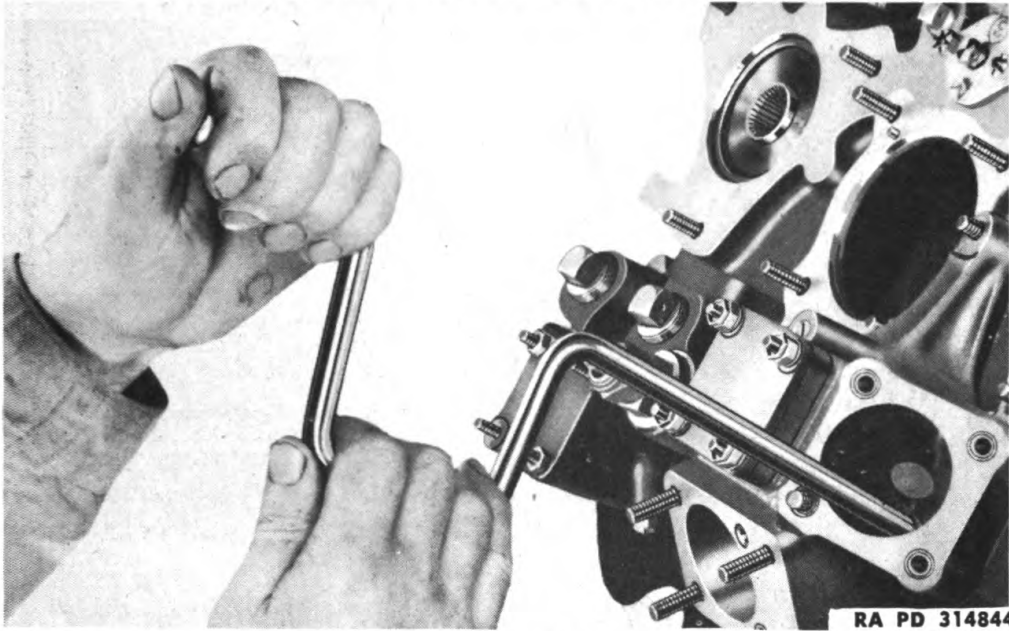

**Figure 172 – Removing Retaining Nuts from Inside of
Three-way Drive Housing**

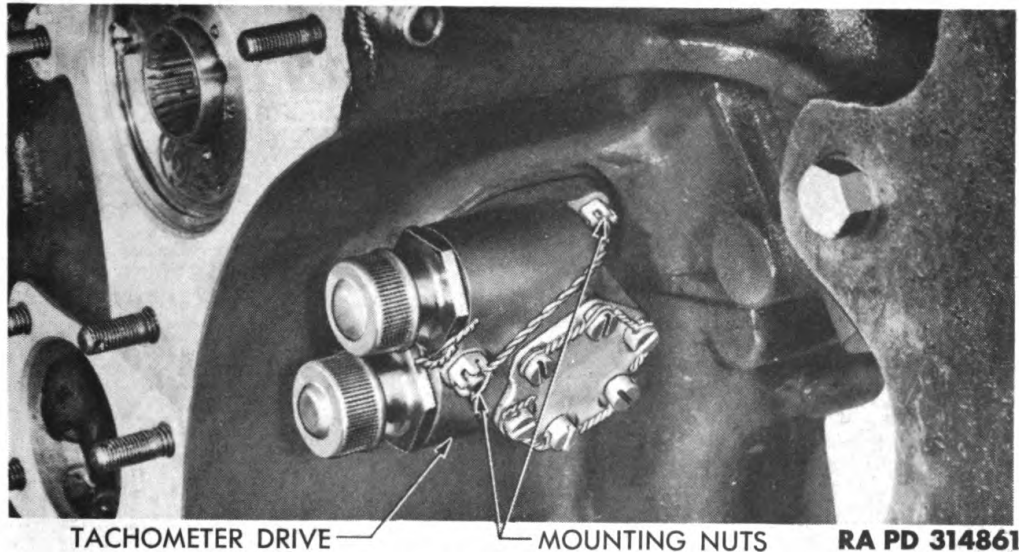
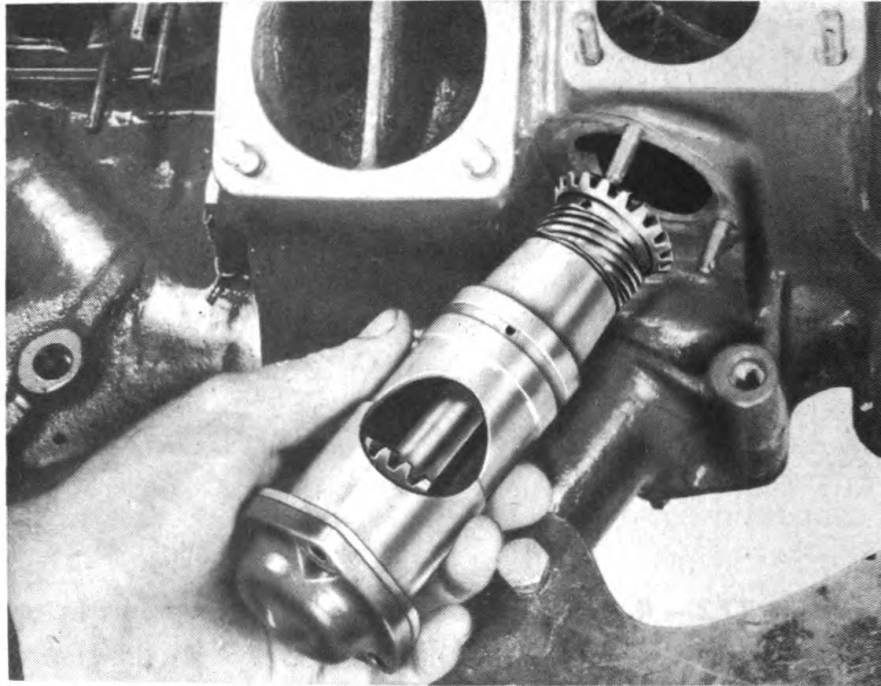

Figure 173 – Tachometer Drive Mounting

(fig. 35). Remove nuts and flat washers from mounting studs, and lift elbow off studs.

c. Remove Three-way Accessory Drive Housing. Cut and remove safety wires from nuts holding right cover on three-way drive housing (fig. 35). Remove four nuts and take off cover from studs. Remove cotter pins from two retaining nuts inside three-way drive housing. Remove nuts (fig. 172). Cut and remove safety wires

**ORDNANCE MAINTENANCE – ORDNANCE ENGINE
MODEL R975-C4 (CONTINENTAL)**



RA PD 314846

**Figure 174 – Removing Tachometer and Three-way
Accessory Drive**

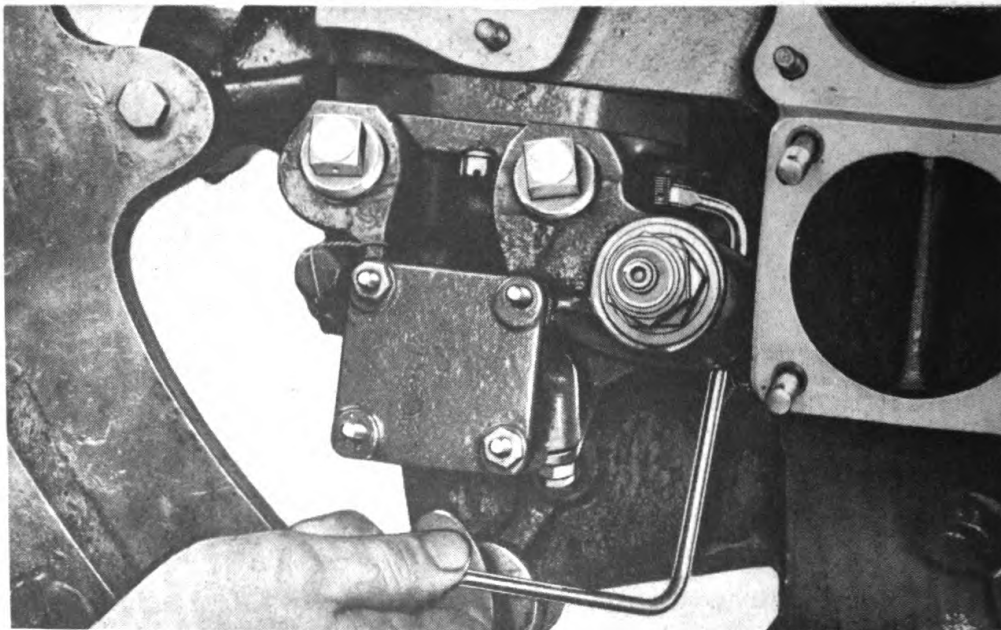

RA PD 314831

**Figure 175 – Removing Oil Pump Attaching Nuts Using
Wrench 41-W-1577-500**

**DISASSEMBLY, CLEANING, INSPECTION, REPAIR, AND
ASSEMBLY OF SUBASSEMBLIES**

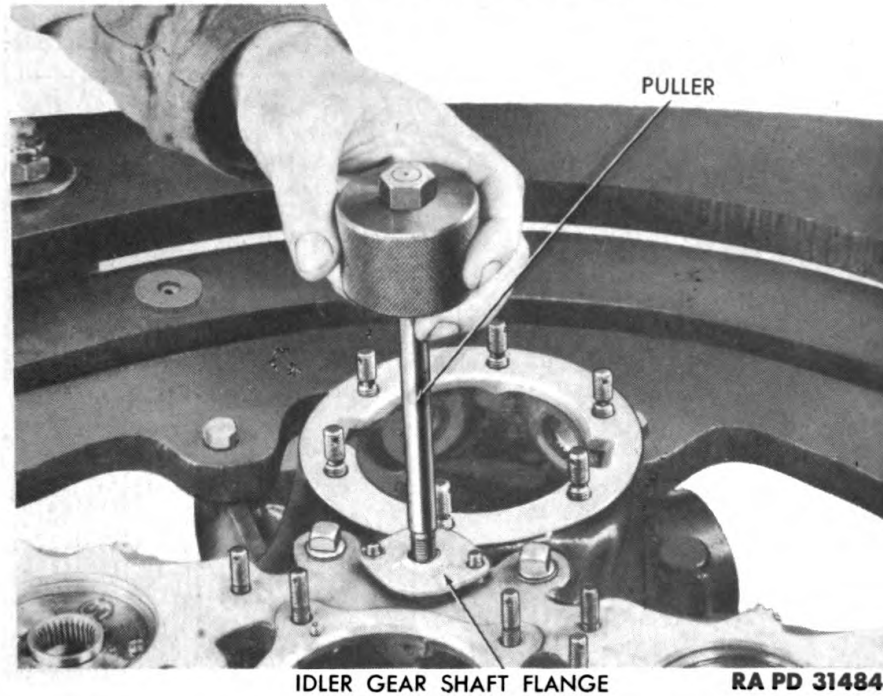

Figure 176 – Pulling Generator Idler Gear Shaft

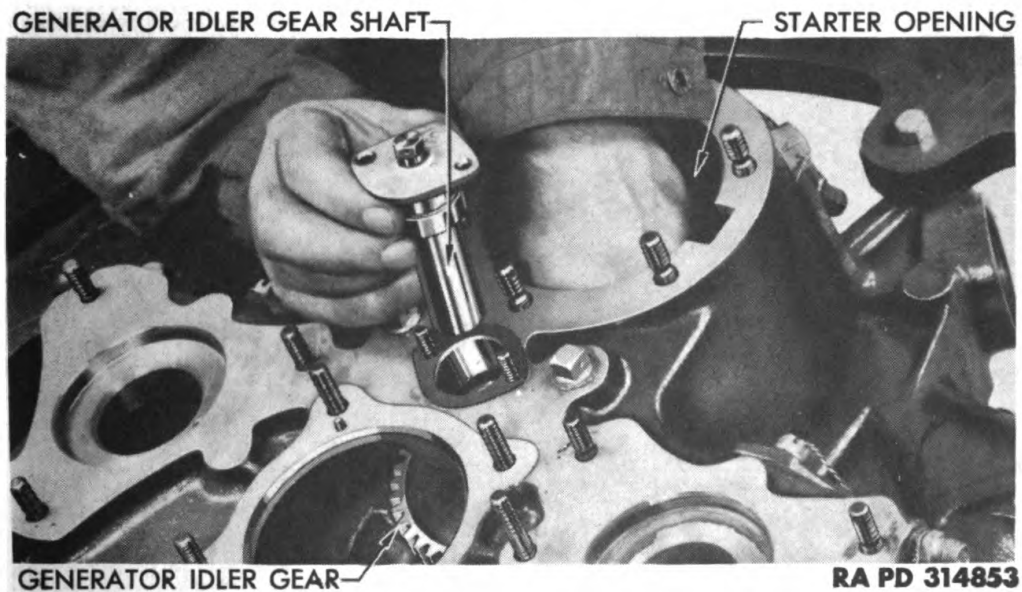
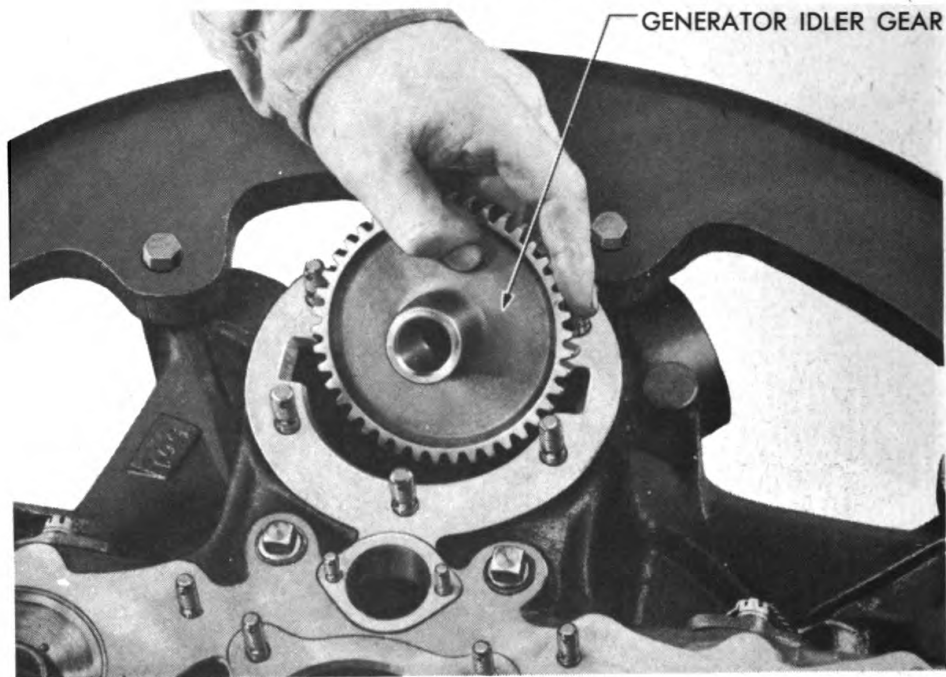

Figure 177 – Removing Generator Idler Gear Shaft

from three external mounting nuts which attach three-way housing to crankcase. Remove nuts and flat washers, and lift off three-way housing from crankcase studs. Pull three-way accessory drive gear from vacuum and fuel pump drive shaft in three-way housing.

ORDNANCE MAINTENANCE – ORDNANCE ENGINE
MODEL R975-C4 (CONTINENTAL)



RA PD 314848

Figure 178 – Removing Generator Idler Gear

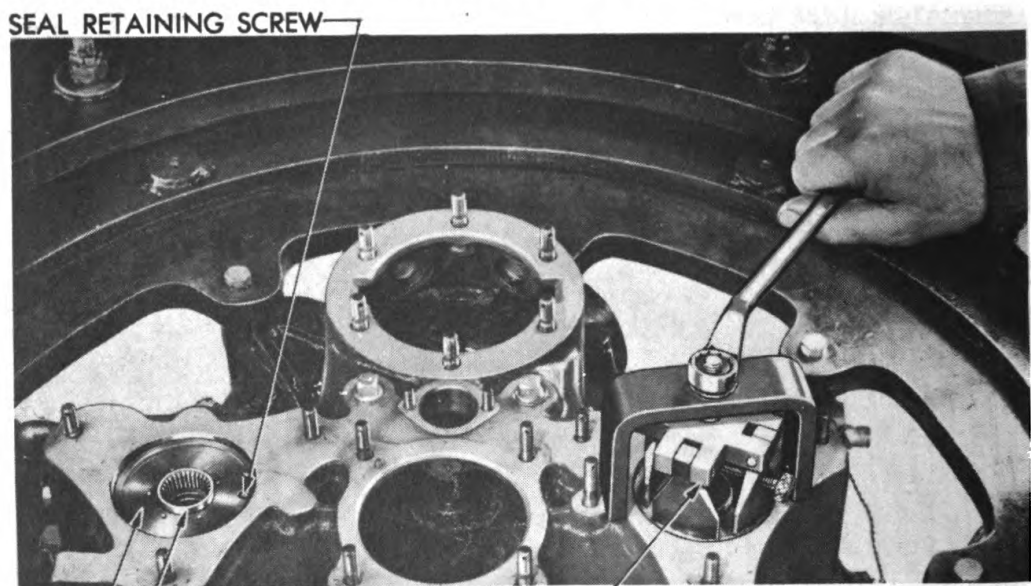

RA PD 314857

Figure 179 – Removing Magneto Drive Oil Seals

d. Remove Tachometer Drive Assembly. Cut and remove safety wires from three nuts holding tachometer drive assembly to rear crankcase section. Remove nuts and flat washers. Pull assembly

**DISASSEMBLY, CLEANING, INSPECTION, REPAIR, AND
ASSEMBLY OF SUBASSEMBLIES**

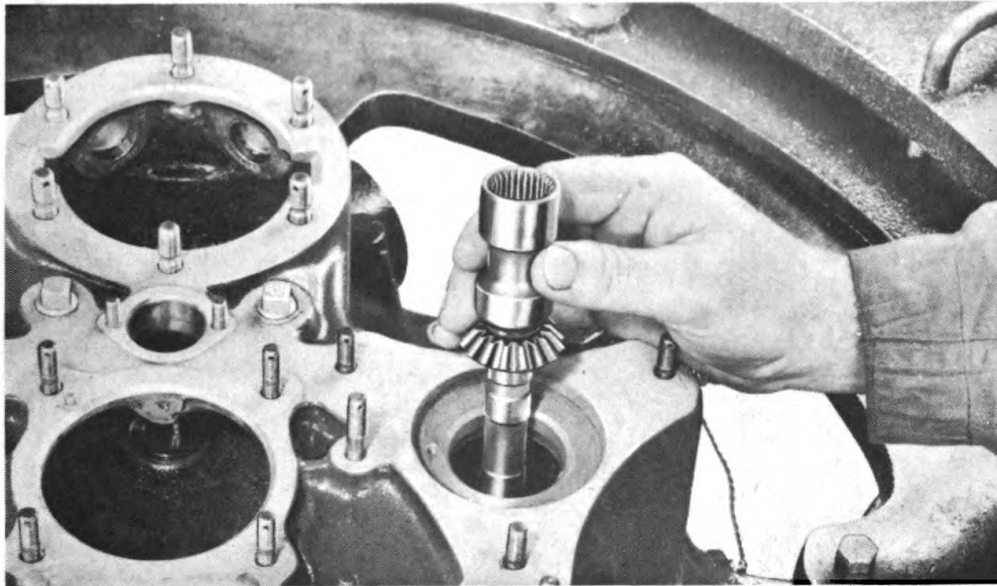

RA PD 314847

Figure 180 – Removing Accessory Drive Shaft

straight off studs. Do not remove six screws holding tachometer drive side cover in place.

e. Remove Tachometer and Three-way Accessory Drive. Cut and remove safety wires from three nuts holding drive gear assembly to rear crankcase section. Remove nuts and flat washers. Remove drive gear assembly from crankcase (fig. 174). If necessary, place wood block on gear, and drive the assembly from crankcase through opening.

f. Remove Oil Pump. Remove safety wires from five nuts, and remove cotter pins from the remaining three nuts. Remove the eight oil pump attaching nuts. Use special wrench (41-W-1577-500) to remove several of these nuts (fig. 175). Remove pump by pulling it straight off studs. Pump drive gear comes off with the pump. Remove gear from pump at once to avoid dropping it.

g. Remove Generator Idler Gear. Cut and remove safety wires from plugs and from nuts on idler gear shaft flange. Remove nuts from studs. Remove plug from center of flange and insert puller. Pull shaft from crankcase by sliding weight on puller (fig. 176). Reach in through starter opening, remove shaft (fig. 177), and pull gear through opening, lining up edges of gear with slots in opening (fig. 178).

h. Remove Accessory Drive Shafts. Remove retaining screws which hold the magneto drive oil seals in position in rear crankcase section. Install puller (41-P-2951-11) on one of the seals. Hook

ORDNANCE MAINTENANCE – ORDNANCE ENGINE
MODEL R975-C4 (CONTINENTAL)

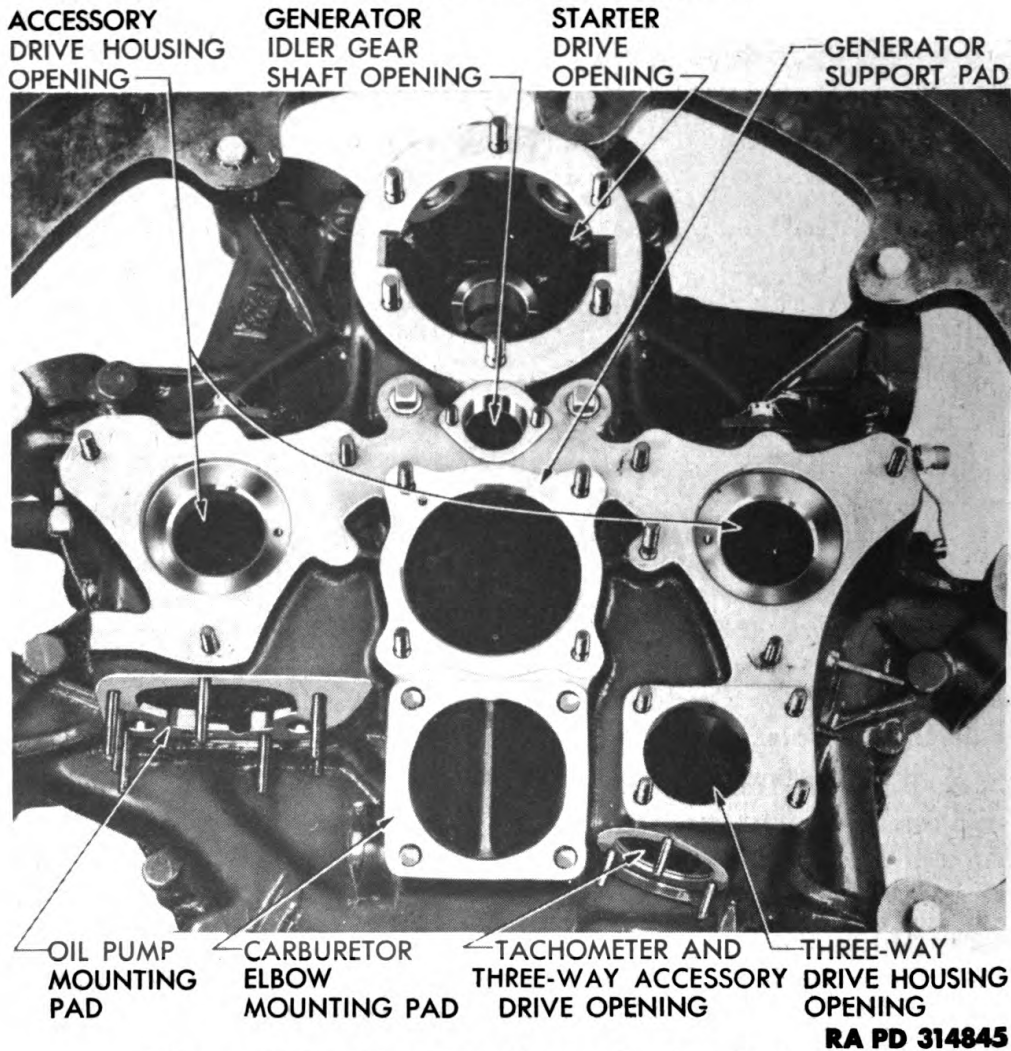

Figure 181 – Rear Crankcase Section Stripped

puller under the flange, and pull seal from crankcase (fig. 179). Lift shaft from bushing in crankcase (fig. 180). Repeat procedure for other seal and shaft.

i. Remove Starter Shaft Seal. Place drift of suitable size against inner surface of starter shaft seal housing which is positioned against starter shaft bushing. Drive seal out through front of rear crankcase section.

j. Remove Rear Crankcase Section. Remove self-locking nuts and bolts securing crankcase section to engine assembly stand. Lift off crankcase section; place it on bench for cleaning and inspection.

46. CLEANING.

a. Steam-clean case and wash with dry-cleaning solvent to remove grease and dirt. Coat machined surfaces with light film of oil. Re-

**DISASSEMBLY, CLEANING, INSPECTION, REPAIR, AND
ASSEMBLY OF SUBASSEMBLIES**

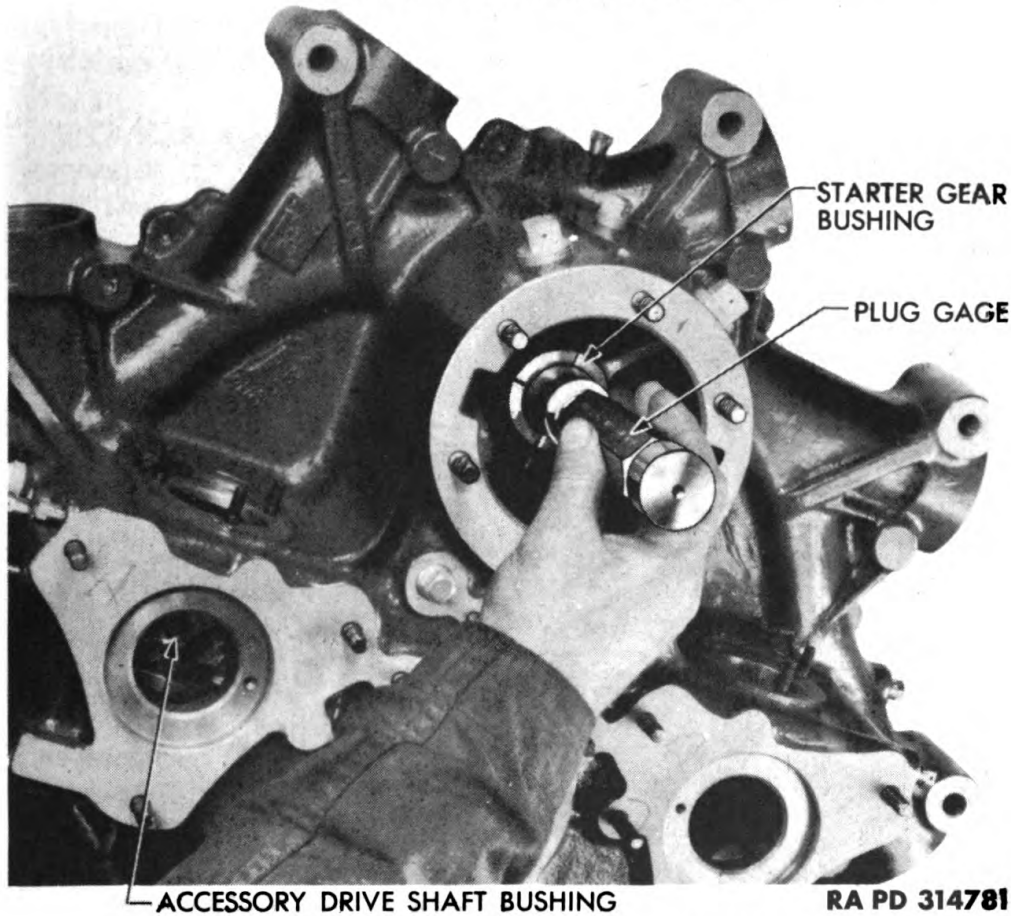

182 – Checking Starter Gear Bushing

move any gasket material or sealing compound that may still be adhering to parting flanges.

47. INSPECTION AND REPAIR.

a. Rear Crankcase Section. Inspect casting very carefully for cracks and other indications of damage, particularly fuel induction tube connections and webs. Replace entire crankcase if casting is cracked or damaged. Inspect all flanges and machined surfaces. Inspect all mounting pads for nicks, burs, or roughness. Remove nicks or burs with a fine stone, and polish with crocus cloth. Check all studs for tightness and condition of threads. Replace studs if necessary (par. 13 f).

b. Bushings. Inspect starter gear and accessory drive shaft bushings for nicks, scores, or other damage. If bushings are in good condition, check their diameter (fig. 182). If bushings are damaged, or worn beyond allowable limits (1.3745 and 1.3755 inches for the starter shaft bushing and 0.7495 and 0.7505 inch for accessory drive

**ORDNANCE MAINTENANCE — ORDNANCE ENGINE
MODEL R975-C4 (CONTINENTAL)**

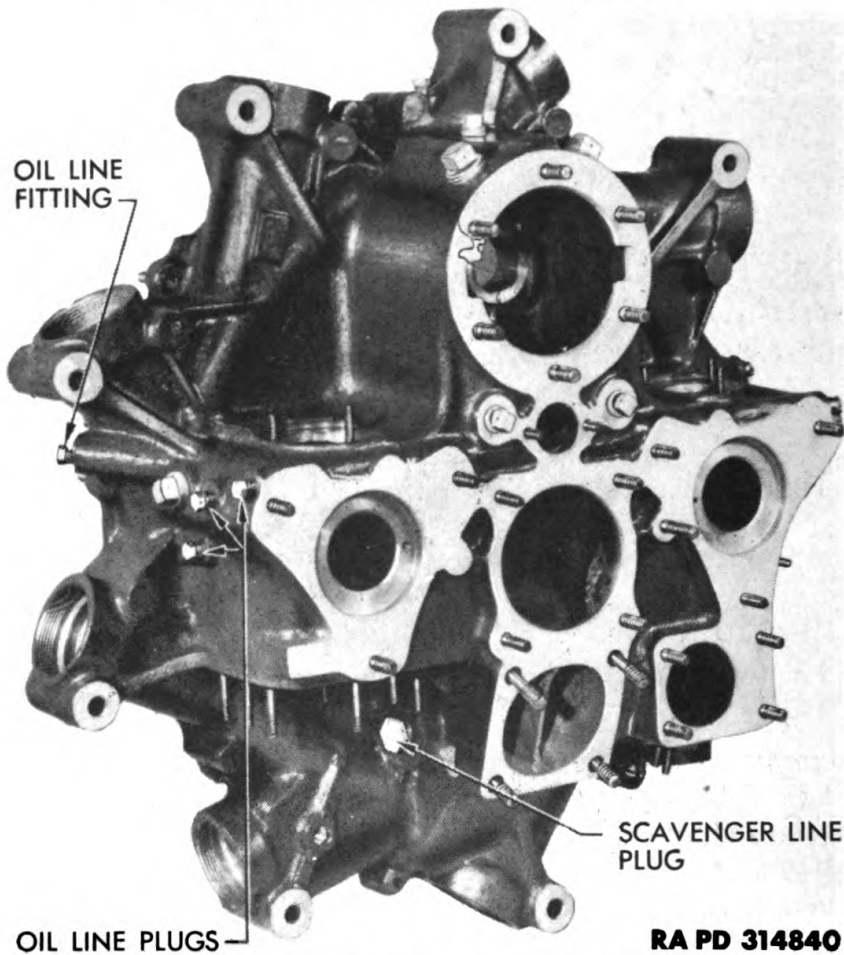

RA PD 314840

Figure 183 — Oil Plugs in Rear Section

shaft bushings), replace bushing, and replace matching bushing in diffuser section. Follow procedure prescribed in paragraph 43 b subpars. (1) through (6). **NOTE:** *It is not necessary to drill out, or remove, pin from accessory drive-shaft bushings in the rear crankcase section, as these have slotted keyways. Line up slot with key and install bushing.*

c. Clean Oil Lines.

(1) **REMOVE No. 1 OIL LINE PLUG** (fig. 183). Plug oilhole to oil standpipe. Insert nozzle of compressed air hose in oil line plug opening, and blow out line. Make certain air passes through opening to generator idler gear shaft.

(2) **PLUG GENERATOR IDLER GEAR SHAFT OPENING.** Blow out oil line to oil standpipe opening in front of rear crankcase section through the No. 2 plug opening (fig. 183).

(3) **PLUG STANDPIPE OPENING.** With air hose in same place, plug standpipe and generator idler gear shaft openings. Blow air through

**DISASSEMBLY, CLEANING, INSPECTION, REPAIR, AND
ASSEMBLY OF SUBASSEMBLIES**

openings to see that line to oil pump opening is clean. Reinstall plug No. 1.

(4) **REMOVE OIL LINE PLUG NO. 2.** Blow through oil line to generator idler gear shaft opening. Blow air through generator idler gear shaft opening to make sure line to generator drive gear shaft opening support pad is clear. From generator drive gear support pad opening, blow through opening for three-way housing.

(5) **REMOVE NO. 3 OIL LINE PLUG.** Blow through opening to sump drain to make sure sump connection is clear.

48. ASSEMBLY.

a. No subassemblies are installed in rear crankcase section at this time. Refer to chapter 5.

Section XI

OIL PUMP

| | Paragraph |
|------------------------------------|------------------|
| Disassembly | 49 |
| Cleaning | 50 |
| Inspection and repair | 51 |
| Assembly | 52 |
| Tests and adjustments | 53 |

49. DISASSEMBLY.

a. **Remove Oil Pump Drive Gear.** Oil pump drive gear is splined to pressure pump drive shaft. Lift drive gear from top of pressure pump body. Place gear, and all other parts subsequently removed, on bench ready for cleaning and inspection.

b. **Remove Pressure Pump Body.** Cut lock wire securing two pairs of body attaching screws, and remove screws. Lift pressure pump body off pump drive shafts. Lay pressure pump body on side on bench, being careful not to mar or scratch the lapped mounting surface on underside of body.

c. **Remove Gear Spacer Plate.** Using both hands, lift off gear spacer plate. Do not pry spacer plate loose from scavenger pump body with tool, or the lapped matching surfaces of the spacer plate and the scavenger pump body may be damaged. Pressure pump drive shafts, drive and driven gears, and the scavenger pump drive gear will come out when the spacer plate is removed. The scavenger pump driven gear may come out with the spacer plate. If it does not, remove by lifting it out of scavenger pump body. The scavenger pump drive gear is keyed to the pressure pump driven shaft. If it

**ORDNANCE MAINTENANCE – ORDNANCE ENGINE
MODEL R975-C4 (CONTINENTAL)**

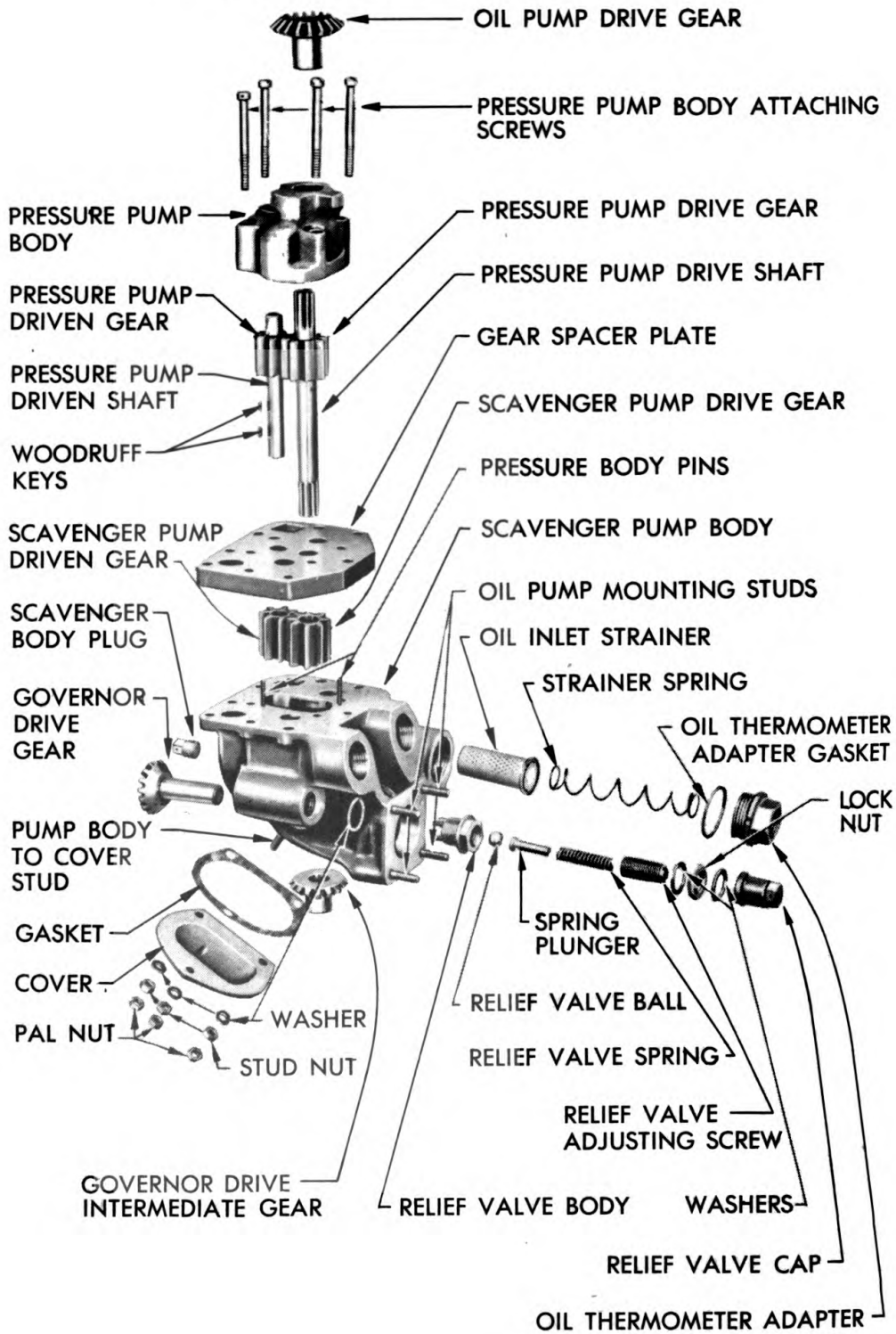

RA PD 314852

Figure 184 – Oil Pump – Disassembled

**DISASSEMBLY, CLEANING, INSPECTION, REPAIR, AND
ASSEMBLY OF SUBASSEMBLIES**

cannot be removed from the shaft easily, turn the spacer plate upside down. Tap end of oil pressure pump driven shaft to break the oil pump driven gear away from the Woodruff keys which lock it to the shaft. Do not attempt to pry it off with tools. Remove the gear by placing fingers between spacer plate and top of gear, being sure not to mar or scratch the lapped surface of spacer plate. After gear is removed, pull Woodruff keys from driven shaft keyway with pliers, and remove scavenger pump drive gear from shaft.

d. Remove Scavenger Pump Body Cover. Turn scavenger body over on bench, being careful not to bend pressure pump body pins or to mar lapped surface of scavenger pump body. Remove three palnuts, stud nuts, and washers, which attach scavenger pump body cover to scavenger body. Lift off cover. Remove gasket, and discard it if new gasket is available.

e. Remove Governor Drive Intermediate Gear. As drive shaft to which governor drive intermediate gear is splined has previously been removed, remove intermediate gear by lifting it from scavenger pump body.

f. Remove Governor Drive Gear. Withdraw governor drive gear through the rear of the scavenger pump body.

g. Remove Relief Valve Assembly. Cut safety wire from relief valve aluminum cap, and remove cap using wrench (41-W-1577-400). Remove gasket and flat washer. Unscrew and remove lock nut. Remove second flat washer. With screwdriver, remove relief valve adjusting screw. Remove relief valve spring with fingers. Ball and plunger may come out with spring. With the other end of special wrench, unscrew and remove relief valve body. If ball and plunger did not come out when spring was removed, remove them now from the relief valve body. Remove relief valve body gasket.

h. Remove Oil Pump Thermometer Adapter. Unscrew oil pump thermometer adapter from scavenger pump body and remove it. Remove and discard gasket from adapter, and pull out spring from inlet strainer.

i. Remove Oil Inlet Strainer. Insert finger inside inlet strainer, and pull strainer from scavenger pump opening. The oil pump is now disassembled.

50. CLEANING.

a. Wash all oil pump parts thoroughly in dry-cleaning solvent. Dry parts with air hose. Cover parts with light coat of engine oil to prevent them from rusting. Remove 1/4-inch plug at rear of scavenger pump body. Blow out all passages in scavenger pump body with compressed air. Replace 1/4-inch plug as soon as passages are clean.

**ORDNANCE MAINTENANCE – ORDNANCE ENGINE
MODEL R975-C4 (CONTINENTAL)****51. INSPECTION AND REPAIR.**

a. Pressure Pump Body. Handle pump body with the extreme care to prevent damage to lapped surface. Inspect drive and driven gear bores for heavy scratches or scoring. If bores are badly scratched or scored, replace pressure pump body, gear spacer plate, and scavenger pump body. This assembly is doweled with master dummy gears by the manufacturer, and none of the three parts are interchangeable. If at any time it is found necessary to replace any one of these parts, replace all three in matched sets. Measure clearance between the shaft bore and shafts. If either clearance between the shafts and shaft bores exceeds 0.003 inch, loose fit, replace pressure pump body, gear spacer plate, and scavenger pump body. Inspect lapped surface of pressure pump body for scratches or imbedded chips. If surface is damaged, replace pressure pump body, gear spacer plate, and scavenger pump body.

b. Gear Spacer Plate. Handle gear spacer plate with extreme care to avoid damaging lapped surfaces. Inspect spacer plate shaft bores for heavy scratches and scoring. Measure clearance between shaft bores and shafts. If bores are severely scratched or scored, or either clearance between shaft bores and shafts exceeds 0.0025 inch, loose fit, replace pressure pump body, spacer plate, and scavenger pump body.

c. Scavenger Pump Body.

(1) **MEASURE SHAFT BORE CLEARANCES.** Inspect scavenger pump body thoroughly and use extreme care in handling to prevent damage to the lapped surface. Measure shaft bore clearances. If clearance between scavenger pump body bore and pressure pump driven shaft exceeds 0.0025 inch, loose fit, or clearance between scavenger pump body bore and pressure pump drive shaft exceeds 0.0035 inch, replace pressure pump body, spacer plate, and scavenger pump body.

(2) **INSPECT RELIEF VALVE SEAT.** Inspect relief valve seat for rough edges. If seat has a rough edge, replace valve seat. To replace the valve seat, tap through the seat with a standard $\frac{3}{8}$ -inch, 16-thread tap. Place several washers under the head of a $\frac{3}{8}$ -inch, socket-head set screw, and with a socket-head set screw wrench, turn screw into seat. When the washers shoulder against the relief valve bore, turn the wrench sharply until the seat is drawn from the pump body. The seat is installed with a press fit, and the wrench must be turned heavily to withdraw the seat. Discard the seat and install a new one. To install new relief valve seat, insert plunger in dummy relief valve body. Place new seat on end of plunger. Screw dummy body into seat opening in scavenger pump body. Screw dummy body in until it is flush against scavenger pump body spot facing. Insert $\frac{3}{8}$ -inch rod through opening in dummy body. Strike rod sharply

**DISASSEMBLY, CLEANING, INSPECTION, REPAIR, AND
ASSEMBLY OF SUBASSEMBLIES**

to drive seat into position. Remove rod. Unscrew dummy body, and remove plunger from dummy body.

d. Relief Valve. Place relief valve ball between four prongs in valve body. Measure clearance between ball and prongs with feeler gage. If the clearance is greater than 0.014 inch, replace valve body. Inspect ball for nicks, cracks, or flat spots. Replace ball if it is damaged. Check the plunger to see if it slides into the relief valve spring so that when the spring is compressed, there is no evidence of binding. Test spring compression. Spring should have a tension between 4.95 and 6.05 pounds at a spring length of 1.25 inches. If tension is less than 4 pounds, replace spring. Inspect condition of threads on the relief valve nut, and the condition of the bore which accommodates the spring. If threads are worn or damaged, or if bore is rough, smooth bore with fine stone, and replace nut.

e. Inlet Screen Assembly. Inspect screen for damage. Replace screen if punctured or otherwise damaged. Check inlet strainer spring for compression. With the spring measuring 3.125 inches in length, spring tension should be 6 pounds. If tension is less than 5 pounds, replace spring. Inspect condition of threads on thermometer adapter. Check hole in adapter to see that it is smooth. Replace adapter if threads are damaged or if bore is rough.

f. Gears.

(1) **OIL PUMP DRIVE GEAR.** Check gear for condition of teeth. If teeth are even slightly worn, grooved, chipped, or broken, replace gear. Install gear in pressure pump body, and measure running clearance with feeler gage. If clearance is not within limits prescribed (Table of Limits), replace gear. Measure clearance between gear shaft and bore opening in pressure pump body. If gear shaft is less than minimum limits prescribed (Table of Limits), replace gear. If bore is larger than maximum limits prescribed by Table of Limits, replace pressure pump body, gear spacer plate, and scavenger pump body. Inspect under side of gear and top of pressure pump body to determine if the top of the pressure pump body provides adequate thrust for the gear. Polished surfaces on both the gear and pressure pump body indicate adequate thrust.

(2) **PRESSURE PUMP GEARS.** Check condition of gear teeth, and replace gear and shaft assembly if teeth are even slightly chipped, worn, grooved, or cracked. Check end clearance and running clearance of both the drive and driven gears in relation to the pressure pump body and the gear spacer plate. If the end, or running, clearances of either gear is more than 0.005 inch, loose fit, replace gear and shaft assembly. Operate gears with master gear and check for backlash. If the gears have more than 0.008-inch backlash, replace gear and shaft assemblies. Excessive backlash affects the priming

**ORDNANCE MAINTENANCE – ORDNANCE ENGINE
MODEL R975-C4 (CONTINENTAL)**

qualities of the pump and backlash must be held to the prescribed minimum. Check condition of drive shaft splines, and replace gear and shaft assemblies if splines are damaged.

(3) **SCAVENGER PUMP GEARS.** Inspect both scavenger pump drive and driven gears for condition of gear teeth. Measure end play and running clearances, and check backlash. If end play exceeds, 0.005 inch, loose fit, if backlash exceeds 0.007 inch, or if the gears are even slightly damaged, replace gears.

(4) **GOVERNOR DRIVE GEARS.**

(a) *Governor Drive Gear Bushing.* Install governor drive gear, and measure clearance between the drive gear shaft and shaft bushing in scavenger pump body. Clearance should measure between 0.001 and 0.0025 inch, tight fit. If bushing is worn beyond maximum inside diameter prescribed, replace bushing. To replace bushing, drill out locking pin, and drill out bushing until thin shell remains. Break out remaining shell. Clean up bearing bore. Press new bushing into bore, and broach to proper inside diameter. Drill hole through scavenger pump body guide hole and bushing. Install locking pin through hole and bushing.

(b) *Governor Drive Gear.* Inspect gear teeth, and replace gear if teeth are worn or damaged.

(c) *Governor Drive Intermediate Gear.* Inspect condition of gear teeth, and replace gear if teeth are damaged. Check condition of gear spline, and slip gear over pressure pump drive shaft spline. Measure spline clearance. If splines are loose fitting, replace intermediate gear.

g. **Body Screws.** Inspect four pressure pump body screws to make sure they are straight, and that the threads are square and in good condition. If screws are bent, or threads are not square, screws will tend to cock pressure pump body when the body is assembled to the gear spacer plate. Replace bent screws or screws with damaged threads.

h. **Scavenger Pump Body Cover.** Inspect cover to make sure that it is not warped, cracked, or dented. Replace cover if it is warped or damaged.

52. ASSEMBLY.

a. **Install Pressure Pump Drive Shafts.** Lubricate two pressure pump drive shafts and gears. Make sure that lapped surface of gear spacer plate is free from chips and dirt. Install shafts in gear spacer plate holes. Make sure that the lower edges of gear teeth are up against countersink in the spacer plate holes. Install two Woodruff keys in keyway in pressure pump driven shaft below spacer plate.

b. **Install Scavenger Gears.** Lubricate the scavenger pump gears. Slide scavenger pump drive gear over the pressure pump

**DISASSEMBLY, CLEANING, INSPECTION, REPAIR, AND
ASSEMBLY OF SUBASSEMBLIES**

driven shaft, carefully. Make sure to line up the gear keyway with the Woodruff keys. Slide gear on by hand and into position. **CAUTION:** *Do not drive it onto shaft.* Press the pressure pump body driven gear, and the scavenger pump drive gear against the gear spacer plate by hand. Slide the scavenger pump driven gear over the pressure pump drive shaft, and mesh with scavenger pump drive gear.

c. Install Governor Drive Gear. Lubricate governor drive gear. Install gear in scavenger pump body so that end of gear shaft fits through and rests in bushing in governor mounting pad.

d. Install Pressure Pump Body and Spacer Plate Assembly. Make sure that there are no chips or dirt, on lapped matching surfaces of the gear spacer plate and scavenger body. Lubricate lower ends of pressure pump drive shafts, and put a small amount of lubricant on scavenger gears. Do not put an excessive amount of lubricant on the driven shaft. Clearances in the scavenger body are so close that excess oil in the shaft bore will create a hydraulic lock, which will prevent the shaft from going to the bottom of the shaft bore. Install the governor intermediate drive gear in position inside scavenger body, and mesh it with governor drive gear. Holding gear spacer plate and shaft assembly upright, lower the assembly into the scavenger body, being careful not to force the pilot pins from their true position. Splines on the lower end of the pressure pump drive shaft will mesh with the splines in the governor drive intermediate gear, holding that gear in position.

e. Install Pressure Pump Body. Hold the pump already assembled in upright position so that assembly does not become separated. Lubricate top of pressure pump drive shafts. Put small amount of lubricant on gear teeth. Install pressure pump body over shafts and gears, and onto pilots extending from gear spacer plate. Insert four pressure pump body holding screws through pressure pump body. Tighten screws slightly more than fingertight. Insert pressure pump drive gear in top of pressure pump body to spline with drive shaft. Operate oil pump drive gear to test free operation of all gears and shafts. If gears and shafts operate freely, tighten four holding screws uniformly. Keep testing free operation of gears as screws are being tightened. Any binding noticed during the screw-tightening procedure, may be due to misalignment of the pressure pump body, improper gear end clearance, or slight misalignment of the dowel pins. Lightly tap pressure pump body laterally in various directions with a rawhide, or plastic, hammer. Operate gears with oil pump drive gear to determine if tight spots exist on any side of pump. Any impossibility to operate gears freely indicates improper assembly or defective parts. Disassemble the pump, reinspect the parts, and replace any de-

**ORDNANCE MAINTENANCE — ORDNANCE ENGINE
MODEL R975-C4 (CONTINENTAL)**

fective parts. If the gears operate freely, tighten the four pressure body holding screws securely, and secure with lock wire. Lock wire the two front screws together, and the two rear ones together.

f. Install Relief Valve Assembly. Place new gasket over relief valve body, and screw valve body into scavenger pump body. Insert valve ball into valve body. Place plunger in valve spring, and push spring and plunger through valve body to valve ball. Install relief valve adjusting screw, and turn screw into valve body about half way (half the number of threads). Place new washer on adjusting screw. Install lock nut. Leave off second washer and relief valve cap until oil pump has been adjusted properly.

g. Install Strainer Assembly. Insert inlet strainer into scavenger body. Place spring in strainer. Place new gasket in thermometer adapter, and screw adapter into scavenger body.

h. Install Scavenger Body Cover. Install scavenger body cover gasket over studs around cover opening on scavenger body. Place cover over studs. Place washers and stud nuts on studs. Tighten nuts. Install and tighten palnuts.

53. TESTS AND ADJUSTMENTS.

a. Install Oil Pump on Test Stand. Install oil pump on test stand designed to simulate actual operating conditions when engine is installed in vehicle. The stand should be constructed so that test motor will drive pump at speeds ranging from 100 to 2,700 revolutions per minute. The stand should be equipped to measure oil flow and oil pressure from zero to the pump maximum values.

b. Test Pump Operation. Start test motor at any prearranged speed. Check to see that pump is priming at 600 revolutions per minute; if not, raise the speed until it does prime. With screwdriver, adjust relief valve adjusting screw so that at an engine speed of 800 revolutions per minute, and with the oil flow controlled between 12 and 15 gallons per minute, oil pressure registers 35 pounds. Increase the speed of the engine. At 2,400 revolutions per minute, adjust oil pressure to 75 pounds. If oil pressure can be adjusted to above specifications, pump is operating satisfactorily. Shut off motor and remove pump. Place pump on bench until ready to install on rear crankcase section.

**DISASSEMBLY, CLEANING, INSPECTION, REPAIR, AND
ASSEMBLY OF SUBASSEMBLIES**

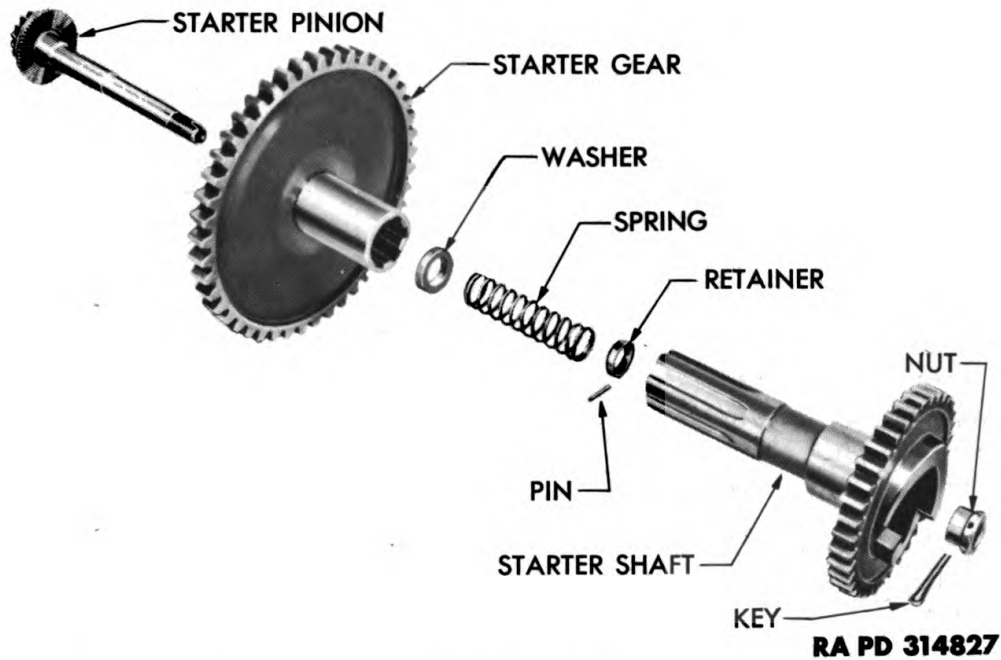

Figure 185 – Starter Gear and Shaft – Disassembled

Section XII

REAR CRANKCASE SECTION SUBASSEMBLIES

| | Paragraph |
|--|-----------|
| Starter gear and shaft | 54 |
| Generator idler gear and shaft | 55 |
| Generator drive gear support | 56 |
| Accessory drive shaft assemblies | 57 |
| Three-way accessory drive housing | 58 |
| Tachometer and three-way accessory drive | 59 |
| Tachometer drive assembly | 60 |
| Fuel pump and mounting | 61 |
| Accessories | 62 |

54. STARTER GEAR AND SHAFT.

a. Disassembly. Remove starter shaft bolt spring by pushing starter shaft bolt spring retainer down to uncover pin installed through bolt. Remove pin from bolt. Pull retainer, spring and spring seat from bolt, and remove bolt.

b. Cleaning, Inspection, and Repair. Clean all parts in dry-cleaning solvent, and coat with light film of lubricating oil. Carefully inspect matching serrations on the pinion gear and drive shaft gear. Check gears for condition, freedom from mars or scratches, and for fit. If any of these three machined parts are unserviceable,

**ORDNANCE MAINTENANCE – ORDNANCE ENGINE
MODEL R975-C4 (CONTINENTAL)**

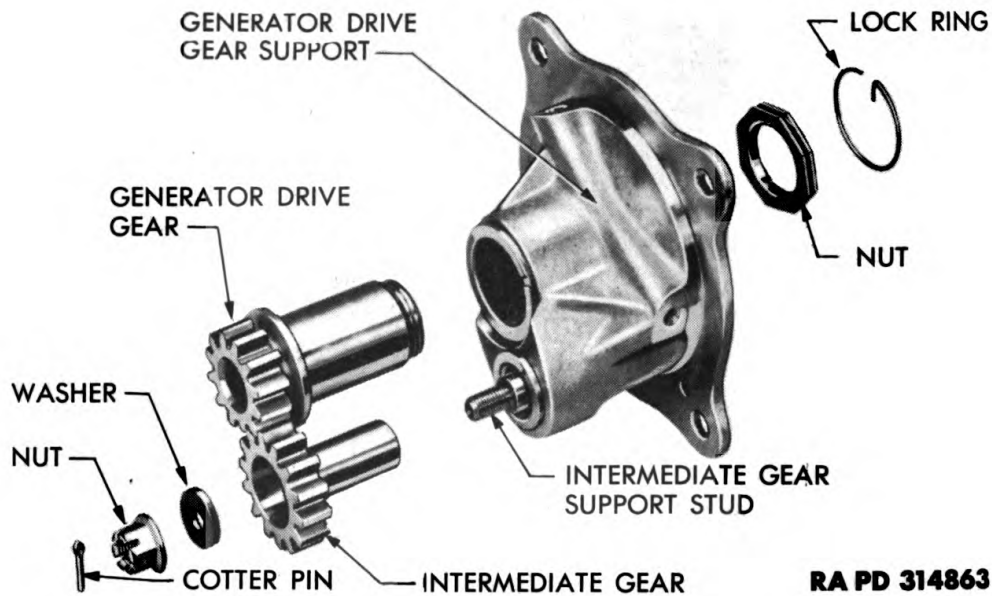

Figure 186 – Generator Drive Gear Support – Disassembled

replace all three with a new matched set. Inspect spring for tension, which should be from 6 to 8 pounds when spring is compressed to 1.375 inches. Inspect bolt, spring seat, retainer, and pin. Replace any unserviceable parts.

c. **Assembly.** Reassemble bolt and starter drive shaft gear by reversing disassembly procedure (subpar. a, above). Make sure to install retainer with flanges up so that flanges will retain the bolt pin in position. Do not assemble starter gear to starter drive shaft gear.

55. GENERATOR IDLER GEAR AND SHAFT.

a. **Disassembly.** The generator idler gear and generator idler gear shaft assembly is an integral unit.

b. **Cleaning, Inspection, and Repair.** Clean gear and shaft with dry-cleaning solvent, and coat with light film of lubricating oil. Inspect shaft for scores, pits, scratches, and evidence of wear. Measure diameter of shaft with micrometer. Diameter should measure between 0.8725 and 0.8735 inch. If diameter is worn beyond allowable limits (Table of Limits), replace assembly. Inspect face of flange at end of shaft for burrs or roughness. Remove burrs or roughness with fine stone, and polish with crocus cloth. Inspect generator idler gear teeth for cracks, or excessive wear. Replace assembly if either of these conditions is found. Inspect gear bushing for roughness, scores, or erosion.

c. **Assembly.** Place assembly on bench until ready to install.

**DISASSEMBLY, CLEANING, INSPECTION, REPAIR, AND
ASSEMBLY OF SUBASSEMBLIES**

56. GENERATOR DRIVE GEAR SUPPORT (fig. 186).

a. Disassembly. Remove nut and washer from generator intermediate gear support stud. Remove intermediate gear from support. Remove lock ring and nut from generator drive gear shaft. Remove generator drive gear from support.

b. Cleaning, Inspection, and Repair. Have gears given a magnaflux inspection. Replace cracked gears. Inspect gears for condition of teeth and journals. Smooth up any slight imperfections with fine stone. Replace worn or damaged gears. Inspect gear support for cracks and general condition. Replace support if it is damaged. Inspect condition of intermediate gear stud. Blow out all oilholes. Drill out pin. Unscrew, and replace pin if threads are worn or damaged. Inspect condition of gear bushings. If bushings are in good condition, check diameters with inside micrometer or plug gage. If drive gear bushing is damaged or is worn beyond allowable limits, replace support. The bushing should measure between 0.6245 and 0.6255 inch. If intermediate gear bushing is damaged, or worn beyond allowable limits, replace support.

c. Assembly. Oil all parts, and reassemble support and gears by reversing disassembly procedure (subpar. a above). Place assembly on bench and protect it from dirt and dust.

57. ACCESSORY DRIVE SHAFT ASSEMBLIES.

a. Disassembly. Assemblies have already been removed, and are not further disassembled.

b. Cleaning, Inspection, and Repair. Clean parts in dry-cleaning solvent, and coat with light film of engine oil. Have assemblies given magnaflux inspection. Inspect accessory drive shafts for galling, scoring, and wear at bearing locations. Inspect condition of threads on ends of shafts. Check teeth on integral gear shaft for scores and wear. Examine magneto couplings for wear. Check magneto coupling splines for scores and wear. Inspect magneto drive splines for fit within magneto couplings and for condition of splines. Remove scores from gear teeth and bearing journals with fine stone, and polish with crocus cloth. If threads at end of shaft are damaged, or either shaft is cracked, replace assembly. If any other part pertaining to shaft is damaged or badly worn, replace the assembly. Blow out oilhole running through each shaft with compressed air.

c. Assembly. No assembly is made until shafts are installed in crankcase. Place assemblies on bench and cover them to protect them from dirt and dust.

58. THREE-WAY ACCESSORY DRIVE HOUSING.

a. Disassembly. Cut safety wire from palnuts, and remove palnuts

ORDNANCE MAINTENANCE – ORDNANCE ENGINE
MODEL R975-C4 (CONTINENTAL)

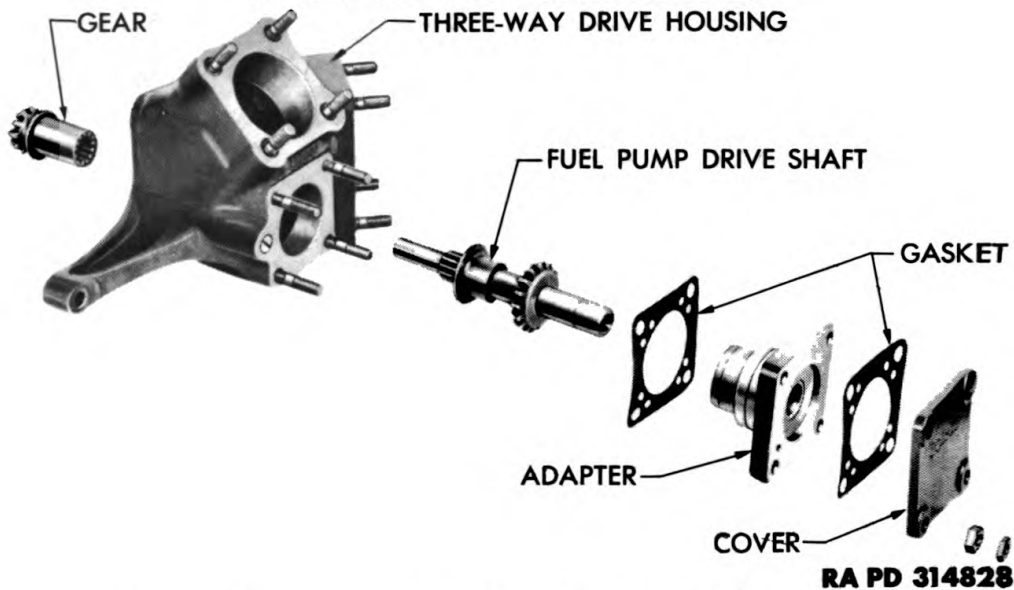

Figure 187 – Three-way Drive Housing Assembly – Disassembled

and washers. Remove, in order, vacuum pump substitute cover, gasket, left-hand vacuum pump adapter, gasket, and vacuum and fuel pump drive shaft.

b. Cleaning, Inspection, and Repair. Clean all parts in dry-cleaning solvent, and coat with light film of engine oil. Inspect vacuum and fuel pump drive gear, and shaft, for condition of teeth and splines. Inspect journals for scores, scratches, or any indications of wear. Inspect housing, adapter, and cover for cracks and general condition. Inspect studs in housing for tightness and condition of threads. Inspect housing, left-hand fuel pump gear bushing, and fuel pump adapter gear bushing for finish and for excessive wear. Check diameter of bushings with micrometer or plug gage.* If diameter of adapter or housing bushings are greater than allowable limits (Table of Limits), or if bushings are damaged, replace adapter or housing. Replace any other unserviceable parts.

c. Assembly. Oil parts of assembly; reinstall new gaskets; and reassemble assembly, reversing disassembly procedure (subpar. a, above).

59. TACHOMETER AND THREE-WAY ACCESSORY DRIVE.

a. Disassembly. Remove cotter pin, nut, and three-way drive gear from inner end of adapter. Remove cover, gasket, and shaft from outer end.

*The drive gear housing should measure between 0.937 and 0.938 inch; the left-hand fuel pump bushing between 0.8775 and 0.8785 inch; and the fuel pump adapter drive gear bushing between 0.7510 and 0.7520 inch.

**DISASSEMBLY, CLEANING, INSPECTION, REPAIR, AND
ASSEMBLY OF SUBASSEMBLIES**

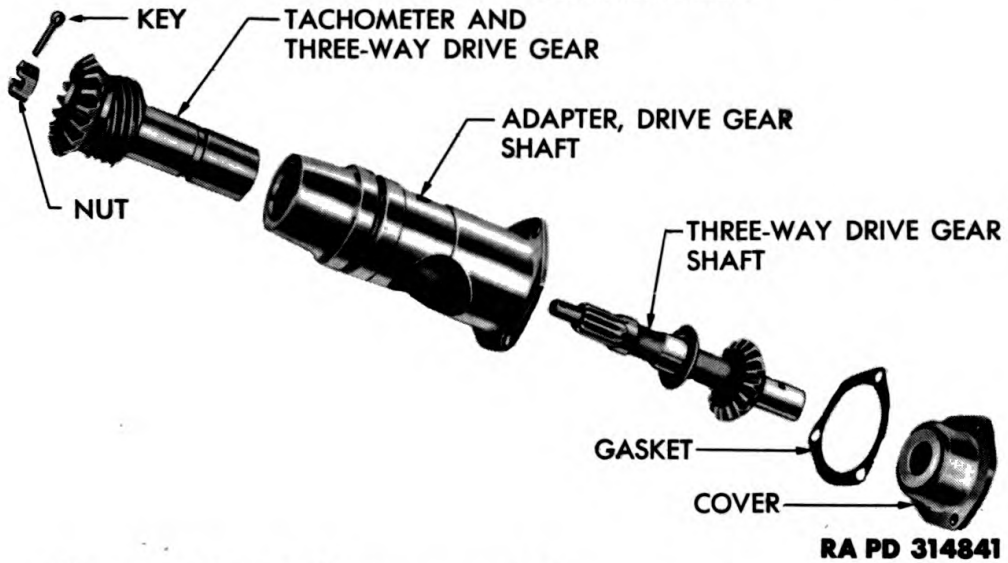

**Figure 188 – Tachometer and Three-way Accessory Drive
– Disassembled**

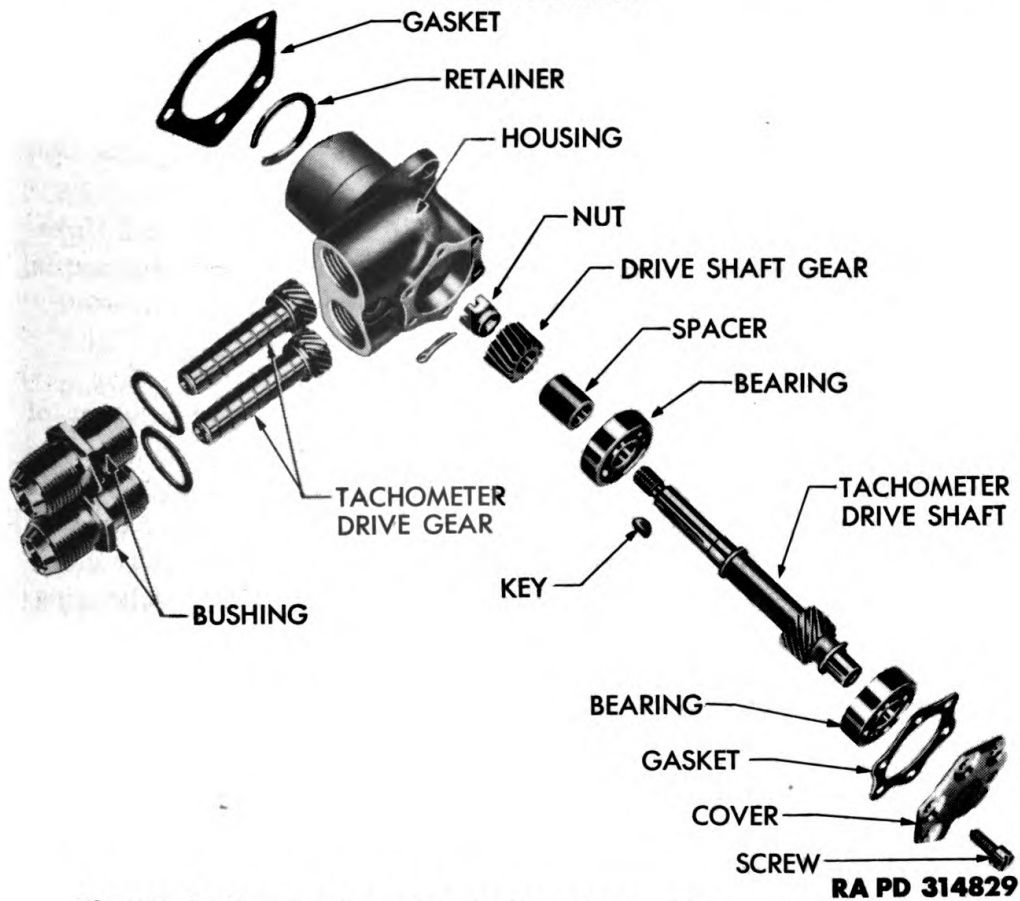

Figure 189 – Tachometer Drive Assembly – Disassembled

ORDNANCE MAINTENANCE – ORDNANCE ENGINE
MODEL R975-C4 (CONTINENTAL)

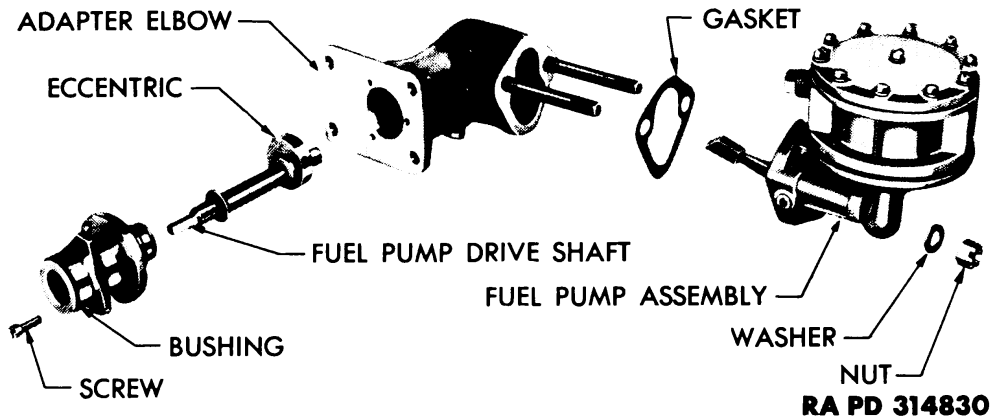

Figure 190 – Fuel Pump Adapter Elbow – Disassembled

b. **Cleaning, Inspection, and Repair.** Give gears magnaflux inspection. Inspect gears for condition of teeth, splines, threads, and journal surfaces. Inspect adapter and cover for cracks, and condition. Inspect tachometer and three-way accessory drive cover bushings for roughness and indications of wear. Check diameter of bushings with micrometer or plug gage. Bushing diameters should measure between 0.7495 and 0.7505 inch. If diameter of either bushing is greater than allowable limits, replace cover or adapter. Replace any parts that are worn or otherwise unserviceable.

c. **Assembly.** Oil all parts, and reassemble tachometer and three-way accessory drive, reversing the disassembly procedure (subpar. a, above). Be sure to use a new gasket under cover.

60. TACHOMETER DRIVE ASSEMBLY.

a. **Disassembly.** Remove protective caps from outer ends of bronze bushings. Remove lock wire, six cap screws, and washers which retain cover on tachometer housing (fig. 189). Remove cover and gasket. Unscrew both tachometer driven shaft bronze bushings from housing. Withdraw two sleeves and gaskets. Pry out tachometer drive shaft ball bearing retainer located at inner end of housing. Remove cotter pin and nut holding drive shaft gear and spacer in place. Remove gear, spacer, and gear key. Pull out tachometer drive shaft, drive shaft gear, and inner ball bearing, as a unit. Remove other ball bearing from housing.

b. **Cleaning, Inspection, and Repair.** Clean all parts in dry-cleaning solvent, and oil with light film of engine oil. Inspect bushings for condition of threads and for condition of inner machined surfaces. Replace badly scored or worn bushings. Give gears magnaflux inspection for cracks. Inspect gears for condition of teeth and journals. Inspect teeth, journal, and threads on drive shaft. Inspect

**DISASSEMBLY, CLEANING, INSPECTION, REPAIR, AND
ASSEMBLY OF SUBASSEMBLIES**

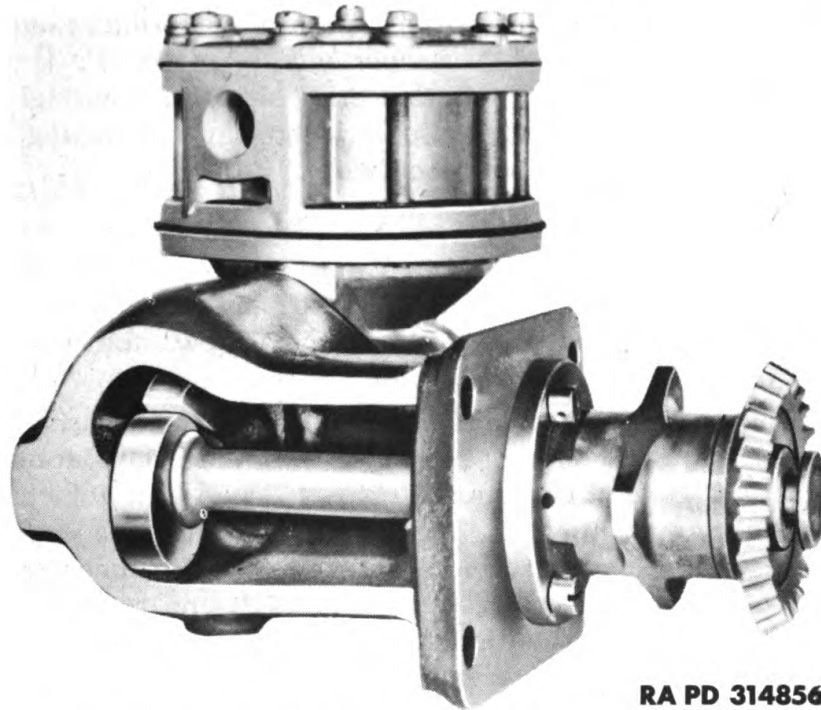

Figure 191 – Phantom View Fuel Pump Adapter Elbow

teeth and keyway on drive shaft gear. Turn bearings slowly to check for flat spots, scores, pits, or excessive wear. Inspect housing and cover for cracks and general condition. Replace any unserviceable parts.

c. Assembly. The tachometer drive gear and shaft assemblies incorporate sleeves in which spiral oil grooves are milled. During normal operation and when properly assembled, the tachometer driven gears rotate in opposite directions to each other. The spiral oil grooves are milled in such a direction, that during rotation, the oil is forced into the interior of the tachometer drive gear housing. Interchanging the driven gears reverses the direction of the spiral oil grooves and tends to force the oil out of the tachometer drive gear shaft housing which results in oil leakage. To check before assembly, select one of the driven gears and rotate it in a counterclockwise direction while facing the gear end. The spiral oil groove milled in the shaft of the driven gear assembly that should be located in the upper position, will run in toward the gear end of the assembly. If not, select the remaining driven gear, and repeat the check. See that ball bearing, spacer, tachometer drive gear nut, and cotter pin are properly installed on the driving end of the tachometer drive shaft. Install retainer. Assemble the drive shaft in the tachometer drive housing. Assemble the tachometer driven shafts, bushings, and gas-

**ORDNANCE MAINTENANCE – ORDNANCE ENGINE
MODEL R975-C4 (CONTINENTAL)**

kets in the tachometer drive housing. Tighten the bushings and make sure that driven shafts have the proper end clearance. Pack housing with petrolatum, and install the other drive shaft ball bearing. Place housing cover and gasket in position. Insert cover attaching screws, tighten screws, and secure with lock wire.

61. FUEL PUMP AND MOUNTING.

a. **Disassembly.** Remove cotter pins from two nuts. Remove nuts and washers, and remove fuel pump from adapter elbow. Take out three screws, and remove bushing from elbow. Lift fuel pump drive shaft and eccentric out of elbow.

b. **Cleaning, Inspection, and Repair.** Clean all parts in dry-cleaning solvent, and coat with light film of oil. Inspect adapter elbow for cracks and general condition. Inspect drive shaft for condition, paying particular attention to eccentric and journals. Inspect bushing for condition of external surfaces and for wear on inner diameter. Check diameter with micrometer or plug gage, and replace bushing, if it is out of round or the diameter is greater than allowable limits (Table of Limits). Replace any other unserviceable parts. If fuel pump requires service attention, refer to procedures given in TM 9-1828A.

c. **Assembly.** Reinstall bushing, fuel pump, and drive shaft, on adapter elbow. Be sure fuel pump is installed so that the control arm is on top of the drive cam in the adapter elbow. Put assembly aside until ready to install in rear crankcase.

62. ACCESSORIES.

a. For disassembly, cleaning, inspection, repair, and assembly of carburetor, fuel pump, booster coil, governor, magnetos, generator, starter, and primer, refer to pertinent technical manuals. Carburetor is covered in TM 9-1826B; fuel pump, TM 9-1828A; Auto-Lite booster coil, TM 9-1825B; Delco-Remy booster coil, TM 9-1825A; governor, TM 9-1750D; magnetos, TM 9-1750C; generator, TM 9-1750D; starter, TM 9-1825A; and primer, TM 9-1750D. For make and models of these accessories, refer to tabulated data (par. 4).

**Section XIII
IGNITION HARNESS**

| | Paragraph |
|--|------------------|
| Disassembly | 63 |
| Inspection, cleaning, and repair | 64 |
| Assembly | 65 |

**DISASSEMBLY, CLEANING, INSPECTION, REPAIR, AND
ASSEMBLY OF SUBASSEMBLIES**

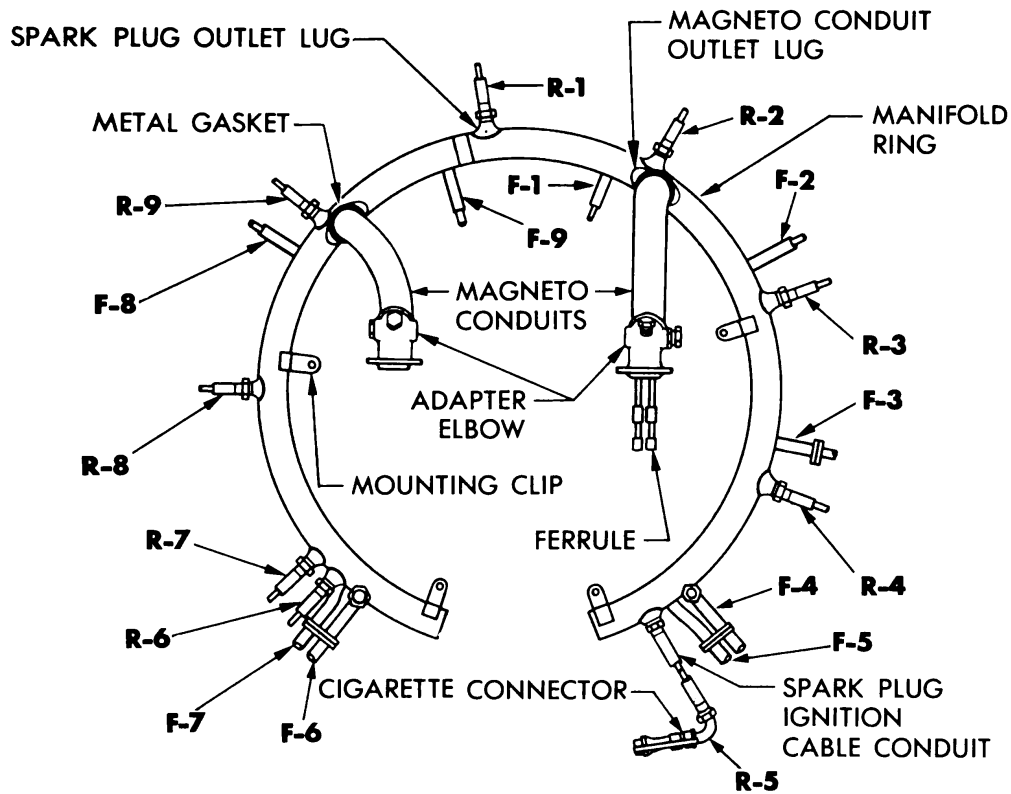

| IGNITION SHIELDING HARNESS REWIRING CHART | | | | | | | |
|--|---------------------|--|---------------------------------|--|---------------------|--|---------------------------------|
| Rear Spark Plugs—Left Magneto | | | | Front Spark Plugs—Right Magneto | | | |
| Cylinder Number and Plug Location | Wiring Order | Cutting Length of Cables (Inches) | Distributor Block Number | Cylinder Number and Plug Location | Wiring Order | Cutting Length of Cables (Inches) | Distributor Block Number |
| R-1 | 5 | 36 | 1 | F-1 | 14 | 41 | 1 |
| R-2 | 4 | 44 | 6 | F-2 | 13 | 44 | 6 |
| R-3 | 3 | 51 | 2 | F-3 | 12 | 52 | 2 |
| R-4 | 2 | 59 | 7 | F-4 | 11 | 59 | 7 |
| R-5 | 1 | 64 | 3 | F-5 | 10 | 59 | 3 |
| R-6 | 6 | 50 | 8 | F-6 | 15 | 73 | 8 |
| R-7 | 7 | 44 | 4 | F-7 | 16 | 70 | 4 |
| R-8 | 8 | 38 | 9 | F-8 | 17 | 56 | 9 |
| R-9 | 9 | 32 | 5 | F-9 | 18 | 50 | 5 |

RA PD 314837

Figure 192 – Ignition Shielding Harness

**ORDNANCE MAINTENANCE – ORDNANCE ENGINE
MODEL R975-C4 (CONTINENTAL)**

63. DISASSEMBLY (fig. 192).

a. At each major engine overhaul, replacement of all the wiring in the ignition harness is recommended.

b. **Remove Cable from Distributor Blocks.** Remove all piercing screws from each distributor block, and withdraw the ignition cables from the distributor block.

c. **Remove Magneto Elbows from Ignition Cables.** Unscrew the knurled nut securing the magneto adapter elbows to the magneto conduits, and slide the adapter elbows off the ignition cables.

d. **Remove Magneto Conduits.** Unscrew the knurled nut securing each magneto conduit to the ignition harness, and slide the magneto conduit off the ignition cables.

e. **Remove Cigarette Connector Protectors.** Unscrew cigarette connector protector from each spark plug wire conduit elbow and remove protector.

f. **Separate Cigarette Connectors.** Straighten the strands of each spark plug cable bent over the sides of the hollow rivet in each cigarette connector, and remove connector from each cable.

g. **Remove Spark Plug Terminal Elbows.** Unscrew coupling nut securing each elbow to spark plug conduit, and remove elbows.

h. **Remove Spark Plug Conduits.** Unscrew the coupling nut attaching spark plug conduit to the manifold ring. Slide the conduit and rubber covering off the cable. Repeat this procedure for each spark plug cable.

i. **Disconnect Manifold Ring.** Unscrew the knurled nut holding the two halves of the manifold ring. Disconnect ring halves. Withdraw ignition cables from the magneto outlet lug in one section of ring in reverse of the wiring order (fig. 192). Withdraw cables from other half of ring in reverse of the wiring order.

64. INSPECTION, CLEANING, AND REPAIR.

a. **Inspection.** Examine the inside surfaces of all parts, particularly at the connections for nicks, burs, and abrasions which may tear or otherwise damage the cable insulation during the wiring of the harness. Inspect the two halves of the manifold ring for cracks and punctures. Inspect the conduits for abrasions or breaks in the braiding wire, and replace if necessary. Examine the threads of all outlets and coupling nuts. Examine all cigarette connectors. If they are burned, or if the spring is broken, replace them.

b. **Cleaning.** Clean dirty conduits with dry-cleaning solvent. With a wire brush, clean the threads of aluminum couplings to remove oxidation which sometimes forms on the threads. This oxidation breaks the grounded circuit and causes radio interference.

**DISASSEMBLY, CLEANING, INSPECTION, REPAIR, AND
ASSEMBLY OF SUBASSEMBLIES**

c. **Repair.** Silver solder, or braze, all cracks in the manifold ring. Silver solder to the manifold ring any loose mounting clips. Dress up damaged threads. Replace defective conduits. Replace defective outlet lugs. To do this, use a torch having a wide flame (or two torches if necessary) to heat the circumference of the joint uniformly and lift off the outlet lug. Silver solder a new outlet lug to the manifold ring. If necessary, half of the manifold ring may be replaced instead of several outlet lugs. In case of a wire shortage, it may be advisable to replace one or more ignition cables. To replace a single ignition cable, remove the spark plug terminal elbow and spark plug conduit, and withdraw the cable from the distributor block. To the spark plug end of the cable, solder a 6-foot length of No. 14 wire. Withdraw the cable from the magneto outlet lug, and unsolder the defective cable from the stringer wire which is now in the manifold ring in place of the cable. Cut a length of cable, equal in length to the one removed, and solder it to the stringer wire at the magneto end. Apply powdered talcum to the cable, and pull the cable through the manifold ring by the stringer wire.

65. ASSEMBLY.

a. **Cut Ignition Cables.** During reassembly after overhaul, replace all ignition cables. Cut ignition cables to the required lengths (fig. 192). To facilitate the wiring of the manifold ring, apply powdered talcum or mica to each cable before feeding it through the manifold ring.

b. **Install Ignition Cables.** Start feeding the cables through the spark plug outlet lugs, and follow the wiring order (fig. 192). To aid in pulling the cable from the magneto outlet lug, use a piece of wire with the end formed into a hook. Insert one finger into the magneto outlet lug, and feed the cable through the ring until it is felt at the magneto outlet lug. Pull the cable out with the hook. If it becomes difficult to install the last few cables, start feeding at the magneto outlet lug. As each cable is installed in the manifold ring, mark it on the magneto end for identification so that it will be installed correctly in the distributor block.

c. **Install and Connect Conduits.** Slide the proper conduit over the cable at the spark plug end, and secure the conduit to the manifold ring with the coupling nut. Cut each cable to a length of $3\frac{1}{4}$ inches measured from the end of the conduit. Slide the elbow over the cable, and secure it to the conduit with the coupling nut.

d. **Install Cigarette Connectors.** Strip about $\frac{3}{8}$ inch of the insulation from end of cable. Slide the cigarette connector over the cable. Thread the stripped end of the cable through the hollow rivet of the cigarette connector. Separate the strands, and bend them over

**ORDNANCE MAINTENANCE – ORDNANCE ENGINE
MODEL R975-C4 (CONTINENTAL)**

the sides of the hollow rivet. Install a protector over each cigarette connector.

e. **Install Magneto Conduits.** Slide the magneto conduits over the cables, and secure the conduit to the manifold ring by the knurled nut.

f. **Attach Cables to Distributor Blocks.** Thread the cables for each magneto adapter elbow through the elbow, and attach the elbows to the conduits by the knurled nuts. Remove about 1/2 inch of the insulation of each wire. Separate the strands, space them evenly, and fold them back over the insulation. Install the proper ferrule, stamped with the number denoting its installation position in the distributor block. Swage the ferrule in place. Insert the cables in the distributor block so that the ferrule number corresponds with the number on the distributor block. Secure the cables in the distributor block with the piercing screws. If the extending ends of the cables are too long, feed them back into the manifold so that the extra length will be available for future repairs.

g. **Test Harness.** Test the harness with a high tension testing set following instructions furnished with the testing set. If a high tension testing set is not available, use a simple bell and battery set, and test each wire.

**Section XIV
FLYWHEEL AND FAN**

| | Paragraph |
|-----------------------------|------------------|
| Disassembly | 66 |
| Cleaning | 67 |
| Inspection and repair | 68 |
| Assembly | 69 |

66. DISASSEMBLY.

a. **Remove Fan from Flywheel.** Mark fan and flywheel with prick punch for identification when reassembling. Drive out 12 flywheel ring bolts from flywheel and fan. Lift off fan (fig. 193).

b. **Remove Separator Pin Springs.** Cut and remove lock wire. Remove two cap screws and spacers from each separator pin spring on flywheel.

c. **Remove Separator Pins.** Remove separator pins from holes in flywheel (fig. 250).

67. CLEANING.

a. Clean all dirt and grease from flywheel and fan, with dry-cleaning solvent. Clean mating surfaces of flywheel and fan.

**DISASSEMBLY, CLEANING, INSPECTION, REPAIR, AND
ASSEMBLY OF SUBASSEMBLIES**

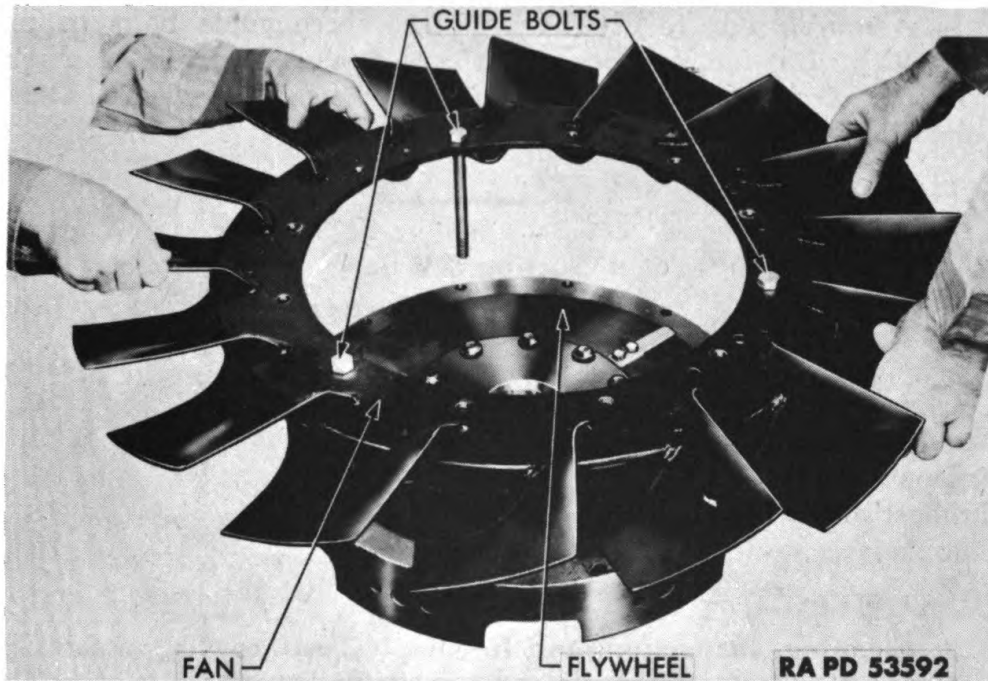

Figure 193 – Assembling Fan and Flywheel

68. INSPECTION AND REPAIR.

a. Inspect Flywheel. Inspect carefully for cracks in both flywheel and hub. Inspect for loose rivets. Inspect splines inside hub, to be sure splines are free from nicks and scores. Inspect surface of flywheel which contacts clutch facing, to be sure this surface is free from any rough spots or irregularities which will not permit good contact with facing. Inspect tapered cone seats, at each end of hub, for rough or flat spots, which would indicate that flywheel has been loose on shaft. Clean up separator pin holes.

b. Inspect Fan. Inspect fan blades and hub carefully for cracks or any indication of interference. Replace fan if any cracks are noted.

c. Inspect Separator Springs. Inspect separator springs to see that they are not cracked or broken. Replace damaged springs. Discard spacers and cap screws.

d. Inspect Separator Pins. Clean up separator pins. Make sure pins are free to travel back and forth in holes in flywheel by pushing on them. Replace worn or damaged pins.

69. ASSEMBLY.

a. Install Separator Springs on Flywheel. Using new cap screws and spacers, reinstall separator springs on flywheel. Use two cap screws to install each spring. Tighten screws and fasten them with lock wire (fig. 193).

**ORDNANCE MAINTENANCE — ORDNANCE ENGINE
MODEL R975-C4 (CONTINENTAL)**

b. **Assemble Fan to Flywheel.** Place three guide bolts in fan (fig. 193). Lift fan, and position it over flywheel with index marks lined up. Guide bolts over matching bolt holes in flywheel. Drive bolts all the way through assembly.

Section XV

MISCELLANEOUS SUBASSEMBLIES

| | Paragraph |
|---------------------------------------|------------------|
| Cowling | 70 |
| Air deflectors | 71 |
| Engine supports | 72 |
| Exhaust manifold collector ring | 73 |
| Sump assembly | 74 |

70. COWLING (fig. 241).

a. **Cleaning, Inspection, and Repair.** Clean cowling assembly, and inspect it for dents and evidences of chafing. See that sections are fastened together securely and secured to the ring. Examine Dzus fasteners for looseness or signs of mutilation. Replace loose or mutilated fasteners. If cowling is dented, hammer it into its original shape. Weld all cracks unless location of cracks makes this inadvisable. Replace cracked parts which cannot be welded. When replacing riveted part, drill out old rivets. Install new part, and drive new rivets. Do not hammer rivets out.

71. AIR DEFLECTORS (fig. 194).

a. **Cleaning, Inspection, and Repair.** Inspect air deflectors for bends, cracks, tightness of rivet, and condition of retaining holes and Dzus fasteners. Replace loose rivets, and loose or mutilated fasteners. Replace or weld all cracked parts. Hammer out bent parts.

72. ENGINE SUPPORTS.

a. **Cleaning, Inspection, and Repair.** Clean and inspect engine rear support for cracks, weld breaks, bends, or other evidence of distortion (fig. 34). Replace damaged, or distorted support. Inspect engine front support carefully for cracks, burs, nicks, scratches, or sharp corners (fig. 36). Remove burs or nicks with fine stone. Replace defective support.

73. EXHAUST MANIFOLD COLLECTOR RING (fig. 245).

a. **Cleaning, Inspection, and Repair.** Clean and make thorough inspection of exhaust manifold assembly. Look for cracks, bends, dents, or erosion. Inspect mounting flanges for cracks, warping, or

**DISASSEMBLY, CLEANING, INSPECTION, REPAIR, AND
ASSEMBLY OF SUBASSEMBLIES**

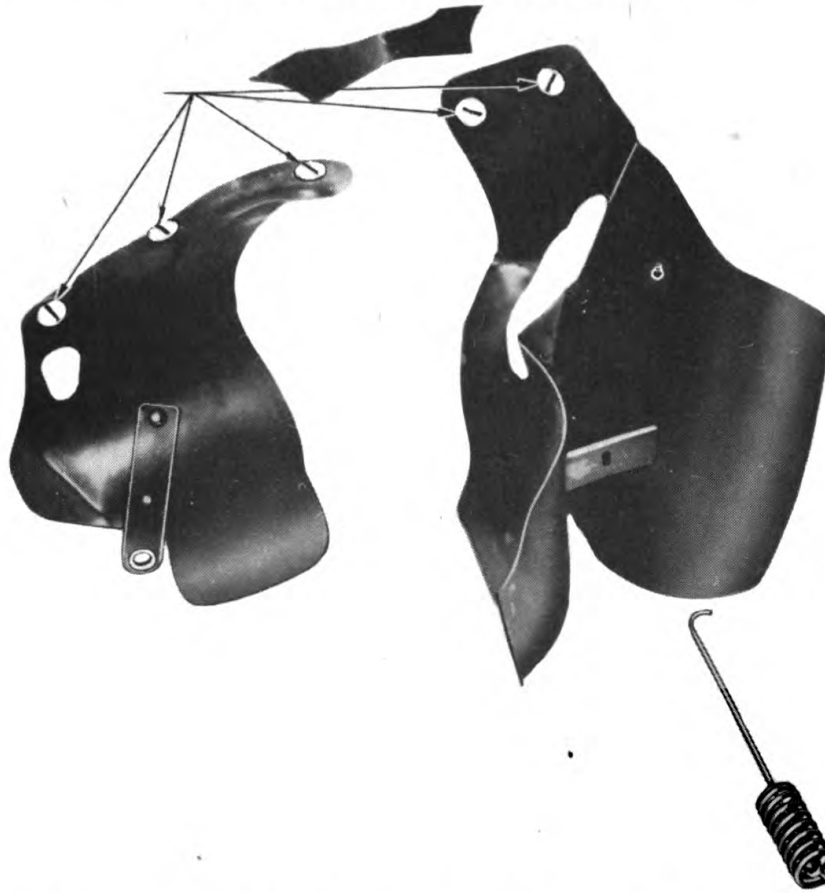

Figure 194 – Inter-cylinder and Cylinder Head Air Deflectors

other defective conditions. Replace damaged individual sections of assembly. Replace sections by loosening clamp cap screws holding ring sections together and removing section. Remove clamps. Install new clamps. Position new section in place, and tighten clamp cap screws.

74. SUMP ASSEMBLY (fig. 242).

a. Cleaning, Inspection, and Repair. Clean sump tanks and tubes. Inspect tanks for leaks, under pressure, if possible. Check for cracks and dents. Replace tanks if they are damaged or if they leak. Inspect spider tubes for leaks, dents, and condition of welded seams. Replace damaged spider. Check general condition of front drain tube, welds, and machined surface. Replace damaged tube. Inspect strainer housing for leaks and general condition, and replace if damaged. Check strainer screen for general and thread condition of plug end. Inspect conditions of threads on spider plug. If threads are worn, install new strainer or spider plug. Check spring on front drain tube. Install new seal. Replace all hose and hose clamps.

ORDNANCE MAINTENANCE — ORDNANCE ENGINE
MODEL R975-C4 (CONTINENTAL)

CHAPTER 5
ASSEMBLY OF SUBASSEMBLIES

| | Paragraph |
|---|-----------|
| Diffuser and rear crankcase sections, assembly and installation | 75 |
| Main and front crankcase sections, assembly and installation . | 76 |
| Cylinder, valve, and valve operating mechanism installation . | 77 |
| Accessories and miscellaneous subassemblies, installation | 78 |
| Flywheel, fan, and clutch installation | 79 |

75. DIFFUSER AND REAR CRANKCASE SECTIONS, ASSEMBLY AND INSTALLATION.

a. Install Rear Crankcase Section on Stand. Remove rear crankcase section from inspection bench, and attach to assembly stand.

b. Install Starter Shaft Seal. Make sure that fuel distribution chamber is absolutely clean, and free from burs and scratches. Install new rubber seal complete with supporting bushing (fig. 196). Place new seal on starter seal support, and insert support in starter shaft opening. Using an old starter shaft bushing as a driver, drive assembly into opening until it bottoms on starter shaft bushing (fig. 196).

c. Install Generator Idler Gear and Shaft. Place gasket over generator idler gear shaft flange studs. Insert gear through slotted starter opening (fig. 178). Position gear with long end of bushing journal up, directly under shaft hole opening. Tap shaft into position. Use a soft hammer, if necessary. Install plug in center of idler gear shaft flange. Install two washers and attaching nuts over studs. With lock wire, fasten the nuts to two nearby plugs.

d. Install Generator Drive Gear Support. Install gasket over generator mounting studs, with dowel hole in gasket over dowel. Position generator drive gear assembly on studs. Line up hole in support over dowel. If necessary, rotate generator idler gear through starter opening to mesh idler gear with the generator drive gear. Push support all the way back on studs (fig. 33). Tap support with soft hammer to make sure it is all the way back. Install generator cover over support, and secure it in place with two nuts tightened fingertight. Install cover on starter opening.

e. Install Accessory Drive Shafts and Seals. Place each accessory drive shaft in bushing in rear crankcase section with magneto coupling up. Lubricate the leather backing on the metal oil seals thoroughly. Install spreading tool in end of accessory drive shaft opening. Install seal on spreader. Place alining bar through retain-

ASSEMBLY OF SUBASSEMBLIES

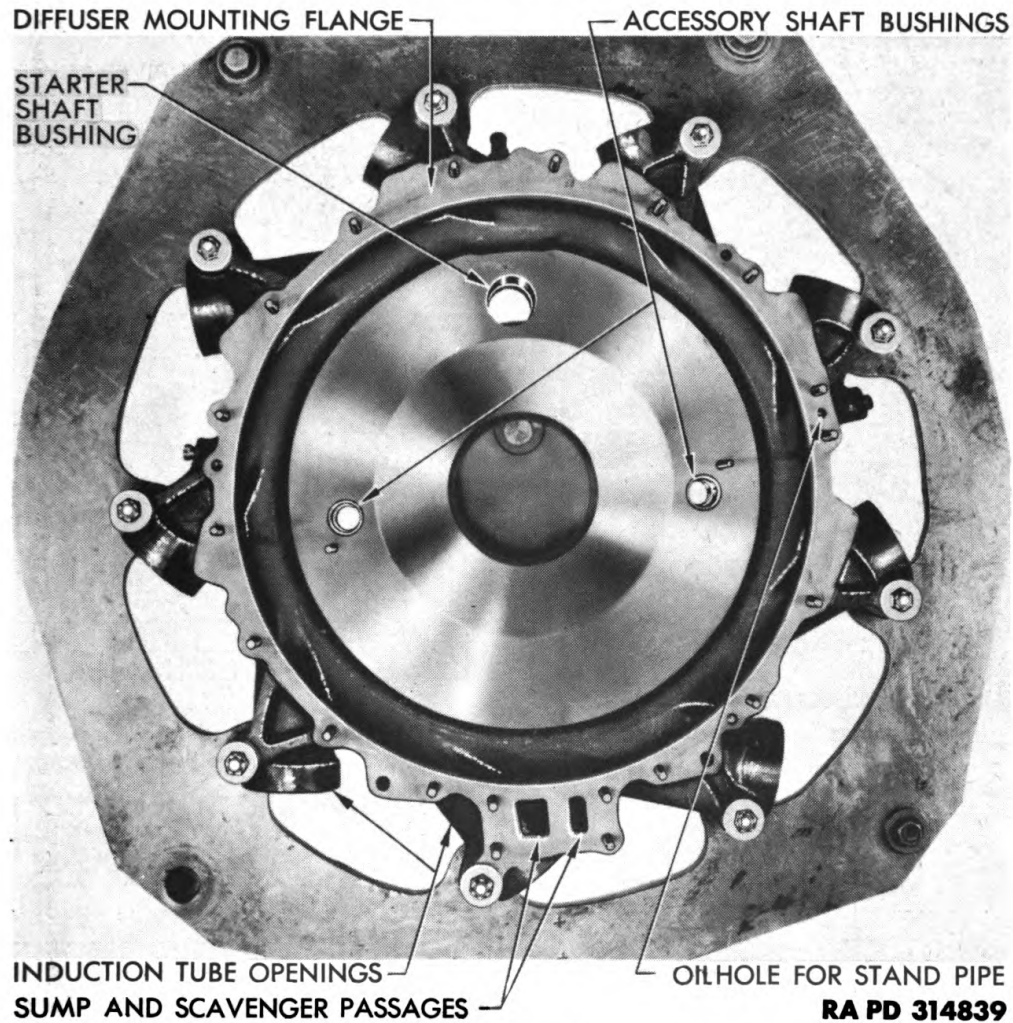

RA PD 314839

Figure 195 – Fuel Distribution Chamber Rear Crankcase Section

ing screw hole in seal (fig. 197). Screw bar into screw hole opening. Push seal over the accessory drive shaft until leather backing is positioned over shaft. Remove spreading and alining tools. Using driving tool, drive seal into section until it bottoms against seat (fig. 198). Install retaining screw. Install seal for other accessory drive shaft in the same way. Do not double under the leather portion of seal when they are being installed. Install small seal in end of each magneto coupling (fig. 199).

f. Install Oil Standpipe. Moving to front of rear crankcase section, position oil standpipe over standpipe hole located between the two closely spaced mounting studs in mounting flange for diffuser section. Push standpipe into hole. Be sure standpipe is pushed in all the way and is properly seated.

g. Cover Rear Crankcase Section. Do not install additional assemblies on rear crankcase section until diffuser section is attached

**ORDNANCE MAINTENANCE – ORDNANCE ENGINE
MODEL R975-C4 (CONTINENTAL)**

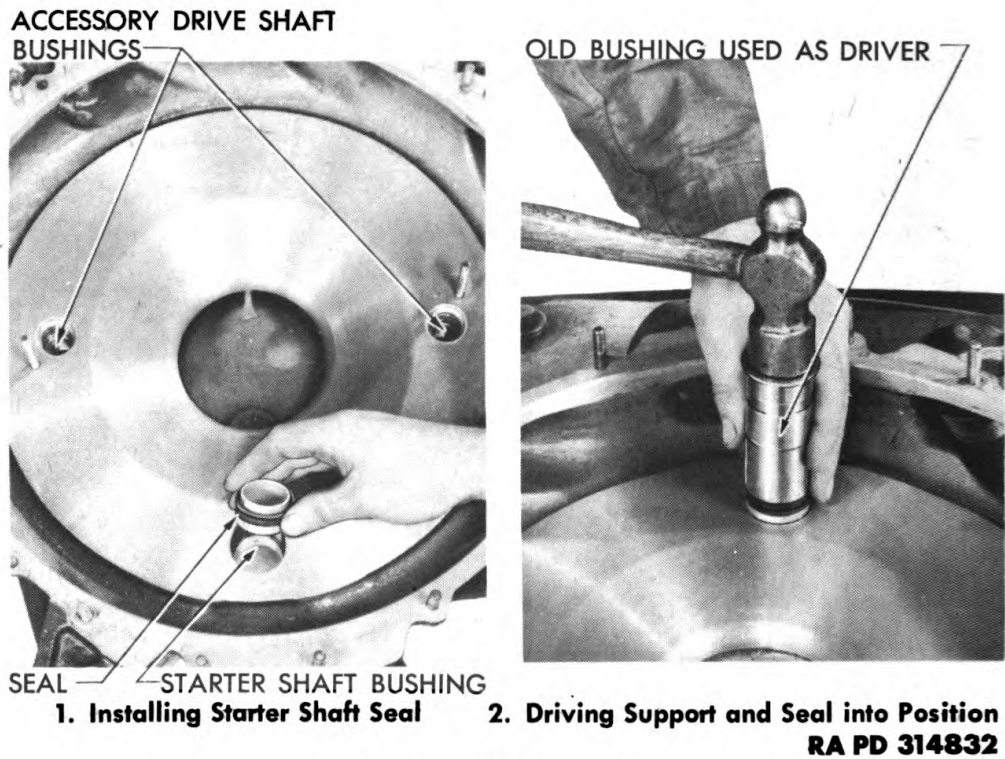

Figure 196 – Installing Starter Shaft Seal and Support

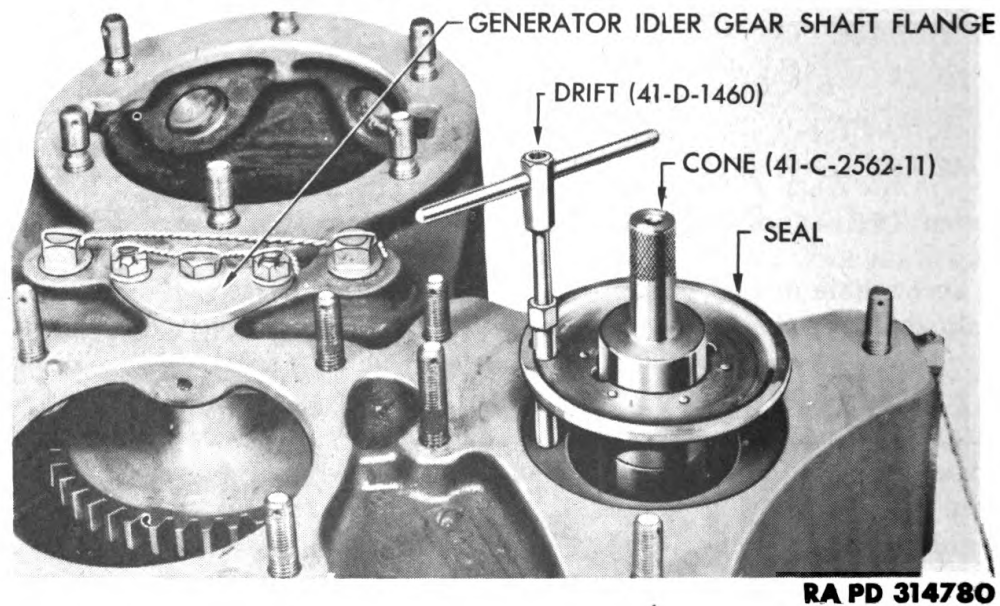

Figure 197 – Alining Retaining Screw Holes for Oil Seal

to rear section. This permits checking the alinement of the accessory drive gears in diffuser section bushings and matching gears in the rear crankcase section. Install cover over front of rear crankcase section to protect the assembly from dust and dirt.

ASSEMBLY OF SUBASSEMBLIES

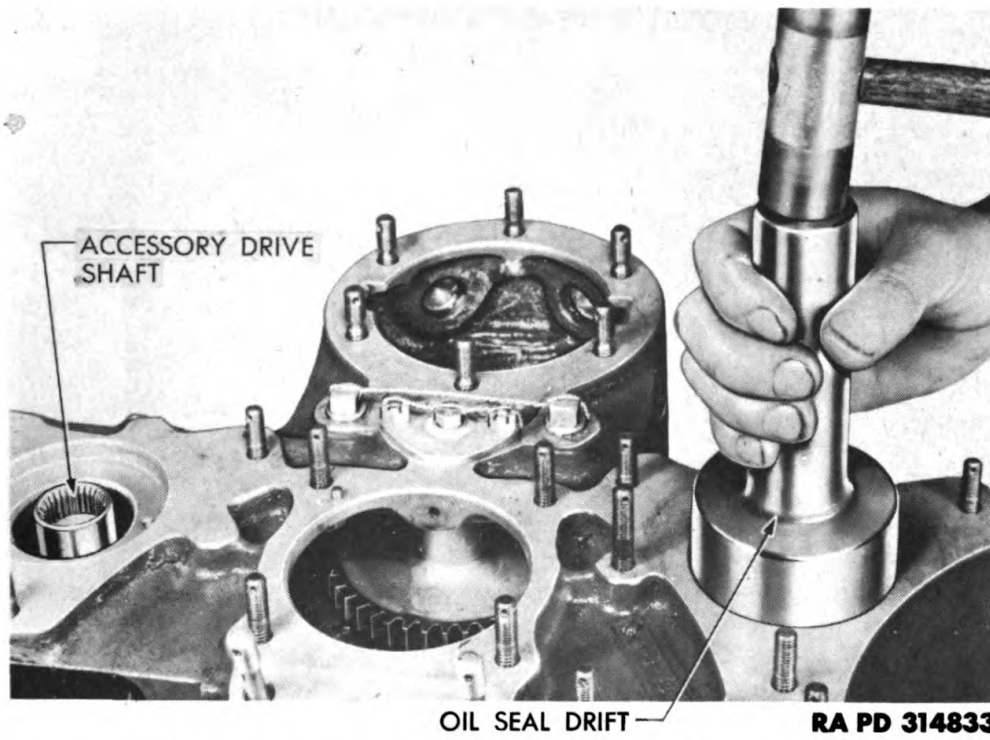

Figure 198 – Driving in Magneto Oil Seal Using Drift 41-D-1460

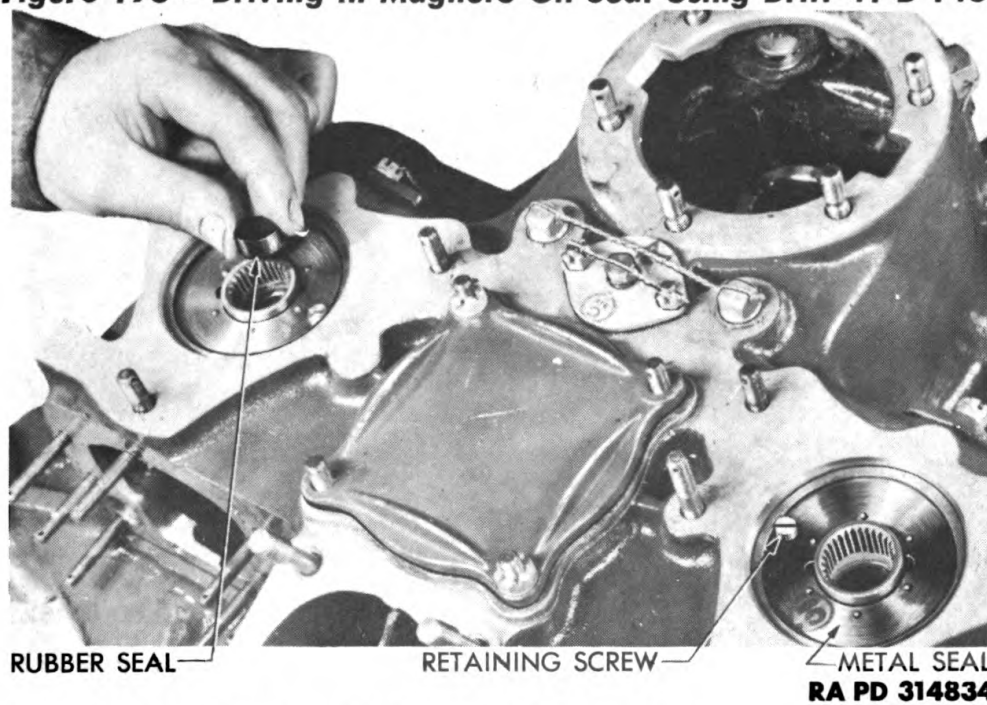

Figure 199 – Placing Rubber Seal in End of Accessory Drive Shaft

ORDNANCE MAINTENANCE — ORDNANCE ENGINE
MODEL R975-C4 (CONTINENTAL)

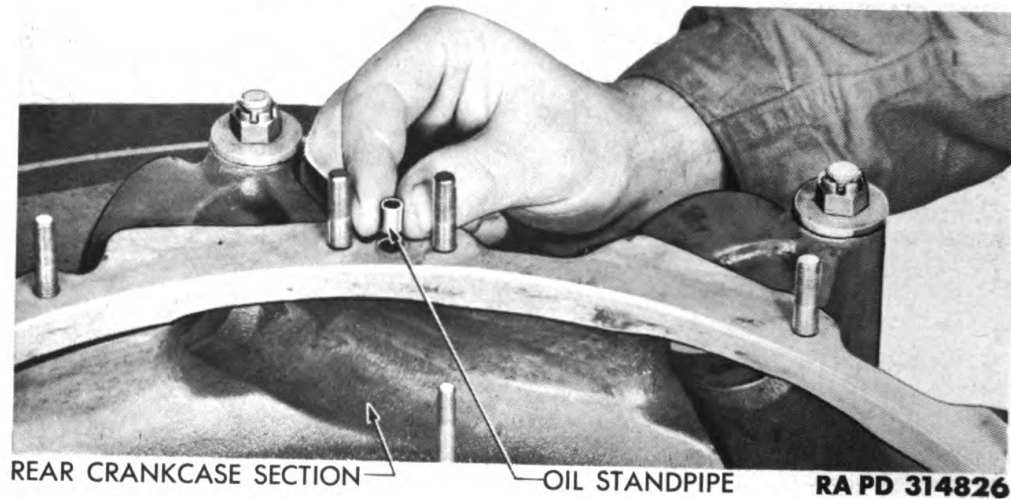

Figure 200 — Installing Oil Standpipe in Rear Crankcase Mounting Flange

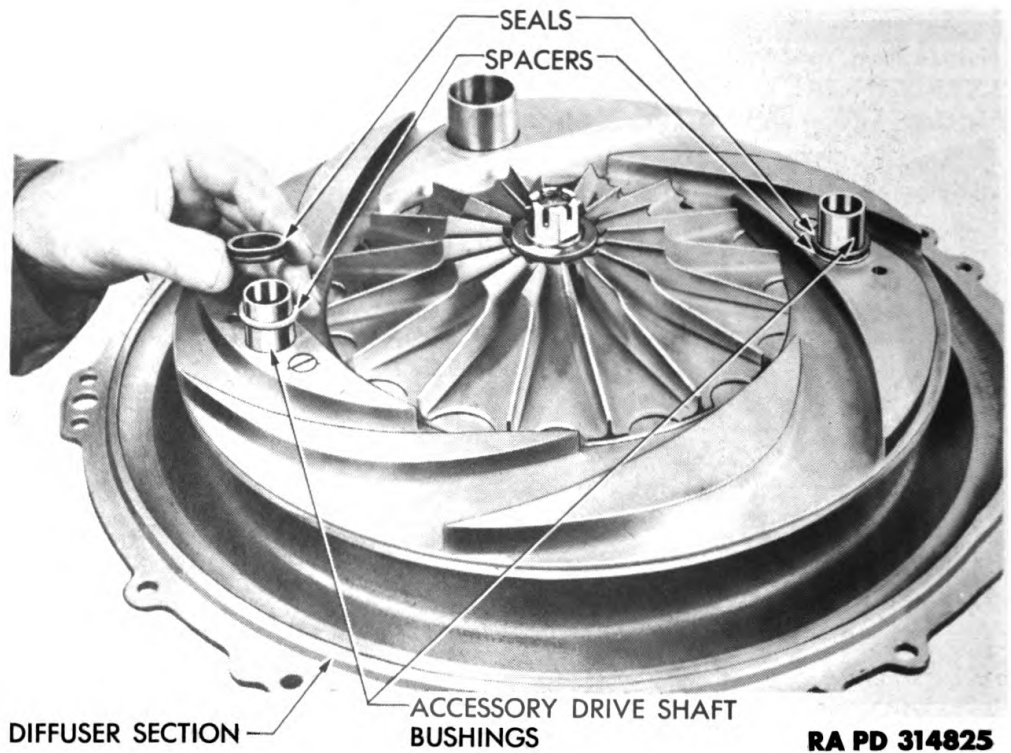

Figure 201 — Installing Spacers and Seals on Accessory Drive Shaft Bushings

h. Install Spacers and Rubber Oil Seals. With rear side of diffuser section facing up on bench, install spacers and rubber oil seals over accessory drive shaft bushings (fig. 201). Press spacers and oil seals down against diffuser ring.

ASSEMBLY OF SUBASSEMBLIES

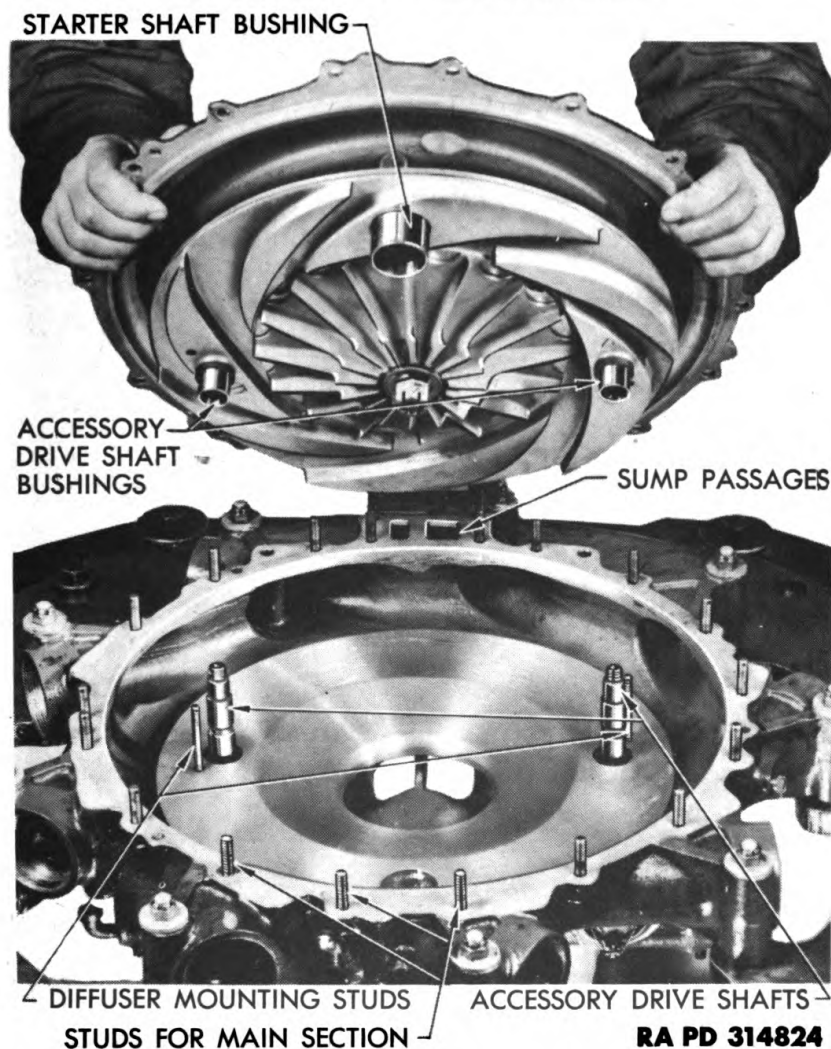

Figure 202 – Installing Diffuser Section on Rear Crankcase Section

i. Before installing diffuser section, make sure that lock and circlip are installed in rear impeller nut, that oil seals are installed, that hold-down screws for diffuser ring have been staked, and that the facing surfaces on the rear and diffuser crankcase sections are clean.

j. **Install Diffuser Section.** Coat matching flanges of rear and diffuser crankcase sections with sealing compound. Spread compound very thin. Position diffuser section on rear crankcase section studs (fig. 202). Align the section by noting the position of the sump drain openings. Tap the diffuser section with soft hammer to make sure that pilot on diffuser section enters the matching flange in the rear crankcase section. Install two diffuser section retaining nuts on studs. Tighten nuts to *not more than* 80 inch-pounds of torque. Install cotter pins through studs and nuts, and secure the cotter pins.

k. **Install Accessory Drive Gears.** Install keys in keyway of ac-

ORDNANCE MAINTENANCE – ORDNANCE ENGINE
MODEL R975-C4 (CONTINENTAL)

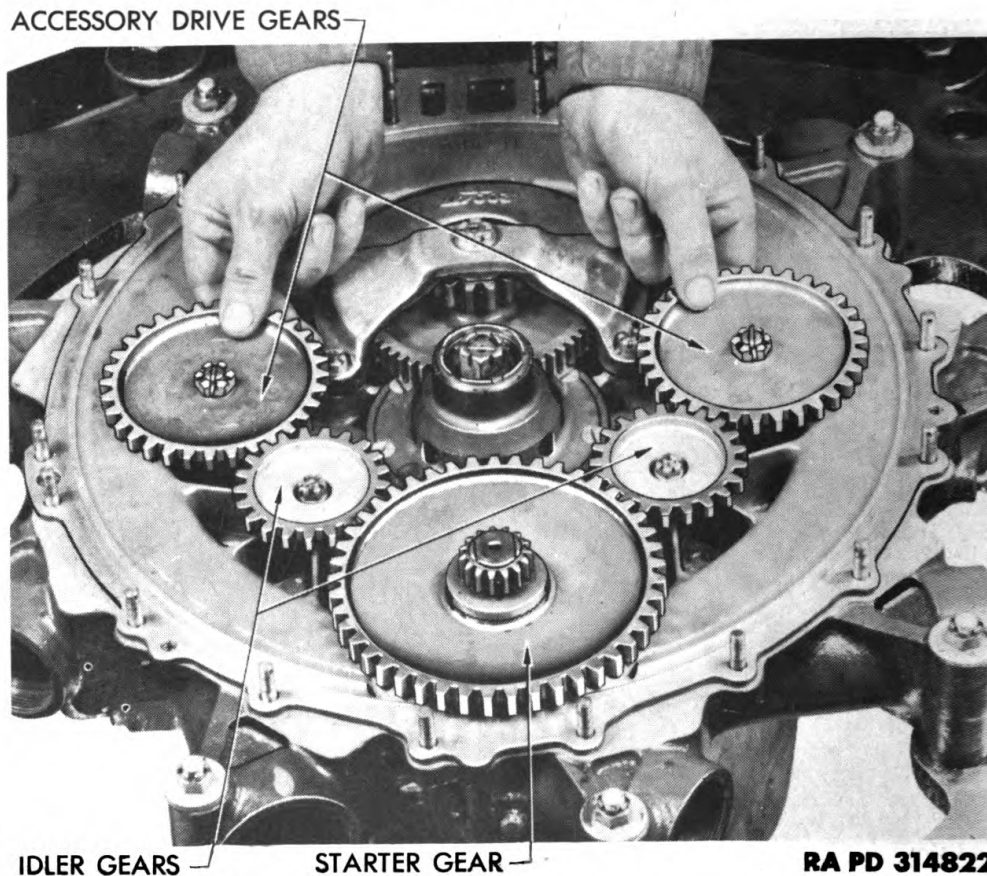

Figure 203 – Checking End Play of Accessory Drive Gears

cessory drive gear shafts. Install gears on shafts, matching keyway in gears with key in shaft. Do not drive gears into position. If gear and shaft keyways line up, gears can be installed easily. Install nuts on accessory drive gear shafts. Install fiber block between teeth of gears to prevent gears from turning. Tighten nuts to between 425 and 450 inch-pounds of torque. Secure nuts with cotter pins. Check all gears for end play (fig. 203). Working from the rear crankcase section, check accessory drive shafts for slight end play and for free turning through at least one complete revolution (fig. 204). End play should measure not less than 0.012 inch, nor more than 0.050 inch. If drive shafts do not turn freely, remove diffuser section, and check matching bushing in diffuser and rear crankcase sections. When bushings are properly aligned and in serviceable condition, reinstall diffuser section and proceed with assembly.

I. Install Starter Gear. Lubricate starter gear bushings in diffuser and rear crankcase sections. Install gear and starter shaft bolt through front of diffuser section (fig. 78). Install starter shaft through opening in rear crankcase section (fig. 77). Mount shaft

ASSEMBLY OF SUBASSEMBLIES

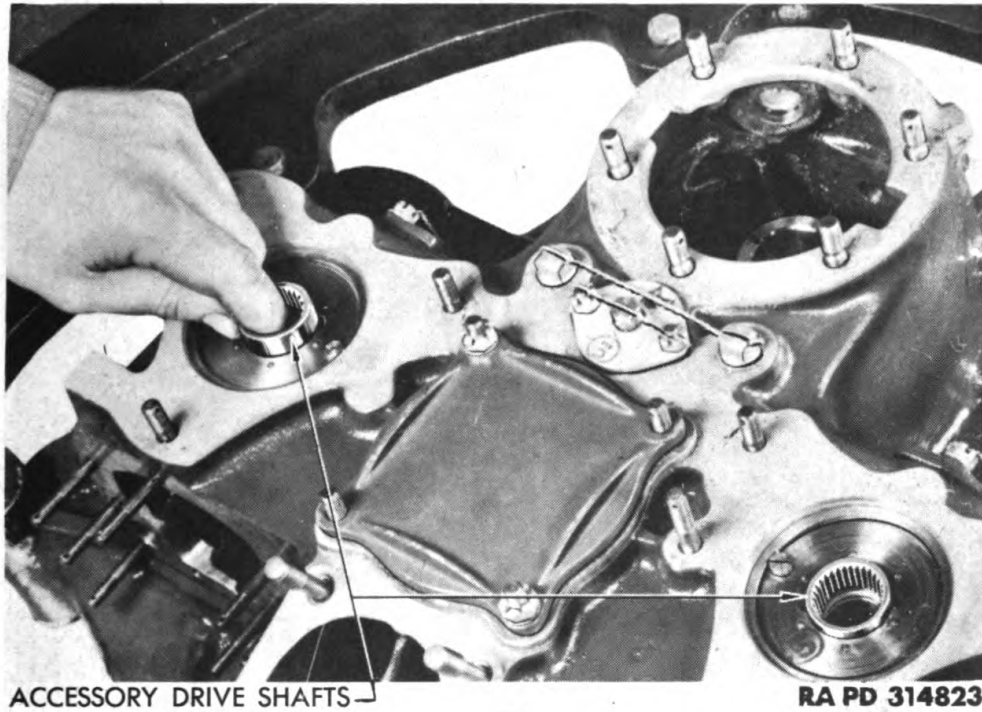

Figure 204 – Testing Rotation of Accessory Drive Shafts

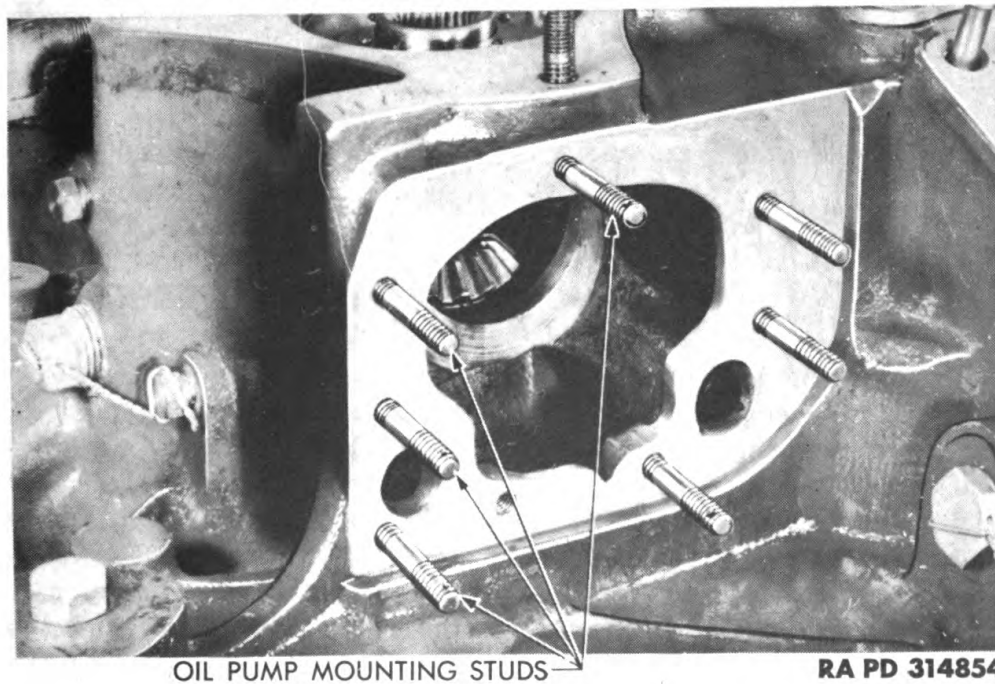
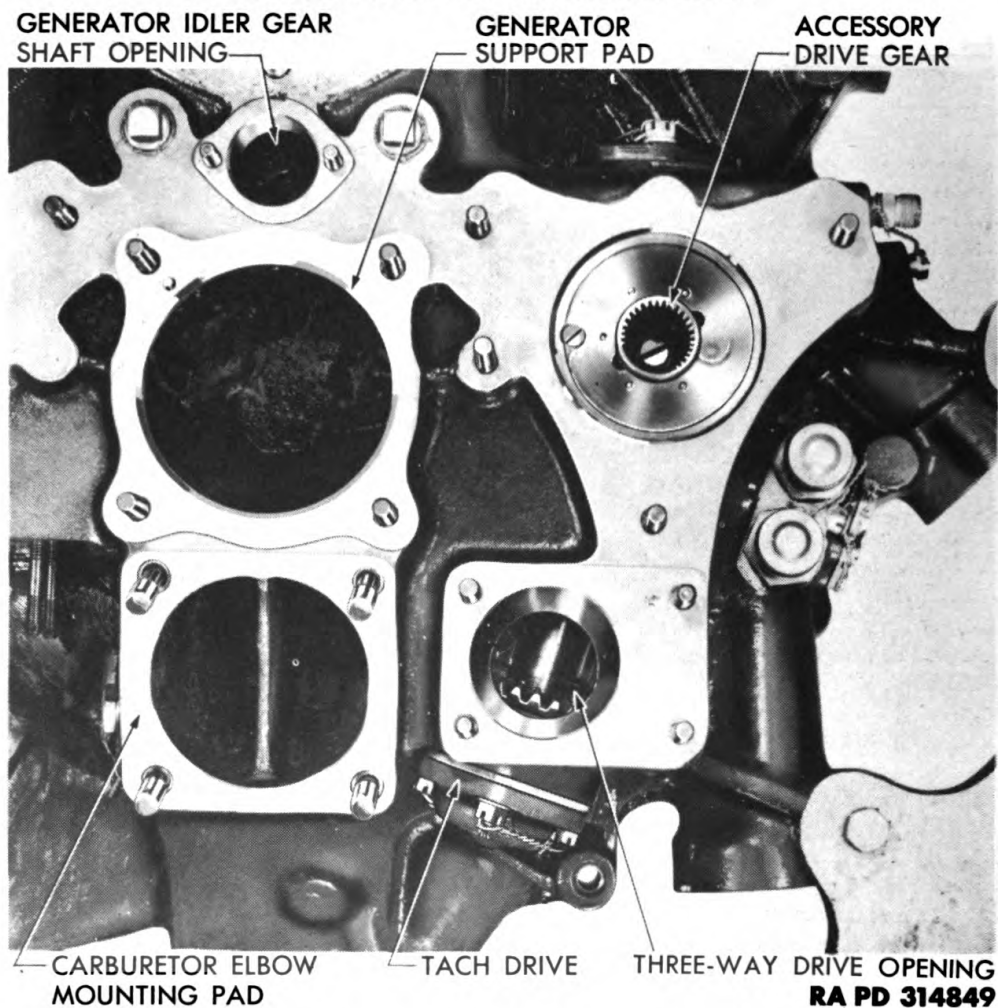

Figure 205 – Oil Pump Mounting Studs

over starter shaft bolt, and secure bolt through shaft by installing timing adjusting nut on end of bolt. With gears held stationary by fiber block placed between gear teeth, tighten starter shaft bolt nut to between 375 and 400 inch-pounds of torque. Check starter gear

ORDNANCE MAINTENANCE – ORDNANCE ENGINE
MODEL R975-C4 (CONTINENTAL)



**Figure 206 – Tachometer Drive Installed and Opening for
Three-way Housing Drive**

for perceptible end play. Remove fiber blocks from between the gears in the diffuser section. Rotate starter gear through at least one complete revolution to see that it turns freely. If gear does not turn freely, remove gear, separate the diffuser and rear crankcase sections. Check matching bushings in diffuser and rear crankcase sections. When bushings are properly aligned and in serviceable condition, reinstall diffuser section and proceed with assembly. Be sure to replace cover over starter opening on rear crankcase section.

m. Install Oil Pump. Lubricate oil pump thoroughly before installing it. Install new gasket over oil pump mounting studs at left of rear crankcase section. Position pump over end of opening and over studs. Make sure that pump drive gear is positioned to mesh with accessory drive gear. Install washers over eight studs, and

ASSEMBLY OF SUBASSEMBLIES

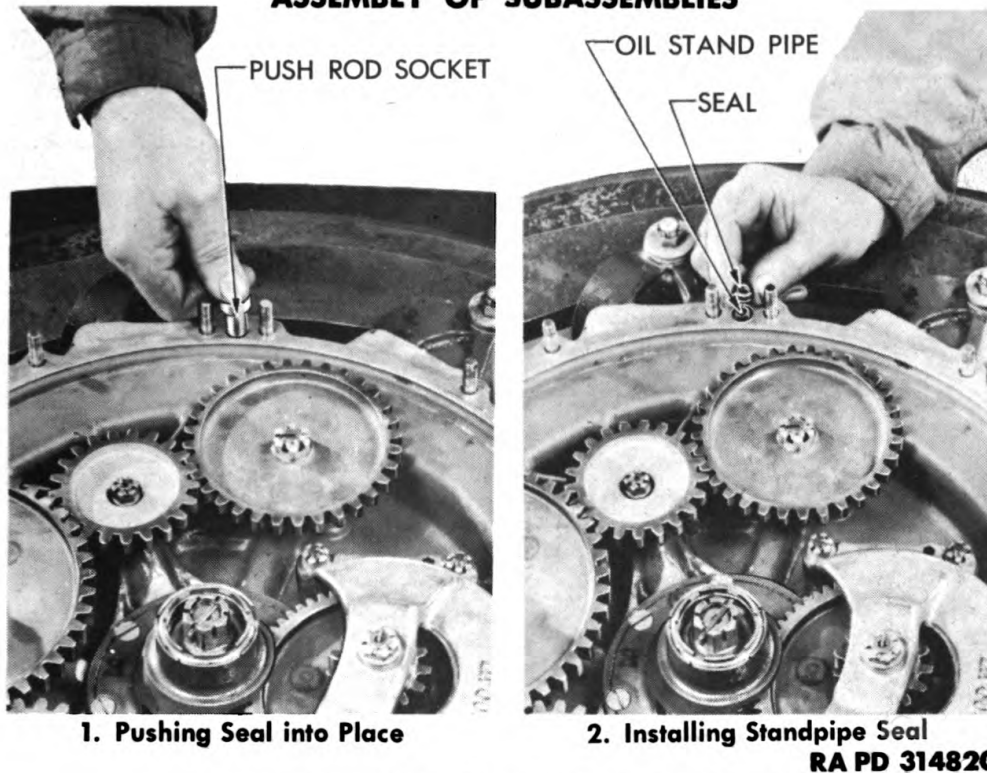

Figure 207 – Installing Standpipe Oil Seal

install eight attaching nuts. Start all nuts at one time, then tighten them with wrench (41-W-1577-500), in order, until they are all tightened securely. Insert cotter pins through nuts on the No. 1, 2, and 3 studs. Fasten nuts together with lock wire on No. 4, 5, and 6 studs. Fasten nuts together with lock wire on No. 7, and 8 studs (fig. 205).

n. Install Tachometer and Three-way Accessory Drive. Install new gasket over studs around opening for tachometer and three-way accessory drive. Position tachometer and three-way accessory drive over studs with opening for three-way housing towards matching opening in rear crankcase section (fig. 206). Install flat washers on three studs, and castellated nuts over washers. Tighten nuts securely, and fasten the three together with lock wire. Install tool for turning accessory drive gear in end of right magneto coupling. Turn gear with tool to make test operation of tachometer and three-way accessory drive gear.

o. Install Tachometer Drive. Install new gasket over three studs on right side of rear crankcase section. Position tachometer drive assembly on studs. Install flat washer and castellated nut on each stud. Tighten nuts securely, and fasten them together with lock wire. Install tool for turning accessory drive gear in end of right magneto coupling. Turn tachometer drive gear, and tachometer and three-way accessory drive gear, to test operation of the gears.

**ORDNANCE MAINTENANCE – ORDNANCE ENGINE
MODEL R975-C4 (CONTINENTAL)**

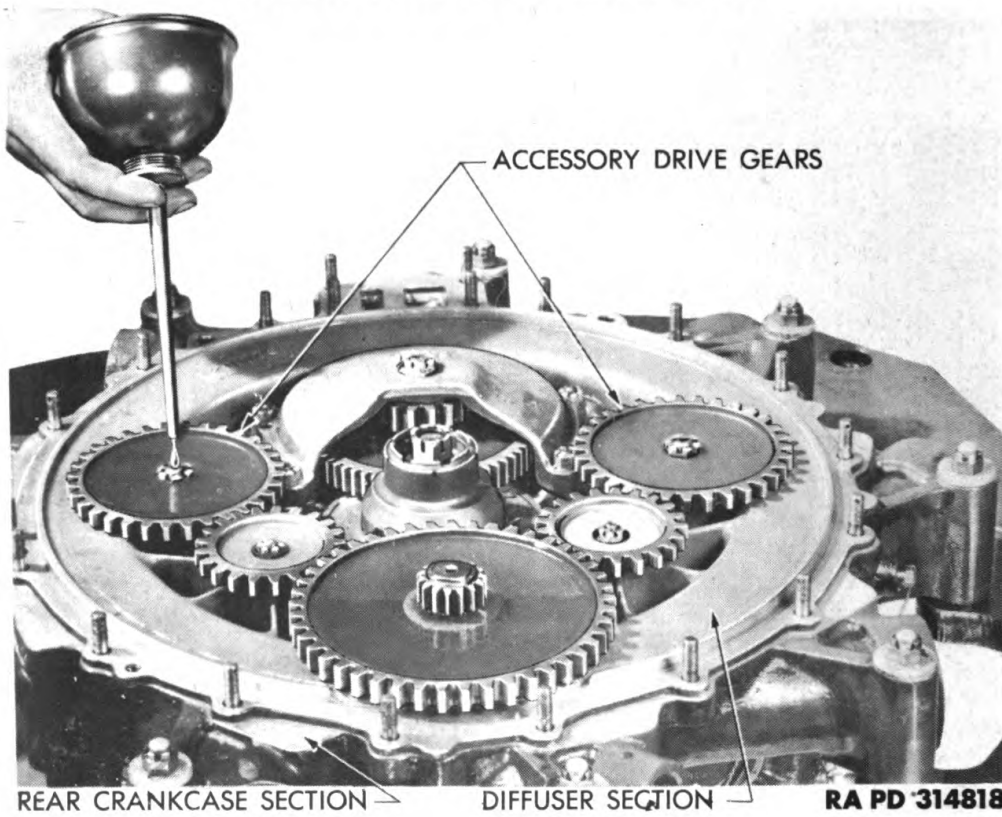

Figure 208 – Filling Gear Recesses with Oil

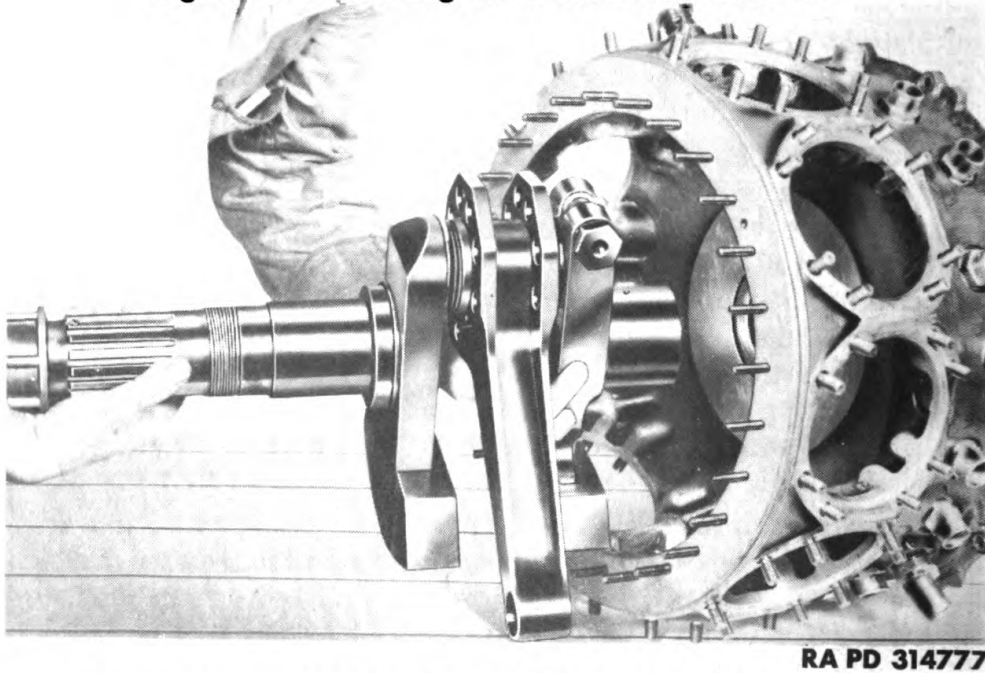

Figure 209 – Positioning Crankshaft for Installation

ASSEMBLY OF SUBASSEMBLIES

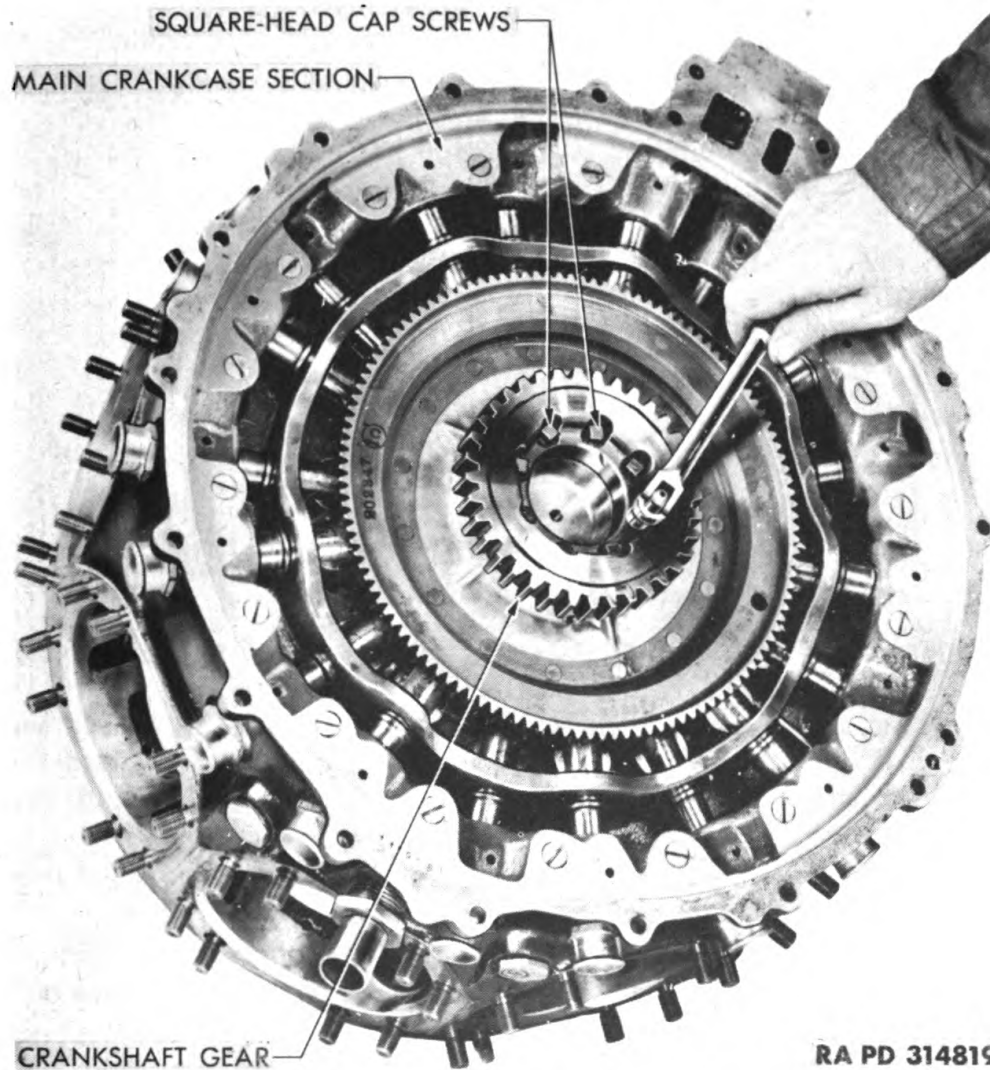

Figure 210 – Tightening Crankshaft Gear Retaining Screws

p. Install Three-way Drive Housing. Install new gasket over studs around opening for three-way drive gear in rear crankcase section. Make sure that three-way drive gear is positioned to mesh with tachometer and three-way accessory drive gear. Install housing over studs. Install flat washers and retaining nuts on each of five studs. Tighten nuts securely. The studs for two of the washers and nuts are inside the housing. Fasten the two nuts inside the housing with cotter pins. Fasten the three nuts outside the housing together with lock wire. Install new gasket over studs around spare drive opening in three-way housing. Place cover over studs. Place flat washers over studs and install nuts. Install sufficient flat washers over each stud so that the castellations on the attaching nuts line up with the safety wire hole in each stud. Tighten nuts securely, and fasten them together with lock wire.

ORDNANCE MAINTENANCE – ORDNANCE ENGINE
MODEL R975-C4 (CONTINENTAL)

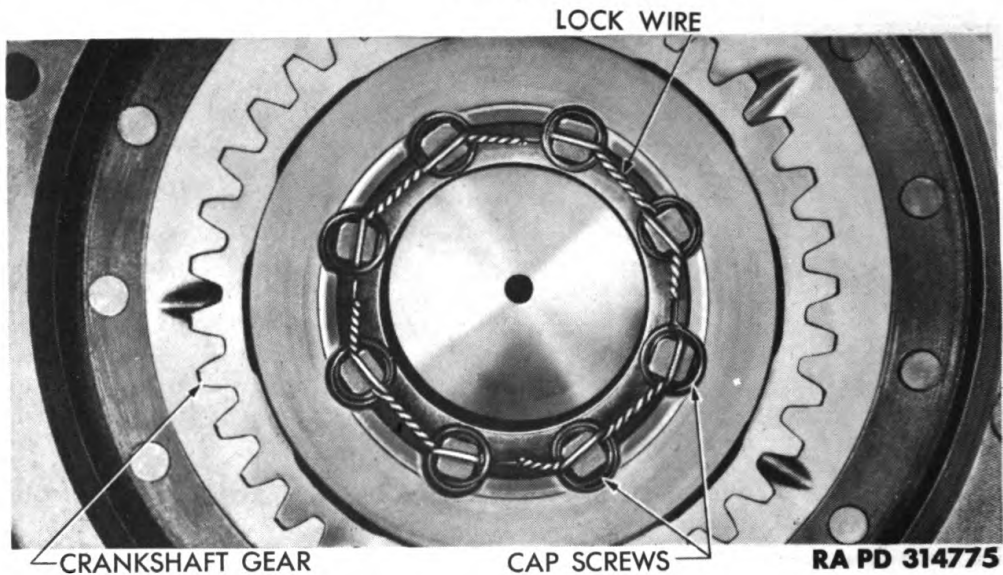

Figure 211 – Crankshaft Gear Attaching Cap Screws Secured

q. Install Oil Stand Pipe Seal. Place small, round, rubber seal for oil standpipe around pipe (fig. 207). Using a valve push rod socket as an installing tool, push seal down until seal is flush with face of diffuser section (fig. 207).

r. Spread Sealing Compound on Flanges. Apply a thin coating of sealing compound on matching flange of diffuser section.

s. Fill Gear with Oil. Fill the recess in all gears in the diffuser section gear train with light engine oil (fig. 208). The recesses hold approximately 1 quart of oil.

t. Cover Diffuser Section. Cover top of diffuser section to keep out dust and dirt until ready for installation of main crankcase section.

76. MAIN AND FRONT CRANKCASE SECTIONS, ASSEMBLY AND INSTALLATION.

a. Install Crankshaft and Master Rod Assembly. Place main crankcase section on bench with opening for No. 9 cylinder at bottom. Lubricate crankshaft rear journal. Lift assembly, and insert it in main crankcase section with counterweights opposite the No. 8 cylinder opening and the master rod pointing into the No. 1 cylinder opening (fig. 209). Insert crankshaft assembly into crankcase section very carefully, twisting it slightly so that the counterweights clear the opening. Make sure that the rear main bearing journal enters the bearing freely without forcing. If assembly is installed carelessly, the rear main bearing may be damaged. Place crankshaft gear on end of crankshaft so that holes in gear and crankshaft line up. Install eight square-headed cap screws. Tighten screws securely (fig. 210).

ASSEMBLY OF SUBASSEMBLIES

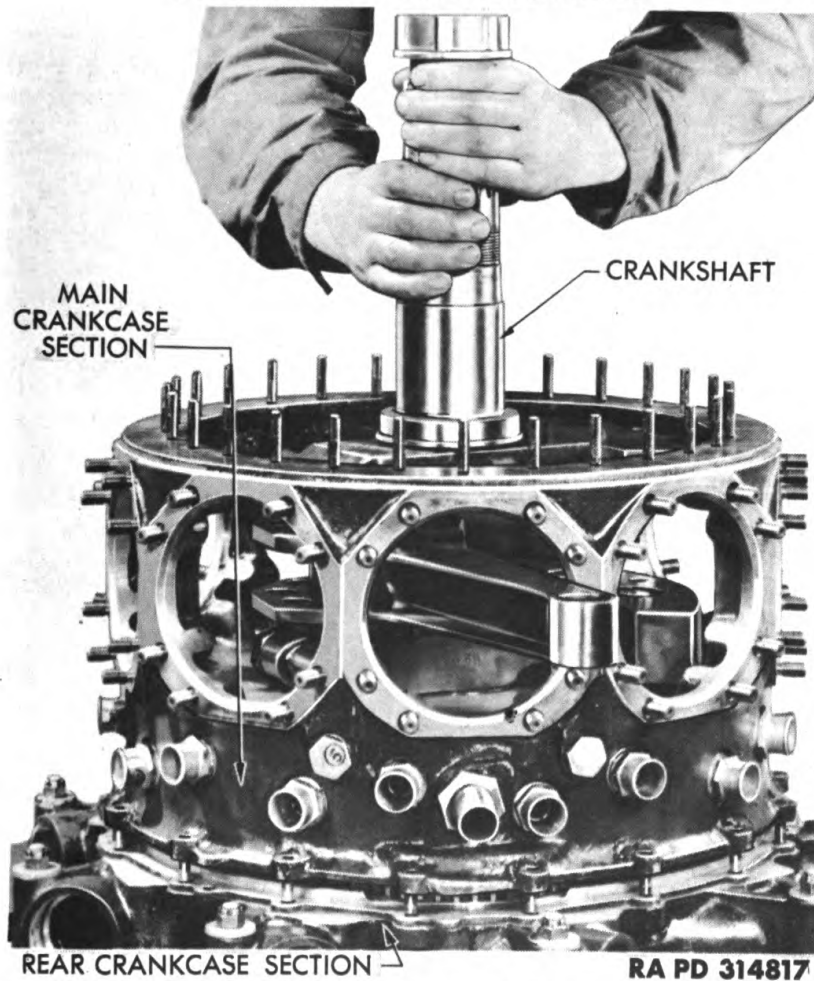

Figure 212 – Turning Crankshaft to Mesh Gear

Fasten screws with lock wire (fig. 211). Install protector for master rod on the No. 1 cylinder pad studs.

b. Install Main Crankcase Section. Spread a thin coat of sealing compound on mounting flange of main crankcase section. Remove covering from diffuser section. With the help of another person, lift main crankcase section and position it over diffuser and rear crankcase assembly, so that the sump drain openings in the main, diffuser, and rear crankcase sections line up. Lower main crankcase sections over rear crankcase section studs. Make sure that the oil standpipe enters the standpipe hole in the main section. Be sure that the crankshaft gear meshes with the starter and impeller drive gears before resting the entire weight of the main section on the rear section flange. Rotate crankshaft to mesh the gears (fig. 212).

c. Use of Lifting Eye. If lifting eye is available, assemble engine by following procedure explained in paragraph 76, subparagraphs a and f through o. When these steps have been completed, follow

**ORDNANCE MAINTENANCE – ORDNANCE ENGINE
MODEL R975-C4 (CONTINENTAL)**

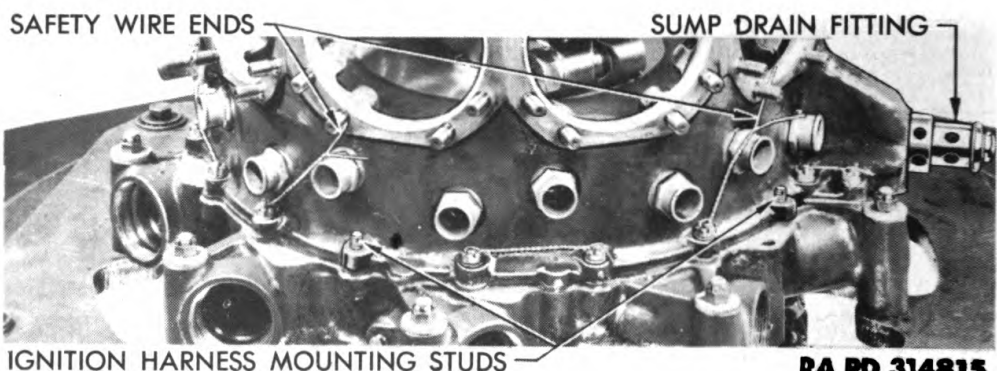
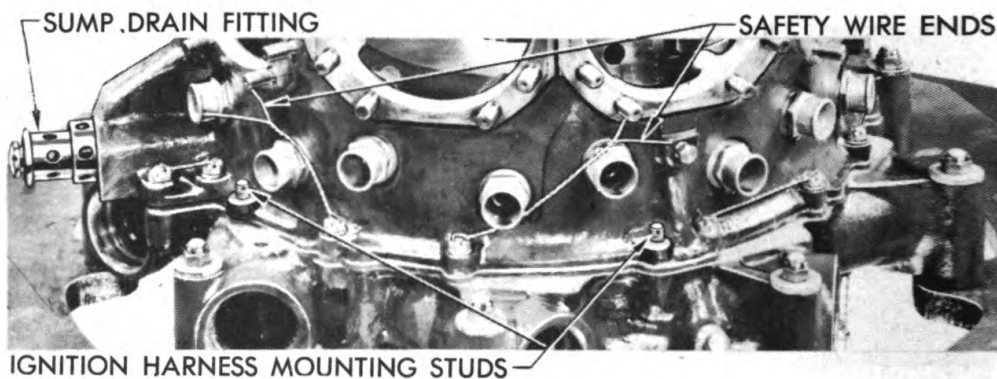

RA PD 314815

Figure 213 – Securing Crankcase Mounting Stud Nuts

procedure prescribed in subparagraph b except to lift the front and main crankcase sections for installation on the rear crankcase section with lifting eye and hoist (fig. 70). Do not lift main crankcase section with lifting eye attached to end of crankshaft, unless front crankcase section and front thrust bearing have been attached to main crankcase section. This operation might damage the rear main bearing by placing too much weight on it.

d. Secure Main Crankcase Section to Rear Section. Place flat washers on all rear crankcase section studs, except the four over which ignition harness is attached (fig. 213). Install washers and mounting nuts on studs. Using wrench (41-W-872-375), tighten each nut to between 160 and 175 inch-pounds of torque (fig. 214). Secure mounting nuts with lock wire. Leave ends of wire loose for attachment to ignition harness mounting nuts (fig. 213). Securing rear crankcase mounting nuts after installation of ignition harness is extremely difficult.

e. Install Ignition Harness. Loosen knurled nut securing two sections of ignition harness shielding, to loosen the sections and make installation easier. With open end of harness at bottom of main crankcase section, position four bracket holes in harness over four igni-

ASSEMBLY OF SUBASSEMBLIES

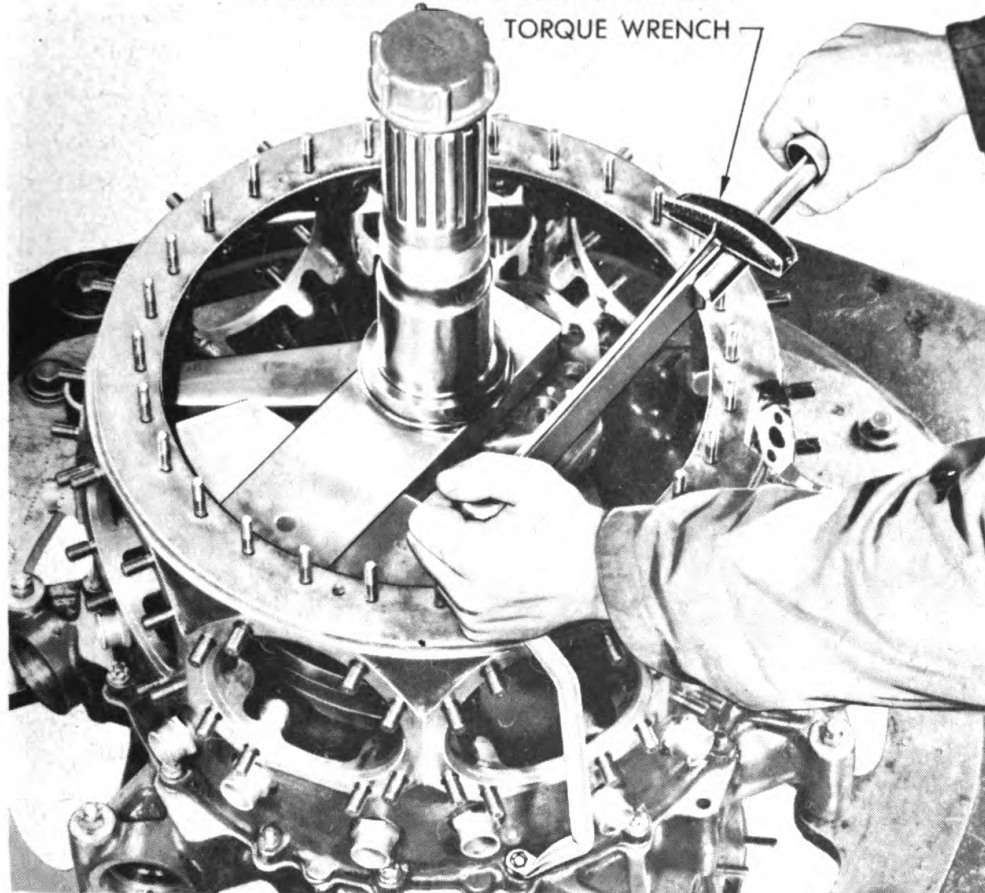

RA PD 314793

Figure 214 – Tightening Main Crankcase Mounting Stud Nuts Using Wrenches 41-W-872-375 and 41-W-3631

tion harness mounting studs in rear crankcase section (fig. 213). Tighten knurled nut to secure two sections of harness shielding tightly together. Install mounting nuts, but no flat washers, over ignition harness studs. Tighten each nut to 450 inch-pounds, using same wrenches used to tighten main crankcase section mounting nuts. Secure ignition harness mounting nuts with lock wire left loose when main crankcase section mounting nuts were secured.

f. Install Articulated Rods. Install articulated rods in pairs, the rod for the No. 2 cylinder with the rod for the No. 3 cylinder; the No. 4 rod with the No. 5 rod, etc. With the engine number stamped on each rod facing up, position the No. 2 rod through the No. 2 cylinder opening and between the flanges of the master rod. Position the No. 3 rod through the No. 3 cylinder opening in same way.

g. Install Knuckle Pins. Oil the bushing in each rod and the two knuckle pins which will secure the rods to the master rod. With the lock plate recess in the two knuckle pins facing each other (fig. 215), insert knuckle pin for each rod through the master rod flange and into the articulated rod bushing. Line up knuckle pins so that screw

ORDNANCE MAINTENANCE — ORDNANCE ENGINE
MODEL R975-C4 (CONTINENTAL)

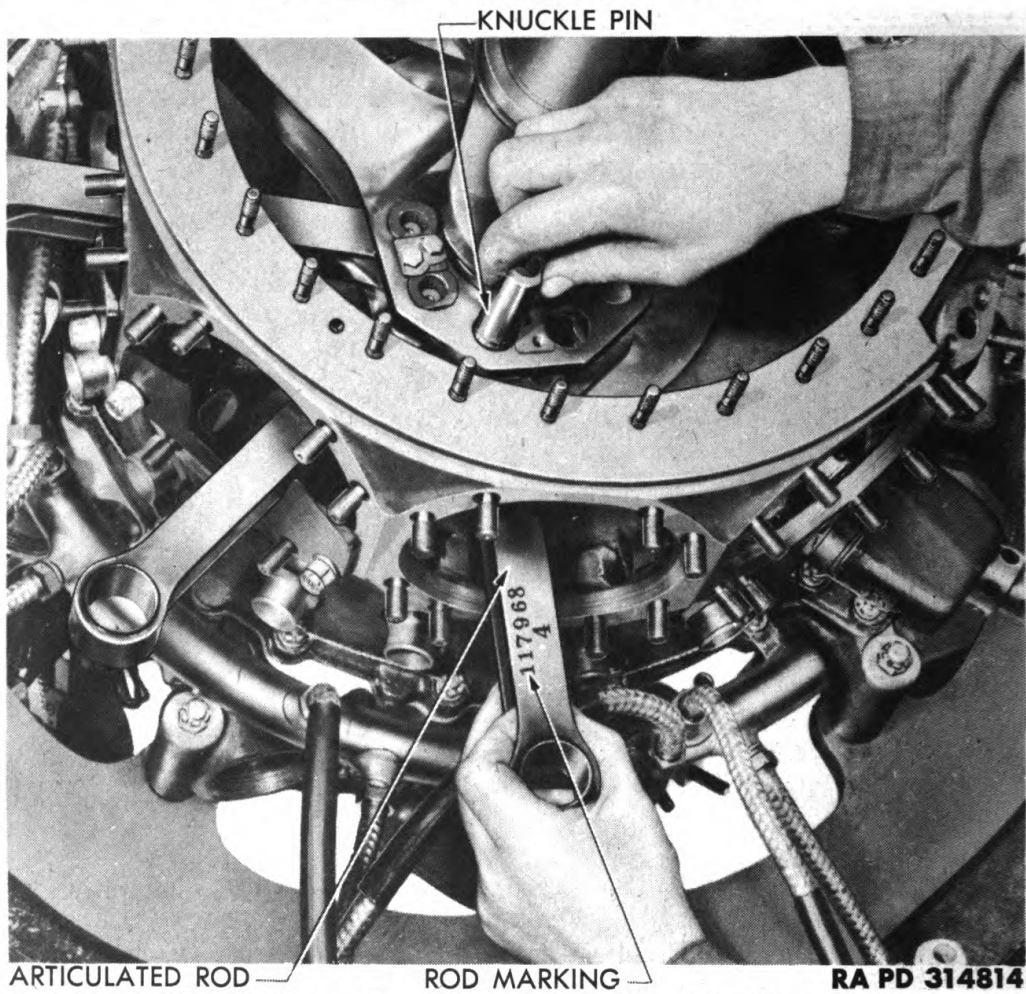

Figure 215 — Inserting Knuckle Pin

holes for lock plate line up with the lock plate screw holes in master rod. Drive knuckle pins into place with a drift (fig. 216). Select knuckle pin lock plate, and fit it between the knuckle pins, as all lock plates must be a tight fit between the knuckle pins. Install knuckle pin lock plates so screw holes line up with knuckle pin and master rod lock plate screw holes. Install retaining plate over lock plate. Install two cap screws in lock plate screw holes, and tighten them securely. Bend thin retaining plate outer edges up against flat sides of hexagon cap screws (fig. 217). Install rod protector for each articulated rod on cylinder hold-down studs. Install remaining articulated rods in pairs by same method. **NOTE: Be sure to install rod protector on each rod after installation.**

h. Install Front Main Bearing. If bearing inner race was removed during disassembly, position bronze inner spacer on crankshaft with radius down (fig. 218). Heat bearing inner race to approximately 250°F. Position inner race over crankshaft with bearing

ASSEMBLY OF SUBASSEMBLIES

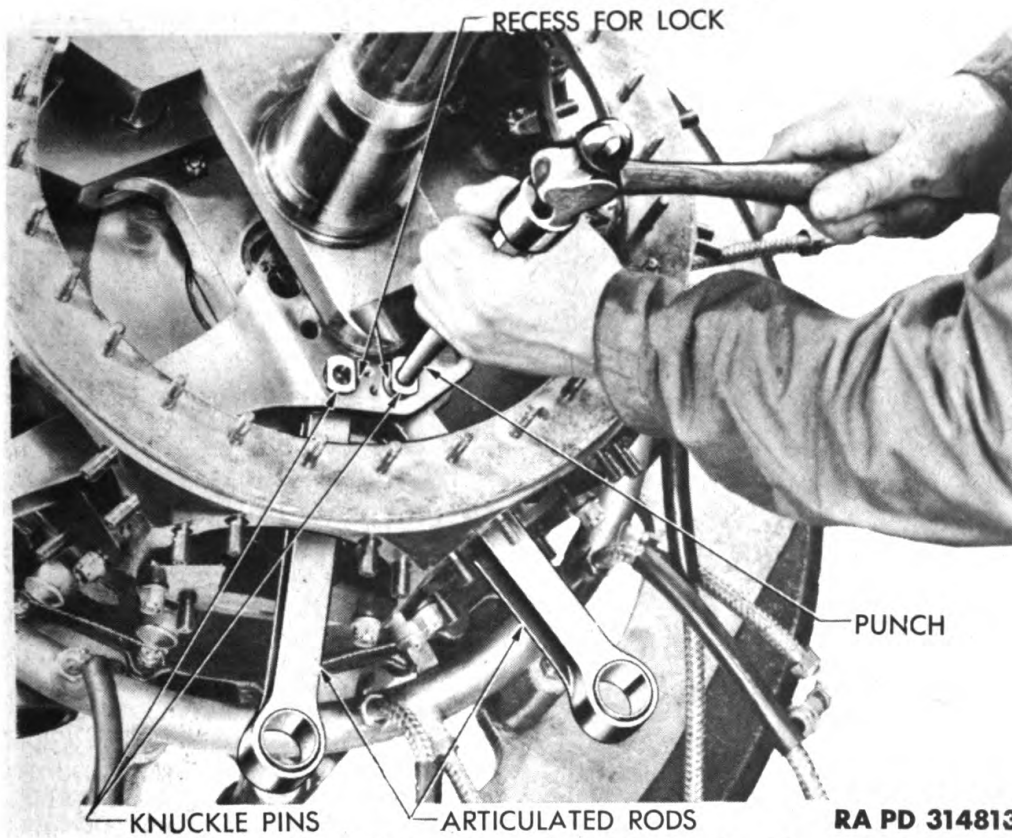

Figure 216 – Driving in Knuckle Pin

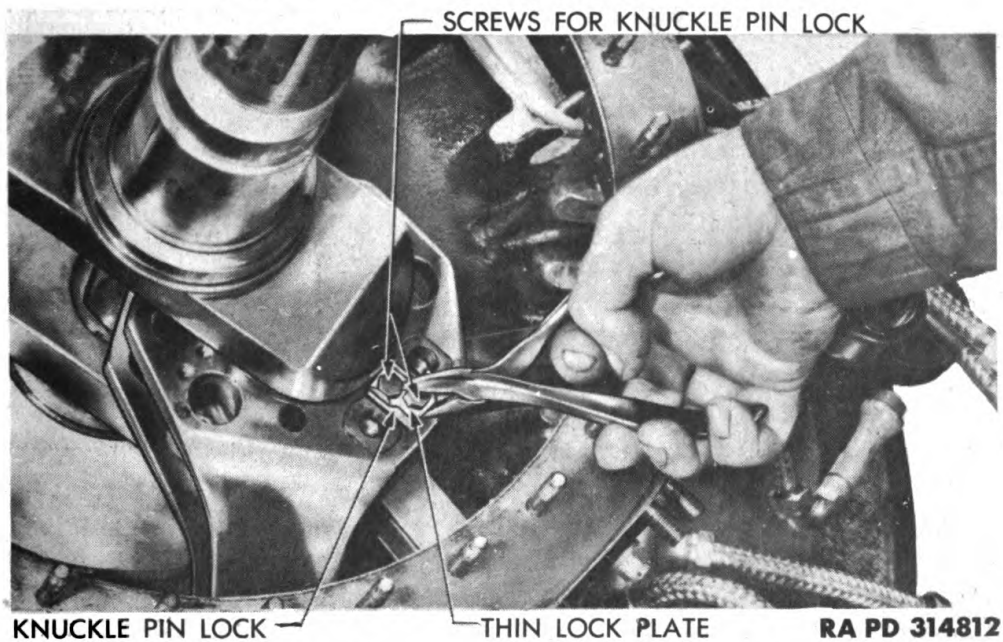
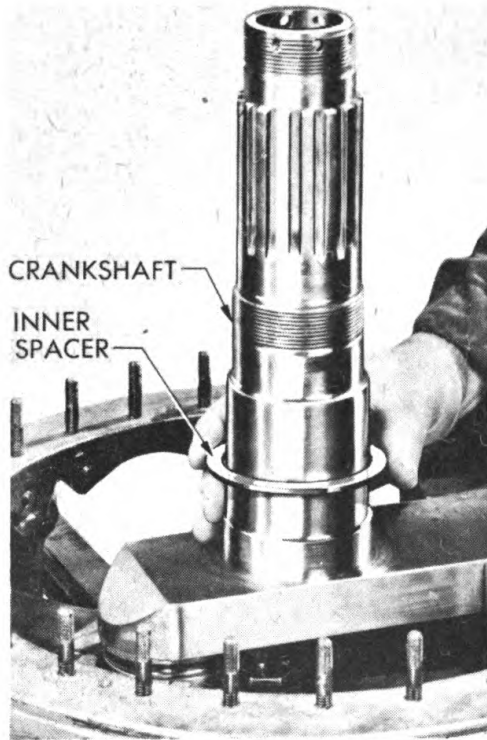

Figure 217 – Bending Retaining Plate

**ORDNANCE MAINTENANCE — ORDNANCE ENGINE
MODEL R975-C4 (CONTINENTAL)**



RA PD 314811

Figure 218 — Installing Front Main Bearing Spacer

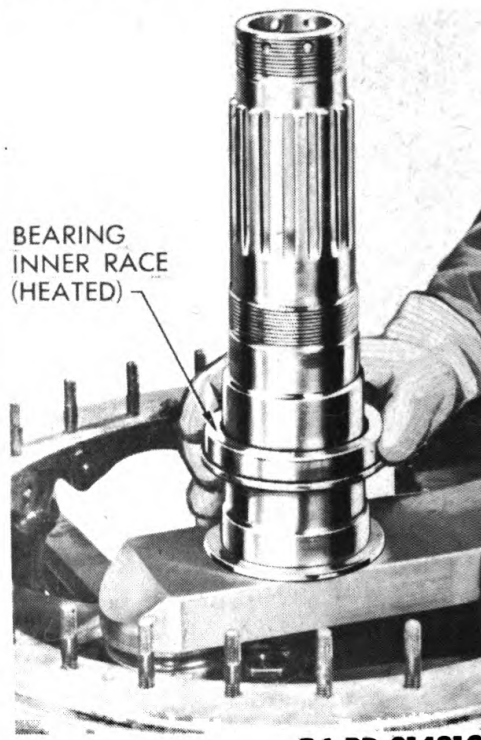

RA PD 314810

Figure 219 — Installing Front Main Bearing Inner Race

flange down (fig. 219). Shoulder flange against spacer. Check bearing outer race to see that rollers are in place and are properly lubricated. Lower outer race and rollers onto inner race. Push rollers back into outer race so that race will drop into position against flange of inner race (fig. 220). Lower outer spacer into position over crankshaft (fig. 221).

i. Install Front Main Bearing Support. Apply a thin coat of sealing compound to matching surface of front main bearing support (fig. 222). Position support over main crankcase section so that sump connection cut-out in support matches sump connection cut-out in main section (fig. 223). Lower support over main section studs. Tap support evenly all around with soft hammer until it seats positively against main crankcase section.

j. Install Thrust Bearing Spacer. With either end down, place thrust bearing spacer over crankshaft (fig. 224). Spacer controls clearance between crankshaft rear crank and rear main bearing.

k. Install Crankcase Front Section. Apply a thin coat of sealing compound to matching flange of front crankcase section (fig. 222). Position front crankcase section over main crankcase section by pointing breather connection in front section directly towards No. 1 cyl-

ASSEMBLY OF SUBASSEMBLIES

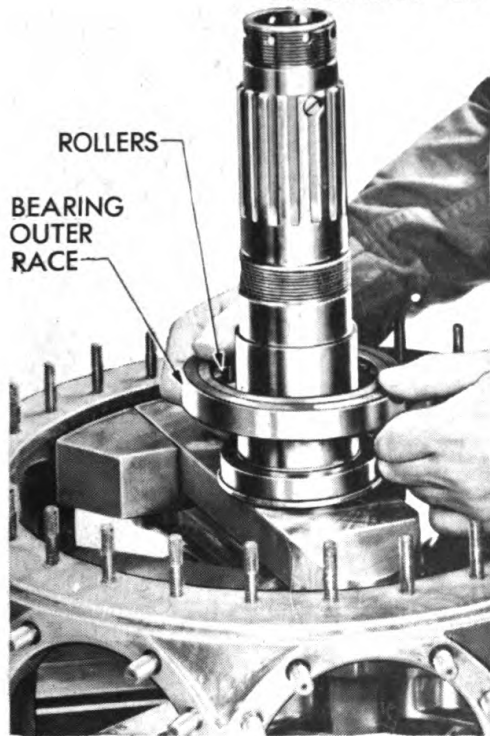

RA PD 314809

Figure 220 – Installing Front Main Bearing Outer Race and Rollers

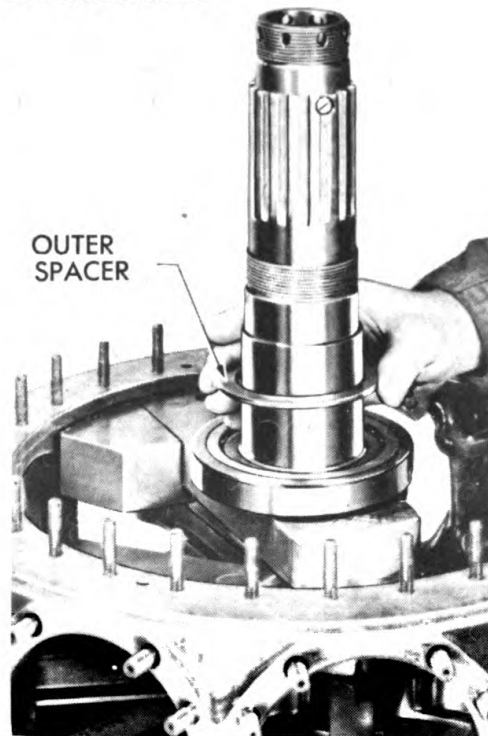

RA PD 314808

Figure 221 – Installing Spacer on Top of Front Main Bearing

inder opening in main section. Lower front section over main crankcase section studs. Tap front crankcase section all around with soft hammer to insure positive contact of matching flanges.

l. Install Front Thrust Bearing. With markings on front thrust bearing facing up, place bearing over crankshaft. Using driver, drive bearing into recess in front crankcase section (fig. 225). Install flat washers over main crankcase section mounting studs, and install mounting nuts. Tighten mounting nuts securely and evenly, and secure with lock wire. Tighten lock wire by method shown in figure 226. Install front cover section laminated shim over front crankcase section mounting studs and dowel (fig. 227). Place front cover in position over studs and against shim.

m. Check Front Cover Clearance. Check clearance between front cover and front crankcase section (fig. 228) with feeler gage. Clearance should measure 0.004 inch, so that when the cover is tightened down, it will hold the crankshaft thrust bearing securely in place. If clearance is less than 0.004 inch, remove cover and install new laminated shim. Peel off shim laminations until proper clearance is obtained. If clearance is greater than 0.004-inch, peel off shim laminations until correct clearance is obtained. **CAUTION:** *When*

**ORDNANCE MAINTENANCE – ORDNANCE ENGINE
MODEL R975-C4 (CONTINENTAL)**

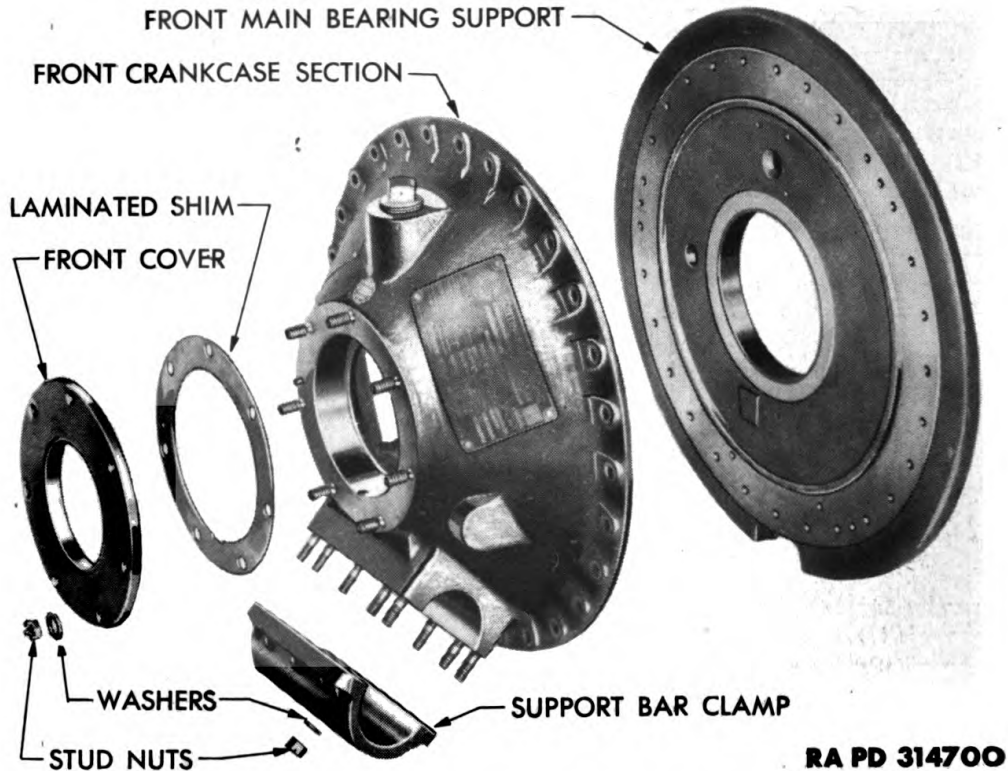

Figure 222 – Front Main Bearing Support, Front Crankcase Section, and Cover – Disassembled

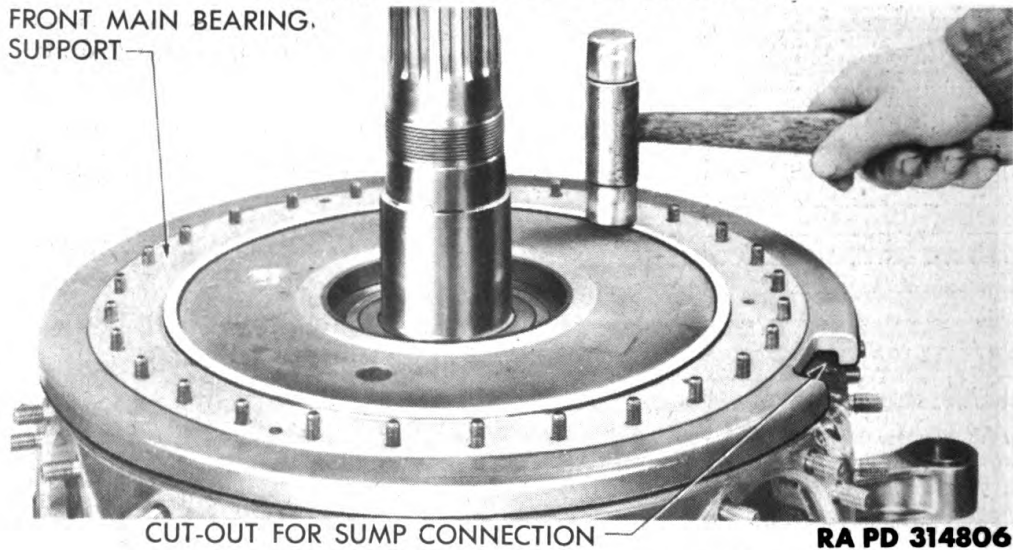

Figure 223 – Installing Front Main Bearing Support

removing shim laminations, be sure to remove a complete lamination, not just a portion of it.

n. Install Front Thrust Nut. Lubricate thrust nut oil seal rings in grooves on thrust nut. Place thrust nut over end of crankshaft.

ASSEMBLY OF SUBASSEMBLIES

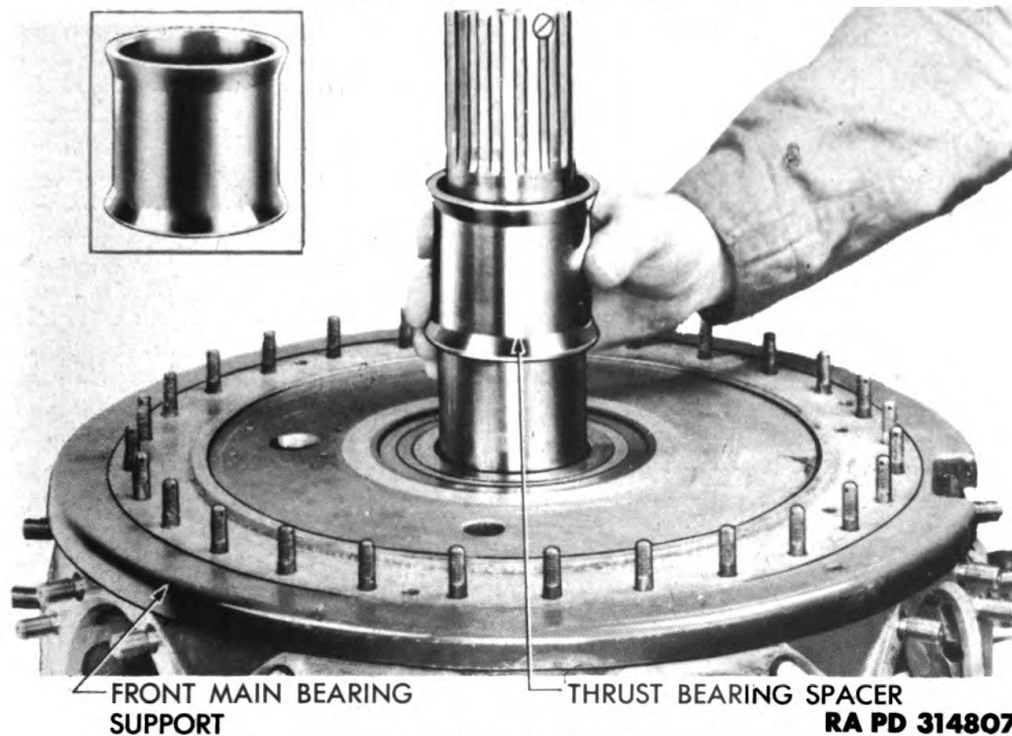

Figure 224 – Installing Thrust Bearing Spacer

Install special ring compressor on rings and compress them. Secure thrust nut in recess in front cover by holding rings compressed and turning thrust nut on crankshaft threads (fig. 229). Turn nut until oil seal rings are compressed below surface of cover. Remove ring compressor. Using special wrench (fig. 59), and holding crankshaft from turning, tighten thrust nut very securely.

o. Secure Front Section Cover. Install flat washers over front crankcase section studs. Place attaching nuts on studs. Tighten nuts from 225 to 250 inch-pounds of torque.

p. Check Crankshaft End Clearance. Measure crankshaft clearance between rear crank and edge of rear main bearing with feeler gage (fig. 231). If clearance is less than 0.025 inch, disassemble front crankcase section, and grind off one end of thrust bearing spacer. If clearance is more than 0.045 inch, disassemble front crankcase section, and replace thrust bearing spacer. Reassemble front crankcase section, and recheck crankshaft clearance to make sure it falls between allowable limits. Secure attaching nuts with lock wire in groups of two, two, and three. Install split bronze cone on end of crankshaft.

77. CYLINDER, VALVE, AND VALVE OPERATING MECHANISM INSTALLATION.

a. Prepare Engine for Cylinder Installation. Install timing bar on front end of crankshaft. Hang nine new cylinder barrel rubber

ORDNANCE MAINTENANCE — ORDNANCE ENGINE
MODEL R975-C4 (CONTINENTAL)

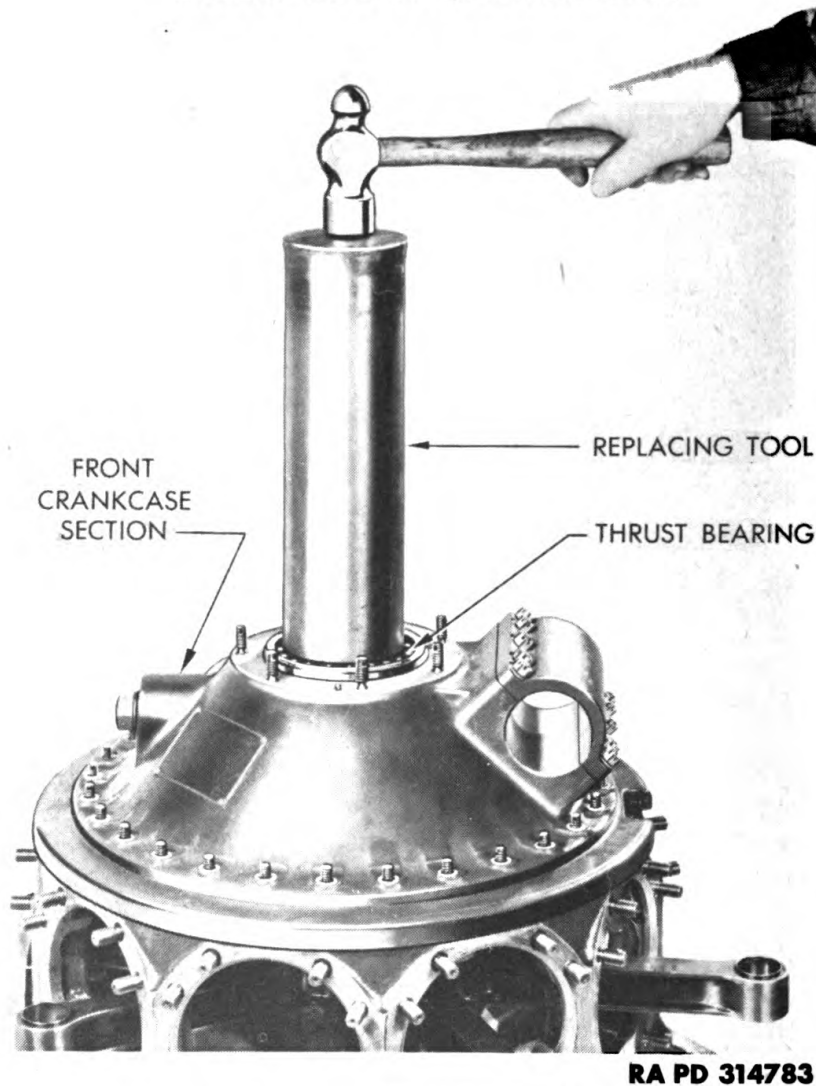

Figure 225 — Installing Front Thrust Bearing

seals on timing bar (fig. 232). Identifying cylinders by number stamped on front of rocker boxes, select the No. 1 cylinder assembly. Clean assembly. Install rear spark plug, and tighten it from 450 to 480 inch-pounds of torque. Oil cylinder bore. Remove cylinder barrel-seal from timing bar, and place it around base of cylinder against barrel flange. Place assembly on bench until ready to install in engine.

b. Install No. 1 Piston. Turn engine with timing bar until master rod is at top center. Remove master rod protector. Clean the No. 1 piston, piston pin, and piston retaining plugs in dry-cleaning solvent. Dry them with compressed air. Lubricate piston pin and the piston pin bushing in master rod. Place piston over master rod, and install

ASSEMBLY OF SUBASSEMBLIES

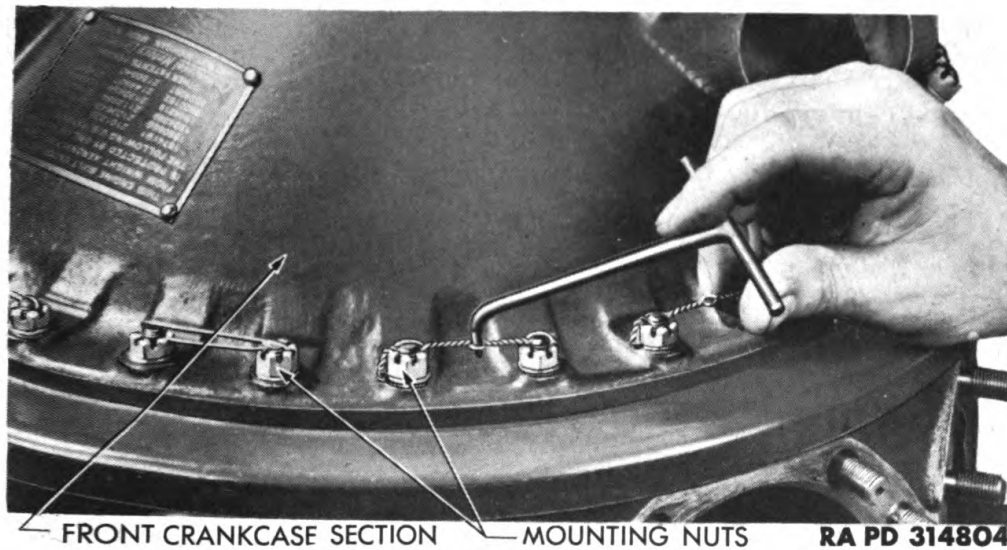

Figure 226 – Securing Front Crankcase Section

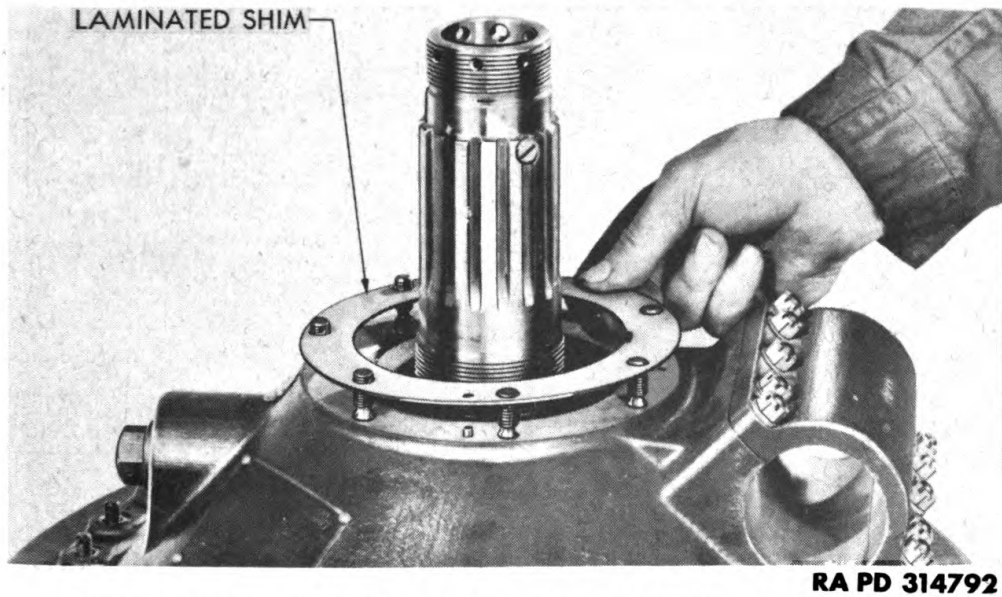
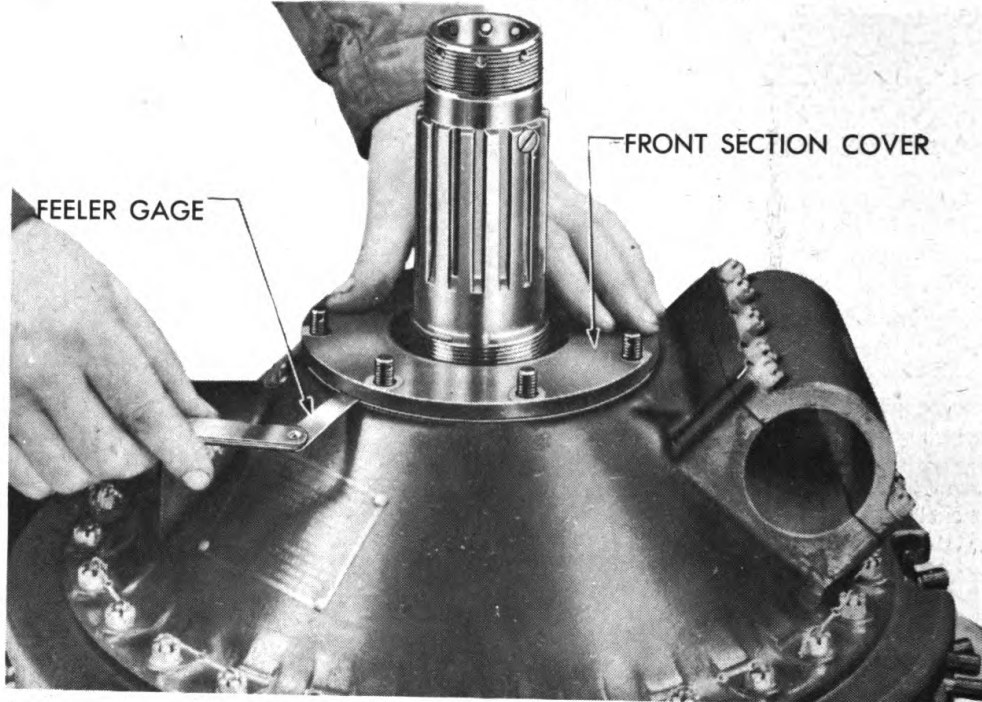

Figure 227 – Installing Laminated Shim for Front Cover

piston pin. Install piston pin retaining plugs in ends of piston pin. Hold bottom plug in position, and install ring compressor (41-C-2550-80) over piston rings (fig. 232). Compressor will hold retaining plugs in position until cylinder is installed.

c. **Install No. 1 Cylinder.** Holding cylinder in one hand and compressor on piston assembly with the other, slide cylinder straight over piston assembly (fig. 232). Do not rock cylinder up and down to install it. Remove piston ring compressor as it is forced off piston skirt. Holding cylinder, install eight cylinder hold-down nuts on cylinder hold-down studs. Tighten nuts to 450 inch-pounds of torque

ORDNANCE MAINTENANCE – ORDNANCE ENGINE
MODEL R975-C4 (CONTINENTAL)



RA PD 314789

Figure 228 – Checking Clearance at Front Cover Using
Gage 41-G-400

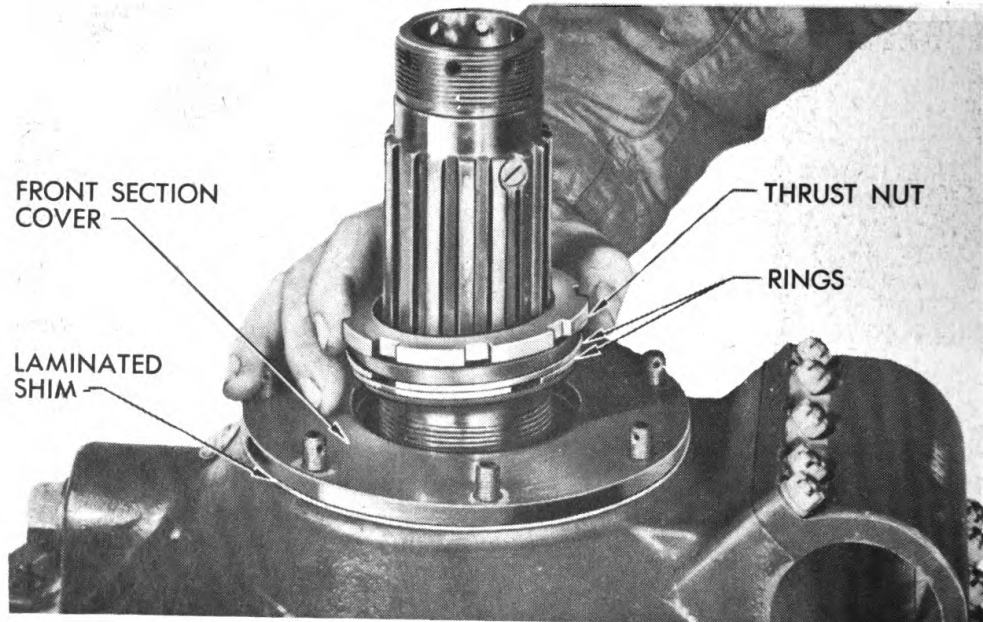

RA PD 314791

Figure 229 – Installing Front Thrust Nut

ASSEMBLY OF SUBASSEMBLIES

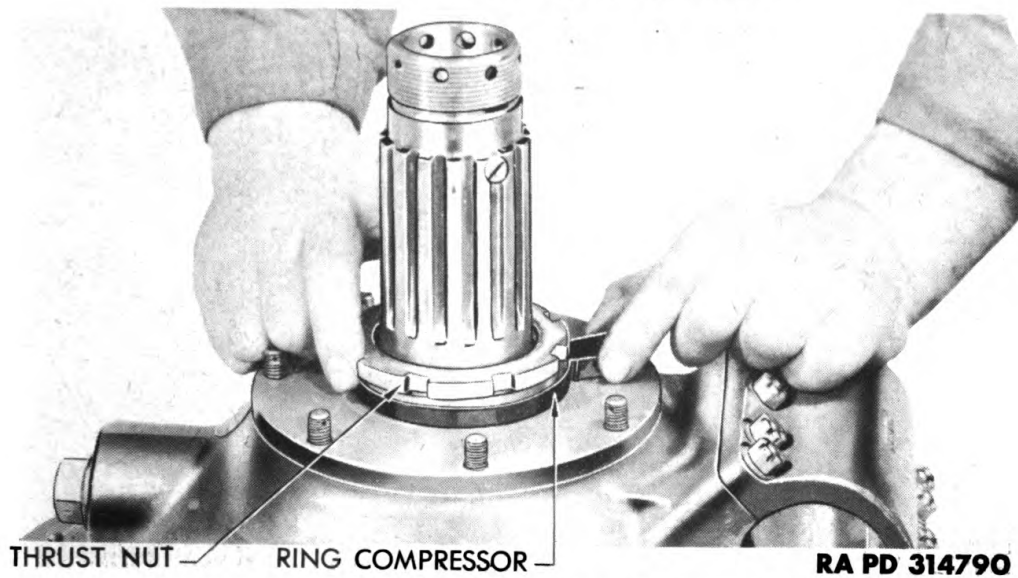

Figure 230 – Compressing Front Thrust Nut Rings

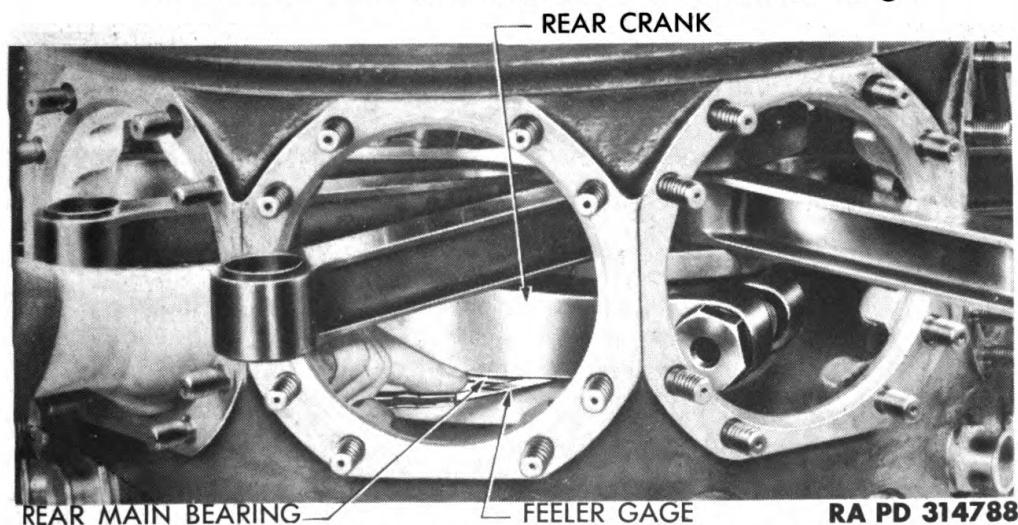

Figure 231 – Checking Clearance Between Crankshaft and Rear Main Bearing Using Gage 41-G-400

(fig. 233). Secure nuts in pairs with lock wire at this time. It is much easier to secure nuts as each cylinder is installed than after all cylinders are installed. Install screened breather plug in front spark plug hole (fig. 234).

d. Install Remaining Pistons and Cylinders. Install each remaining piston and cylinder following procedures explained in subparagraphs b and c above. Install pistons and cylinders in numerical order, one, two, three, four, etc. Be sure to remove rubber seal from timing bar, and place over each cylinder barrel against flange before installing cylinder. Before installing each cylinder, turn crankshaft so that articulated rod for the cylinder being installed is at top center.

ORDNANCE MAINTENANCE – ORDNANCE ENGINE
MODEL R975-C4 (CONTINENTAL)

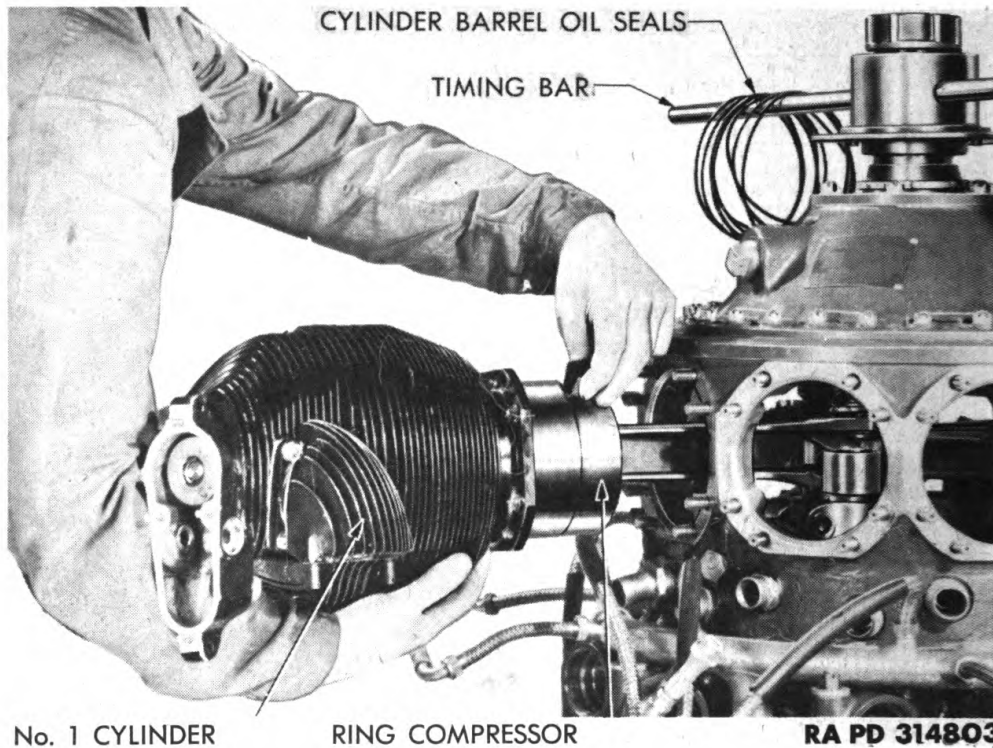
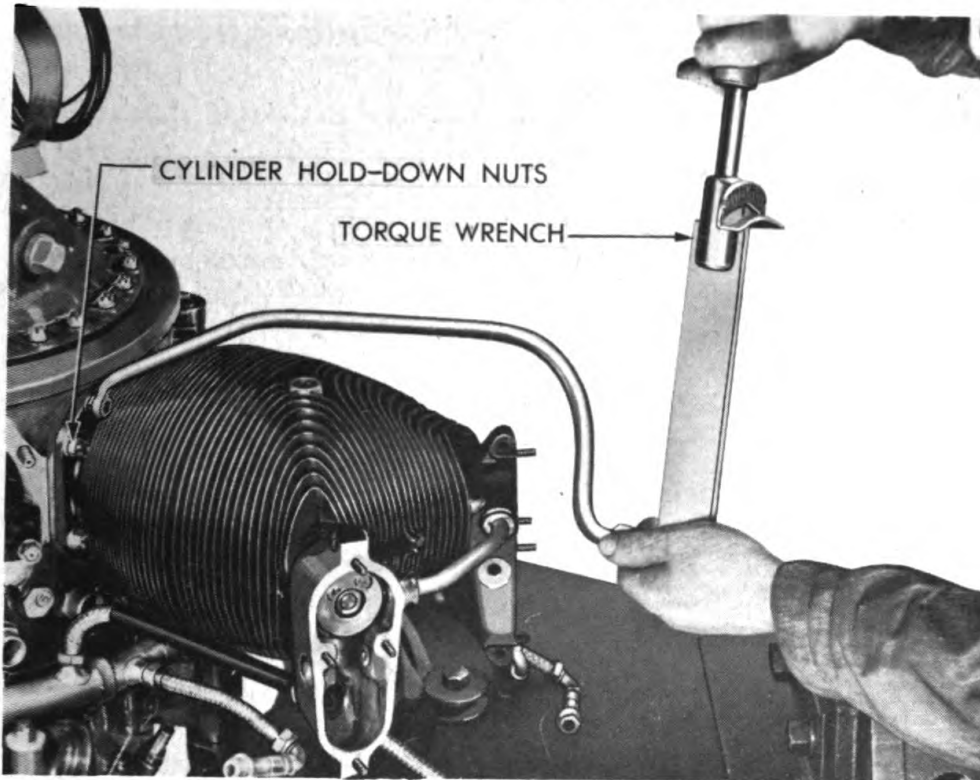

Figure 232 – Installing No. 1 Cylinder Using Fixture 41-F-2997-84 and Compressor 41-C-2550-80

After installing the No. 2 cylinder, loosen and back off spark plug conduit nut from harness end of spark plug conduit wire between the cylinders. Double up conduit wire, and push wire up between base of the cylinders. Tighten conduit nut. After each cylinder is installed, repeat the procedure of pushing spark plug conduit wire between cylinders. Check all cylinders after they are installed to see that no rubber seals remain hanging on timing bar as proof that seal has been installed on each cylinder.

e. Install Intercylinder Air Deflectors. Position engine for easy accessibility. Select the proper intercylinder air deflector, and insert it through rear of engine, between proper pair of cylinders, and over cylinder exhaust elbows. Thread hooked end of deflector attaching spring through to front of cylinders as deflector is installed. Air deflectors installed between the Nos. 6 and 7, and Nos. 4 and 5 cylinders, have openings for two spark plug conduits. The air deflector installed between the Nos. 5 and 6 cylinders has a large opening for the sump front drain tube. The air deflector installed between the Nos. 7 and 8 cylinders has no opening. Air deflectors installed between the Nos. 3 and 4, 2 and 3, 1 and 2, 9 and 1, and 8 and 9 cylinders, have an opening for a single spark plug conduit. Make sure

ASSEMBLY OF SUBASSEMBLIES



RA PD 314794

Figure 233 – Tightening Cylinder Hold-down Nuts with Torque Wrench 41-W-3630

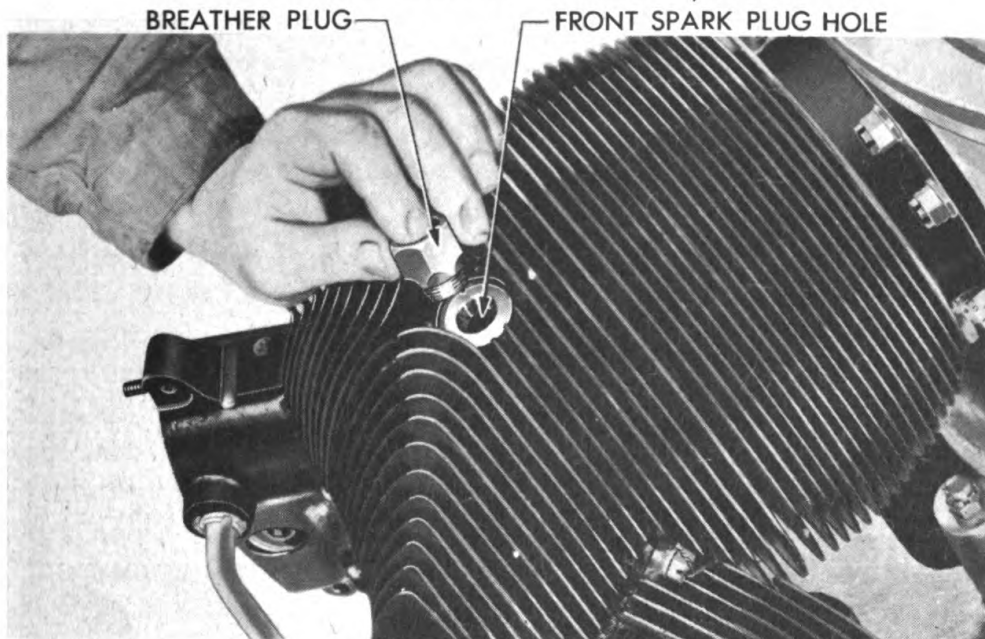

RA PD 314795

Figure 234 – Installing Breather Plug

ORDNANCE MAINTENANCE – ORDNANCE ENGINE
MODEL R975-C4 (CONTINENTAL)

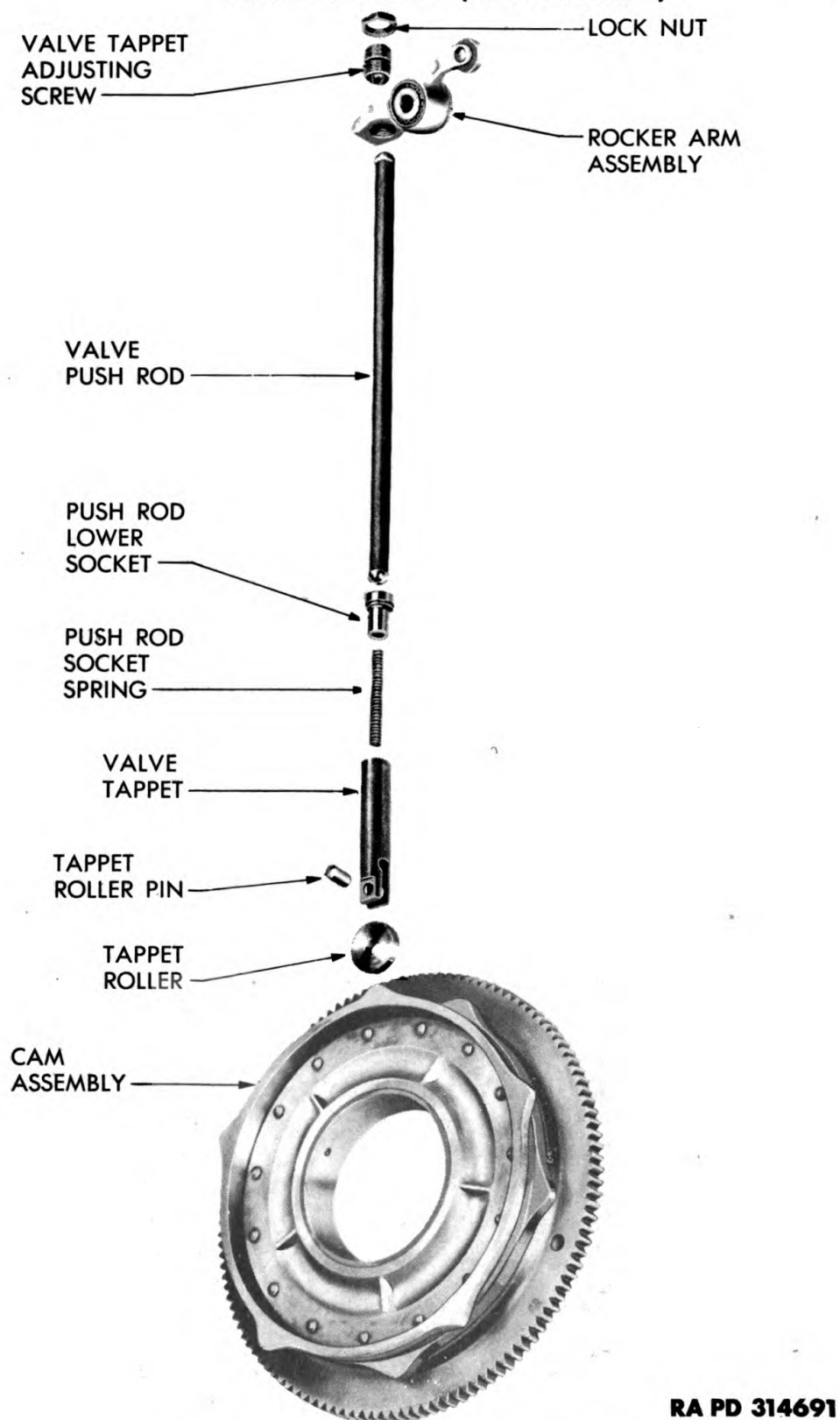

Figure 235 – Valve Operating Mechanism
222

ASSEMBLY OF SUBASSEMBLIES

that spark plug conduits are in opening provided in intercylinder air deflectors.

f. Install and Connect Spark Plugs. Make sure there is a solid copper gasket on each spark plug. Do not use a gasket less than 0.068 inch thick. A thinner gasket allows plug to be screwed in too far exposing threads to gases in combustion chamber and causing preignition. Install plugs, and tighten them with torque wrench connected to 1-inch socket wrench. Tighten each spark plug from 450 to 480 inch-pounds of torque. Remove protectors from spark plug cigarette connectors. Insert cigarette connector into spark plug. Tighten conduit lock nuts at both ends of each elbow connector. Install and connect remaining rear plug.

g. Install Fuel Induction Tubes. Check tubes to make sure that gland nut and new rubber seal are positioned properly on one end of each induction tube. Insert nut, and seal end of tube in recess in rear crankcase section (fig. 6). Push seal and nut into recess, and start nut on recess threads. Tighten nut finger-tight. Install new gasket between cylinder head and induction tube flange.

h. Install Cylinder Head Air Deflectors. Install cylinder head air deflector on cylinder head. Air deflectors are interchangeable with the exception of the one with the long Dzus fasteners (marked 200 on head). This deflector is installed on the No. 7 cylinder head. The long fastener is used to fasten air deflector to cowling. Install flat washers and lock washers on each of three attaching cap screws. Install three cap screws in holes in induction tube flange. Upper cap screw also attaches air deflector to cylinder head. Tighten cap screws to secure tube to cylinder head. Using special wrench (41-W-1537), tighten induction tube gland nut in rear crankcase section recess. Install remaining induction tubes and cylinder head air deflectors in same way.

i. Install Push Rod Housings. Lubricate push rod springs and sockets. Install a spring and socket in valve tappet guide by placing them through opening in push rod housing adapters in each cylinder. Install push rod housing connecting hose. Position one housing, with its connecting hose and clamps, between the push rod housing adapter on the main crankcase section, and the push rod housing on the cylinder rocker box. Place the end with the hose with the single small clamp, nearest the rocker box push rod housing adapter. Slide hose at other end of housing over main crankcase housing adapter, and tighten hose clamps with wrench (41-W-1986). Place push rod housing up against rocker box push rod housing adapter, and slide hose over end of adapter. Tighten two hose clamps. Install remaining housings in same way.

**ORDNANCE MAINTENANCE – ORDNANCE ENGINE
MODEL R975-C4 (CONTINENTAL)**

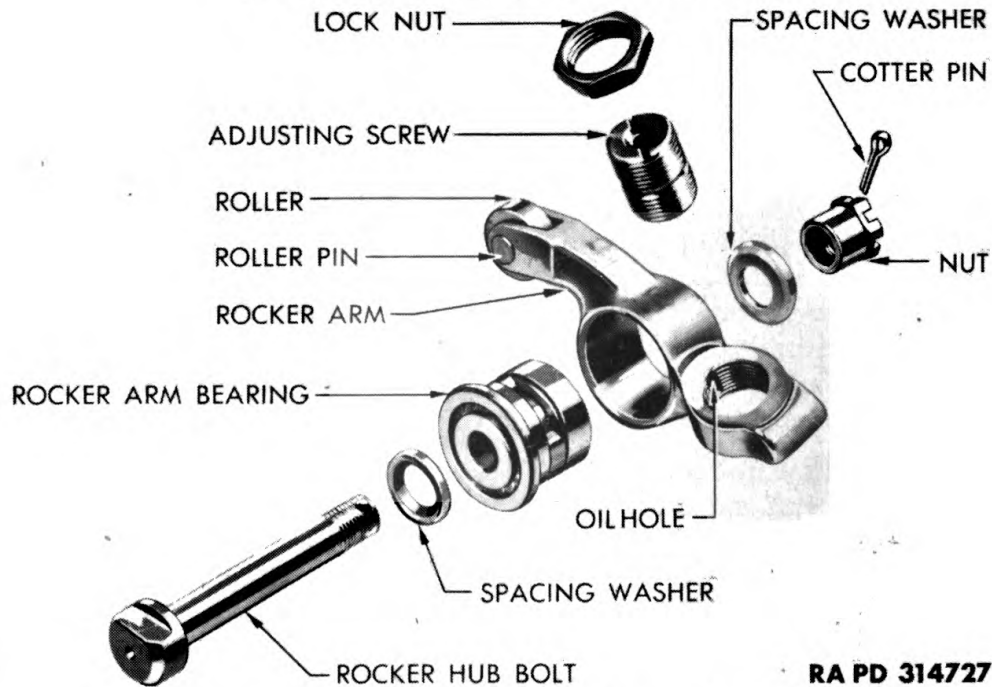

RA PD 314727

Figure 236 – Rocker Arm Assembly – Disassembled

j. Install Push Rods. Lubricate each push rod (fig. 235) and install them, one at a time, through rocker box and into push rod housing (fig. 47). Push each rod against push rod spring and socket (fig. 235) to test the spring action, to make sure the push rod end is properly seated in the socket, and that the socket is in position in valve tappet guide. Install each push rod in same way.

k. Install Rocker Arms. Check to see that the No. 1 cylinder valves are closed. If they are not, turn timing bar and close them. Back off rocker arm tappet adjusting screws in all rocker arms, and lubricate bearings in the intake rocker arm (fig. 236). Position intake rocker arm between bosses in intake rocker box. Place rocker arm hub bolt washer on bolt. Install bolt through rocker box and rocker arm. Place rocker arm hub bolt nut washer over end of bolt, with washer recess facing outward so that rocker arm hub bolt nut fits into washer recess. Install and tighten nut to from 250 to 325 inch-pounds of torque (fig. 46). Safety nut with cotter pin. Install exhaust rocker arm, and install rocker arms for remaining cylinders in same way. *Be sure that cylinder valves are closed at all times.* After all rocker arms have been installed, give the clearance between rocker arm rollers and valve stems an approximate setting by turning adjusting screw on each rocker arm. This is to assist in holding the cam ring in position for valve timing later in the assembly. Install intercylinder air deflector brackets between the eleventh and twelfth fin of each

ASSEMBLY OF SUBASSEMBLIES

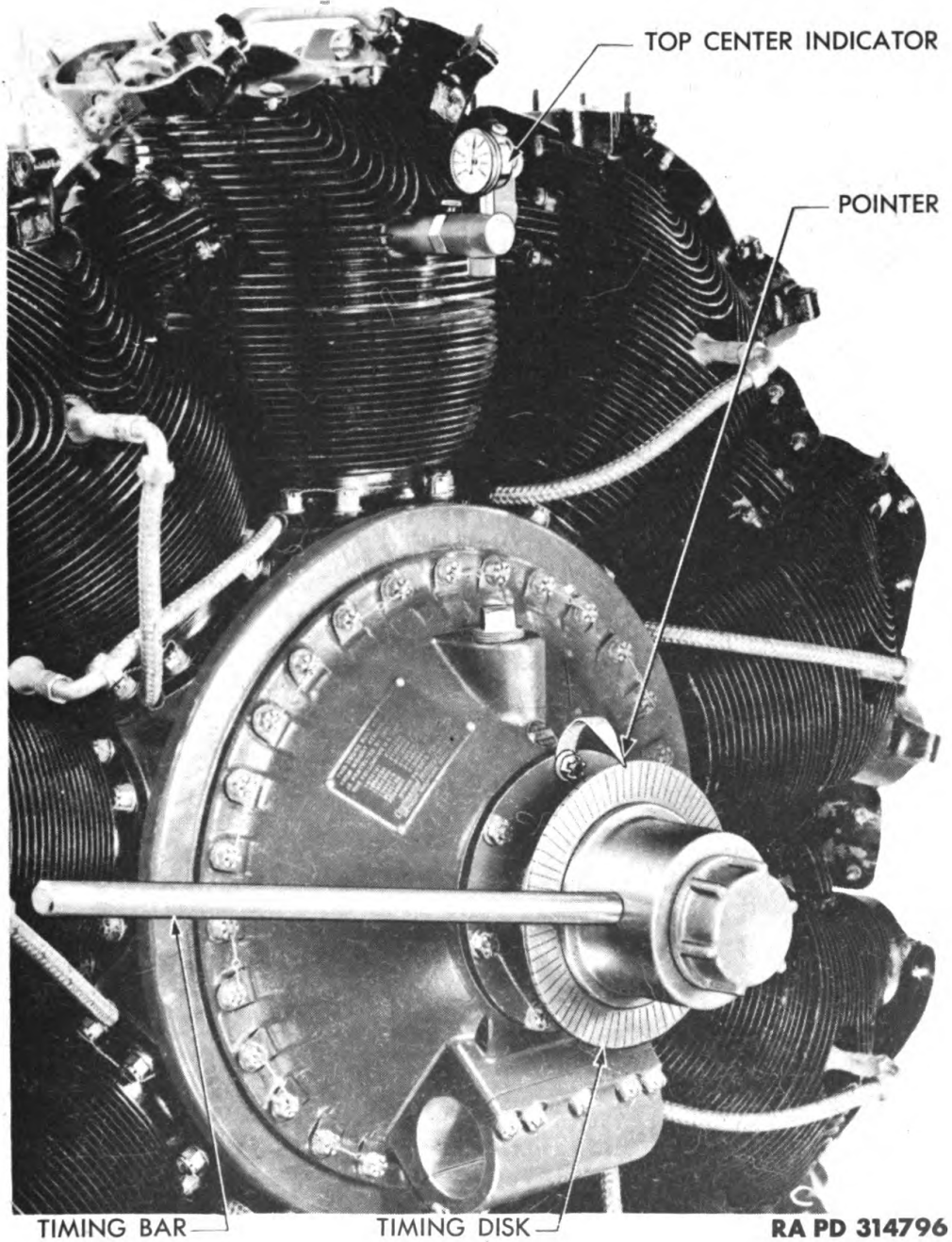

**Figure 237 – Timing Engine Using Indicator 41-I-73-100 and
Fixture 41-F-2997-84**

**ORDNANCE MAINTENANCE – ORDNANCE ENGINE
MODEL R975-C4 (CONTINENTAL)**

ROCKER ARM FOR
No. 1 EXHAUST VALVE

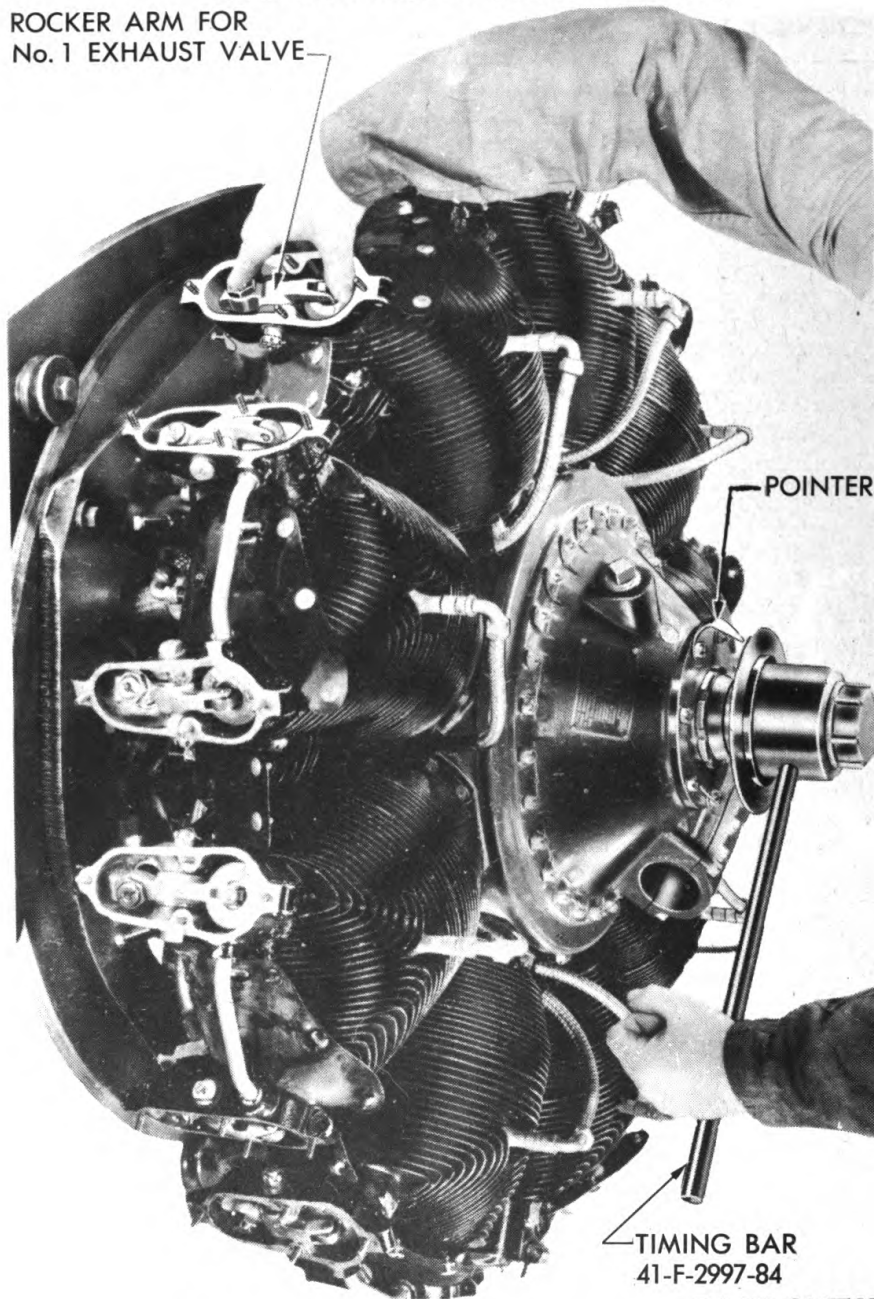

Figure 238 – Checking Valve Action

cylinder, counting up from the base of the cylinder (fig. 42). Attach intercylinder air deflector springs to air deflector brackets (fig. 41).

I. Set Timing Disk Pointer. If timing bar, or disk, is not installed, install it at this time on front end of crankshaft. Install timing disk pointer on front cover top hold-down stud. Install top dead center indicator (41-I-73-110) in No. 1 cylinder spark plug hole (fig. 237). Set pointer so that it points as closely as possible to

ASSEMBLY OF SUBASSEMBLIES

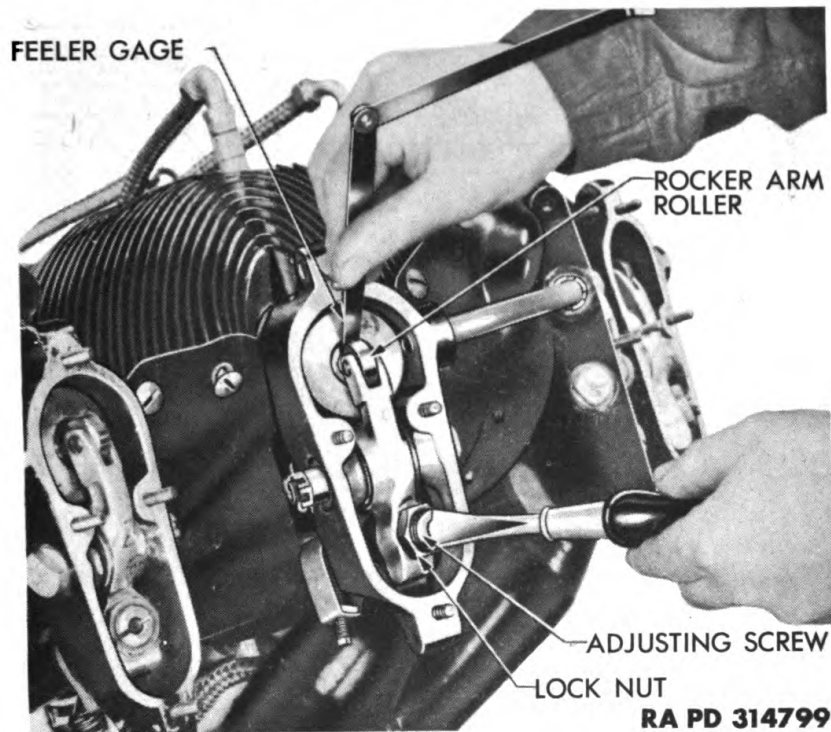

Figure 239 – Adjusting Valve Clearance Using Gage 41-G-412-75

center of No. 1 cylinder. Turn crankshaft in counterclockwise direction (as viewed from front) until, on upstroke of piston, top dead center (TDC) indicator reads zero. Note the reading on the timing disk as indicated by the pointer. Continue to turn crankshaft in same counterclockwise direction until the pointer on the top dead center indicator has gone past and returned to zero. Again note the reading on the timing disk. Turn the crankshaft backwards (clockwise) about one-quarter of a revolution then turn it forward (counterclockwise) until the timing disk pointer indicates a point on the timing disk exactly midway between the two readings previously obtained. Then adjust the pointer to indicate exactly zero degree on the timing disk. Leave the pointer in this position. Remove top dead center indicator.

m. Time Valves.

(1) **ADJUST NO. 1 CYLINDER VALVE CLEARANCE.** Turn crankshaft in a counterclockwise direction until the No. 9 intake valve just begins to open (fig. 238). Tap push rod ends of both No. 1 cylinder rocker arms with fiber mallet. Adjust valve tappet clearance between the rocker arm roller and valve stem for the No. 1 cylinder intake and exhaust valves by turning rocker arm adjusting screw in or out until a clearance of 0.070 inch is obtained. Measure clearance with feeler gage (fig. 239). Wash grease from hands, and from rocker arm rollers with dry-cleaning solvent. Press rocker arm adjusting

ORDNANCE MAINTENANCE – ORDNANCE ENGINE
MODEL R975-C4 (CONTINENTAL)

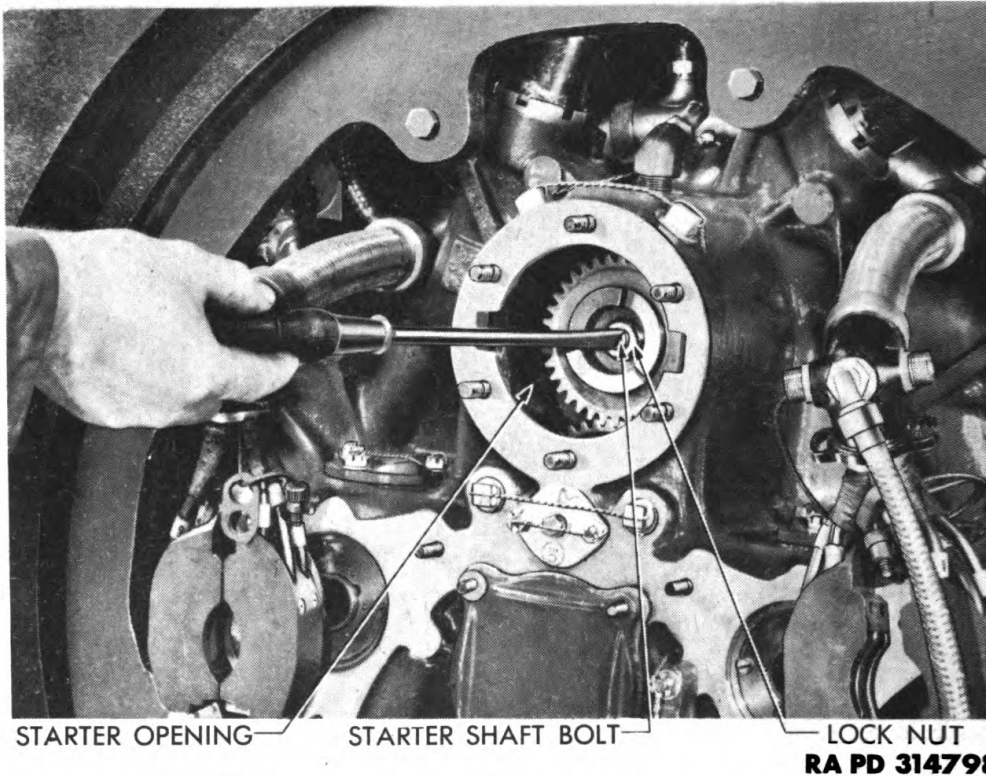

Figure 240 – Disengaging Timing Serrations

screw for the No. 1 cylinder intake valve down, with the fingers of your right hand, and turn rocker arm roller with thumb. At the same time, turn crankshaft in counterclockwise direction until roller begins to bind (fig. 238). Loosen lock nut at rear end of starter shaft bolt. Insert screwdriver in bolt slot to keep bolt from turning. Push bolt forward to disengage timing serrations at front end of bolt from serrations in starter gear (fig. 240). While holding bolt in this forward position, turn crankshaft until timing disk pointer registers eight degrees before top dead center on timing disk. Permit bolt to slip back and reengage timing serrations with serrations on starter gear. Tighten bolt lock nut securely; then back off nut $\frac{1}{2}$ turn. With screwdriver in bolt slot, attempt to rotate starter shaft bolt to make sure bolt serrations are meshed with starter gear serrations. Retighten lock nut.

(2) **ADJUST CLEARANCES FOR OTHER VALVES.** Adjust clearance between rocker arm rollers and valve stems on all other cylinders in same way, but to only 0.006 inch. Set the valve tappet clearances first on the odd numbered cylinder assemblies, in order, beginning with No. 3; then on the even numbered assemblies beginning with No. 2. When adjusting valve tappet clearance for each valve assembly, be sure to turn crankshaft so top dead center marking on timing

ASSEMBLY OF SUBASSEMBLIES

bar points towards the center of the cylinder on which clearance is being adjusted. After adjusting clearance for each valve, tighten adjusting screw lock nut. After valve tappet clearances have been adjusted, check valve timing again.

(3) **RECHECK VALVE TIMING.** Turn crankshaft until the No. 1 cylinder intake valve begins to open. The valve should start to open at 8 degrees plus or minus 4 degrees, before top dead center, as indicated on the timing disk by the timing disk pointer. Turn crankshaft until No. 1 cylinder exhaust valve starts to close. Exhaust valve should start to close at 19 degrees plus or minus 4 degrees as indicated on the timing disk by the timing disk pointer. Turn crankshaft until the No. 1 cylinder is at top dead center on the compression stroke. Adjust No. 1 cylinder valve clearance to 0.006 inch by procedure explained above. Leave timing disk pointer in position for magneto timing.

n. Install Rocker Box Covers. Install new gaskets on all rocker box mounting flanges. Place rocker box covers over rocker box studs. Place flat washers, lock washers, and nuts over studs. Tighten nuts securely. Rocker box covers for the Nos. 3 and 4, 4 and 5, 6 and 7, and 7 and 8 cylinders (cylinders on the lower side of the engine) are connected in pairs by drain tubes. Install the joined box covers together.

78. ACCESSORIES AND MISCELLANEOUS SUBASSEMBLIES, INSTALLATION.

a. Install Generator. Remove two nuts which secure cover over opening in generator support in rear crankcase section, and remove cover. Place new gasket over generator support pad studs. With data plate facing up, position generator over support pad studs with generator splined drive fitting into splined opening in support pad. Place flat washers over studs, and install castellated nuts on studs. Using special wrench (41-W-636-550), tighten nuts securely (fig. 32). Secure nuts in pairs with lock wire.

b. Install and Time Magnetos.

(1) **INSTALL AND TIME RIGHT MAGNETO.** Turn crankshaft in counterclockwise direction until timing pointer and disk indicate 29 degrees before top dead center on the compression stroke of the No. 1 cylinder. Do not turn the crankshaft beyond the 29-degree indication and then turn it back. If this is done, the backlash of the gears will throw the magneto out of timing. Check the matching surfaces of the right magneto mounting flange and mounting pad to make sure they are clean. Apply rust preventive to magneto drive gear splines. Position magneto in front of magneto mounting pad. Turn magneto splined drive until two marks engraved on large distributor gear line up with corresponding marks on front end cover plate. Install magneto over mounting pad studs with magneto splined drive entering magneto coupling on right accessory drive shaft. Move magneto on

**ORDNANCE MAINTENANCE — ORDNANCE ENGINE
MODEL R975-C4 (CONTINENTAL)**

studs by means of elongated slots on magneto mounting flange, until the large distributor gear marks are exactly opposite front end cover plate marks. Use a straightedge to obtain an accurate alinement of the marks. When the marks line up, the mounting pad studs should be in the approximate center of the elongated slots. If they are not, remove magneto from mounting studs. Turn large distributor gear one complete revolution until marks on gear and cover plate again line up. This operation changes the position of the magneto drive splines, and will bring the mounting pad studs in the approximate center of the elongated slots on the magneto mounting flange, when the magneto is reinstalled on the mounting pad. Having the studs in the approximate center of the elongated slots, provides sufficient range for final timing of the magneto during the engine test run. Install washers and nuts on mounting studs, and tighten nuts. Secure nuts with lock wire.

(2) **INSTALL AND TIME LEFT MAGNETO.** Turn crankshaft counterclockwise 3 degrees from the 29-degree point. The pointer will indicate 26 degrees before top dead center on the timing disk. Follow the procedure used in subparagraph b (1) to install and time the left magneto.

(3) **INSTALL MAGNETO DISTRIBUTOR BLOCKS.** Connect one magneto ground wire to right magneto by screwing terminal end into opening provided in top of magneto. Connect other ground wire to left magneto by same method. Connect secondary booster coil wire to right magneto by following the same procedure. Push rubber grommets down on magnetos. Install magneto distributor blocks to each magneto.

(4) **INSTALL DISTRIBUTOR BLOCK COVERS.** Position matching halves of distributor block cover on right magneto (fig. 31). Covers are marked on the inside. Match up covers similarly marked. Secure the bottoms of the covers to the magnetos with clamps. Install safety pin in each clamp. Squeeze covers together at the top. Install bolts through matching holes on either side at top cover halves. Place flat washers, lock washers, and nuts on ends of bolts. Tighten nuts. Place flat washers and lock washer on each of two cap screws which hold shielding elbow to top half of each cover. Install and tighten cap screws. Tighten knurled nut on harness connection to magneto elbow. Install distributor block cover on left magneto in same way, and tighten knurled nut on harness connection to magneto elbow (fig. 27).

c. Install Starter. Remove cover plate from opening on starter mounting pad in rear crankcase section. Place new gasket over mounting pad studs. Position starter over studs with cranking unit at top. Install plain washers and hold-down nuts on six studs. Using

ASSEMBLY OF SUBASSEMBLIES

RA PD 314902

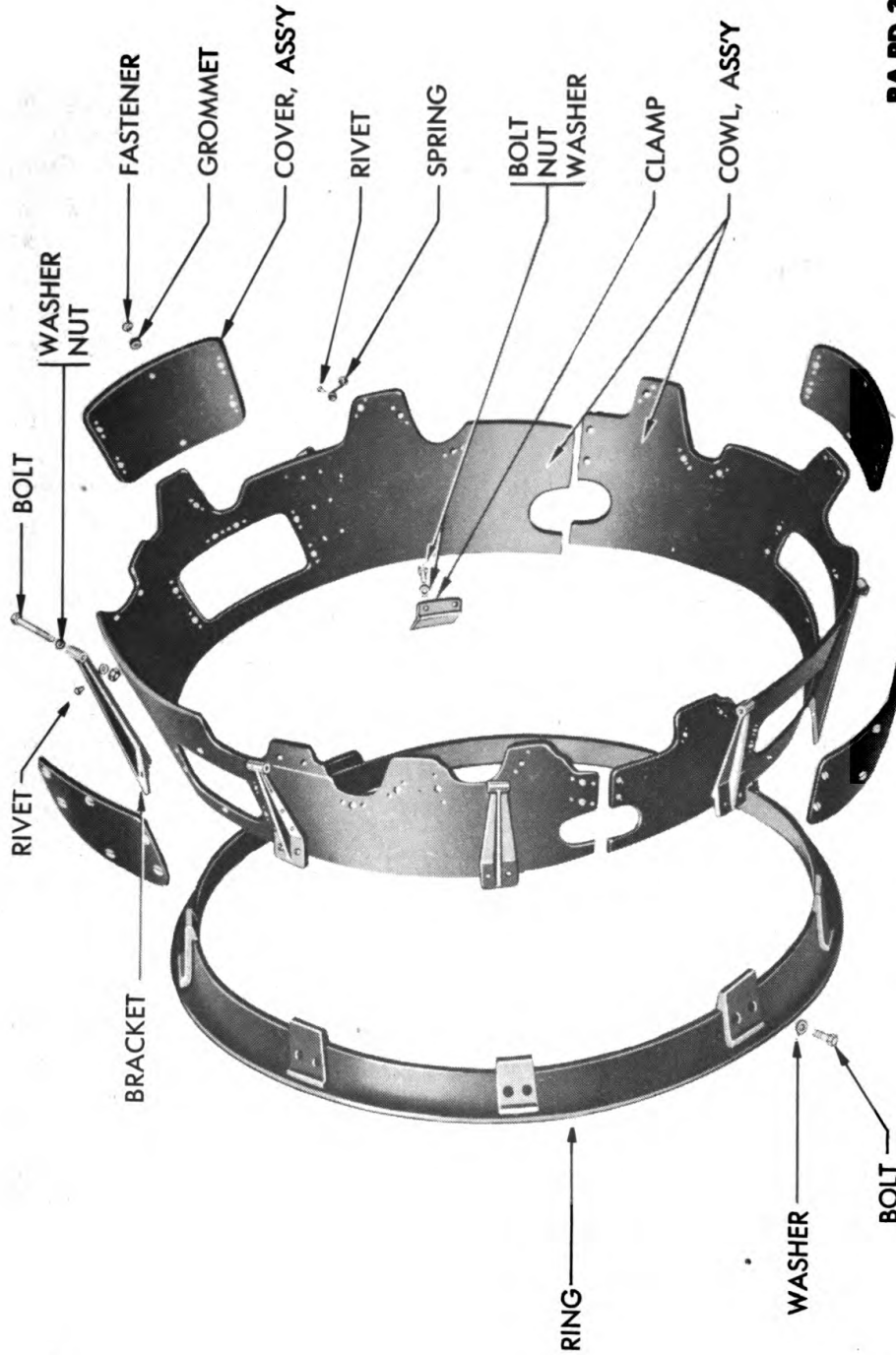
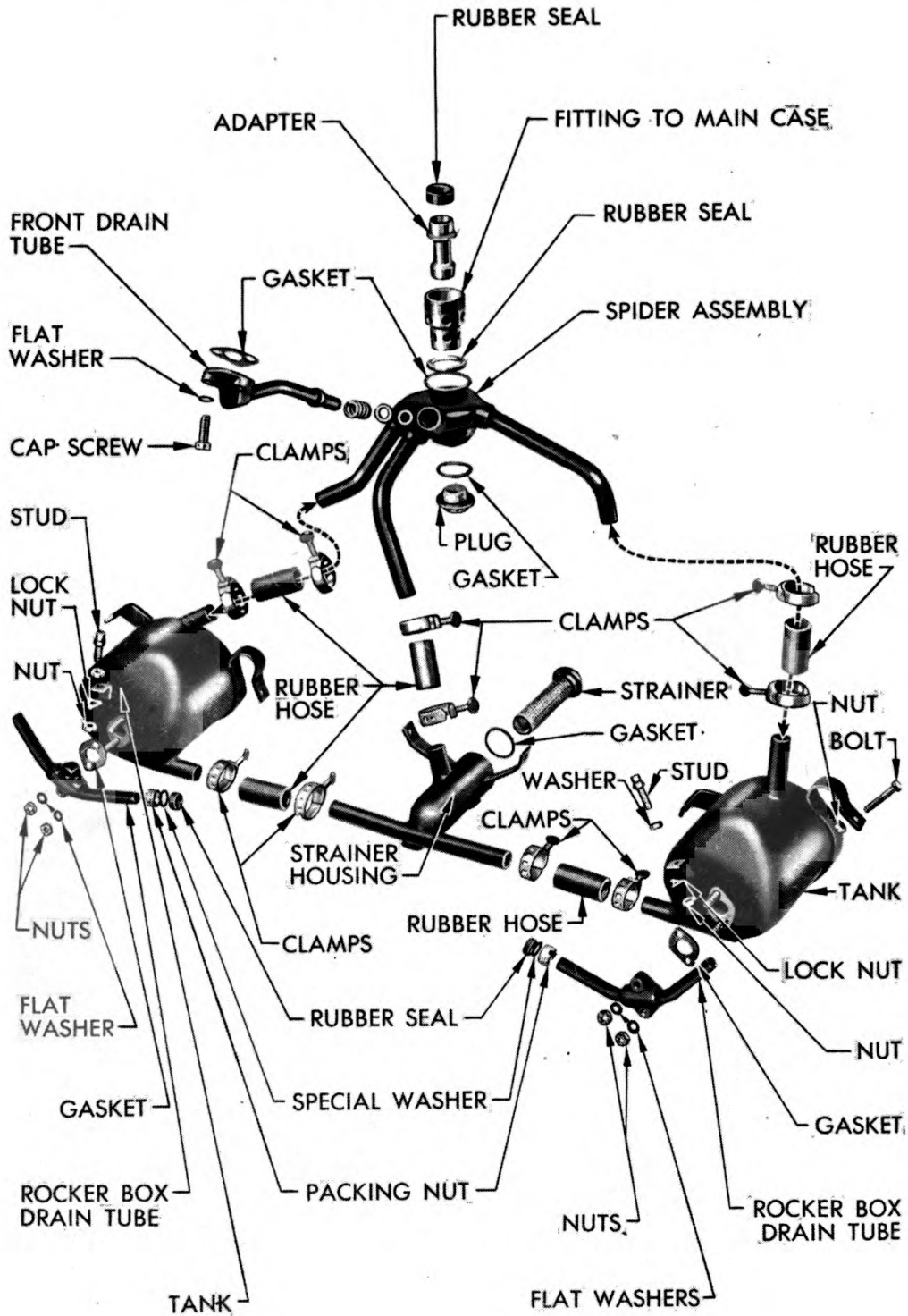

Figure 241 — Engine Cowling — Disassembled

ORDNANCE MAINTENANCE – ORDNANCE ENGINE
MODEL R975-C4 (CONTINENTAL)



RA PD 314842

Figure 242 – Sump – Disassembled
232

ASSEMBLY OF SUBASSEMBLIES

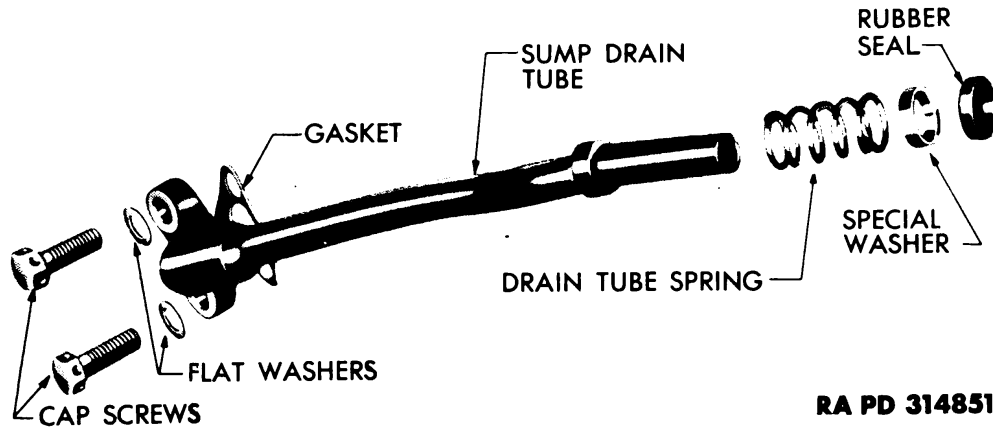

Figure 243 – Sump Drain Tube – Disassembled

special wrench (fig. 30), tighten nuts, and secure them with lock wire in groups of three and three. Place starter-generator support bracket side plates in position between starter and generator. Install flat washers on eight nuts that attach side plates to support bands. Install and tighten nuts. Secure each nut with cotter pin (fig. 29).

d. Install and Connect Front Spark Plugs. Follow procedure for installing and connecting rear spark plugs (par. 77 f).

e. Install Engine Cowling. Position cowling so that the holes in the engine front support bar clamp and cowling, and the holes in cowling bracket line up with bolt holes in cylinder rocker boxes. Bend intercylinder and cylinder head baffles back to make sure they are on outside of cowling. Install bolts through rocker box bolt holes and cowling. Place flat washers and nuts on bolts. Tighten nuts and secure with cotter pin. Secure cowling to intercylinder and cylinder head baffles by tightening Dzus fasteners. There are two Dzus fasteners in each intercylinder baffle, and three in each cylinder head baffle.

f. Install Engine Front Support Bar. Slide bar through hole in either side of cowling, and through support bar center clamp at front of engine (fig. 36). Center the bar so that it extends an equal distance on each side of clamp. Install 10 stud nuts on support bar center clamp, 5 below and 5 above. Tighten nuts, and secure them with lock wire, 5 and 5.

g. Install Sump.

(1) **INSTALL SUMP SPIDER** (fig. 242). Install new rubber gasket over end of sump fitting in bottom of main crankcase section. Install new gasket on machined face in end of spider. Slide end of spider assembly over sump fitting. Place washer in spider plug and screw plug onto bottom of spider assembly fingertight. Position spring, washer, and seal on end of drain tube (fig. 242). Working from front of engine, install drain tube between cylinder baffles and into spider.

**ORDNANCE MAINTENANCE – ORDNANCE ENGINE
MODEL R975-C4 (CONTINENTAL)**

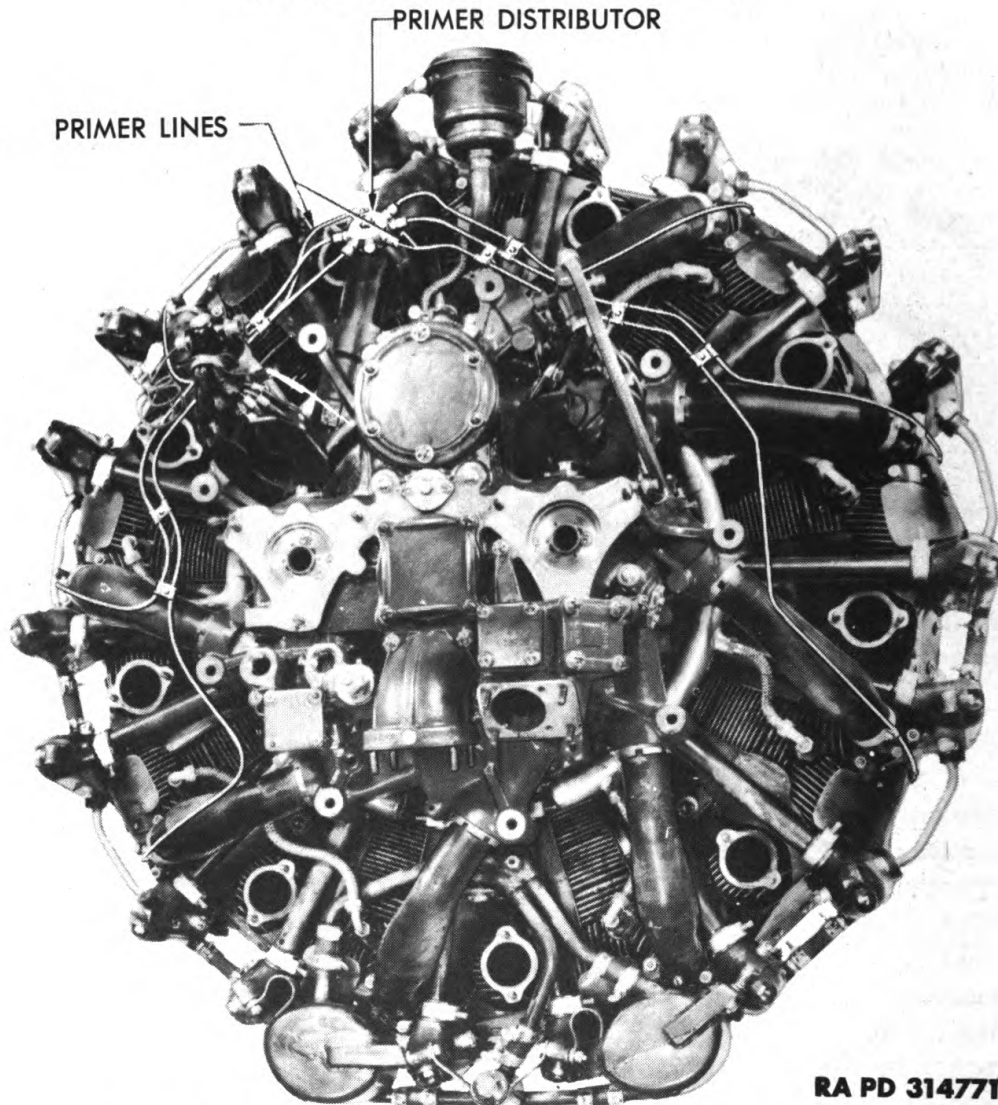

Figure 244 – Primer Distributor and Lines – Installed

Install new gasket between end of drain tube and drain tube opening in main crankcase section. Install flat washers on two cap screws which secure drain tube to main crankcase. Install screws and tighten. Secure screws together with lock wire.

(2) **INSTALL SUMP TANKS** (fig. 243). Place new gaskets for oil tube fittings over studs on each oil sump tank. Position tank assembly so that rocker box drain tube fitting studs on tanks pass through holes in fitting, and the holes in sump tank brackets fit over mounting studs on the Nos. 5 and 6 cylinder heads. Install flat washers and castellated nuts on rocker box drain tube fitting studs. Tighten nuts and secure them in pairs with lock wire. Attach three connecting pipes from sump spider assembly to each sump tank and to strainer

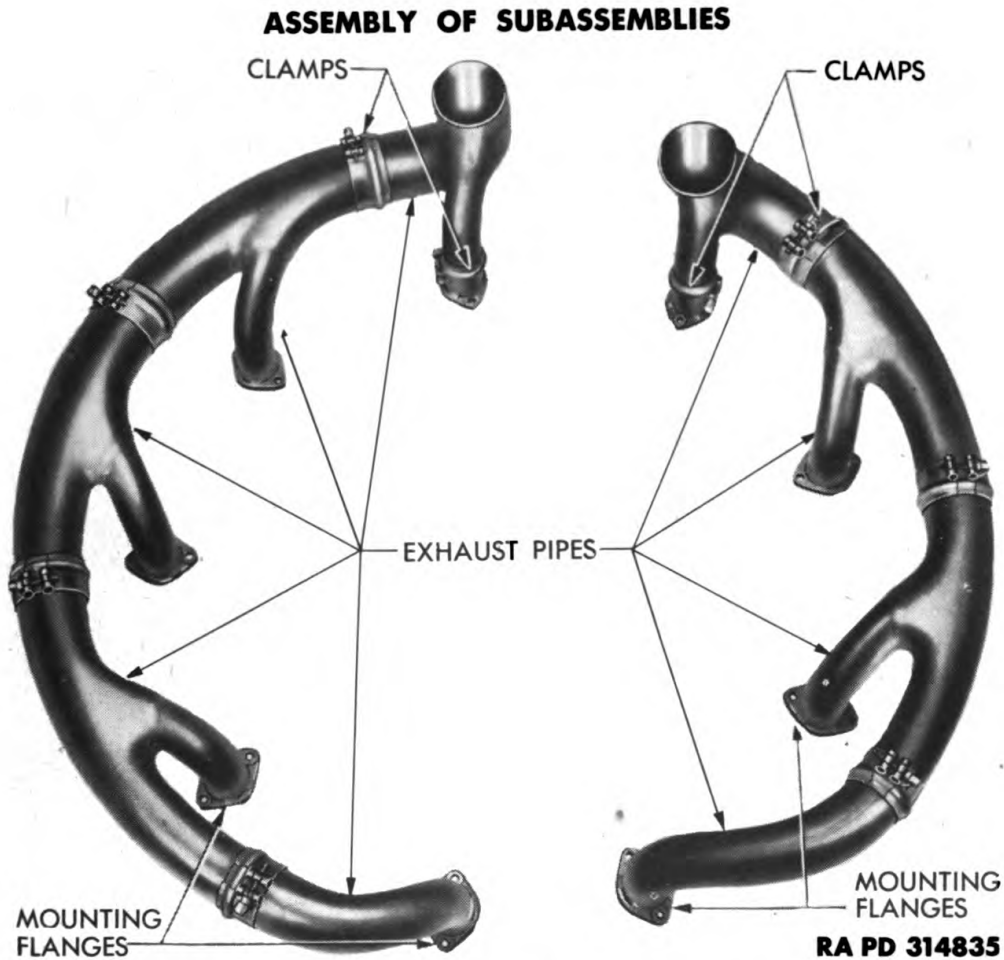

Figure 245 – Exhaust Collector Ring

housing, by means of three attaching hose fitted over the pipes and sump tank and strainer housing connections. Tighten hose with hose clamps at each end of the hose. Install lock washers and nuts on rocker box mounting studs. Tighten nuts, and bend lock washer against flat side of hexagonal nuts. Tighten spider plug securely at this time and safety with lock wire.

h. Install Crankcase Breather. Install hose clamps over both ends of hose connecting crankcase breather to rear and main crankcase sections (fig. 44). Install one end of each hose over hose connections on breather. Install breather on engine with bolt holes in breather bracket lined up with bolt holes in No. 1 cylinder rocker boxes. Install two bolts. Place flat washers, nuts, and palnuts on bolts. Tighten nuts and hose clamps.

i. Install Primer System. Place rear half of primer attaching bracket behind fuel induction tube for the No. 1 cylinder (fig. 43). Position primer distributor assembly over induction tube so that holes in front half of bracket line up with holes in rear half of bracket. Place washers on cap screws, install cap screws in bracket holes, and

**ORDNANCE MAINTENANCE – ORDNANCE ENGINE
MODEL R975-C4 (CONTINENTAL)**

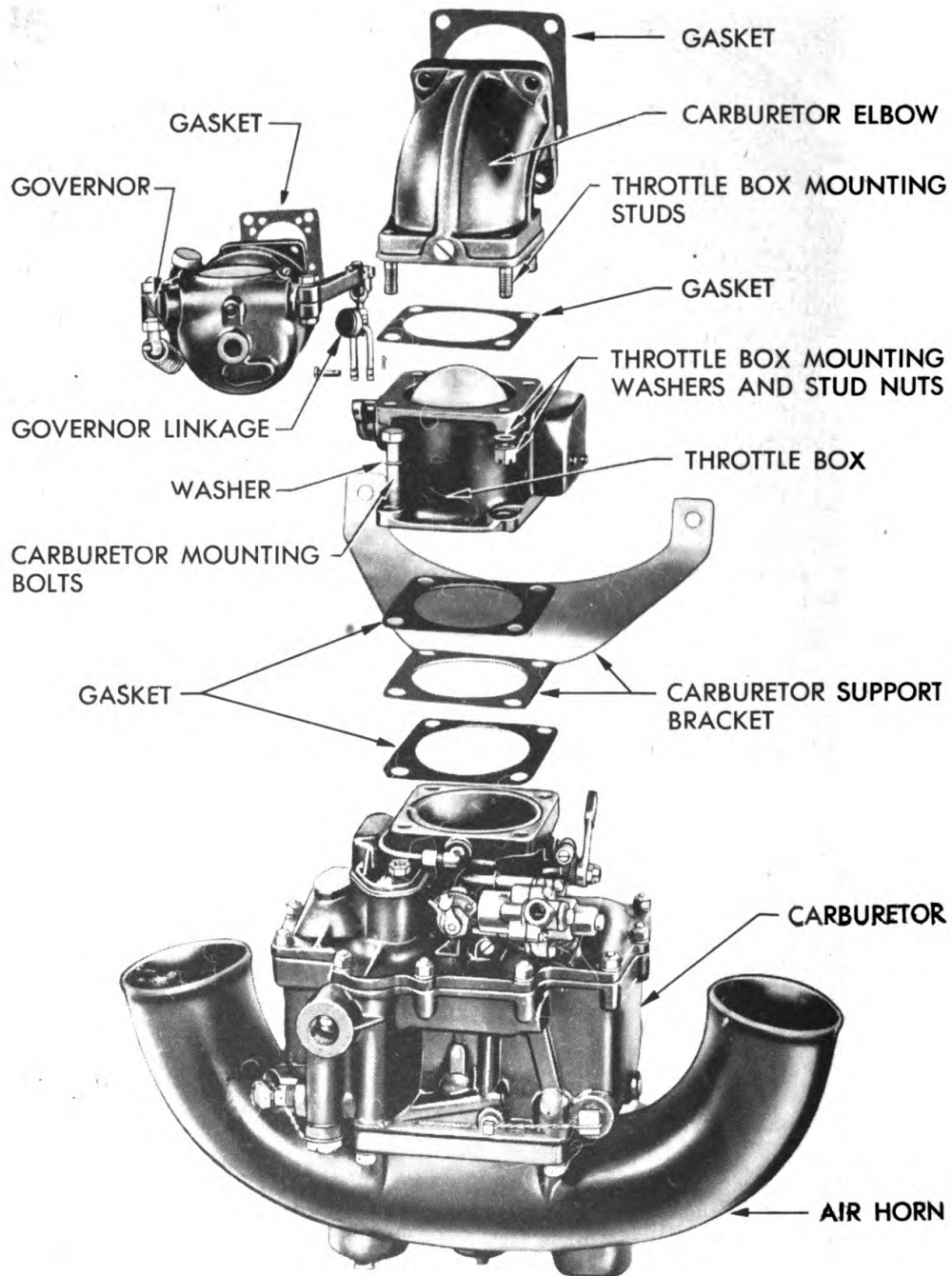

RA PD 314782

**Figure 246 – Carburetor, Governor, and Related Parts
– Disassembled**

ASSEMBLY OF SUBASSEMBLIES



RA PD 314805

Figure 247 – Installing Fuel Pump

tighten. Fasten screws with lock wire. Connect each primer line to cylinder head elbow (fig. 244). Place primer line clamps around each fuel induction tube, and tighten clamps to secure lines to induction tubes. Attach engine sling to rocker box arm hub bolts and remove engine from stand.

j. Install Exhaust Collector Ring (fig. 245). With engine suspended from sling, install new copper gaskets on cylinder exhaust elbows. Position collector ring segments so that ring stud mounting holes fit over two studs in each cylinder exhaust elbow. Install washers and nuts on studs, and tighten nuts securely. Fasten two nuts on each exhaust elbow together with lock wire.

k. Install Engine Rear Support. Position rear engine support ring on rear of engine with flat side towards engine (fig. 3). Line up bolt holes in engine and support ring. Remove bolts, nuts, and washers, from bolt holes in engine mounting stand. Install bolts, and place washers and nuts on bolts. Tighten nuts from 400 to 425 inch-pounds of torque. Secure nuts with cotter pins. Secure support to suitable engine stand. Remove engine sling from rocker arm hub bolts.

l. Install Governor (fig. 246). Remove cover from governor drive flange opening in oil pump. Place new gasket over studs around drive flange opening. Position governor over studs. Install washers, plain nuts, and palnuts on studs. Tighten nuts.

m. Install Carburetor Elbow (fig. 246). Place new gasket over

**ORDNANCE MAINTENANCE – ORDNANCE ENGINE
MODEL R975-C4 (CONTINENTAL)**

carburetor elbow mounting studs in rear crankcase section. Position elbow over studs. Install washers and nuts over studs. Tighten nuts and secure them with lock wire.

n. Install Throttle Box (fig. 246). Place new gasket on top mounting flange of throttle box. Install throttle box over carburetor elbow studs. Place washers and nuts on four studs, and tighten nuts. Fasten nuts in pairs with lock wire. Before installing throttle box linkage to governor, be sure there is tension on the governor spring. Attach link to governor arm. Adjust link so link pin fits freely into throttle box arm. Lengthen link one-half to one turn, and insert clevis pin and cotter pin. Make certain that linkage fits freely and does not have to be bent into alinement with governor and throttle arm.

o. Install Carburetor Support Bracket (fig. 246). Place new gasket between carburetor support bracket and throttle box. Position support bracket so bracket cap screw holes line up with holes in rear crankcase section. Install washers on two cap screws. Install cap screws through bracket holes and rear crankcase section holes. Tighten screws, and fasten them together with lock wire.

p. Install Carburetor (fig. 246). Install four carburetor attaching bolts through holes in throttle box bottom flange and bolt holes in support bracket. Place new gasket on carburetor mounting flange. Install carburetor over attaching bolts. Place flat washers and self-locking nuts on four bolts, and tighten nuts.

q. Connect Conduit to Carburetor (fig. 12). Remove cap from degasser unit. Remove nut, lock washer, and flat washer from terminal post. Remove from bench wire which runs from degasser unit to control on vehicle. This wire has a conduit on it. Slip wire terminal over terminal post. Install washer, plain lock washer, and nut, on terminal post, and tighten nut. Replace and screw upper cap on degasser unit (fig. 12). Slip conduit up on conduit elbow, and tighten elbow nut. Install clip which holds loose end of conduit to rear engine support until ready to install in vehicle.

r. Install Fuel Pump. Install fuel pump drive gear in square adapter on drive gear shaft. Install new gasket over four fuel pump mounting pad studs on three-way-accessory drive housing. Install fuel pump and fuel pump adapter elbow as a unit over studs. Install enough washers on each stud to bring castellated nuts in line with lock wire holes in studs. Install castellated nuts on studs. Tighten nuts, and fasten in pairs with lock wire.

s. Install Fuel and Drain Lines (fig. 11). Install hose and clamps over fittings on fuel pump and carburetor. Tighten clamp at each end of hose. Connect drain line running from governor to

ASSEMBLY OF SUBASSEMBLIES

fuel pump adapter elbow. Connect drain line running from fuel pump adapter elbow to sump.

t. Install Booster Coil (fig. 28).

(1) **INSTALL BOOSTER COIL.** Line up booster coil bracket over holes on right side of rear engine support. Install toothed lock washers on fillister head screws. Install screws in matching holes in booster coil mounting flange and engine support. Tighten screws.

(2) **INSTALL CONNECTIONS.** Uncoil primary booster coil wire attached to booster coil. Slide conduit to booster coil over wire, and secure conduit to booster coil. String wire through right magneto elbow from right to left. Tighten knurled nut attaching conduit to right magneto elbow. Uncoil booster coil secondary wire attached to right magneto elbow. Slide conduit over wire. Attach conduit elbow to right magneto elbow by tightening hexagonal nut. Install cigarette connector on secondary booster coil wire, and bend over ends of wire to secure cigarette connector to wire. Attach cigarette end of secondary booster coil wire to booster coil. Uncoil ground wire to right magneto elbow. Slide intermagneto elbow conduit over primary booster coil wire and right magneto ground wire. Run these two wires through left magneto elbow from right to left. Secure conduit to two magneto elbows by tightening hexagonal nut at each end. Uncoil left magneto ground wire left in coil. Slide the conduit, which runs from left magneto elbow to vehicle, over the three wires. Attach conduit to left magneto elbow by tightening knurled nut. Solder terminals to wire ends.

79. FLYWHEEL, FAN, AND CLUTCH INSTALLATION.

a. Install Rear Cone. Making sure flat surfaces are clean and free from burs, install rear brass cone on engine crankshaft (fig. 248).

b. Install Flywheel and Fan. Wipe inner and outer cones of flywheel clean. Lift assembly, and install over crankshaft. Crankshaft hub and flywheel hub are splined so assembly will go only one way.

c. Install Front Cone and Nut. Place two halves of front cone in position over flange of front cone nut (fig. 249). Hold nut in position in flywheel hub, and screw nut up by hand as far as possible.

d. Tighten Cone Nut. Place a wood block between ventilating opening in flywheel and stand (fig. 249). Insert $\frac{3}{4}$ -inch diameter bar through holes in nut, and tighten nut from 600 to 650 foot-pounds of torque.

e. Lock Nut into Position. Insert retaining pin from inside through opening in crankshaft and in nut. Install flat washer over pin. Install and secure cotter pin (fig. 249).

f. Install Separator Pins. Install driving plate separator pins by inserting small end of pin in holes in flywheel (fig. 250). Press in

**ORDNANCE MAINTENANCE – ORDNANCE ENGINE
MODEL R975-C4 (CONTINENTAL)**

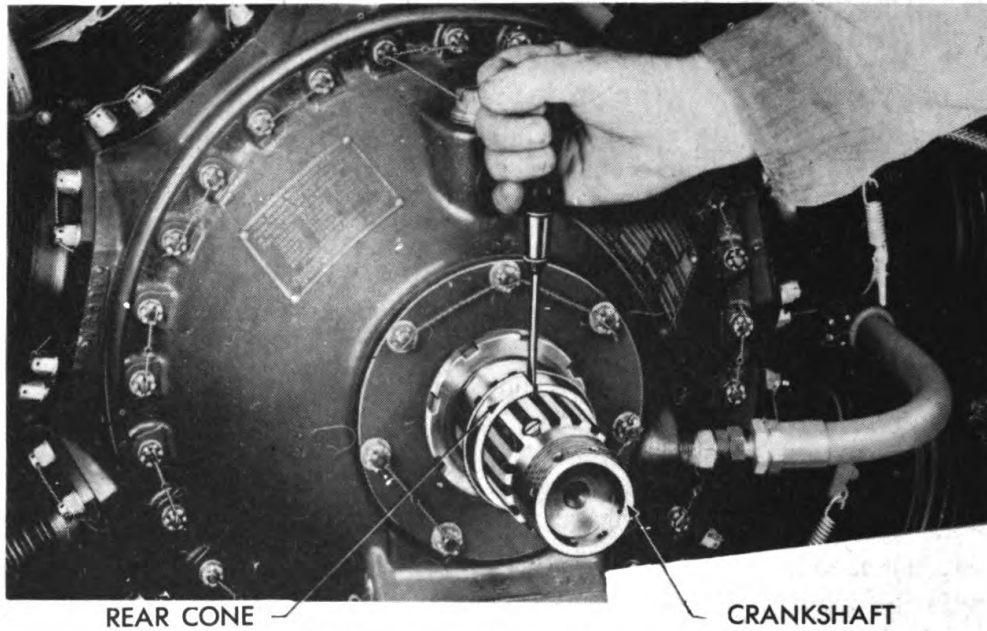

1. INSTALLING REAR CONE

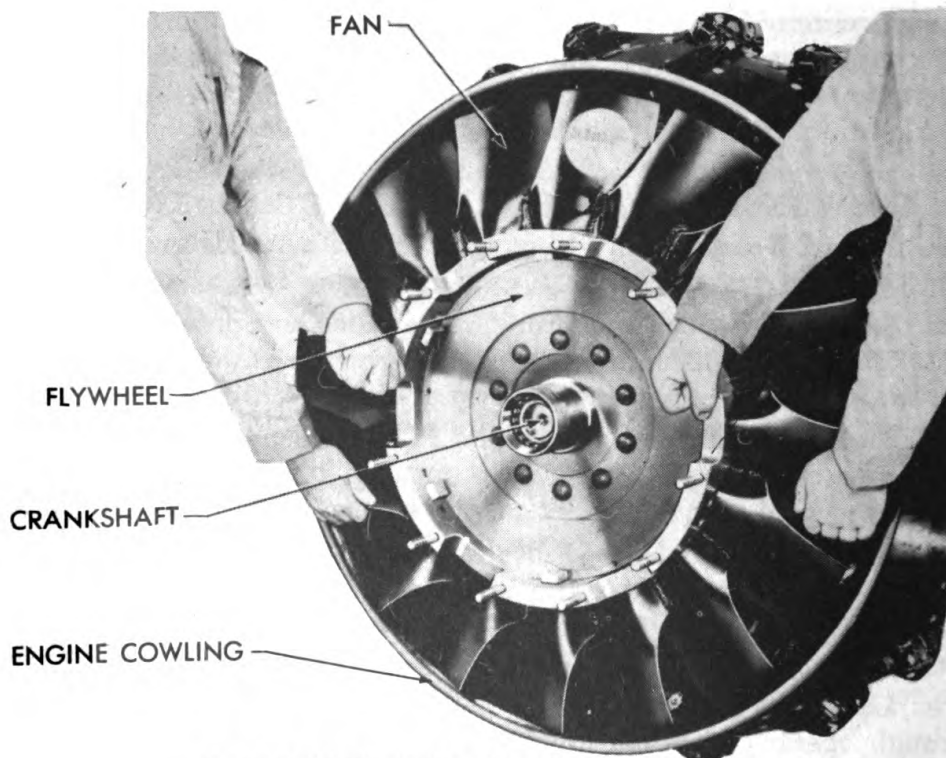

2. INSTALLING FAN AND FLYWHEEL ASSEMBLY

RA PD 53641

Figure 248 – Installing Rear Cone, Fan, and Flywheel Assembly
240

ASSEMBLY OF SUBASSEMBLIES

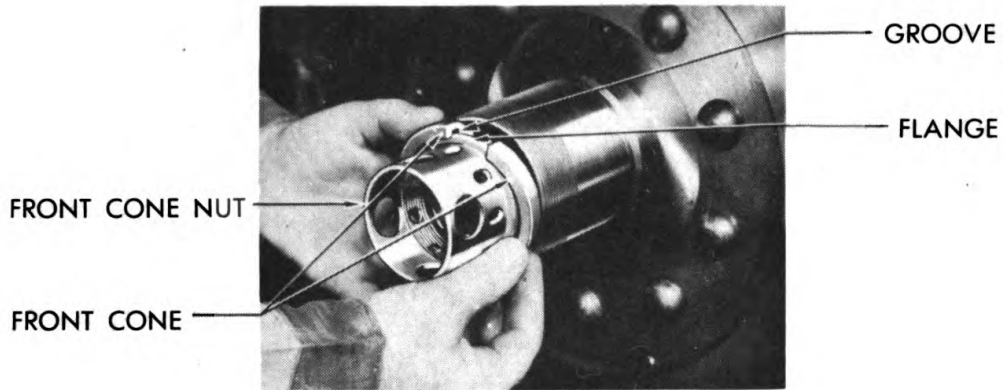

1. INSTALLING FRONT CONE

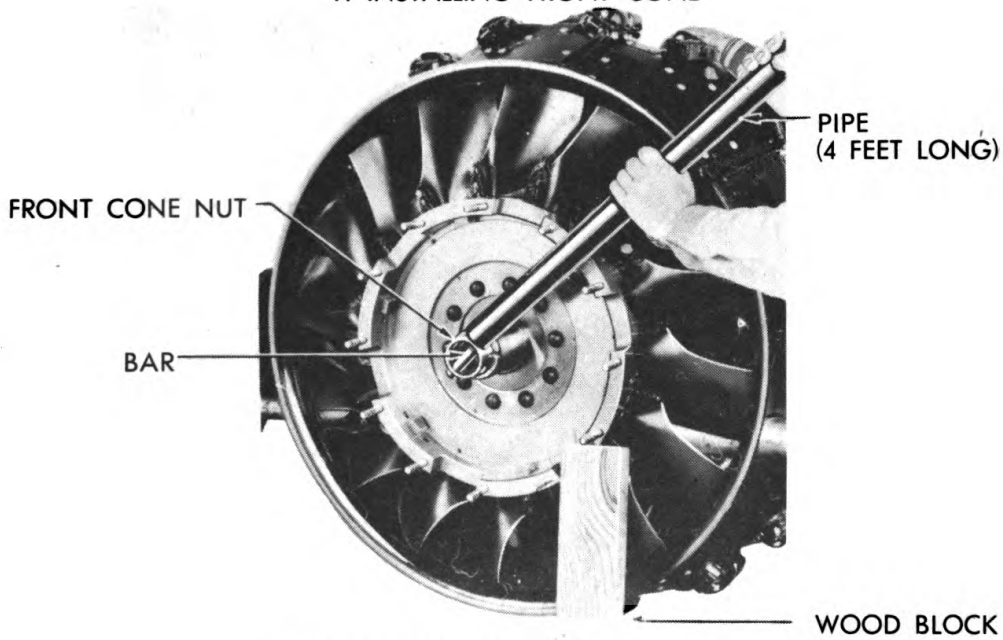

2. TIGHTENING FRONT CONE NUT

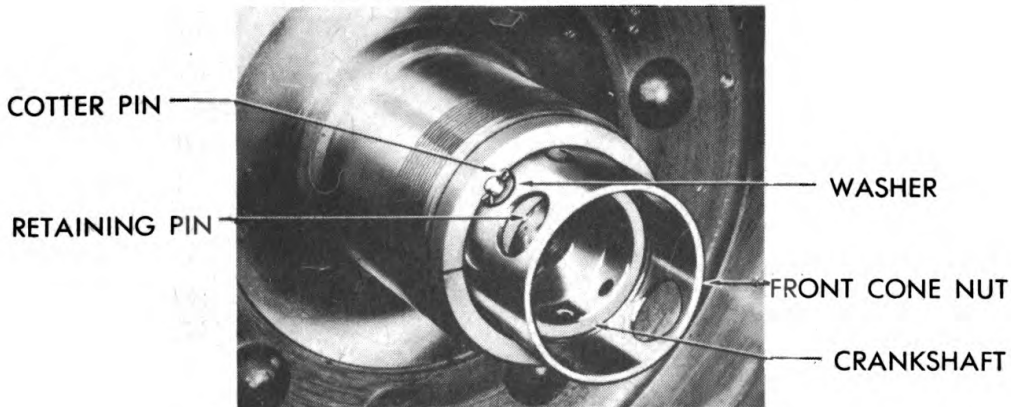

3. FRONT CONE NUT LOCKED IN POSITION

RA PD 53593

Figure 249 – Installing Front Cone and Nut

**ORDNANCE MAINTENANCE – ORDNANCE ENGINE
MODEL R975-C4 (CONTINENTAL)**

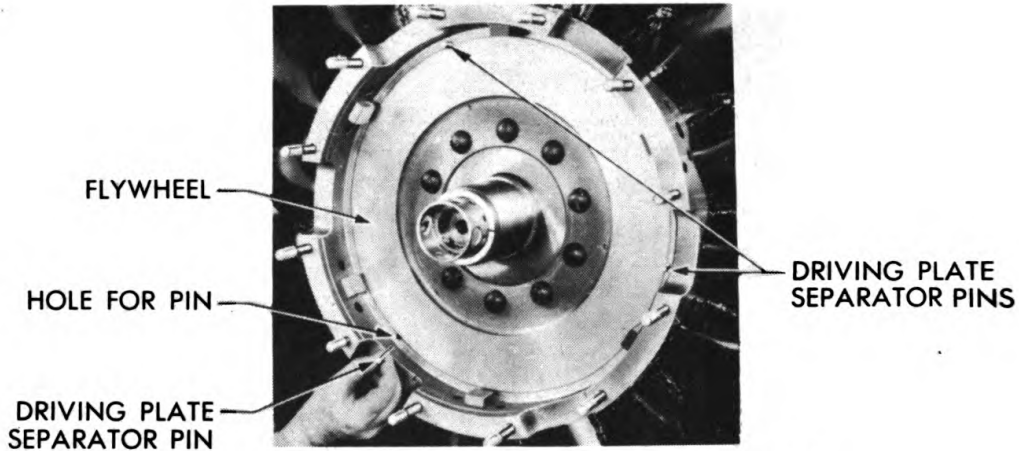

1. INSTALLING DRIVING PLATE SEPARATOR PINS

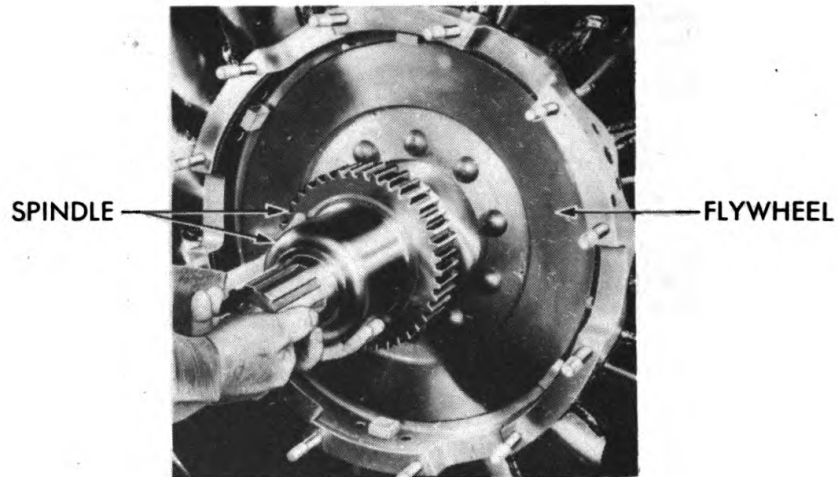

2. INSTALLING SPINDLE

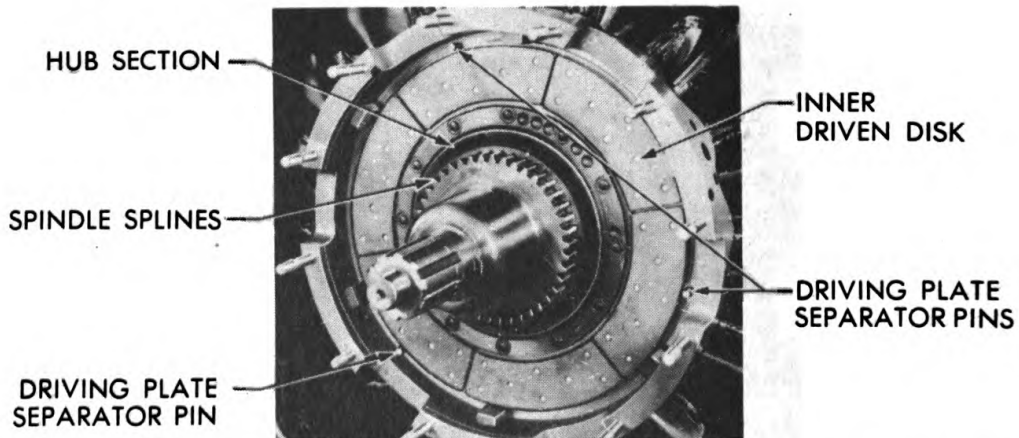

3. INNER DRIVEN DISK IN POSITION

RA PD 53594

**Figure 250 – Installing Inner Driven Disk
242**

ASSEMBLY OF SUBASSEMBLIES

0.015-0.018 IN.
CLEARANCE AT
THIS POINT AT
EACH DRIVING PIN

DRIVING PLATE

FLYWHEEL
DRIVING
PIN

PUNCH MARKS

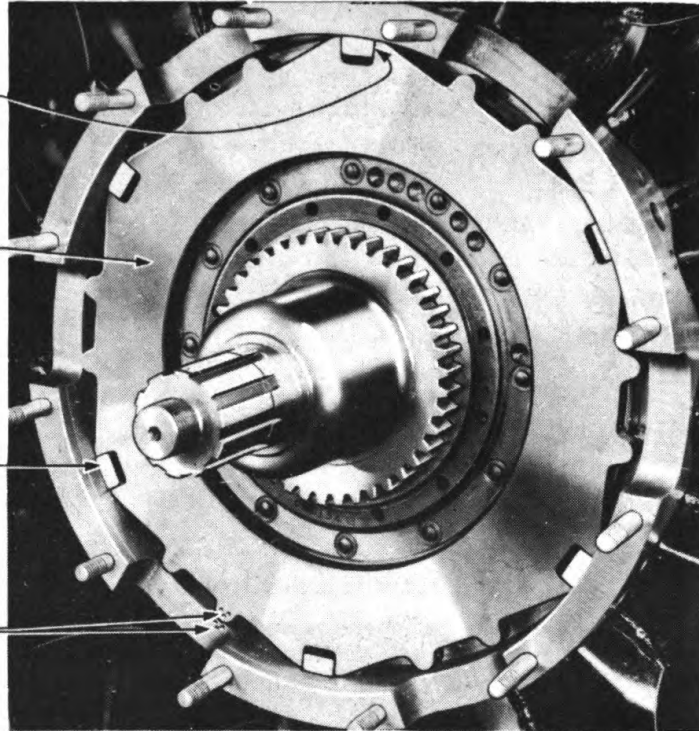

RA PD 314869

Figure 251 – Installing Driving Plate

against each pin as it is installed to test spring tension. Make sure pins each return to normal position when pressure is released.

g. Install Spindle. Place spindle in position on hub of flywheel (fig. 250).

h. Install Inner Driven Disk. With long end of the hub section facing out, or towards operator, install inner driven disk on spindle (fig. 250).

i. Install Driving Plate. Line up prick punch marks on flywheel and driving plate. Install driving plate over spindle, and over the six flywheel driving pins (fig. 251). Check clearance between flywheel driving pins and driving plate. If the clearance is not between 0.015 and 0.018 inch on the drive side of each flywheel driving pin, remove driving plate, and file recesses until proper clearance is obtained (fig. 251).

j. Install Outer Driven Disk. With long end of the hub section facing out, or towards operator, place outer driven disk in position on spindle.

k. Install Flywheel Ring and Pressure Plate. Using a lifting eye, or with the help of another person, install flywheel ring and pressure plate on spindle (fig. 252). Be careful flywheel ring bolts are not pushed back out of position in flywheel when positioning pressure plate assembly. Place nuts on 12 bolts, and tighten uniformly to between 75 and 85 foot-pounds of torque (fig. 252).

**ORDNANCE MAINTENANCE – ORDNANCE ENGINE
MODEL R975-C4 (CONTINENTAL)**

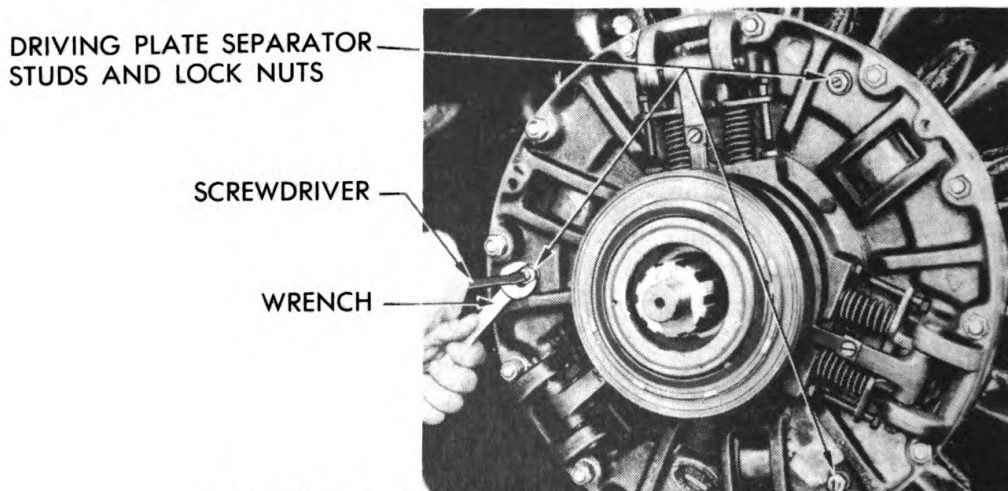
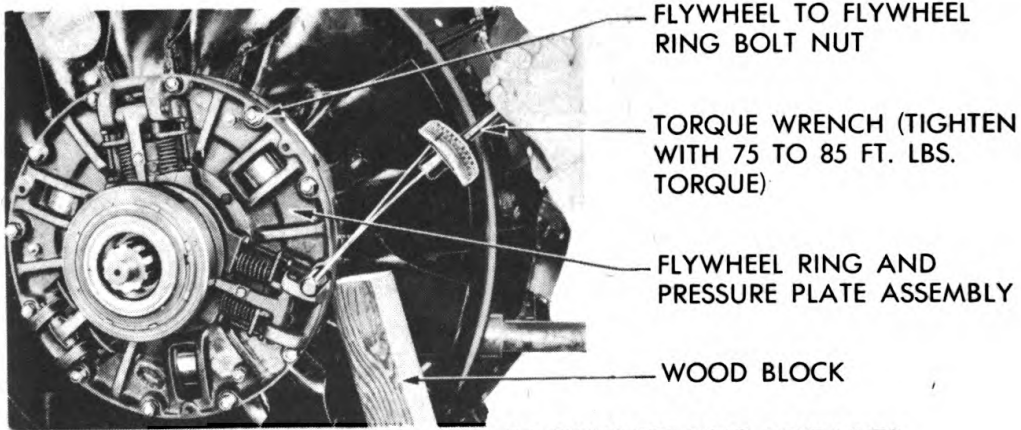
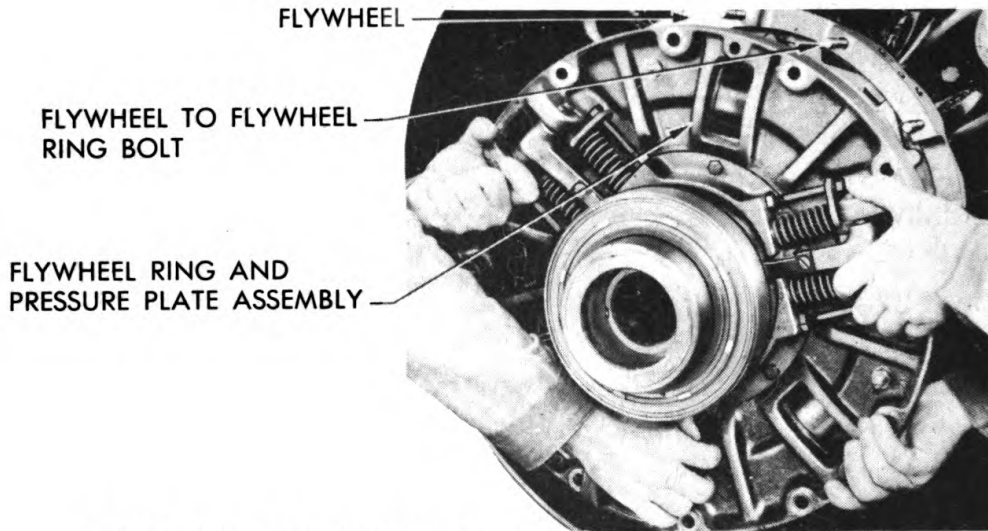

RA PD 320028

Figure 252 – Installing Flywheel Ring and Pressure Plate Assembly

ASSEMBLY OF SUBASSEMBLIES

l. Adjust Driving Plate Separator Studs. Tighten three driving plate separator studs until they just contact driving plate. Back off studs one complete turn to provide necessary $\frac{1}{16}$ -inch clearance, and tighten studs with lock nuts (fig. 252).

m. Install Clutch Spindle Flange. Reinstall flange on spindle (fig. 17). Install flat washer and flange nut, and tighten nut. Secure nut with cotter pin. The engine is now completely assembled, ready for test run.

ORDNANCE MAINTENANCE – ORDNANCE ENGINE
MODEL R975-C4 (CONTINENTAL)

CHAPTER 6

TESTS AND ADJUSTMENTS

| | Paragraph |
|--------------------------------|-----------|
| Preliminary instructions | 80 |
| Test schedule | 81 |
| Test procedure | 82 |
| Final adjustments | 83 |

80. PRELIMINARY INSTRUCTIONS.

a. **General.** Test engine after each complete overhaul to “run-in” new parts, and to see if engine operates satisfactorily. Attach engine to suitable dynamometer stand. If dynamometer equipment is not available, use a calibrated test club propeller designed to absorb 440 brake horsepower at 2,400 revolutions per minute. Also use a positive type pressure gage for measuring oil pressure. Before starting engine, check all items vital to safe operation such as, fuel lines and oil lines, oil supply, magneto ground wires, throttle controls, and mounting bolts. Have fire extinguishers handy.

81. TEST SCHEDULE.

a. Operate engine under loads specified in test schedule below.

| Period | Time Min. | R.P.M. | Observed H.P. (Approx.) | Fuel Flow Lb/Hr (Approx.) | Absolute Manometer Pressure (In. of Hg.) (Approx.) |
|--------|--------------|--|-------------------------------|---------------------------------|--|
| 1 | 10 | Warm up to 1,200 rpm | | | |
| 2 | 10 | 1,200 | 55 | 40 | 16 – 17 |
| 3 | 10 | 1,500 | 107 | 65 | 18 – 19 |
| 4 | 15 | 1,600 | 130 | 80 | 20 – 21 |
| 5 | 15 | 1,700 | 156 | 95 | 21 – 22 |
| 6 | 15 | 1,800 | 185 | 110 | 23 – 24 |
| 7 | 20 | 1,900 | 208 | 120 | 24 – 25 |
| 8 | 20 | 2,000 | 254 | 132 | 26 – 27 |
| 9 | 20 | 2,100 | 294 | 190 | 28 – 29 |
| 10 | 30 | 2,200 | 339 | 220 | 31 – 32 |
| 11 | 30 | 2,300 | 386 | 260 | 34 – 35 |
| 12 | 5 | 2,400 F.T. | 440 | 310 | 37 – 38 |
| 13 | 30 | 97.5 percent (2340) : 93 percent (408) | | 274 | 35 – 36 |
| 14 | 10 | Cool off period. | | | |

82. TEST PROCEDURE.

a. **Make Entries on Inspection Log.** Before starting engine, enter number of carburetor and magnetos on inspection log accompanying engine.

TESTS AND ADJUSTMENTS

b. Start Engine. Start engine and enter time, initial speed, oil pressure and oil-in temperature on log sheet. Operate engine for period of time indicated in Test Schedule (par. 81).

c. Check Cylinder Firing. After starting engine, check cylinder firing, and adjust carburetor idle mixture if necessary. To check cylinders for firing, examine cylinder exhaust stacks. Flame from stack indicates cylinder is firing. A red colored stack indicates heavy oil consumption, a blue stack (the ideal condition) indicates low oil consumption for that cylinder. Shut off engine. Feel each cylinder. A cool cylinder indicates that particular cylinder is not firing.

d. Make Test Run. Start and run engine for periods of time indicated in Test Schedule (par. 81). Enter time, oil pressure, and oil-in temperature at start of each period. Complete reading for each period as soon as engine operation has become stabilized. During the No. 11 test period, take three complete readings. Readings should approximate figures shown in test schedule. During period No. 12, run engine at full throttle for 5 minutes and determine proper load for period No. 13. Take three complete readings during period No. 13 for oil consumption check.

83. FINAL ADJUSTMENTS.

a. Oil Pressure Adjustment. After 1 hour (after period No. 5) or at 1,800 revolutions per minute, reset oil pressure to 65 pounds. The oil-in temperature should be between 160° and 180°F. Remove oil pressure relief valve adjusting screw cap. Hold wrench (41-W-1577-400) on relief valve body, and loosen lock nut. Tighten relief valve body in pump. When engine is stabilized at 1,800 revolutions per minute, adjust oil pressure to 65 pounds by turning adjusting screw. When correct setting has been obtained, hold the adjusting screw from turning, and tighten lock nut securely. Just previous to period No. 12, with engine speed stabilized at 2,400 revolutions per minute, adjust oil pressure to 75 pounds. Lock relief valve adjusting screw, install new gasket, and replace relief valve cap. Lock wire parts together securely.

b. Magneto Checks. Make final magneto adjustment at start of test run. Check magnetos with test light. Magnetos should reach their peak advance at engine speed of 1,500 revolutions per minute. If either magneto does not reach its peak advance at 1,500 revolutions per minute, reset it until it does. Make two further magneto checks, one during period No. 9 and one after period No. 13 with the engine operating at 2,400 revolutions per minute. In these checks, engine speed should not drop more than 100 revolutions per minute when the engine is switched from one magneto to the other. If engine speed drops more than 100 revolutions per minute, reset magnetos.

**ORDNANCE MAINTENANCE – ORDNANCE ENGINE
MODEL R975-C4 (CONTINENTAL)**

c. **Set Governor.** Set governor at end of test run. Stop engine, and turn governor speed adjusting screw to the left to reduce governor spring tension to a minimum. Start engine. Open throttle wide. Engine speed should not exceed 2,400 revolutions per minute with the adjusting screw turned to the left. Turn speed adjusting screw to the right, to increase tension of the governor spring until tachometer registers from 2,200 to 2,250 revolutions per minute. Lock governor adjustment. Test governor by closing engine throttle to drop engine to idling speed. Then open throttle wide. Engine speed should not exceed 2,400 revolutions per minute. After governor has been adjusted, make check to see that there is no engine surge at various engine speeds. To insure close regulation (60 to 150 rpm) between "no-load" and "full-load", bring governor linkage eye bolt up as far as necessary to insure close regulation without encountering surge. Do not regulate governor to get a closer regulation than 60 revolutions per minute, or surging will develop under different running or load conditions. A 75 to 100 revolutions per minute regulation is highly desirable, but not always possible to obtain. For this reason, a 150 revolutions per minute drop is permissible.

CHAPTER 7
FITS AND TOLERANCES

| | Paragraph |
|--|-----------|
| Front and main crankcase sections and front main bearing support | 84 |
| Cylinder assemblies, valves, and valve mechanisms | 85 |
| Crankshaft, master rod, articulated rods, and knuckle pins | 86 |
| Diffuser section | 87 |
| Rear crankcase section and accessories | 88 |
| Oil pump | 89 |
| Flywheel and fan assembly | 90 |

84. FRONT AND MAIN CRANKCASE SECTIONS AND FRONT MAIN BEARING SUPPORT.

| | Replace Beyond | Minimum | Maximum |
|--|-------------------|---------|---------|
| Crankshaft thrust bearing nut and oil seal ring, side clearance | 0.010L | 0.002L | 0.006L |
| Front crankcase section cover and cover sleeve, diameter | | 0.003T | 0.006T |
| Front crankcase section cover clamp and thrust bearing, shim | | 0.005T | 0.007T |
| Front main bearing and bearing ring, diameter | | 0.0002T | 0.0015L |
| Front main bearing support and bearing ring, diameter | | 0.003T | 0.006T |
| Front main bearing support and front crankcase section, diameter | | 0.003T | 0.003L |
| Front main bearing support and main crankcase section, diameter | 0.006L | 0.000 | 0.006L |
| Thrust bearing, total end movement | 0.020 | 0.006 | 0.010 |

85. CYLINDER ASSEMBLIES, VALVES, AND VALVE MECHANISMS.

| | | | |
|--|--------|---------|---------|
| a. Cylinders. | | | |
| Cylinder barrel, choke | 0.004 | 0.008 | 0.010 |
| b. Piston Assemblies. | | | |
| Piston and piston pin, diameter | 0.003L | 0.000 | 0.001L |
| Piston, cast, center of skirt and cylinder, diameter | 0.035L | 0.015 | 0.019 |
| Piston, forged, center of skirt and cylinder, diameter | 0.035L | 0.025 | 0.029 |
| Piston groove No. 1 (top) and ring, side clearance | | 0.0055L | 0.007L |
| Piston groove No. 2 and ring, side clearance | | 0.004L | 0.0055L |

**ORDNANCE MAINTENANCE — ORDNANCE ENGINE
MODEL R975-C4 (CONTINENTAL)**

| | Replace Beyond | Minimum | Maximum |
|---|---------------------------|----------------|----------------|
| Piston groove No. 3 and ring, side clearance | | 0.0025L | 0.004L |
| Piston groove No. 4 and ring, side clearance | | 0.0025L | 0.004L |
| Piston groove No. 5 and ring, side clearance | | 0.0025L | 0.004L |
| Piston pin and bushing, diameter . . | 0.005L | 0.0015L | 0.0025 |
| Piston pin and plug | 0.005L | 0.0015L | 0.0025 |
| Piston pin bushing, and master and articulated rods, diameter | | 0.0045T | 0.0065T |

NOTE: Piston pin plugs assembled in piston pin and cylinder bore. Replace flat spot in excess of 5/16-inch diameter wear on radius of plug.

c. Rocker Arm Assemblies.

| | | | |
|--|---------|-------------|---------|
| Rocker bearing bore and rocker bolt, diameter | 0.011L | 0.000 | 0.001L |
| Rocker bearing, outside diameter, and rocker arm, diameter | 0.001T | | 0.002T |
| Rocker bolt and rocker box, diameter | | 0.0005L | 0.003L |
| Rocker box and rocker bearing, clearance before clamping | 0.010L | 0.004L | 0.010L |
| Rocker roller and rocker arm, side clearance | 0.0025L | 0.0095L | 0.0155L |
| Rocker roller hub and pin, diameter | 0.0025L | | 0.0025L |
| Rocker roller hub and rocker arm, side clearance | | rivet tight | |
| Rocker roller hub and roller, diameter | 0.005L | 0.0015L | 0.0035L |

d. Valve Mechanisms.

| | | | |
|--|---------|---------|----------|
| Valve guide and cylinder head, intake, shrink fit | | 0.001T | 0.0025T |
| Valve guide and cylinder head, exhaust, shrink fit | | 0.002T | 0.0035T |
| Valve guide and valve, intake, diameter | 0.0035L | 0.0013L | 0.0028L |
| Valve guide and valve, exhaust, diameter | 0.0065L | 0.0035L | 0.0005L |
| Valve seat and cylinder head, intake, shrink fit | | 0.014T | 0.017T |
| Valve seat and cylinder head, exhaust, shrink fit | | 0.011T | 0.015T |
| Valve spring, outer, diameter of wire, 0.192 inch | | | |
| Weight at 1.34-inch height | 90 lb | 94.8 lb | 104.8 lb |

FITS AND TOLERANCES

| | Replace Beyond | Minimum | Maximum |
|--|---------------------------|----------------|----------------|
| Weight at 1.96-inch height | 50 lb | 54.5 lb | 86.5 lb |
| Valve spring, intermediate, diameter of wire, 0.162 inch | | | |
| Weight at 1.40-inch height | 69 lb | 73.0 lb | 80.6 lb |
| Weight at 1.96-inch height | 38 lb | 42.0 lb | 51.5 lb |
| Valve spring, inner, diameter of wire, 0.120 inch | | | |
| Weight at 1.32-inch height | 35 lb | 38.6 lb | 42.6 lb |
| Weight at 1.88-inch height | 20 lb | 22.4 lb | 27.4 lb |
| Valve tappet ball socket spring, di- ameter of wire, 0.051 inch | | | |
| Weight at 2.18-inch height | 6 lb | 7.74 lb | 9.46 lb |
| Valve tappet guide and crankcase section, diameter | | 0.001T | 0.003T |
| Valve tappet guide and valve tappet, diameter | 0.003L | 0.0005 | 0.0015L |
| Valve tappet roller and roller pin, diameter | 0.006L | 0.003L | 0.0045L |
| e. Cam Assembly. | | | |
| Cam and cam drive pinion, backlash | 0.020 | 0.006 | 0.014 |
| Cam and cam bearing, diameter | | 0.0015T | 0.0045T |
| Cam and cam hub and attaching rivet, diameter before assembly | | 0.000 | 0.006L |
| Cam drive pinion spring, wire di- ameter 0.062 inch | | | |
| Weight at 1.375-inch height | 6 lb | 8 lb | |
| Cam hub end clearance | 0.016L | 0.009L | 0.016L |
| Cam hub and cam bearing, diameter | | 0.0015T | 0.0045T |
| Cam hub support and cam bearing, diameter | 0.008 | 0.003L | 0.005L |

**86. CRANKSHAFT, MASTER ROD, ARTICULATED RODS,
AND KNUCKLE PINS.**

a. Crankshaft and Crankshaft Gear.

| | | | |
|--|--------|---------|---------|
| Crankpin bearing and crankpin, di- ameter | 0.006L | 0.0025L | 0.004L |
| Crankpin bearing and master rod, diameter, shrink fit | | 0.001T | 0.003T |
| Crankshaft and crankshaft gear, di- ameter | | 0.0005L | 0.002L |
| Crankshaft and front main bearing, diameter | | 0.0002T | 0.0007T |
| Crankshaft and thrust bearing, di- ameter | | 0.0002T | 0.0009T |

**ORDNANCE MAINTENANCE — ORDNANCE ENGINE
MODEL R975-C4 (CONTINENTAL)**

| | Replace Beyond | Minimum | Maximum |
|---|---------------------------|----------------|----------------|
| Crankshaft bearing and main crank- case section, diameter | | 0.002L | 0.004T |
| Crankshaft bearing and rear crank- shaft, diameter | 0.0055L | 0.002L | 0.004L |
| Crankshaft cheek and flange of rear main bearing, clearance | | 0.025 | 0.040 |
| Crankshaft clamping cap screw elon- gated | | 0.005 | 0.007 |
| Crankshaft front and rear sections, diameter before tightening clamp- ing cap screw | 0.001L | 0.001T | 0.001L |
| Crankshaft gear hub and crankshaft gear, diameter | 0.005L | 0.001L | 0.003L |
| Crankshaft gear hub and crankshaft gear, side clearance | 0.010L | 0.003L | 0.005L |
| Crankshaft gear spring, wire diameter 0.1251 inch | | | |
| Weight at 0.713-inch height | 0.170 lb | 181 lb | 191 lb |
| Crankshaft rear end plug and crank- shaft, diameter | | 0.000 | 0.002T |
| Crankshaft run-out between threads and splines at forward end when supported at front and rear main bearing (full indicator reading) | 0.004 | | |
| Crankshaft run-out at center bearing journal when supported at thrust and rear main bearings (full indica- tor reading) | 0.004 | | |
| Crankshaft run-out at thrust bearing journal when supported at front main bearing and rear main bear- ing (full indicator reading) | 0.004 | | |
| Crankshaft spline, side clearance. Movement of hub on crankshaft measured at 15-inches, radius from center of crankshaft | 0.050 | | 0.040 |
| Rear crankshaft and counterweight pin bushing, diameter | | 0.001T | 0.0025T |
| Rear crankshaft and counterweight, side clearance, total | 0.015L | 0.006L | 0.012L |
| Rear crankshaft counterweight and bushing, diameter | | 0.0015T | 0.003T |
| Rear crankshaft counterweight and stop, clearance | 0.060L | 0.041L | 0.057L |

FITS AND TOLERANCES

| | Replace Beyond | Minimum | Maximum |
|--|-------------------|-------------|---------|
| b. Master Rod. | | | |
| Master rod, end clearance on crank-pin | | 0.017L | 0.019L |
| Master rod, maximum twist or misalignment | 0.0045 | in 6 inches | |
| c. Articulated Rods. | | | |
| Articulated rod, maximum twist or misalignment | 0.0045 | in 6 inches | |
| d. Knuckle Pins. | | | |
| Knuckle pin and master rod, diameter | 0.000 | 0.000 | 0.008T |
| Knuckle pin bushing and articulated rod, diameter | | 0.0045T | 0.0065T |
| Knuckle pin bushing and knuckle pin, diameter | 0.004 | 0.0015L | 0.0025L |
| Knuckle pin bushing and master rod, side clearance | 0.020L | 0.006L | 0.014L |
| Knuckle pin locks. Select locks to obtain a light tapping fit when assembled between knuckle pins. | | | |
| 87. DIFFUSER SECTION. | | | |
| a. Diffuser Section. | | | |
| Diffuser section and accessory drive shaft bushing, diameter | | 0.001T | 0.003T |
| Diffuser section shoulder and diffuser ring, diameter | | 0.003L | 0.007L |
| b. Starter Shaft and Gear. | | | |
| Starter drive and crankshaft gear, backlash | 0.020 | 0.008 | 0.016 |
| Starter drive gear and bushing, diameter | 0.006L | 0.0025L | 0.004L |
| Starter drive gear bushing and diffuser section, diameter | | 0.001T | 0.003T |
| Starter shaft, end clearance | 0.050L | 0.013L | 0.045L |
| Starter shaft bushing and rear crankcase section, diameter | | 0.001T | 0.003T |
| Starter shaft bushing and shaft, diameter | 0.006L | 0.0025L | 0.004L |
| c. Impeller Assembly. | | | |
| Impeller and shaft. Impeller must be tight fit on splines. | | | |
| Impeller and impeller housing, front clearance | 0.032 | 0.022 | 0.032 |

**ORDNANCE MAINTENANCE — ORDNANCE ENGINE
MODEL R975-C4 (CONTINENTAL)**

| | Replace Beyond | Minimum | Maximum |
|---|---------------------------|----------------|----------------|
| Impeller drive gear hub, bearing and impeller drive gear bushing, diameter | 0.006L | 0.003L | 0.004L |
| Impeller drive gear hub bearing, between shaft support and diffuser section | | 0.000 | 0.008T |
| Impeller drive gear pinion and bearing | 0.025L | 0.008L | 0.016L |
| Impeller drive pinion and crankshaft gear backlash | 0.025 | 0.010 | 0.018 |
| Impeller intermediate gear and bushing, diameter | | 0.001T | 0.003T |
| Impeller oil seal ring, gap | 0.008 | 0.000 | 0.006 |
| Impeller oil seal ring, side clearance | 0.010L | 0.006L | 0.008L |
| Impeller shaft and ball bearing, diameter | | 0.0001 | 0.0004T |
| Impeller shaft bearing support and bearing, diameter | 0.0015L | 0.0005L | 0.0013L |
| Impeller shaft gear and drive gear, backlash | 0.012 | 0.002 | 0.008 |
| Impeller shaft nut lock and nut, end clearance | 0.002L | 0.000 | 0.002L |
| Impeller shaft nut lock, side clearance | | 0.000 | 0.003 |
| Impeller shaft rear ball bearing, side clearance | 0.006L | 0.004L | 0.006L |
| Impeller shaft rear bearing and cage, diameter | 0.0015L | 0.0005L | 0.0013L |

88. REAR CRANKCASE SECTION AND ACCESSORIES.

a. Accessory Drive Shaft.

| | | | |
|---|--------|---------|---------|
| Accessory drive idler gear, end clearance | 0.030L | 0.011L | 0.021L |
| Accessory drive idler gear and bushing, diameter | 0.006L | 0.0025L | 0.0045L |
| Accessory drive idler gear bushing and diffuser section, diameter | | 0.0011 | 0.003T |
| Accessory drive gear and tachometer and fuel pump drive shaft adapter, diameter | 0.005L | 0.0015L | 0.0035L |
| Accessory drive housing and rear crankcase section, diameter | 0.005L | 0.001L | 0.003L |
| Accessory drive shaft and bushing, diameter | 0.008L | 0.0025L | 0.0045L |

FITS AND TOLERANCES

| | Replace Beyond | Minimum | Maximum |
|---|---------------------------|----------------|----------------|
| Accessory drive shaft and rear bushing, diameter | 0.006L | 0.0025L | 0.0045L |
| Accessory drive shaft bevel gear and accessory drive gear, backlash | 0.020 | 0.004 | 0.012 |
| Accessory drive shaft bushing and crankcase rear section, diameter . . | 0.003L | 0.000 | 0.002L |
| Accessory drive shaft rear bushing and crankcase rear section, diameter | | 0.001T | 0.003T |
| Accessory idler, starter, and accessory drive gear, backlash | 0.020 | 0.004 | 0.012 |
| Magneto shaft, end clearance | 0.035 | 0.012 | 0.035 |
| b. Fuel Pump Assembly. | | | |
| Fuel pump adapter and accessory drive housing, diameter | | 0.0005L | 0.0025L |
| Fuel pump adapter and bushing, diameter | | 0.0025T | 0.0045T |
| Fuel pump adapter bushing and fuel pump drive gear, diameter | 0.006L | 0.002L | 0.004L |
| Fuel pump drive gear and thrust plug retainer, diameter | 0.003L | 0.0005L | 0.0015L |
| Fuel pump drive gear and vacuum pump drive shaft, backlash | 0.020 | 0.004 | 0.012 |
| Fuel pump drive gear thrust plug spring, wire diameter 0.046 inch | | | |
| Weight at 0.0560-inch height | 8 lb | 8.9 lb | 9.1 lb |
| Fuel pump drive shaft and drive shaft bushing, diameter | 0.006L | 0.0025L | 0.0045L |
| Fuel pump drive shaft bushing and drive shaft housing, diameter | | 0.001T | 0.003T |
| Fuel pump drive gear and bushing, diameter | 0.005L | 0.001L | 0.003L |
| Fuel pump drive gear and extension, diameter | | 0.000 | 0.002T |
| Fuel pump drive gear bushing and accessory drive housing, diameter . . . | | 0.0015T | 0.0035T |
| Fuel pump drive shaft adapter and accessory drive housing, diameter . . . | | 0.0005L | 0.0025L |
| Fuel pump drive shaft adapter and bushing, diameter | | 0.0035T | 0.0055T |
| Fuel pump drive shaft and adapter bushing, diameter | 0.005L | 0.0016L | 0.0036L |
| Fuel pump drive shaft and collar, diameter | | 0.0005T | 0.0025T |

**ORDNANCE MAINTENANCE — ORDNANCE ENGINE
MODEL R975-C4 (CONTINENTAL)**

| | Replace Beyond | Minimum | Maximum |
|---|---------------------------|----------------|----------------|
| Fuel pump drive shaft and vacuum pump drive gear, backlash | 0.020 | 0.004 | 0.012 |
| c. Generator Drive and Idler Gears. | | | |
| Generator drive gear and bushing, diameter | 0.007 | 0.0025 | 0.0055 |
| Generator drive gear and generator drive gear support, end clearance | | 0.006L | 0.020L |
| Generator drive gear and generator drive intermediate gear, backlash | 0.020 | 0.004 | 0.012 |
| Generator drive gear support and bushing, diameter | 0.007 | 0.0025 | 0.0055 |
| Generator drive gear support and rear crankcase section | | 0.001T | 0.003L |
| Generator drive intermediate and generator intermediate gear support bushing, diameter | 0.006 | 0.0015L | 0.0045 |
| Generator drive intermediate gear and generator drive support | 0.045L | 0.006L | 0.030L |
| Generator idler gear and bushing, diameter | | 0.0005T | 0.0035T |
| Generator idler gear and starter gear, backlash | 0.020 | 0.004 | 0.012 |
| Generator idler gear bushing and shaft, diameter | 0.005L | 0.001L | 0.003L |
| Generator idler gear, end clearance | 0.035 | 0.003L | 0.023 |
| Generator idler gear shaft and bushing, diameter | 0.005L | 0.001L | 0.003L |
| Generator idler gear shaft and rear crankcase section, diameter | | 0.000 | 0.002L |
| Generator idler gear shaft bushing and rear crankcase section, diameter | | 0.001T | 0.003T |
| Generator intermediate gear and generator idler gear, backlash | 0.020 | 0.004 | 0.012 |
| Generator intermediate gear support and bushing, diameter | | 0.001T | 0.003T |
| d. Rear Crankcase Section. | | | |
| Rear crankcase section and packing retainer ring, diameter | | 0.001T | 0.004T |
| Rear crankcase section, tachometer, and three-way accessory drive shaft adapter, large diameter | | 0.001L | 0.005L |

FITS AND TOLERANCES

| | Replace Beyond | Minimum | Maximum |
|--|-------------------|---------|---------|
| e. Tachometer Drive. | | | |
| Tachometer and fuel pump drive shaft and adapter cover bushing, diameter | 0.004 | 0.0005L | 0.0025L |
| Tachometer and fuel pump drive shaft adapter and cover, diameter | | 0.0005L | 0.0025L |
| Tachometer and fuel pump drive shaft adapter, cover, and bushing, diameter | | 0.0005L | 0.0025L |
| Tachometer, fuel pump drive shaft adapter, and rear crankcase section, small diameter | | 0.000 | 0.002L |
| Tachometer and fuel pump drive shaft and vacuum pump drive gear, backlash | 0.020 | 0.004 | 0.012 |
| Tachometer and fuel pump drive shaft and accessory drive gear, diameter | 0.005L | 0.001L | 0.003L |
| Tachometer drive gear and drive-shaft gear, backlash | 0.020 | 0.004 | 0.012 |
| Tachometer drive gear and housing, end clearance | | 0.002L | 0.052L |
| Tachometer drive gear and sleeve and tachometer shaft bushing, diameter | | 0.0005L | 0.0035L |
| Tachometer drive gear and tachometer drive gear sleeve | | 0.0005T | 0.0035T |
| 89. OIL PUMP. | | | |
| Governor drive gear and governor shaft gear, backlash | 0.018 | 0.004 | 0.012 |
| Oil pressure pump body and oil pump idler shaft, end clearance | 0.005L | 0.001L | 0.0025L |
| Oil pressure pump body and oil pump idler shaft, side clearance | 0.005 | 0.002 | 0.0035 |
| Oil pressure relief valve seat and oil pump, diameter | | 0.0023T | 0.0038T |
| Oil pressure relief valve spring, wire diameter 0.051 inch, weight at 1.25-inch height | 4 lb | 4.95 lb | 6.05 lb |
| Oil pump body governor drive shaft bushing, diameter | 0.0035L | 0.001T | 0.0025T |
| Oil pump body and oil pump drive shaft, diameter | 0.0035L | 0.001L | 0.0025L |
| Oil pump body and oil pump idler gear, side clearance | 0.005L | 0.002L | 0.0035L |

ORDNANCE MAINTENANCE – ORDNANCE ENGINE
MODEL R975-C4 (CONTINENTAL)

| | Replace Beyond | Minimum | Maximum |
|--|---------------------------|----------------|----------------|
| Oil pump body and oil pump idler shaft, diameter | 0.0025 | 0.001L | 0.0025L |
| Oil pump body and pump gear, side clearance | 0.005L | 0.002L | 0.0035L |
| Oil pump body bushing and governor drive shaft, diameter | 0.005L | 0.001L | 0.003L |
| Oil pump drive gear and oil pressure pump body, diameter | 0.003L | 0.001L | 0.003L |
| Oil pump drive shaft and oil pump gear spacer, diameter | 0.0025L | 0.0071 | 0.0017L |
| Oil pump drive shaft and oil pressure pump body, diameter | 0.003L | 0.001L | 0.002L |
| Oil pump drive shaft and oil pump idler shaft, backlash | 0.007 | 0.002 | 0.005 |
| Oil pump drive shaft gear and oil pressure pump body, side clearance | 0.0035L | 0.002L | 0.0035L |
| Oil pump gear and oil pump idler gear, backlash | 0.008 | 0.004 | 0.006 |
| Oil pump idler gear and body, end clearance | 0.005L | 0.002L | 0.0035L |
| Oil pump idler shaft and oil pressure pump body, diameter | 0.003L | 0.001L | 0.0025L |
| Oil pump idler shaft and pump spacer, diameter | 0.0025L | 0.0007L | 0.0017L |
| Oil suction strainer spring, wire diameter 0.063 inch, weight at 3.125-inch height | 5 lb | 6 lb | |

90. FLYWHEEL AND FAN ASSEMBLY.

a. Flywheel.

| | | |
|-----------------------------------|--------|--------|
| Diameter of driving pin | 0.7525 | 0.7535 |
|-----------------------------------|--------|--------|

b. Flywheel Hub.

| | | |
|---|--------|--------|
| Inside diameter of hub | 2.631 | 2.638 |
| Inside diameter of splines | 2.412 | 2.419 |
| Diameter of rear spindle bearing seat | 3.5055 | 3.5063 |
| Inside diameter of rear spindle bearing | 3.506 | 3.506 |

CHAPTER 8
TOOLS

| | |
|---------------------|-----------------|
| Common tools | Paragraph 91 |
| Special tools | 92 |

91. COMMON TOOLS.

a. Lists of common tools ordinarily required for work on the R975C-4 engine will be found in SNL N-19 and SNL N-21.

92. SPECIAL TOOLS.

a. Special tool sets required for operations ordinarily performed by organizational mechanics are listed in SNL G-19. SNL G-27 lists standard maintenance tool sets for use by automotive ordnance maintenance establishments. In addition, it lists special tools designed specifically for repair of this engine. The special tools required for the operations described in this manual are listed below:

| TOOL | Federal Stock Number | Manufacturer's Number |
|--|-----------------------------|------------------------------|
| BAR, crankshaft alining, 0.4995-in. diameter; selective fit No. 1 | 41-B-150-25 | MTM-M3-216 |
| BAR, master and articulating rod, piston pin bushing, finish bore alinement checking, 1.2495-in. diameter; selective fit No. 2 | 41-B-263 | MTM-M3-349 |
| BAR, master rod crankshaft bearing, finished bore alinement, 2.2525-in. diameter | 41-B-263-27 | MTM-M3-353 |
| BAR, master rod crankshaft bearing, finished bore alinement, 2.2530-in. diameter | 41-B-263-29 | MTM-M3-354 |
| BAR, valve tappet guide, installing .. | 41-B-332 | MTM-M3-261 |
| COMPRESSOR, piston ring, special 5-in. diameter | 41-C-2550-80 | MTM-M3-207 |
| COMPRESSOR, valve spring | 41-C-2559-25 | MTM-M3-260 |
| CONE, accessory drive shaft, leather oil seal, installing | 41-C-2562-11 | MTM-M3-436 |
| DRIFT, accessory drive shaft, leather oil seal, installing | 41-D-1460 | MTM-M3-427 |
| DRIFT, piston (round fiber) | 41-D-1541-75 | MTM-M3-330 |
| EYE, crankshaft and engine lifting .. | 41-E-615 | MTM-M3-208 |
| FIXTURE, accessory drive shaft bushing, diffuser section, and rear crankcase section holes, line ream .. | 41-F-2987-210 | MTM-M3-345 |
| FIXTURE, boring master and articulating rod bearing | 41-F-2987-425 | |
| FIXTURE, rear bearing, reconditioning, with reamers | 41-F-2994-21 | MTM-M3-376 |

**ORDNANCE MAINTENANCE — ORDNANCE ENGINE
MODEL R975-C4 (CONTINENTAL)**

| TOOL | Federal Stock Number | Manufacturer's Number |
|--|-----------------------------|------------------------------|
| FIXTURE, timing including disk pointer and handle (bare engine) | 41-F-2997-84 | MTM-M3-221 |
| GAGE, plug, valve tappet guide | | |
| GAGE, cylinder bore, star | 41-G-99-500 | MTM-M3-468 |
| GAGE, plug, no-go, exhaust valve guide, 0.6295 in. | 41-G-254-285 | |
| GAGE, thickness, special, 0.010 in. and 0.070 in. | 41-G-412-75 | MTM-M3-211 |
| HONE, valve tappet guide | | |
| INDICATOR, piston, top dead center, dial type (with box) | 41-I-73-110 | MTM-M3-237 |
| PLUG and COLLAR, master rod crankshaft bearing removing and installing | 41-P-2115-500 | MTM-M3-317 |
| PULLER, crankcase section removing (3 per engine required) | 41-P-2906-280 | MTM-M3-359 |
| PULLER, crankshaft rear end plug | 41-P-2907-100 | MTM-M3-296 |
| PULLER, knuckle pin | 41-P-2941-125 | MTM-M3-362 |
| PULLER, leather oil seal, accessory drive | 41-P-2951-11 | MTM-M3-298 |
| REAMER, carbon steel, accessory drive shaft short and long bushing hand line ream, standard size | 41-R-390 | MTM-M3-342 |
| REMOVER and REPLACER, bearing, crankshaft, rear | 41-R-2373-675 | WR-81014 |
| REAMER and BUSHING, starter shaft and starter drive gear bushing | 41-R-2324 | MTM-M3-316 |
| RING, checking cylinder bore diameter (use w/41 G-99-500) | 41-R-2492 | MTM-M3-423 |
| ROLLERS, crankshaft alinement | 41-R-2660 | MTM-M3-288 |
| STAND, crankshaft assembly and disassembly | 41-S-4932 | MTM-M3-527 |
| STAND, master and articulating rod hole alinement checking | 41-S-4977 | MTM-M3-350 |
| STAND, valve removing and installing | 41-S-4988-77 | MTM-M3-214 |
| TOOL, impeller shaft and front nut, locking | 41-T-3217-100 | MTM-M3-417 |
| TOOL-SET, piston pin and knuckle bushing replacement | 41-T-3539-8 | MTM-M3-384 |
| WRENCH, generator removing | 41-W-636-550 | |
| WRENCH, crankshaft gear hub screw (O.D. 0.550-0.555) | 41-W-871-31 | MTM-M3-294 |

TOOLS

| TOOL | Federal Stock Number | Manufacturer's Number |
|---|---------------------------------|----------------------------------|
| WRENCH, crankshaft thrust bearing nut | 41-W-871-35 | MTM-M3-297 |
| WRENCH, cylinder hold-down nut, $\frac{9}{16}$ -in. hex. (EC-3 only) | 41-W-872-375 | MTM-M3-287 |
| WRENCH, intake pipe packing nut | 41-W-1537 | MTM-M3-210 |
| WRENCH, oil pump to crankcase rear section attaching nut, $\frac{7}{16}$ -in. hex | 41-W-1577-500 | MTM-M3-299 |
| WRENCH, push rod housing clamp screw (flexible) | 41-W-1986 | MTM-M3-483 |
| WRENCH, clutch spindle flange | 41-W-3058-300 | |
| WRENCH, rear cylinder attaching nuts | | |

**ORDNANCE MAINTENANCE — ORDNANCE ENGINE
MODEL R975-C4 (CONTINENTAL)**

REFERENCES

STANDARD NOMENCLATURE LISTS.

| | |
|---|---------------------|
| Cleaning, preserving and lubricating materials; recoil fluids, special oils, and miscellaneous related items | SNL K-1 |
| Soldering, brazing, and welding material, gases, and related items | SNL K-2 |
| Tools, maintenance, for repair of automotive vehicles | SNL G-27 Vol. 1 |
| Interchangeability chart of ordnance maintenance tools for combat vehicles | SNL G-27 Vol. 2 |
| Tool-sets, motor transport | SNL N-19 |
| Tool-sets for ordnance service command, automotive shops | SNL N-30 |
| General tools and supplies, ordnance base automotive maintenance company (engine rebuild) | SNL N-327 |
| Current Standard Nomenclature Lists are listed above. An up-to-date list of SNL's is maintained in the Index to Ordnance Publications | ASF CAT. ORD-2 OPSI |

EXPLANATORY PUBLICATIONS.

| | |
|---|-----------|
| Military motor vehicles | AR 850-15 |
| List of publications for training | FM 21-6 |

Related Technical Manuals.

| | |
|--|------------|
| Ordnance maintenance: Accessories for Wright R975EC-2 engines for medium tanks M3 and M4 | TM 9-1750D |
| Ordnance maintenance: Electrical equipment (Delco Remy) | TM 9-1825A |
| Ordnance maintenance: Electrical equipment (Auto-Lite) | TM 9-1825B |
| Ordnance maintenance: Carburetors (Stromberg) | TM 9-1826B |
| Ordnance maintenance: Fuel pumps | TM 9-1828A |

Automotive Materiel.

| | |
|-------------------------------|-----------|
| Automotive electricity | TM 10-580 |
| Electrical fundamentals | TM 1-455 |

REFERENCES

- Fuels and carburetion TM 10-550
 The internal combustion engine TM 10-570
 The motor vehicle TM 10-510
- Care and Preservation.**
- Automotive lubrication TM 10-540
 Cleaning, preserving, lubricating, and welding
 materials and similar items issued by the Ord-
 nance Department TM 9-850
 Explosives and demolitions FM 5-25
 Motor transport inspections TM 10-545
 Product guide OFSB 6-2
- Decontamination.**
- Chemical decontamination materials and equip-
 ment TM 3-220
 Decontamination of armored force vehicles FM 17-59
 Defense against chemical attack FM 21-40
- Storage and Shipment.**
- Registration of motor vehicles AR 850-10
 Rules governing the loading of mechanized and
 motorized army equipment, also, major caliber
 guns, for the United States Army and Navy, on
 open top equipment published by Operations
 and Maintenance Department of Association
 of American Railroads
 Storage of motor vehicle equipment AR 850-18
 Ordnance field service storage and shipment
 Chart — group G major items OSSC-G

**ORDNANCE MAINTENANCE — ORDNANCE ENGINE
MODEL R975-C4 (CONTINENTAL)**

INDEX

| A | Page No. | Page No. |
|--|-----------------|--|
| Accessory drive gears | | |
| installation | 199 | main 97-100, 206-215 |
| removal | 65-67 | rear 171 |
| replacement | 154 | crankshaft 130-136 |
| Accessory drive housing, three-way | | crankshaft gear assembly 141 |
| assembly | 182 | cylinders 107-112 |
| cleaning, inspection, repair | 182 | diffuser section 156-162 |
| installation | 205 | diffuser and rear crankcase sec- |
| removal | 163-165 | tion 194-206 |
| Accessory drive mechanism de- | | disassembly and assembly of |
| scription | 16-19 | subassemblies 85 |
| Accessory drive shafts | | fan to flywheel 192 |
| fits and tolerances | 254-255 | flywheel and fan 191 |
| installation | 194-195 | front main bearing support 88 |
| removal | 167-168 | fuel pump and mounting 187 |
| Accessory drive, three-way, and | | generator drive gear support 181 |
| tachometer | | generator idler gear and shaft 180 |
| assembly | 184 | ignition harness 189-190 |
| cleaning | 182 | master rod 130-136 |
| disassembly | 182 | oil drain tubes 113 |
| installation | 203 | oil pump 176-178 |
| removal | 167 | pistons 117 |
| Adjustments and tests 178, 246-248 | | starter gear and shaft 180 |
| Adjustment | | tachometer drive assembly 185-186 |
| governor | 248 | three-way accessory drive hous- |
| magneto | 247 | ing 182 |
| oil pressure | 247 | valve operating mechanism 107-112 |
| valves | 227-229 | |
| Air deflectors, cleaning, inspection | | |
| and repair | 192 | B |
| Air deflectors, intercylinder, instal- | | Baffle attaching springs, removal 47 |
| lation | 220-223 | Body screws, replacement 176 |
| Antifriction bearings, cleaning 82 | | Booster coil |
| Articulated rods | | installation 239 |
| fits and tolerances | 253 | removal 39-40 |
| installation | 209 | Bushings, replacement 169-170 |
| removal | 58-61 | |
| replacement | 137 | C |
| Articulated rods and knuckle pins | | Cables to and from distributor |
| assembly | 140 | blocks |
| cleaning | 137 | installation 190 |
| disassembly | 136 | removal 188 |
| inspection and repair 137-140 | | Cam assembly |
| Assembly | | installation 99-100 |
| articulated rods and knuckle pins 140 | | removal 64 |
| crankcase section | | Cam hub and ring assembly |
| front 88, 206-215 | | inspection 95-97 |
| | | installation 97 |

INDEX

| C—Cont'd | Page No. | Page No. | |
|-------------------------------------|-----------------|--------------------------------------|-----------------|
| Carburetor, removal | 35 | Conduits, installation | 189 |
| Carburetor elbow | | Conduit at carburetor, removal | 34-35 |
| installation | 237-238 | Cone, front and nut, installation .. | 239 |
| removal | 162-163 | Cone, rear, installation | 239 |
| Carburetor support bracket | | Connecting rod assemblies, descrip- | |
| installation | 238 | tion | 14-15 |
| removal | 35 | Cover plates, removal | 162 |
| Cigarette connectors, installa- | | Cover crankcase section, rear in- | |
| tion | 189-190 | stallation | 195-196 |
| Cigarette connector protectors, re- | | Cowling | |
| moval | 188 | cleaning, inspection and repair | 192 |
| Clamping cap screw, removal | 120 | description | 10 |
| Cleaning | | removal | 45 |
| air deflectors | 192 | Crankcase breather | |
| antifriction bearings | 82 | installation | 235 |
| articulated rods and knuckle pins | 137 | removal | 47-48 |
| cowling | 192 | Crankcase sections | |
| crankcase section | | front | |
| front | 86 | assembly | 88, 206-215 |
| main | 89 | cleaning | 86 |
| rear | 168-169 | description | 8-10 |
| crankshaft gear assembly .. | 125, 141 | disassembly | 86 |
| cylinders | 104-105 | fits and tolerances | 249 |
| diffuser section | 144 | inspection and repair | 86-88 |
| disassembly and assembly of | | installation | 212-213 |
| subassemblies | 82 | removal | 56-58 |
| engine supports | 192 | main | |
| exhaust manifold collector | | assembly | 97-100, 206-215 |
| ring | 192-193 | cleaning | 89 |
| flywheel and fan | 190 | disassembly | 88-89 |
| main bearing support, front .. | 86 | inspection and repair | 89-96 |
| fuel pump and mounting | 187 | removal | 62-63 |
| generator idler gear and shaft | 180 | rear | |
| generator drive gear support .. | 181 | assembly | 171 |
| ignition harness | 188-189 | cleaning | 168-169 |
| master rod | 125 | disassembly | 162-168 |
| oil pump | 173 | fits and tolerances | 254-255 |
| pistons | 113-116 | inspection | 168-169 |
| starter gear and shaft | 179-180 | removal | 69, 168 |
| sump assembly | 193 | subassemblies | 179-180 |
| tachometer drive assembly | 184-185 | Crankcase sections, rear and dif- | |
| three-way accessory drive hous- | | fuser (See diffuser and crankcase | |
| ing | 182 | section) | |
| valve operating mechanisms | 104-105 | Crankcase section, rear, on stand, | |
| Clutch, flywheel and fan (See fly- | | installation | 190 |
| wheel, fan and clutch) | | Crankpin plug from crankpin, re- | |
| Clutch parts, removal | 33 | moval | 120 |
| Clutch spindle flange | | Crank plug, rear; removal | 120 |
| installation | 245 | Crank, rear; removal | 120 |
| removal | 32 | | |

**ORDNANCE MAINTENANCE – ORDNANCE ENGINE
MODEL R975-C4 (CONTINENTAL)**

| C—Cont'd | Page No. | | Page No. |
|--|-----------------|--|-----------------|
| Crankshaft | | engine lubrication system | 22-27 |
| assembly | 130-136 | engine, model R975-C4 (Con- | |
| cleaning | 125 | tinental) | 8-27 |
| description | 15-16 | fuel system | 20-22 |
| disassembly | 119-125 | ignition system | 20 |
| fits and tolerances | 251-252 | pistons, piston pins and rings | 12-13 |
| inspection and repair | 125-130 | valve operating mechanism . . . | 13-14 |
| installation | 206-207 | Diffuser section | |
| removal | 63-64 | assembly | 156-162 |
| Crankshaft gear, removal | 63 | cleaning | 144 |
| Crankshaft, front end | | disassembly | 141-143 |
| inspection | 125-126 | fits and tolerances | 253 |
| installation | 124 | inspection | 144-154 |
| Crankshaft gear assembly | | installation | 199 |
| assembly | 141 | Diffuser section bushings, replace- | |
| cleaning | 141 | ment | 149 |
| disassembly | 140 | Diffuser section, cover | 206 |
| inspection | 141 | Diffuser and rear crankcase sections | |
| Cylinders | | assembly | 194-206 |
| assembly | 107-112 | installation | 194-206 |
| cleaning | 104-105 | Diffuser section from rear crank- | |
| description | 12 | case section | 67-69 |
| disassembly | 100-104 | Diffuser ring | |
| fits and tolerances | 249-250 | installation | 157-158 |
| inspection | 105-112 | removal | 143 |
| installation | 216-219 | Disassembly and assembly of sub- | |
| removal | 52-53 | assemblies | |
| Cylinder head air deflectors, in- | | assembly | 85 |
| stallation | 223 | cleaning | 82 |
| Cylinder head baffles, removal | 50 | inspection | 82 |
| Cylinder, No. 1, installation | 217-219 | repair | 83-85 |
| Cylinder temperatures, data | 28 | Disassembly of engine into sub- | |
| | | assemblies | |
| | | preliminary instructions | 30-32 |
| | | Disassembly | |
| | | articulated rods and knuckle pins | 136 |
| | | crankshaft | 119-125 |
| | | crankshaft gear assembly | 140 |
| | | cylinders | 100-104 |
| | | disassembly and assembly of | |
| | | subassemblies | 82 |
| | | diffuser section | 141-143 |
| | | flywheel and fan | 190 |
| | | front crankcase section | 86 |
| | | front main bearing support | 86 |
| | | fuel pump and mounting | 187 |
| | | generator drive gear support | 181 |
| | | generator idler gear and shaft | 180 |
| | | ignition harness | 188 |

D

| | |
|-------------------------------------|-------|
| Data | |
| cylinder temperatures | 28 |
| engine lubrication system | 29 |
| engine, model R975-C4 (Con- | |
| tinental) | 27-29 |
| fuel system | 28-29 |
| ignition | 28 |
| valves | 27-28 |
| Description | |
| accessory drive mechanism | 16-19 |
| connecting rod assemblies | 14-15 |
| cowling | 10 |
| crankcase | 8-10 |
| crankshaft | 15-16 |
| cylinders | 12 |

INDEX

| D—Cont'd | Page No. | Page No |
|--|-----------------|----------------|
| Disassembly—Cont'd | | |
| impeller bearing cage | 142–143 | |
| main crankcase section | 88–89 | |
| master rod | 119–125 | |
| oil pump | 171–173 | |
| pistons | 113 | |
| rear crankcase section | 162–168 | |
| starter gear and shaft | 179 | |
| tachometer drive assembly | 184 | |
| three three-way accessory drive housing | 181–182 | |
| valve operating mechanisms | 100–104 | |
| Driven disk, inner and outer, installation | 243 | |
| Driving plate, installation | 243 | |
| Dynamic damper | | |
| inspection | 127 | |
| installation | 130–131 | |
| removal | 124 | |
| test | 127 | |
| E | | |
| Engine, model R975-C4 (Continental) | | |
| data | 27–29 | |
| description | 8–27 | |
| lubrication system | | |
| data | 29 | |
| description | 22–27 | |
| supports | | |
| cleaning, inspection and repair | 192 | |
| rear, installation | 237 | |
| rear, removal | 43 | |
| support bar, installation, removal | 43–45, 233 | |
| Exhaust elbows | | |
| installation | 113 | |
| removal | 101 | |
| Exhaust manifold collector ring | | |
| cleaning, inspection and repair | 192–193 | |
| installation | 237 | |
| removal | 43 | |
| F | | |
| Fan assembly | | |
| fits and tolerances | 258 | |
| inspection | 191 | |
| Fan assembly and flywheel | | |
| assembly | 192 | |
| fits and tolerances | 258 | |
| installation | 239 | |
| removal | 190 | |
| Fan, flywheel and clutch (See Flywheel, fan and clutch) | | |
| Fits and tolerances | | |
| accessory drive shaft | 254–255 | |
| articulated rods | 253 | |
| crankcase sections | | |
| front and main | 249 | |
| rear | 250 | |
| rear and accessories | 254–255 | |
| crankshaft | 251–252 | |
| cylinder assemblies | 249–250 | |
| diffuser section | 251 | |
| fan assembly | 251 | |
| flywheel | 251 | |
| flywheel hub | 251 | |
| front main bearing support | 249 | |
| fuel pump assembly | 255–256 | |
| impeller assembly | 253–254 | |
| knuckle pins | 251 | |
| master rods | 251 | |
| oil pump | 257–258 | |
| piston assemblies | 249–250 | |
| rocker arm assemblies | 251 | |
| starter shaft and gear | 251 | |
| tachometer drive | 251 | |
| valves | 249–250 | |
| valve mechanisms | 250–251 | |
| Flywheel | | |
| fits and tolerances | 251 | |
| inspection | 191 | |
| Flywheel and fan | | |
| assembly | 191 | |
| cleaning, inspection and repair | 190–191 | |
| disassembly | 191 | |
| fits and tolerances | 251 | |
| installation | 239 | |
| removal | 3 | |
| Flywheel hub, fits and tolerances | | |
| Flywheel fan and clutch, installation | | |
| Flywheel ring and pressure plate | | |
| installation | 24 | |
| removal | 32–33 | |

**ORDNANCE MAINTENANCE – ORDNANCE ENGINE
MODEL R975-C4 (CONTINENTAL)**

| F—Cont'd | Page No. | I | Page No. |
|---|-----------------|-------------------------------------|-----------------|
| Front bearing inner race and spacer, removal | 124 | Idler gears | |
| Fuel and drain lines | | installation | 162 |
| installation | 238–239 | removal | 141 |
| removal | 34 | replacement | 154 |
| Fuel induction tubes | | Ignition cables, installation | 189 |
| installation | 223 | Ignition harness | |
| removal | 50–52 | assembly | 189–190 |
| Fuel pump | | cleaning, inspection and | |
| fits and tolerances | 255–256 | repair | 188–189 |
| installation | 238 | disassembly | 188 |
| removal | 35 | installation | 208–209 |
| Fuel pump and mounting | | removal | 61–62 |
| assembly | 187 | test | 190 |
| cleaning, inspection and repair | 187 | Ignition system | |
| disassembly | 187 | data | 28 |
| Fuel system | | description | 20 |
| data | 28–29 | Impeller assembly | |
| description | 20–22 | fits and tolerances | 253–254 |
| | | installation | 161 |
| | | removal | 142 |
| | | Impeller bearing cage | |
| | | disassembly | 142–143 |
| | | installation | 158 |
| | | removal | 142 |
| | | Impeller drive gear assembly | |
| | | installation | 158–159 |
| | | replacement | 153–154 |
| | | Impeller drive gear and shaft, | |
| | | removal | 142 |
| | | Impeller drive gear shaft support, | |
| | | removal | 141 |
| | | Impeller oil seal cage, removal ... | 143 |
| | | Impeller shaft assembly, replace- | |
| | | ment | 153 |
| | | Inlet screen assembly, replacement | 175 |
| | | Inspection | |
| | | air deflectors | 192 |
| | | articulated rods and knuckle | |
| | | pins | 137–140 |
| | | cam hub and ring assembly .. | 95–97 |
| | | cowling | 192 |
| | | crankshaft | 125–130 |
| | | crankshaft gear assembly | 141 |
| | | cylinders | 107–114 |
| | | diffuser section | 144–154 |
| | | disassembly and assembly of | |
| | | subassemblies | 82 |
| | | engine supports | 192 |

G

| | |
|---------------------------------------|---------|
| Gears, installation | 175–176 |
| Gear spacer plate | |
| removal | 171–173 |
| replacement | 174 |
| Generator, removal | 41 |
| Generator drive gear support | |
| assembly | 181 |
| cleaning, inspection and repair | 181 |
| disassembly | 181 |
| installation | 194 |
| Generator idler gear, removal | 167 |
| Generator idler gear and shaft | |
| assembly | 180 |
| cleaning, inspection and repair | 180 |
| disassembly | 180 |
| installation | 194 |
| Generator support pad, removal | 41–42 |
| Governor | |
| adjustment | 248 |
| installation | 237 |
| removal | 42 |
| Governor drive gear | |
| installation | 177 |
| removal | 173 |
| Governor drive gear, intermediate, | |
| removal | 173 |

INDEX

| I—Cont'd | Page No. | | Page No. |
|--|----------|--|----------|
| Inspection—Cont'd | | Magneto conduits | |
| exhaust manifold collector | | installation | 190 |
| ring | 192-193 | removal | 188 |
| fan | 191 | Magneto distributor block cover, | |
| flywheel | 191 | removal | 41 |
| front crankcase section | 86-88 | Magneto elbows from ignition | |
| front main bearing support | 86-88 | cables, removal | 188 |
| fuel pump and mounting | 187 | Magneto shielding, removal | 36-39 |
| generator drive gear support | 181 | Main bearing, front | |
| generator idler gear and shaft | 180 | installation | 210-212 |
| ignition harness | 188-189 | test | 127-128 |
| main crankcase section | 89-96 | Main bearing, rear | |
| master rod | 125-130 | inspection | 90 |
| oil pump | 174-176 | replacement | 90-91 |
| pistons | 116 | Main bearing support, front | |
| piston pins | 117 | assembly | 88 |
| push rod assemblies | 107 | cleaning | 86 |
| rear crankcase section | 168-169 | disassembly | 86 |
| rear main bearing | 90 | fits and tolerances | 249 |
| rocker box assemblies | 105-107 | inspection and repair | 86-88 |
| separator pins | 191 | installation | 212 |
| separator springs | 191 | removal | 58 |
| starter gear and shaft | 179-180 | Main and front crankcase sections, | |
| sump assembly | 193 | assembly | 206-215 |
| tachometer drive assembly | 184-185 | Main crankcase section to rear . | |
| three-way accessory drive hous- | | section, installation | 208 |
| ing | 182 | Manifold ring, disconnection | 188 |
| valve operating mechanisms | 105-114 | Master rod | |
| valve tappets | 95 | assembly | 130-136 |
| valve tappet guides | 91-95 | cleaning | 125 |
| Intercylinder air deflectors, instal- | | disassembly | 119-125 |
| lation | 220-223 | fits and tolerances | 253 |
| Intercylinder baffle assemblies, | | inspection and repair | 125-130 |
| removal | 52 | installation | 206-207 |
| | | removal | 120-123 |
| | | replacement | 128-130 |
| | | Master rod spacer, removal | 123-124 |
| | | | |
| | | K | |
| Knuckle pins | | | |
| fits and tolerances | 253 | | |
| installation | 209-210 | | |
| replacement | 140 | | |
| | | | |
| | | L | |
| Lock at rear of impeller shaft, | | | |
| replacement | 162 | | |
| | | | |
| | | M | |
| Magnetos | | | |
| adjustment | 247 | | |
| installation | 229-230 | | |
| removal | 41 | | |
| | | | |
| | | O | |
| | | Oil drain tubes | |
| | | assembly | 113 |
| | | removal | 104 |
| | | Oil inlet strainer, removal | 173 |
| | | Oil pressure, adjustment | 247 |
| | | Oil pump | |
| | | assembly | 176-178 |
| | | cleaning | 173 |
| | | disassembly | 171-173 |
| | | fits and tolerances | 257-258 |
| | | inspection and repair | 174-176 |

**ORDNANCE MAINTENANCE – ORDNANCE ENGINE
MODEL R975-C4 (CONTINENTAL)**

| O—Cont'd | Page No. | | Page No. |
|-----------------------------------|-----------------|-------------------------------------|-----------------|
| Oil Pump—Cont'd | | removal | 65 |
| installation | 202-203 | Push rod sockets and springs, | |
| removal | 167 | removal | 50 |
| tests and adjustments | 178 | | |
| Oil pump drive gear, removal | 171 | | |
| Oil pump thermometer adapter, | | R | |
| removal | 173 | Rear crank, inspection and | |
| Oil rings, installation | 160-161 | test | 126-127 |
| Oil seal cage, installation | 156-157 | Relief valve assembly | |
| Oil standpipe, installation | 195 | installation | 178 |
| Oil standpipe seal, installation | 206 | removal | 173 |
| | | replacement | 175 |
| | | Repair | |
| P | | accessory drive housing, | |
| Pistons | | three-way | 182 |
| assembly | 117 | air deflectors | 192 |
| cleaning | 113-116 | cowling | 192 |
| disassembly | 113 | engine supports | 192 |
| fits and tolerances | 249-250 | exhaust manifold collector | |
| inspection and repair | 116 | ring | 192-193 |
| removal | 52-56 | flywheel and fan | 191 |
| Piston, No. 1, installation | 216-217 | fuel pump and mounting | 187 |
| Piston pins, inspection | 117 | generator drive gear support | 181 |
| Piston rings | | generator idler gear and shaft | 180 |
| installation | 117 | ignition harness | 188-189 |
| removal | 113 | starter gear and shaft | 179-180 |
| Pistons and cylinders, installa- | | sump assembly | 193 |
| tion | 219-220 | tachometer drive assembly | 184-185 |
| Pistons, piston pins and rings | | Rocker arm assemblies | |
| description | 12-13 | fits and tolerances | 250 |
| Pressure plate and flywheel ring, | | installation | 224-226 |
| installation | 243 | removal | 48 |
| Pressure pump body | | Rocker box assemblies, inspec- | |
| installation | 177-178 | tion | 105-107 |
| removal | 171 | Rocker box covers, removal | 48 |
| replacement | 174 | Rubber seals and spacers, installa- | |
| Pressure pump body and spacer | | tion | 198 |
| plate assembly, installation | 177 | | |
| Pressure pump drive shafts, | | S | |
| installation | 176 | Scavenger gears, installation | 176-177 |
| Primer system | | Scavenger pump body, replace- | |
| installation | 235-237 | ment | 174-175 |
| removal | 47 | Scavenger pump body cover | |
| Push rod assemblies | | installation | 178 |
| inspection | 107 | removal | 173 |
| installation | 224 | replacement | 176 |
| Push rods and housings, removal | 48-50 | Separator pins | |
| Push rod housings, installation | 223 | inspection | 191 |
| Push rod housing adapters | | installation | 239-243 |
| installation | 97 | removal | 190 |

INDEX

| S—Cont'd | Page No. | | Page No. |
|---|-----------------|---|-----------------|
| Separator pin springs, removal . . . | 190 | disassembly | 184 |
| Separator springs, inspection . . . | 191 | fits and tolerance | 257 |
| Separator springs on flywheel, in- stallation | 191 | installation | 203 |
| Slit brass cone, removal | 56 | removal | 166-167 |
| Strainer assembly, installation . . . | 178 | Tappet guides and rear bearing, main | 65 |
| Spacers and rubber seals, installa- tion | 198 | Tests and adjustments final adjustments | 24/-248 |
| Spark plug conduits, removal . . . | 186 | preliminary instructions | 246 |
| Spark plugs front installation | 223 | test procedure | 246-247 |
| removal | 46-47 | test schedule | 246 |
| rear, removal | 52 | Three-way accessory drive housing, installation | 205 |
| Spark plug terminal elbows, removal | 188 | Three-way accessory drive, and tachometer, removal | 167 |
| Spindle, installation | 243 | Throttle box installation | 238 |
| Starter installation | 230-233 | removal | 36 |
| removal | 40 | Thrust bearing, front, installation | 213 |
| Starter gear and shaft assembly | 180 | Thrust bearing retaining nut, removal | 56 |
| cleaning, inspection and repair | 179-180 | Thrust bearing spacer, installation | 212 |
| disassembly | 179 | Thrust nut, front, installation | 214-215 |
| fits and tolerances | 253 | | |
| removal | 65 | V | |
| Starter gear, installation | 200-202 | Valve operating mechanisms description | 13-14 |
| Starter shaft nut, removal | 52 | fits and tolerances | 250-251 |
| Starter shaft seal installation | 194 | installation | 215-229 |
| removal | 168 | Valves adjustment | 227-229 |
| Sump assembly cleaning, inspection and repair | 193 | assembly | 107-112 |
| installation | 233-235 | cleaning | 104-105 |
| removal | 46 | data | 27-28 |
| Sump drain pipe and fitting, removal | 64 | disassembly | 105-114 |
| Sump fitting, installation | 97 | fits and tolerances | 249-250 |
| | | inspection and repair | 105-114 |
| T | | installation | 113, 227-229 |
| Tachometer and three-way acces- sory drive installation | 203 | removal | 101-104 |
| removal | 167 | Valve springs, removal | 101 |
| Tachometer drive assembly assembly | 185-186 | Valve tappets inspection | 95 |
| cleaning, inspection and repair | 184-185 | installation | 97-99 |
| | | removal | 64-65 |
| | | replacement | 95 |
| | | Valve tappet guides inspection | 91-95 |
| | | replacement | 95 |

RAPD18FEB44-41M

