

~~ORIGINALLY~~
DEPARTMENT OF THE ARMY TECHNICAL MANUAL

TM 11-5820-202-10

DEPARTMENT OF THE AIR FORCE TECHNICAL ORDER

TO 31R2-2GRC26-151

OPERATOR'S MANUAL

RADIO SETS AN/GRC-26A AN/GRC-26B AND AN/GRC-26C



DEPARTMENTS OF THE ARMY AND THE AIR FORCE
JANUARY 1959

WARNING

Be careful when working on the 115-volt ac line connections. Serious injury or death may result from contact with these terminals.

DON'T TAKE CHANCES

EXTREMELY DANGEROUS VOLTAGE (2,500 VOLTS) EXISTS IN RADIO TRANSMITTER BC-610 (*)

When the transmitter is operating, keep away from all antenna connections and antenna tuning unit. Extremely high current radio-frequency energy exists at those points.

Do not add gasoline to the vehicle fuel tank or the fuel tank of the power unit while transmitting. Radio-frequency voltage on the chassis of the vehicle may cause a spark resulting in an explosion. Turn off the radio transmitter and the power unit and *keep them off* until refueling is finished. To prevent explosions caused by static electricity, *always* ground the fuel container to the fuel tank before pouring gasoline from container to tank. *Do not smoke* during refueling operations.

TECHNICAL MANUAL
No. 11-5820-202-10
TECHNICAL ORDER
No. 31R2-2GRC26-151

DEPARTMENTS OF THE ARMY
AND THE AIR FORCE

WASHINGTON 25, D.C., 7 January 1959

RADIO SETS AN/GRC-26A, AN/GRC-26B, AND AN/GRC-26C

	Paragraph	Page
CHAPTER 1. INTRODUCTION		
Section I. General.....	1, 2	3, 4
II. Description and data.....	3-16	4-17
CHAPTER 2. INSTALLATION		
Section I. Service upon receipt of equipment.....	17-21	18-22
II. Installation of antennas.....	22-25	22-33
III. Connections and installation.....	26, 27	33-39
CHAPTER 3. OPERATING INSTRUCTIONS		
Section I. Operator's controls, instruments, indicators, and jacks.....	28, 29	40-43
II. Starting procedures.....	30-32	44-47
III. Full duplex procedures.....	33-35	48-53
IV. One-way reversible procedures.....	36-38	53-56
V. Teletypewriter, reperforator, miscellaneous, and stopping procedures.....	39-43	56-62
VI. Operation under unusual conditions.....	44-47	62-63
CHAPTER 4. MAINTENANCE INSTRUCTIONS	48-52	64-72
5. SHIPMENT AND LIMITED STORAGE AND DEMOLITION TO PREVENT ENEMY USE		
Section I. Shipment and limited storage.....	53, 54	73
II. Demolition to prevent enemy use.....	55, 56	73
APPENDIX I. REFERENCES.....		74
II. OPERATOR'S REPAIR PARTS AND SPECIAL TOOLS LIST FOR RADIO SETS AN/ GRC-26, AN/GRC-26A, -26B, and -26C.....		77

*This manual supersedes so much of TM 11-264A/TO 31R2-2GRC26-11, 6 January 1953, including C 1, 19 May 1954; C 2, 27 September 1954; C 3, 27 October 1955; C 4, 1 March 1956; C 5, 26 April 1956; and C 6, 29 May 1958, as pertains to installation and operation instructions.

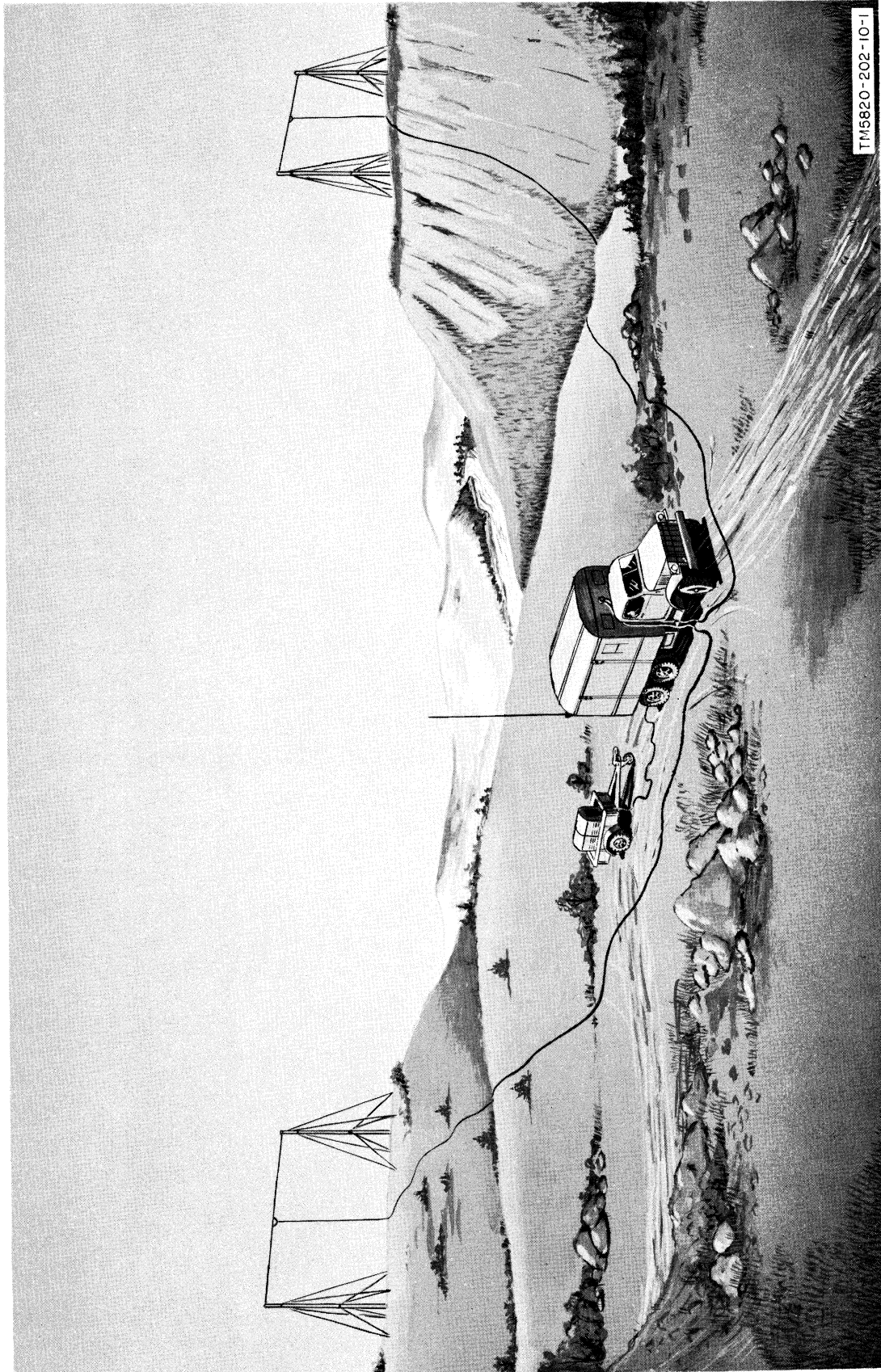

Figure 1. Radio Set AN/GRC-26(*).

Operator's Manual

RADIO SETS AN/GRC-26A, AN/GRC-26B, AN/GRC-26C

CHANGE }
No. 6 }8 Jan 70
W. H. SweeneyHEADQUARTERS
DEPARTMENT OF THE ARMY
WASHINGTON, D.C., 9 January 1964

TM 11-5820-202-10, 7 January 1959, is changed as follows:

Note. The parenthetical reference to previous changes (example: page 1 of C 4) indicates that pertinent material was published in that change.

Page 4, paragraph 2 (as changed by C 5, 29 Mar 63).

2. Index of Publications

Refer to the latest issue of DA Pam 310-4 to determine whether there are new editions, changes, or additional publications pertaining to this equipment. DA Pam 310-4 is an index of current technical manuals, technical bulletins, supply bulletins, lubrication orders, and modification work orders that are available through publications supply channels. The index lists the individual parts (-10, -20, -35P, etc) and the latest changes to and revisions of each equipment publication.

Paragraph 2.1 (as added by C 5, 29 Mar 63). Delete subparagraph *c* and substitute:

2.1. Forms and Records

a. Reports of Maintenance and Unsatisfactory Equipment. Use equipment forms and records in accordance with instructions in TM 38-750.

b. Report of Damaged or Improper Shipment. Fill out and forward DD Form 6 (Report of Damaged or Improper Shipment) as prescribed in AR 700-58 (Army), NAVSANDA Publication 378 (Navy), and AFR 71-4 (Air Force).

c. Reporting of Equipment Manual Improvements. The direct reporting, by the individual

user, of errors, omissions, and recommendations for improving this manual, is authorized and encouraged. DA Form 2028 (Recommended Changes to DA Technical Manual Parts Lists or Supply Manuals 7, 8, or 9) will be used for reporting these improvements. This form will be completed in triplicate using pencil, pen or typewriter. The original and one copy will be forwarded direct to Commanding Officer, U.S. Army Electronic Materiel Support Agency, ATTN: SELMS-MP, Fort Monmouth, N.J. 07703. One information copy will be furnished to the individual's immediate supervisor (officer, noncommissioned officer, supervisor, etc).

Page 64, paragraph 48 (as changed by C 5, 29 Mar 63).

b. Operator's maintenance for the items listed in *a* above consists of the following:

- (1) Preventive maintenance (par. 49).
- (2) Daily maintenance service and inspection (par. 50.1).
- (3) Weekly maintenance service and inspection (par. 50.2).
- (4) Cleaning (par. 50.3).
- (5) System troubleshooting (par. 51).
- (6) Replacement of defective fuses (par. 52*a*).
- (7) Replacement of parts (par. 52*b* and *c*).

49. Preventive Maintenance

(as changed by C 5, 29 Mar 63)

Preventive maintenance is the systematic care, servicing, and inspection of equipment to

* This change supersedes C 5, 29 March 1963.

prevent the occurrence of trouble, to reduce downtime, and to assure that the equipment is serviceable.

a. Systematic Care. The procedures given in paragraphs 48 through 52 cover systematic care essential to proper upkeep and operation of the equipment. The cleaning operations (par. 50.3) should be performed once a day. If the equipment is not used daily, however, the cleaning operations must be performed before operation of the equipment after any extended shutdown, or once a week while the equipment is kept in standby condition. The other items must be checked before the equipment is placed in operation after a shutdown, during operation, or after it is turned off, as specified in the applicable paragraph.

b. Maintenance Service and Inspection. The maintenance service and inspection charts (par. 50.1 and 50.2) outline inspections to be made at specific intervals. These inspections are made to determine that the equipment is in good general (physical) condition, in good operating condition, and likely to remain combat serviceable. To assist operators in maintaining combat serviceability, the charts indicate what to inspect, how to inspect, and what the normal conditions are; the *references* column lists the paragraph that contains additional information. If the defect cannot be remedied by the operator, higher echelon maintenance or repair is required. Records and reports of these inspections must be made in accordance with TM 38-750.

50. Maintenance Service and Inspection Periods

(as changed by C 5, 29 Mar 63)

Maintenance service and inspections of the AN/GRC-26A, -26B, and -26C, are required on a daily and weekly basis.

a. Paragraph 50.1 specifies services and inspections that must be accomplished daily and under special conditions listed below.

(1) *In vehicular installations.*

- (a) Before the vehicle starts on a mission.
- (b) When the equipment is initially installed.
- (c) When the equipment is reinstalled after removal for any reason.
- (d) At least once a week if the equipment is maintained in standby condition.

(2) *In transportable and mobile installations.*

- (a) When the equipment is initially installed.
- (b) When the equipment is reinstalled after removal for any reason.
- (c) At least once a week if the equipment is maintained in standby condition.

b. Paragraph 50.2 specifies maintenance services and inspections that must be performed once each week. If the equipment is being maintained in a standby condition, the daily (par. 50.1) and weekly (par. 50.2) services and inspections should be accomplished at the same time.

50.1. Daily Maintenance Service and Inspection Chart

(As added by C 5, 29 Mar 63)

No. Item	Procedure		References
	Item	Normal condition or result	
1	COMPLETENESS: Inspect for completeness.	Equipment must be complete (app. II).	App. II.
3	CLEANLINESS: Inspect for cleanliness.	Shelter, power unit, antenna system in use, and items within the shelter should be clean and free from grease, dirt, rust, corrosion, and fungus.	Par. 50.3.
7	HARDWARE AND MOUNTING: Inspect for broken, missing, or loose catches, latches, hinges, handles, breakage or other damage.	All bolts, nuts, and washers are present and properly tightened. Mountings show no evidence of weakness or deformity. Catches, latches, hinges, and handles are not missing or damaged.	

No. Item	Procedure		References
	Item	Normal condition or result	
8	CORDS AND CABLES: Inspect for cuts, cracked or gouged jackets, fraying, bad bruises or kinks.	Items are free from cuts, cracked or gouged jackets, fraying, bad bruises, or kinks.	TM 11-904. Par. 51.
9	PLUGS AND RECEPTACLES: Inspect for breakage and firm seating.	Items are firmly seated and in good physical condition.	
10	ANTENNA MASTS AND GUY LINES: Inspect antenna masts to see if they are straight and vertical. Check guy lines to see that they are secure and taut.	Mast sections are straight and vertical. Guy wires are properly secure and taut.	
11	METERS: Inspect meters for broken glass.	Meter window glass should be free from cracks and broken glass.	
29	POWER UNIT: Check the electrical power unit for proper operation.	Refer to TM 11-904.	
30	OPERATIONAL CHECK: During operation be alert for unusual operation or condition.	Equipment should operate properly.	

50.2. Weekly Maintenance Service and Inspection Chart

(As added by C 5, 29 Mar 63)

Item No.	Procedure		References
	Item	Normal condition or result	
4	PRESERVATION: Inspect for preservation.	Painted surfaces must be free of bare spots, rust, and corrosion.	Par. 27d(1).
12	CASES, RACKS AND MOUNTS: Check for tightness and security.	Items are physically secure without missing hardware.	
13	ACCESSIBLE ITEMS: Inspect switches, knobs, jacks, connectors, motors, blowers, etc, for looseness.	Items are physically secure and without missing hardware.	
14	AIR FILTERS: Inspect for cleanliness.	Air filters should be free from excessive dirt and dust.	
15	BATTERIES: Inspect batteries in the power unit for dirt, specific gravity, and damaged cases.	Items should be clean and without damaged cases. Specific gravity should indicate a charged battery.	
16	SHELTER: Inspect for weather-proofing.	Shelter door gaskets should be complete and in good condition. All other seals and gaskets should exclude water.	

50.3. Cleaning

(as added by C 5, 29 Mar 63)

Inspect the exteriors of the units within the shelter. The exterior surfaces should be clean, free of dust, dirt, grease, and fungus.

a. Remove dust and loose dirt with a clean soft cloth.

Warning: Cleaning compound is flammable and its fumes are toxic. Provide adequate ventilation. Do not use near a flame.

b. Remove grease, fungus, and ground-in dirt from the cases; use a cloth dampened (not wet) with cleaning compound.

c. Remove dust or dirt from plugs and jacks with a brush.

Caution: Do not press on the meter faces (glass) when cleaning; the meter may become damaged.

d. Clean the front panels, meters, and control knobs; use a soft clean cloth. If dirt is difficult to remove, dampen the cloth with water and mild soap.

Page 65 (as deleted by C 5, 29 Mar 63). Delete figure 31.

Page 66 (as deleted by C 5, 29 Mar 63). Delete figure 32.

Page 74, appendix I (as changed by C 5, 29 Mar 63). Delete and substitute:

APPENDIX I

REFERENCES

Following is a list of applicable references that are available to the operator of Radio Set AN/GRC-26(*) :

- DA Pam 310-4 Index of Technical Manuals, Technical Bulletins, Supply Manuals (types 4, 6, 7, 8, and 9) Supply Bulletins, Lubrication Orders, and Modification Work Orders.
- SB 11-254 Utilization of Test Prod, FSN 6625-510-1841 With Equipment T-268()/URT, BC-610(), AM-141()/MRC, AM-494()/GR and AN-495()/GR.
- SB 11-203 Supply of Telephone Sets TA-312/PT, TA-43/PT and EE-8.
- SB 11-462 Generator Set for AN/GRC-26, -A, -B, -C, -D, and AN/GRC-41.
- TM 9-213 Painting Instructions for Field Use.
- TM 11-257 Frequency Shift Exciters O-39/TRA-7, O-39A/TRA-7, O-39B/TRA-7, and O-39C/TRA-7.
- TM 11-262 Control Units C-292/TRA-7, C-292A/TRA-7, and C-292B/TRA-7.
- TM 11-333 Telephone EE-8, EE-8-A, and EE-8-B.
- TM 11-486-6 Electrical Communication Systems Engineering Radio.
- TM 11-826 Radio Transmitters BC-610-E, -F, -G, -H, -I, and Radio Transmitter T-213/GRC-26 and Antenna Tuning Units BC-939-A and -B.
- TM 11-854 Radio Receiver R-388/URR.
- TM 11-809-10 Operator's Manual: Radio Transmitters T-368/URT, T-368A/URT, T-368B/URT, T-368C/URT, T-368D/URT, and T-368E/URT, Antenna, Tuning Unit BC-939B; Radio Rrequency Tuner TN-339/GR; and Standing Wave Ratio-Power Meter ME-165/G.
- TM 11-904 Power Units PE-95-A, -B, -C, -F, -G, -H, -I, and -K.
- TM 11-957 Rectifier RA-87.
- TM 11-957A Rectifier RA-87-A.
- TM 11-2222 Transmission Distributors TT-26/FG and TT-52/FG, Receiving Transmitter Distributors TT-12/FGQ-1, TT-13/FGQ-1, TT-21/FG, TT-21A/FG, and TT-25/FG, and Teletype Model 14 Transmitter Distributors XD82, XD99, XD221 and XD223.
- TM 11-2223 Typing and Nontyping Reperforators, Teletype Model 14.
- TM 11-2225 Teletypewriter Sets AN/GGC-3, AN/GGC-3A and Teletypewriter Reperforator-Transmitters TT-76/GGC, TT-76A/GGC, and TT-76B/GGC.
- TM 11-2234 Teletypewriter Sets AN/PGC-1 and AN/TGC-7A, and Teletypewriters TT-4_TG, TT-4/TG, and TT-173A/TG (superseded by TM 11-5815-206-12).
- TM 11-5062 Frequency Shift Converters CV-182/GRC-26A, CV-182A/GRC-26A, and CV-182B/GRC-26A and Power Supplies PP-712/GRC-26A and PP-712A/GRC-26A.
- TM 11-5054 Speech Amplifier BC-614-E, -F, -H, and -I.
- TM 11-5805-200-12P Operator's and Organizational Maintenance Repair Parts and Special Tools List and Maintenance Allocatoin Chart for Telephone EE-8, -8A, -8B, -8C, -8D, and -8E.

- TM 11-5805-272-12P Operator's and Organizational Maintenance Repair Parts and Special Tools List and Maintenance Allocation Chart for Generators GN-38, -38A, and -38B.
- TM 11-5815-206-12 Operator and Organizational Maintenance Manual: Teletypewriter Set AN/PGC-1, and Telewriters TT-4A/TG, TT-4B/TG, TT-4C/TG and TT-335/TG.
- TM 11-5820-202-20 Radio Sets AN/GRC-26A, AN/GRC-26B and AN/GRC-26C, Organizational Maintenance, Second Echelon.
- TM 11-5820-216-10P Operator's Maintenance Repair Parts and Special Tools List: Frequency Shift Converters CV-182/GRC-26A, CV-182A/GRC-26A, and CV-182B/GRC-26A.
- TM 11-5820-217-10P Operator's Maintenance Repair Parts and Special Tools List: Power Supplies PP-712/GRC-26A and PP-712A/GRC-26A.
- TM 11-5820-230-12P Operator and Organizational Maintenance Repair Parts and Special Tools List and Maintenance Allocation Chart: Radio Set Control Group AN/GRA-14.
- TM 11-5820-251-10P Basic Issue Items List: Mast AB-155/U, AB-155A/U, and AB-155B/U.
- TM 11-5820-257-12P Operator and Organizational Maintenance Repair Parts and Special Tools List and Maintenance Allocation Chart: Antenna Tuning Unit BC-939-A, -939-B and Tuner, Radio Frequency TN-339/GR.
- TM 11-5820-479-12P Operator and Organizational Maintenance Repair Parts and Special Tools List and Maintenance Allocation Chart: Mast Base MP-65, MP-65A and MP-65B.
- TM 11-5965-216-15P Operator, Organization, Field and Depot Maintenance Repair Parts and Special Tools List and Maintenance Allocation Chart: Handset TS-9-F.
- TM 11-5965-218-15P Operator, Organizational, Field and Depot Maintenance Repair Parts and Special Tools List and Maintenance Allocation Chart: Microphone T-50 and Microphone, Dynamic M-105/U.
- TM 11-5965-230-12P Operator's and Organizational Maintenance Repair Parts and Special Tools List and Maintenance Allocation Chart for Headsets HS-30-A, HS-30-B, HS-30-C, HS-30-D, HS-30-E, HS-30-F, HS-30-G, HS-30-H, HS-30-J, HS-30-K, HS-30-L, HS-30-R and HS-30-U.
- TM 11-6115-202-10P Basic Issue Items List: Generator Set, Gasoline Engine PU-286/G and Power Unit PE-197.
- TM 11-6115-223-15P Operator, Organizational, Field and Depot Maintenance Repair Parts and Special Tools List and Maintenance Allocation Chart for Generator Set, Gasoline Engine Trailer Mounted PU-294/G.
- TM 38-750 The Army Equipment Record System and Procedures.

Page 77, appendix II, section II. Add the following item in the columns indicated below:

Page	2	1	2	3	4	5	4	6	7
5 of C 4	2540-892-6243	†	†	†	†	†	LADDER, VEHICLE, BOARDING MX-3391/G <i>Note.</i> This item added as a safety measure.	NX	1
7 of C 4	5815-553-6061	†	†	†	†	†	TELETYPEWRITER TT-76A/GGC, TT-76B/GGC: MIL-R-11177.	NX	1

(Page 6 of C 4, column 5, "REPERFORATOR-TRANSMITTER". Delete item in its entirety.

By Order of the Secretary of the Army:

EARLE G. WHEELER,
General, United States Army,
Chief of Staff.

Official:

J. C. LAMBERT,
Major General, United States Army,
The Adjutant General.

Distribution:

Active Army:

USASA (2)	Ft Gordon (5)
CNGB (1)	Ft Huachuca (10)
CSigO (7)	GENDEP (OS) (2)
CofT (1)	Sig Dep (OS) (12)
CofEngrs (1)	Sig Sec, GENDEP (5)
TSG (1)	Army Dep (2) except
CofSptS (1)	Lexington (12)
USAAESWBD (5)	Sacramento (28)
USAECDA (1)	Tobyhanna (12)
USACBRCDA (1)	Ft Worth (8)
USACECDA (1)	Svc Colleges (2)
USACECDA, Ft Monmouth (1)	Br Svc Sch (10)
USAMSCDA (1)	WRAMC (2)
USAOCD (2)	USA Tml Comd (1) except
USAQMCDA (1)	Pacific (5)
USATCDA (1)	Army Tml (1)
USAADCDA (1)	POE (1)
USAARMCDA (1)	AMS (1)
USAAVNCDA (1)	USASA Fld Sta (5)
USAARTYCDA (1)	USA Elct Mat Agcy (9)
USASWCDA (2)	JCA (5)
USAMC (5)	Army Pic Cen (2)
USASMCOM (1)	USA Mbl Spt Cen (1)
USCONARC (5)	USAPRDC (5)
ARADCOM (2)	Chicago Proc Dist (1)
ARADCOM Rgn (2)	Rock Island Arsenal (5)
OS Maj Comd (3)	Sig Fld Maint Shops (3)
OS Base Comd (2)	USA Elct RD Actv, White Sands (13)
LOGCOMD (2)	USAERDL Trp Comd (10)
USAECOM (7)	Yuma PG (2)
USAMICOM (4)	WSMR (5)
USASCC (4)	USA Corps (3)
MDW (1)	JUSMAG, Iran (5)
Armies (2)	GENMISH (5)
Corps (2)	KMAG (5)
Div (2)	Units organized under following TOE.
1st GM Bde (5)	(2 copies each UNOINDC)
USASA Co (5)	7-52
USASA Gp (5)	9-12
USASA Bn (5)	9-22
USATC FA (2)	9-86
USATC AD (2)	11-5
USATC Armor (3)	11-15
USATC Engr (2)	11-16
USATC Inf (3)	11-18
USASTC (100)	11-32
Instl (2) except	11-37
Ft Monmouth (63)	11-38
Ft Hancock (4)	11-39

11-55	17-51
11-57	17-55
11-85	20-45
11-87	20-46
11-95	30-25
11-97	30-29
11-98	30-500 (AA-AE)
11-99	32-52
11-117	32-56
11-237	32-57
11-157	32-67
11-500 (AA-AE) (4)	32-68
11-557	39-51
11-587	39-401
11-592	44-12
11-597	

NG: State AG (3) ; units same as active Army except allowance is one (1) copy to each unit.

USAR: None.

For explanation of abbreviations used, see AR 320-50.

☆ U. S. GOVERNMENT PRINTING OFFICE: 1964-700507



OBSELETE

**RADIO SETS AN/GRC-26A, AN/GRC-26B, AN/GRC-26C
ORGANIZATIONAL MAINTENANCE**

SECOND ECHELON

TM 11-5820-202-20
TO 31R2-2GRC26-152
CHANGES No. 2

*3 Jan 70
W. H. Sullivan*

DEPARTMENTS OF THE ARMY
AND THE AIR FORCE
WASHINGTON 25, D.C., 29 March 1963

TM 11-5820-202-20/TO 31R2-2GRC26-152, 24 December 1958, is changed as follows:

Page 2. Delete paragraph 1 and substitute:

1. Scope

a. This manual contains instructions covering second echelon maintenance of Radio Sets AN/GRC-26A, AN/GRC-26B, and AN/GRC-26C. It includes instructions for performing preventive and periodic maintenance services, general theory, and repair functions to be accomplished by the organizational repairman. Operating instructions are given in TM 11-5820-202-10.

b. Second echelon maintenance of Radio Sets AN/GRC-26A, AN/GRC-26B, and AN/GRC-26C includes:

- (1) Replacement of defective fuses (TM 11-5820-202-10).
- (2) Preventive maintenance (par. 4).
- (3) Monthly maintenance service and inspection (par. 4.2).
- (4) Cleaning and touchup painting instructions (par. 4.3).
- (5) Lubrication (par. 5).
- (6) Troubleshooting (par. 7).
- (7) Replacement of defective tubes (par. 8).
- (8) Replacement of relays (par. 11), lenses, lamps, cords, connector adapters, mast plate (TM 11-5820-202-10), and the air heater.
- (9) Voltage and resistance measurements (par. 9 and 10).

c. Refer to the latest issue of DA PAM 310-4 to determine whether there are new editions, changes or additional publications pertaining to the equipment. Department of the Army Pamphlet No. 310-4 is a current index of technical manuals, technical bulletins, supply bulletins, lubrication orders, and modification work orders that are available through publications supply channels.

The index lists the individual parts (-10, -20, -35P, etc.) and the latest changes and revisions of each equipment publication.

d. Forward all comments on this publication direct to: Commanding Officer, U. S. Army Electronics Materiel Support Agency, ATTN: SELMS-MP, Fort Monmouth, N.J. (DA Form 1598 (Record of Comments on Publications), DA Form 2496 (Disposition Form), or letter may be used.)

Note. For applicable forms and records, see paragraph 2.1, TM 11-5820-202-10.

Delete paragraph 4 and substitute new paragraph 4 and paragraphs 4.1 through 4.3.

4. Preventive Maintenance

a. Preventive maintenance is the systematic care, inspection, and servicing of equipment to maintain it in serviceable condition, prevent breakdowns, and assure maximum operational capability. Preventive maintenance is the responsibility of all echelons concerned with the equipment and includes the inspection, testing, and repair or replacement of parts, subassemblies, or units that inspection and tests indicate would probably fail before the next scheduled periodic service. Preventive maintenance service and inspections of Radio Sets AN/GRC-26A, AN/GRC-26B, and AN/GRC-26C at the second echelon level are made at monthly intervals unless otherwise directed by the commanding officer. The maintenance services should be scheduled concurrently with the periodic service schedule of the carrying vehicle for all vehicular installations.

b. Maintenance forms and records to be used and maintained on this equipment are specified in TM 38-750. Paragraph 2.1, TM 11-5820-202-10, contains additional information concerning submission of specific forms.

4.1. Monthly Maintenance

a. Perform the maintenance functions in the monthly maintenance and inspection chart (par. 4.2) once each month. A month is defined as approximately 30 calendar days of 8-hour-per-day operation. If the equipment is operated 16 hours a day, the monthly maintenance should be performed at 15-day intervals. Adjustment of the maintenance interval must be made to compensate for any unusual operating conditions. Equipment maintained in a standby (ready for immediate operation) condition, must have monthly maintenance performed on it. Equipment in limited storage (requires service before operation) does not require monthly maintenance.

b. Monthly maintenance will be scheduled in accordance with the requirements of TM 38-750.

If the equipment is part of a vehicular installation, the monthly maintenance should be scheduled concurrently with the periodic service schedule of the carrying vehicle to reduce out-of-service time to a minimum. All deficiencies or shortcomings will be recorded, and those not corrected during the inspection and service will be immediately reported to higher echelon by use of forms and procedures specified by TM 38-750. Equipment that has a deficiency that cannot be corrected by second echelon should be deadlined in accordance with TM 38-750. Perform all the services listed in the monthly maintenance and inspection chart (par. 4.2) in the sequence listed. Whenever a *normal condition or result* is not observed, take corrective action in accordance with the paragraph listed in the *References* column.

4.2. Monthly Maintenance Service and Inspection Chart

Item No.	Procedure		References
	Item	Normal condition or result	
1	COMPLETENESS: Inspect for completeness.	Equipment must be complete (app. II, TM 11-5820-202-10).	
2	PROPER INSTALLATION: Inspect for proper installation.	Installation is in accordance with paragraph 25, TM 11-5820-202-10.	
3	CLEANLINESS: Inspect for cleanliness-----	Shelter, power unit, antenna system in use, and items within the shelter should be clean and free from grease, dirt, rust, corrosion and fungus.	Par. 50.3, TM 11-5820-202-10.
4	PRESERVATION: Inspect for preservation..	Painted surfaces must be free of bare spots, rust, and corrosion.	Par. 4.3.
5	PUBLICATIONS: Check to see that pertinent publications are available (app. I).	a. Operator's manual must be complete and in usable condition without missing pages. b. All Changes pertinent to the equipment are on hand (DA Pam 310-4). c. Organizational maintenance manual is complete and in usable condition.	a. None. b. DA Pam 310-4 for requirements. c. None.
6	MODIFICATION WORK ORDERS: Check DA Pam 310-4 to determine if new applicable MWO's have been published.	All URGENT MWO's have been applied to the equipment. All ROUTINE MWO's have been scheduled.	DA Pam 310-4.
7	HARDWARE: Inspect for broken, missing, or loose catches, latches, handles, hinges, breakage, or other damage.	All bolts, nuts, and washers are present and properly tightened. Mountings show no evidence of weakness or deformity. Catches, latches, hinges, and handles are not missing or damaged.	
8	CORDS AND CABLES: Inspect for cuts, cracked or gouged jackets, fraying, bad bruises, or kinks.	Items are free from cuts, cracked or gouged jackets, fraying, bad bruises or kinks.	
9	PLUGS AND RECEPTACLES: Inspect for breakage and firm seating.	Items are firmly seated and in good physical condition.	
10	ANTENNA MASTS AND GUY LINES: Inspect antenna masts to see if they are straight and vertical. Check guy lines to see that they are secure and taut.	Most sections are straight and vertical. Guy wires are properly secure and taut.	Par. 24, TM 11-5820-202-10.
11	METERS: Inspect meters for broken glass...	Meter window glass should be free from cracks and broken glass.	

4.2. Monthly Maintenance Service and Inspection Chart—Continued

Item No.	Procedure		References
	Item	Normal condition or result	
12	CASES, RACKS, AND MOUNTS: Check for tightness and security.	Items are physically secure without missing hardware.	Par. 27, TM 11-5820-202-10.
13	ACCESSIBLE ITEMS: Inspect knobs, jacks, motors, blowers, etc, for looseness.	Items are physically secure and without missing hardware.	
14	AIR FILTERS: Inspect for cleanliness-----	Air filters should be free of excessive dirt and dust (par. 5f).	
15	BATTERIES: Inspect batteries in the power unit for dirt, specific gravity, and damaged cases.	Items should be clean and without damaged cases. Specific gravity should indicate a charged battery.	
16	SHELTER: Inspect for weatherproofing-----	Shelter door gaskets should be complete and in good condition. All other seals and gaskets should exclude water.	
17	PLUCKOUT ITEMS: Inspect the seating of all pluckout items: tubes, lamps, fuses, crystals, connectors, plug-in coils, and tuning units.	All items should be properly seated and clamps properly positioned.	
18	RELAYS AND CIRCUIT BREAKERS: Inspect for loose mountings, bad contacts, and misalignment of contacts.	Items should be securely mounted. Contacts should be properly aligned and free from pitting.	
19	VARIABLE CAPACITORS: Inspect for dirt, moisture, and loose mountings.	Item should be securely mounted and free of dirt and moisture.	
20	RESISTORS: Inspect for cracks, blistering, moisture, or discoloration.	Items should be securely mounted and free from cracks, blistering, moisture, or discoloration.	
21	TERMINAL BLOCKS: Inspect for looseness, cracks, and breaks.	Items should be securely mounted and in good physical condition.	
22	CAPACITORS: Inspect large capacitors for oil or electrolyte leakage, dirt, and insecure mountings.	Items should show no evidence of leakage, dirt, or loose mountings.	TM 11-904.
23	TRANSFORMERS, CHOKES, AND POTENTIOMETERS: Inspect for overheating.	Items should show no evidence of overheating.	
24	GENERATOR: Inspect the power unit generator for worn or loose brushes.	Brushes should be properly seated and not excessively worn.	
25	ANTENNA: Inspect the antenna group in use for damaged insulators.	Antenna insulators should be free from cracks and any other signs of damage.	Par. 5 and fig. 4 and 5.
26	LUBRICATION: Check the lubrication of the equipment (par. 5 and fig. 4 and 5).	Mechanisms should not show signs of overlubrication or underlubrication.	
27	FUSES: Check for proper fuses-----	Refer to paragraph 27a(3), TM 11-5820-202-10.	TM 11-904.
28	CHASSIS: CAPACITORS AND SWITCHES: Inspect for loose connections and mountings, cracks, overheating, and for any other abnormal signs of wear.	Items should not show signs of overheating, cracks, or abnormal wear.	
29	POWER UNIT: Check the electrical power unit for proper operation.	Refer to TM 11-904-----	
30	OPERATIONAL CHECK: Refer to Paragraph 7.	Refer to paragraph 7.	App. II, TM 11-5820-202-10.
31	SPARE PARTS: Check all spare parts for general condition and method of storage.	All spare parts must be in good condition and properly stored. There should be no evidence of overstock, and all shortages will be on valid requisitions.	

4.3. Cleaning and Touchup Painting Instructions

Remove rust and corrosion from metal surfaces by lightly sanding them with fine sandpaper. Brush two thin coats of paint on the bare metal to protect it from further corrosion. Refer to applicable

cleaning and refinishing practices specified in TM 9-213

Page 4. Delete figure 2.

Page 5. Delete figure 3.

Page 36, appendix I (page 1 of C1). Delete appendix I in its entirety and substitute:

APPENDIX I REFERENCES

Following is a list of applicable references available to the organizational maintenance man of Radio Set AN/GRC-26(*):

DA Pam 310-4	Index of Technical Manuals, Technical Bulletins, Supply Bulletins, Lubrication Orders and Modification Work Orders.
SB 38-100	Preservation, Packaging and Packing Materials, Supplies, and Equipment Used in the Army.
TB 11-6625-274-12/1	Test Data for Electron Tube Test Sets TV-7/U, TV-7A/U, TV-7B/U, and TV-7D/U.
TM 9-213	Painting Instructions for Field Use.
TM 11-257	Frequency Shift Exciters 0-39/TRA-7, 0-39A/TRA-7, 0-39B/TRA-7, and 0-39C TRA-7.
TM 11-261	Dual Diversity Converters CV-31/TRA-7, CV-31A/TRA-7, CV-31B/TRA-7, CV-31C/TRA-7, and CV-31D/TRA-7.
TM 11-333	Telephones EE-8, EE-8-A, and EE-8-B.
TM 11-826	Radio Transmitter, BC-610-E, -F, -G, and -I, and Radio Transmitter T-213/GRC-26, and Antenna Tuning Unit BC-939-A and -B.
TM 11-854	Radio Receiver R-388/URR.
TM 11-904	Power Units PE-95-A, -B, -C, -F, -G, -H, -I, and -K.
TM 11-957	Rectifier RA-87.
TM 11-957A	Rectifier RA-87-A.
TM 11-2222	Transmitter Distributors TT-26/FG and TT-52/FG, Receiving Transmitter Distributors TT-12/FGQ-1, TT-13/FGQ-1, TT-21/FG, TT-21A/FG, TT-25/FG, and Teletype Model 14 Transmitter Distributors XD82, XD99, XD221, and XD223.
TM 11-2223	Typing and Nontyping Reperforators, Teletype Model 14.
TM 11-2225	Teletypewriter Sets AN/GGC-3 and AN/GGC-3A, and Teletypewriter Reperforator-Transmitters TT-76/GGC, and TT-76A/GGC, and TT-76B/GGC.
TM 11-5062	Frequency Shift Converters CV-182/GRC-26A, CV-182A/GRC-26A, and CV-182B/GRC-26A, and Power Supplies PP-712/GRC-26A and PP-712A/GRC-26A.
TM 11-5815-206-12	Operator and Organizational Maintenance Manual: Teletypewriter Set AN/PGC-1 and Teletypewriters TT-4A/TG, TT-4B/TG, TT-4C/TG, and TT-335/TG.
TM 11-5820-202-10	Radio Set AN/GRC-26A, AN/GRC-26B, and AN/GRC-26C, Operator's Manual.
TM 11-5820-216-20P	Organizational Maintenance Repair Parts and Special Tools List and Maintenance Allocation Chart: Frequency Shift Converters CV-182/GRC-26A, CV-182A/GRC-26A and CB-182B/GRC-26A.
TM 11-5820-217-20P	Organizational Maintenance Repair Parts and Special Tools List and Maintenance Allocation Chart: Power Supplies PP-712/GRC-26 and PP-712A/GRC-26A.

- TM 11-5820-230-12P Operator and Organizational Maintenance Repair Parts and Special Tools List and Maintenance Allocation Chart: Radio Set Control Group AN/GRA-14.
- TM 11-5820-251-20P Organizational Maintenance Repair Parts and Special Tools List and Maintenance Allocation Chart: Mast AB-155/U, AB-155A/U and AB-155B/U.
- TM 11-5820-257-12P Operator and Organizational Maintenance Repair Parts and Special Tools List and Maintenance Allocation Chart: Antenna Tuning Unit BC-939-A, BC-939-B, and Tuner, Radio Frequency TN-339/GR.
- TM 11-5820-431-15P Operator, Organizational, Field and Depot Maintenance Repair Parts and Special Tools List and Maintenance Allocation Chart: Control Boxes C-345/MRC-2 and C-345A/MRC-2.
- TM 11-5820-479-12P Operator and Organizational Maintenance Repair Parts and Special Tools List and Maintenance Allocation Chart: Mast Base MP-65, MP-65A, and MP-65B.
- TM 11-5965-230-12P Operator and Organizational Maintenance Repair Parts and Special Tools List and Maintenance Allocation Chart for Headsets HS-30-A, HS-30-B, HS-30-C, HS-30-D, HS-30-E, HS-30-F, HS-30-G, HS-30-H, HS-30-J, HS-30-K, HS-30-L, HS-30-R, and HS-30-U.
- TM 11-6115-202-20P Organizational Maintenance Repair Parts and Special Tools List and Maintenance Allocation Chart: Generator Set, Gasoline Engine PU-286/G and Power Unit PE-197.
- TM 11-6115-223-15P Operator, Organizational, Field and Depot Maintenance Repair Parts and Special Tools List and Maintenance Allocation Chart for Generator Set, Gasoline Engine, Trailer Mounted PU-294/G.
- TM 11-6625-235-12P Operator and Organizational Maintenance Repair Parts and Special Tools List and Maintenance Allocation Chart for Rectifier Power Unit RA-133, RA-133-A, and RA-133-B.
- TM 11-6625-274-12 Operator's and Organizational Maintenance Manual: Test Sets TV-7/U, TV-7A/U, TV-7B/U, and TV-7D/U.
- TM 38-750 The Army Equipment Record System and Procedures.

By Order of the Secretaries of the Army and the Air Force:

EARLE G. WHEELER,
General, United States Army,
Chief of Staff.

Official:

J. C. LAMBERT,
Major General, United States Army,
The Adjutant General.

Official:

R. J. PUGH,
Colonel, United States Air Force,
Director of Administrative Services.

CURTIS E. LEMAY,
Chief of Staff, United States Air Force.

Distribution:

Active Army:

DASA (6)	Sig Sec, GENDEP (OS) (5)	11-39
USASA (2)	USA Elct RD Actv (Ft Huachuca)	11-55
CNGB (1)	(2)	11-57
CofEngrs (1)	USA Elct RD Actv (White Sands)	11-85
TSG (1)	(13)	11-87
CSigO (7)	WRAMC (1)	11-95
CofT (1)	Army Pic Cen (2)	11-98
USA CD Agcy (1)	USA Mbl Spt Cen (1)	11-99
USCONARC (5)	USA Trans Tml Comd (1)	11-117
USAMC (5)	Army Tml (1)	11-155
USAECOM (5)	POE (1)	11-157
USAMICOM (4)	USAOSA (1)	11-237
ARADCOM (2)	AFIP (1)	11-500 (Tms AA-AC) (4)
ARADCOM Rgn (2)	AMS (1)	11-557
OS Maj Comd (3)	USA Elet Mat Agcy (25)	11-587
OS Base Comd (2)	Chicago Proc Dist (1)	11-592
LOGCOMD (2)	USASSC (4)	11-597
MDW (1)	USARCARIB Sig Agcy (1)	17
Armies (2)	Sig Fld Maint Shops (3)	17-51
Corps (2)	JBUSMC (2)	17-55
USA Corps (3)	Units org under fol TOE's: (2 cy ea	20-45
Instl (2) except	UNOINDC)	20-46
Ft Monmouth (63)	7	29-56
USATC AD (2)	7-52	30-25
USATC Armor (2)	9-12	30-29
USATC Engr (2)	9-22	32-51
USATC Inf (2)	9-86	32-52
USASTC (2)	11-5	32-56
Svc Colleges (2)	11-7	32-57
Br Svc Sch (2)	11-15	32-67
GENDEP (OS) (2)	11-16	32-68
Sig Dep (OS) (12)	11-17	37
Army Dep (2) except	11-18	39-51
Ft Worth (8)	11-32	39-401
Lexington (12)	11-37	57
Sacramento (17)	11-38	
Tobyhanna (12)		

NG: State AG (3); units—same as active Army except allowance is one copy to each unit.

USAR: None.

For explanation of abbreviations used see AR 320-50.





CHAPTER 1

INTRODUCTION

Section I. GENERAL

1. Scope

a. This manual describes Radio Sets AN/GRC-26A, AN/GRC-26B, and AN/GRC-26C and covers their installation, operation, and operator's maintenance. It includes operation under usual and unusual conditions, cleaning and inspection of the equipment, and replacement of parts available to first echelon maintenance. The Maintenance Allocation Chart is published in TM 11-5820-202-20.

b. Official nomenclature which contains (*) is used to indicate all models of the equipments covered in this manual; thus—

- (1) Radio Transmitter BC-610-(*) represents Radio Transmitters BC-610-H and -I.
- (2) Speech Amplifier BC-614-(*) represents Speech Amplifiers BC-614-H and -I.
- (3) Rectifier RA-87-(*) represents Rectifiers RA-87 and RA-87-A.
- (4) Microphone T-17-(*) represents Microphones T-17-B through -F.
- (5) Frequency Shift Exciter O-39(*)/TRA-7 represents Frequency Shift Exciters O-39B/TRA-7 and O-39C/TRA-7.
- (6) Headset HS-30-(*) represents Headsets HS-30-A through -H, -J through -M, and -R.
- (7) Power Supply PP-712(*)/GRC-26A represents Power Supplies PP-712/GRC-26A and PP-712A/GRC-26A.
- (8) Frequency Shift Converter CV-182(*)/GRC-26A represents Frequency Shift Converters CV-182/GRC-26A, CV-182A/GRC-26A, and CV-182B/GRC-26A.
- (9) Radio Set AN/GRC-26(*) represents Radio Sets AN/GRC-26A, -26B, and -26C.

- (10) Antenna Tuning Unit BC-939(*) represents Antenna Tuning Units BC-939, BC-939A, and BC-939B.
- (11) Power Unit PE-95(*) represents Power Units PE-95-G, PE-95-H, and PE-95-I.
- (12) Mast Base MP-65-(*) represents Mast Bases MP-65-B and MP-65-C.
- (13) Telephone EE-8- (*) represents Telephones EE-8, EE-8-A, and EE-8-B.

c. Technical manuals have been published covering detailed instructions on the installation, maintenance, and operation of most of the major components of Radio Set AN/GRC-26(*). These are—

Equipment	Technical manual
Frequency Shift Exciter O-39(*)/TRA-7	TM 11-257
Frequency Shift Converter CV-182(*)/GRC-26A	TM 11-5062
Speech Amplifier BC-614-(*)	TM 11-5054
Antenna Tuning Unit BC-939-(*)	TM 11-826
Radio Transmitter BC-610-(*)	TM 11-826
Power Unit PE-95-(*)	TM 11-904
Radio Receiver R-388/URR	TM 11-854
Rectifier RA-87	TM 11-957
Rectifier RA-87-A	TM 11-957A
Teletypewriter TT-55/MGC	TM 11-352
Teletypewriter TT-4A/TG	TM 11-2234
Perforator-Transmitter TT-56/MGC	TM 11-2201
Transmitter-Distributor (part of TT-56/MGC)	TM 11-2222
Power supply PP-712(*)/GRC-26A	TM 11-5062
Teletypewriter Reperforator-Transmitter TT-76/GGC	TM 11-2225

d. Radio Teletypewriter Control C-808/GRC-26A, Transmitter-Teletypewriter C-808A/GRC-

26A, and Radio Set Control Group AN/GRA-14 are covered in detail in this manual.

2. Forms and Records

a. Unsatisfactory Equipment Reports.

- (1) Fill out and forward DA Form 468 (Unsatisfactory Equipment Report) to Commanding Officer, U.S. Army Signal Equipment Support Agency, Fort Monmouth, N.J., as prescribed in AR 700-38.
- (2) Fill out and forward AF TO Form 29 (Unsatisfactory Report) to Commander, Air Materiel Command, Wright-Patterson Air Force Base, Ohio, as prescribed in AF TO 00-35D-54.

b. *Report of Damaged or Improper Shipment.* Fill out and forward DD Form 6 (Report of Damaged or Improper Shipment) as prescribed in 2.1 (ADDED) SEE PAGE 1 OF E-6

Section II. DESCRIPTION AND DATA

3. Purpose and Use

a. *Radio Set AN/GRC-26-(*).* Radio Sets AN/GRC-26A, -26B, and -26C (fig. 1) are identical in purpose and use. They are mobile equipments that provide facilities for transmitting and receiving radioteletypewriter (RTT) frequency shift (fs) signals within the frequency range of 2 to 18 megacycles (mc). In addition, continuous-wave (cw) telegraphy and amplitude-modulated (am) voice facilities are provided. The voice signals can be transmitted alone or they can be transmitted simultaneously with the RTT signals. Teletypewriter operation may be either half duplex one-way reversible or full duplex. The teletypewriter equipment operates most satisfactorily when stationary, but, over smooth terrain, operation in motion on a one-way reversible basis is possible.

b. *Radio Set Control Group AN/GRA-14.* The control group controls the following functions of the radio set from locations as far as 1 mile: switching from send to receive; providing both radiotelephone and radioteletypewriter communication on a one-way reversible or full-duplex basis; and communication by telephone and by teletypewriter between the remote site and the radio set.

c. *Radio Teletypewriter Control C-808/GRC-26A and Transmitter-Teletypewriter C-808A/GRC-26A.* For transmitting operation, the teletypewriter control unit converts neutral pulses received from the transmitting teletypewriter equipments into polar signals for operation of the frequency shift exciter.

SEE PAGE 1 OF E-6
AR 700-58 (Army) Navy Shipping Guide, Article 1850-4 (Navy) and AFR 71-4 (Air Force).

c. *Preventive Maintenance Form.* Prepare DA Form 11-238 (figs. 31 and 32) (Maintenance Check List for Signal Equipment, Sound Equipment, Radio, Direction Finding, Radar, Carrier, Radiosonde and Television) in accordance with instructions on page 1 of the form.

d. *Parts List Form.* Forward DA Form 2028 (Recommended Changes to DA Technical Manual Parts Lists or Supply Manuals 7, 8, and 9) direct to the Commanding Officer, U.S. Army Signal Equipment Support Agency, Fort Monmouth, N.J., ATTN: SIGFM/ES-ML for comments on parts listings in Appendix II.

e. **Comments on Manual.** Forward all other comments on this publication direct to the Commanding Officer, U.S. Army Signal Publications Agency, Fort Monmouth, N.J.

(ADDED) SEE PAGE 1 OF E-4

For receiving operation, the teletypewriter control unit converts the polar pulses received from the frequency-shift converter to neutral pulses (or, in some operations, to polar pulses) for the operation of the receiving teletypewriter and/or reperforator equipments.

4. Technical Characteristics

The technical characteristics of Radio Set AN/GRC-26(*) are as follows:

Frequency range	2 to 18 mc.
Types of signals transmitter	850-eps fs radioteletypewriter, fs manual keying, cw, am (voice) (with Speech Amplifier BC-614-(*)).
Distance range:	
Cw or fs	250 miles.
Voice	100 miles.
Type of modulation	Fs and am simultaneously or separately.
Antennas:	
Whip antenna	Transmitting, 15 feet long; receiving, 12 feet long.
Doublet	Wire W-1 cut to desired length, supported by Masts AB-155A/U or lance poles.
Long wire	25 to 100 feet long.
Power input	115 volts ac, 50 to 60 eps.
Power output:	
Cw or fs operation	400 watts (max).
Voice	300 watts (max).
Fs and voice simultaneously.	400 watts (max).

a. *Teletypewriter Control C-808/GRC-26A.*

Polar input:	
Mark	+ .025 amp.
Space	- .025 amp.
Polar output:	
Mark	+ .020 amp.
Space	- .025 amp.
Neutral input and output:	
Mark060 amp.
Space	0 amp.
Number of tubes	2.
Power input	115 volts ac, 50 to 60 cps, 100 watts.

b. *Radio Set Control Group AN/GRC-14.*

(1) *Overall equipment.*

Types of operation	Switching from send to receive. Radiotelephone and/or radioteletypewriter communication on a one-way reversible or full-duplex basis. Telephone communication to the radio set shelter simultaneously with radioteletypewriter communication to a distant station. Teletypewriter communication to the radio set shelter simultaneously with radiotelephone communication to a distant station.
Range of operation between remote site and radio set.	1 mile (max).
Interconnections	Field wires between remote site and radio set. Special cables for connections to local radio equipment.

(2) *Radio Set Control C-1306/GRA-14.*

Power input	115 volts dc.
Connections for external equipment.	Four multiple connectors. Three jacks. One pair of spring binding posts for telephone connections. One male receptacle for power cord.
Connection for remote line.	Three pairs of spring binding posts.
Local control facilities ..	Switching to provide local or remote control for telephone, radiotelephone, and radioteletypewriter communications.

(3) *Remote Switching Control C-1307/GRA-14.*

Power source	115 volts ac, 60 cps.
Connections for external equipment.	Two spring binding posts, six jacks.
Connections for remote lines.	Three pairs of spring binding posts.

5. Components of Radio Sets

Refer to appendix II for a list of the major and minor components of the radio sets. The running spares covered by this manual are also listed. For information on the running spares furnished for other components of the radio sets, refer to the appropriate technical manuals (par. 1c). Refer to paragraph 14 for additional equipment required.

6. Common Names

A list of the nomenclature assignments for the components of the radio set is given below. A common name is indicated after each item.

Nomenclature	Common name
Radio Sets AN/GRC-26A, -26B, and -26C.	Radio set.
Frequency Shift Converter CV-182(*)/GRC-26A.	Frequency shift converter.
Frequency Shift Exciter O-39(*)/TRA-7.	Frequency shift exciter.
Radio Set Control Group AN/GRA-14.	Control group.
Radio Set Control C-1306/GRA-14.	Radio set control.
Remote Switching Control C-1307/GRA-14.	Remote switching control.
Radio Teletypewriter Control C-808/GRC-26A and Transmitter-Teletypewriter C-808A/GRC-26A.	Teletypewriter control unit.
Radio Transmitter BC-610-(*).	Transmitter.
Speech Amplifier BC-614-(*).	Speech amplifier.
Antenna Tuning Unit BC-939-(*).	Antenna tuning unit.
Radio Receiver R-388/URR.	Receiver.
Teletypewriter TT-4A/TG or Teletypewriter TT-55/MGC.	Teletypewriter.
Power Unit PE-95-(*).	Power unit.
Telephone EE-8-(*).	Telephone.
Perforator-Transmitter TT-56/MGC or Teletypewriter Reperforator-Transmitter TT-76/GGC.	Reperforator.
Shelter S-69/GRC.	Shelter.

7. Description of Radio Set AN/GRC-26(*)

a. The radio set consists of two receivers, a transmitter with an antenna tuning unit, speech amplifier, frequency shift exciter, frequency shift

SHELTER S-69/GRC

C-388-C 3.5-4.5 MC	C-389-C 4.5-5.7 MC	C-390-C 5.7-8.0 MC	C-447-B 8.0-11.0 MC	C-448-B 11.0-14.0 MC	C-449-B 14.0-18.0 MC	TU-47 2.0-2.5 MC	TU-47 2.0-2.5 MC	TU-47 2.0-2.5 MC	TU-47 2.0-2.5 MC		
TU-49 3.2-4.0 MC	TU-50 4.0-5.0 MC	TU-51 5.0-6.35 MC	TU-52 6.35-8.0 MC	TU-53 8.0-12.0 MC	TU-54 12.0-18.0 MC	TU-48 2.5-3.2 MC	TU-48 2.5-3.2 MC	TU-48 2.5-3.2 MC	TU-48 2.5-3.2 MC		
TU-49 3.2-4.0 MC	TU-50 4.0-5.0 MC	TU-51 5.0-6.35 MC	TU-52 6.35-8.0 MC	TU-53 8.0-12.0 MC	TU-54 12.0-18.0 MC	TU-49 3.2-4.0 MC	TU-49 3.2-4.0 MC	TU-50 4.0-5.0 MC	TU-51 5.0-6.35 MC		
1 HARDWARE		2 SPARES FOR FREQUENCY SHIFT EXCITER		7 SPARES FOR FREQUENCY SHIFT CONVERTER		8 TECHNICAL MANUALS		13 CORDS		14 2 EA. TANK COILS C-387-D 2.0-3.5 MC CAPACITOR CA-423	
3 ANTENNA EQUIPMENT		4 SPARES FOR RADIO TRANSMITTER		9 SPARES FOR TELETYPEWRITER CONTROL UNIT		10 ELECTRICAL TROUBLE LAMP		15 KEY J-45, MICROPHONE HEADSET		16 SPARES FOR RECEIVER	
5 MULTIMETER TS-352/U (IF ISSUED)		6		11 SPARES FOR SPEECH AMPLIFIER		12		17 STATIONERY		18 MISC.	
1 EA. POWER CABLE ASSEMBLY CX-1165/U		3 EA. MAST BASE MP-65-(* 3 EA. BRACKET MP-50-A 1 EA. CLIP BOARD 1 EA. BRUSH, BENCH		SPARE FLUORESCENT LAMPS		UTILITY TABLE FOR CY-1216/U (AN/GRC-26B AND -26C)					
2 EA. RF CABLE ASSEMBLY CG-557A/U		1 EACH MAST BASE MP-47-A									

TM5820-202-10-2

Figure 2. Diagram of storage cabinet for minor components and spare parts.



Figure 3. Radio Set AN/GRC-26C, interior rear view of shelter.

converter, control group, teletypewriter control unit, teletypewriters, reperforator, power unit, shelter, three whip antennas and three doublet antennas, interconnecting cables, and accessory components and spare parts. Refer to appendix II for a list of all the components of the radio set. Figures 3 and 4 show some of the operating components of Radio Set AN/GRC-26C.

b. All components of the radio set except the doublet antennas, the remote switching control,

and the trailer-mounted power unit are housed within the shelter during operation.

8. Description of Shelter S-69/GRC

(fig. 5)

a. The shelter is an insulated steel and plywood structure used to house the operating components of Radio Set AN/GRC-26(*). A roof hatch, six wall windows, and the window in the rear door are provided with screening and blackout blinds. The

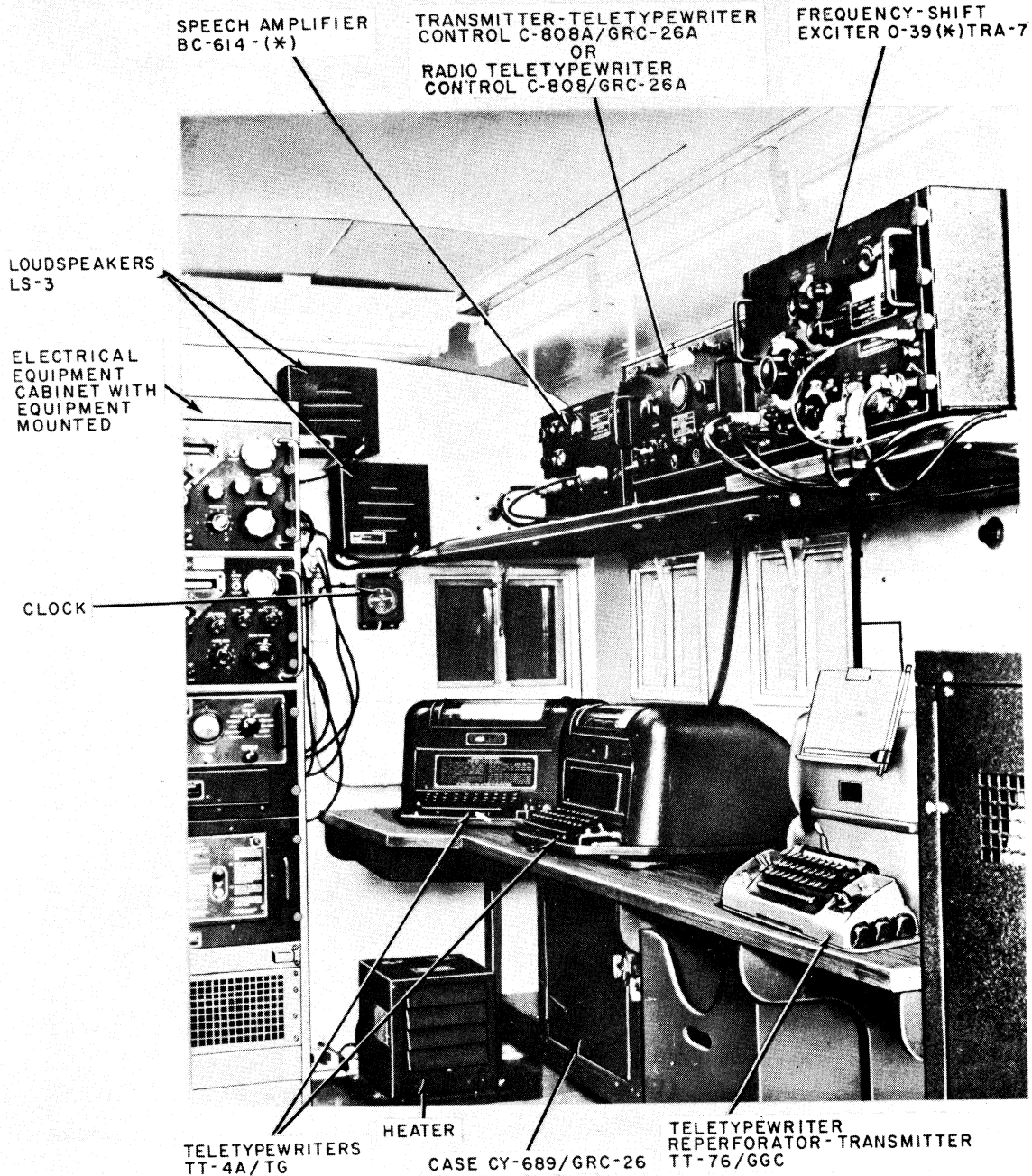

TM5820-202-10-4

Figure 4. Radio Set AN/GRC-26C, interior side view of shelter.

windows and roof hatch may be opened to provide ventilation. The wall cabinets, operating tables, shelves, wiring, electrical outlets, fluorescent lights, and ventilating blower are permanent parts of the shelter.

b. The power for the operation of the radio set is connected through the power receptacle in the rear wall of the shelter to the two power circuits. Each circuit breaker controls the power for two branch circuits. From the power circuit breakers, the

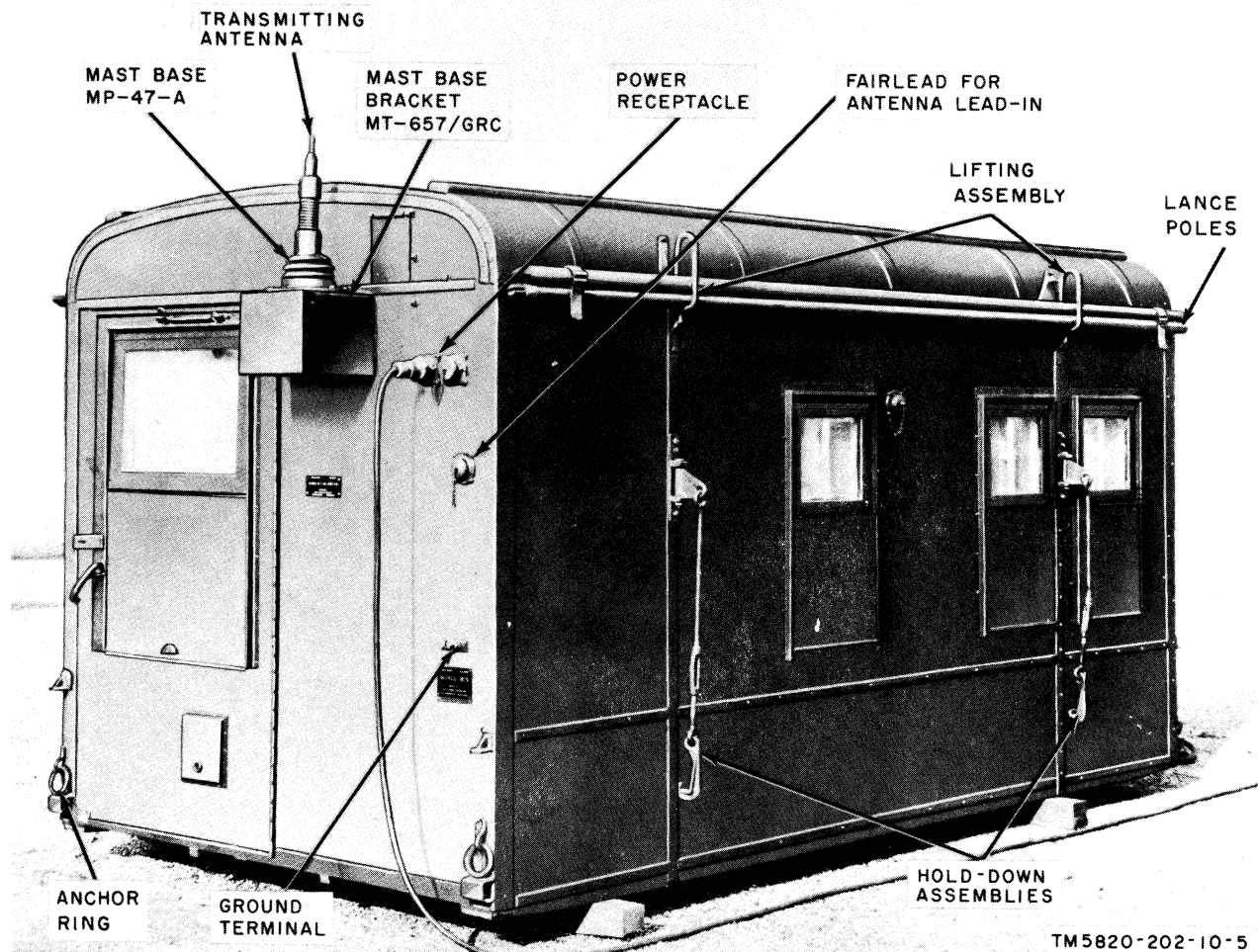

Figure 5. Shelter S-69/GRC, rear oblique view.

power is also applied to a lighting circuit breaker which controls the power to the fluorescent fixtures.

c. The shelter is mounted on a standard 80- by 144-inch cargo truck body for transportation or mobile operation. Lifting assemblies are used when hoisting the shelter onto the truck. Two hold-down assemblies on each side of the shelter secure it to the cargo truck body. Four anchor rings are used to secure the shelter to the cargo truck when the truck bed is a wooden platform. The shelter can be removed from the truck when fixed station operation is desired.

9. Description of Antenna Equipment

a. *Whip Antennas.* One transmitting and two receiving whip antennas are furnished.

(1) The transmitting whip antenna consists of one each Mast Sections MS-49,

MS-50, MS-51, MS-52, and MS-53 in Mast Base MP-47-A. Mast Base MP-47-A is mounted on mast base Bracket MT-657/GRC, which is secured to the rear exterior wall of the shelter (fig. 5). An insulated guy assembly is provided to tie the whip antenna in a horizontal position when the radio set is in motion (fig. 12).

(2) Each receiving whip antenna consists of two Mast Sections MS-116-A, one Mast Section MS-117-A, and one Mast Section MS-118-A in Mast Base MP-65-(*). Mast Base MP-65-(*) is mounted on Mast Bracket MP-50-A, which is secured to the front exterior wall of the shelter (fig. 13). Each whip antenna is tied down with an insulated guy assembly when the radio set is in motion (fig. 12).

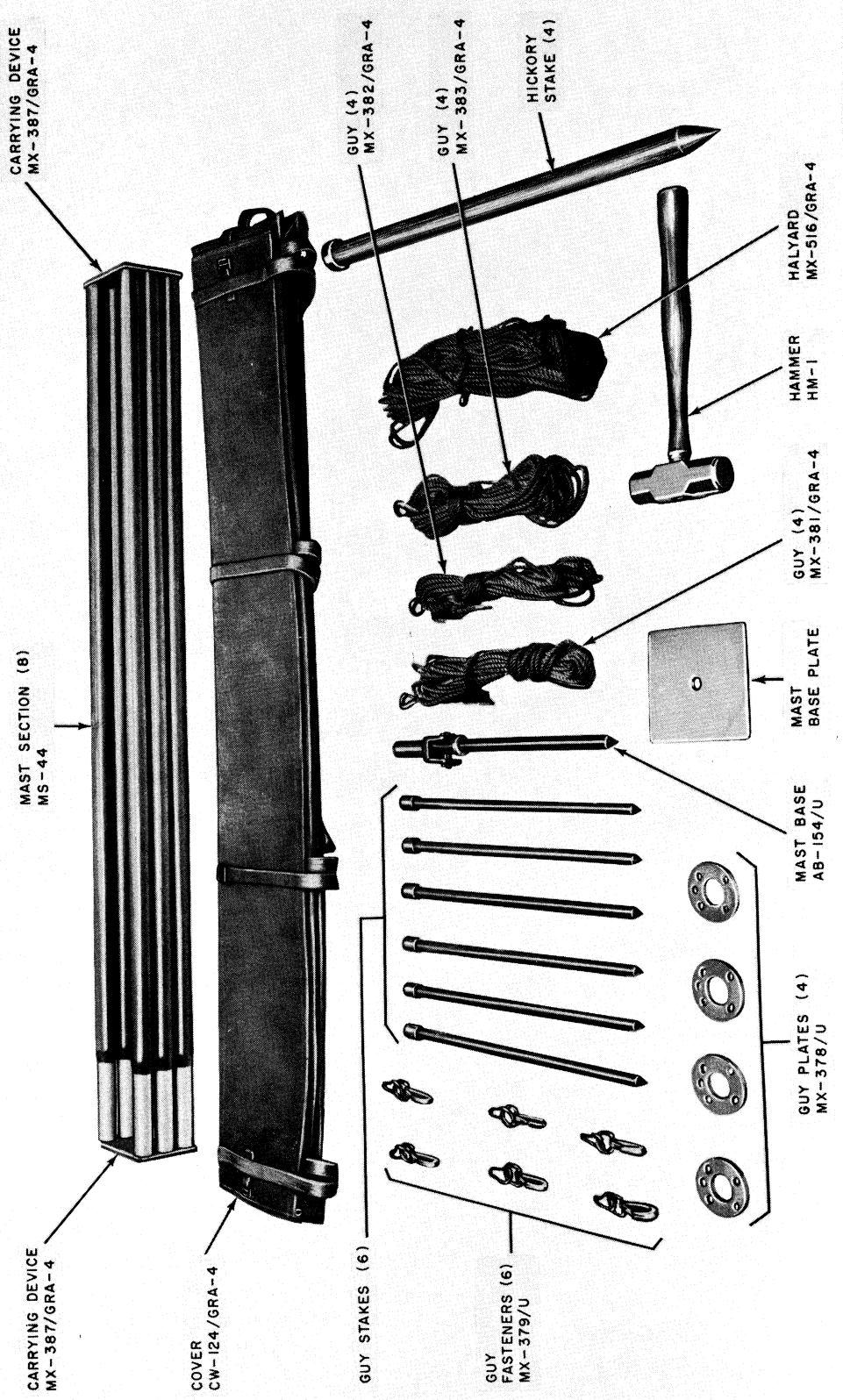

TM5920-202-10-6

Figure 6. Mast AB-155A/U, components.

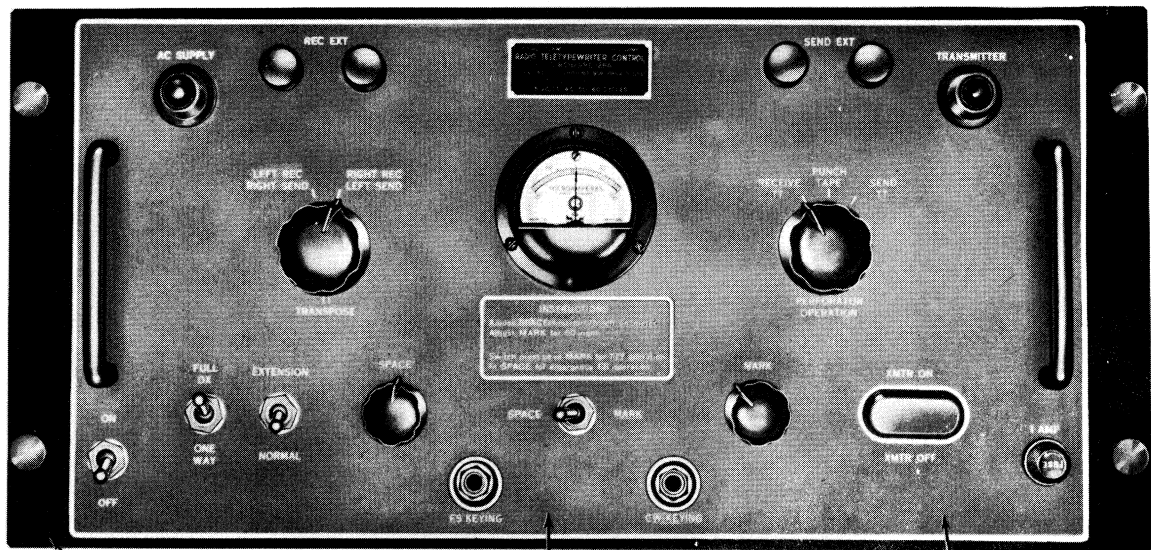

RADIO TELETYPEWRITER
CONTROL CASE
CY-901/GRC-26

NOTE:
CAUTION NOTICE HAS BEEN
ADDED WITH DECALCOMANIA
BY MWO SIG11-264A-6.

CAUTION
FOR C-W BREAK-IN, PLACE SWITCH
ON REAR OF CHASSIS IN C-W BREAK-IN
POSITION FOR ALL OTHER OPERATIONS,
PLACE SWITCH IN NORMAL POSITION.

RADIO TELETYPEWRITER
CONTROL C-808/GRC-26A

TM5820-202-10-7

Figure 7. Radio Teletypewriter Control C-808/GRC-26A, mounted in Radio Teletypewriter Case CY-901/GRC-26A.

b. Doublet Antennas. Six Masts AB-155A/U (fig. 6) and 1,000 feet of Wire W-1 are furnished for the construction of half-wave doublet antennas. At the higher frequencies (4-20 mc), where shorter wire lengths are required, two masts are used to support each doublet. Therefore, three antennas may be erected, two for receiving on space diversity operation and one for transmitting. Four wooden lance poles are available for use as antenna masts in temporary installations. Two RF Cable Assemblies CG-557/U (500 ft) on Reels DR-4 are used for receiving antenna lead-ins. One RF Cable Assembly CG-557A/U (75 ft) is used as a transmission line for the transmitting doublet.

10. Description of Radio Teletypewriter Control C-808/GRC-26A and Transmitter-Teletypewriter Control C-808A/GRC-26A

(fig. 7)

The teletypewriter control unit is housed in a case and mounted on a shelf above the teletypewriter equipment (fig. 4). Operating controls, indicating lamps, and meter are located on the

front panel. Jacks and receptacles for connectors for connection to the other equipment of the radio set are mounted on the top and rear of the teletypewriter control unit.

11. Description of Radio Set Control Group AN/GRA-14

(fig. 8)

The control group consists of Radio Set Control C-1306/GRA-14, Remote Switching Control C-1307/GRA-14, and assorted cables. Adjustment of the control group is made by setting toggle switches on the front of the local control unit.

a. Radio Set Control. The various parts of the unit are mounted on the inside of the box. Switches, controls, and binding posts are mounted on the front, top, and two sides. The box is mounted on the shelter wall immediately below the teletypewriter control unit.

b. Remote Switching Control. The various parts of the unit are mounted on the inside of the box. A switch and indicator light are mounted on the front of the box; binding posts, jacks, and a power cord are located on the sides of the box. Two

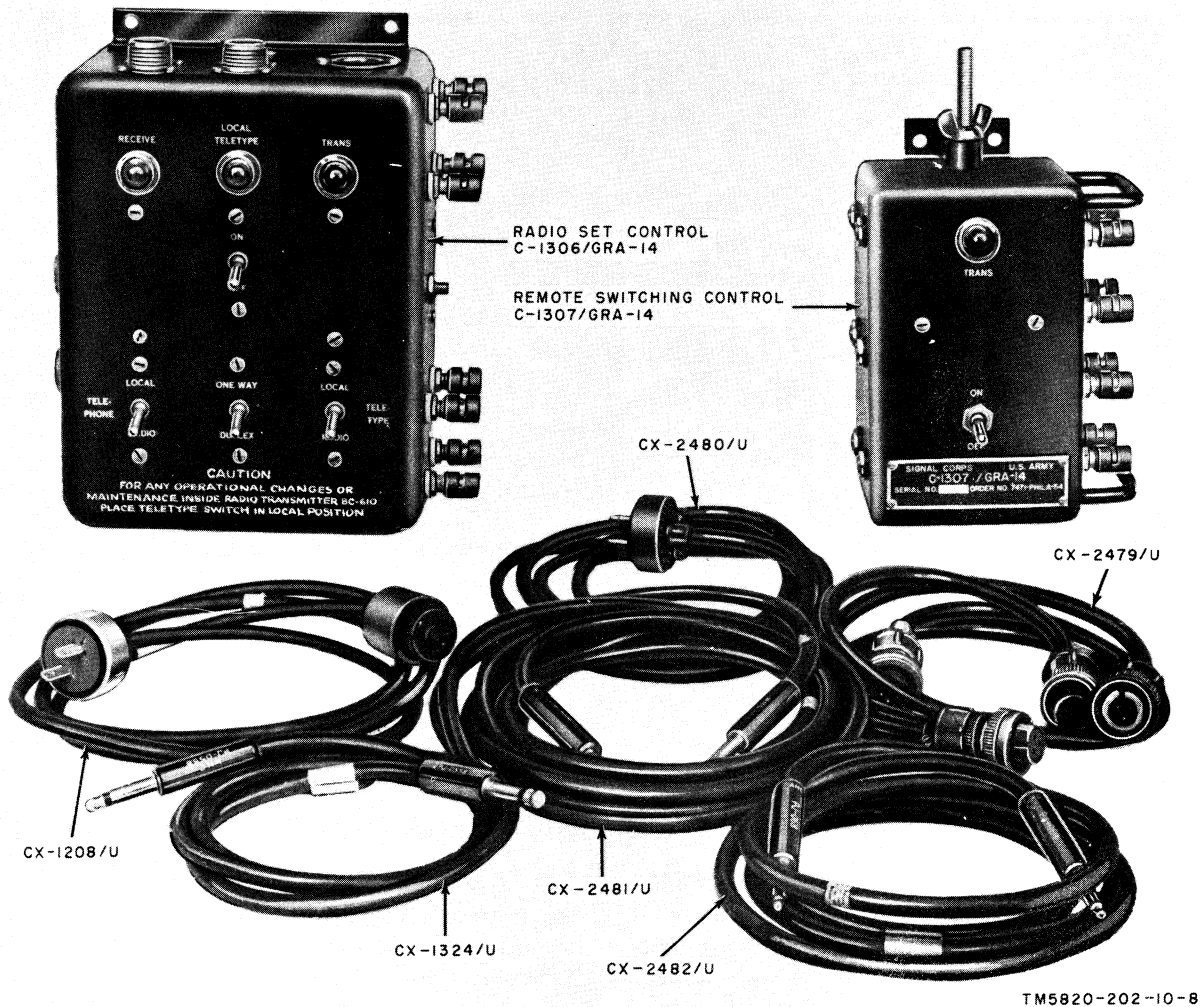

Figure 8. Radio Set Control Group AN/GRA-14.

U-shaped brackets are located close to the spring binding posts to provide mechanical protection for connections made to these terminals. A clamp is used to mount the box to a convenient object, such as a table.

12. Description of Cabinets

a. Rack CY-1050/GRC-26A (fig. 9). This rack, used in Radio Set AN/GRC-26A, is located in the front end of the shelter. It is designed to house the two receivers, the frequency shift converter, and Power Supply PP-712(*)/GRC-26A. Guide rails provide the means to position the units in the rack. Rows of tapped holes along both sides of the front panel provide a means of screwing the knurled nuts of the mounted units to the cabinet. The cover on the right-hand side provides access

to the frequency-shift converter and to Power Supply PP-712(*)/GRC-26A without removing these units from the cabinet.

b. Electrical Equipment Cabinet CY-1216/U (fig. 10). This cabinet, used in Radio Sets AN/GRC-26B and AN/GRC-26C, is located in the front end of the shelter. It is similar to Rack CY-1050/GRC-26A (*a* above), but has several additional features. These include a blower assembly for air circulation, an air vent and duct for distribution of warm air, convenience outlets, individual cabinet openings for admitting each cable or cord entering the cabinet, and a detachable utility cable.

(1) *Blower assembly.* This unit is mounted at the bottom of Electrical Equipment Cabinet CY-1216/U and contains a small,

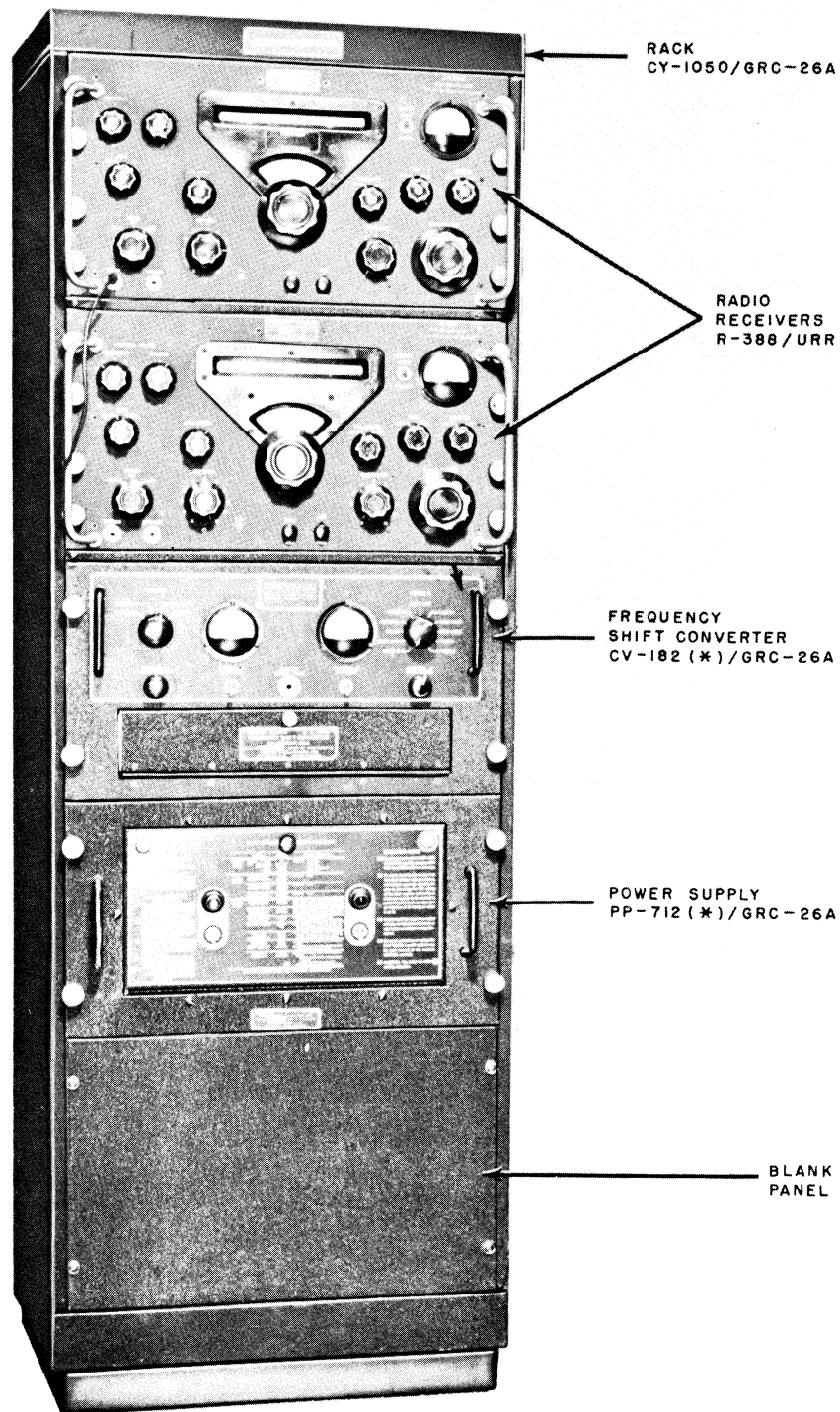

TM5820-202-10-9

Figure 9. Rack CY-1050/GRC-26A, front view.

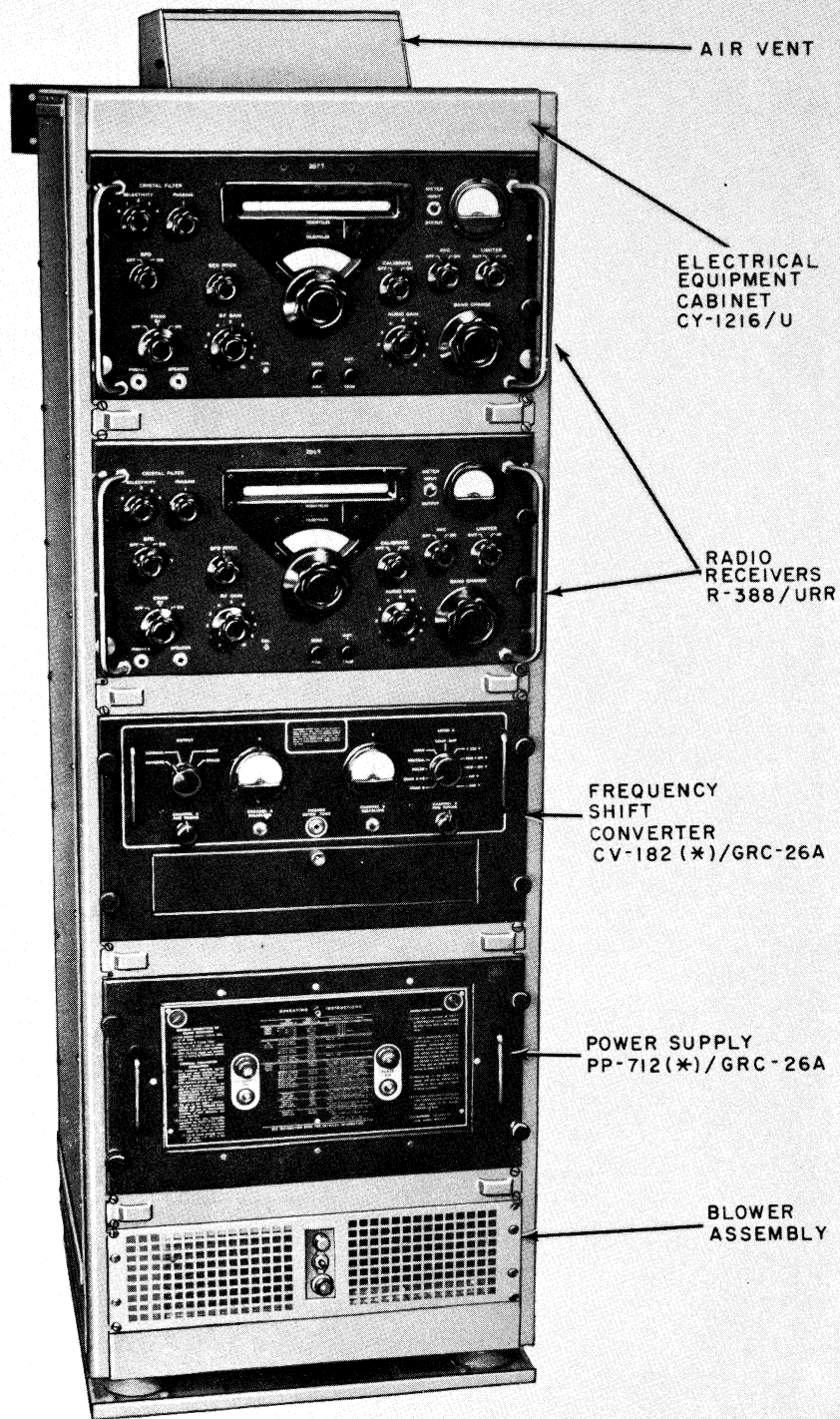

TM5820-202-10-10

Figure 10. Electrical Equipment Cabinet CY-1216/U, front view.

fractional horsepower induction motor operating on 115 volts, 50 to 60 cycles per second (cps) alternating current (ac). Two centrifugal vanes blow cooling air through the cabinet and out the air vent. The front panel of the blower assembly contains an ON-OFF switch, a ½-ampere fuse in a fuse holder, and a red lens, neon, power-on indicator lamp. The ac power cord passes through the rear of the blower assembly and connects to the bottom convenience outlet ((2) below).

- (2) *Convenience outlets.* A vertically mounted wiring channel assembly with five non-polarized 115-volt ac outlets is located inside the cabinet. Two of these outlets are used for supplying ac power to the two receivers and the third is for the blower assembly. The power cord attached to this wiring channel assembly passes out through an opening in the bottom part of the rear panel in the cabinet.
- (3) *Rear panel cable entrances.* Eight openings are provided for admitting the cables and cords to the cabinet. Split rubber grommets protect the cables and cords from damage.
- (4) *Utility table.* A formica-topped utility table can be fastened to the front of the cabinet at four different heights, each corresponding to the correct servicing height of the four major components in the cabinet. This table is stored in the right hand bottom section of the spare parts storage cabinet when not in use (fig. 2).
- (5) *Equipment mountings.* The cabinet is furnished with slides, stops, and guide-pin inserts for installing various equipments in the rack. When Radio Receiver R-388/URR is installed in the rack, the guide-pin inserts must be in the top hole of the stops at the rear of the receiver slides.

13. Description of Minor Components

a. Headset HS-30-().* The headset consists of two small telephone receivers which can be adjusted on the metal headband to suit each individual. Cord CD-605 (6 ft, 6 in.), provided with a telephone plug at one end, is connected to the receivers by a Y-cord.

b. Telephone EE-8-().* This portable field telephone is incased in a leather or weatherproofed canvas case. The handset, provided with a switch for talking or listening, is connected to the terminals at the top of the telephone case by a cord. A hand generator is provided for signaling. The telephone is used on either local or common battery systems.

c. Key J-45. Key J-45 is a keying device provided with a metal band which can be placed around the thigh. Cord CD-201-A, provided with a two-conductor plug at one end, is connected permanently to the key at the other end. Manual fs or cw keying can be accomplished when the key is connected to the teletypewriter control unit.

d. Loudspeaker LS-3. Each loudspeaker LS-3 (fig. 4) is a permanent-magnet type speaker housed in a metal case. Electrical Special Purpose Cable Assembly CX-1939/U is used to connect a loudspeaker to a receiver.

e. Microphones.

- (1) Microphone T-17-(*) is a low-impedance, carbon-button, hand microphone. It is provided with a three-wire cord terminating in Plug PL-68 on one end and in the microphone on the other end. It is plugged into CARBON MIC. 1 jack on the speech amplifier and operated by using the press-to-talk button on the handle.
- (2) Microphone T-50 is a dynamic high-impedance (21,000 ohms) microphone. It is provided with a 6-foot cord which terminates in a three-pin coaxial-type connector. It is plugged into DYNAMIC MIC. 2 jack on the speech amplifier and operated by pressing the press-to-talk switch.

f. Adapter Kit M-459. Adapter Kit M-459 (fig. 15) consists of a two-section ceramic insulator, a steel ground ring connected to a metal clamp through a tinned copper braid, and two rubber washers. One ceramic insulator has a coaxial-type connector fitted into one end. The other has a bakelite bushing. It provides a coaxial-type connector for the coaxial cable transmission line from a receiving whip antenna mast base to a receiver.

g. Case CY-689/GRC-26. Case CY-689/GRC-26 (fig. 4) is a plywood bin equipped with two handles. It is used to store teletypewriter tape

and is located under the table to the left of the transmitter-distributor.

h. Electrical Air Heater No. AFF-15. This electrical heater (fig. 4), provided with a cast aluminum grid, is housed in a metal case. It operates on 115-volt, 50- to 60-cps, single-phase, ac, and consumes 1,500 watts. A fan mounted in front of the heater element circulates the heated air. Four wing nuts secure the heater to the floor of the shelter.

i. Reel RL-29. Reel RL-29 is an H-shaped wire holder with a handle fastened to one side. It is used to store antenna Wire W-1.

j. Compass. The compass is a moving needle-magnetic compass incased in an aluminum case. It is graduated in degrees from 0 to 360 in a raised metal ring with the zero point at the North position. It is unmounted and can be carried suspended from the neck by a cord fastened to the case. A small button near the periphery of the glass is depressed when the hinged cover is closed. This clamps the needle when the hinged cover is closed.

k. Time Stamp MC-181-A. The time stamp is a key-wound mechanical clock inclosed in a metal housing. It prints message center, organization, month, day, year, and the time of day on a 24-hour basis (0000 to 2359). It is located between the right hand teletypewriter and the reperforator.

l. Clock. This aircraft clock (fig. 4) is mounted in a metal frame. The mounting frame with four holes is used to mount the clock on the wall below Loudspeakers LS-3.

14. Additional Equipment Required

a. Mobile Operation (fig. 12). To transport or operate the radio set while traveling, a 6 x 6, 2½-ton truck is needed. In addition, a hoist or crane, with suitable chains, steel rope, or equivalent, is required to lift the shelter and place it on the truck. Skid Equipment MX-157/U, consisting of ropes and two wooden skids, may be used to slide the shelter onto the truck.

b. Batteries. Four Batteries BA-30 are required for the two Telephones EE-8-(*). One Battery BA-30 and three Batteries BA-31 are required for Multimeter TS-352/U, if this test set is supplied with the radio set.

c. Remote Operation Site. The teletypewriters and the reperforator may be taken from the shelter and mounted at the remote site for remote operation. However, for full use of the radio

set with the control group, the following additional equipment is required:

- (1) Two Teletypewriters TT-4A/TG, or equivalent.
- (2) One Perforator-Transmitter TT-56/MGC or Teletypewriter Reperforator-Transmitter TT-76/GGC.
- (3) A source of 115-volt ac power.
- (4) One Telephone EE-8-(*), or equivalent.
- (5) Wire WD-1/TT, or equivalent, to provide three lines between the shelter and the remote site.
- (6) Spiral-four cable may be used if the operation is to be only one-way reversible (one pair for the teletypewriter circuit, the other pair for the telephone circuit).

15. Differences in Models

Radio Sets AN/GRC-26A, -26B, and -26C are similar in purpose and in general operation. Differences in the radio sets are described in *a* through *j* below.

a. Teletypewriters.

- (1) Teletypewriter TT-55/MGC was issued in some early sets of Radio Set AN/GRC-26A.
- (2) Teletypewriter TT-4A/TG was issued with late sets of Radio Set AN/GRC-26A, and is used in Radio Sets AN/GRC-26B and -26C.

b. R.C. perforators.

- (1) Perforator-Transmitter TT-56/MGC is used in Radio Sets AN/GRC-26A and -26B.
- (2) Teletypewriter Reperforator-Transmitter TT-76/GGC is used in Radio Set AN/GRC-26C.

c. Cabinets.

- (1) Rack CY-1050/GRC-26A is used in Radio Set AN/GRC-26A.
- (2) Electrical Equipment Cabinet CY-1216/U is used in Radio Sets AN/GRC-26B and AN/GRC-26C.

d. Cording. Interconnection of equipments of the different models of the radio sets vary slightly. Refer to figures 23 through 25 for the proper cording connections.

e. Frequency Shift Exciter O-39()/TRA-7.*

- (1) In equipments not listed in (2) below, FUSE F102, 3 AMP is used.
- (2) In Frequency Shift Exciter O-39B/TRA-7 bearing Order No. 3135-Phila-51 (serial Nos. 630-811) and in Frequency Shift

Exciter O-39C/TRA-7 bearing Order No. 3357-Phila-52, FUSE 103, .3 AMP is used instead of FUSE F102, 3 AMP.

f. Typewriter MX-322/U. This instrument is available only in some early sets of Radio Set AN/GRC-26A.

g. Plug PL-258. Four of these plugs are supplied with radio sets bearing Order No. 3357-Phila-52.

16. System Application

The actual applications of Radio Set AN/GRC-26(*) depend on the tactical situation. The radio set may be used for signal communication:

a. From beachhead landing force in amphibious operations to higher headquarters.

b. From advanced command posts, and other command and administrative headquarters in land operations, to higher headquarters.

c. With mobile communication centers.

d. For interconvoy and intraconvoy communication.

e. From corps command post to rapidly moving subordinate or supporting echelons.

f. From division command post to subordinate or supporting elements.

g. From fixed bases prior to established permanent facilities.

CHAPTER 2

INSTALLATION

Section I. SERVICE UPON RECEIPT OF EQUIPMENT

17. Unpacking

a. Packaging Data.

- (1) When packaged for export shipment, Radio Set AN/GRC-26A is packed in two wooden export crates. Items may be packaged in a different manner depending on the supply channel. The size, weight, and volume of each crate are as follows.

Number of crates	Height (in.)	Length (in.)	Depth (in.)	Volume (cu ft)	Unit weight (lb) (approx)
1	93 $\frac{7}{8}$	155	99 $\frac{1}{4}$	768	10,000
1	75 $\frac{3}{4}$	108	80 $\frac{3}{4}$	382	5,400
Total weight (lb)					15,400

- (2) When packaged for domestic shipment, Shelter S-69/GRC is not crated. Power Unit PE-95-(*) mounted on Trailer K-52 is in a protective wooden crate. The size, weight, and volume of each unit is as follows.

Number of crates	Height (in.)	Length (in.)	Depth (in.)	Volume (cu ft)	Unit weight (lb)
Shelter	79 $\frac{1}{2}$	142	83 $\frac{1}{2}$	544	6,590
Trailer	75 $\frac{3}{4}$	108	80 $\frac{3}{4}$	382	5,360
Total weight (lb)					11,950

- (3) The following list indicates the contents of each case. Refer to the packing list attached to each case for a detailed list of contents.

Case dimensions (in.)	Item	Contents
93 $\frac{7}{8}$ x 155 x 91 $\frac{1}{4}$.	Shelter S-69/GRC in external crate.	Contains operating components, antenna equipment, Reel Unit RL-31, power cables, shoring, and desiccants.
79 $\frac{1}{2}$ x 145 x 81 $\frac{1}{2}$.	Shelter S-69/GRC less external crate.	Same components as with external crate.
75 $\frac{3}{4}$ x 108 x 80 $\frac{3}{4}$.	Power Unit PE-95-(*) mounted on Trailer K-52.	Contains gasoline cans, racks, desiccants, and moisture-vaporproof barriers.

- (4) An aircraft loading data plate, mounted on the outside of Shelter S-69/GRC, gives the weight, dimensions, and center of gravity of the shelter, less external crate. Note that the weight includes shelter shoring, desiccant, and other packing materials which are inside the shelter (fig. 3) when it is shipped initially. The weight shown on the plate is reduced by approximately 1,000 pounds when shoring, desiccant, and packing materials are removed. The center of gravity remains substantially unchanged.

b. Removing Contents. When unpacking the equipment from the export case (fig. 11), perform the steps outlined below. When unpacking the equipment from the domestic case, omit the procedures given in (1) through (3) below.

- (1) Remove the top of the crate. Use nail pullers and crowbars for dismantling the crate.

- (2) Remove the sides and the ends.
- (3) Unfasten the clamps of the four hold-down assembly clamps (fig. 11) from the base of the crate.
- (4) Remove the moisture-vaporproof barriers from the door and openings.
- (5) Open the door, dismantle the wooden blocking frames, and remove the desiccant bags. Avoid thrusting dismantling tools into cabinets, chests, and boxes.
- (6) Remove all other ties used to secure the components within the shelter.
- (7) For instructions on uncrating and unpacking the power unit and Trailer K-52, refer to TM 11-904.

18. Checking Unpacked Equipment

Check the equipment against the packing list. When no packing list accompanies the equipment, the repair parts and special tools list (app II) may be used as a general check to indicate the equipment which *probably* was packed. However, the absence of minor components which do not affect the functioning of the equipment need not prevent the equipment from being used.

19. Siting

a. General. The shelter of the radio set may be installed on the ground or in a 2½-ton truck. The specific situation and local conditions will indicate the general area where this set is to be used. When locating the radio set within the general area, consider the following:

- (1) The need to place the radio set where the shelter cannot be seen, the terrain, and the necessity for easy access to messenger service.
- (2) If possible, select a firm, level, and well-drained area that will reduce the danger of bogging down the truck and trailer wheels.
- (3) Avoid locating the radio set near sources of electrical interference such as power lines, radar sets, and field hospitals.
- (4) The distance from the remote control unit must be no more than 1 mile.
- (5) Enough area for doublet antennas (b(3) below) is required.

b. Antennas. Refer to TM 11-486-6, Electrical Communication Systems Engineering, Radio, for planning antenna lengths and locations.

- (1) Try several locations within the general area and select the one that provides the

best signals to and from the desired stations.

- (2) Determine whether the whip antennas or the antenna masts are to be used.
- (3) For space diversity operation, a clear area, suitable for the erection of two doublet receiving antennas, is required (par. 23). A doublet transmitting antenna can also be used.
- (4) Where a large number of radio sets are in operation, careful layout of the numerous antennas is necessary. Improper layouts will cause mutual interference between the various radio sets. This interference may be great enough to affect the intelligibility of the incoming signals. Mutual interference from nearby transmitters may be reduced by separating the receiving antennas from the transmitting antennas as much as possible. Other means of reducing the interference are as follows:
 - (a) Orient the antennas to take best advantage of their directional patterns.
 - (b) Select operating frequencies properly.
 - (c) Tune transmitters accurately.
 - (d) Align receivers accurately.
- (5) The effect of jamming (par. 42) may be reduced by locating the antenna so that nearby obstructions act as a screen in the direction of probable sites of enemy jamming transmitters. This screening action may also reduce the transmitted signal strength in a direction toward the enemy and thereby make it more difficult for the enemy to intercept the signals.

20. Tools and Equipment Required for Installation

a. No special tools are required for installation of the components of the radio set other than small hand tools such as wrenches, screw drivers, and hammers, that are supplied with each radio set.

b. A hoist, or crane, and heavy ropes or steel cable are required to lift the shelter onto a truck body (par. 21) when the radio set is to be used for mobile operation or to take it off the truck. When a crane or hoist is not available, Skid Equipment MX-157/U can be used.

c. Tape TL-83 (friction) is needed for keeping the connectors on the whip antennas tight and for tying some parts of the doublet antennas.

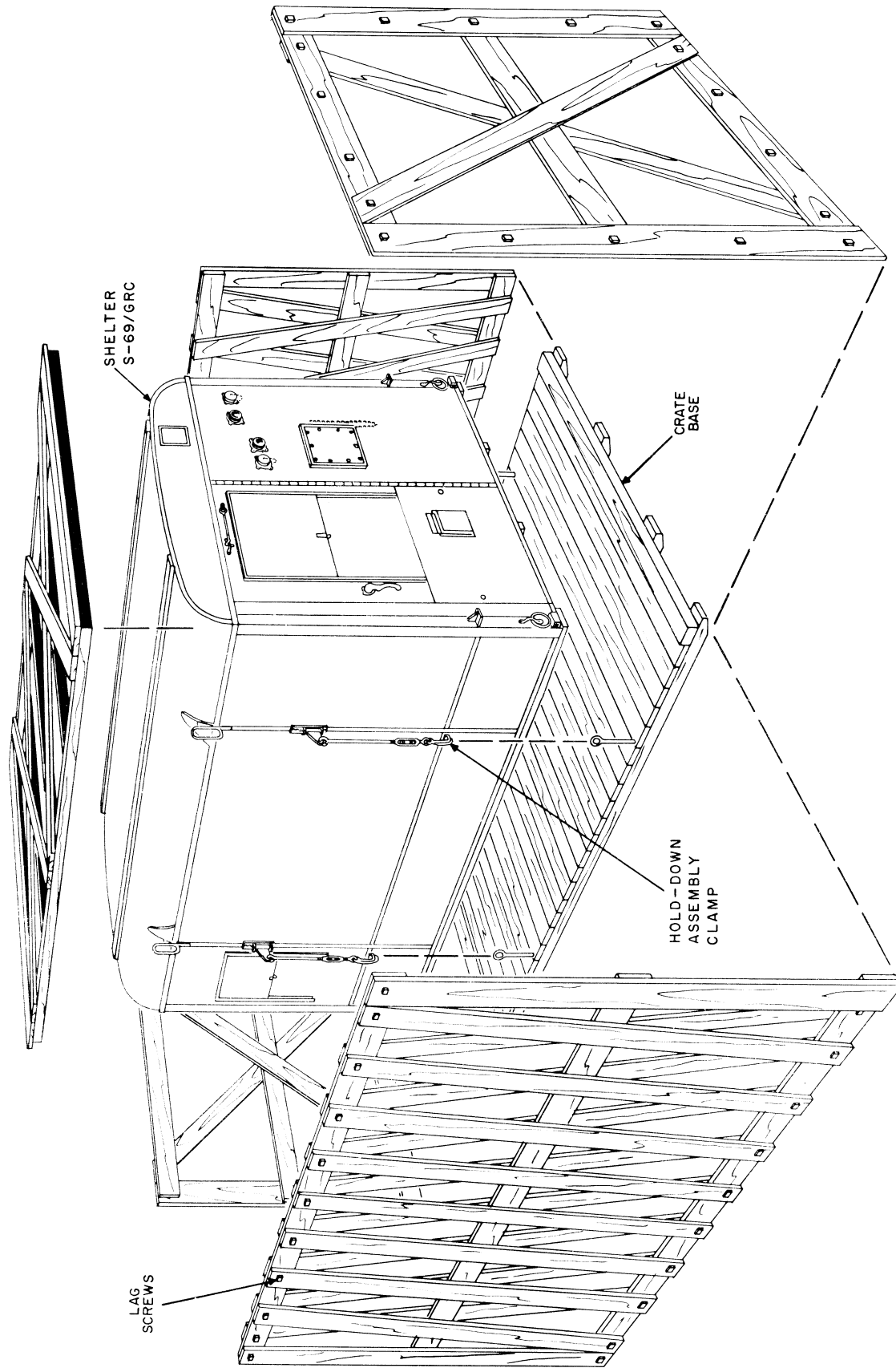

TM5820-202-10-11

Figure 11. Shelter S-69 GRC, showing shipping crate.



Figure 12. Radio Set AN/GRC-26(*) mounted on truck.

21. Installation of Shelter on Truck

If the radio set is to be used as a mobile station, the shelter should be installed on a 2½-ton, 6 x 6 cargo truck (fig. 12). Use the following procedure for setting up the radio set for mobile use.

a. Remove the canvas cover and side framing from the truck. Drop the tailgate.

b. With all equipment installed, the shelter weighs about 2½ tons. Obtain a hoist that is capable of lifting the shelter. Lift the shelter by its four lifting assemblies (fig. 5) and place it on the truck body with the entrance door toward the rear of the truck. If no hoist is available, use skids to slide the shelter onto the truck. Skid Equipment MX-157/U may be used for this purpose. Hook two wooden skids to the

rear of the truck body. Attach two ropes or steel cables to the shelter and feed them through the front gate of the truck, one on each side of the cab. Attach the other ends of the ropes or cables to a second truck and pull the shelter up the skids. If a second truck is not available, the winch on the truck that will carry the shelter may be used by attaching a pulley to a nearby tree and running the cable back through the front gate of the truck body.

c. To hold the shelter firmly in place, attach the clamps of the hold-down assemblies on the shelter to the sides of the truck body. If the cargo truck has a wooden platform, secure the shelter by means of the four anchor rings (fig. 5).

d. Couple the power unit trailer to the rear of the truck.

Section II. INSTALLATION OF ANTENNAS

22. Installation of Whip Antennas

The antenna bracket assemblies, mast bases, and whip antennas are disassembled and stowed within the shelter during shipment of the radio set. Remove the antenna bracket assemblies from the cartons. Be careful not to lose the mounting hardware stored in the attached cloth bags.

a. *Mounting Receiving Antenna Mast Bases MP-65-(*) and Mast Brackets MP-50-A.*

- (1) Remove the three feedthrough receptacles (fig. 13) (provided with gasketed covers) mounted on the front end of the shelter.
- (2) Mount Mast Bracket MP-50-A backed with a wood spacer around each feedthrough receptacle. Use the nuts and bolts provided. Replace the feedthrough receptacle cover on the middle feedthrough receptacle.
- (3) For radio sets provided with Mast Base MP-65-B, mount it on Mast Bracket MP-50-A (fig. 13) as follows:
 - (a) Place a neoprene washer on the top and bottom of the bracket and locate the metal ring, with braid and clamp attached, between the bottom washer and the bracket.
 - (b) Place the neoprene gasket between the feed through receptacle and the mast bracket.

(c) Secure the feedthrough receptacle to the mast bracket.

(d) Place the clamp around the coaxial cable connector after the cable has been connected to the antenna connector.

- (4) For radio sets provided with Mast Base MP-65-C, mount it on Mast Bracket MP-50-A as follows:

(a) Remove the body of the mast base from the upper insulator and mount the body of the mast base in the phenolic washer of Adapter Kit M-459 (fig. 15).

(b) Mount the remainder of Adapter Kit M-459 on Mast Bracket MP-50-A ((3)(a)-(d) above).

b. *Transmitting Antenna Mast Base MP-47-A and Bracket MT-657/GRC.*

(1) Mount Bracket MT-657/GRC (fig. 5) at the rear of the shelter. Use the hardware provided.

(2) Apply the calking compound, furnished in a metal tube, around the bracket and housing mounting holes.

(3) Mount Mast Base MP-47-A on Bracket MT-657/GRC; use the bolts and nuts provided (fig. 16).

c. *Assembly of Receiving Whip Antenna.* Select the following items from the storage cabinet (fig. 2). Assemble and mount the receiving whip

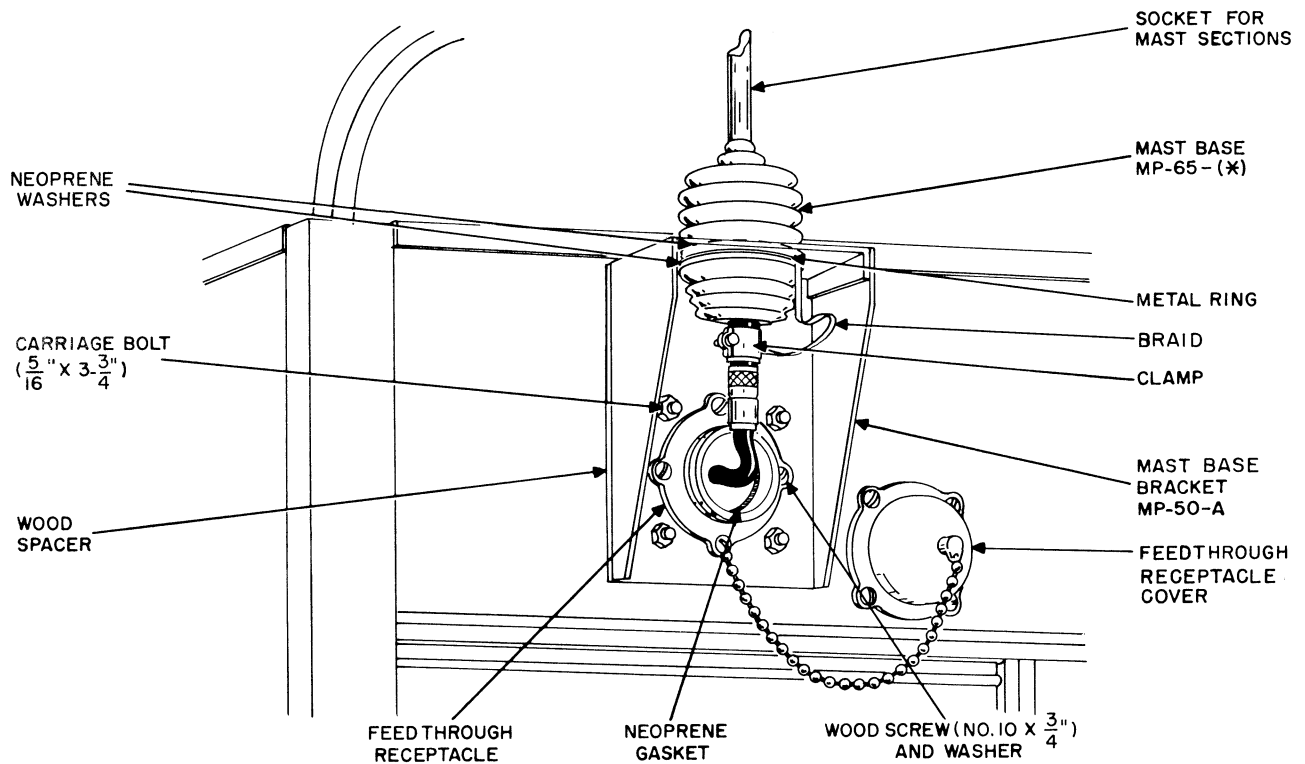

TM5820-202-10-13

Figure 13. Assembly of Mast Bracket MP-50-A and Mast Base MP-65-B, for receiving whip antenna.

antennas when required (pars. 33a and b, or 36a(1)).

- 4 Mast Section MS-116-A
- 2 Mast Section MS-117-A
- 2 Mast Section MS-118-A
- 2 receiving antenna hold-down guys

Assemble the receiving whip antenna as follows:

- (1) Screw one Mast Section MS-116-A into another Mast Section MS-116-A.
- (2) Screw one Mast Section MS-118-A into Mast Section MS-117-A.
- (3) Screw the two assembled sections ((1) and (2) above) together.
- (4) Screw the bottom Mast Section MS-116-A into Mast Base MP-65-(*) on the left front corner of the shelter.
- (5) Make certain that all the mast sections connections are tight; tape them with friction tape.
- (6) Assemble another receiving antenna. Repeat the procedures given in (1) through (5) above. Screw the set into Mast Base MP-65-(*) on the right front corner of the shelter.
- (7) If the radio set is to operate mounted on a truck, attach the receiving antenna hold-

down guys, one for each antenna, at the junction of the third and fourth sections. Pull each antenna down to a forward horizontal position and secure the other end of the guy to the headlight grill of the truck (fig. 12).

d. *Assembly of Transmitting Whip Antenna.* Select the following items from the storage cabinet (fig. 2):

- 1 Mast Section MS-49, MS-50, MS-51, MS-52, and MS-53.

1 transmitting antenna hold-down guy.

Assemble the transmitting antenna as follows:

- (1) Screw the mast sections together in the following sequence: MS-53, MS-52, MS-51, MS-50, MS-49 (top).
- (2) Screw Mast Section MS-53 into Mast Base MP-47-A.
- (3) Make certain that all mast sections connections of the antenna are tight; tape them with friction tape.
- (4) If the radio set is to operate mounted on a truck, attach the transmitting antenna hold-down guy to the top of Mast Section MS-51. Pull the antenna down to the trailer and attach the other end of the guy to the trailer (fig. 12).

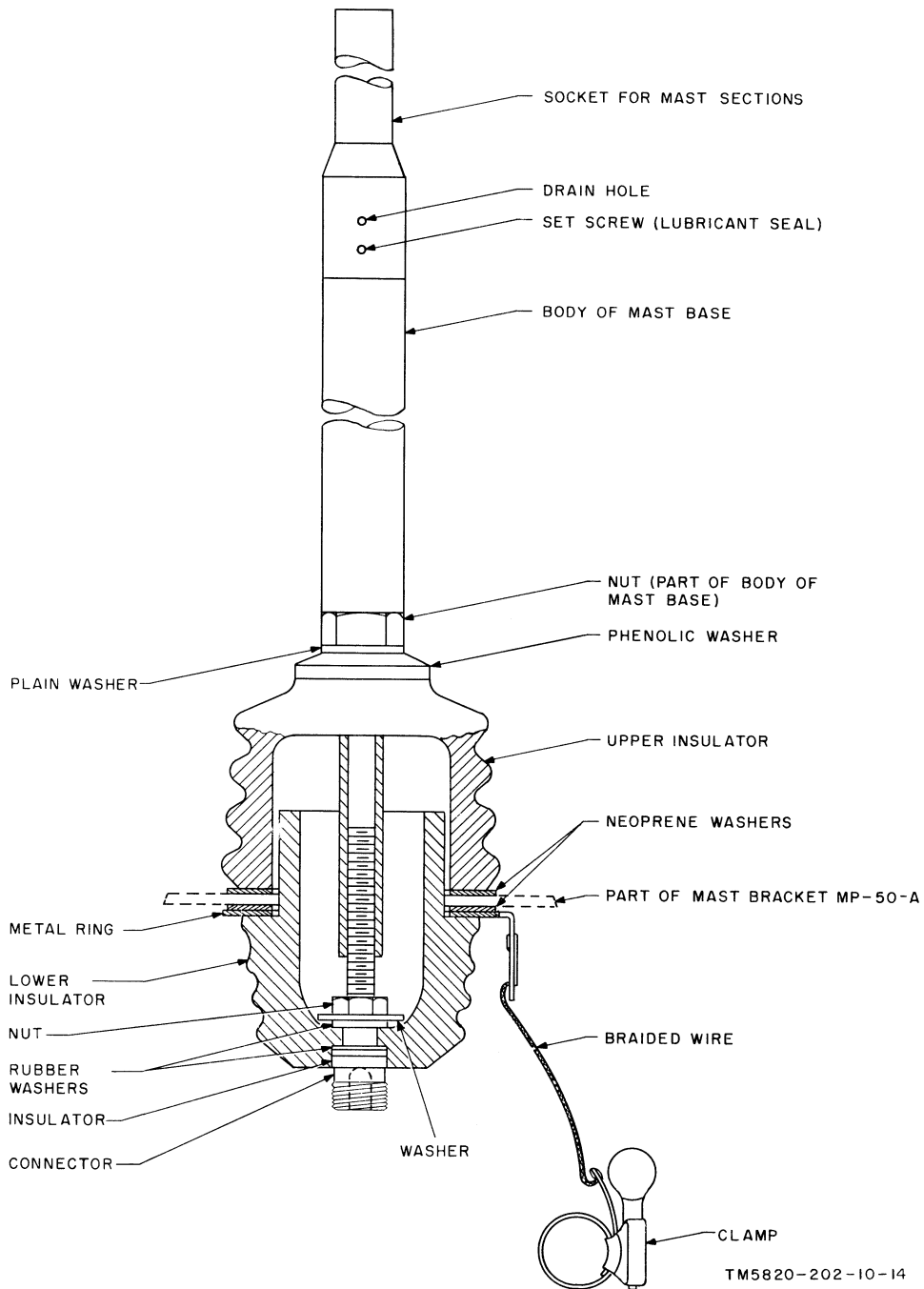
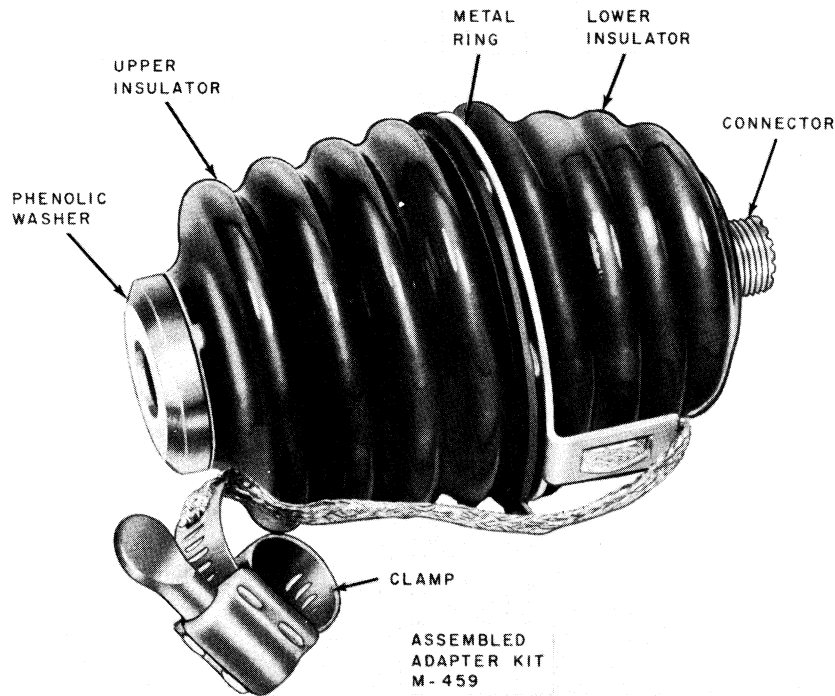

Figure 14. Assembly of Mast Base MP-65-B.

23. Location of Doublet Antennas

A desirable arrangement of the doublet antennas and the shelter is shown in figure 17. The space diversity receiving antennas should be installed as far apart as the antenna cables and terrain permit. If the terrain is such that the receiving antennas cannot be separated by at least 600 feet, estimate the distance for three wave lengths of the

fundamental frequency being used and place the receiving antennas this far apart. Do not place the receiving antennas in line (end to end). Do not install them directly in front of or behind the transmitting antenna or directly in front of each other. The 75-foot transmitter coaxial cable limits the distance that the shelter may be located from the center of the transmitting antenna to



TM 5820-202-10-15

Figure 15. Adapter Kit M-459.

about 30 feet. Refer to TM 11-486-6 for antenna grouping considerations. For each receiving antenna, it is desirable to have a clear level area, the size of which is determined by the operating frequency. At 2 mc, each antenna will require an area of 285 x 50 feet, the long dimension being perpendicular to the direction of reception. At 18 mc, each antenna will require an area of 80 x 50 feet. If a long-wire transmitting antenna is used, a level area of approximately 200 x 40 feet is needed. The center of the transmitting antenna should be approximately 25 feet from the shelter.

24. Installation of Doublet Antennas and Masts

Install the doublet antennas when required (pars. 33a and 36a(1)).

a. General.

- (1) A doublet type antenna is used for fixed and semifixed installations, and when greater directivity and signal pick-up of a doublet antenna are desired. The doublet antenna consists of two quarter-wave sections terminated at the center by a special coaxial cable connector.
- (2) Three Masts AB-155A/U (fig. 20) are required to support the antenna when it is

used for lower frequencies (approximately 2-4 mc). At higher frequencies (4-18 mc), the length of the antenna wire is short enough (less than 120 feet) to omit the center post and use only two supports.

- (3) The antenna wire is made up of sections of Wire W-1 separated by strain insulators. The sections are connected by jumpers which will allow preselection of various lengths for operation on different frequencies (fig. 19).
- (4) The erection of the doublet antenna generally follows the pattern given below.
 - (a) Determine the various frequencies expected to be used by the receivers and transmitter.
 - (b) Compute the antenna lengths (*b* below) based on whether the antenna will operate at the half-wave fundamental of the desired frequency or on any odd harmonic of the fundamental. The antenna is normally used on the half-wave fundamental wave length. Only when the antenna is used at its half-wave fundamental length, with regard to frequency, will the radiation pattern be broadside.

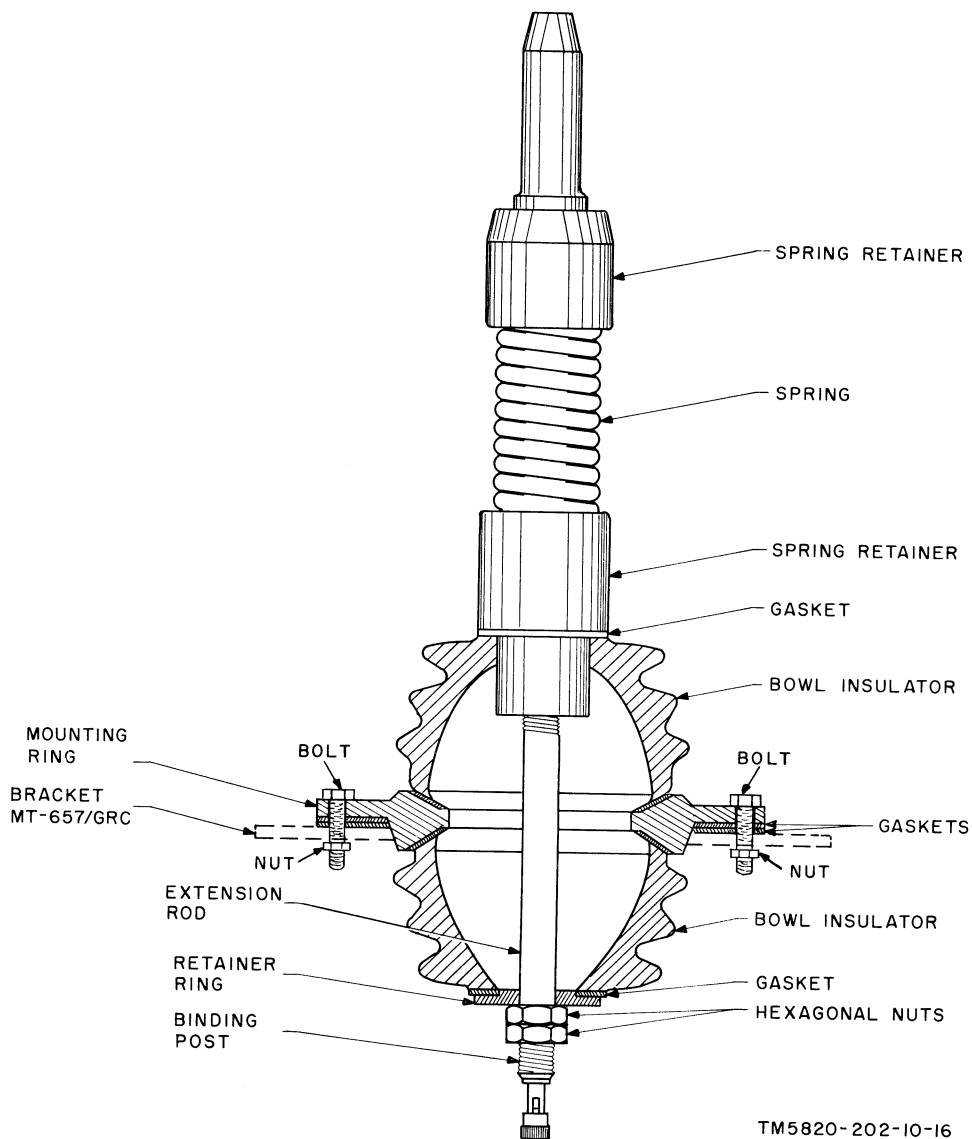

Figure 16. Assembly of Mast Base MP-47-A.

(c) Construct the desired lengths of the antenna; determine the position of the antenna orientation; assemble the masts at their exact location; raise the masts; and then pull the preconstructed antenna up to the top of the masts (c and d below).

b. *Determining Antenna Lengths.* Determine the frequencies to be used by the transmitter and receivers.

(1) Refer to figure 18 and compute the lengths desired for the various antenna sections as follows:

Example: Assume that operation is desired on frequencies of 2,500, 2,650, 2,900, and 3,900 kilocycles (kc).

- (2) Then, according to figure 18, these frequencies require antenna lengths of 187, 177, 161, and 120 feet respectively.
- (3) The formula for the length of a half-wave doublet antenna operating on fundamental frequency is as follows and may be used instead of the chart:

$$L = \frac{492 \times .95}{f}$$

where: L = length of antenna in feet
 f = frequency in mc

- (4) When radioteletypewriter and voice break-in is being used in net operation (pars. 36 and 37), the *transmitting antenna* is cut

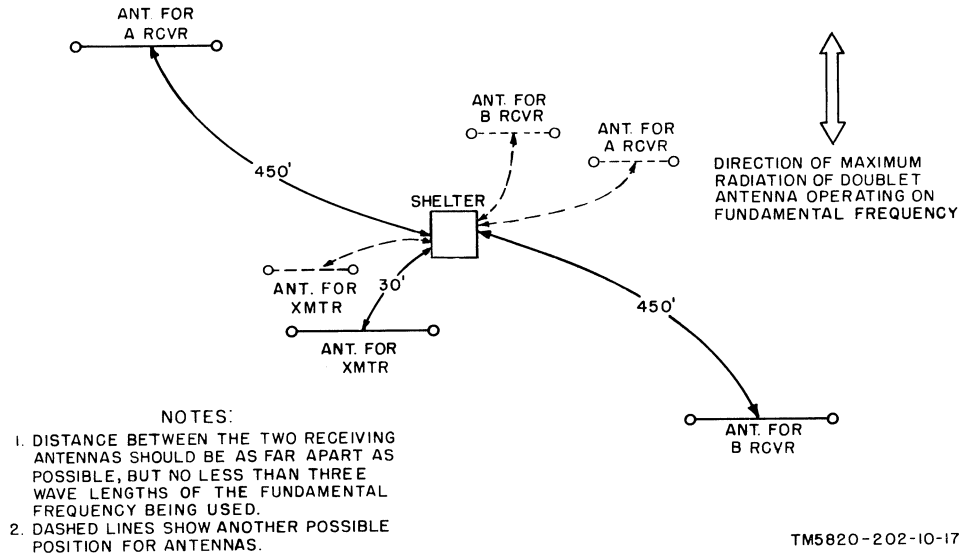

Figure 17. Typical arrangements of antennas and shelter for space diversity operation.

to the mean length between the RTT and the voice frequencies. One frequency is needed for RTT and simultaneous voice, and an adjacent frequency is necessary for break-in voice operation. The frequencies should have a minimum separation of 100 kc and a maximum separation of 500 kc. The length of the antenna for the fundamental frequency is computed from the following formula:

$$L = \frac{234}{F} + \frac{234}{f}$$

where: L = length of antenna in feet
 F = RTT frequency in mc
 f = voice break-in frequency in mc

$$234 = \frac{492 \times .95}{2}$$

c. *Constructing Doublet Antenna* (fig. 19).

- (1) The shortest length of antenna must be constructed first. In the case of the above example (b(1) above), the shortest antenna is the 120-foot, 3,900-kc antenna. Determine the length of the quarter-wave antenna. In this example, a quarter-wave would be $\frac{120}{2} = 60$ feet. Use the steel measuring tape (100 ft) provided to measure the antenna.
- (2) Attach one end of the antenna wire to the coaxial connector (A, fig. 19); use a connector, Burndy type KS-15, and the

- wing nut on the coaxial connector ends (B, fig. 19). The coaxial connector terminates one end of RF Cable Assembly CG-557A/U. Attach the other end of the antenna wire to an insulator.
- (3) Construct the other half of the half-wave antenna in the same fashion, using the remaining terminal on the coaxial connector as the starting point.
- (4) Select the next shortest length of antenna required; in this case, the 161-foot, 2,900-kc antenna. Attach a piece of antenna wire to the unused end of the insulator of the 3,900-kc antenna already constructed. Allow enough free wire for a jumper connection. Determine the quarter-wave length for 2,900 kc: $\frac{161}{2} = 80.5$ feet. Run enough wire to bring the total length of one side of the antenna to 80.5 feet as measured from the center of the coaxial connector to the end of the antenna. Include the length of the conductors in this measurement. Construct the other half of the half-wave antenna in the same manner.
- (5) Construct each additional lower-frequency antenna by adding more wire to the antenna already formed. Each antenna length is measured from the center of the coaxial connector to the end of the antenna being constructed; include the length of the insulators in the measurements.

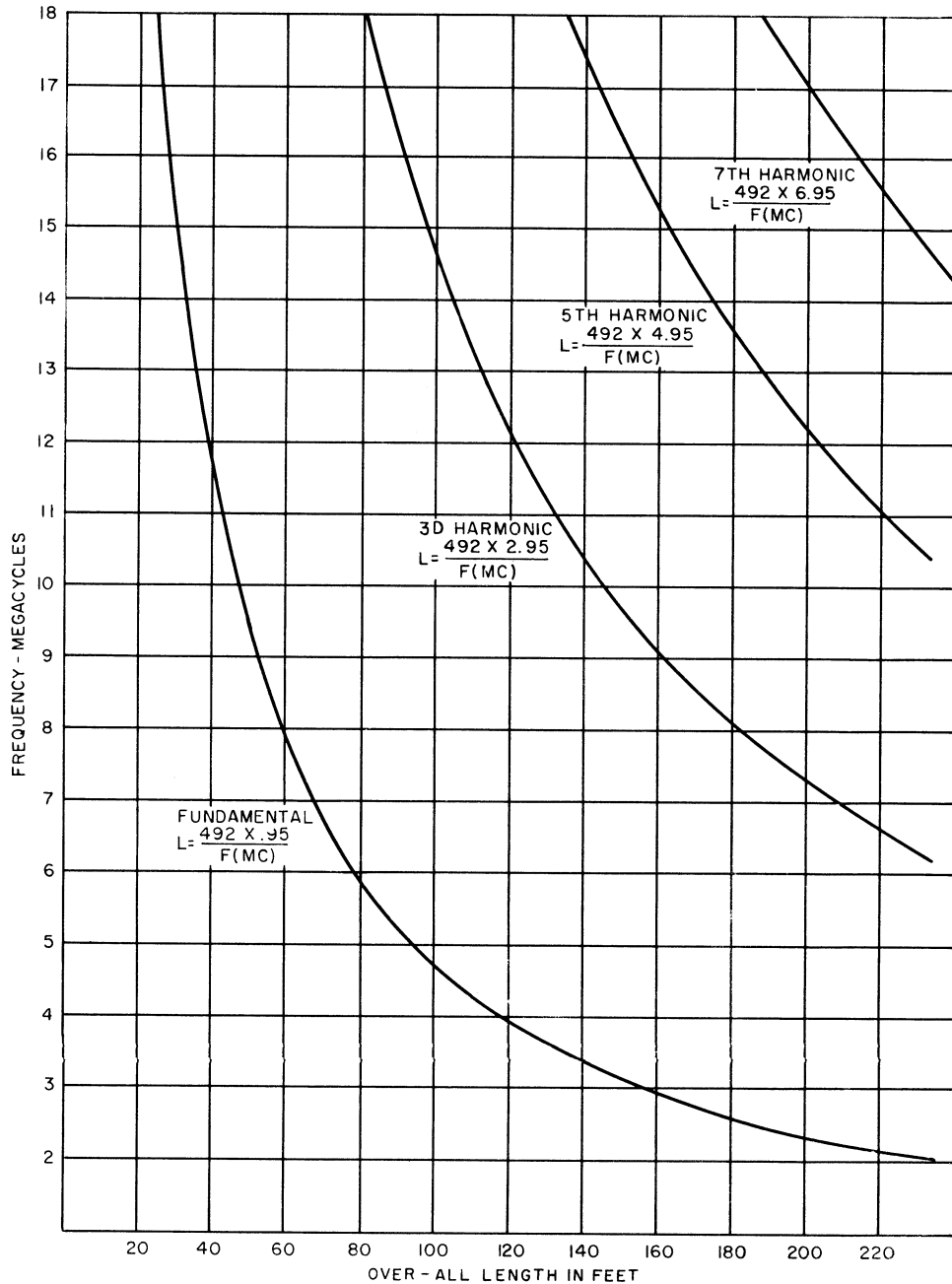

Figure 18. Graph of antenna wave length versus frequency.

(6) After the desired lengths have been determined and constructed, connect each jumper in its place by using a connector, Burndy type KS-90 (C, fig. 19). Each antenna will operate on the fundamental and odd harmonics of the frequency to which it is cut. An antenna constructed as described (D, fig. 19) will be the correct length for the following frequencies:

Fundamental (kc)	Third harmonic (kc)	Fifth harmonic (kc)
2,500	7,500	12,500
2,650	7,950	13,250
2,900	8,700	14,500
3,900	11,700	19,500

Note. Refer to fig. 18 to calculate harmonics versus length of antenna wire.

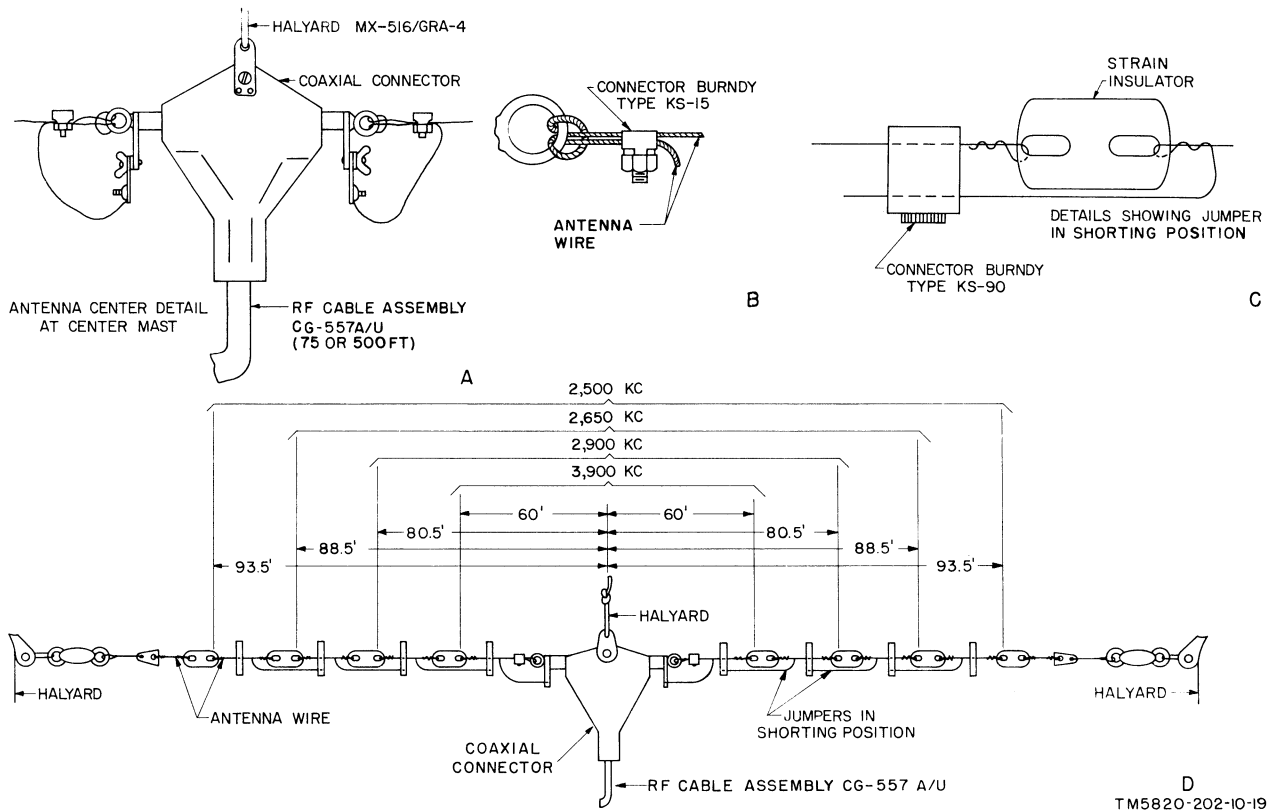

Figure 19. Construction and assembly of doublet antenna.

d. Erecting Antenna Masts. After the antenna wire has been constructed (c above), determine the location and position of the antenna to be erected (par. 19). Only when the antenna is used at its fundamental wave length will the radiation pattern be broadside. Use the compass (par. 13j) for accurate determination of the antenna orientation.

- (1) Stretch the fabricated antenna along the ground in the desired position. Place the end masts several feet beyond the end insulators. The center mast should be at the coaxial connector and offset 3 feet from the line between the two end masts (fig. 22) so that the antenna will clear the center mast. For the transmitting antenna, place the center mast within 30 feet of the shelter to allow for proper connection of RF Cable Assembly CG-557A/U (75 ft long). Tape the RF cable assembly to the center mast to relieve the strain on the coaxial connector. A center mast will not be required if the antenna is less than 120 feet, in which case only the two end masts will be used.

- (2) Place Mast AB-155A/U at each mast location and remove the canvas cover from Carrying Device MX-387/GRA-4 (fig. 6). Drive the stake of Mast Base AB-154/U into the ground at the desired mast location, with the swivel end of the mast base pointing 45° from the line of the antenna (fig. 20). If the ground is soft or sandy, place the mast base plate (fig. 22) on the ground and push it down firmly. Then drive the stake of Mast Base AB-154/U through the hole in the mast base plate.
- (3) Align the female ends of Mast Sections MS-44 toward the mast base. Connect the first three sections and place Guy Plate MX-378/U over the third section. Connect the next two sections and add another guy plate. Add three more mast sections and place a third guy plate over the last section.
- (4) For this procedure, use four Guy Fasteners MX-379/U and four guy stakes (fig. 20). Slip a guy fastener over each stake before it is driven into the ground.

Drive a guy stake (back guy stake) as close as possible to the junction of the fifth and sixth mast sections (25 ft. from base). Use a guy rope to measure 25 feet between the mast base and the front and side guy stakes. Place them 90° apart as shown in figure 20. If the ground is soft and sandy, use the wooden stakes instead of the metal stakes, and omit Guy Fasteners MX-379/U. In this case, the guys should be looped over the stakes.

- (5) Four each of the following guys (fig. 6) are required.

Item	Identification	Length (ft)
Guy MX-381/GRA-4...	White tag—center guy	40
Guy MX-382/GRA-4...	Blue tag—lower guy	31
Guy MX-383/GRA-4...	Red tag—upper guy	50

- (6) Fasten the four 50-foot guys (Guy MX-383/GRA-4) to top Guy Plate MX-378/U (fig. 22), the four 40-foot guys (Guy MX-381/GRA-4) to the center guy plate, and the remaining four 31-foot guys (Guy MX-382/GRA-4) to the bottom guy plate. The guys are fastened by snapping the fastener at the end of each guy into one of the four holes located 90° apart on the guy plate. Carry the free ends of the three back guys to a side guy stake (fig. 20) to measure their correct length. Fasten these guys to the back guy stake with Guy Fastener MX-379/U. Connect both sets of side guys to their respective guy stake, and remove slack by adjusting Slide Fastener FT-9. Do not tighten too much or the mast may bend. Keep the three front guys together and stretch them along the mast toward the front guy stake.
- (7) Attach the snap fastener Halyard MX-516/GRA-4 (fig. 6) on the pulley to the unused hole in the top guy plate. Slip the halyard rope through the pulley (fig. 22) and tie the free end of the rope near the mast base to keep the rope from running through the pulley when erecting the mast.

- (8) Assemble the additional masts by repeating the procedures given in (1) through (7) above.
- (9) If the center mast is used, attach the fastener assembly on the halyard to the center coaxial connector on RF Cable Assembly CG-557A/U (fig. 22).
- (10) Fasten the halyard on each end mast to the antenna wire by attaching one end of a wire (approximately 15 in. of Wire W-1) to the end insulator and the other end to the fastener assembly of the halyard.
- (11) Three men are required to raise a mast (fig. 21). One man (B) takes a position at the mast base. Another man (A) pulls the front guys and halyard. The third man (C) stands near the top of the mast. Perform the following procedures simultaneously until the mast is raised to a vertical position:
- A pulls steadily on the front guys, keeping slightly more tension on the top guy to bow the mast slightly.
 - C continues raising the mast while walking toward the mast base.
 - B holds the bottom of the mast in the desired position.
 - A connects the front guys to the front stake and adjusts the guys, removing slack by adjusting Slide Fasteners FT-9 (fig. 20).
- (12) Adjust all guys until the mast is vertical. Whenever a guy is tightened, the opposite one may have to be loosened slightly to keep the mast from bowing.
- (13) Raise the remaining masts by following the procedures given in (10) through (12) above.
- (14) After all the masts are erected, pull the antenna wire into position by means of the halyards. Tie each halyard to the mast to prevent the weight of the antenna from pulling the loose end of the halyard back through the halyard pulley. Figure 22 shows a doublet antenna completely erected.
- (15) After the transmitting doublet antenna is completely erected, disconnect RF Cable Assembly CG-558/U (used in whip antenna operation) from connector SO-10 on the transmitter to the antenna ter-

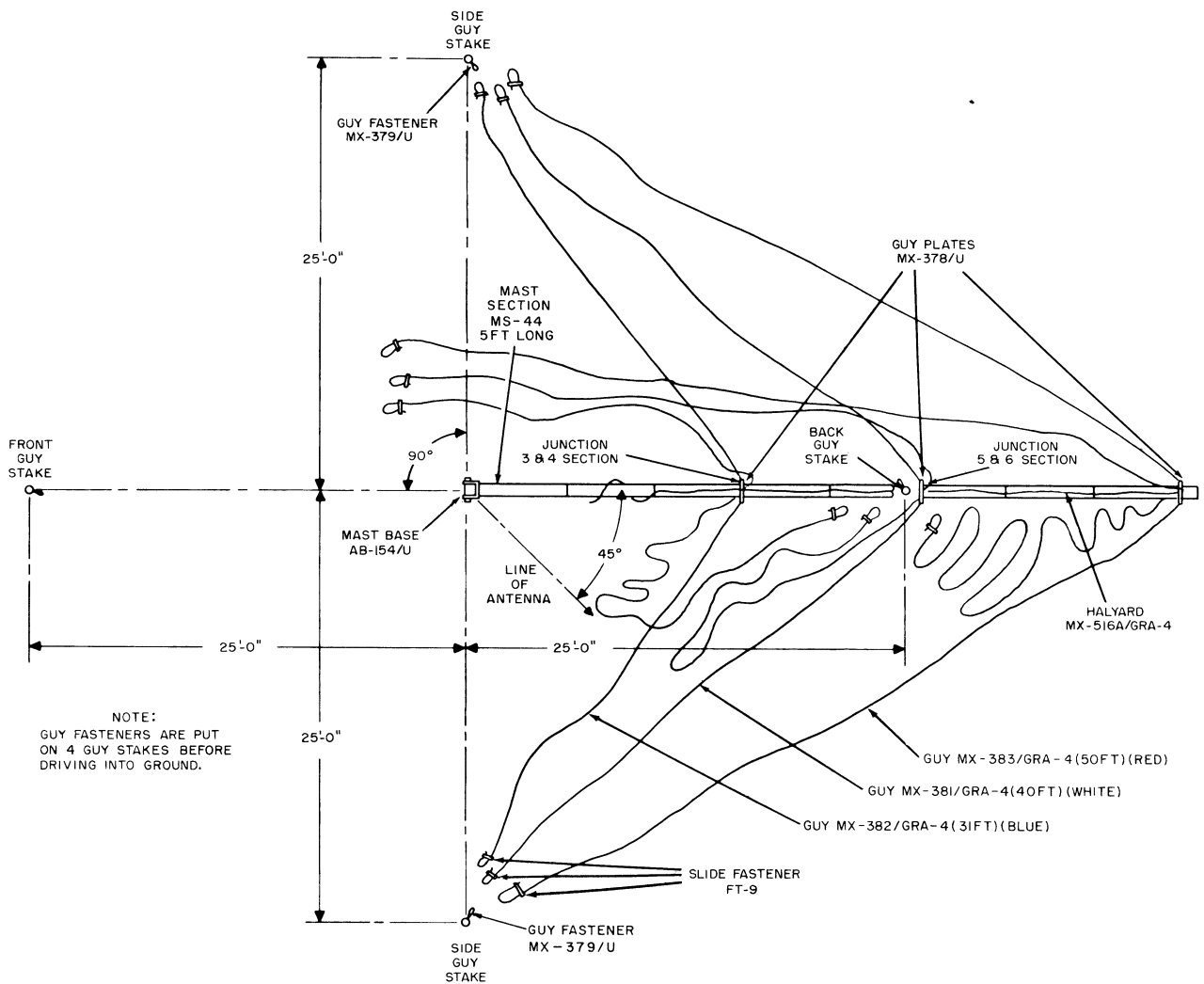

TM5820-202-10-20

Figure 20. Preparing antenna mast for erection.

minimal posts on the antenna tuning unit (figs. 23-25). On the transmitting antenna, pass the disconnected end of the antenna transmission line, the 75-foot RF Cable Assembly CG-557A/U through the feedthrough in the shelter wall and connect it to connector SO-10 on the transmitter; use right angle Adapter M-359 as a coupling.

Caution: The antenna lead-ins (RF Cable Assembly CG-557A/U) should be raised off the ground on poles. This prevents the lead-in from freezing to the ground, and, at all times, minimizes damage which may result from the lead-ins lying on the ground. The lead-in should be taped to both the mast and the shelter to relieve tension on the coaxial

connectors. The coaxial cable connector is structurally weak and should not be used as a support.

(16) After the receiving doublet antennas are completely erected, the lead-ins must be connected to the receivers by using one of the two methods described in (a) and (b) below.

(a) Disconnect Cords CG-67/MRQ-2 (used in whip antenna operation) from Mast Bases MP-65-(*) (figs. 23-25) and from Radio Receivers R-388/URR. Withdraw the ends of these cords into the shelter through each feedthrough receptacle. Pass one end of each RF Cable Assembly CG-557A/U (the 500-foot receiving antenna lead-in) through the feedthrough receptacles and con-

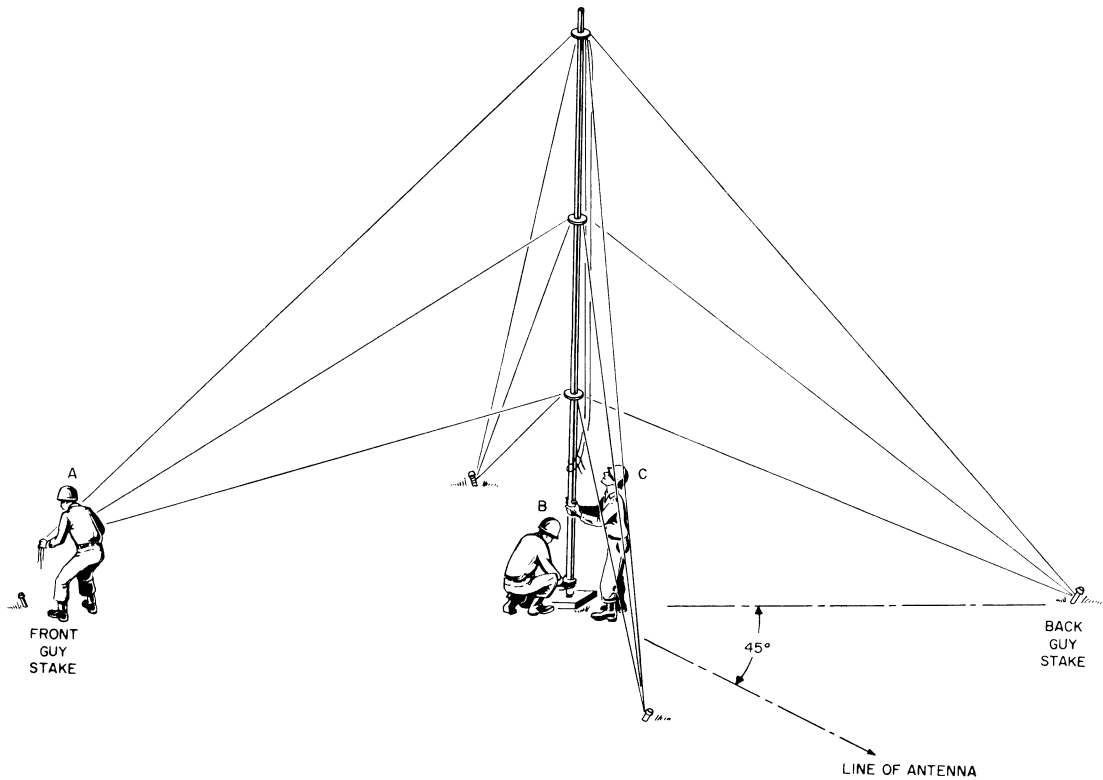
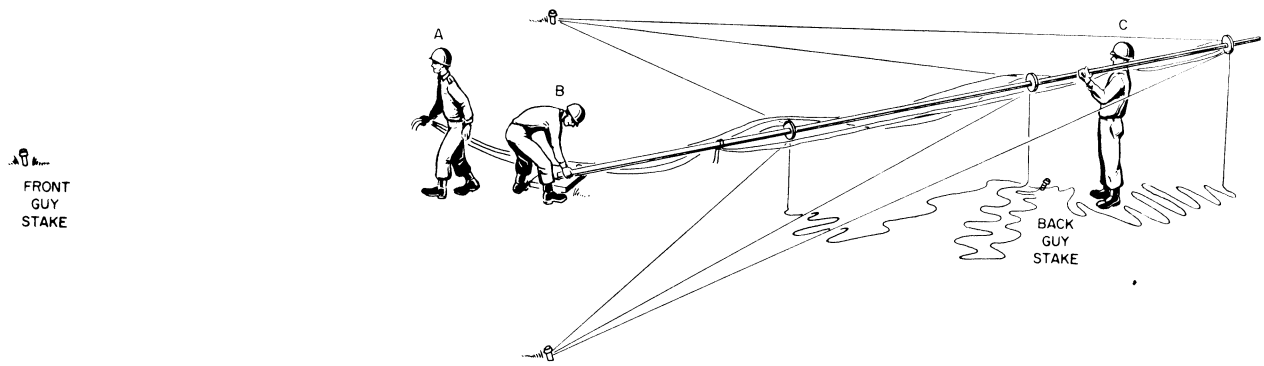

TM5820-202-10-21

Figure 21. Raising the assembled antenna mast.

nect the end of each to the ANTENNA connector on the rear of each receiver; use Adapter M-359 as a coupling.

- (b) Disconnect Cords CG-67/MRQ-2 from Mast Bases MP-65-(*) figs. (23-25) (but not from the receivers) and withdraw the ends of these cords through each feed-through receptacle. Connect Plug PL-258 to the free end of this cord. Pass one end of each RF Cable Assem-

bly CG-557A/U (500 feet) through each feedthrough receptacle and connect the cable to the other end of Plug PL-258. This method has been provided because of the limited space behind the radio receivers.

25. Other Antenna Installations

In all semifixed installations, when there is insufficient time for erection of the 40-foot masts

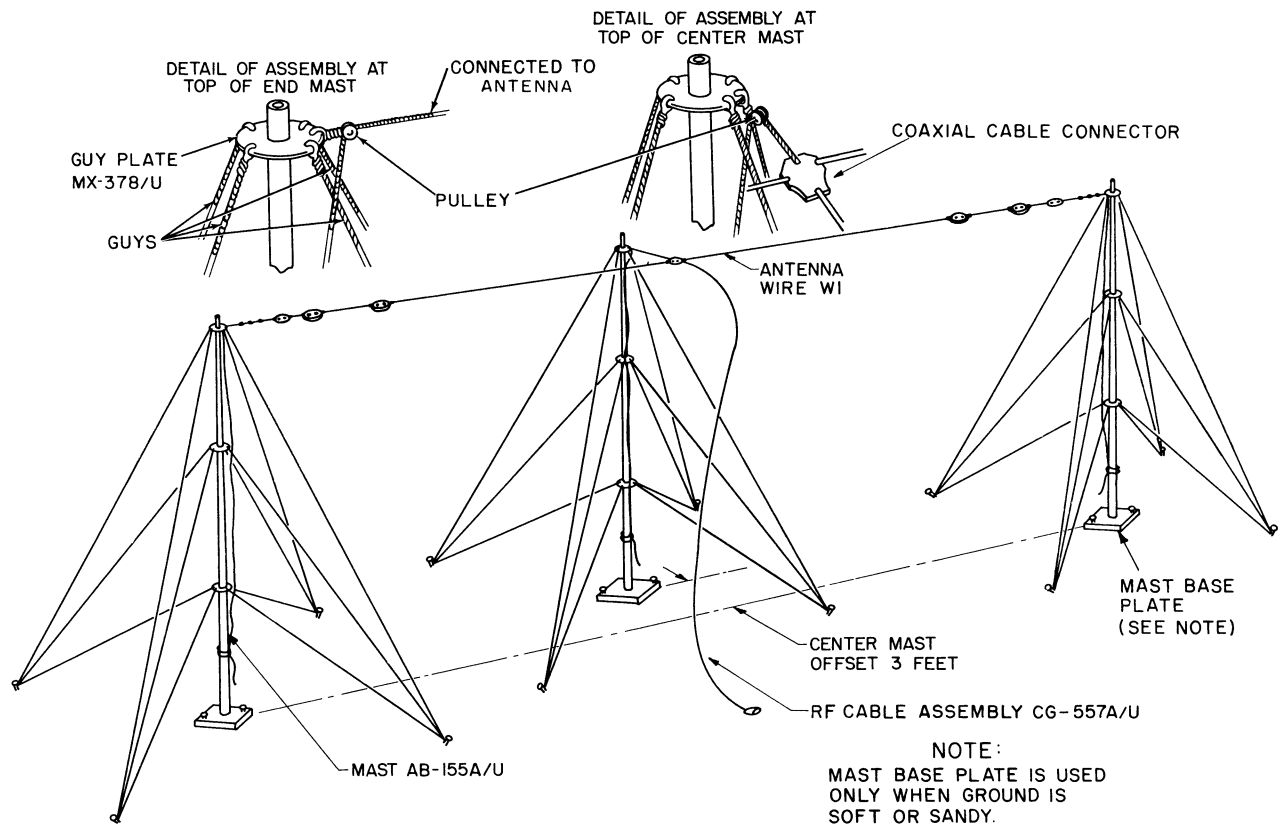

Figure 22. Doublet antenna erected.

(par. 24), the wooden lance poles (fig. 5) may be used to support the doublet antenna wire. The lance poles are put into the ground in the desired location and guyed with Rope RP-5 attached to the guy stakes (supplied with Mast AB-155A/U (fig. 6)). When greater height is desired, one of the lance poles may be fastened to the outside of

the shelter in a vertical position. In this case, the transmitting antenna may be located approximately 60 feet from the shelter. Various systems for erecting antennas may be improvised by using poles, trees, buildings, or other suitable supports. The doublet antenna must always be insulated from its supports.

Section III. CONNECTIONS AND INSTALLATIONS

26. Connections

(figs. 23-26)

a. Power Connections. The ac power outlet boxes for operating the components of the radio set are wired permanently in the shelter. When Power Unit PE-95-(*) is used as power source, connect Power Cable Assembly CX-1165/U be-

tween the shelter power receptacle (fig. 5) and ac outlet nuts on the PE-95-(*). When the power unit is some distance from the shelter, insert extension Power Cable Assembly CX-1166/U between Power Cable Assembly CX-1165/U and the shelter power receptacle. The following chart contains a list of the connections of the power cords.

Item No.	Cable or cord	From		To	
		Component	Receptacle designation	Component	Receptacle designation
1	Cord CD-763	Transmitter	SO-6	Ac outlet box	Ac outlet.
2	Power cord	Blower		Ac outlet box	
3	Cord CX-962/TRA-7	Frequency shift exciter	Ac supply	Ac outlet box	
4	Cord CX-959/TRA-7	Teletypewriter control unit.	J15	Ac outlet box	
5	Power cord	Reperforator (TT-56/MGC ^a TT-76/GGC ^b).		RA-87-(*)	
6	Power cords	Teletypewriters (left and right).		Ac outlet box	
7	Power cord	Rectifier RA-87-(*)		Ac outlet box	
8	Power cord (dc)	Reperforator		Connection box or reperforator.	
9	Power Cable Assembly CX-1208/U.	Radio set control	RA-87-115V ac	Ac ^a	
10	Power cord	Remote switching control (when used).		Ac outlet box ^c	
11	Power cords	Receivers (channel A and B).		Ac power source	
12	Cord CX-954/TRA-7	Frequency shift converter.	J104	Ac outlet box ^d	
13	Extension power cable	Frequency shift converter.	P107	Power terminal strip in cabinet. ^e	
14	Power cord	Heater		Ac outlet box	
15	Power cord	Electrical Equipment Cabinet CY-1216/U. ^e	Power outlet terminal strip.	Ac outlet box	
16	Power cord	Blower assembly on CY-1216/U. ^e		Power outlet terminal strip in cabinet. ^e	

^a Radio Sets AN/GRC-26A and AN/GRC-26B.

^b Radio Set AN/GRC-26C.

^c Radio Sets AN/GRC-26B and AN/GRC-26C.

^d Radio Set AN/GRC-26A.

b. Component Interconnections. The following chart lists the interconnections between the components of the radio set.

Item No.	Cable or cord	From		To	
		Component	Connector designation	Component	Connector designation
1	Cord CG-67/MRQ-2	Mast Base MP-65-(*)	Connector (fig. 15).	Channel A receiver.	ANTENNA (J101), using Adapter M-359.
2	Cord CG-67/MRQ-2	Mast Base MP-65-(*)	Connector (fig. 15).	Channel B receiver.	ANTENNA (J101), using Adapter M-359.
3	RF Cable Assembly CG-557A/U (500 ft). ^a	Doublet receiving antenna.	Connector	Channel A receiver.	ANTENNA (J101), using Plug PL-258 (par. 24).
4	RF Cable Assembly CG-557A/U (500 ft). ^a	Doublet receiving antenna.	Connector	Channel B receiver.	ANTENNA (J101), using Plug PL-258 (par. 24).

See footnotes at end of table.

Item No.	Cable or cord	From		To	
		Component	Connector designation	Component	Connector designation
5	RF Cable Assembly CG-562/U.	Channel B receiver	IF OUTPUT	Frequency shift converter.	J102.
6	RF Cable Assembly CG-562/U.	Channel A receiver	IF OUTPUT	Frequency shift converter.	J101.
7	Electrical Power Cable Assembly CX-1939/U.	Channel A receiver	AUDIO, term. 600 and GND.	Loudspeaker LS-3.	Jack.
8	Electrical Power Cable Assembly CX-1939/U.	Channel B receiver	AUDIO, term. 600 and GND.	Loudspeaker LS-3.	Jack.
9	Special Purpose Cable Assembly CX-1150/U (red).	Power Supply PP-712/GRC-26A (tone oscillator).	J404	Teletypewriter control unit.	J10.
10	Special Purpose Cable Assembly CX-1151/U (blue).	Frequency shift converter.	J103	Radio set control	CV-182 J103.
11	Cord CD-307 (red)	Teletypewriter control unit.	J1	Left teletypewriter.	Plug (red).
12	Cord CD-307 (black)	Teletypewriter control unit.	J3	Left teletypewriter.	Plug (black).
13	Cord CD-307 (red)	Teletypewriter control unit.	J4	Right teletypewriter.	Plug (red).
14	Cord CD-307 (black)	Teletypewriter control unit.	J6	Right teletypewriter.	Plug (black).
15	Cord CX-961/TRA-7 (blue).	Teletypewriter control unit.	J12	Frequency shift exciter.	SEND AND CONTROL.
16	Cord CX-961/TRA-7 (red).	Teletypewriter control unit.	J13	Frequency shift exciter.	LOCAL C-W CONTROL.
17	Electrical Special Purpose Cable Assembly CX-1850/U.	Power Supply PP-712/GRC-26A.	P405	Frequency shift converter.	J106.
18	Electrical Special Purpose Cable Assembly CX-1851/U.	Power Supply PP-712/GRC-26A (tone oscillator).	J403	Channel B receiver.	REMOTE, term. 2 and 3.
19	Electrical Special Purpose Cable Assembly CX-1851/U.	Power Supply PP-712/GRC-26A (tone oscillator).	J402	Channel A receiver.	REMOTE, term. 2 and 3.
20	Special Purpose Cable Assembly CX-1120/U. ^b	Teletypewriter control unit.	J2	Reperforator connection box.	Any LOCAL OPERATION jack.
21	Cord CD-307 (gray) ^b	Teletypewriter control unit.	J5	Transmitter-distributor.	Plug.
22	Cord CD-307 (gray) ^c	Teletypewriter control unit.	J5	Reperforator (TT-76/GGC).	Plug PJ-055 (yellow).
23	Cord CD-307 (red)	Teletypewriter control unit.	J7	Reperforator	Plug (red).
24	Cord CD-307 (black)	Teletypewriter control unit.	J8	Reperforator	Plug (black).
25	Special Purpose Cable Assembly CX-1152/U.	Speech amplifier	TO JB-70	Radio set control	BC-614 SO 102.
26	Special Purpose Cable Assembly CX-2479/U.	Teletypewriter control unit.	J14	Radio set control	C-808 J14.
27	Special Purpose Cable Assembly CX-2480/U.	Teletypewriter control unit.	J11	Radio set control	C-808 J11.
28	Electrical Special Purpose Cable Assembly CX-1324/U.	Teletypewriter control unit.	FS KEYING	Radio set control	C-808 FS KEYING.

See footnotes at end of table.

Item No.	Cable or cord	From		To	
		Component	Connector designation	Component	Connector designation
29	Cord CG-389/U	Frequency shift exciter.	NORMAL (through Adapter UG-27/U).	Transmitter	Tuning unit crystal socket.
30	Electrical Special Purpose Cable Assembly CX-2481/U.	Radio set control	R-388 PHONES	Receiver (channel A or B).	PHONES (par. 34b).
31	Cord CD-764	Speech amplifier	TO BC-610	Transmitter	SO-5.
32	Special Purpose Cable Assembly CX-2482/U.	Speech amplifier	CARBON MIC. 1	Radio set control	BC-614 J102.
33	Wire W-128	Transmitting whip antenna.	Connector	Antenna tuning unit BC-939-(*).	Antenna terminal.
34	RF Cable Assembly CG-558/U (used for whip antenna). ^d	Antenna Tuning Unit BC-939-(*).	Input terminals	Transmitter	SO-10 through Adapter M-359.
35	RF Cable Assembly CG-557A/U (75 ft).	Doublet transmitting antenna.	Connector	Transmitter	SO-10.

^a Paragraph 24d(16).

^b Radio Sets AN/GRC-26A and AN/GRC-26B.

^c Radio Set AN/GRC-26C.

^d Paragraph 24d(15).

c. Grounding Connections (figs. 23-25).

- (1) For fixed or semifixed installations, ground the equipment in the shelter by driving Ground Rod GP-26 into the ground near the shelter. Connect a No. 7 AWG braid strap between the ground rod and the ground bus. For mobile operation, ground the shelter equipment by connecting the No. 7 AWG braid strap between the ground bus and a convenient bolt on the chassis of the truck.
- (2) Connect the following components to the ground bus with No. 7 AWG braid straps:
 - (a) Power circuit breaker.
 - (b) Transmitter (from a convenient screw on the transmitter case).
 - (c) GND terminal on the frequency shift exciter.
- (3) Connect the ground wire lug on the teletypewriter power cords to a screw on the ac outlet box.

d. Remote Control Connections (fig. 26).

- (1) Interconnect the remote control unit and the radio set control, using field wire or equivalent (A, fig. 26). Connect the ac plug to a source of 115 volts ac, 50-60

cps. Connect the telephone to the radio set control.

- (2) Insert the plugs from the teletypewriter equipment into the appropriate jacks on the remote control unit and connect the telephone to the unit.
 - (a) For one-way reversible operation, connect the equipment as shown in B or C, figure 26.
 - (b) For full-duplex operation, connect the equipment as shown in D or E, figure 26.

e. Test Prod Assembly Connection. To protect personnel from dangerous voltages in the transmitter (par. 33c), install the test prod assembly (grounding hook) (SB 11-254, Utilization of Test, Prod, Stock Number 3F3705-12.19 with Equipments T-368()/URT, BC-610(), AM-141()/MRC, AM-494()/GR, and AM-495()/GR) (FSN 6625-510-1814). Connect the grounding hook clamp to the frame of the transmitter or to the ground bus (figs. 23 through 25).

f. Other Connections. To communicate between the cab of the truck and the shelter, install one Telephone EE-8-(*) in the cab of the truck and one in the shelter. Cut a 15-foot length of Wire WD-1/TT from the roll. Connect one end of the

NOTES:

1. CONNECT POWER CABLE CX-1165/U TO POWER UNIT PE-95-(*) OR COMMERCIAL AC SOURCE, RATED 115V AC, 60 CPS, 5.4 KW.
2. AC OUTLET BOXES HAVE TWO CONTACT RECEPTACLES EXCEPT THE TWO 3-WIRE BOXES FURNISHING POWER TO THE REMOTE CONTROL UNIT, FS CONVERTER, AND FS EXCITER. THE THIRD WIRE (GREEN), ALSO USED IN THE LIGHTING FIXTURE WIRING, IS CONNECTED TO THE GROUND BUS THROUGH THE POWER CIRCUIT BREAKER.
3. THE CASES OF ALL TRANSMITTING, RECEIVING, AND OPERATING COMPONENTS ARE CONNECTED TO THE GROUND BUS THROUGH COPPER BRAID, ALTHOUGH NOT SHOWN IN DIAGRAM.
4. SOME RECEPTACLES AND MATING CONNECTORS ARE COLOR CODED TO FACILITATE MAKING PROPER CONNECTIONS.
5. WHEN DOUBLET RECEIVING ANTENNAS ARE USED, CORDS CG-67/MRQ-2 ARE REMOVED FROM MAST BASES MP-65-(*) AND ARE CONNECTED TO CORDS CG-557A/U (500FT) USING PLUGS PL-258.
6. WHEN DOUBLET TRANSMITTING ANTENNA IS USED, ANTENNA TUNING UNIT BC-939-(*) IS NOT USED AND CORD CG-557A/U (75 FT) FROM DOUBLET ANTENNA IS CONNECTED TO SOCKET SO-10 OF RADIO TRANSMITTER BC-610-(*).
7. THE FOLLOWING COMPONENTS ARE CONNECTED AS REQUIRED TO SPEECH AMPLIFIER BC-614-(*) AS FOLLOWS;

COMPONENT	CORD	CONNECTION DESIGNATION
MICROPHONE T-17-(*)	CORD CD-76	CARBON MIC. 1
MICROPHONE T-50		DYNAMIC MIC. 2
KEY J-45	CORD CD-201-A	KEY

8. HEADSET HS-30-(*) CONNECTS TO PHONES JACK OF FREQUENCY SHIFT EXCITER O-39-(*) OR FREQUENCY SHIFT CONVERTER CV-182-(*)/GRC-26A AS REQUIRED.
9. KEY J-45 CONNECTS TO CW KEYING JACK OF RADIO TELETYPEWRITER CONTROL C-808/GRC-26A AS REQUIRED.
10. EXTENSION POWER CABLE PLUG P107 FROM FREQUENCY SHIFT CONVERTER CV-182-(*)/GRC-26A CONNECTS TO CONNECTOR J301 ON POWER SUPPLY PP-712-(*)/GRC-26A.
11. CONNECTOR OF CG-390/U & CX-2481/U CONNECT TO PHONES JACK OF EITHER CHANNEL A OR CHANNEL B RADIO RECEIVER AS REQUIRED.
12. WIRES OF ELECTRICAL POWER CABLE ASSEMBLY CX-1939/U CONNECT TO TERMINALS 4 AND GND OF AUDIO TERMINAL STRIP
13. THE GROUND LEAD ON AC POWER CORDS OF TELETYPEWRITERS TT-4A/TG IS CONNECTED TO SCREW ON AC OUTLET BOX.
14. INDICATES EQUIPMENT MARKING.
15. RADIO SET CONTROL C-1306/GRA-14:

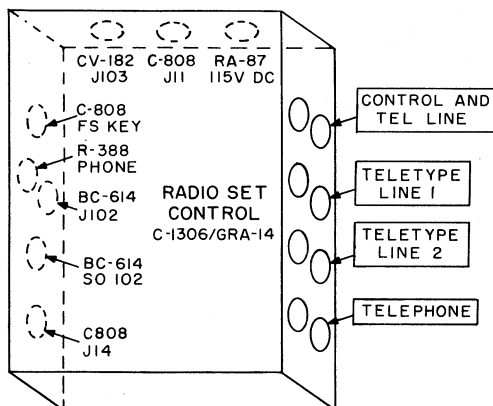

16. TELETYPEWRITER TT-55/MGC IS USED IN SOME RADIO SETS INSTEAD OF TELETYPEWRITER TT-4A/TG. CORD CONNECTIONS ARE SAME AS SHOWN.

ELECTRICAL POWER
CABLE ASSY
CX-1939/U (5 FT)
(NOTE 12)

POWER
CORDS

(NOTE 11)

ELECTRICAL POWER
CABLE ASSY
CX-1851/U (4 FT)

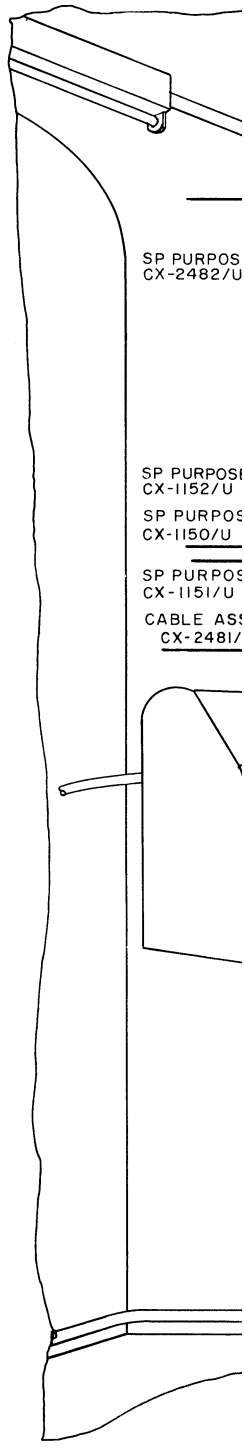
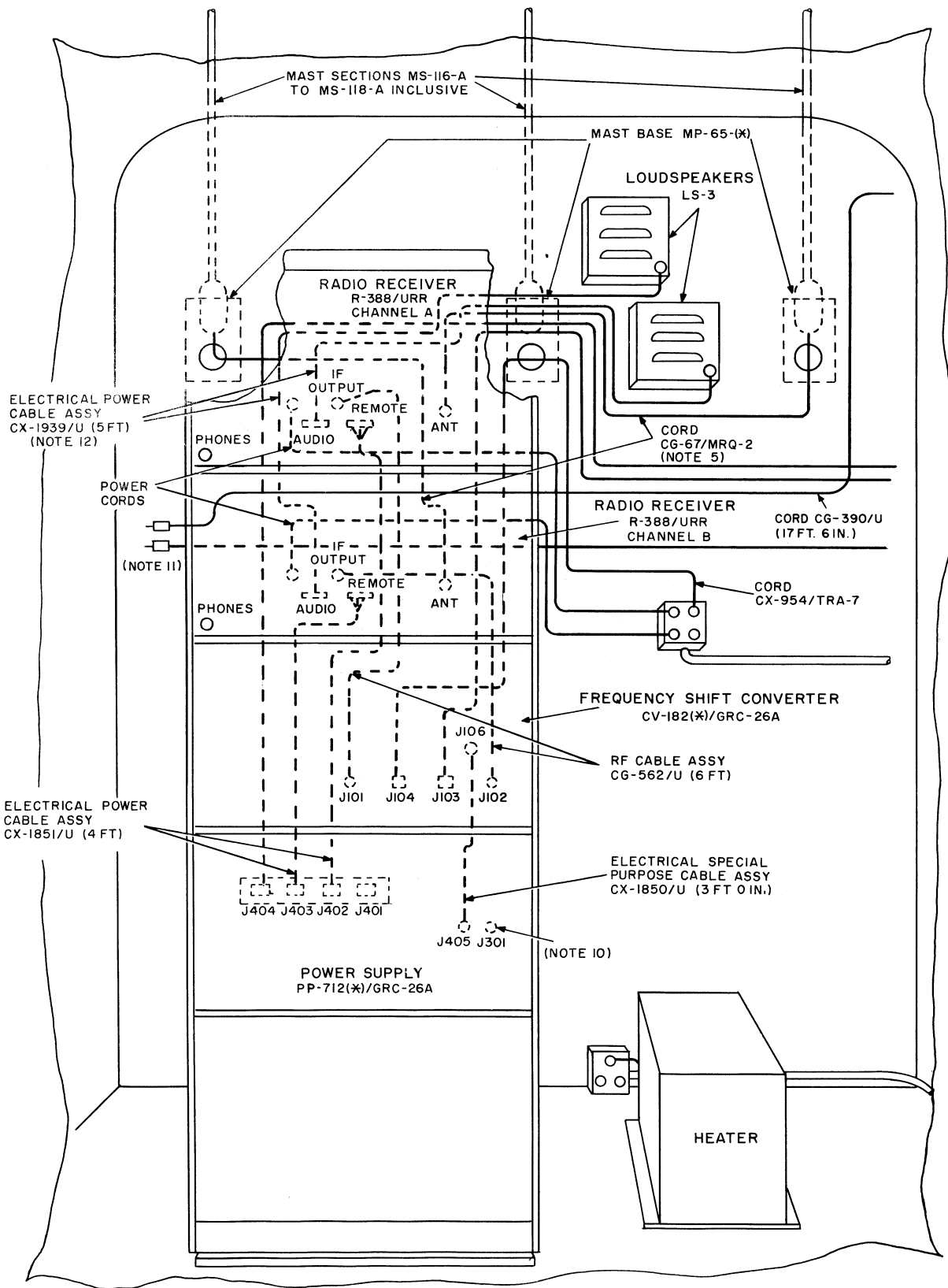

Figure 23. Radio Set AN/GRC

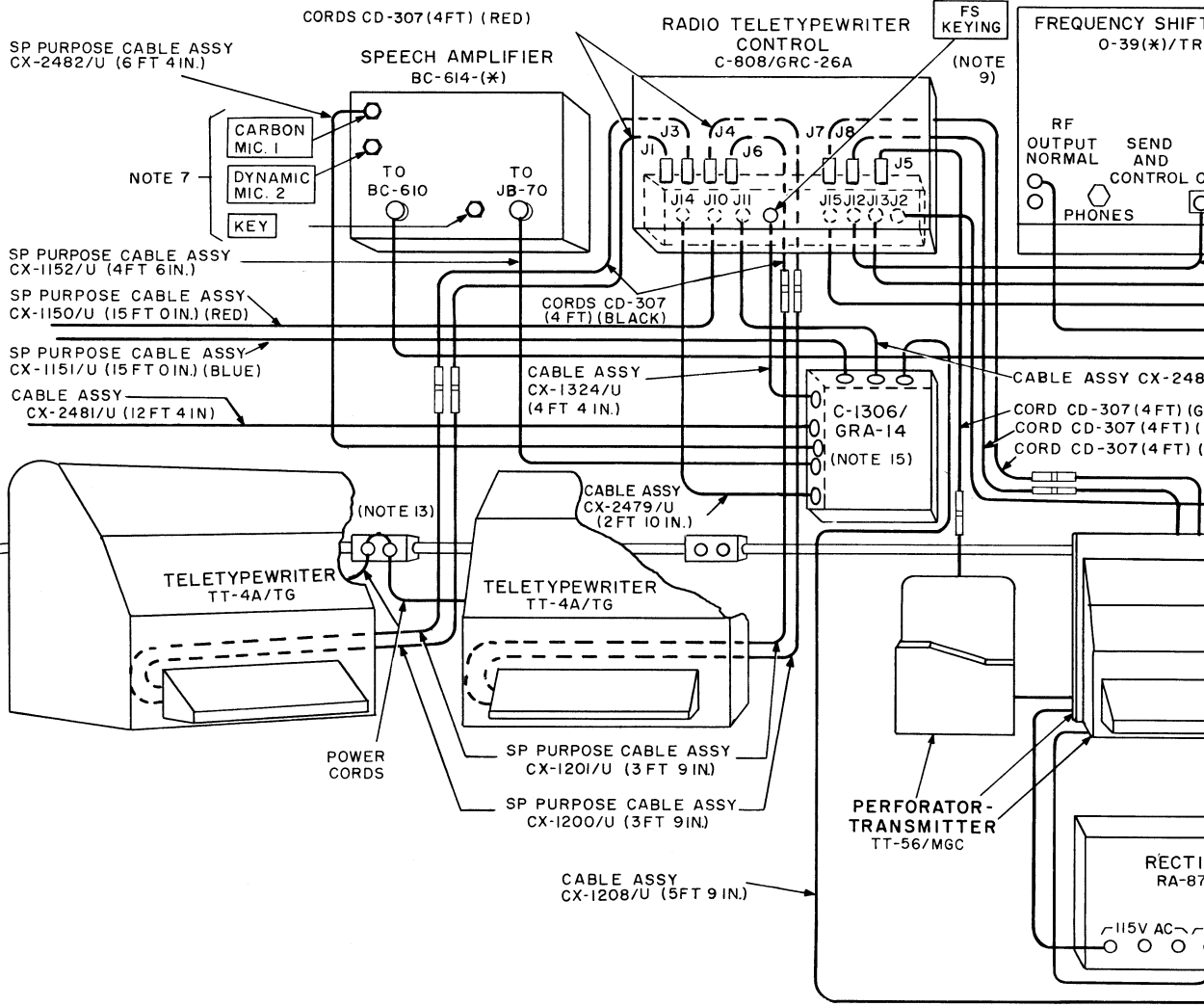
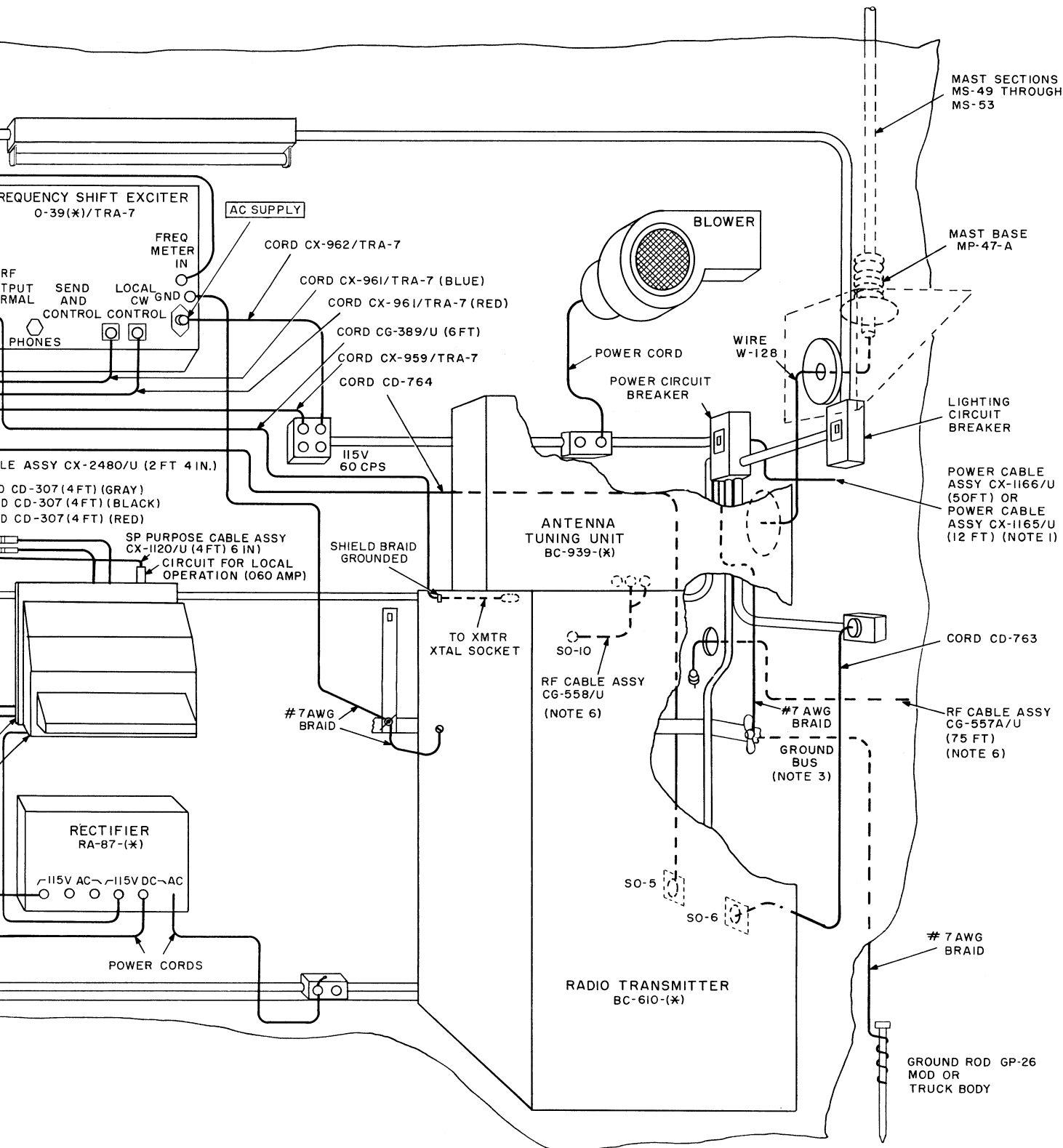

Figure 23. Radio Set AN/GRC-26A, cording diagram.



NOTES:

1. CONNECT POWER CABLE CX-1165/U TO POWER UNIT PE-95-(*) OR COMMERCIAL AC SOURCE, RATED 115V AC, 60 CPS, 5.4 KW.
2. AC OUTLET BOXES HAVE TWO CONTACT RECEPTACLES EXCEPT THE TWO 3-WIRE BOXES FURNISHING POWER TO THE REMOTE CONTROL UNIT, FS CONVERTER, AND FS EXCITER. THE THIRD WIRE (GREEN), ALSO USED IN THE LIGHTING FIXTURE WIRING, IS CONNECTED TO THE GROUND BUS THROUGH THE POWER CIRCUIT BREAKER.
3. THE CASES OF ALL TRANSMITTING, RECEIVING, AND OPERATING COMPONENTS ARE CONNECTED TO THE GROUND BUS THROUGH COPPER BRAID, ALTHOUGH NOT SHOWN IN DIAGRAM.
4. SOME RECEPTACLES AND MATING CONNECTORS ARE COLOR CODED TO FACILITATE MAKING PROPER CONNECTIONS.
5. WHEN DOUBLET RECEIVING ANTENNAS ARE USED, CORDS CG-67/MRQ-2 ARE REMOVED FROM MAST BASES MP-65-(*) AND ARE CONNECTED TO CORDS CG-557A/U (500FT) USING PLUGS PL-25B.
6. WHEN DOUBLET TRANSMITTING ANTENNA IS USED, ANTENNA TUNING UNIT BC-939-(*) IS NOT USED AND CORD CG-557A/U (7.5 FT) FROM DOUBLET ANTENNA IS CONNECTED TO SOCKET SO-10 OF RADIO TRANSMITTER BC-610-(*) .
7. THE FOLLOWING COMPONENTS ARE CONNECTED AS REQUIRED TO SPEECH AMPLIFIER BC-614-(*) AS FOLLOWS;

COMPONENT	CORD	CONNECTION DESIGNATION
MICROPHONE T-17-(*)	CORD CD-76	CARBON MIC. 1
MICROPHONE T-50		DYNAMIC MIC. 2
KEY J-45	CORD CD-201-A	KEY

8. HEADSET HS-30-(*) CONNECTS TO PHONES JACK OF FREQUENCY SHIFT EXCITER O-39-(*) OR FREQUENCY SHIFT CONVERTER CV-182-(*) AS REQUIRED.
9. KEY J-45 CONNECTS TO CW KEYING JACK OF RADIO TELETYPEWRITER CONTROL C-808/GRC-26A AS REQUIRED.
10. EXTENSION POWER CABLE PLUG P107 FROM FREQUENCY SHIFT CONVERTER CV-182-(*)/GRC-26A CONNECTS TO CONNECTOR J301 ON POWER SUPPLY PP-712-(*)/GRC-26A.
11. CONNECTOR OF CG-390/U & CX-2481/U CONNECT TO PHONES JACK OF EITHER CHANNEL A OR CHANNEL B RADIO RECEIVER AS REQUIRED.
12. WIRES OF ELECTRICAL POWER CABLE ASSEMBLY CX-1939/U CONNECT TO TERMINALS 4 AND GND OF AUDIO TERMINAL STRIP.
13. THE GROUND LEAD ON AC POWER CORDS OF TELETYPEWRITERS TT-4A/TG IS CONNECTED TO SCREW ON AC OUTLET BOX.
14. □ INDICATES EQUIPMENT MARKING.
15. RADIO SET CONTROL C-1306/GRA-14:

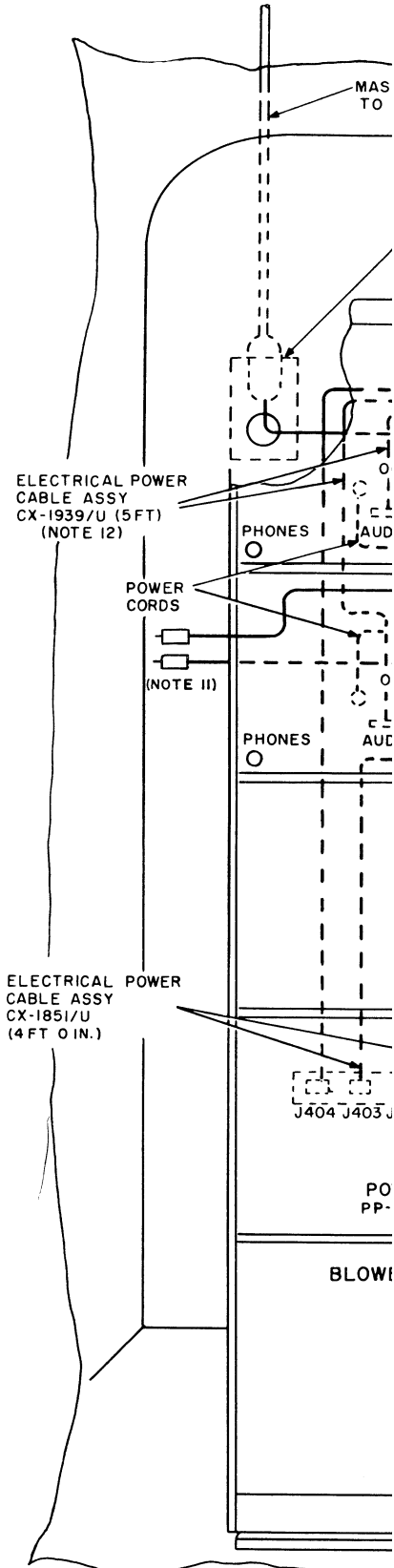
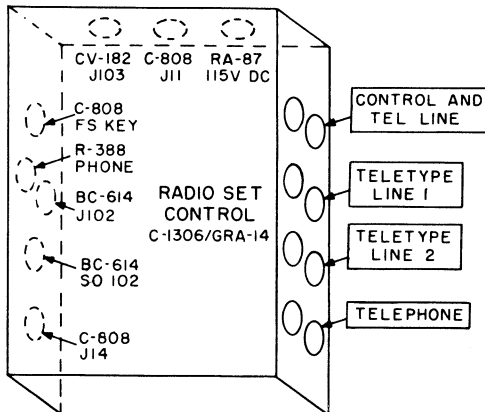

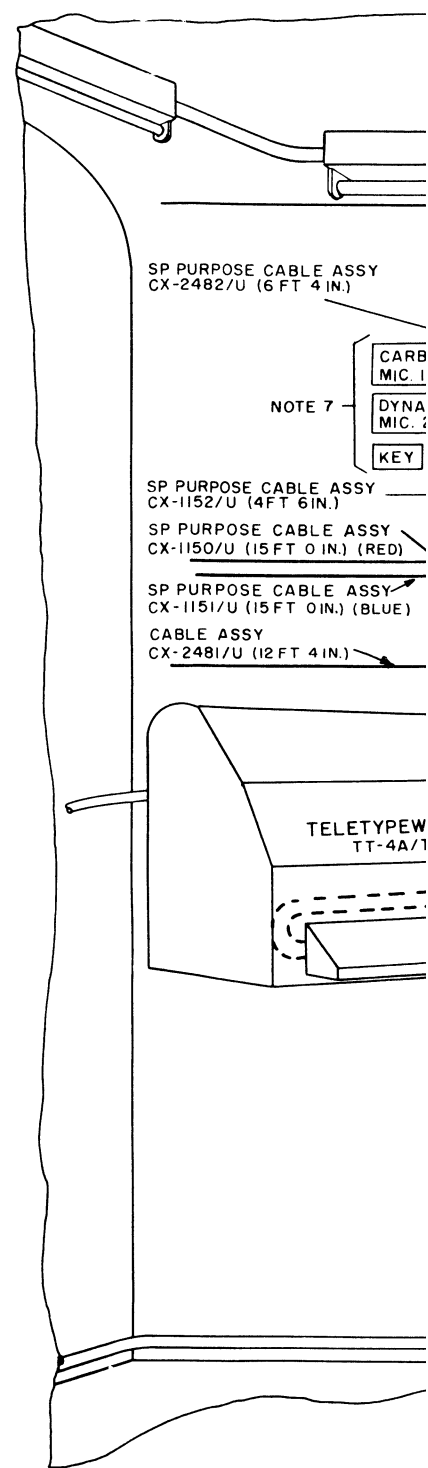
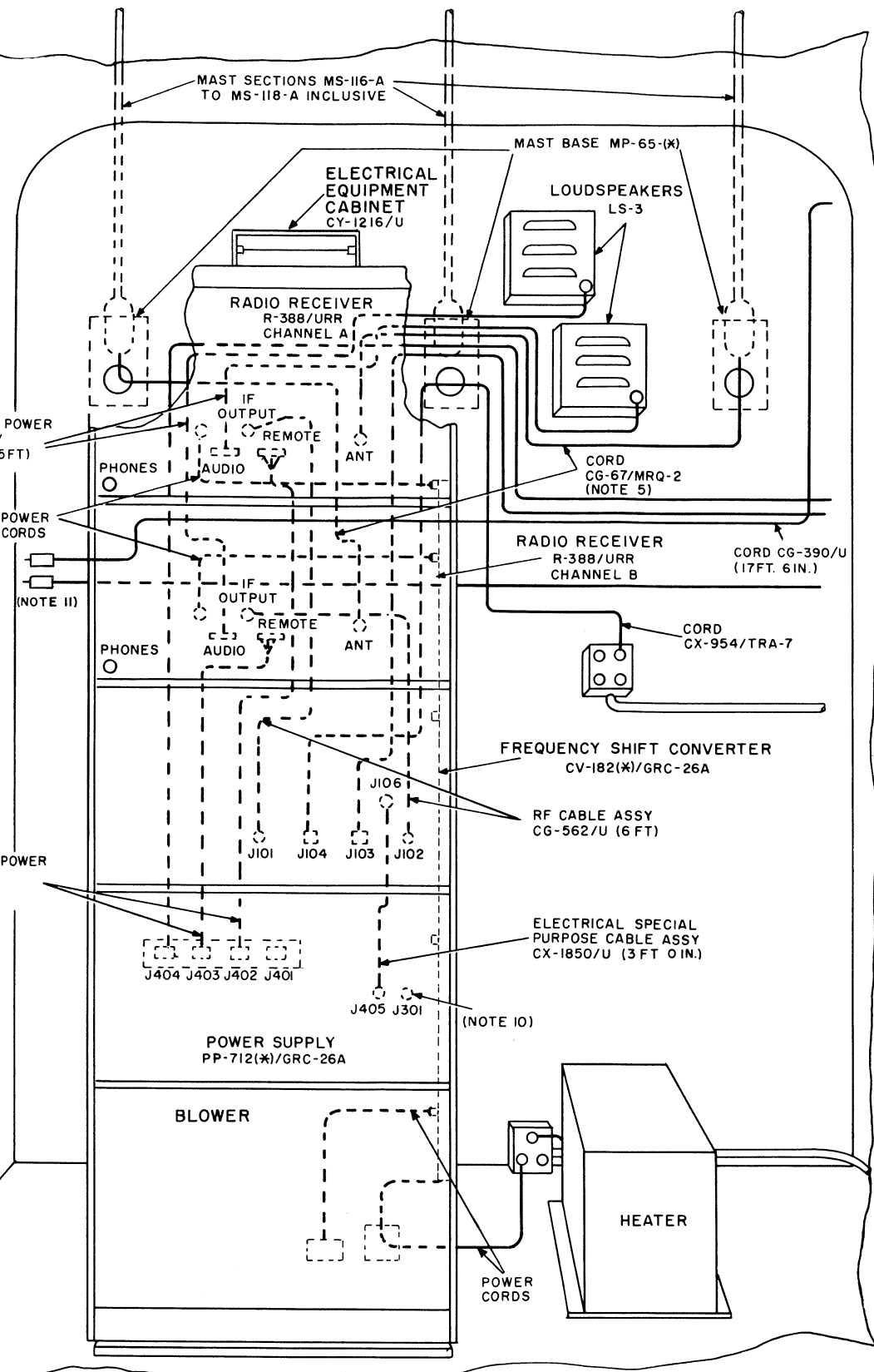
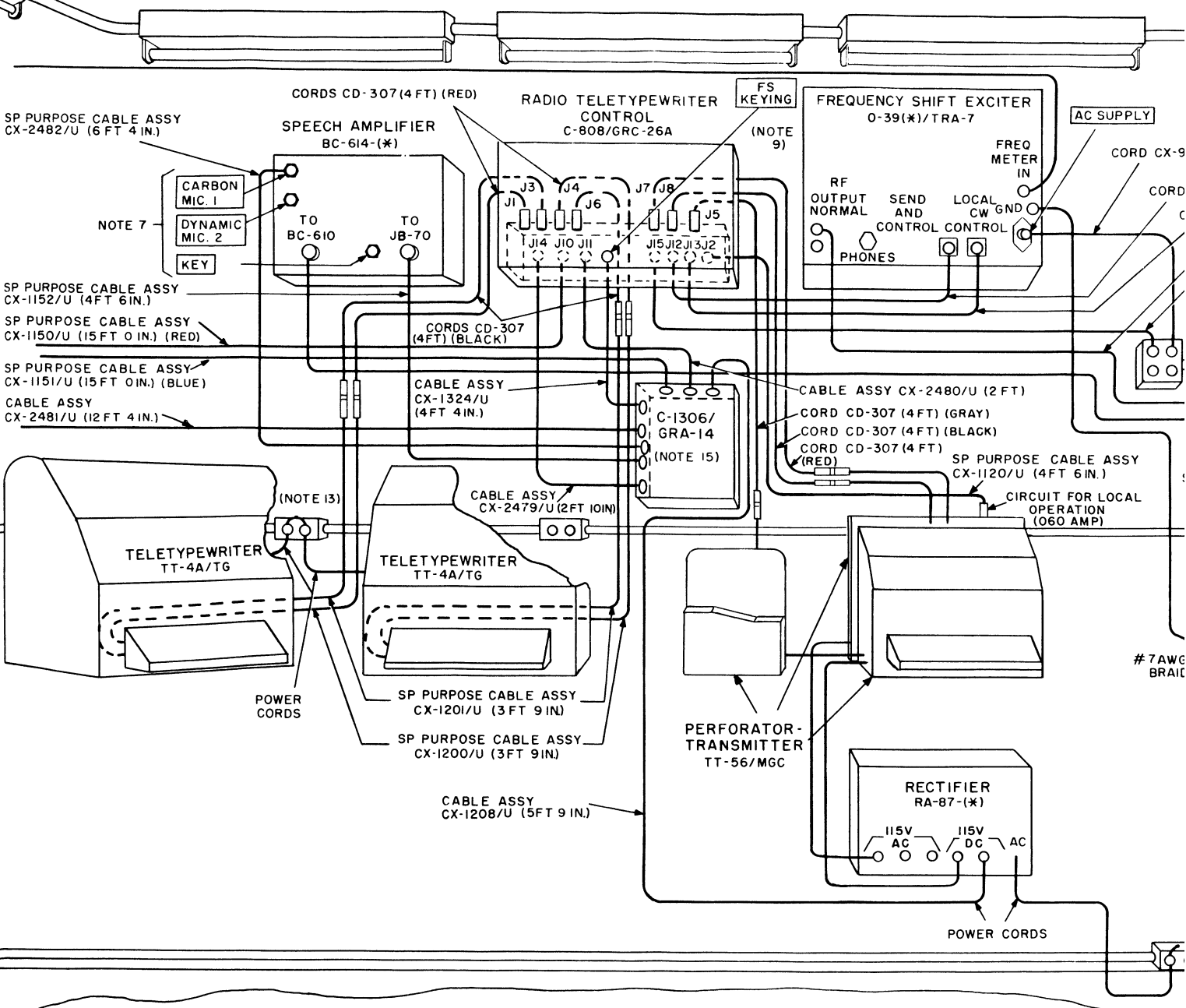
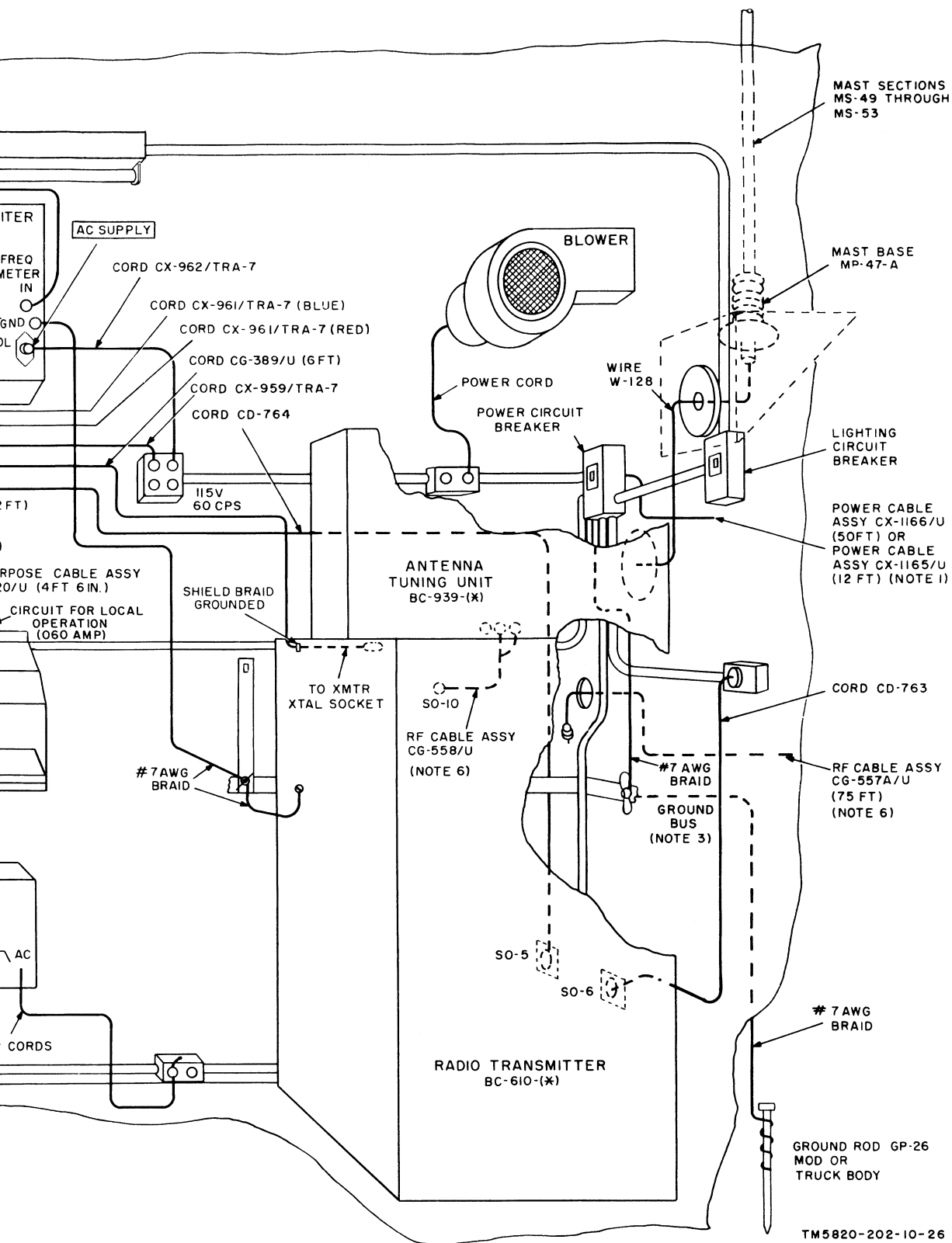

Figure 24. Radio Set AN/GRC-26B, cording diagram



... AN/GRC-26B, cording diagram.



NOTES:

1. CONNECT POWER CABLE CX-1165/U TO POWER UNIT PE-95-(*) OR COMMERCIAL AC SOURCE, RATED 115V AC, 60 CPS, 5.4 KW.
2. AC OUTLET BOXES HAVE TWO CONTACT RECEPTACLES EXCEPT THE TWO 3-WIRE BOXES FURNISHING POWER TO THE REMOTE CONTROL UNIT, FS CONVERTER, AND FS EXCITER. THE THIRD WIRE (GREEN), ALSO USED IN THE LIGHTING FIXTURE WIRING, IS CONNECTED TO THE GROUND BUS THROUGH THE POWER CIRCUIT BREAKER.
3. THE CASES OF ALL TRANSMITTING, RECEIVING, AND OPERATING COMPONENTS ARE CONNECTED TO THE GROUND BUS THROUGH COPPER BRAID, ALTHOUGH NOT SHOWN IN DIAGRAM.
4. SOME RECEPTACLES AND MATING CONNECTORS ARE COLOR CODED TO FACILITATE MAKING PROPER CONNECTIONS.
5. WHEN DOUBLET RECEIVING ANTENNAS ARE USED, CORDS CG-67/MRQ-2 ARE REMOVED FROM MAST BASES MP-65-(*) AND ARE CONNECTED TO CORDS CG-557A/U (500FT) USING PLUGS PL-258.
6. WHEN DOUBLET TRANSMITTING ANTENNA IS USED, ANTENNA TUNING UNIT BC-939-(*) IS NOT USED AND CORD CG-557A/U (75 FT) FROM DOUBLET ANTENNA IS CONNECTED TO SOCKET SO-10 OF RADIO TRANSMITTER BC-610-(*).
7. THE FOLLOWING COMPONENTS ARE CONNECTED AS REQUIRED TO SPEECH AMPLIFIER BC-614-(*) AS FOLLOWS;

COMPONENT	CORD	CONNECTION DESIGNATION
MICROPHONE T-17-(*)	CORD CD-76	CARBON MIC. 1
MICROPHONE T-50		DYNAMIC MIC. 2
KEY J-45	CORD CD-201-A	KEY

8. HEADSET HS-30-(*) CONNECTS TO PHONES JACK OF FREQUENCY SHIFT EXCITER O-39-(*) OR FREQUENCY SHIFT CONVERTER CV-182-(*) AS REQUIRED.
9. KEY J-45 CONNECTS TO CW KEYING JACK OF RADIO TELETYPEWRITER CONTROL C-808/GRC-26A AS REQUIRED.
10. EXTENSION POWER CABLE PLUG PI07 FROM FREQUENCY SHIFT CONVERTER CV-182-(*)/GRC-26A CONNECTS TO CONNECTOR J301 ON POWER SUPPLY PP-712-(*)/GRC-26A.
11. CONNECTOR OF CG-390/U & CX-2481/U CONNECT TO PHONES JACK OF EITHER CHANNEL A OR CHANNEL B RADIO RECEIVER AS REQUIRED.
12. WIRES OF ELECTRICAL POWER CABLE ASSEMBLY CX-1939/U CONNECT TO TERMINALS 4 AND GND OF AUDIO TERMINAL STRIP.
13. THE GROUND LEAD ON AC POWER CORDS OF TELETYPEWRITERS TT-4A/TG IS CONNECTED TO SCREW ON AC OUTLET BOX.
14. □ INDICATES EQUIPMENT MARKING.
15. RADIO SET CONTROL C-1306/GRA-14:

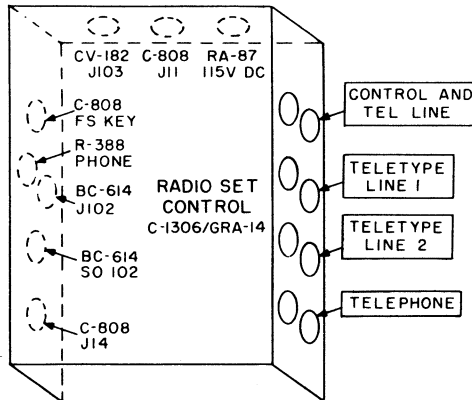

493510 O - 59 (Face p. 36) No. 2

ELECTRIC
CABLE AS
CX-1939/
(NOTE

ELECTRIC
CABLE AS
CX-1851/U

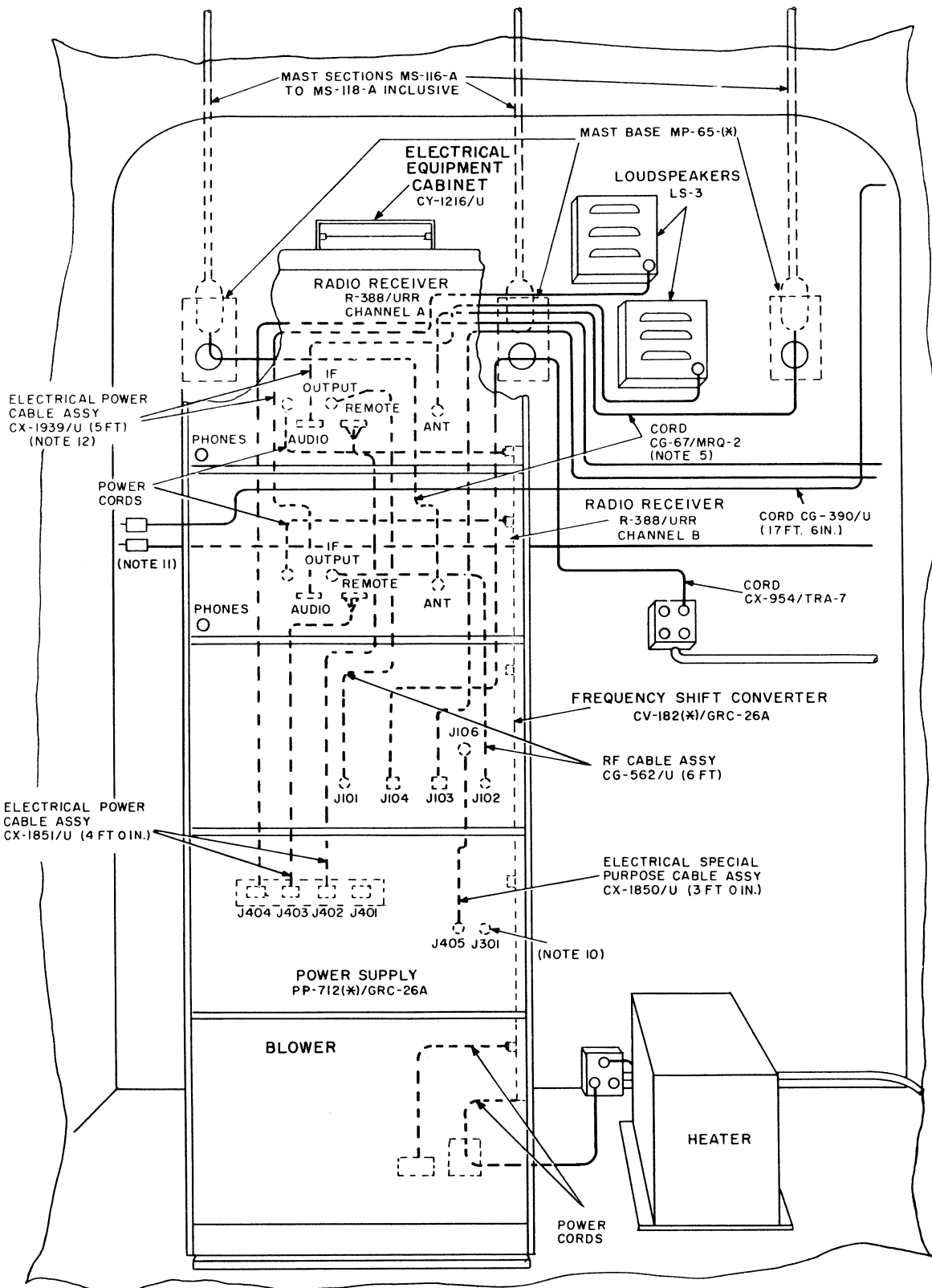

Figure 25. Radio Set AN

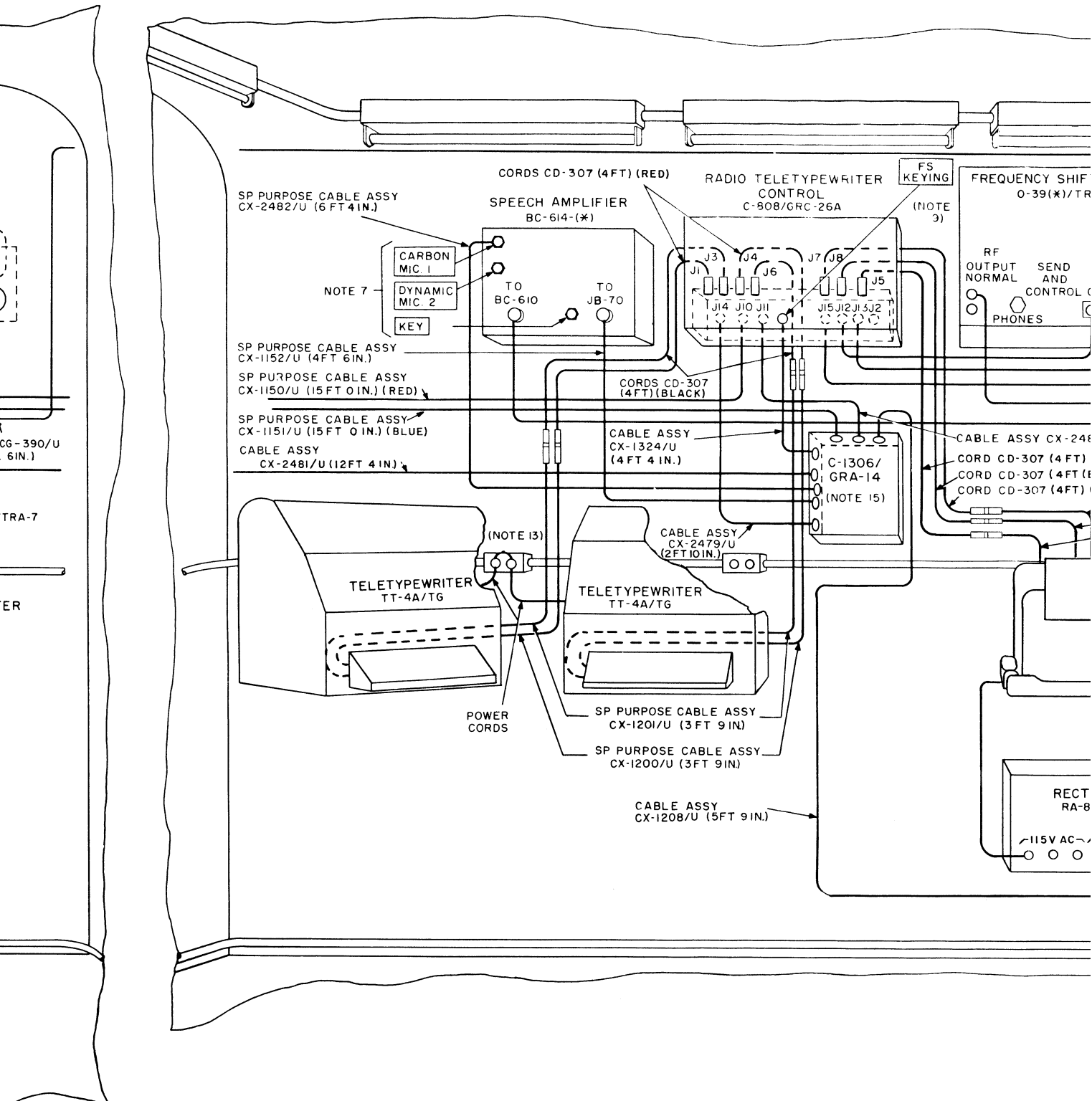
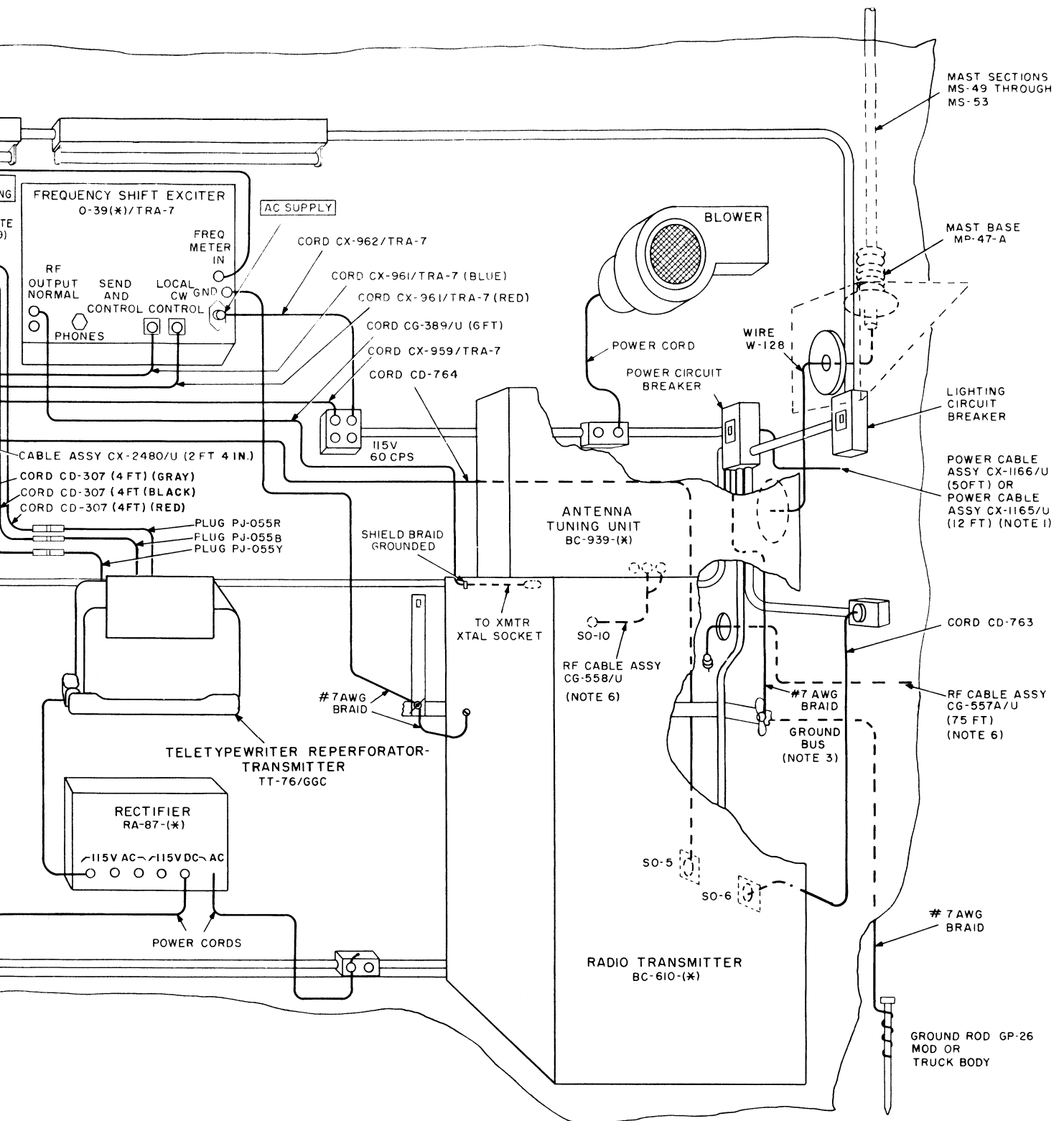
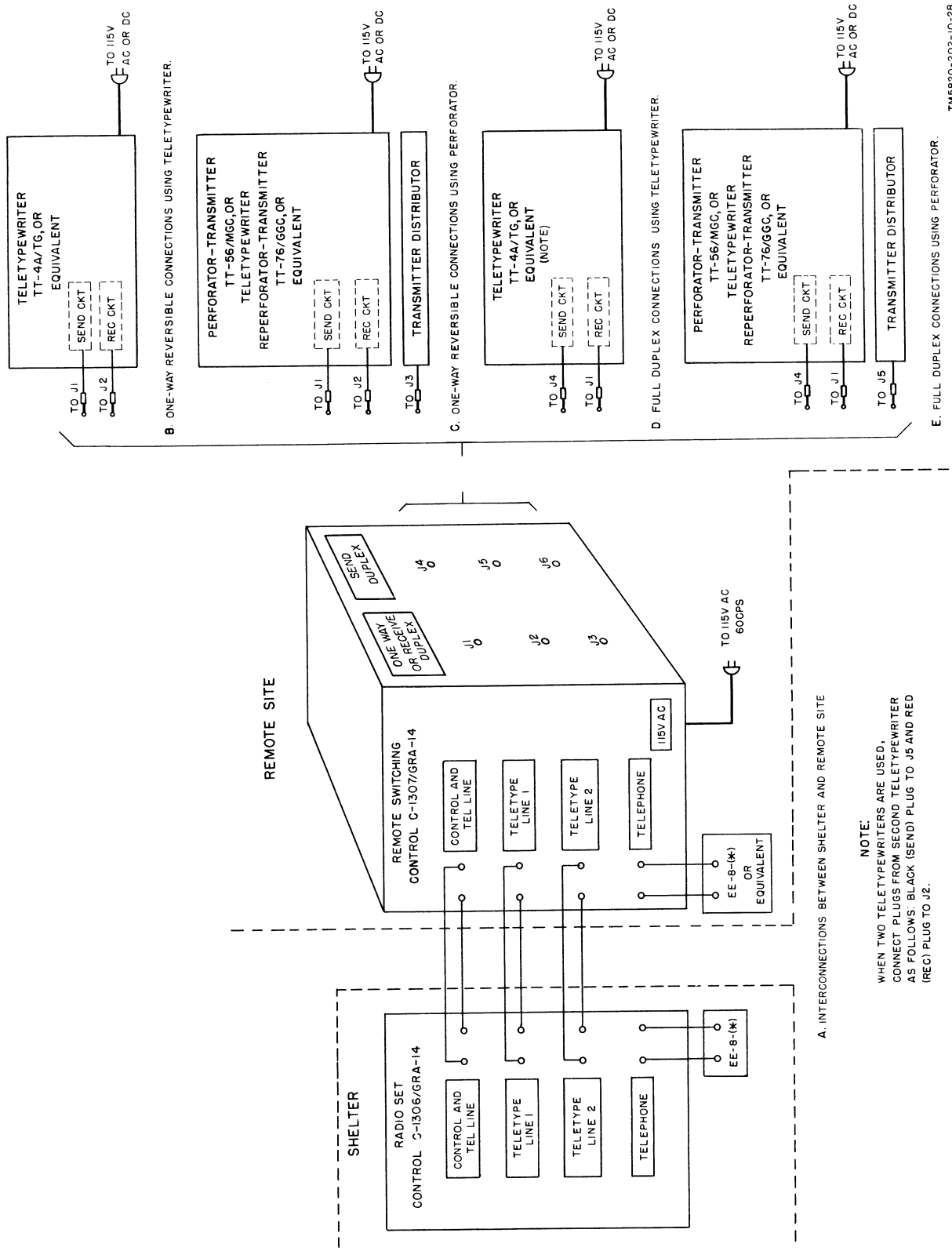

Figure 25. Radio Set AN/GRC-26C, cording diagram.





TM5820-202-10-28

Figure 26. Remote Control Group A)(GRA-14, cording diagram and line connections.

wire to the telephone in the shelter; pass the wire through the bushing of Mast Bracket MP-50-A and into the truck cab and connect it to the other telephone.

27. Installation of Operating Equipment

a. Shelter.

(1) The operating equipment is installed within the shelter by the manufacturer or the depot. Check to see that all tubes and tube caps are firmly in place. Location of tubes in Radio Teletype-

writer Control C-808/GRA-26A or Transmitter-Teletypewriter Control C-808A/GRA-26A is shown in TM 11-5820-202-20. Tube location for the components of the radio set is shown in the components technical manual for each component (par. 1c).

(2) Install the fluorescent lamps and the starters in the lighting fixtures.

(3) Be sure that the correct fuses are mounted in the equipment. The chart below lists the fuses used in each component.

Equipment	Fuse	Rating (amp)	Location
Radio Transmitter BC-610-(*)	FS1	25	Front panel.
	FS2	25	
	FS3	20	
	FS4	6	
	FS5	3	
Radio Receivers R-388/URR	F101	1.5	Rear panel of chassis.
Power Supply PP-712(*)/GRC-26A	F301	3	Behind hinged door on front panel.
	F302	3	
	F401	1	
Electrical Equipment Cabinet CY-1216/U		.5	Blower assembly front panel.
Frequency Shift Exciter O-39(*)/TRA-7 (except equipments listed in the next item).	F101	3	Front panel.
Frequency Shift Exciter O-39B/TRA-7 bearing Order No. 3135-Phila-51 (serial Nos. 630-811), and Frequency Shift Exciters OB-39B/TRA-7 and O-39C/TRA-7 bearing Order No. 3357-Phila-52.	F103	3	
	F101	3	Front panel.
Radio Teletypewriter Control C-808/GRC-26A and Transmitter-Teletypewriter Control C-808A/GRC-26A.	F103	.3	
	F1	1	Front panel.
Perforator-Transmitter TT-56/MGC (in Radio Sets AN/GRC-26A and AN/GRC-26B).	Fusetron for transmitter distributor.	1.6	Connection box.
	Fusetron for typing reperforator.	1.6	
Teletypewriter Reperforator-Transmitter TT-76/GGC (in Radio Set AN/GRC-26C).	F1	1.6	Power supply and terminal unit (under dust cover).
Teletypewriter TT-4A/TG	MOTOR	2	Behind hinged door of dust cover.
Rectifier RA-87-(*) (in Radio Sets AN/GRC-26A and AN/GRC-26B).	LINE	$\frac{1}{8}$	
	F1	.5	Behind hinged door.
Teletypewriter TT-55/MGC (in same Radio Set AN/GRC-26A).	F2	15	Behind bottom panel.
	Fusetron for motor	1.6	Base of teletypewriter near motor unit.

b. *Antenna Tuning Unit BC-939-(*)*. Remove the unit from its packing case and remove the wrappings. Set the tuning unit on top of the radio transmitter (fig. 3) and secure it to the radio transmitter with the four wing nuts.

c. *Telephone EE-8-(*)*. Install two Batteries BA-30 in each Telephone EE-8-(*) in the shelter. When a Telephone EE-8-B is used at the remote control unit (e(2) below), install two Batteries BA-30 in it.

d. *Power Unit PE-95-(*)*.

- (1) Examine the storage battery for the power unit. Instructions for preparing the battery for service are attached to each battery. Follow the directions

carefully. Refer to TM 11-904 to install the battery.

- (2) Check the power unit for gasoline and oil.
- e. *Radio Set Control Group AN/GRA-14*.
- (1) The control group (par. 3b) consists of the radio set control and the remote switching control.
 - (2) Use the clamp to mount the remote switching control as close to the remote teletypewriter position as possible. Usually, it is clamped to the operator's table between the two teletypewriters. Make the connections to the teletypewriters, the remote switching control, and the telephone as shown in figure 26.

CHAPTER 3

OPERATING INSTRUCTIONS

Section I. OPERATOR'S CONTROLS, INSTRUMENTS, INDICATORS, AND JACKS

Note. This section covers only items used by the operator; items used by maintenance personnel are covered in instructions for the appropriate maintenance echelon. Detailed descriptions of controls and instruments for components of the radio set not described in paragraphs 28 and 29, are covered in the technical manual for the particular component (par. 1c).

28. Radio Teletypewriter Control C-808/ GRC-26A and Transmitter-Teletype- writer Control C-808A/GRA-26A, Controls, Indicators, Connectors, and Jacks (fig. 27)

Control, indicator, connector, or jack	Function
ON-OFF switch.....	Two-position toggle switch: ON position—connects ac power to teletypewriter control unit. OFF position—disconnects ac power from teletypewriter control unit.
FULL DX ONE-WAY switch.....	Two-position toggle switch: FULL DX position—permits full-duplex operation of the radio set. Operation may be radiotelephone, radioteletype, or both. ONE WAY—permits one-way reversible operation of the radio set. Operation may be either radiotelephone or radioteletype.
EXTENSION-NORMAL switch.....	Two-position toggle switch: EXTENSION position—connects teletypewriter polar signal circuit to teletypewriter equipment connected to REC EXT and SEND EXT binding posts. NORMAL position—connects teletypewriter signal circuit to the local teletypewriter equipment.
FS KEYING jack.....	Connection for frequency shift (fs) keying of the frequency shift exciter.
CW KEYING jack.....	Connection for cw keying of the transmitter.
SPACE-MARK switch.....	Two-position toggle switch: SPACE position—disconnects mark power supply, leaving space power supply current to be measured on meter. MARK position—connects mark power supply, permitting mark current to be measured on meter.
SPACE control.....	Regulates space output current.
MARK control.....	Regulates mark output current.
XMTR ON-XMTR OFF switch.....	Two-position ganged switch: XMTR ON position— <i>disables</i> the receiver and <i>enables</i> the transmitter. Completes transmitter plate power and frequency shift exciter plate power circuits. XMTR OFF position— <i>disables</i> the transmitter and <i>enables</i> the receiver.
Meter.....	Measures mark and space current of polar signals to the frequency shift exciter.
TT TRANSPOSE switch.....	Two-position rotary switch: LEFT REC-RIGHT SEND position—connects left teletypewriter for receiving messages and connects the right teletypewriter for sending messages. RIGHT REC-LEFT SEND position—connects right teletypewriter for receiving messages and connects the left teletypewriter for sending messages.

Control, indicator, connector, or jack	Function
PERFORATOR OPERATION switch	Three-position rotary switch: RECEIVE TT position—permits tape copy of incoming message to be made on the perforator. PUNCH TAPE position—allows independent tape preparation on re-perforator. Performs no function in Radio Set AN/GRC-26C. SEND TT position—permits perforator to make tape copy of outgoing messages being sent from left or right teletypewriter or from the re-perforator.
TRANSMITTER indicator lamp	Lights when XMTR ON-XMTR OFF switch is in XMTR ON position.
NORMAL-CW BREAK-IN switch	Two-position toggle switch (at rear of chassis): NORMAL position—disconnects disabling circuit of C-W BREAK-IN position. CW BREAK-IN position—disables receivers for cw operation.
REC EXT terminals	Binding posts for connecting extension lines for polar receiving loop.
SEND EXT terminals	Binding posts for connecting extension lines for polar sending loop.
AC SUPPLY indicating lamp	Lights when ON-OFF switch is operated to ON position.

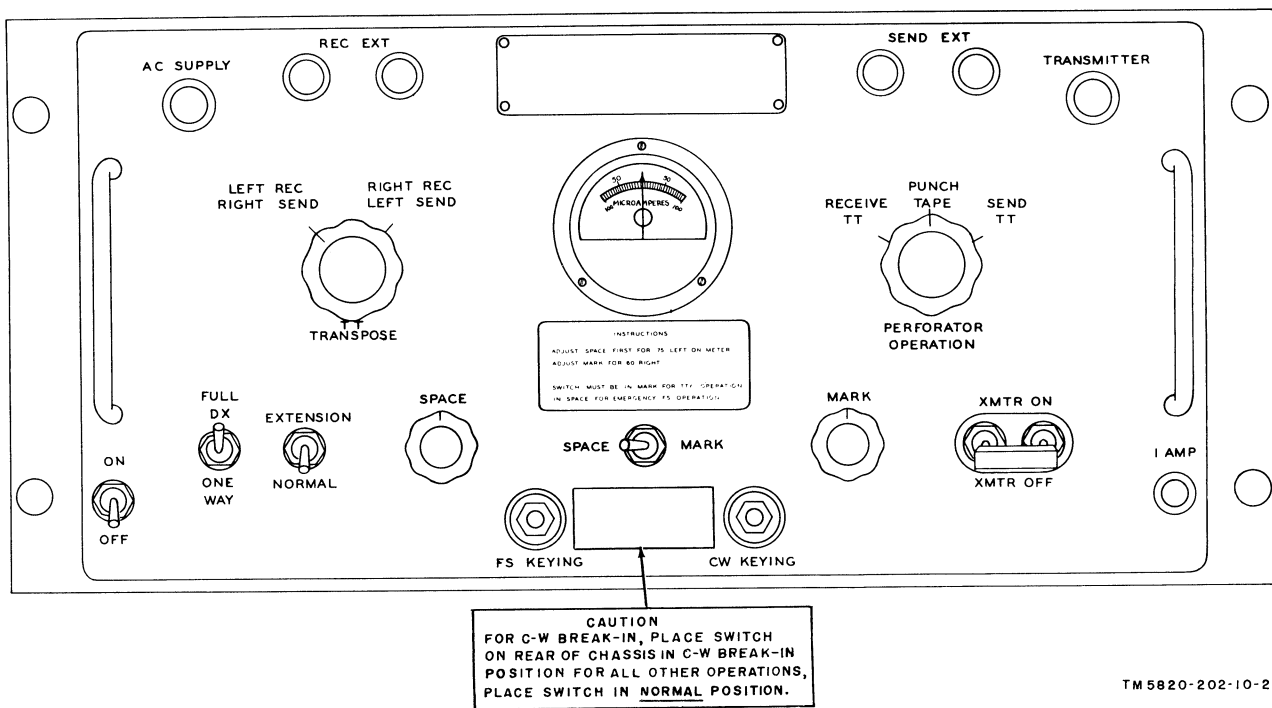

Figure 27. Radio Teletypewriter Control C-808/GRC-26A or Transmitter-Teletypewriter Control C-808A/GRC-26A, controls, indicators, connectors, and jacks.

29. Radio Set Control Group AN/GRA-14, Controls and Indicators

Radio Set Control Group AN/GRA-14 consists of Radio Set Control C-1306/GRA-14 and Remote Switching Control C-1307/GRA-14 and associated cables (fig. 11).

a. *Radio Set Control C-1306/GRA-14* (fig. 28).

Control or indicator	Function
ON-OFF switch.....	Two-position toggle switch: ON position—connects the radio set control to ac power, and permits the radio set control to control the radio set. OFF position—disconnects ac power from the radio set control, and disconnects the radio set control from the radio set.
TELEPHONE switch.....	Two-position toggle switch: LOCAL position—permits telephone communication between the shelter and the remote site. RADIO position—permits radiotelephone operation of the radio set from the remote site.
ONE-WAY-DUPLEX switch.....	Two-position toggle switch: ONE WAY position—permits one-way reversible operation from remote site of either radiotelephone or radioteletypewriter. DUPLEX position—permits full-duplex operation of either radiotelephone or radioteletypewriter, or both, from remote site.
TELETYPE switch.....	Two-position toggle switch: LOCAL position—permits teletypewriter communication between the shelter and the remote site during full-duplex radiotelephone operation. RADIO position—permits radioteletypewriter operation of the radio set from the remote site.
HYBRID BALANCE control.....	Adjust level of receiver teletypewriter signals to reduce modulation of transmitter during full-duplex radioteletypewriter operation.
RECEIVE indication lamp.....	When lighted, indicates that receivers are disabled. When out, indicates that transmission is being made when operating on one-way reversible basis.
LOCAL TELETYPE indicating lamp.....	When lighted, indicates that teletypewriter communication may be made between the remote site and the shelter.
TRANS indicator lamp.....	When lighted, indicates that radioteletypewriter transmission may be made.

b. *Remote Switching Control C-1307/GRA-14* (fig. 29).

Control or indicator	Function
ON-OFF switch.....	Two-position toggle switch: ON position— <i>disables</i> receivers and <i>enables</i> transmitter for transmission during one-way reversible operation. OFF position—signals being received by the radio set. Signals also may be transmitted when remote switching control is being used on full-duplex operation.
TRANS indicator lamp.....	When lighted, indicates that ON-OFF switch is in ON position.

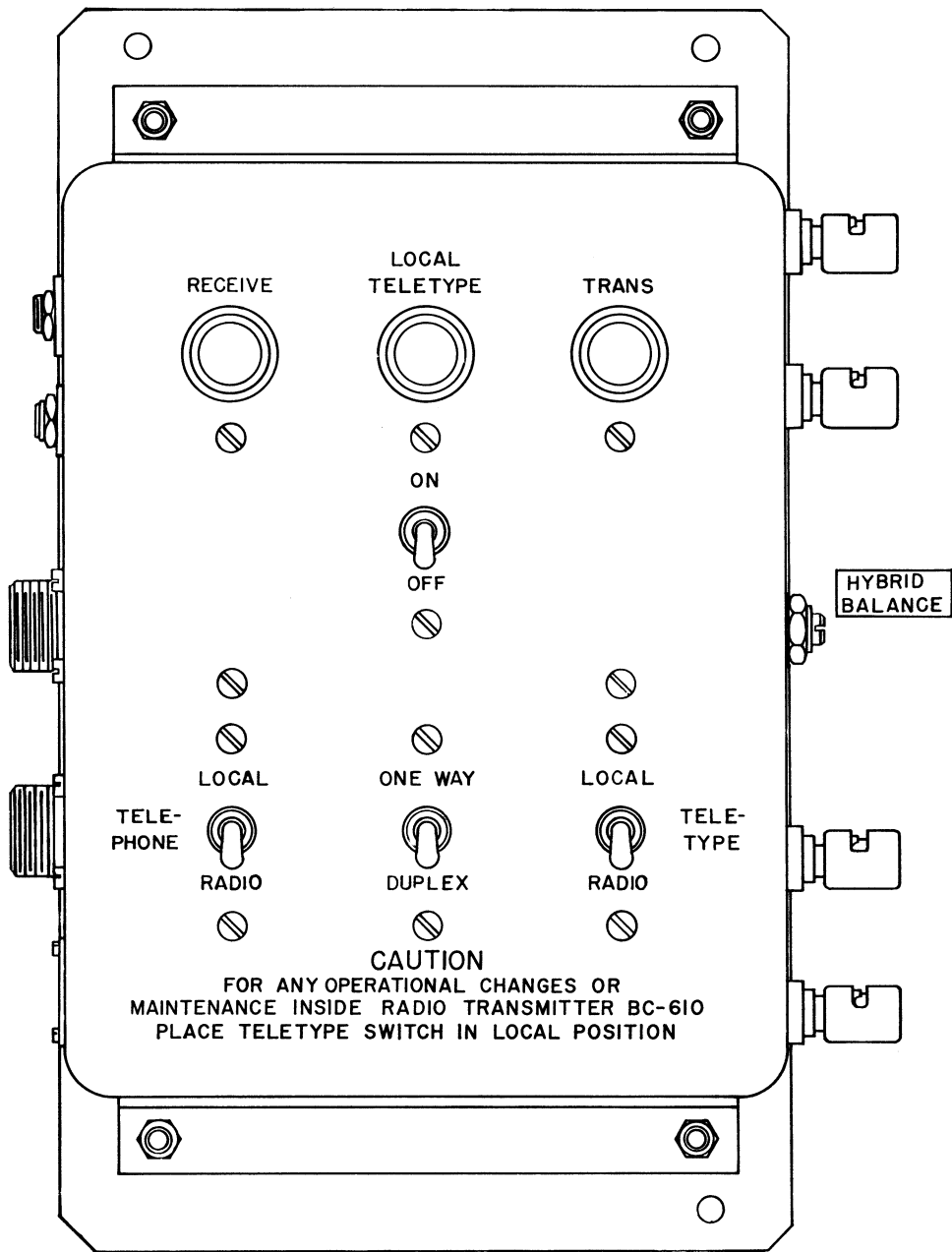

TM 5820-202-10-30

Figure 28. Radio Set Control C-1306/GRA-14, controls and indicators.

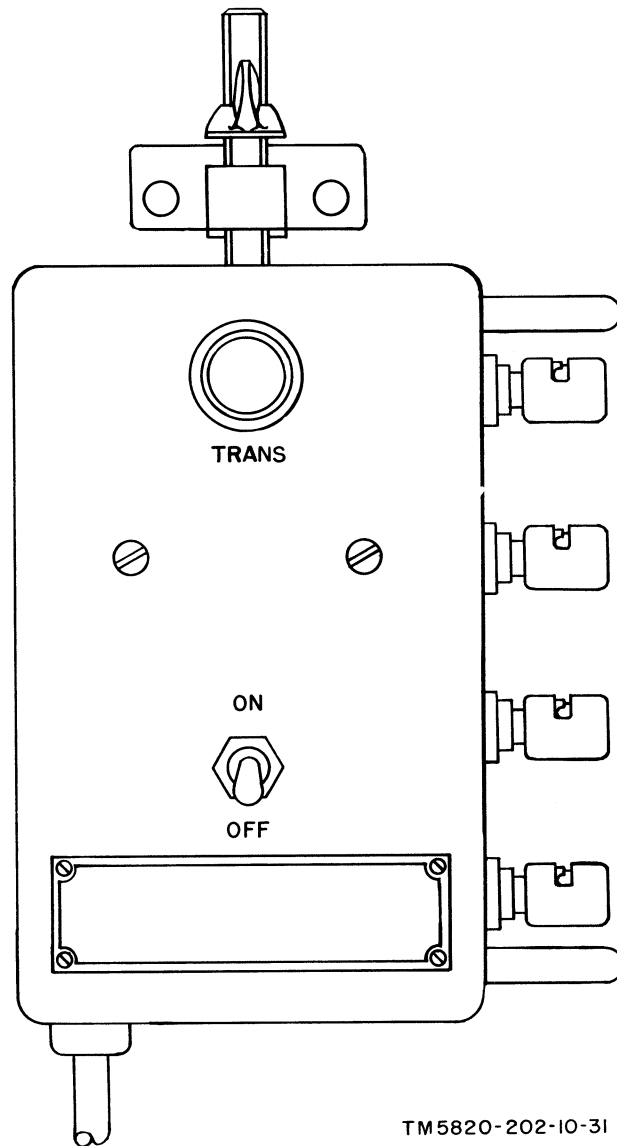

Figure 29. Remote Switching Control C-1307/GRA-14, control and indicator.

Section II. STARTING PROCEDURES

30. Types of Operation

One of the several operating conditions can be used, depending upon the existing situation. The radio set is capable of operating in mobile, mobile-at-halt, or semifixed conditions.

a. Mobile Condition. In this type of operation, the radio set is used while in motion. The whip antennas are used for transmission and reception of signals (par. 22). One-way reversible or full duplex operation can be used; one-way reversible operation is usually employed. In one-way re-

versible operation, the transmitter and receiver do not operate simultaneously. When the transmitter is used, the receivers (or receiver) are disabled; when the receivers are used, the transmitter is disabled. The transmitter and the receivers use the same frequency in this type of operation. In one-way reversible net operation two frequencies separated by at least 400 kc are used for transmission and reception; one frequency is for radioteletypewriter (RTT) operation, the other for voice break-in operation.

Caution: To prevent damage to the receivers in full duplex mobile and mobile-at-halt operation, the transmitting and receiving frequencies should be at least 1 mc apart and not be harmonics of one another.

b. Mobile-at-Halt Condition. In this type of operation, the radio set is stopped but may move again with a minimum delay. The whip antennas are used for transmission and reception of signals (par. 22). Duplex and one-way reversible operation can be used. One-way reversible operation is usually employed. In duplex operation, the transmitter and receiver operate on frequencies separated by at least 400 kc. This makes it possible for the radio set to transmit and receive at the same time without interference between the transmitter and receiver.

c. Semifixed Condition. Semifixed condition is described as a more permanent condition in which the doublet antennas are erected (pars. 23 and 24). The shelter may be removed from the vehicle and placed in a more concealed position. Under these conditions, doublet antennas are erected and either space diversity duplex or space diversity one-way reversible operation is used.

d. Remote Operation. In remote operation, the teletypewriter equipment and telephone at the remote site are used for transmitting and receiving messages. Operation may be one-way reversible or full-duplex for both radioteletypewriter and radiotelephone operation.

e. Procedure. To operate the radio set for any type of operation, perform the preliminary and starting procedures (pars. 31 and 32). Then perform the operations for the desired type of operation as follows:

- (1) Tune the radio set as desired for:
 - (a) Full-duplex operation (pars. 33 through 35).
 - (b) One-way reversible operation (pars. 36 through 38).
 - (c) Remote operation (par. 40).
- (2) Operate the teletypewriter and reperforator equipment (par. 39).
- (3) Stop the equipment (par. 43).

31. Preliminary Starting Procedures

Perform the preliminary starting procedures before starting the equipment (par. 32). Operate the control to the position indicated.

Component	Control	Position
Shelter S-69/GRC Receiver	Power circuit breaker	OFF.
	Lighting circuit breaker	OFF.
	OFF-STANDBY-ON switch	OFF.
	AVC switch	OFF.
	CALIBRATE switch	OFF.
	BFO switch	OFF.
	BFO PITCH control	Set to white line.
	RF GAIN control	Set to zero.
	LIMITER switch	OFF.
	METER switch	INPUT.
	CRYSTAL FILTER SELECTIVITY switch	O.
	PHASING control	Set to white line.
	BREAK-IN switch	OFF.
	Frequency shift converter	OUTPUT switch
METER B switch		INPUT.
DRIFT COMPENSATOR		Out (down).
BANDWIDTH switch		NARROW.
CHANNEL A FINE TUNING control		Set to white line.
CHANNEL A OPERATE-DISABLED switch.		DISABLED.*
CHANNEL B FINE TUNING control		Set to white line.
CHANNEL B OPERATE-DISABLED switch.		DISABLED.*
NEUTRAL OUTPUT control		Fully counterclockwise.
MARK HOLD LEVEL (switch and control).		OFF (fully counterclockwise).
LP FIL switch	IN (up).	

Component	Control	Position
Power Supply PP-712(*)/GRC-26A	AC SUPPLY switch	Off (down).
	PLATE switch	Off (down).
Blower assembly (on Electrical Equipment Cabinet CY-1216/U). ^b	ON-OFF switch	OFF.
Teletypewriter control unit	ON-OFF switch	OFF.
	XMTR ON-XMTR OFF switch	XMTR OFF.
	EXTENSION-NORMAL switch	NORMAL.
	FULL DX-ONE WAY switch	FULL DX.
	SPACE-MARK switch	MARK.
	PERFORATOR OPERATION switch	PUNCH TAPE.
Radio set control	ON-OFF switch	OFF.
Teletypewriter TT-55/MGC (if used) ^c	ON-OFF switch	OFF.
Teletypewriter TT-4A/TG	MOTOR switch	OFF.
	VOICE FREQ LINE—D. C. LINE switch.	D. C. LINE.
	LINE INCREASE control	Fully counterclockwise.
Perforator-Transmitter TT-56/MGC ^d	POWER switch	OFF (up).
	MOTOR ON-MOTOR OFF switch	MOTOR OFF.
Transmitter distributor (p/o TT-56/MGC). ^d	STOP-SEND switch	STOP.
Teletypewriter Reperforator-Transmitter TT-76/GGC. ^e	POWER ON-OFF switch	OFF.
Rectifier RA-87-(*)	ON-OFF switch	OFF.
Frequency shift exciter	AC SUPPLY switch	Off (down).
	OVEN switch	Off (down).
	TEST OSC 850 ~ switch	OFF.
	TEST switch	NORM.
Transmitter	FILAMENT POWER switch	Off (down).
	FILAMENT VOLTAGE control	Fully counterclockwise.
	EXCITER PLATE POWER switch	NORMAL (down).
	HIGH VOLTAGE PROTECT switch	NORMAL (down).
	PLATE POWER switch	Off (down).
	PHONE-CW switch	CW.
	EXCITATION METER SWITCH	INT. AMP. GRID.

* Some units label these switches CHANNEL A DISABLING and CHANNEL B DISABLING. Up position is operate position; down position is disabled position.

^b Radio Sets AN/GRC-26B and -26C.

^c Radio Set AN/GRC-26A.

^d Radio Sets AN/GRC-26A and -26B.

^e Radio Set AN/GRC-26C.

32. Starting Procedures

With the controls set as outlined in paragraph 31, perform the following operations in the sequence given. If an abnormal indication is

obtained during the starting procedure, operate the power switch of the component to the off position and refer to the troubleshooting check list (par. 51) for suggested corrective measures.

Item No.	Component	Switch or control	Action and indication
1	Power unit	START-STOP switch	Operate to START position. Hold until engine starts.
		CIRCUIT BREAKER	Operate to ON position. Allow at least 10 minutes for the power unit to warm up before operating this switch.
2	Shelter	Power circuit breaker	Operate to ON position.
		Lighting circuit breaker	Operate to ON position. Shelter lamps light.

See footnotes at end of table.

Item No.	Component	Switch or control	Action and indication												
3	Frequency shift exciter	OVEN switch AC SUPPLY switch	Operate to ON position. The OVEN lamp lights when crystal oven is operating. Operate to ON position. The AC SUPPLY lamp lights. Allow at least 2 hours to warm up. If the equipment is required sooner, careful checks must be made of the transmitted frequency.												
4	Receivers, channel A and channel B.	OFF-STANDBY-ON switch	Operate to STANDBY position. Lamps behind KILOCYCLES and MEGACYCLES dials light.												
5	Electrical Equipment Cabinet CY-1216/U. ^a	Blower assembly ON-OFF switch	Operate to ON position. Indicating lamp lights and blower operates. Open the vent at top of cabinet.												
6	Power Supply PP-712-(*)/GRC-26A.	AC SUPPLY switch PLATE switch	Turn the two slotted screws on the front panel and pull open the panel door. Check to see that the input connections on transformers T301 and T302 are both at terminals 1 and 3. Operate to ON position. Filament (white) lamp lights. Operate to ON position. Plate (red) lamp lights.												
7	Transmitter	FILAMENT POWER switch FILAMENT VOLTAGE control	Operate to ON (up) position. Green lamp lights. Turn until an indication of 5 to 5.3 volts ac appears on FILAMENT VOLTAGE meter. Allow at least 1 minute warm up.												
8	Frequency shift converter	METER B switch	Turn to following positions and observe required meter B readings: <table style="margin-left: auto; margin-right: auto;"> <thead> <tr> <th>Switch position</th> <th>Meter reading (approx volts)</th> </tr> </thead> <tbody> <tr> <td>+275V</td> <td>60 ± 6 (right)</td> </tr> <tr> <td>REG + 150V</td> <td>30 ± 5 (right)</td> </tr> <tr> <td>REG - 150V</td> <td>30 ± (left)</td> </tr> <tr> <td>-150V</td> <td>30 ± (left)</td> </tr> <tr> <td>-400V</td> <td>80 ± 8 (left)</td> </tr> </tbody> </table>	Switch position	Meter reading (approx volts)	+275V	60 ± 6 (right)	REG + 150V	30 ± 5 (right)	REG - 150V	30 ± (left)	-150V	30 ± (left)	-400V	80 ± 8 (left)
Switch position	Meter reading (approx volts)														
+275V	60 ± 6 (right)														
REG + 150V	30 ± 5 (right)														
REG - 150V	30 ± (left)														
-150V	30 ± (left)														
-400V	80 ± 8 (left)														
9	Teletypewriter control unit	ON-OFF switch	Operate to ON position. AC SUPPLY (white indicating lamp) lights.												
10	Rectifier RA-87-(*).	ON-OFF switch	Operate to ON position.												
11	Teletypewriters TT-55/MGC ^b	ON-OFF switch	Operate to ON position.												
12	Teletypewriters TT-4A/TG	MOTOR switch LIGHT switch LINE INCREASE control	Operate to ON position. Motor runs. Operate to ON position. Lamps light. Adjust for indication of 60 ma on dc MILLIAMPERES meter. The teletypewriter should run closed.												
13	Perforator-Transmitter TT-56/MGC.	MOTOR switch	Operate to ON position (down). Motor runs.												
14	Transmitter-distributor (p/o TT-56/MGC). ^c	MOTOR ON-MOTOR OFF switch.	Operate to MOTOR ON position. Motor runs.												
15	Teletypewriter Reperforator-Transmitter TT-76/GGC. ^d	POWER switch MOTOR switch LIGHT switch	Operate to ON position. Operate to ON position. Motor runs. Operate to ON position. Light lights.												
16	Transmitter-distributor (p/o TT-76/GGC). ^d	START-STOP-FEED RETRACT switch.	Operate to STOP position.												

^a Radio Sets AN/GRC 26B and 26C.

^b Radio Set AN/GRC 26A.

^c Radio Sets AN/GRC-26A and -26B.

^d Radio Set AN/GRC-26C.

Section III. FULL-DUPLEX PROCEDURES

33. Full-duplex Operation

In full-duplex operation the transmitter and receivers operate at the same time. One frequency is used for transmission; another is used for reception.

a. Determine the assigned transmitting and receiving frequencies.

b. Install the appropriate antennas (pars. 19 and 24-27). Operate the equipment for full-duplex operation (pars. 34 and 35).

c. A calibration chart for the frequency shift exciter, giving the approximate setting of certain controls and switches for the frequency to be used, is located in a pocket in the side of the frequency shift exciter (the SHIFT control setting is different for each exciter). Tuning charts for setting certain controls and switches on the transmitter and antenna tuning unit are located in a pocket in the front of the transmitter and in TM 11-826. Power amplifier (pa) plate tuning coils and transmitter tuning units are stored in compartments in the storage cabinet (fig. 2).

Warning: Dangerous high voltages are present in the transmitter. When a pa plate tuning coil is changed or adjusted, use the grounding hook (par. 256) to ground the tuning capacitor in the left compartment. Open the top left door of the transmitter, put the right hand into a coat or trouser pocket, and touch the prod of the shorting stick to the frame of tuning capacitor.

34. Tuning Transmitter and Frequency Shift Exciter

a. *Preliminary Operation.* Determine that the antenna being used (doublet, whip, or long wire) is connected properly (figs. 22, 23, or 24). Perform the procedures outlined in paragraphs 31 through 33. Perform the following operations:

- (1) *Frequency shift converter.* Operate either CHANNEL A or CHANNEL B disabling switch to the OPERATE position, depending on which receiver is being used as the frequency standard. Operate the

other disabling switch to the DISABLED position. In this procedure, channel A receiver is used as the frequency standard.

- (2) *Teletypewriter control unit.* Operate the XMTR ON-XMTR OFF switch to the XMTR OFF position.
- (3) *Frequency shift exciter.*
 - (a) Use the frequency shift exciter calibration chart to set the designated controls nearest the setting given as the closest to the assigned transmitting frequency.
 - (b) Operate the TEST switch to the MARK position.
 - (c) Operate the BUFFER TUNING control for maximum brilliance on the BUFFER INDICATOR lamp.
 - (d) Operate the TEST switch to the NORM position. During these line-up procedures, use the TEST switch to turn the transmitter plate power on and off.
- (4) *Transmitter.*
 - (a) From the transmitter tuning chart, determine the proper transmitter tuning unit and pa tank coil for the assigned frequency; select these components from the wall cabinet (fig. 2).
 - (b) Place the transmitter tuning unit and pa tank coil in their respective sockets in the transmitter. Operate the transmitter tuning unit MO-XTAL switch to the XTAL position.
 - (c) Insert the connector of Cord CG-389/U into the XTAL receptacle on the selected transmitter tuning unit (figs. 23 through 25).
 - (d) Set the transmitter controls to the settings indicated in the transmitter tuning chart for the frequency nearest the assigned frequency.
 - (e) Leave the door over the right compartment open until time to adjust for proper plate current.

- (5) *Tuning receiver as frequency standard.*
Final adjustment of the frequency shift exciter requires the use of a receiver as a frequency standard. In these directions, channel A receiver is used as the standard. Refer to TM 11-854 to operate the receiver.

- (a) Calibrate the receiver.
(b) Operate the switches and controls to the position given in the following chart:

Caution: Do not change the settings of the KILOCYCLES control until the receiver is no longer required as the frequency standard.

Switch or control	Position
KILOCYCLES control	Set to desired frequency.
BFO switch	ON.
BFO PITCH control	Index lines lined up.
AVC switch	ON.
LIMITER switch	ON.
CALIBRATE switch	OFF.
SELECTIVITY control	O.
RF GAIN control	Fully clockwise.
CRYSTAL FILTER SELECTIVITY control.	Fully counterclockwise.
PHASING control	Index lines lined up.
OFF-STANDBY-ON switch	ON.
BREAK-IN switch	OFF.

b. Tuning Frequency Shift Exciter.

Component	Switch or control	Action and indication
Receiver (frequency standard)	BFO switch	Operate to ON position. Adjust the other controls (par. 33b).
Teletypewriter control unit	XMTR ON-XMTR OFF switch	Operate to XMTR OFF position.
Frequency shift exciter	OSCILLATOR TUNING control	Rotate slowly until zero beat is heard in loudspeaker.
	BUFFER TUNING control	Rotate for maximum brilliance in BUFFER INDICATOR lamp.
	TEST switch	Operate to NORM position.
Cord CG-390/U		Insert plug into PHONES jack on receiver being used as frequency standard. Connect the other end to FREQUENCY METER IN connector on frequency shift exciter (figs. 22-24).
Headset HS-30-(*) (headset)		Obtain a headset from the storage cabinet (fig. 2).
Frequency shift exciter	PHONES 850 ~ TEST jack	Insert headset plug into this jack. Place the headset on your head.
	TEST OSC 850 ~ switch	Operate to up position; 850 cps tone is heard in headset.
	VOLUME 850 ~ TEST control	Adjust for comfortable volume.
	TEST switch	Operate to SPACE position. Two tones are heard in headset. If the tone is too loud in the loudspeaker, turn the AUDIO GAIN control on the receiver until the tone is just audible.
	SHIFT control	Carefully move a few divisions to left or right of its preset position until the two notes blend into one tone and 850 ~ TEST indicator lamp stops fluttering and shows the narrowest angle. Recheck the mark frequency for zero beat again.
	TEST OSC 850 ~ switch	Operate to OFF position. Tone stops.
	TEST switch	Operate to MARK position. Zero beat should be obtained in loudspeaker. If not, readjust OSCILLATOR TUNING control.
	OSCILLATOR TUNING control	Carefully readjust for zero beat in loudspeaker.

Component	Switch or control	Action and indication
Headset HS-30-(*) Frequency shift exciter	BUFFER TUNING control	Readjust for maximum brilliance in BUFFER INDICATOR lamp. Recheck for space signal again.
	TEST switch	SPACE position.
	TEST OSC 850 ~ switch	Up position. Two tones are heard.
	SHIFT control	Carefully readjust until two tones blend into one; 850 ~ TEST indicator lamp stops fluttering and shows narrowest angle. Continue slightly readjusting OSCILLATOR TUNING control and SHIFT control until zero beat (mark) and 850-cps test tone (space) are constant when TEST switch is alternately operated from MARK to SPACE position.
	TEST OSC 850 ~ switch	Operate to OFF position. Tone in headset stops.
	TEST switch	Operate to MARK position. Tune transmitter (<i>c</i> below) with switch in this position.
	OSCILLATOR TUNING, BUFFER TUNING, and SHIFT controls.	Remove headset. Lock controls.

c. Tuning Transmitter for RTT Operation.

- (1) After the frequency shift exciter is tuned (*b* above), tune the transmitter. Refer to TM 11-826. When reference is made to operation of the PLATE POWER switch, use the following procedure.
 - (a) When the PLATE POWER switch is to be operated to the OFF (down) position, operate the TEST switch on the frequency shift exciter to the NORM position.
 - (b) When the PLATE POWER switch is to be operated to the ON (up) position, operate the TEST switch on the frequency shift exciter to the MARK position.
- (2) After the transmitter is tuned, lock the P.A. PLATE TUNING control.
- (3) Adjust for speech operation (*d* below).

d. Tuning Transmitter and Speech Amplifier for Voice Operation Simultaneous with RTT Operation. After the transmitter and frequency shift exciter have been tuned (*b* and *c* above), proceed as follows:

- (1) Remove Microphone T-50 (microphone) from the storage cabinet (fig. 2).
- (2) Insert the microphone connector into the

DYNAMIC MIC. 2 receptacle on the speech amplifier.

Note. If remote operation is not to be used (par. 40), Microphone T-17-(*) (microphone) may be used. Remove the plug of Cable Assembly CX-2482/U from the CARBON MIC. 1 jack and insert the plug of the microphone into this jack.

- (3) Operate the PHONE-CW switch to the PHONE position on the transmitter.
- (4) Adjust the transmitter and the speech amplifier (TM 11-5054 or TM 11-826). *Adjust for MODULATOR PLATE meter peaks of 100 ma* (to prevent overmodulation from introducing errors in RTT signals).
- (5) Since simultaneous voice operation with RTT is the normal arrangement, leave the transmitter PHONE-CW switch in the PHONE position.
- (6) Operate the TEST switch on the frequency shift exciter to the NORM position.
- (7) Operate the XMTR ON-XMTR OFF switch on the teletypewriter control unit to the XMTR OFF position until ready to transmit to the distant station. Then operate the switch to the XMTR ON position.

35. Tuning to Distant Station, Full-duplex Operation

For single channel operation, one receiver is tuned (*a* below). For space diversity operation,

the second receiver is tuned (*b* below).

a. Tuning Channel A Receiver. Request R-Y's from the distant terminal and perform the following operations:

Component	Control	Action and indication
Teletypewriter control unit	TT TRANSPOSE switch	Operate to LEFT REC-RIGHT SEND position.
Frequency shift converter	OUTPUT switch METER B switch NEUTRAL OUTPUT control	Operate to MARK position. Operate to NEUTRAL position. Adjust to obtain 60-ma indication on METER B. If unable to obtain 60 ma, adjust LINE INCREASE control on the teletypewriter.
Teletypewriter control unit	OUTPUT switch	Operate to SPACE position. Receiving teletypewriter runs open.
Teletypewriter control unit	TT TRANSPOSE switch	Operate to NORMAL position. Receiving teletypewriter runs closed.
Teletypewriter control unit	TT TRANSPOSE switch	Operate to RIGHT REC-LEFT SEND position. Adjust LINE INCREASE control on teletypewriter to obtain 60-ma indication on METER B.
Frequency shift converter	TT TRANSPOSE switch	Operate to LEFT REC-RIGHT SEND position.
Frequency shift converter	TT TRANSPOSE switch	Set all controls (except disabling switches) as given in paragraph 31.
Receivers, channel A and channel B	CHANNEL A OPERATE-DISABLED switch. CHANNEL B OPERATE-DISABLED switch.	Operate to OPERATE position. Operate to DISABLED position.
Receivers, channel A and channel B	OFF-STANDBY-ON switch	Operate to ON position.
Receivers, channel A and channel B	AVC switch	Operate to ON position.
Receivers, channel A and channel B	BFO switch	Operate to ON position.
Receivers, channel A and channel B	BFO PITCH control	Set to white mark.
Receivers, channel A and channel B	RF GAIN control	Set to maximum position.
Receivers, channel A and channel B	LIMITER switch	Operate to ON position.
Receivers, channel A and channel B	CRYSTAL SELECTIVITY switch	Operate to 0 position.
Receivers, channel A and channel B	PHASING control	Set to white line.
Receiver, channel A	KILOCYCLES control	Adjust for maximum indication on meter B, equal deflections around zero on meter A, and clear R-Y's on receiving teletypewriter.
Frequency shift converter	OUTPUT switch	Operate to NORMAL position. If S-Y's appear on the receiving teletypewriter, change OUTPUT switch to REVERSE position. Adjust the second receiver if one is being used (<i>c</i> below). Adjust drift compensator circuit if necessary (<i>d</i> below).
Teletypewriter	Armature and range controls	Adjust for best operation (TM 11-2234 for TT-4A/TG, or TM 11-352 for TT-55/MGC).
Teletypewriter control unit	PERFORATOR OPERATION switch.	Operate to RECEIVE TT position.
Reperforator	Motor and range controls	Adjust for best operation (TM 11-2201 for TT-56/MGC or TM 11-2225 for TT-76/GGC).
Teletypewriter control unit	PERFORATOR OPERATION switch.	Operate to PUNCH TAPE position.
Channel B receiver	PERFORATOR OPERATION switch.	Tune if required (<i>b</i> below).

b. Tuning Second Receiver. Tune the channel B receiver (for space diversity operation) after the operations given in *a* above have been performed.

Component	Control	Action and indication
Frequency shift converter	CHANNEL A OPERATE-DISABLED switch.	Operate to DISABLED position.
Receiver, channel B	CHANNEL B OPERATE-DISABLED switch. METER B switch	Operate to OPERATE position. Operate to INPUT position.
Receiver, channel B	KILOCYCLES control	Adjust for maximum indication on receiver meter and on frequency shift converter meter B.
Frequency shift converter	METER B switch	Operate to CHAN B position.
Receiver, channel B	KILOCYCLES control	Adjust slightly until equal deflections around zero are obtained on the frequency shift converter meter B and for R-Y's on receiving teletypewriter.
Frequency shift converter	CHANNEL A OPERATE-DISABLED switch.	Operate to OPERATE position.
Receiver, channel A	RF GAIN control	Operate to maximum position.
Receiver, channel B	RF GAIN control	Adjust until maximum swings of meter B needle equal swings of meter A needle. Adjust drift compensator, if required (<i>c</i> below).
Teletypewriter, receiving	Armature and range controls	Adjust for best operation (TM 11-2234 for TT-4A/TG or TM 11-352 for TT-55/MGC).

c. Drift Compensator Adjustments. The drift compensator feature need not be used if the output of the receiver remains stable. A sufficiently stable output is indicated if it is not necessary to retune the receiver more often than once an hour. Do not use the drift compensator feature if weak signals are received with prevailing noise levels. Maintain accurate tuning by constantly monitoring the output on the converter meters. If two receivers are being used, use channel A receiver for the adjustment.

Caution: With drift compensator circuit operating, a circuit in the frequency shift exciter adjusts itself very slowly whenever the KILOCYCLES control on the receiver is moved. Therefore, to prevent errors in the received copy on the

teletypewriter, readjust the KILOCYCLES control a slight movement at a time until the required indications on the frequency shift converter meters are obtained.

- (1) If two receivers are in operation, operate the disabling switches as follows:
 - (a) Operate the CHANNEL A OPERATE-DISABLED switch to the OPERATE position.
 - (b) Operate the CHANNEL B OPERATE-DISABLED switch to the DISABLED position.
- (2) Request R-Y's from the distant station. At the conclusion of the adjustments ((3) below), request the distant station to stop sending R-Y's.

Component	Control	Action and indication
Frequency shift converter	BAND WIDTH switch DRIFT COMPENSATOR switch	WIDE position. IN position. Teletypewriter should type garbled copy. OUTPUT switch must be changed.
	OUTPUT switch	Change from NORMAL to REVERSE position or vice versa.
	METER B switch	COMP AMP position.
	AMP GAIN control	Fully counterclockwise position.
	LIMITER control	Fully clockwise position.
	AMP GAIN control	Adjust slowly clockwise for an indication of minimum kicks on meter B and needle settles near zero; teletypewriter should start printing clear copy. Then advance the control about 30° or 40° farther.
Receiver	KILOCYCLES control	If meter will not center around zero, very slowly adjust until meter needle centers around zero.
Frequency shift converter	METER B switch	CHAN A + B position.
Receiver	OFF-STANDBY-ON switch	STANDBY position.
Frequency shift converter	LIMITER control	Adjust until meter B needle indicates +70.
Receiver	OFF-STANDBY-ON switch	ON position.
	KILOCYCLES control	Adjust until meter B needle centers around zero.

Section IV. ONE-WAY REVERSIBLE PROCEDURES

36. One-Way Reversible Operation

In one-way reversible operation, the transmitter and receiver do not operate at the same time; both stations operate on the same frequency. When the transmitter is used, the receivers are disabled; when the receivers are used, the transmitter is disabled. One station, called station A, controls the operation in the system.

a. Preliminary Procedures at Both Stations.

- (1) If a single channel (one receiver) operation is used, install one doublet antenna (pars. 23 and 24). If space diversity operation is used, install both doublet antennas (pars. 23 and 24). The whip antennas can be used if desired (par. 22).
- (2) Perform the procedures given in paragraphs 31 and 32.
- (3) Install a pa plate tuning coil and a transmitter tuning unit in the transmitter (par. 34a(4)).
- (4) Preset the transmitter controls for the RTT frequency.
- (5) Calibrate and set channel A (and channel B, if space diversity reception is used) receiver for the RTT frequency (TM 11-854). Operate channel A (and chan-

nel B, if used) receiver BREAK-IN switch to the ON position.

b. Station A Tuning Procedure.

- (1) Tune the frequency shift exciter and transmitter (par. 34b through d). Record the setting of the P.A. PLATE TUNING control.
- (2) Prepare an R-Y test tape on the reperforator (par. 39g). Insert the tape into the transmitter distributor and transmit the test signal (par. 39f (1) or (2)).
- (3) Check to see that channel A (and channel B, if used) receiver BREAK-IN switch is operated to the ON position. Operate the teletypewriter control unit XMTR ON-XMTR OFF switch to XMTR ON position. At this point, the signal is on the air; station B tunes channel A receiver on the test signal (c(1) below). The signal is also received on terminal A receiver and teletypewriters.
- (4) Tune channel A receiver (par. 35b). Tune channel B receiver if it is being used (par. 35c).
- (5) On the teletypewriter control unit, operate the XMTR ON-XMTR OFF switch to

the XMTR OFF position; operate the ONE WAY-FULL DX switch to the ONE-WAY position.

- (6) Stop the transmitter distributor.
- (7) Adjust the mark-hold circuit (par. 38).

c. Station B Tuning Procedures.

- (1) When the test signal from station A (*b*(3) above) is detected, tune channel A receiver (par. 35*b*). Tune channel B receiver if it is being used (par. 35*c*).
- (2) Check to see that channel A (and channel B, if used) receiver BREAK-IN switch is operated to the ON position.
- (3) Operate the teletypewriter control unit XMTR ON-XMTR OFF switch to the OFF position.
- (4) On the transmitter, operate PLATE POWER switch to the off (down) position; open the top right compartment door.
- (5) Tune the frequency shift exciter (par. 34*b*).
- (6) Prepare an R-Y test tape on the reperfector (par. 39*g*). Insert it into the transmitter distributor and transmit the test signal (par. 39*f* (1) or (2)).
- (7) Slightly adjust the frequency shift exciter OSCILLATOR TUNING control until channel A receiver meter needle deflects to maximum position, and the frequency shift converter meter A needle deflects equally about zero.
- (8) Operate the frequency shift converter OUTPUT switch to the NORMAL position.
- (9) Operate the MOTOR switch on the receiving teletypewriter to the ON position. R-Y's should appear on the receiving teletypewriter.
- (10) If S-Y's appear, operate the frequency shift converter OUTPUT switch to the REVERSE position.
- (11) Slightly readjust the frequency shift exciter OSCILLATOR TUNING control until error-free copy is received.
- (12) Turn off the transmitter distributor.
- (13) Adjust the mark-hold circuit (par. 38).
- (14) Tune the transmitter for RTT and voice operation (par. 34*c* and *d*).
- (15) Operate the teletypewriter control unit FULL DX-ONE WAY switch to the ONE WAY position.

- (16) Record the setting of the transmitter P.A. PLATE TUNING control.

d. Operating Procedures. Perform the applicable procedures in (1) through (3) below after the lineup procedures given in *a* through *c* above have been completed.

- (1) *Transmitting RTT frequency.* Transmission must be coordinated with the receiving station ((3) below).
 - (a) Operate channel A receiver BREAK-IN switch to the ON position.
 - (b) On channel B receiver operate the BREAK-IN switch to the OFF position and the BFO switch to the OFF position. The receiver is not disabled; transmission from the distant station can be received.
 - (c) Check to see that the transmitter BAND switch is operated to position 1 (using the transmitter tuning unit set for the RTT frequency).
 - (d) On the teletypewriter control unit operate the TEST switch to the NORM position and the XMTR ON-XMTR OFF switch to the XMTR ON position.
 - (e) Communicate with the receiving station using the microphone or the teletypewriter equipment as desired.
 - (f) When communication is finished, operate the teletypewriter control unit XMTR ON-XMTR OFF switch to the XMTR OFF position.
- (2) *Transmitting voice break-in frequency.* Transmission on the voice break-in frequency is usually made by the receiving station while RTT traffic is being received ((3) below).
 - (a) Operate channel B receiver BREAK-IN switch to the ON position.
 - (b) Operate the transmitter BAND switch to position 2 (using the transmitter tuning coil set for the voice break-in frequency).
 - (c) Set the transmitter P.A. PLATE TUNING control to the position used for the beat tuning of the voice break-in frequency.
 - (d) Operate the teletypewriter control unit XMTR ON-XMTR OFF switch to the XMTR ON position.
 - (e) Use the microphone to communicate with the distant transmitting station.

(3) *Receiving RTT frequency.*

- (a) On channel A and B receivers, operate the BFO switch to the OFF position and the BREAK-IN switch to the OFF position (both receivers are enabled).
- (b) To "break in" on the transmitting station, follow the procedures given in (2) above.

37. One-Way Reversible Net Operation

In one-way reversible net operation, one of the stations in the net is called the *net control station* (NCS) (terminal A in par. 36) and controls net operation. In addition to the RTT frequency, a second frequency for voice break-in is required. The RTT frequency and the voice break-in frequency should have 100-kc minimum separation and 500-kc maximum separation. Channel A receiver is tuned to the RTT frequency; Channel B receiver is tuned to the voice break-in frequency. The number of stations that can participate in a net depends on the amount and type of traffic that must be handled. Since each station has two transmitting frequencies, crossband communication among the stations of the net is possible (fig. 29).

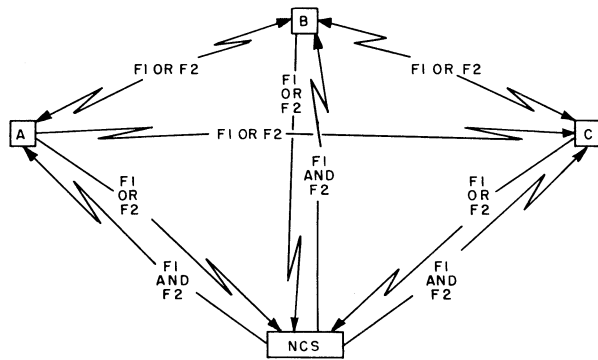

LEGEND:
NCS = NET CONTROL STATION
A, B, C = OUTLYING STATIONS
F1 = RTT FREQUENCY
F2 = BREAK-IN VOICE FREQUENCY

TM 5820-202-10-32

Figure 30. One-way reversible RTT net diagram.

a. Preliminary Procedures at All Stations

- (1) Install the doublet receiving antenna for the RTT frequency (pars. 23 and 24). Install the second doublet receiving antenna for the voice break-in frequency. The transmitting antenna is set up at the mean length of the RTT and voice break-in frequency and installed (pars. 23 and 24). Whip antennas can be used if desired (par. 22).

- (2) Perform the procedures given in paragraphs 31 and 32.
- (3) Install a pa plate tuning coil and a transmitter tuning unit for RTT frequency in the transmitter. Set the transmitter tuning unit M.O.-XTAL switch to the XTAL position. Install a second transmitter tuning unit for the voice break-in frequency in channel 2 position in the transmitter. Set the transmitter tuning unit M.O.-XTAL switch to the M.O. position.

- (4) Set the transmitter controls to the setting indicated in the transmitter tuning chart for the RTT frequency.
- (5) Calibrate and set channel A receiver for the RTT frequency (TM11-854). Calibrate and set channel B receiver for the break-in frequency (TM11-854). Operate channel A and channel B receivers BREAK-IN switches to the ON position.

b. Net Control Station Tuning Procedure.

- (1) Tune the transmitting equipment for RTT operation (par. 36b). Record the setting of the transmitter P.A. PLATE TUNING control.
- (2) Operate the transmitter BAND switch to position 2.
- (3) Insert Microphone T-50 (microphone) into the DYNAMIC MIC. 2 receptacle on the speech amplifier.

Note. If remote operation is not going to be used (par. 40), Microphone T-17(*) (microphone) may be used. Remove the plug of Cable Assembly CX-2482/U from the CARBON MIC. 1 jack and insert the plug of T-17(*) into this jack.

- (4) Adjust the transmitter and speech amplifier to zero beat with channel B receiver, using the master oscillator (mo) procedures of the transmitter (TM 11-826). Use the teletypewriter control unit XMTR ON-XMTR OFF switch to turn the transmitter plate power on and off, as required (par. 34c(1)(a)).
- (5) At this point, the stations in the net tune channel B receiver on this frequency (c(2) below).
- (6) Record the setting of the transmitter P. A. PLATE TUNING control.
- (7) Operate the teletypewriter control unit XMTR ON-XMTR OFF switch to XMTR OFF position.

- (8) Operate channel B receiver BREAK-IN switch to the OFF position.
- (9) This completes the line-up of the NCS; the net stations complete the tuning of their transmitting equipment (*e*(3) below).

c. Net Stations Tuning Procedures. When the NCS tunes the transmitter on the RTT frequency (*b*(1) above), all outlying net stations will tune channel A receiver ((1) below). When the NCS tunes the transmitter on the voice break-in frequency (*b*(5) above), all outlying stations will tune channel B receiver ((2) below). Then each station locally tunes its transmitting equipment against the receivers ((3) below).

- (1) Tune in and adjust the equipment for the RTT signal (par. 36*c*).
- (2) When the voice break-in signal is transmitted (*b*(5) above), tune channel B receiver (par. 36*b*).
- (3) Tune in and adjust the equipment (*b*(2)–(9) above).

d. Operating Procedures. Transmission and reception are performed in the same manner as for one-way reversible operation (par. 36*d*). Cross-band operation on voice among the net stations (fig. 30) is performed by transmitting voice simultaneously with the RTT traffic and receiving the reply (on channel B receiver) from the distant station which transmits on the voice break-in frequency.

38. Adjustment of Mark-hold Circuit, Frequency Shift Converter

The mark-hold feature is provided to maintain a steady marking condition automatically if the signal level drops below the noise level or dis-

appears for any reason. *It must be used for one-way reversible service.* For full-duplex service, the carrier-control mark-hold feature is not required. It is removed by turning the MARK HOLD LEVEL control to the extreme counterclockwise position until a click is heard. When the mark-hold feature is used, the following adjustments are made:

a. On the receiver, turn the MARK HOLD LEVEL control fully clockwise.

b. With the power at the distant transmitter off or with the receiver on STANDBY, verify that a steady marking signal is connected to the receiving dc loops (the teletypewriter does not run open). Do not turn the receiver RF GAIN down for test because total noise should be present.

Note. Occasional kicks may be transmitted if a relatively high noise level prevails. In this case, slowly turn the MARK HOLD LEVEL control counterclockwise until a steady marking signal is produced.

c. When the transmitter signal is again received, verify that the setting (*b* above) will not cause a steady mark signal which will prevent reception of the teletypewriter message.

d. Check the setting of the MARK HOLD LEVEL control from time to time, because it is important to provide a setting which is as far clockwise as possible. This setting should be such that the mark-hold circuit will not interfere when weak or fading rf signals are received, yet far enough counterclockwise to provide application of a steady marking signal to keep the teletypewriters from running open when the received signal is disconnected. The setting of the control is subject to some change due to variable noise levels and different RF GAIN control adjustments of the associated receivers.

Section V. TELETYPEWRITER, REPERFORATOR, MISCELLANEOUS, AND STOPPING PROCEDURES

39. Teletypewriter, Reperforator, and Transmitter Distributor Operations

After the transmitting and receiving equipments have been tuned and adjusted, the system is ready for message traffic. Refer to the applicable technical manual for the operating procedures of the teletypewriter equipment. Use the applicable procedures given in *b* through *g* below to transmit and receive messages on the teletypewriter equipment.

a. General.

- (1) *Teletypewriters.* The positions of the teletypewriter control unit TT TRANSPOSE switch positions (LEFT REC-RIGHT SEND, RIGHT REC-LEFT SEND) indicate which unit will function for receiving and which will function for sending. Usually, the TT TRANSPOSE switch is operated to the LEFT REC-RIGHT SEND position.

(2) *TT-56/MGC or TT-76/GGC.*

(a) *Transmitting distributor.* Messages are sent from this unit by placing the desired punched tape in the unit and operating its switches. Tape messages are sent from this unit to the distant terminal by operating the SEND-STOP switch to the SEND position and the MOTOR switch to the ON position.

(b) *Reperforator.* Local operation, transmission, and reception on this unit are controlled by the teletypewriter control unit PERFORATOR OPERATION switch. In the SEND TT position, messages are transmitted to the distant terminal; in the RECEIVE TT position, messages are received on the unit; in the PUNCH TAPE position, the unit operates within itself.

(3) *Preliminary requirements.* The procedures given in *b* through *f* below require the following preliminary operations:

(a) On the TT-55/MGC, operate the motor switch on both sending and receiving teletypewriters to the ON position. Operate the SEND-REC-BREAK switch on the sending teletypewriter to the SEND position, and, on the receiving teletypewriter, operate the switch to the REC position.

(b) On the TT-56/MGC, operate the MOTOR switch to the ON position, and on the transmitter distributor, operate the MOTOR ON-MOTOR OFF switch to the MOTOR ON position. The transmitter distributor START-STOP switch is operated to the STOP position unless indicated otherwise.

(c) On the TT-76/GGC, operate the POWER, LIGHT, and MOTOR switches to the ON position. The transmitter distributor START-STOP switch is operated to the STOP position unless indicated otherwise.

b. Transmitting From Send Teletypewriter Only.

(1) Operate the teletypewriter control unit PERFORATOR OPERATION switch to the PUNCH TAPE position.

(2) Transmit from the send teletypewriter. The message is transmitted to the distant

station; the sending teletypewriter monitors the message by printing page copy.

c. Receiving on Receive Teletypewriter Only.

(1) Operate the teletypewriter control unit PERFORATOR OPERATION switch to the PUNCH TAPE position.

(2) The incoming RTT message is printed on the receiving teletypewriter as page copy.

d. Transmitting from Reperforator Keyboard.

(1) Operate the teletypewriter control unit PERFORATOR OPERATION switch to the SEND TT position.

(2) On the TT-56/MGC, operate the MOTOR switch to the on (up) position.

(3) On the TT-76/GGC, operate the SELECTOR switch to position 1; and operate the KEYBOARD switch to the SEND position.

(4) Type on the reperforator keyboard. The message is sent to the distant station; the typing reperforator prints and perforates tape; the receiving teletypewriter monitors the message by printing page copy.

(5) Transmitting from the sending teletypewriter provides the same results as given in (4) above.

e. Receiving on Reperforator.

(1) Operate the teletypewriter control unit PERFORATOR OPERATION switch to the RECEIVE TT position.

(2) On the TT-56/MGC, operate the MOTOR switch to the on (up) position.

(3) On the TT-76/GGC, operate the SELECTOR switch to position 1.

(4) The reperforator prints and perforates tape of the received RTT message, and the message appears as page copy on the receiving teletypewriter.

f. Transmitting from Transmitter Distributor.

Insert prepared tape (*g* below) in the transmitter distributor. The position of the teletypewriter control unit PERFORATOR OPERATION switch has no effect on transmission from the transmitter distributor.

(1) On the TT-56/MGC, transmitter distributor, operate the STOP-SEND switch to the SEND position.

(2) On the TT-76/GGC, transmitter distributor, operate the STOP-START switch to the START position; operate the SELECTOR switch to position 1.

- (3) The message is sent to the distant station; the sending teletypewriter monitors the message by printing page copy.
- (4) When the PERFORATOR OPERATION switch is operated to the SEND TT position (in addition to operation *e*(4) above), the reperforator prints the message and perforates tape.

g. Reperforator Local Operation. To operate the reperforator locally without transmitting and receiving to other equipment, operate the teletypewriter control unit PERFORATOR OPERATION switch to the PUNCH TAPE position. Prepare the desired tape using the reperforator keyboard (TM 11-2201 or TM 11-2225). Put the tape on the transmitter distributor and transmit the message to the distant terminal (*f* above).

40. Remote Operation

a. Preliminary Procedures. Install the lines (par. 26*d*) and the equipment required at the remote site (par. 14*c*). Check to see that the cabling at the radio set control is in place (figs. 23 through 25). Before operating, make the following tests:

- (1) Operate the remote switching control ON-OFF switch to the OFF position.
- (2) Operate the radio set control switches as follows—

Switch	Position
ON-OFF.....	OFF.
TELEPHONE.....	LOCAL.
ONE WAY-DUPLEX.....	ONE WAY.
TELETYPE.....	LOCAL.

- (3) Communicate with the remote location.
- (4) On Teletypewriters TT-4A/TG, check the current meter for current indication. If the meter needle reads reverse, interchange the field wires for that teletypewriter. Adjust the current to 60 ma. Operate the motor switch on the teletypewriter equipment to the ON position.
- (5) After the radio set is tuned for RTT and

voice operation (pars. 33 through 38), operate the radio set control switches as follows—

Switch	Position
ON-OFF.....	ON.
TELEPHONE.....	RADIO.
ONE WAY-DUPLEX.....	DUPLEX.
TELETYPE.....	RADIO.

- (6) Operate the BFO switch to the ON position and tune in a signal on one of the receivers.
- (7) Adjust the radio set control HYBRID BALANCE for a minimum indication on the speech amplifier MODULATION meter.

b. Operations.

- (1) Before using the telephones in radio telephone operation (one-way reversible or full-duplex), readjust the audio amplifier (par. 34*d*(4)) while speaking on the telephone in the shelter and then on the telephone at the remote site. If feedback occurs while using the telephone in the shelter, disconnect the loudspeaker from the receiver and use the telephone for listening.

Note. During full-duplex radiotelephone operation, be sure that a telephone is connected to the proper terminals on the remote switching control (fig. 26). If not, the HYBRID BALANCE will not be effective; improper operation can result.

- (2) The following chart shows the switch positions for the various functions of the control group and the resulting pilot light indications. A column is included to indicate the proper position of the frequency shift exciter Test switch. Also, a column to show the condition of the transmitter (on or off) is included. *Local telephone* in the *Function* column means local telephone communication between shelter and remote site. *Local teletypewriter* means local teletypewriter communication between shelter and remote site.

Function	Local control unit							Remote control unit		Frequency shift exciter	Transmitter
	Switches				Pilot lamps			ON-OFF switch	TRANS lamp	TEST switch	
	ON-OFF	TELEPHONE	ONE WAY-DUPLEX	TELETYPE	RECEIVE	LOCAL TELETYPE	TRANS				
Receive RTT, one-way reversible. Local telephone.	ON	LOCAL	ONE WAY	RADIO	On	Off	Off	OFF	Off	NORMAL	Off
Transmit RTT, one-way reversible. Local telephone.	ON	LOCAL	ONE WAY	RADIO	Off	Off	ON	ON	On	NORMAL	On
Transmit radiotelephone, one-way reversible.	ON	RADIO	ONE WAY	RADIO	Off	Off	On	On	On	NORMAL	On
Receive radiotelephone one-way reversible.	ON	RADIO	ONE WAY	RADIO	On	Off	Off	Off	Off	NORMAL	Off
Receive and transmit RTT, full-duplex. Local telephone.	ON	LOCAL	DUPLEX	RADIO	On	Off	On	OFF	Off	NORMAL	On
Receive and transmit RTT and radiotelephone, full-duplex.	ON	RADIO	DUPLEX	RADIO	On	Off	Off	OFF	Off	NORMAL	On
Receive and transmit radiotelephone, full-duplex. Local teletypewriter.	ON	RADIO	DUPLEX	LOCAL	On	On	Off	OFF	Off	MARK	On

Note. For all modes of operation performed at the remote location, except local telephone, set the ON-OFF switch on the local control unit at ON. Local telephone service may be used in either position of the ON-OFF switch.

41. Miscellaneous Operations

a. CW Transmission With Key J-45.

- (1) Operate the teletypewriter control unit NORMAL-CW BREAK-IN switch (at rear of unit) to the CW BREAK-IN position.
- (2) Operate the transmitter PLATE POWER switch to the off (down) position and the PHONE-CW switch to the CW position.
- (3) Operate the frequency shift exciter TEST switch to the MARK position.
- (4) Tune the frequency shift exciter and the transmitter (par. 34b and c).
- (5) Operate the frequency shift exciter TEST switch to the NORM position.
- (6) Operate the teletypewriter control unit XMTR ON-XMTR OFF switch to the XMTR ON position.

(7) Insert the plug of the cord on Key J-45 into the teletypewriter control unit CW KEYING jack.

(8) Depress the key of J-45. The frequency shift exciter BUFFER INDICATOR lamp lights.

(9) Release the key of J-45. The frequency shift exciter BUFFER INDICATOR lamp goes out.

(10) Operate the key for CW operation.

(11) The distant terminal operates the receiver BFO switch to the ON position when tuning for CW reception.

b. Frequency Shift Transmission With Key J-45.

(1) Tune the frequency shift exciter and transmitter (par. 34b and c).

(2) Operate the frequency shift exciter TEST switch to the NORM position.

- (3) Operate the teletypewriter control unit FULL DX-ONE WAY switch to the ONE WAY position, and the XMTR ON-XMTR OFF switch to the XMTR ON position.
- (4) Operate the teletypewriter motor switches to OFF.
- (5) Remove the plug of Cable Assembly CX-1324/U from the teletypewriter control unit FS KEYING jack and insert the cord plug from Key J-45 into this jack.
- (6) Depress the key of J-45; a mark signal is transmitted.
- (7) Release the key of J-45; a space signal is transmitted.
- (8) The distant terminal operates the receiver BFO switch to ON when tuning for frequency shift reception.
- (9) Voice transmission is still possible when the transmitter and audio frequency amplifier are adjusted (par. 34*d*).

42. Antijamming Procedures

When the receiver is being jammed by unwanted signals, the immediate superior officer must be notified promptly. However, the operator must not cease operating the equipment under any condition. One or more of the following procedures may be used for obtaining the maximum intelligibility from the desired signals during the jamming process.

a. Jammed AM Signals by CW, Pulse, or Other Sharp Noise Signals. Perform the procedures outlined in (1) through (6) below on the receiver.

- (1) Detune the receiver several degrees on either side of the desired signal by using the KILOCYCLES tuning knob. This may cause some separation of the desired signal from the jamming signal.
- (2) Operate the LIMITER switch to the ON position. Strong pulse signals may be reduced greatly. If not, operate the switch to the OFF position.
- (3) Operate the CRYSTAL FILTER SELECTIVITY control to position 1. Adjust the CRYSTAL FILTER PHASING control for the best reception of the desired signals. Repeat the procedures given in (1) above. If the results are unfavorable, operate the SELECTIVITY control to each of the three other positions and adjust the PHASING control each time the SELECTIVITY control is

operated. Again repeat the procedures given in (1) above. When the SELECTIVITY control is in position 4, the receiver is most selective. Selectivity may result in a greater separation of signals.

- (4) Vary the RF GAIN control in both directions. This may reduce the jamming signal enough to permit the comparatively weak wanted signal to be copied. When the radio-frequency gain of the receiver is increased, it is possible to saturate the jamming signal.
- (5) Operate the AVC control to the OFF position. Position the CRYSTAL FILTER SELECTIVITY control either at position 1, 2, 3, or 4 for the best reception. The sensitivity of the receiver will be increased somewhat, and better separation of the wanted signals and the jamming signals may be obtained.
- (6) Vary the AUDIO GAIN control in both directions. The level of the desired signal may be raised enough to saturate the jamming signals and provide perfect copy of the desired signals.
- (7) If the above instructions fail to provide satisfactory separation of the desired signals from the jamming signals, try the following methods:
 - (a) Request a change in frequency and call letters.
 - (b) Request the use of CW signals if AM methods fail.
 - (c) Install the antenna behind a tree, tank, or hill, and change the polarization of the antenna from horizontal to vertical, or vice versa.
 - (d) Change the direction, length, or height of the antenna.
- (8) When the jamming action is so thorough that communication is impossible, make a report to the immediate superior but continue to operate the equipment.

b. Jammed AM Signals by FM and AM Signals, or Bagpipes. Use the methods outlined in *a* above to counteract these types of signals.

c. Jammed CW Signals by CW and Pulse Signals, or Other Type Sharp Noises.

- (1) Repeat the procedures given in *a*(1) and (3) above.
- (2) Vary the BFO PITCH control to separate the tone characteristics of the desired

signal from that of the jamming signal.

- (3) Operate the LIMITER control to the ON position to eliminate strong noise pulses.
- (4) Repeat the procedures given in a(4) through (8) above.

d. *Jammed CW Signals by AM or FM Signals, or Bagpipes, Separately or in Combination.* Repeat the procedures given in a and c above.

e. *Jammed RTT Operation.*

- (1) Perform the procedures in a and b above.
- (2) Perform the following procedures on frequency shift converter:
 - (a) Turn the BANDWIDTH switch to NARROW position.
 - (b) Slowly vary the controls marked CHANNEL A FINE TUNING and/or CHANNEL B FINE TUNING until the best teletypewriter reception is obtained.
 - (c) If dual diversity is used, try channel A and B receivers separately, and then in diversity reception, in addition to all the procedures indicated above.
 - (d) Use the type operation that gives the best teletypewriter reception.

desirable to shut down for a short period of time. Under some circumstances, it may be desirable to shut down more completely. Use procedures in a or b below as desired.

a. *Partial.* Use the following procedure to shut down for a short period of time so that starting up can be accomplished with a minimum of preparation.

- (1) Set the transmitter FILAMENT POWER switch to the off (down) position.
- (2) Set the teletypewriter control unit XMTR ON-XMTR OFF switch to the XMTR OFF position.
- (3) Set the frequency shift exciter TEST key to the NORM position.
- (4) Set the circuit breakers in the shelter to the OFF position.
- (5) Depress the STOP button in the power unit until the engine stops.
- (6) The radio set can be operated again by starting the power unit engine; setting the circuit breakers to the ON position in the shelter; setting the FILAMENT POWER switch in the transmitter to the on (up) position after a suitable time has elapsed.

b. *Complete.* When shutting down completely, operate the control or switch to position indicated for each component in the chart below.

43. Stopping Procedure

For tactical reasons, it may be necessary or

Equipment	Switch or control	Position
Transmitter	PLATE POWER	Off (down).
	FILAMENT VOLTAGE	Fully counterclockwise.
	FILAMENT POWER	Off (down).
Frequency shift exciter	TEST	NORM.
	AC SUPPLY	Off (down).
	OVEN	Off (down).
Radio set control	ON-OFF	OFF.
Rectifier RA-87-(*)	ON-OFF	OFF.
Reperforator (TT-56/MGC)	MOTOR	OFF.
Transmitter distributor (p/o TT-56/MGC).	MOTOR ON-MOTOR OFF	MOTOR OFF.
	STOP-SEND	STOP.
Reperforator (TT-76/GGC)	POWER	OFF.
	MOTOR	OFF.
	LIGHT	OFF.
Transmitter distributor (p/o TT-76/GGC).	START-STOP	STOP.
Teletypewriter TT-55/MGC (if used)	ON-OFF	OFF.
Teletypewriter TT-4A/TG	MOTOR	OFF.
Teletypewriter control unit	ON-OFF	OFF.
	XMTR ON-XMTR OFF	XMTR OFF.

Equipment	Switch or control	Position
Electrical Equipment Cabinet CY-1216/U, blower assembly.	ON-OFF	OFF.
Power Supply PP-712(*)/GRC-26A	PLATE	Off (down).
	AC SUPPLY	Off (down).
Receivers	OFF-STANDBY-ON	OFF.
Shelter	Circuit breaker	OFF.
Power Unit PE-95-(*)	STOP button	Press firmly until engine stops.

Section VI. OPERATION UNDER UNUSUAL CONDITIONS

44. General

The operation of Radio Set AN/GRC-26A may be difficult in regions where extreme cold, heat, humidity and moisture, sand conditions, etc., prevail. In the following paragraphs, instructions are given on procedures for minimizing the effect of these unusual operating conditions.

45. Operation in Arctic Climates

Subzero temperatures and climatic conditions associated with cold weather affect the efficient operation of the equipment. Instructions and precautions for operation under such adverse conditions follow:

- a. Handle the equipment carefully.
- b. Keep the equipment warm and dry. Keep the shelter heater turned on at all times and regulate ventilation as necessary. Electric air heaters are used to heat the shelters. If one is not enough, additional heaters may be requisitioned.
- c. Take precautions to prevent cold air from coming into contact with heated tubes when the shelter door is opened. A sudden draft of cold air may shatter the glass envelope of a heated tube.
- d. Do not attempt to operate teletypewriters when they are cold because the typing mechanism is inoperable at low temperatures and errors will appear frequently. Allow adequate warm-up time.
- e. Heavy coatings of frost will gather on mouth-type microphones in extremely cold weather when the microphones are used in the open air or in a cold room. Breath will cause frost to form in the small holes of the cap, and this will affect transmitter modulation. Rubber and fabric diaphragms have been designed to protect some types of microphones; use them when available. Have a spare microphone ready, if possible, in case the one in use fails to function properly.

f. The equipment will sweat until it is brought up to operating temperature after exposure to the cold. This condition also arises when equipment is used after exposure during a cold night. When the equipment has reached room temperature, dry it thoroughly.

g. Use any improvised means to protect dry batteries against the cold. Preheat the batteries. To prevent heat loss, place them in bags lined with kapok, spun glass fiber materials, or woolen clothing.

h. Keep the RF cable assembly rolled up inside the shelter when it is not being used. The cold weather causes the plastic sheathing to stick together. Unrolling the reel in this condition removes the sheathing and makes the cable useless.

46. Operation in Tropical Climates

a. When operating the equipment in tropical climates, high relative humidity will cause condensation to form on the equipment whenever the temperature of the equipment becomes lower than the ambient air. To minimize this condition, place lighted electric bulbs under the equipment. Dry the equipment thoroughly before operating it.

b. Tape all cable connectors with rubber tape to prevent shorts and leakage caused by moisture.

47. Operation in Desert Climates

a. Conditions similar to those encountered in tropical climates often prevail in desert areas. Use the same measure to insure proper operation of the equipment.

b. The main problem that arises with equipment operation in desert areas is the large amount of sand or dust and dirt which enters the moving parts of radio equipment, such as motors and power units. The ideal precaution is to house the equipment in a dustproof shelter. Such a

building, however, seldom is available and would require air conditioning. The next best precaution is to make the shelter in which the equipment is located as dustproof as possible with available materials. Hang wet sacking over the windows, skylight, and door.

c. Keep the equipment as free from dust as possible. Make frequent preventive maintenance

checks. Pay particular attention to the lubrication of the equipment. Excessive amounts of dust, sand, or dirt that come into contact with oil and grease result in grit, which will damage the equipment.

d. Make periodic checks of doublet antenna guy assemblies to prevent damage during sudden wind squalls which occur in desert areas.

CHAPTER 4

MAINTENANCE INSTRUCTIONS

48. Scope of Operator's Maintenance

a. The following maintenance duties (b below) are normally performed by the operator of Radio Set AN/GRC-26-(*). These procedures cover those components and parts of Radio Set AN/GRC-26-(*), such as Radio Teletypewriter Control C-808/GRC-26, Transmitter-Teletypewriter C-808A/GRC-26A, Radio Set Control Group AN/GRA-14, Mast AB-155A/U, mast base, guys, cords, cables, and all other items used with the radio set, except those covered in a separate technical manual or other publication. For detailed maintenance instructions of other components which comprise the radio set, refer to the appropriate technical manual (par. 1c). These procedures do not require special tools or test equipment.

b. Operator's maintenance for the items listed in a above consists of the following:

- (1) Preventive maintenance (par. 49).
- (2) Visual inspection (par. 50).
- (3) System troubleshooting (par. 51).
- (4) Replacement of defective fuses (par. 52a).
- (5) Checking cable connections.
- (6) Tightening mechanical connections.
- (7) Replacement of parts (par. 52b and c).

49. Preventive Maintenance

DA Form 11-238 (figs. 1 and 2) is a check list to be used by the operator. Items not applicable are lined out in the figures. References in the ITEM block are to paragraphs that contain additional maintenance information pertinent to the particular item. Instructions for the use of the form appear on the back of the form.

b. Items. The information shown in this subparagraph is supplementary to DA Form 11-238. The item numbers correspond to the ITEM numbers on the form.

SEE PAGES 1 & 2 OF C-6

Item	Maintenance procedure
2	Use a clean cloth to remove dust, dirt, and moisture from the air heater, insulators, controls, and the front panels of the equipment. If necessary, wet the cloth with Cleaning Compound and then wipe the parts dry with a clean cloth.
3	All controls should operate freely, be tight on the shaft, and should not bind. Tighten all loose knobs and be sure that they do not rub against the front panel.
10	Check the seating of the fuses, tubes, lamps, and connectors.

Warning: Cleaning Compound is flammable and its fumes are toxic. Provide adequate ventilation.

SEE PAGE 2 OF C-6

50. Visual Inspection

a. Many of the faults appearing in the radio set may be detected by a visual inspection of the system components. Pilot lamps are used to indicate that power has been applied to a component. If the pilot lamps fail to light, check to see that the power cords are connected to the proper receptacles and that the plugs are properly inserted.

b. One type of fault is the improper setting of controls and switches. Check the control and switch settings for the type of operation to be used. Other commonly encountered faults that may be detected by visual inspection are burned-out fuses (usually indicate some other fault) and poorly seated pluck-out type components (tubes, et al.).

50.1 TO 50.3 (ADDED) SEE PAGES 2 & 3 OF C-6

51. Operator's Troubleshooting Check List

The following check list is supplied as an aid in locating trouble in Radio Set AN/GRC-26-(*). This chart lists the symptoms which the operator may observe while operating the equipment.

ADDITIONAL ITEMS FOR 2D AND 3D ECHELON INSPECTIONS		CONDITION	
26. INSPECTOR'S SIGNATURE AND DATE REPAIRS TO BE MADE			
27. CHECK FOR NORMAL OPERATION			
28. SECURE SHIELDING OR SCREENING REMOVE BATTERIES			
IF DEFICIENCIES NOTED ARE NOT CORRECTED DURING THE INSPECTION, INDICATE ACTION TAKEN FOR CORRECTION.			
ITEM 8. TRANSMITTING WHIP ANTENNA MAST BASE MP-47-A INSULATORS CRACKED. REPLACEMENT REQUISITIONED.			

MAINTENANCE CHECK LIST FOR SIGNAL EQUIPMENT
 SOUND EQUIPMENT, RADIO, DIRECTION FINDING
 RADAR, CARRIER, RADIOSONDE AND TELEVISION
 (AR 750-625)

EQUIPMENT NOMENCLATURE
RADIO SET AN/GRC-26C

EQUIPMENT SERIAL NUMBER
3000

INSTRUCTIONS

This form may be used for a period of one month by using the correct dates and weeks of the month. It is to be used as a Preventive Maintenance check list for Signal equipment in actual use, or for a check on equipment prior to issue.

- For detailed Preventive Maintenance instructions see:
 - The Technical Manual (in TM 11 series) for the equipment. (See DA Pamphlet Number 310-4)
 - The Supply Bulletin (SB 11-100 series) for the equipment. (See DA Pamphlet Number 310-4)
 - The Department of the Army Lubrication Order. (See DA Pamphlet Number 310-4)
- The following action will be taken by either the Communications Officer/Chief for 1st echelon, or the Inspector for higher echelon:
 - Enter Equipment Nomenclature and Serial Number.
 - Strike out items that do not apply to the equipment.
- Operator/Inspector will enter in the columns entitled **CONDITION**, on the proper line, a notation regarding the condition, using symbols specified under **LEGEND**.
- After operator completes each daily inspection he will initial over the appropriate dates under "Daily Condition for Month", then return form to his supervisor.

TYPE OF INSPECTION

OPERATOR	2/3 ECHELON	DATE	SIGNATURE
✓		7 MARCH '59	A.C. Duell

DA FORM 11-238
 1 MAY 57

REPLACES DA FORMS 11-238, 1 NOV 55; 11-239,
 11-244, 11-245, 11-248, 11-249, 11-250, AND 11-281;
 WHICH ARE OBSOLETE.

Figure 31. DA Form 11-238, pages 1 and 4.

LEGEND for marking conditions: Satisfactory ✓, Adjustment, Repair or Replacement required, X, Defect corrected, (X).		DAILY CONDITION FOR MONTH OF MARCH 1959																														
		1	2	3	4	5	6	7	8	9	10	11	12	13	14	15	16	17	18	19	20	21	22	23	24	25	26	27	28	29	30	31
NO.	DAILY ITEM																															
1.	COMPLETENESS AND GENERAL CONDITION OF EQUIPMENT. (Transmitter, receiver, carrying cases, wire, cables, microphones, tubes, spare parts, technical manuals).																															
2.	CLEAN DIRT AND MOISTURE FROM ANTENNA. MICRO-PHONES, HEADSETS, KEYS, JACKS, PLUGS, COMPONENT PANELS. PAR. 49b																															
3.	INSPECT CONTROLS FOR NORMAL OPERATION. TAP CONTROLS LIGHTLY FOR EVIDENCE OF CUT-OUT FROM LOOSE CONTACTS. PAR. 49b																															
4.	CHECK FOR NORMAL OPERATION OF EQUIPMENT. BE ALERT FOR UNUSUAL OPERATION OR CONDITION. PAR. 31 THRU 41																															
	WEEKLY	CONDITION EACH WEEK					ADDITIONAL ITEMS FOR 2D AND 3D ECHELON INSPECTIONS					CONDITION																				
		1ST	2D	3D	4TH	5TH	3D	3D	3D	ECH																						
5.	CLEAN AND TIGHTEN EXTERIORS OF CASES, RACKS, MOUNTS, TRANSMISSION LINES.	✓																														
6.	INSPECT CASES, MOUNTS, WIRE AND EXPOSED METAL SURFACES FOR RUST, CORROSION.	✓																														
7.	INSPECT CORDS, CABLE, WIRE, SHOCK MOUNTS FOR CUTS, KINKS, BREAKS, FRAYING, UNDUUE STRAIN.	✓																														
8.	CHECK ANTENNA GUY WIRES FOR PROPER TENSION OR DAMAGE.	X																														
9.	INSPECT CANVAS AND LEATHER ITEMS FOR MILDEW, TEARS, FRAYING.	✓																														
10.	INSPECT ACCESSIBLE ITEMS FOR LOOSENESS: SWITCHES, KNOBS, JACKS, CONNECTORS, TRANSFORMERS, MOTORS, PILOT LIGHTS, BLOWERS, ETC. PAR. 49b	✓																														
11.	CLEAN AND/OR INSPECT AIR FILTERS, BRASS NAME PLATES, DIAL AND METER WINDOWS.	✓																														
12.	INSPECT DIAL BATTERIES FOR LEAKAGE. INSPECT DRY BATTERIES FOR LEAKAGE.	✓																														
	ADDITIONAL ITEMS FOR 2D AND 3D ECHELON INSPECTIONS																															
13.	INSPECT SHELVES FOR OVERHEATING. INSPECT SHELVES FOR OVERHEATING.																															
14.	INSPECT SHELVES FOR OVERHEATING. INSPECT SHELVES FOR OVERHEATING.																															

2

3

CONTINUED ON PAGE 4

TM5820-202-10-36

SEP 1957 O-47034

Figure 32. DA Form 11-238, pages 2 and 3.

Follow the starting procedure described in paragraphs 31 and 32. The information in this paragraph is in the same sequence as the steps in the starting procedure. For troubles in components

other than those described below, refer to individual equipment technical manuals as indicated in the chart. Refer to figures 23 through 26 for cording diagrams.

Item No.	Symptom	Probable trouble	Procedure
1	Power Unit PE-95-G fails to start when START button is pressed.	MANUAL-REMOTE switch on power unit in MANUAL position. Discharged batteries in power unit.	Set MANUAL-REMOTE switch to REMOTE position. Start power unit with hand crank (MANUAL-REMOTE switch must be in the MANUAL position).
		Out of gasoline..... Defective power unit.....	Check power unit gas tank. Higher echelon maintenance required (TM 11-904).
2	Power Unit PE-95-G is running but no power available at shelter.	Faulty connection at either end of Power Cable Assembly CX-1166/U. CIRCUIT BREAKER on panel of power unit in OFF position. Circuit breakers on shelter wall in OFF position.	Check connections for tightness at power unit and shelter. Set CIRCUIT BREAKER on panel of power unit to ON position. Set to ON position.
3	Frequency shift exciter dial or AC SUPPLY lamps will not light when AC SUPPLY switch is set to ON position.	Defective fuse..... Defective lamps..... No ac power to exciter.....	Replace fuse F101, F102, or both. Replace dial or indicator lamp. Check connections to wall receptacles.
4	Frequency shift exciter OVEN indicator will not light when OVEN switch is turned ON.	No ac power to exciter..... Defective lamp.....	Check Cord CX-962/TRA-7; replace if necessary. Higher echelon maintenance required (TM 11-257). Check Cord CX-962/TRA-7; replace if necessary. Check connection to ac outlet. Replace OVEN indicator lamp. Higher echelon maintenance required (TM 11-257).
5	Frequency shift exciter BUFFER INDICATOR will not light.	TEST switch in NORM position.. Open circuit in exciter control relay wiring. Defective BUFFER INDICATOR lamp, or lamp loose in socket.	Set switch to MARK position. Check for faulty connection in either end of Cord CX-961/TRA-7 (red). Disconnect Key J-45 cord plug from CW KEYING jack on teletypewriter control unit. Tighten or replace BUFFER INDICATOR lamp. Higher echelon maintenance required (TM 11-257).
6	No beat note heard in loudspeaker when making final adjustments to frequency shift exciter OSCILLATOR TUNING dial.	Exciter, receiver, or transmitter improperly adjusted. Defective Cord CG-390/U.....	Check settings and readjust controls on exciter, receiver, and transmitter, in accordance with operating instructions (par. 31 through 41). Check connections or Cord CG-390/U. Replace if necessary. Higher echelon maintenance required (TM 11-257).

Item No.	Symptom	Probable trouble	Procedure
7	Audio tone from frequency shift exciter PHONES 850 ~ TEST jack not heard in headset.	Headset not connected to proper jack. Wrong setting of exciter controls	Connect plug from headset into PHONES 850 ~ TEST jack. Check exciter controls in accordance with operating instructions (par. 34b). Higher echelon maintenance required (TM 11-257).
8	Frequency shift exciter 850 ~ TEST indicator does not function when audio beat is heard in headset.	Defective tube	Higher echelon maintenance required (TM 11-257).
9	Operating TEST key on frequency shift exciter from MARK to SPACE causes no change in transmitted frequency.	Defective tube	Higher echelon maintenance required (TM 11-257).
10	No filament power when radio transmitter FILAMENT POWER switch is set at on (up).	Defective fuse Faulty power cord connection	Replace fuse FS1, FS2, or FS4. Check connections on power Cord CD-763. Higher echelon maintenance required (TM 11-826).
11	Transmitter PLATE POWER indicator lamp does not light when exciter TEST key is set at MARK or SPACE or when XMTR ON-XMTR OFF switch on teletypewriter control unit is set at XMTR ON.	Transmitter overload relay open Defective lamp Defective fuse Defective XMTR ON switch S5 in teletypewriter control unit. Faulty control cable connection	Press transmitter OVERLOAD RESET switch. Replace indicator lamp LM4. Replace fuse FS5. Higher echelon maintenance required (TM 11-5820-202-35). Check connections at either end of Cord CX-961/TRA-7 (blue). Check connections at either end of Cord CX-961/TRA-7 (red). Check plug connections at either end of Special Purpose Cable Assembly CX-1152/U. Check connections at either end of Cable Assembly CX-2479/U. Check connections at either end of Cord CD-764. Higher echelon maintenance required (TM 11-826).
12	No current indication on transmitter EXCITATION METER when meter switch is set to INT. AMP. GRID position (transmitter PLATE POWER indicator lamp lighted).	Wrong tuning unit selected Transmitter or controls not adjusted or set correctly. Faulty connection on either end of Cord CG-389/U. Defective tube	Check to see that proper tuning unit is being used. Check BAND SWITCH for correct position. Check MO-XTAL switch on tuning unit (should be in XTAL position). Check adjustment of DOUB control in accordance with operating instructions (TM 11-826). Check for faulty connection of either end of Cord CG-389/U. Transmitter end should be plugged into tuning unit being used. Higher echelon maintenance required (TM 11-826).
13	No current indication on transmitter EXCITATION METER when meter switch is set to P. A. GRID position.	Tuning unit control adjusted incorrectly. Defective tube	Check adjustment of INT. AMP. knob on tuning unit in accordance with operation instructions. Higher echelon maintenance required (TM 11-826).

Item No.	Symptom	Probable trouble	Procedure
14	No indication of radio transmitter plate current on P. A. PLATE current meter (red light on).	Coil unit out or improperly installed in transmitter. Defective tube in transmitter.....	Check for proper installation of coil unit in transmitter. Higher echelon maintenance required (TM 11-826).
15	FILAMENT POWER switch on transmitter in on (up) position and speech amplifier red lamp fails to light.	Transmitter fuse FS5 open..... Lamp LM101 burned out..... Cord CD-764 defective.....	Replace fuse. Replace lamp. Check connections at either end of the cord.
16	Transmitter cannot be voice modulated.	Cord CD-764 defective..... Tube V107 in exciter defective.....	Check connections at either end of the cord. Higher echelon maintenance required (TM 11-5054).
17	Transmitter can be modulated by one microphone but not by the other.	Microphone defective..... Microphone jack or connector defective.	Replace microphone. Higher echelon maintenance required (TM 11-5054).
18	Transmitter cannot be keyed from KEY jack at speech amplifier.	Cord CD-764 defective or KEY jack defective.	Higher echelon maintenance required (TM 11-5054).
19	Converter pilot lamps do not light....	Defective fuse..... Defective lamp I 301 or I 302.... No ac power to converter..... Defective converter.....	Replace fuse F301 or F302. Replace indicator lamps. Check Cord CX-954/TRA-7 and connections. Higher echelon maintenance required (TM 11-5062).
20	Receivers receive teletypewriter signal but converter meter B does not indicate with METER B switch in INPUT position.	Defective RF Cable Assembly CG-562/U.	Check cords and connectors.
21	Dial lights on receiver light but no sound heard in loudspeakers or headset.	Plugs not in proper jacks..... Insufficient volume..... Defective receiver.....	Check Electrical Power Cable Assembly CX-1939/U and connections. Check to see that the cords are connected to the proper jack and terminals. See that RF GAIN controls of receivers are increased sufficiently. Higher echelon maintenance required (TM 11-854).
22	Receiver seems operative but no signals can be heard.	Defective antenna Cord CG-67/MRQ-2. Defective antenna connection.....	Check cord and connectors. Check antenna cord connections, mast base, and receiver. Higher echelon maintenance required (TM 11-854).
23	Receivers not disabled when operating one-way reversible.	BREAK-IN switch in incorrect position. Defective Electrical Special Purpose Cable Assembly CX-1150/U. Defective Electrical Special Purpose Cable Assembly CX-1851/U. Teletypewriter control unit XMTR ON-XMTR OFF switch in XMTR OFF position.	Operate switch to ON position. Check cord and connectors. Check cords and connectors. Check to see that switch is in XMTR ON position while transmitting. Higher echelon maintenance required (TM 11-854 and TM 11-5820-202-35).
24	Teletypewriter motor does not run when MOTOR switch is set to ON position.	No ac power to teletypewriter.... Defective fuse..... Defective teletypewriter.....	Check ac cord, plug, and outlet. Replace fuse. Higher echelon maintenance required (TM 11-352 or TM 11-2234).

Item No.	Symptom	Probable trouble	Procedure
25	Receiving teletypewriter runs open with converter OUTPUT switch on MARK.	<p>Incorrect switch position on teletypewriter control unit.</p> <p>Current too low-----</p> <p>Teletypewriter red plugs not in proper jack.</p> <p>Red plug or cord defective-----</p> <p>Defective teletypewriter-----</p> <p>Defective converter-----</p>	<p>See that the SEND-REC-BREAK key (Teletypewriter TT-55/MGC only) of the right or left teletypewriter used as indicated by the TT TRANSPOSE switch in the radio-teletypewriter control in the REC position and EXTENSION NORMAL switch in NORMAL position.</p> <p>Adjust current (par. 35a).</p> <p>Check that teletypewriter plugs are plugged into proper jacks of teletypewriter control unit.</p> <p>Replace defective cord or plugs.</p> <p>Higher echelon maintenance required (TM 11-352 or TM 11-2234).</p> <p>Higher echelon maintenance required (TM 11-5062).</p>
26	Teletypewriter signal noted on meter B with METER B switch in NEUTRAL position but receiving teletypewriter does not receive copy.	<p>Incorrect connections of teletypewriter red and black plugs.</p> <p>Incorrect switch position on teletypewriter control unit.</p> <p>Defective teletypewriter-----</p>	<p>See that plugs are correctly connected to teletypewriter control unit.</p> <p>See that the TT TRANSPOSE switch is in the proper position for the receiving teletypewriter in use.</p> <p>Higher echelon maintenance required (TM 11-352 or TM 11-2234).</p>
27	Sending teletypewriter runs open-----	<p>SPACE-MARK switch in SPACE position in teletypewriter control unit.</p> <p>Mark current power supply defective or relay 0 1 defective in teletypewriter control unit.</p> <p>Teletypewriter plugs not in proper jacks.</p> <p>Cords or plugs defective-----</p> <p>Defective Special Purpose Cable Assembly CX-1151/U (blue).</p> <p>Defective red and black jacks on teletypewriter control unit.</p> <p>Defective converter-----</p>	<p>Place SPACE-MARK switch in MARK position.</p> <p>Higher echelon maintenance required (TM 11-5820-202-35).</p> <p>See that teletypewriter plugs are plugged into proper jacks on teletypewriter control unit.</p> <p>Repair or replace defective cords or plugs.</p> <p>Check cord and connectors.</p> <p>Higher echelon maintenance required (TM 11-352 or TM 11-2234).</p> <p>Higher echelon maintenance required (TM 11-5062).</p>
28	Sending teletypewriter holds when BREAK key is depressed.	<p>Sending teletypewriter cord with black plug not in proper jack.</p> <p>Defective black cord plug-----</p> <p>Defective jack on teletypewriter control unit.</p> <p>Defective SEND-REC-BREAK switch on Teletypewriter TT-55/MGC only.</p>	<p>Check to see that black plug is connected to proper jack on teletypewriter control unit.</p> <p>Higher echelon maintenance required (TM 11-352 or TM 11-2234).</p> <p>Higher echelon maintenance required (TM 11-5820-202-35).</p> <p>Higher echelon maintenance required (TM 11-352).</p>
29	Reperforator motors do not run when switches are in ON position (TT-56/MGC or TT-76/GGC).	<p>No ac power-----</p> <p>Defective fuse-----</p>	<p>Check power cord, plug, and outlet.</p> <p>Replace fuse.</p>

Item No.	Symptom	Probable trouble	Procedure
30	Reperforator transmits or receives with PERFORATOR OPERATION switch in PUNCH TAPE (TT-56/MGC or TT-76/GGC).	<p>Cords not plugged in proper jacks.</p> <p>Defective cords or plugs.</p> <p>Defective jacks on teletypewriter control unit.</p> <p>Defective dc cord from connection box to Rectifier RA-87-(*).</p> <p>Defective Special Purpose Cable Assembly CX-1120/U or plug.</p> <p>Special Purpose Cable Assembly CX-1120/U not properly connected.</p> <p>Rectifier RA-87-(*). not on.</p> <p>Defective fuse in rectifier.</p> <p>Defective rectifier ac cord.</p> <p>Defective rectifier RA-87-(*).</p>	<p>Check to see that the plugs are connected to proper jacks on the teletypewriter control unit.</p> <p>Refer to figures 22 through 25.</p> <p>Replace defective cord or plug.</p> <p>Higher echelon maintenance required (TM 11-5820-202-35).</p> <p>Repair cord or plug.</p> <p>Replace defective cord.</p> <p>See that proper connection is made in connection box and teletypewriter control unit.</p> <p>Set ON-OFF switch to ON.</p> <p>Replace fuse.</p> <p>Check and repair cord.</p> <p>Connect to ac outlet.</p> <p>Higher echelon maintenance required (TM 11-957 or TM 11-957A).</p>
31	Transmitter distributor does not transmit when STOP-SEND switch is in SEND position on TT-56/MGC or when START-STOP switch on TT-76/GGC is in START position.	<p>Stop rod stuck on TT-56/MGC.</p> <p>Defective unit.</p>	<p>Push clear button, located on lower right side near front of TT-56/MGC transmitter distributor. (This button is labeled.)</p> <p>Higher echelon maintenance required (TM 11-2222 or TM 11-2225).</p>

52. Replacement of Parts

The operator may replace the mast base plate, cable assemblies, clock compass, connector adapters, guys, insulators, and the loudspeaker. The replacement of these items requires no additional instructions or tools other than those furnished with the equipment.

a. Replacement of Fuses.

- (1) Operate the POWER switch to OFF.
- (2) Turn the fuse holder cap counterclockwise until it is released.
- (3) Remove the defective fuse and replace it with a good one. Replace the fuse holder cap.

b. Removal and Replacement of Mast Base MP-65-B.

- (1) Disconnect the antenna lead-in from the mast base connector.
- (2) Unscrew the mast socket from the mast base while holding the lower insulator with the free hand.
- (3) Remove the mast socket and the upper insulator section; remove the lower insulator section.
- (4) Mount the replacement (MP-65-A or

-B) on Mast Bracket MP-50-A (fig. 13). Place a neoprene washer on each side of the feed-through hole of the bracket. Position the metal ring with braid and clamp attached between the bottom washer and the bracket.

- (5) Insert the lower insulator into the bracket and connect the upper insulator section to it. Screw the mast socket into the mast base to secure the insulators.
- (6) Connect the antenna lead-in to the connector or the mast base.

c. Removal and Replacement of Mast Base MP-47-A (fig. 5).

- (1) Remove the antenna lead-in from the binding post of the mast base.
- (2) Demount the mast base from Mast Bracket MT-657/GRC by removing the six bolts, washers, and nuts from the retaining plate. Lift the mast base from the mast bracket.
- (3) Remove the bolts from the binding post assembly while holding the body of the mast base with the free hand.

- (4) Hold the lower insulator in position, and remove the body of the mast base and the upper insulator. Remove the lower insulator.
- (5) Assemble the mast base with the retaining plate and the neoprene gasket between the upper and lower insulators.
- (6) Insert the body of the mast base into the upper insulator and secure the entire mast base assembly by screwing the nuts on the bolt and binding post assembly.
- (7) Mount the mast base in the mast bracket and attach the antenna lead-in.

CHAPTER 5

SHIPMENT AND LIMITED STORAGE AND DEMOLITION TO PREVENT ENEMY USE

Section I. SHIPMENT AND LIMITED STORAGE

53. Disassembly of Equipment

The following instructions are recommended as a guide for preparing the radio set for shipment and storage.

a. Disconnect all outside field lines. Disconnect the power cable to Power Unit PE-95-(*).

b. Roll up power cables and store them in the shelter.

c. Take down the doublet antennas; disconnect the antenna transmission cables. Repack the antennas and replace the antenna transmission cables on the reels.

d. Remove the whip antenna cables from the mast bases and pull them into the shelter. Remove the mast bases by reversing the installation procedures (par. 22). Wrap the mast bases in corrugated paper and place them in the wall cabinet. Place the mast sections in the cabinet compartment.

e. Disconnect the grounding wire. Pull up the ground rod and clean it. Stow the grounding wire and ground rod in the wall cabinet.

f. Remove the pa tuning coils and transmitter

tuning units from the transmitter. Stow them in compartments in the storage cabinet.

g. Cover the teletypewriters, reperforator, and transmitter distributor with the canvas covers. On Teletypewriter TT-4A/TG, lock the platen lock in place to prevent the platen from shifting. The carriage must be first operated to FIG. to raise the platen high enough to engage the platen lock.

h. See that all components are mounted securely and that snubbers are fastened tightly.

i. Remove the fluorescent lamps from fixtures; wrap them for protection and stow them within the shelter. Be careful that none of the fluorescent powder from broken lamps enters cuts or breaks in the skin. It is a dangerous compound.

j. Close all windows, the roof hatch, and the feed-through holes in the shelter.

54. Repackaging for Shipment or Limited Storage

Repackaging of Radio Set AN/GRC-26(*) is covered in TM 11-5820-202-20.

Section II. DEMOLITION OF MATERIEL TO PREVENT ENEMY USE

55. Authority for Demolition

Demolition of the equipment will be accomplished only upon the order of the commander. The destruction procedures outlined in paragraph 56 will be used to prevent further use of the equipment.

56. Methods of Destruction

Use any of the following methods to destroy the equipment.

a. Smash. Smash the controls, tubes, coils, switches, capacitors, transformers, meters, and

power unit engine; use sledges, axes, handaxes, pickaxes, hammers, or crowbars.

b. Cut. Cut all cables and cords; use axes, handaxes, or machetes.

c. Burn. Burn cords and technical manuals; use gasoline, kerosene, oil, flame throwers, or incendiary bombs.

d. Bend. Bend panels, cases, and cabinets.

e. Explode. If explosives are necessary, use firearms, grenades, or TNT.

f. Dispose. Bury or scatter the destroyed parts in slit trenches, foxholes, or throw them in streams.

~~SEE~~
APPENDIX I

REFERENCES

SEE PAGES 4 & 5 OF E-6

1. Following is a list of references which are applicable and available to the operator of Radio Set AN/GRC-26(*):

SB 11-156 Plug PL-258—To be added to Radio Sets AN/GRC-26 and AN/GRC-26A.

SB 11-254 Utilization of Test, Prod, Stock Number 3F3705-12.19 with Equipments T-368()/URT, BC-610(), AM-141()/MRC, AM-494()/GR, and AM-495()/GR.

SB 11-283 Requisitioning Generator Set for Use with Radio Set AN/GRC-26().

SB 11-462 Generator Set for AN/GRC-26, -A, -B, -C, -D, and AN/GRC-41.

TB SIG 223 Field Expedients for Wire and Radio.

TM 11-257 Frequency Shift Exciters 0-39/TRA-7, 0-39A/TRA-7, 0-39B/TRA-7, and 0-39C/TRA-7.

TM 11-333 Telephones EE-8, EE-8-A, and EE-8-B.

TM 11-352 Printer TG-7-A, and Teletypewriters TG-7-B and TG-37-B, and TT-55/MGC.

TM 11-486-6 Electrical Communications Systems Engineering, Radio.

TM 11-826 Radio Transmitter BC-610-E, -F, -G, -H, and -I, and Transmitter T-213/GRC-26, and Antenna Tuning Unit BC-939-A and -B.

TM 11-854 Radio Receiver R-388/URR.

TM 11-904 Power Units PE-95-A, -B, -C, -F, -G, -H, -I, and -K.

TM 11-957 Rectifier RA-87.

TM 11-957A Rectifier RA-87-A.

TM 11-2201 Reperforator Teletypewriter Sets TC-16 and TC-17 (including Reperforator Transmitters TT-26-A and -B, and Perforator Transmitter TT-56/MGC).

TM 11-2222 Receiving Transmitter Distributors TT-12/FGQ-1, TT-13/FGQ-1, and Transmitter Distributors TT-21/FG, TT-25/FG, TT-26/FG, TT-52/FG.

TM 11-2223 Typing and Nontyping Reperforators, Teletype Model 14.

TM 11-2225 ~~Teletypewriter Sets AN/GGC-3 and AN/GGC-3A, and Teletypewriter Reperforator Transmitters TT-76/GGC, and TT-76A/GGC.~~ *SEE PAGE 1 OF E-6*

TM 11-2234 Teletypewriter Sets AN/PGC-1 and AN/TGC-7A, and Teletypewriters TT-4/TG, TT-4A/TG, and TT-173A/TG.

TM 11-5054 Speech Amplifier BC-614-E, -F, -G, -H, and -I.

TM 11-5062 Frequency Shift Converter CV-182/GRC-26A, CV-182A/GRC-26A, and CV-182B/GRC-26A, and Power Supplies PP-712/GRC-26A, and PP-712A/GRC-26A.

2. (ADDED) *SEE PAGES 1 & 2 OF E-9*

SEE PAGES 2 THRU 9 OF C-4

APPENDIX II

OPERATOR'S REPAIR PARTS AND SPECIAL TOOLS LIST FOR RADIO SETS AN/GRC-26, AN/GRC-26A, -26B, and -26C

Section I. INTRODUCTION

1. Scope

a. General. This appendix lists items supplied for initial operation and for running spares for Radio Sets AN/GRC-26, AN/GRC-26A, -26B, and -26C and for Radio Teletypewriter Control C-808/GRC-26A and Transmitter-Teletypewriter Control C-808A/GRC-26A. The list includes tools, accessories, and similar material issued as *part of* the major end item. The list includes all items authorized for basic operator maintenance of the equipment listed. End items of equipment are issued on the basis of allowances prescribed in equipment authorization tables and other documents which are a basis for requisitioning.

b. Columns.

- (1) *Federal or technical service stock number.* The stock number column lists the 11-digit Federal stock number. In the absence of a Federal stock number, the technical service stock number will be used for requisitioning purposes.
- (2) *Repair parts source, maintenance and recoverability code.* (Not used.)
- (3) *Designation by model.* A subdivision of this column is assigned to each specific model of the equipment or for groups of equipment, as noted. A dagger (†) in one of these columns indicates that the part is used in that model.
- (4) *Designation by model.* Nomenclature or the standard item name and brief identifying data for each item are listed in this column. When requisitioning, enter the nomenclature and description on the requisition.
- (5) *Unit of issue.* The unit of issue is the supply term applied to the smallest quantity by which the individual item

is counted for procurement, storage, requisitioning, allowances, and issue purposes.

- (6) *Expendability.* Expendable items are indicated by the letter X; nonexpendable items are indicated by NX.
- (7) *Quantity authorized.* Under "Items Comprising an Operable Equipment" (pages 1 through 5), the column lists the quantity of items supplied for the initial operation of the equipment. Under Running Spares and Accessory Items (pages 6 through 8), the quantities listed are those issued initially with the equipment as spare parts. The quantities are authorized to be kept on hand by the operator for maintenance of the equipment.
- (8) *Illustration (fig. No.).* (Not used.)
- (9) *Illustration (item No.).* The reference designations in this column are parts identifications that are used on the equipment.

2. Critical Items

A zero slash (Ø) appears in the Description column preceding items that are expected to fail during the first year. The symbol Ø also appears by items that will make the equipment inoperative if they fail.

3. Tube Allowance Factors

The consumption rates given for tubes are conservative, theoretical estimates. They are provided for use only where no better information, such as data based on operating experience, is available. The quantities listed are based on levels and requirements for equipment actually in

use, not on authorizations for equipment or equipment stored in depots.

4. Contents of First Echelon Repair Parts and Special Tools List

The major items of the equipment covered by this list appear in section II in the following sequence:

Radio Sets AN/GRC-26, AN/GRC-26A, B, C.

Radio Teletypewriter Control C-808/GRC-26A Group.

5. References

A Maintenance Allocation Chart showing all repair operations authorized to be performed by the respective echelons of maintenance is contained in TM 11-5820-202-20. Additional instructions concerning maintenance of this equipment are contained in:

TM 11-264, Radio Set AN/GRC-26

TM 11-809-10, Radio Transmitters T-368/URT, T-368A/URT, T-368B/URT, and T-368C/URT and Antenna Tuning Unit BC-939-B, Operator's Manual

TM 11-5820-217-10P, Operator's Maintenance Repair Parts and Special Tools List for Power Supplies PP-712/GRC-26A and PP-712A/GRC-26A

TM 11-5820-251-10P, Operator's Maintenance Repair Parts and Special Tools List for Masts AB-155/U, AB-155A/U, and AB-155B/U

SIG 7 & 8 AN/GGC-3, Teletypewriter Set AN/GGC-3

SIG 7 & 8 AN/GRC-26, Radio Set AN/GRC-26; AN/GRC-26A

SIG 7 & 8 BC-610, Radio Transmitter BC-610-E, F, G, H, I

SIG 7 & 8 BC-614, Speech Amplifier BC-614-E, H, I

SIG 7 & 8 C-292/TRA-7, Control Unit C-292/TRA-7, C-292A, B/TRA-7

SIG 7 & 8 CV-31/TRA-7, Dual Diversity Converter CV-31/TRA-7, CV-31A, B, C, D/TRA-7

SIG 7 & 8 CY-1216/U, Electrical Equipment Cabinet CY-1216/U

SIG 7 & 8 EE-8, Telephone EE-8, EE-8-A, B, C, D, E

SIG 7 & 8 GN-38, Hand Ringing Generator GN-38, GN-38-A, B

SIG 7 & 8 HS-30, Headsets HS-30 A, B, C, D, E, F, G, H, J, K, L, R, U

SIG 7 MC-181, Organizational Spare Parts for Stamp MC-181 and MC-181-A

SIG 8 MC-181, Higher Echelon Spare Parts for Stamp MC-181 and MC-181-A

SIG 7 & 8 MP-47, Mast Base MP-47-A

SIG 7 & 8 MP-65, Mast Base MP-65; MP-65-A, B

SIG 7 & 8 O-39/TRA-7, Frequency Shift Exciter O-39/TRA-7, O-39A, B, C/TRA-7

SIG 7 & 8 O-41/TRA-7, Oscillator O-41/TRA-7, O-41A/TRA-7

SIG 7 & 8 PP-193/TRA-7, Rectifier Power Unit PP-193/TRA-7, PP-193A/TRA-7

SIG 7 & 8 PU-109/GG, Motor Unit PU-109/GG

SIG 7 & 8 R-388/URR, Radio Receiver R-388/URR

SIG 7 & 8 RA-87, Rectifier RA-87, RA-87-A

SIG 7 & 8 S-55/GRC, Shelter S-55/GRC

SIG 7 & 8 S-69/GRC, Shelter S-69/GRC

SIG 7 & 8 SCR-211, Frequency Meter Set SCR-211, A, B, C, D, E, F, J, K, L, M, N, P, Q, T, AA, AF, AG, AJ, AK

SIG 7 & 8 TS-9, Handset TS-9-F

SIG 7 & 8 TT-55/MGC, Teletypewriter TT-55/MGC

SIG 7 & 8 TT-56/MGC, Perforator-Transmitter TT-56/MGC

SIG 7 & 8 TU-47, Transmitter Tuning Unit TU-47

SIG 7 & 8 TU-48, Transmitter Tuning Unit TU-48

SIG 7 & 8 TU-49, Transmitter Tuning Unit TU-49

SIG 7 & 8 TU-50, Transmitter Tuning Unit TU-50

SIG 7 & 8 TU-51, Transmitter Tuning Unit TU-51

SIG 7 & 8 TU-52, Transmitter Tuning Unit TU-52

SIG 7 & 8 TU-53, Transmitter Tuning Unit TU-53

SIG 7 & 8 TU-54, Transmitter Tuning Unit TU-54

Section II. FIRST ECHELON REPAIR PARTS AND SPECIAL TOOLS LIST

(1) FEDERAL OR TECHNICAL SERVICE STOCK NUMBER	(2) REPAIR PARTS SOURCE, MAINTENANCE AND RECOVERABILITY CODE	(3) DESIGNATION BY MODEL	(4) DESCRIPTION	(5) UNIT OF ISSUE	(6) EXPENDABILITY	(7) QUANTITY AUTHORIZED	(8) ILLUSTRATION	
							FIGURE NO.	ITEM NO.
		1 2 3 4 5	RADIO SET AN/GRC-26, AN/GRC-26A, B, C					
5820-186-9250			NOTE: Model Column 1 refers to AN/GRC-26; Column 2 refers to AN/GRC-26 thru serial No. 778 Column 3 refers to AN/GRC-26A ser No. 779 thru No. 839; Column 4 refers to AN/GRC-26B; Column 5 refers to AN/GRC-26C RADIO SET AN/GRC-26, AN/GRC-26 A,B,C: gnd use; 400 w A1, 300 A3, and 400 w F9 emission; 2-18 mc freq range; 120 v ac 50-60 cyc, single ph	ea	NX			
		+	TECHNICAL MANUAL TM-264: Order thru AGC	ea	X	2		
		+	TECHNICAL MANUAL TM-264A: Order thru AGC	ea	X	2		
5820-194-8300		+	AMPLIFIER, AUDIO FREQUENCY: speech amplifier BC-614-H, 1	ea	NX	1		
5985-221-5566		+	BASE, MAST: Mast Base MP-47-A	ea	NX	1		
5820-221-5553		+	BASE, MAST: Mast Base MP-65-A	ea	NX	2		
5820-503-2953		+	BASE, MAST: Mast Base MP-65-B	ea	NX	2		
5820-497-8705		+	BRACKET: Mast Bracket No. MP-50	ea	NX	2		
5820-404-2718		+	BRACKET: Mast Bracket No. MP-50-A	ea	NX	2		
5805-356-3548		+	BRACKET: "T" shape; holds telephone EE-8; Sig dwg No. SC-C-28020	ea	X	1		
5820-497-8596		+	BRACKET MT-657/GRC	ea	X	1		
6145-241-1770		+	BRAID, WIRE: tinned copper; 3/16" id; Alpha Wire No. 1230	ft	X	15		
		+	BRAID, WIRE: tinned copper; 1" x 0.047 thk; Belden Code Facing	ft	X	9		
		+	CABINET, ELECTRICAL EQUIPMENT: CY-826/GRC-26	ea	NX	1		
5820-194-8130		+	CABINET, ELECTRICAL EQUIPMENT: CY-1216/U	ea	NX	1		
5820-503-0804		+	CABLE ASSEMBLY, POWER, ELECTRICAL: Cord CX 962/TRA-7; 4 ft lg; Sig dwg No. SC-C-34601	ea	X	1		W108
3995-164-7902		+	CABLE ASSEMBLY, POWER, ELECTRICAL: Cord CX 763; 13 ft lg	ea	X	1		W1
5995-164-7692		+	CABLE ASSEMBLY, POWER, ELECTRICAL: Cord CX 1165/U; 13 ft lg	ea	X	2		W2
5995-170-7943		+	CABLE ASSEMBLY, POWER, ELECTRICAL: Power Cable Assembly No. CX-1166/U; 50 ft lg	ea	X	2		W3
5995-170-7929		+	CABLE ASSEMBLY, POWER, ELECTRICAL: Special Purpose Cable Assembly No. CX-1200/U; 3 ft 10-1/2 in lg	ea	X	2		
5995-170-8780		+	CABLE ASSEMBLY, POWER, ELECTRICAL: special purpose cable assembly No. CX-1201/U; 3 ft 9 in lg	ea	X	2		
5995-170-8773		+	CABLE ASSEMBLY, RADIO FREQUENCY: Cord No. CG-67/AHQ-2; 5 ft 6 in lg	ea	X	2		W12
5995-160-5954		+	CABLE ASSEMBLY, RADIO FREQUENCY: Cord No. CG-389A/U; 6 ft lg	ea	X	1		
5995-238-3414		+	CABLE ASSEMBLY, RADIO FREQUENCY: Cord No. CG-390/U; 3 ft lg	ea	X	1		
5995-171-2980		+	CABLE ASSEMBLY, RADIO FREQUENCY: Coar No. CG-390/U; 17 ft 11 in lg	ea	X	1		
5995-251-3832		+		ea	X	1		

AN/GRC-26; AN/GRC-26A, B, C

(1) FEDERAL OR TECHNICAL SERVICE STOCK NUMBER	(2) REPAIR PARTS SOURCE, MAINTENANCE AND RECOVERABILITY CODE	(3) DESIGNATION BY MODEL	(4) DESCRIPTION	(5) UNIT OF ISSUE	(6) EXPENDABILITY	(7) QUANTITY AUTHORIZED	(8) ILLUSTRATION		(9)
							FIGURE NO.	ITEM NO.	
5995-272-9111		1 2 3 4 5	AN/GRC-26; AN/GRC-26A, B, C (continued)						
		+	0 CABLE ASSEMBLY, RADIO FREQUENCY: RF Cable Assembly No. CG-557A/U; 75 ft lg Sig dwg No. SC-D-22840;	ea	X	1			
5995-272-9144		+	0 CABLE ASSEMBLY, RADIO FREQUENCY: RF Cable Assembly No. CG-557A/U; 500 ft lg; Sig dwg No. SC-D-22840;	ea	X	2			
5995-636-0186		+	0 CABLE ASSEMBLY, RADIO FREQUENCY: RF Cable Assembly #CG-558A/U; 30-3/4 in lg; Sig dwg No. SC-D-22837;	ea	X	1			W17
5995-284-6679		+	0 CABLE ASSEMBLY, RADIO FREQUENCY: RF Cable Assembly No. CG-562A/U; 6 ft lg	ea	X	2			
5995-162-7141		+	0 CABLE ASSEMBLY, SPECIAL PURPOSE, ELECTRICAL: Cord No. CD-267; 46 in lg Sig dwg No. SC-D-5386;	ea	X	2			
6623-170-9608		+	CABLE ASSEMBLY, SPECIAL PURPOSE, ELECTRICAL: Cord No. CD-605; 10 ft lg	ea	X	1			
5995-164-6494		+	0 CABLE ASSEMBLY, SPECIAL PURPOSE, ELECTRICAL: Cord No. CD-764; 14 ft 5 in lg; Sig dwg No. SC-D-27457;	ea	X	1			W7
5995-161-1670		+	0 CABLE ASSEMBLY, SPECIAL PURPOSE, ELECTRICAL: Cord No. CX-955/TRA-7; 7 ft 4 in lg	ea	X	2			
5995-164-6598		+	0 CABLE ASSEMBLY, SPECIAL PURPOSE, ELECTRICAL: Cord No. CX-956/TRA-7; 6 ft 4 in lg	ea	X	1			
5995-161-4673		+	0 CABLE ASSEMBLY, SPECIAL PURPOSE, ELECTRICAL: Cord No. CX-957/TRA-7; 6 ft lg	ea	X	1			
5995-163-1740		+	CABLE ASSEMBLY, SPECIAL PURPOSE, ELECTRICAL: Cord No. CX-958/TRA-7; 6 ft 4 in lg	ea	X	1			
5995-163-0035		+	0 CABLE ASSEMBLY, SPECIAL PURPOSE, ELECTRICAL: Cord No. CX959/TRA-7; 6 ft 4 in lg	ea	X	1			
5995-163-1742		+	0 CABLE ASSEMBLY, SPECIAL PURPOSE, ELECTRICAL: Cord No. CX-961/TRA-7; 4 ft lg Sig dwg No. SC-C-34600; w/red band;	ea	X	1			W106
5995-163-1741		+	0 CABLE ASSEMBLY, SPECIAL PURPOSE, ELECTRICAL: Cord No. CX-961/TRA-7; 4 ft lg w/blue band; Sig dwg No. SC-C-34600;	ea	X	1			
5995-240-0876		+	0 CABLE ASSEMBLY, SPECIAL PURPOSE, ELECTRICAL: Special Purpose Core Assembly No. SC-D-22489	ea	X	1			W8
5995-237-8038		+	0 CABLE ASSEMBLY, SPECIAL PURPOSE, ELECTRICAL: Special Purpose Cable Assembly No. CX-1150/U; 15 ft lg Sig dwg No. SC-DL-22674	ea	X	1			W9
5995-237-8037		+	0 CABLE ASSEMBLY, SPECIAL PURPOSE, ELECTRICAL: Special Purpose, Cable Assembly No. CX-1151/U; 15 ft lg Sig dwg No. SC-D-22634-A	ea	X	2			
5995-170-7919		+	0 CABLE ASSEMBLY, SPECIAL PURPOSE, ELECTRICAL: Special Purpose Cable Assembly No. CX-1152/U; 4 ft lg Sig dwg No. SC-D-22630	ea	X	1			W11
5995-228-4334		+	0 CABLE ASSEMBLY, SPECIAL PURPOSE, ELECTRICAL: Electrical Special Purpose Cable Assembly No. CX-1850/U 3 ft lg Sig dwg No. SC-DL-85089	ea	X	1			
5995-232-3026		+	0 CABLE ASSEMBLY, SPECIAL PURPOSE, ELECTRICAL: Special Cable Assembly No. CX1851/U; 4 ft lg	ea	X	2			
5995-256-9968		+	0 CABLE ASSEMBLY, POWER, ELECTRICAL: Cable Assembly Special Purpose Electrical No. CX-1939/U; 5 ft 3-7/8 in lg Sig dwg No. SC-C-68578	ea	X	2			W5
5820-537-7884		+	CASE CY-689/GRC-26; Sig dwg No. SC-D-28022	ea	X	1			
		+	CHAIR: w/o arms: Westmoreland Metal Mfg Co type No. 1052CB; (26-C-2330 Qm Stk No.)	ea	NX	2			

AN/GRC-26; AN/GRC-26A, B, C

(1) FEDERAL OR TECHNICAL SERVICE STOCK NUMBER	(2) REPAIR PARTS SOURCE, MAINTENANCE AND RECOVERABILITY CODE	(3) DESIGNATION BY MODEL	(4) DESCRIPTION	(5) UNIT OF ISSUE	(6) EXPENDITURE	(7) QUANTITY AUTHORIZED	(8) ILLUSTRATION		(9)
							FIGURE NO.	ITEM NO.	
5925-498-4084		1 2 3 4 5	AN/GRC-26; AN/GRC-26A, B, C (continued)	ea	NX	1			
5935-196-4689		+	CHAIR: w/o arms; American Seating Co type No. 674 (26-C-7920 Qm Stk No.)	ea	X	1			
5935-237-7351		+	CIRCUIT BREAKER: air, dpst; 20 amp 120/240 v ac 60 cyc; square D No. M92-1617225	ea	NX	1			
5820-162-6330		+	CLOCK: Mechanical 8 day; Longines-Wittnauer type No. 11 (18-C-1155-400 Qm Stk No.)	ea	X	5			
5935-196-4689		+	() CONNECTOR, ADAPTER: sigC Adapter No. M-359	ea	X	1			
5935-237-7351		+	G CONNECTOR, ADAPTER: sigC Adapter No. M-359	ea	X	1			
5820-162-6330		+	CONNECTOR, ADAPTER: sig plug No. PL-258	ea	X	2			
5820-243-0818		+	CONTROL, RADIO SET: JENS Teletypewriter Control No. C-345/MRC-2, C-345A/MRC-2	ea	NX	1			
5805-162-6302		+	CONTROL, RADIO SET: JENS Teletypewriter Control No. C-808/GRC-26A sig dwg No. SC-D-7886	ea	X	1			
5815-162-8257		+	CONTROL, TELEGRAPH: Line unit No. BE-77-A	ea	NX	1			
			OR						
5815-162-1301		+	CONTROL, TRANSMITTER-TELETYPEWRITER: Control Unit No. C-292B/TRA-7	ea	NX	1			
5820-240-3295		+	CONVERTER, FREQUENCY SHIFT CONVERTER: No. CV-182/GRC-26A and No. CV-182A/GRC-26A	ea	NX	1			
5995-164-6648		+	CORD, HEADSET: Cord No. CD-201A 5 ft 3 in lg Sig dwg No. SC-D-6609	ea	X	1			
6625-170-9608		+	CORD ASSEMBLY, ELECTRICAL: Sig Cord No. CD-605; 6 ft 10 in lg; Sig dwg No. SC-A-7999	ea	X	1			W6
5815-404-8438		+	COVER: BG-198;	ea	X	2			
5815-498-7933		+	COVER: Cover No. BG-199	ea	X	1			
5815-498-7958		+	COVER, TELETYPEWRITER REPERFORATOR TRANSMITTER: Cover No. BG-200	ea	X	1			
5815-194-9388		+	DIAL DIVERSITY CONVERTER CV-31/TRA-7, CV-31, A, B, C/TRA-7	ea	NX	1			
6625-404-3732		+	FREQUENCY METER BC-221-AA, AB, AC, AE, AF, AG, AH, AJ, AK, AL and AN	ea	NX	1			
6115-635-5614		+	GENERATOR SET, GASOLINE, TRAILER MOUNTED: PU-294/G	ea	NX	1			
5975-164-7259		+	HEADSET HS-30; HS-30-A, B, C, D, E, F, G, H, J, K, L, M, R, V; 250 ohm imp	ea	NX	1			
5970-285-0123		+	INSULATOR, BOWL: Steatite, 2-23/32 in lg x 5-1/4 in dia; Alisigma type No. A-9232	ea	X	1			
5970-405-9871		+	INSULATOR, SPREADER: Steatite grade L-4, brown glazed; 4 in lg x 3/4 in dia	ea	X	6			
5805-171-3370		+	KEY, TELEGRAPH: Key J-45	ea	NX	1			
6240-267-2860		+	LAMP, INCANDESCENT: Lamp, 125 v 15 w; intermediate screw base GE part No. 1577N (125)	ea	X	1			
		+	LAMP, INCANDESCENT: Lamp, 120 v, 50 w; med screw base; Masda No. 50A/RS (17-6767, 100-050 Engr Stk No.)	ea	X	1			
5995-279-2576		+	LEAD, ELECTRICAL: 1 cond No. 7AWG; 10 ft lg; U S Army Spec No. 71-1683	ea	X	1			
5995-252-3958		+	LEAD, ELECTRICAL: wire braid; No. 7AWG; 5 ft lg; B/W part/dwg No. 26-567B	ea	X	1			
		+	LIGHT EXTENSION: trouble light; 25 ft lg (17-7047, 075, 250 Eng Stk No.)	ea	X	1			
5965-163-1791		+	LOUDSPEAKER LS-3; dynamic; 6 in cone; PM type	ea	NX	2			
5820-251-2366		+	MAST AB-155/U, AB-155A/U	ea	NX	6			
5820-199-8842		+	0 MAST SECTION: MS-49	ea	NX	1			
5820-155-8131		+	0 MAST SECTION: MS-50	ea	NX	1			

(1) FEDERAL OR TECHNICAL SERVICE STOCK NUMBER	(2) REPAIR PARTS SOURCE, MAINTENANCE AND RECOVERABILITY CODE	(3) DESIGNATION BY MODEL	(4) DESCRIPTION	(5) UNIT OF ISSUE	(6) EXPENDABILITY	(7) QUANTITY AUTHORIZED	(8) ILLUSTRATION		(9)
							FIGURE NO.	ITEM NO.	
			AN/GRC-26; AN/GRC-26A, B, C (continued)						
5820-155-8130		1	0 MAST SECTION: MS-51	ea	NX	1			
5820-155-8129		2	0 MAST SECTION: MS-52	ea	NX	1			
5820-156-1055		3	0 MAST SECTION: MS-53	ea	NX	1			
5820-199-8831		4	0 MAST SECTION: MS-116	ea	X	4			
5820-199-8843		5	0 MAST SECTION MS 117	ea	X	2			
5820-199-8841			0 MAST SECTION: MS-118	ea	X	2			
5965-128-2512			MICROPHONE: microphone T-17, T-17B,D; Carbon; low imp 30 to 90 ohm ekt	ea	NX	1			
5965-170-5232			MICROPHONE: Microphone T-50, 20,000 ohm imp	ea	NX	1			
5820-128-1484			MOUNTING, RADIO RECEIVER: mounting MT-563/MRC	ea	NX	1			
5820-186-9471			MOUNTING: Mounting FT-178	ea	X	2			
5820-355-9212			MOUNTING: Shock mtg base for radio xmtr; Vibelimator partNo. BW-25336	ea	NX	1			
5815-224-5287			OSCILLATOR, RADIO FREQUENCY: Frequency shift exciter No. O-398/TRA-7, O-39C/TRA-7	ea	NX	1			
5815-198-9033			PERFORATOR-TRANSMITTER: Reperforator-Transmitter TT-56/MGC	ea	NX	1			
5975-407-6373			PLIERS TL-103; diagonal cutting w./cutters (5110-00-17075 Ord Stk No.)	ea	X				
6625-245-9673			POLE LANCE: wood, pole 11 ft 5 in lg; sig dwg No. SC-C-27971	ea	NX	4			
5820-548-1682			POWER SUPPLY: rectifier power unit No. RA-139, RA-133A, B	ea	NX	1			
6130-230-7257			POWER SUPPLY: electronic power supply No. PP-712/GRC-26A, PP-712A/GRC-26A	ea	NX	1			
5820-221-2427			POWER SUPPLY: rectifier RA-87, RA87A	ea	NX	1			
3895-237-8438			RACK: cabinet Electrical Equipment, No. CY-1050/GRC-26A	ea	NX	1			
5820-503-1090			RACK: rack No. MT-655/GRC; sig dwg SC-C-27979	ea	X	2			
5820-194-2992			RADIO SET CONTROL GROUP: AN/GRA-14	ea	NX	1			
5820-537-3895			RECEIVER, RADIO: Radio Receiver No. R-336/GRC-26	ea	NX	2			
5820-030-2969			RECEIVER, RADIO: Radio Receiver No. R-388/URR	ea	NX	2			
4020-408-4219			REEL: wire reel No. RL-29	ea	NX	1			
5410-498-7314			REPERFORATOR-TRANSMITTER, Teletypewriter No. TT-76/GGC (4TTT-76/MGC sig Stk No.)	ea	NX	1			
5410-356-2486			ROPE: rope cotton braid No. RP-5	ft	X	50			
5975-266-2034			SHELETER: shelter No. S-55/GRC	ea	NX	1			
			SHELETER: shelter No. S-69/GRC	ea	NX	1			
			SPLICE, CONDUCTOR: compression; accom 1 continuous and 1 branch max No. 10AWG; Burivdy	ea	X	6			
			No. KS-90						
			STAMP: time clock stamp No. MC-181-A (51-S-16022-45 Om Stk No.)	ea	NX	1			
8465-408-4347			STRAP, RETAINING: broom and hammer retaining strap; sig dwg No. SC-B-27964	ea	X	2			
5410-219-6401			STRAP, RETAINING: holds folding chair sig dwg No. SC-C 19825-GR-1	ea	X	2			
5410-498-9541			STRAP, RETAINING: hold gnd rod in storage position B and w part/dwg No. 26-512	ea	X	1			
5820-497-8791			STRAP, RETAINING: hold lance poles; sig dwg No. SC-C-27982 GrII	ea	X	4			
			STRAP, RETAINING: Mast retaining strap B and w part No. 25-1	ea	X	3			

AN/GRC-26; AN/GRC-26A, B, C

(1) FEDERAL OR TECHNICAL SERVICE STOCK NUMBER	(2) REPAIR PARTS SOURCE, MAINTENANCE AND RECOVERABILITY CODE	(3) DESIGNATION BY MODEL	(4) DESCRIPTION	(5) UNIT OR ISSUE	(6) EXPENDABILITY	(7) QUANTITY AUTHORIZED	(8) ILLUSTRATION FIGURE NO.	(9) ITEM NO.
5820-221-0188		1 2 3 4 5	AN/GRC-26; AN/GRC-26A, B, C (continued)					
		+	SWITCHING UNIT: Radio Teletypewriter Control No. C-535/GRC-26	ea	NX	1		
		+	TAPE: measuring; 100 ft lg (41-8496, 100, 500 Eng Stk No.)	ea	NX	1		
5805-162-6251		+	TELEPHONE EE-8: field; self contained	ea	NX	2		
5815-198-4438		+	TELETYPEWRITER TT-4/TC, TT-4A/TC: std com keyboard; English characters; sending and receiving	ea	NX	2		
5815-198-4442		+	TELETYPEWRITER TT-55/ALGC: portable std commercial w/po; English characters 72 perline	ea	NX	2		
5820-194-0965		+	TRANSMITTER, RADIO: radio transmitter No. T-213/GRC-26	ea	NX	1		
5820-189-7042		+	TRANSMITTER, RADIO: radio transmitter, BC-610-H, I (Note: Issue Model Hor I only)	ea	NX	1		
5820-223-4641		+	TUNER, RADIO FREQUENCY: Antenna Tuning Unit No. BC-939-A, B	ea	NX	1		
6145-128-8695		+	WIRE: bare wire No. 14AWG W-1	ft	X	1000		
6145-160-5114		+	WIRE: 1 cond No. 14AWG W-128	ft	X	2		
6145-226-8812		+	WIRE: wire, electrical WD-1/TT on 1/2 mile reel	ea	X	2		
			RADIO TELETYPEWRITER CONTROL C-808/GRC-26A Group					
			NOTE: Model Column 1 refers to Barker and Williamson orders; Column 2 refers to Hallcrafters Orders 1908-Ph-51, 3131-Ph-51, and 3357-Ph-52; column 3 refers to C-808A/GRC-26A					
5815-356-3903		+	CASE, RADIO TELETYPEWRITER CONTROL: CY901/GRC-264			1		
5995-164-7717		+	CORD CD-307: uses cordage Co-119A; 4 ft lg; sig dwg No. SC-D-2019; NOTE: To be requested in min quantity of 7 ft or multiple thereof.	ea	X	7		
5960-193-5113		+	0 ELECTRON TUBE: JAN 5Y3WGT	ea	X	2		
5920-057-2952		+	0 FUSE, CARTRIDGE: 1 amp Littlefuse No. 413001	ea	X	1		F1
6240-155-8706		+	LAMP: LM-52; GE type No. 17	ea	X	2		E5
6210-213-0073		+	LENS, INDICATOR LIGHT: green; Dialco part No. 93246-112;	ea	X	1		
6210-299-3870		+	LENS, INDICATOR LIGHT: amber, Dialco NO. DP-H	ea	X	1		
6210-404-9871		+	LENS, INDICATOR LIGHT: red; Dialco No. 93-111	ea	X	1		
5945-188-5691		+	0 RELAY, ARMATURE: spst; Sigma Instruments Inc No. 7J02-160T Model D	ea	X	1		01
5945-258-4060		+	RELAY ARMATURE: spst; Sigma Instrs; part No. 7J02-150T	ea	X	1		01
5960-273-2460		+	RETAINER, ELECTRON TUBE: times fax No. 2THat	ea	X	2		
5120-224-2504		+	WRENCH: Allen type for No. 8 Allen Set Screw	ea	X			

AN/GRC-26; AN/GRC-26A, B, C

(1)	(2)	(3)	(4)	(5)	(6)	(7)	(8)	(9)
FEDERAL OR TECHNICAL SERVICE STOCK NUMBER	REPAIR PARTS SOURCE, MAINTENANCE AND RECOVERABILITY CODE	DESIGNATION BY MODEL	DESCRIPTION	UNIT OF ISSUE	EXPENDABILITY	QUANTITY	ILLUSTRATION	ITEM NO.
							FIGURE NO.	
		1 2 3 4 5	AN/GRC-26; AN/GRC-26A, B, C (continued)					
			RUNNING SPARES AND ACCESSORY ITEMS					
			RADIO SET AN/GRC-26; AN/GRC-26A, B, C					
			NOTE: Model Column 1 refers to AN/GRC26; Column 2 refers to AN/GRC-26A thru serial No. 778; Column 3 refers to AN/GRC-26A ser No. 779 thru No. 839; Column 4 refers to AN/GRC-26B; Column 5 refers to AN/GRC-26C					
5820-186-9250			RADIO SET AN/GRC-26; AN/GRC-26A, B, C; 3rd use; 400 w Al, 300 A3, and 400 w F9 emission; 2-18 mc freq range; 120 v ac 50-60 cyc, single ph	ea	NX			
5985-221-5566		+	BASE, MAST: Mast base No. MP-47-A	ea	NX	1		
5820-221-5553		+	BASE, MAST: Mast base No. MP-65-A	ea	NX	1		
5820-503-2953		+	BASE, MAST: Mast base No. MP-65-B	ea	NX	1		
5820-497-9664		+	BOX: BX-19, BX-19A	ea	X	2		
5820-497-8705		+	BRACKET: Mast bracket No. MP-50	ea	NX	1		
5820-404-2718		+	BRACKET: Mast bracket No. MP-50-A	ea	NX	1		
7920-285-9816		+	BROOM, FLOOR: Flat, 55 in lg x 10 in w x 2-1/2 in thk; (38-B-105 QM Stk No.)	ea	X	1		
5995-636-0186		+	BRUSH, CLEANING: 8 in lg; Dietzgen No. 4211A	ea	X	1		
5995-163-1742		+	0 CABLE ASSEMBLY, RADIO FREQUENCY; RF Cable Assembly No. CG-558A/U; 30-3/4 in lg; Sig dwg No. SC-D-22837	ea	X	1		W17
5995-163-1741		+	0 CABLE ASSEMBLY, SPECIAL PURPOSE, ELECTRICAL; Cord No. CX-971/TRA-7; 4 ft lg Sig dwg No. SC-C-34600; w/red band;	ea	X	1		W106
5995-256-9968		+	0 CABLE ASSEMBLY, SPECIAL PURPOSE, ELECTRICAL; Cord No. CX-961/TRA-7; 4 ft lg w/blue band; sig dwg No. SC-C-34600;	ea	X	1		W5
6605-222-1756		+	0 CABLE ASSEMBLY, POWER, ELECTRICAL; Cable Assembly Special Purpose Electrical No. CX-1939/U; 5 ft 3-7/8 in lg Sig dwg No. SC-C-68578	ea	X	1		
5935-196-4689		+	CLIPBOARD: 12-1/2 in lg x 9 in w; Julius Bandes and Co. No. CT-112 (53-F-2296 QM Stk No.)	ea	X	1		
5935-196-4689		+	COMPASS, MAGNETIC, HAND HELD; K and E type No. 5600-1/2	ea	NX	1		
5935-196-4689		+	0 CONNECTOR, ADAPTER: Sig Adapter No. M-359	ea	X	1		
5935-237-7351		+	0 CONNECTOR, ADAPTER: Sig Adapter No. M-359	ea	X	1		
5975-193-6771		+	CONNECTOR, ADAPTER: Sig Plug No. PL-258	ea	X	2		
5975-193-6774		+	GUY: Hold down for whip ant; 11 ft 3 in; Sig dwg No. SC-B-28061	ea	X	2		
5120-230-7857		+	GUY: Hold down for whip ant; 11 ft 5 in lg; Sig dwg No. SC-B-28062	ea	X	1		
		+	HAMMER, HAND: 6 lb sledge	ea	X	1		
		+	HEATER, AIR: Coates Elec mfg Model No. AAAT-13; (17-5741, 075, 115 Engr Stk No.)	ea	NX	1		

AN/GRC-26; AN/GRC-26A, B, C

(1) FEDERAL OR TECHNICAL SERVICE STOCK NUMBER	(2) REPAIR PARTS SOURCE, MAINTENANCE AND RECOVERABILITY CODE	(3) DESIGNATION BY MODEL	(4) DESCRIPTION	(5) UNIT OR ISSUE	(6) EXPENDABILITY	(7) QUANTITY AUTHORIZED	(8) ILLUSTRATION		(9)
							FIGURE NO.	ITEM NO.	
		1 2 3 4 5							
5820-356-1159		+	AN/GRC 26; AN/GRC-26A, B, C (continued)						
5975-164-7259		+	HARDWARE KIT: for mtgs and maint:	ea	X	1			
5970-283-0123		+	HEADSET HA-30, IIS-30 A, B, C, D, E, F, G, J, K, L, M, R, V; 250 ohm imp	ea	XX	1			
5970-405-8971		+	INSULATOR, BOWL: Steatite, 2-23/32 in lg x .514 in dia; Alsigma Type No. A 9232	ea	X	1			
		+	INSULATOR, SPREADER: Steatite grade L-1, brown glazed; 4 in lg x 3/4 in dia	ea	X	18			
6240-267-2860		+	KNIFE: TL 29 (Engr Stk No. 11-5153-303,060)			1			
		+	LAMP, INCANDESCENT: Lamp, 125 v 15 w; intermediate screw base GE part No. 157TY(125)	ea	X	1			
		+	LAMP, INCANDESCENT: Lamp, 120 v, 50 w; Med screw base; Mazda No. 50A/RS (17-6767, 100-050)	ea	X	1			
			Engr Stk No.)						
5995-279-2576		+	LEAD, ELECTRICAL: 1 cond No. 7AWG; 10 ft. lg; U S Army Spec No. 71 1683	ea	X	1			
5995-252-3958		+	LEAD, ELECTRICAL: wire braid; No. 7AWG; 5 ft. lg; B/W part/dwg No. 26-567B	ea	X	1			
5820-199-8842		+	0 MAST SECTION: MS 49	ea	XX	2			
5820-155-8131		+	0 MAST SECTION: MS 50	ea	XX	2			
5820-155-8130		+	0 MAST SECTION: MS 51	ea	XX	2			
5820-155-8129		+	0 MAST SECTION: MS 52	ea	XX	2			
5820-156-1055		+	0 MAST SECTION: MS-53	ea	XX	2			
5820-199-8831		+	0 MAST SECTION: MS-116	ea	X	4			
5820-199-8843		+	0 MAST SECTION MS-117	ea	X	2			
5820-199-8841		+	0 MAST SECTION: MS-118	ea	X	2			
		+	PLIERS TL-103; diagonal cutting w/cutters (5110 00-17075 Ord Stk No.)	ea	X	1			

(1) FEDERAL OR TECHNICAL SERVICE STOCK NUMBER	(2) REPAIR PARTS SOURCE, MAINTENANCE AND RECOVERABILITY CODE	(3) DESIGNATION BY MODEL	(4) DESCRIPTION	(5) UNIT OF ISSUE	(6) EXPENDABILITY	(7) QUANTITY AUTHORIZED	(8) ILLUSTRATION	
							FIGURE NO.	ITEM NO.
5975-187-5295		1 2 3 4 5 + + + + +	AV/GRC-26; AN/GRC-26A, B, C. (Continued) ROD, GROUND: GP-26					
		+ + + + +	SCREWDRIVER, COMMON: 5/16 in w tip, 6 in lg; (11-S 1104 Ord Stk No.)	ea	X	1		
		+ + + + +	SCREWDRIVER: TL-21 (11-S 1225 Ord Stk No.)	ea	X	1		
		+ + + + +	SOLDERING IRON: TL-120 (11-1-688 Ord. Stk. No.)	ea	X	1		
5975-266-2034		+ + + + +	SPLICE, CONDUCTOR: compression; accom l continuous and l branch max No. 10AWG; Buridy No. KS-90	ea	X	24		
5120-240-5328		+ + + + +	WRENCH: Open end TL-475/U	ea	X	1		
5120-220-7010		+ + + + +	WRENCH: Special, "T" shape; Sig dng No. SC-C-28016	ea	NX	1		
			RADIO TELETYPEWRITER CONTROL C-808/GRC-26A GROUP					
			NOTE: Model Column 1 refers to Barker and Williamson orders; Column 2 refers to Hallcrafters Orders 1908-Ph-51, 3131-Ph-51 and 3357-Ph-52; Column 3 refers to C-808A/GRC-26A; O ELECTRON TUBE: JAN 5Y3WCT O FUSE, CARTRIDGE: Lamp Littlefuse No. 113001 LAMP: LU-52; GE type No. 47 O RELAY, ARMATURE: spst; Sigma Instruments Inc No. 7J02-160T Model D O RELAY ARMATURE: spst; Sigma Instrs; part No. 7J02-150T WRENCH: Allen type for No. 8 Allen Setscrew					
5960-193-5113		+ + + + +		ea	X	1		
5920-057-2952		+ + + + +		ea	X	5		
6240-155-8706		+ + + + +		ea	X	1		ES
5945-188-5631		+ + + + +		ea	X	1		01
5945-258-4060		+ + + + +		ea	X	1		
5120-224-2504		+ + + + +		ea	X	1		

AV/GRC-26; AN/GRC-26A, B, C

INDEX

	Paragraph	Page
Adapter Kit M-459:		
Description.....	13f	15
Use.....	22a(4)	22
Additional equipment required.....	14	16
Adjustment of mark-hold circuit.....	38	56
Antennas:		
Description.....	9	9
Doublet:		
Connections.....	26b	34
Description.....	8b	8
Installation.....	24	25
Length.....	24b	26
Location.....	23	24
Siting.....	19b	19
Whip:		
Connections.....	26b	34
Description.....	8a	7
Installation.....	23	24
Antijamming procedures.....	42	60
Application, system.....	16	17
Arctic climate, operation.....	45	62
Authority for demolition.....	55	73
Blower assembly, description.....	10b	11
Bracket MT-657/GRC, installation.....	22b	22
Cabinets, description:		
Electrical Equipment Cabinet CY-1216/U.....	12b	12
Rack CY-1050/GRC-26A.....	12a	12
Checking unpacked equipment.....	18	19
Common names.....	6	5
Compass:		
Description.....	13j	16
Use.....	24d	29
Components:		
Interconnections.....	26b	34
Radio Set AN/GRC-26-(*).	5	5
Connections:		
Equipment cording.....	26b	34
Grounding.....	26c	36
Power.....	26a	33
Remote control operation.....	26d	36
Test prod.....	26f	36
Control group:		
Connections.....	26d	36
Controls.....	29	42
Description.....	11	11
Installation.....	27e	39
Purpose.....	3	4
Remote operation.....	40	58
Technical characteristics.....	4b	5

	Paragraph	Page
Controls, indicators, instruments, and jacks:		
Radio Set Control C-1306/GRA-14	29a	42
Radio Set Control Group AN/GRA-14	29	42
Radio Teletypewriter Control C-808/GRC-26A	28	40
Remote Switching Control C-1307/GRA-14	29b	42
Transmitter-Teletypewriter Control C-808A/GRC-26A	28	40
Cording and connections	26b	34
CW operation	41a	59
Demolition, authority	55	73
Description:		
Adapter Kit M-459	13f	15
Antenna equipment	9	9
Cabinets	12	12
Compass	13j	16
Doublet antenna	8b	8
Electrical Equipment Cabinet CY-1216/U	12b	12
Headset HS-30-(*)	13a	15
Key J-45	13c	15
Loudspeaker LS-3	13d	15
Microphone T-17-(*)	13e	15
Microphone T-30	13e	15
Minor components	13	15
Rack CY-1050/GRC-26A	12a	12
Radio Set AN/GRC-26-(*)	7	5
Ratio Set Control Group AN/GRA-14	11	11
Ratio Teletypewriter Control C-808/GRC-26A	10	11
Shelter S-69/GRC	8	7
Telephone EE-8-(*)	13b	15
Transmitter-Teletypewriter Control C-808A/GRC-26A	10	11
Whip antenna	8a	7
Desert climates, operation	47	62
Destruction, methods	56	73
Differences in models	15	16
Disassembly of equipment	53	73
Doublet antenna:		
Construction	24e	32
Description	8b	8
Installation	24	25
Length	24b	26
Location	23	24
Drift compensator adjustments	34c	50
Electrical Equipment Cabinet CY-1216/U	12b	12
Equipment required, additional	14	16
Forms and records	2	4
Formulas for antenna length	24b	26
Frequency Shift Converter CV-182(*)/GRC-26A:		
Mark-hold circuit adjustment	38	56
Tuning for full-duplex operation	35a	51
Tuning for one-way reversible operation	36c	54
Frequency Shift Exciter O-39-*/TRA-7:		
Tuning for full-duplex operation	34b	49
Tuning for one-way reversible operation	36b	53
Frequency standard, tuning receiver as	34a(5)	49
Full-duplex operation, general	33	48
Fuses, location	27a(3)	38
Grounding, connections	26c	36
Headset HS-30-(*):		
Description	13a	15
Use	34b	49

	Paragraph	Page
Inspection, visual	50	64
Installation:		
Doublet antenna	24	25
Other antennas	25	32
Shelter	21	22
Tools required	20	19
Whip antenna	20	19
Interconnections:		
Installation	26 <i>b</i>	34
Key J-45:		
Description	13 <i>c</i>	15
Use	41	59
Lance poles	25	32
Limited storage	54	73
Long wire antenna	25	32
Loudspeaker LS-3, description	13 <i>d</i>	15
Maintenance:		
Forms	49 <i>a</i>	64
Preventive	50	64
Mast AB-155A/U, installation	24 <i>d</i>	29
Mast Base MP-47-A:		
Installation	22 <i>b</i>	22
Replacement	52 <i>c</i>	71
Mast Base MP-65-(*):		
Installation	22 <i>a</i>	22
Replacement	52 <i>b</i>	71
Mast Bracket MP-50-A, installation	22 <i>a</i>	22
Methods of destruction	56	73
Microphone T-17-(*):		
Description	13 <i>e</i> (1)	15
Use	34 <i>d</i>	50
Microphone T-50:		
Description	13 <i>e</i> (2)	15
Use	34 <i>d</i>	50
Mobile operation	30 <i>a</i>	44
Models, differences	15	16
Names, common	6	5
Net operation, one-way reversible	37	55
One-way reversible net operation	37	55
One-way reversible operation	36	53
Operations:		
Antijamming	42	60
Arctic climate	45	62
Conditions	30	44
Cw with Key J-45	41	59
Desert climate	47	62
Frequency shift with Key J-45	41	59
Full duplex:		
Receiving	35	51
Transmitting	34	48
Miscellaneous	41	59
One-way reversible	36	53
One-way reversible net	37	55
Preliminary starting	31	45
Remote	40	58
Starting	32	46
Stopping	43	61
Tropical	46	62

	Paragraph	Page
Operator's maintenance:		
Forms	49	64
Scope	48	64
Parts, replacement	52	71
Perforator-Transmitter TT-56/MGC. (See Reperforator.)		
Power connections	26a	33
Preliminary starting procedure	31	45
Preventive maintenance:		
Form	49	64
Scope	48	64
Purpose and use:		
Radio Set AN/GRC-26-(*).	3	4
Radio Set Control Group AN/GRA-14	3a	4
Radio Teletypewriter Control C-808/GRC-26A	3b	4
Transmitter-Teletypewriter Control C-808A/GRC-26A	3b	4
Rack CY-1050/GRC-26A, description	12a	12
Radio Receiver R-388/URR. (See Receiver.)		
Radio Set AN/GRC-26-(*):		
Antijamming procedures	42	60
Components	5	5
Description	7	5
Disassembly	53	73
Installation	27	38
Miscellaneous operations	41	59
Operating conditions	30	44
Operator's maintenance	49	64
Remote operation	40	58
Siting	19	19
System application	16	17
System troubleshooting chart	51	64
Unpacking	17	18
Radio set control:		
Connections	26d	36
Controls and indicators	29a	42
Description	11a	11
Operation	40	58
Technical characteristics	4b(1)	5
Radio Set Control C-1306/GRA-14. (See Radio switching control.)		
Radio Set Control Group AN/GRA-14. (See Control group.)		
Radiotelephone	40	58
Radio Teletypewriter Control C-808/GRC-26A. (See Teletypewriter control unit.)		
Radio Transmitter BC-610-(*). (See Transmitter.)		
Receiver:		
Frequency standard, use as	34a(5)	49
Full-duplex operation	35	51
One-way reversible net operation	37	55
One-way reversible operation	36	53
Records and forms	2	4
Reel RL-29, description	13i	16
Remote operation	40	58
Remote switching control:		
Connections	26d	36
Controls and indicators	29b	42
Description	11b	11
Equipment required	14c	16
Operation	40	58
Technical characteristics	4b(2)	5
Remote Switching Control C-1307/GRA-14. (See Remote switching control.)		
Repackaging	54	73
Reperforator, operation	39d, e	57

	Paragraph	Page
Replacement of parts:		
Fuses.....	52a	71
Mast Base MP-47-A.....	52c	71
Mast Base MP-65-(*).....	52b	71
Scope:		
Operator's maintenance.....	48	64
Technical manual.....	1	3
Shelter S-69/GRC:		
Description.....	8	7
Installation.....	21	22
Siting:		
Antennas.....	19b	32
Radio set.....	19	32
Speech Amplifier BC-614-(*), operation.....	34d	50
Starting:		
Preliminary.....	31	45
Procedures.....	32	46
Stopping procedures.....	43	61
System:		
Application.....	16	17
Troubleshooting chart.....	51	64
Technical characteristics:		
Radio Set AN/GRC-26-(*).....	4	4
Radio Set Control C-1306/GRA-14.....	4b(2)	5
Radio Set Control Group AN/GRA-14.....	4b(1)	5
Radio Teletypewriter Control C-808/GRC-26A.....	4a	5
Remote Switching Control C-1307/GRA-14.....	4b(3)	5
Transmitter-Teletypewriter Control C-808A/GRC-26A.....	4a	5
Telephone EE-8-(*):		
Description.....	13b	15
Remote use.....	40b	58
Truck use.....	26f	36
Teletypewriter:		
Operating procedures.....	39	56
Troubleshooting.....	51	64
Teletypewriter control unit:		
Controls and indicators.....	28	40
Description.....	10	11
Operation:		
Full duplex.....	34	48
One-way reversible.....	36	53
One-way reversible net.....	37	55
Remote.....	40	58
Teletypewriter Reperforator-Transmitter TT-76/GGC. (See Reperforator.)		
Teletypewriter TT-55/MGC. (See Teletypewriter.)		
Teletypewriter TT-4A/TG. (See Teletypewriter.)		
Test Prod installation.....	26e	36
Tools for installation.....	20	19
Transmitter:		
Antennas:		
Installation.....	22	22
Length.....	24b	26
Operation:		
Full-duplex.....	34	48
One-way reversible.....	36	53
One-way reversible net.....	37	55
Transmitter distributor (p/o TT-56/MGC or TT-76/GGC), operation.....	39f	57
Transmitter-Teletypewriter Control C-808A/GRC-26A. (See Teletypewriter control unit.)		
Tropical climates, operation.....	46	62
Troubleshooting chart, system.....	51	64

	Paragraph	Page
Unpacked equipment, checking	18	18
Unpacking	17	18
Use, purpose and	3	4
Visual inspection	50	64
Whip antenna:		
Description	8a	7
Installation	22	22

BY ORDER OF THE SECRETARIES OF THE ARMY AND THE AIR FORCE :

MAXWELL D. TAYLOR,
General, United States Army,
Chief of Staff.

OFFICIAL :

R. V. LEE,
Major General, United States Army,
The Adjutant General.

THOMAS D. WHITE,
Chief of Staff, United States Air Force.

OFFICIAL :

J. L. TARR,
Colonel, United States Air Force,
Director of Administrative Services.

DISTRIBUTION :

Active Army:

ASA (2)	TASSA (15)	7-52 (2)
CNGB (1)	Mid-Western Rgn Ofc (TASSA)	11-5 (2)
Technical Stf, DA (1) except	(1)	11-7 (2)
CSigO (30)	USA Sig Pub Agcy (8)	11-15 (2)
Technical Stf Bd (1)	USA Sig Engr Agcy (1)	11-16 (2)
USCONARC (5)	USA Comm Agcy (2)	11-17 (2)
USA Arty Bd (1)	USA Sig Eqp Spt Agcy (2)	11-37 (2)
USA Armor Bd (1)	USA Sig Msl Spt Agcy (13)	11-55 (2)
USA Inf Bd (1)	WRAMC (1)	11-57 (2)
USA Air Def Bd (1)	AFIP (1)	11-85 (2)
USA Abn & Elet Bd (1)	AMS (1)	11-87 (2)
USA Avn Bd (1)	Ports of Emb (OS) (2)	11-95 (2)
USA Armor Bd Test Sec (1)	Trans Terminal Comd (1)	11-96 (2)
USA Air Def Bd Test Sec (1)	Army Terminals (1)	11-98 (2)
USA Arctic Test Bd (1)	OS Sup Agcy (2)	11-117 (2)
US ARADCOM (2)	Yuma Test Sta (2)	11-500 (AA-AE) (2)
US ARADCOM Rgn (2)	USA Elet PG (1)	11-537 (2)
OS Maj Comd (5)	Sig Lab (5)	11-557 (2)
OS Base Comd (5)	Sig Fld Maint Shops (3)	11-587 (2)
Log Comd (5)	USA Ord Msl Comd (3)	11-592 (2)
MDW (1)	Fld Comd, AFSWP (5)	11-597 (2)
Armies (5)	Mil Dist (1)	17-51 (2)
Corps (2)	Sector Comd, USA Corps (Res)	17-55 (2)
Div (2)	(1)	20-45 (2)
USATC (2)	USA Corps (Res) (1)	20-46 (2)
Svc Colleges (5)	JBUSMC (2)	20-300 (2)
Br Svc Sch (5) except	Units organized under following	32-51 (2)
USASCS (180), USAAMS (300),	TOE's:	32-55 (2)
US ARADSCH (250),	5-346 (2)	32-56 (2)
USASESCS (50)	5-347 (2)	32-500 (2)
Gen Depots (2) except	5-348 (2)	39-51 (2)
Atlanta Gen Depot (None)	6-315 (2)	39-61 (2)
Sig Sec, Gen Depots (10)	6-317 (2)	39-71 (2)
Sig Depots (17)	6-545 (2)	44-12 (2)
Army Pictorial Cen (2)	6-558 (2)	44-15 (2)
Engr Maint Cen (1)	6-635 (2)	44-101 (2)

NG: State AG (3); units—same as Active Army except allowance is one copy to each unit.

USAR: None.

For explanation of abbreviations used, see AR 320-50.



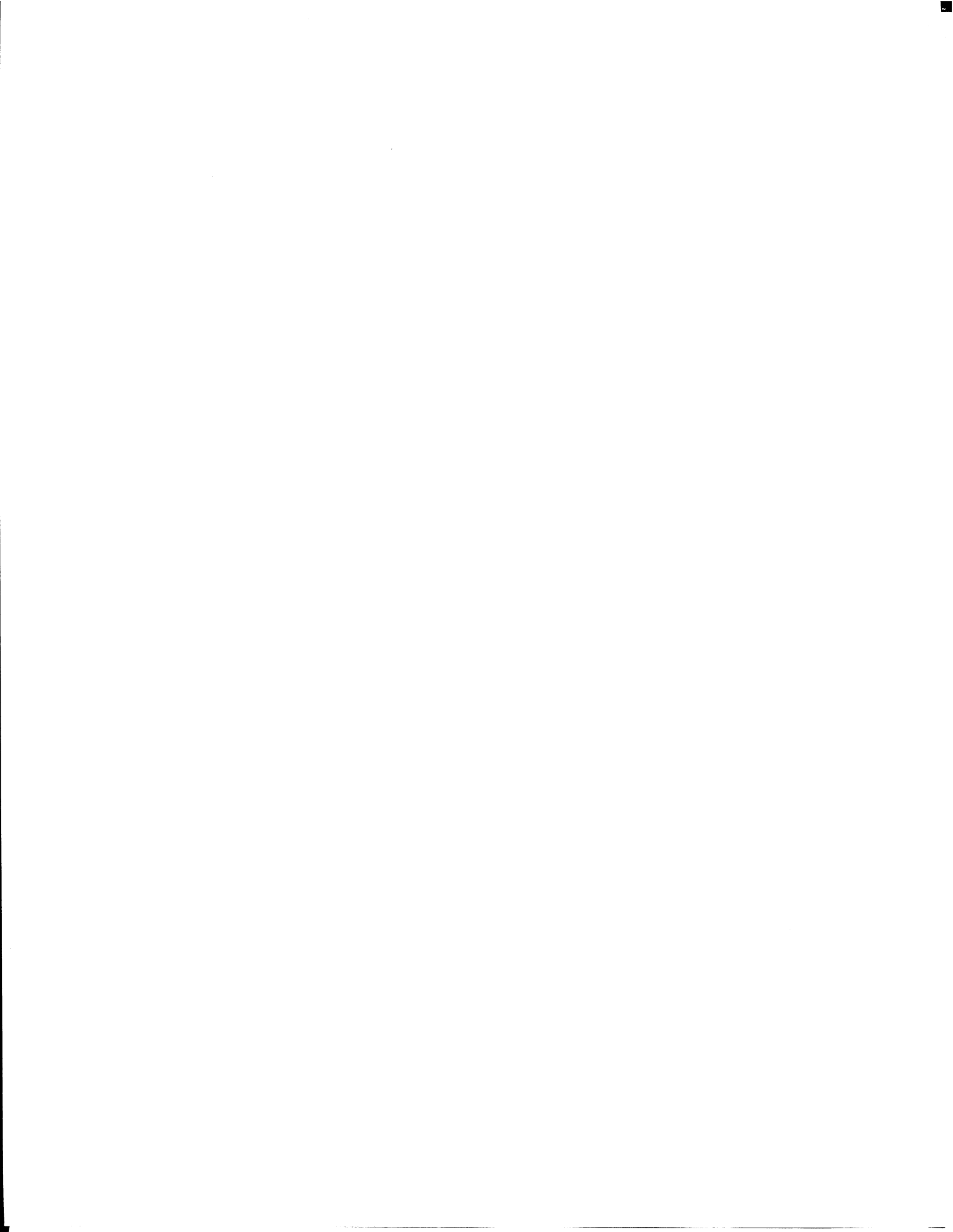



OBsolete

Operator's Manual

RADIO SETS AN/GRC-26A, AN/GRC-26B, AND AN/GRC-26C

TM 11-5820-202-10
TO 31R2-2GRC26-151
CHANGES No. 4

8 Jan 70
L.H.S.

DEPARTMENTS OF THE ARMY
AND THE AIR FORCE
WASHINGTON 25, D.C., 14 September 1962

TM 11-5820-202-10/TO 31R2-2GRC26-151, 7 January 1959, is changed as follows:

Page 4, paragraph 2. Add the following subparagraph after subparagraph e.

f. Index of Equipment Publications. Refer to DA Pamphlet 810-4 to determine what changes to or revisions of this publication is current.

Page 74. Designate the first paragraph as "1"

Page 74, paragraph 1. Change TM 11-2225 to read:

TM 11-2225, Teletypewriter Sets AN/GGC-3, AN/GGC-3A and Teletypewriter Reperforator-Transmitters TT-76/GGC, TT-76A/GGC, and TT-76B/GGC.

Page 74. Add the following after the last sentence:

2. A maintenance allocation chart is contained in TM 11-5820-202-20.

Additional instructions concerning maintenance of this equipment are contained in—

a. *Technical Manual.*

TM 11-261, Dual Diversity Converters CV-31/TRA-7, CV-31A/TRA-7, CV-31B/TRA-7, CV-31C/TRA-7, and CV-31D/TRA-7.

b. *Operator and Organizational Maintenance Manual.*

TM 11-5815-206-12, Teletypewriter Set AN/PGC-1 and Teletypewriters TT-

4A/TG, TT-4B/TG, TT-4C/TG and TT-335/TG.

c. *Operator's Maintenance Repair Parts and Special Tools List.*

TM 11-5805-230-10P, Line Units BE-77-A, BE-77B, and BE-77-C.

TM 11-5820-216-10P, Frequency Shift Converters CV-182/GRC-26A, CV-182A/GRC-26A and CV-182B/GRC-26A.

TM 11-5820-217-10P, Power Supplies PP-712/GRC-26A and PP-712A/GRC-26A.

d. *Basic Issue Items List.*

TM 11-5820-251-10P, Mast AB-155/U, AB-155A/U, and AB-155B/U.

e. *Operator and Organizational Maintenance Repair Parts and Special Tools List and Maintenance Allocation Chart:*

TM 11-5820-479-12P, Mast Base MP-65, MP-65A and MP-65B.

TM 11-5805-200-12P, Telephone EE-8, -8A, -8B, -8C, -8D, and -8E.

TM 11-5965-230-12P, Headsets HS-30-A, HS-30-B, HS-30-C, HS-30-D, HS-30-E, HS-30-F, HS-30-G, HS-30-H, HS-30-J, HS-30-K, HS-30-L, HS-30-R and HS-30-U.

TM 11-6625-235-12P, Rectifier Power Unit RA-133, RA-133-A-B.

TM 11-5820-230-12P, Radio Set Control Group AN/GRA-14.

TM 11-5820-257-12P, Antenna Tuning Unit BC-939-A, -939-B and Tuner, Radio Frequency TN-339/GR.

* These Changes supersede C 3, 11 July 1960.

TM 11-5805-272-12P, Generators GN-38, -38A and -38B.

TM 11-5815-208-12P Reperforator TT-16/FG, TT-17/FG, TT-53/FG and Perforator-Transmitter TT-56/MGC.

f. *Operator, Organizational, Field and Depot Maintenance Repair Parts and Special Tool List and Maintenance Allocation Chart.*

TM 11-5820-431-15P, Control Boxes C-345/MRC-2 and C-345A/MRC-2.

TM 11-6115-223-15P, Generator Set, Gasolene Engine, Trailer Mounted PU-294/G.

TM 11-5965-218-15P, Microphone T-50 and Microphone, Dynamic M-105/U.
TM 11-5965-216-15P, Handset TS-9-F.

g. *Supply Manuals.*

SIG 7&8, S-55/GRC

SIG 7&8, S-69/GRC

SIG 7&8, R-388/URR

SIG 7&8, CY-1216/U

SIG 7&8, C-292/TRA-7

SIG 7&8, O-39/TRA-7

SIG 7&8, O-41/TRA-7.

Pages 75 thru 84, APPENDIX II. Delete in its entirety and substitute the following:

APPENDIX II

BASIC ISSUE ITEMS LIST

RADIO SETS AN/GRC-26, AN/GRC-26A, -26B, AND -26C (Superseded)

Section I. INTRODUCTION

1. Scope

a. This appendix lists items supplied for initial operation and for running spares. The list includes tools, accessories, parts, and material issued as part of the major end item. The list includes all items authorized for basic operator maintenance of the equipment. End items of equipment are issued on the basis of allowances prescribed in equipment authorization tables and other documents that are a basis for requisitioning.

b. Columns are as follows:

(1) *Source, maintenance, and recoverability code.* Not used.

(2) *Federal stock number.* This column lists the 11-digit Federal stock number.

(3) *Designation by model.* The dagger (†) indicates model and/or serial number in which the part is used.

(4) *Description.* Nomenclature or the standard item name and brief identifying data for each item are listed in this column. When requisitioning, enter the nomenclature and description.

(5) *Unit of issue.* The unit of issue is each

unless otherwise indicated and is the supply term by which the individual item is counted for procurement, storage, requisitioning, allowances, and issue purposes.

(6) *Expendability.* Nonexpendable items are indicated by NX. Expendable items are not annotated.

(7) *Quantity authorized.* Under "Items Comprising an Operable Equipment," the column lists the quantity of items supplied for the initial operation of the equipment. Under "Running Spares and Accessory Items," the quantities listed are those issued initially with the equipment as spare parts. The quantities are authorized to be kept on hand by the operator for maintenance of the equipment.

(8) *Illustration.* The Item No. column lists the reference symbols used for identification of the items in the illustration or text of the manual.

2. Other Service Stock Numbers

Other service items listed herein are authorized in accordance with AR 700-51.

SECTION I' 'TIONAL PARTS LIST

(1) SOURCE MAINTENANCE AND RECOVERABILITY CODE	(2) FEDERAL STOCK NUMBER	(3) DESIGNATION BY MODEL	(4) DESCRIPTION	(5) UNIT OF ISSUE	(6) EXPENDABILITY	(7) QUANTITY AUTHORIZED	(8) ILLUSTRATIONS		(9)
							FIGURE NO	ITEM NO	
	5820-186-9250	1 2 3 1 5	RADIO SETS AN/GRC-26, AN/GRC-26A, B, C: gnd use: 400 w Al, 300 A3, and 400 w F9 emission; 218 mc freq range: 120 v ac 50 60 cyc, single ph NOTE: Model Column 1 refers to AN/GRC-26; Column 2 refers to AN/GRC-26 thru serial No. 778; Column 3 refers to AN/GRC-26A ser No. 779 thru No. 830; Column 4 refers to AN/GRC-26B; Column 5 refers to AN/GRC-26C		NX				
ITEMS COMPRISING AN OPERABLE EQUIPMENT									
	Ord thru AGC	+ + +	TECHNICAL MANUAL TM 11-5820-202-10			2			
	5820-194-8300	+ + + +	AMPLIFIER, AUDIO FREQUENCY: speech amplifier BC-614-H, 1		NX	1			
	5985-221-5566	+ + + +	BASE, MAST: Mast Base MP-47-A		NX	1			
	5820-221-5553	+	BASE, MAST: Mast Base MP-65-A		NX	2			
	5820-503-2953	+ + + +	BASE, MAST: Mast Base MP-65-B		NX	2			
	5820-497-8705	+	BRACKET: Mast Bracket No. MP-50		NX	2			
	5820-404-2718	+ + + +	BRACKET: Mast Bracket No. MP-50-A		NX	2			
	5805-356-3548	+ + + +	BRACKET: "T" shape; holds telephone EE-8; Sig dwg No. SC-C-28020			2			
	5820-497-8596	+ + + +	BRACKET MT-657/GRC			1			
	6145-164-0156	+ + + +	BRAID, WIRE: tinned copper: 3/16 in id; Alpha Wire No. 1230	ft		15			
	6145-241-1770	+	BRAID, WIRE: tinned copper: 1 in w x 0.017 thk; Belden Code Facing	ft		9			
	5820-194-8130	+	CABINET, ELECTRICAL EQUIPMENT: CY-826/GRC-26		NX	1			
	5820-194-8131	+ + + +	CABINET, ELECTRICAL EQUIPMENT: case; CY-827/GRC-26, for Frequency Shift Excites O-39()/TRA-7 when installed in Radio Set AN/GRC-26		NX	1			
	5820-503-0804	+	CABINET, ELECTRICAL EQUIPMENT: CY-1216 U		NX	1			
	5995-164-7902	+ + + +	CABLE ASSEMBLY, POWER, ELECTRICAL: Cord CX-962/TRA-7; 1 ft 1g; Sig dwg No. SC-C-34601			1		W108	
	5995-164-7692	+ + + +	CABLE ASSEMBLY, POWER, ELECTRICAL: Cord CD-763; 13 ft 1g			1		W1	
	5995-170-7943	+ + + +	CABLE ASSEMBLY, POWER, ELECTRICAL: Power Cable Assembly No. CX-1165/U; 13 ft 1g			2		W2	
	5995-170-7929	+ + + +	CABLE ASSEMBLY, POWER, ELECTRICAL: Power Cable Assembly No. CX-1166/U; 50 ft 1g			2		W3	
	5995-170-8780	+ + + +	CABLE ASSEMBLY, POWER, ELECTRICAL: Special Purpose Cable Assembly No. CX-1200/U; 3 ft 10-1/2 in 1g			2			
	5995-170-8773	+ + +	CABLE ASSEMBLY, POWER, ELECTRICAL: special purpose cable assembly No. CX-1201/U; 3 ft 9 in 1g			2			
	5995-160-5954	+ + + +	CABLE ASSEMBLY, RADIO FREQUENCY: Cord No. CG-67/AMQ-2; 5 ft 6 in 1g			2		W12	
	5995-238-3114	+ + + +	CABLE ASSEMBLY, RADIO FREQUENCY: Cord No. CG-390A/U; 6 ft 1g			1			
	5995-171-2980	+	CABLE ASSEMBLY, RADIO FREQUENCY: Cord No. CG-390/U; 3 ft 1g			1			

(1) SOURCE MAINTENANCE AND RECOVERABILITY CODE	(2) FEDERAL STOCK NUMBER	(3) DESIGNATION BY MODEL	(4) DESCRIPTION	(5) UNIT OF ISSUE	(6) EXPENDABILITY	(7) QUANTITY AUTHORIZED	(8) ILLUSTRATIONS		(9)
							FIGURE NO	ITEM NO	
		1 2 3 4 5							
	5995-251-3832	+	AV/GRC-26, AV/GRC-26A,B,C (continued)						
	5995-272-9111	+	CABLE ASSEMBLY, RADIO FREQUENCY: Cord No. CG-390/U; 17 ft 11 in 1g			1			
		+	CABLE ASSEMBLY, RADIO FREQUENCY: RF Cable Assembly No. CG-527A/U; 75 ft 1g Sig dwg			1			
		+	No. SC-D-22810						
	5995-272-9144	+	CABLE ASSEMBLY, RADIO FREQUENCY: RF Cable Assembly No. CG-527A/U; 500 ft 1g; Sig dwg			2			
		+	No. SC-D-22810						
	5995-636-0186	+	CABLE ASSEMBLY, RADIO FREQUENCY: RF Cable Assembly No. CG-528A/U; 30-3-1 in 1g; Sig dwg			1			W17
		+	No. SC-D-22837						
	5995-284-6679	+	CABLE ASSEMBLY, RADIO FREQUENCY: RF Cable Assembly No. CG-562/U; 6 ft 1g			2			
		+	CABLE ASSEMBLY, SPECIAL PURPOSE, ELECTRICAL: Cord No. CD-267; 16 in 1g Sig dwg			2			
	5995-162-7141	+	No. SC-D-5386						
		+	CABLE ASSEMBLY, SPECIAL, ELECTRICAL: Cord No. CD-605; 10 ft 1g			1			
	6625-170-9608	+	CABLE ASSEMBLY, SPECIAL PURPOSE, ELECTRICAL: Cord No. CD-764; 14 ft 5 in 1g; Sig dwg			1			W7
	5995-164-6494	+	CABLE ASSEMBLY, SPECIAL PURPOSE, ELECTRICAL: Cord No. CD-764; 14 ft 5 in 1g; Sig dwg			1			
		+	No. SC-D-27457						
	5995-161-4670	+	CABLE ASSEMBLY, SPECIAL PURPOSE, ELECTRICAL: Cord No. CX-935/TRA-7; 7 ft 4 in 1g			2			
		+	CABLE ASSEMBLY, SPECIAL PURPOSE, ELECTRICAL: Cord No. CX-936/TRA-7; 6 ft 4 in 1g			1			
	5995-164-6598	+	CABLE ASSEMBLY, SPECIAL PURPOSE, ELECTRICAL: Cord No. CX-937/TRA-7; 6 ft 1g			1			
	5995-161-4673	+	CABLE ASSEMBLY, SPECIAL PURPOSE, ELECTRICAL: Cord No. CX-957/TRA-7; 6 ft 1g			1			
	5995-163-1740	+	CABLE ASSEMBLY, SPECIAL PURPOSE, ELECTRICAL: Cord No. CX-938/TRA-7; 6 ft 4 in 1g			1			
		+	CABLE ASSEMBLY, SPECIAL PURPOSE, ELECTRICAL: Cord No. CX-958/TRA-7; 6 ft 4 in 1g			1			
	5995-163-0035	+	CABLE ASSEMBLY, SPECIAL PURPOSE, ELECTRICAL: Cord No. CX-959/TRA-7; 6 ft 4 in 1g			1			
	5995-163-1742	+	CABLE ASSEMBLY, SPECIAL PURPOSE, ELECTRICAL: Cord No. CX-961/TRA-7; 1 ft 1g Sig dwg			1			W106
		+	No. SC-C-31600; w/red band						
	5995-163-1741	+	CABLE ASSEMBLY, SPECIAL PURPOSE, ELECTRICAL: Cord No. CX-961/TRA-7; 1 ft 1g w/blue band; Sig dwg No. SC-C-31600			1			
		+	CABLE ASSEMBLY, SPECIAL PURPOSE, ELECTRICAL: Special Purpose Core Assembly			1			W8
	5995-240-0876	+	CABLE ASSEMBLY, SPECIAL PURPOSE, ELECTRICAL: Special Purpose Core Assembly			1			
		+	No. SC-D-22489						
	5995-237-8038	+	CABLE ASSEMBLY, SPECIAL PURPOSE, ELECTRICAL: Special Purpose Cable Assembly			1			W9
		+	No. CX-1150/U; 15 ft 1g Sig dwg No. SC-DL-22674						
	5995-237-8037	+	CABLE ASSEMBLY, SPECIAL PURPOSE, ELECTRICAL: Special Purpose, Cable Assembly			2			
		+	No. CX-1151/U; 15 ft 1g Sig dwg No. SC-D-22684-A						
	5995-170-7919	+	CABLE ASSEMBLY, SPECIAL PURPOSE, ELECTRICAL: Special Purpose Cable Assembly			1			W11
		+	No. CX-1152/U; 4 ft 1g Sig dwg No. SC-D-22680						
	5995-228-4334	+	CABLE ASSEMBLY, SPECIAL PURPOSE, ELECTRICAL: Electrical Special Purpose Cable			1			
		+	Assembly No. CX-1650/U; 3 ft 1g Sig dwg No. SC-DL-85080						
	5995-232-3026	+	CABLE ASSEMBLY, SPECIAL PURPOSE, ELECTRICAL: Special Cable Assembly No. CX-1851/U; 4 ft 1g			2			

AV/GRC-26, AV/GRC-26A, B, C

(1) SOURCE MAINTENANCE AND RECOVERABILITY CODE	(2) FEDERAL STOCK NUMBER	(3) DESIGNATION BY MODEL	(4) DESCRIPTION	(5) UNIT OF ISSUE	(6) EXPENDABILITY	(7) QUANTITIES AUTHORIZED	(8) ILLUSTRATIONS	
							FIGURE NO	ITEM NO
		1 2 3 4 5	AN/GRC-26, AN/GRC-26A, B, C (continued)					
	5995-256-9968	+	CABLE ASSEMBLY, POWER, ELECTRICAL: Cable Assembly Special Purpose Electrical No. CX-1939/U; 5 ft 3-7/8 in lg Sig dwg No. SC-C-68778			2		W5
	5820-537-7884	+	CASE CY-689/GRC-26; Sig dwg No. SC-D-28022			1		
	5820-242-9130	+	CASE, CONVERTER CY-825/GRC-26; to house CV-31/TRA-7			1		
		+	CHAIR: w/o arms; Westmoreland Metal Mfg Co type No. 1052CB; (26-C-2330 Om Stk No.)			1		
		+	CHAIR: w/o arms; American Seating Co type No. 671 (26-C-7920 Om Stk No.)			1		
	5925-498-4084	+	CIRCUIT BREAKER: air, dpst; 20 amp 120/240 v ac 60 cyc; square D No. W02-161722S			1		
		+	CLOCK: Mechanical B day; Longines Wittenauer type No. 11 (18-C-1155-100 Om Stk No.)			1		
	5935-196-4689	+	CONNECTOR, ADAPTER: SigC Adapter No. M-359			5		
	5935-196-4689	+	CONNECTOR, ADAPTER: SigC Adapter No. M-359			1		
	5935-237-7351	+	CONNECTOR, ADAPTER: Sig plug No. PL-258			2		
	5820-162-6330	+	CONTROL, RADIO RECEIVER: AN Control Box No. C-315/MRC-2, C-345A/MRC-2			1		
	5820-243-0818	+	RADIO: Teletypewriter Control C-608/GRC-26A; Sig dwg No. SC-D-7886			1		
	5805-162-6302	+	CONTROL, TELEGRAPH: Line unit No. BE-77-A			1		
	5815-162-8257	+	CONTROL, TRANSMITTER: Control Unit No. C-292/TRA-7, C-292A/TRA-7 OR			1		
	5815-162-1301	+	CONTROL, TRANSMITTER-TELETYPEWRITER: Control Unit No. C-292B/TRA-7			1		
	5820-240-3295	+	CONVERTER, FREQUENCY SHIFT CONVERTER: No. CV-182/GRC-26A and No. CV-182A/GRC-26A			1		
	5995-164-6648	+	CORD, HEADSET: Cord No. CD-201A 5 ft 3 in lg Sig dwg No. SC-D-6609			1		
	6625-170-9608	+	CORD ASSEMBLY, ELECTRICAL: Sig Cord No. CD-605; 6 ft 10 in lg; Sig dwg No. SC-A-7999			1		W6
	5815-404-8438	+	COVER: BC-198			2		
	5815-498-7933	+	COVER: Cover No. BG-199			1		
	5815-498-7958	+	COVER, TELETYPEWRITER REPERFORATOR TRANSMITTER: Cover No. BG-200			1		
	5815-194-9388	+	DUAL DIVERSITY CONVERTER CV-31/TRA-7, CV-31, A, B, C/TRA-7			1		
	6625-404-3732	+	FREQUENCY METER BC-221-AA, AB, AC, AE, AF, AG, AH, AJ, AK, AL and AV			1		
	6115-635-5614	+	GENERATOR SET, GASOLINE, TRAILER MOUNTED: PU-291/G			1		
	5975-164-7259	+	HEADSET HS-30: HS-30-A, B, C, D, E, F, G, H, J, K, L, M, R, V; 250 ohm imp			1		
	5970-285-0123	+	INSULATOR, BOWL: Steatite, 2-23/32 in lg x 5-1/4 in dia; Alsigna type No. A-9232			1		
	5970-405-9871	+	INSULATOR, SPREADER: Steatite grade L-4, brown glazed; 4 in lg x 3/4 in dia			6		
	5805-171-3370	+	KEY, TELEGRAPH: Key J-45			1		
	6240-267-2860	+	LAMP, INCANDESCENT: Lamp, 125 v 15 w; intermediate screw base GE part No. 1517X (125) Engrg Stk No.)			1		
		+	LAMP, INCANDESCENT: Lamp, 120 v, 50 w; med screw base; Masda No. 50A/BS (17-6767.100-050)			1		
	5995-279-2576	+	LEAD, ELECTRICAL: 1 cond No. 7AWG; 10 ft lg; U S Army Spec No. 71-1683			1		
	5995-252-3958	+	LEAD, ELECTRICAL: wire braid; No. 7AWG; 5 ft lg; B/W part/dwg No. 26-567B			1		
	(ADDED) SEE PAGE 5 OF 6-6							

(1) SOURCE MAINTENANCE AND RECOVERABILITY CODE	(2) FEDERAL STOCK NUMBER	(3) DESIGNATION BY MODEL	(4) DESCRIPTION	(5) UNIT OF ISSUE	(6) EXHAUSTIBILITY	(7) QUANTITY AUTHORIZED	(8) ILLUSTRATIONS	
							FIGURE NO	ITEM NO
		1 2 3 4 5	AV/GRC-26, AN/GRC-26A, B, C (continued)					
		+	LIGHT EXTENSION: trouble light; 25 ft lg (17-7047, 075, 250 Eng Stk No.)			1		
	5965-163-1791	+	LOUDSPEAKER LS-3; dynamic; 6 in cone; PM type			2		
	5820-251-2366	+	MAST AB-155/U, AB-155A/U			6		
	5820-199-8842	+	MAST SECTION: MS-49			1		
	5820-155-8131	+	MAST SECTION: MS-50			1		
	5820-155-8130	+	MAST SECTION: MS-51			1		
	5820-155-8129	+	MAST SECTION: MS-52			1		
	5820-156-1055	+	MAST SECTION: MS-53			1		
	5820-199-8891	+	MAST SECTION: MS-116			4		
	5820-199-8843	+	MAST SECTION: MS-117			2		
	5820-199-8841	+	MAST SECTION: MS-118			2		
	5965-128-2512	+	MICROPHONE: microphone T-17, T 17B,D; Carbon; low imp 30 to 60 ohm ekt			1		
	5965-170-5232	+	MICROPHONE: Microphone T-50, 20,000 ohm imp			1		
	5820-128-1484	+	MOUNTING, RADIO RECEIVER: mounting MF-563 MRC			1		
	5820-186-9474	+	MOUNTING: Mounting FT-178			2		
	5820-355-9242	+	MOUNTING: Shock mtg base for radio mtr; Vibe/liminator part No. BW-2533/6			1		
	5815-224-5287	+	OSCILLATOR, RADIO FREQUENCY: Frequency shift exciter No. O-398/TRA-7, O-39C TRA-7			1		
	5820-392-9654	+	PAD, SILENCING: felt; 17-1/4 in x 17-1/8 in x 1/2 in thk; Amer Felt Co No. 8537			1		
			NOTE: For use w/TT-55, in AN/GRC-26, AN/GRC-26A Serial Nos. 1 thru 788					
	5815-198-9033	+	PERFORATOR TRANSMITTER: Reperforator-Transmitter TF-56/MGC			1		
		+	PLIERS TL-103; diagonal cutting w cutters (5110-00-17075 Ord Stk No.)			1		
	5975-407-6373	+	POLE LANCE: wood, pole 11 ft 5 in lg; Sig dwg No. SC-C-27971			4		
	6625-245-9673	+	POWER SUPPLY: rectifier power unit No. RA-133, RA-133A, B			1		
	5820-548-1682	+	POWER SUPPLY: electronic power supply No. PP-712/GRC-26A, PP-712A/GRC-26A			1		
	6130-230-7527	+	POWER SUPPLY: rectifier RA-87, RA-87A			1		
			NOTE: Required for Remote Control Operation only in AN/GRC-26C; in AN/GRC-26A and 26B furnishes rectified power for teletype					
	5820-221-2427	+	RACK: cabinet Electrical Equipment, No. CY-1050 GRC-26A			1		
	5895-237-8438	+	RACK: rack No. MF-655/GRC; Sig dwg SC-C-27979			2		
	5820-503-1090	+	RADIO SET CONTROL GROUP: AN/GRA-14			1		
	5820-194-2992	+	RECEIVER, RADIO: Radio Receiver No. R-336/GRC-26			2		
	5820-537-3895	+	RECEIVER, RADIO: Radio Receiver No. R-388 URR			2		
	5820-030-2969	+	REEL: wire reel No. RL-29			2		
			REPERFORATOR TRANSMITTER, Teletypewriter No. TT-76/GCC (ATT-76/MGC Sig Stk No.)			1		
	4020-408-4219	+	ROPE: rope cotton braid No. RP-5			50		

(f) SOURCE MAINTENANCE AND RECOVERABILITY CODE	(e) FEDERAL STOCK NUMBER	(d) DESIGNATION BY MODEL	(c) DESCRIPTION					(b) QUANTITY AUTHORIZED	(a) ILLUSTRATIONS	
			1	2	3	4	5		FIGURE NO	ITEM NO
						AV/GRC-26, AV/GRC-26A,B,C (continued)				
	5945-577-2755		+	+	+	RELAY, ARMATURE: Sigma Inst Type No. 7210Z160TGICP	1		01	
	5960-273-2460		+	+	+	RETAINER, ELECTRON TUBE: times fax No. 2THaT	2			
	5120-224-2504		+	+	+	WRENCH: Allen type for No. 8 Allen Set Screw	1			
						RUNNING SPARES AND ACCESSORY ITEMS				
						RADIO SET AV/GRC-26; AV/GRC-26A,B,C				
	5985-221-5566		+	+	+	BASE, MAST: Mast base No. MP-47-A	NX	1		
	5820-221-5553		+			BASE, MAST: Mast base No. MP-65-A	NX	1		
	5820-503-2983		+	+	+	BASE, MAST: Mast base No. MP-65-B	NX	1		
	5820-497-9664		+	+	+	BOX: BX-19, BX-19A		2		
	5820-497-8705		+			BRACKET: Mast bracket No. MP-50	NX	1		
	5820-404-2718		+	+	+	BRACKET: Mast bracket No. MP-50-A	NX	1		
	7920-285-9816		+	+	+	BROOM, FLOOR: Flat, 55 in lg x 10 in w x 2-1/2 in thk; (38-B-105 OM Stk No.)		1		
	5995-636-0186		+	+	+	BRUSH, CLEANING: 8 in lg; Dietzgen No. 4211A		1		
			+	+	+	CABLE ASSEMBLY, RADIO FREQUENCY: RF Cable Assembly No. CG-358A/U; 30-3/4 in lg; Sig dwg No. SC-D-22837		1		W17
	5995-163-1742		+	+	+	CABLE ASSEMBLY, SPECIAL PURPOSE, ELECTRICAL: Cord No. CX-971/TRA-7; 4 ft lg Sig dwg No. SC-C-34600; w/red band		1		W106
	5995-163-1741		+	+	+	CABLE ASSEMBLY, SPECIAL PURPOSE, ELECTRICAL: Cord No. CX-961/TRA-7; 4 ft lg w/blue band; Sig dwg No. SC-C-34600		1		
	5995-256-9968		+	+	+	CABLE ASSEMBLY, POWER, ELECTRICAL: Cable Assembly Special Purpose Electrical No. CX-1989/U; 5 ft 3-7/8 in lg Sig dwg No. SC-C-68378		1		W5
	6605-222-1756		+	+	+	CLIPBOARD: 12-1/2 in lg x 9 in w; Julius Bandes and Co No. CT-112 (53-F-2296 OM Stk No.)		1		
	5935-196-4689		+	+	+	COMPASS, MAGNETIC, HAND HELD: K and E type No. 5600-1/2	NX	1		
	5935-196-4689		+	+	+	CONNECTOR, ADAPTER: Sig Adapter No. M-359		1		
	5935-237-7351		+	+	+	CONNECTOR, ADAPTER: Sig Adapter No. M-359		1		
	5975-193-6771		+	+	+	CONNECTOR, ADAPTER: Sig Plug No. PL-258		2		
	5975-193-6774		+	+	+	GUY: Hold down for whip ant; 11 ft 3 in; Sig dwg No. SC-B-28061		2		
	5120-230-7857		+	+	+	GUY: Hold down for whip ant; 11 ft 5 in lg; Sig dwg No. SC-B-28062		1		
			+	+	+	HAMMER, HAND: 6 lb sledge		1		
	5820-356-4159		+	+	+	HEATER, AIR: Coates Elec mfg Model No. AAT-13; (17-5741.075.115 Engr Stk No.)	NX	1		
			+	+	+	HARDWARE KIT: for mtgs and maint		1		

(1) (2) (3) (4) (5) (6) (7) (8) (9)

SOURCE MAINTENANCE AND RECOVERABILITY CODE	FEDERAL STOCK NUMBER	DESIGNATION BY MODEL	DESCRIPTION	UNIT OF ISSUE	EXPENDABILITY	QUANTITY AUTHORIZED	ILLUSTRATIONS	
							FIGURE NO	ITEM NO
		1 2 3 4 5	AN/GRC-26, AN/GRC-26A, B, C (continued)					
	5975-164-7259	+	HEADSET HS-30, HS-30 A, B, C, D, E, F, G, J, K, L, M, R, V; 250 ohm imp			1		
	5970-285-0123	+	INSULATOR, BOWL: Steatite, 2-23/32 in lg x 5-1/4 in dia; Alsigma Type No. A-0232			1		
	5970-405-8971	+	INSULATOR, SPREADER: Steatite grade L-4, brown glazed; 4 in lg x 3/4 in dia			18		
		+	KNIFE: TL-29 (Engrg Stk No. 41, 5153, 305, 060)			1		
	6240-267-2860	+	LAMP, INCANDESCENT: Lamp, 125 v 15 w; intermediate screw base GE part No. 1577N(125)			1		
		+	LAMP, INCANDESCENT: Lamp, 120 v, 50 w; Med screw base; Mazda No. 50A/RS (17-6767, 100, 050 Engrg Stk No.)			1		
	5995-279-2576	+	LEAD, ELECTRICAL: 1 cond No. TAWG; 10 ft lg; U S Army Spec No. 71 1683			1		
	5995-252-3958	+	LEAD, ELECTRICAL: wire braid; No. TAWG; 5 ft lg; B/W part/dwg No. 26-567B			1		
	5820-199-8842	+	MAST SECTION: MS-49			2		
	5820-155-8131	+	MAST SECTION: MS-50			2		
	5820-155-8130	+	MAST SECTION: MS-51			2		
	5820-155-8129	+	MAST SECTION: MS-52			2		
	5820-156-1055	+	MAST SECTION: MS-53			2		
	5820-199-8831	+	MAST SECTION: MS-116			4		
	5820-199-8843	+	MAST SECTION: MS-117			2		
	5820-199-8841	+	MAST SECTION: MS-118			2		
		+	PLIERS TL-103: diagonal cutting w/cutters (5110 00-17075 Ord Stk No.)			1		
	5975-187-5295	+	ROD, GROUND: GR-26			1		
		+	SCREWDRIVER, COMMON: 5/16 in w tip, 6 in lg; (41 S 4404 Ord Stk No.)			1		
		+	SCREWDRIVER: TL-21 (41 S 1225 Ord Stk No.)			1		
		+	SOLEIRING IRON: TL-420 (41-4-6R8 Ord Stk No.)			1		
	5975-266-2034	+	SPLICE, CONDUCTOR: compression; accom 1 continuous and 1 branch max No. 10AWG; Burlydy No. KS-90			24		
	5120-240-5328	+	WRENCH: Open end TL-475/U			1		
	5120-223-7010	+	WRENCH: Special, "T" shape; Sig dwg No. SC-C-28016			1		
			RADIO TELETYPEWRITER CONTROL C-808/GRC-26A					
	5920-057-2952	+	FUSE, CARTRIDGE: 1 amp Littlefuse No. 413001			5		
	6240-155-8706	+	LAMP: LM-52; GE type No. 47			1		E5
	5945-577-2755	+	RELAY, ARMATURE: Sigma Inst Type No. 72J0Z1G0TGP			1		D1
	5120-224-2504	+	WRENCH: Allen type for No. R Allen Setscrew			1		

AN/GRC-26, AN/GRC-26A, B, C

G. H. DECKER,
General, United States Army,
Chief of Staff.

Official:

J. C. LAMBERT,
Major General, United States Army,
The Adjutant General.

Distribution:

Active Army:

DASA (6)	Sacramento Sig Dep (17)	11-39
USASA (2)	WRAMC (1)	11-55
CNGB (1)	USA Trans Tml Comd (1)	11-57
Tech Stf, DA (1) except	Army Tml (1)	11-85
CSigO (5)	POE (1)	11-87
Tech Stf Bd (1)	OSA (1)	11-95
USCONARC (5)	USAEPG (2)	11-97
USAARTYBD (1)	AFIP (1)	11-98
USAARMBD (2)	AMS (1)	11-99
USAIB (1)	Army Pic Cen (2)	11-117
USARADB (2)	EMC (1)	11-155
USAAVNBD (1)	USA Strat Comm Comd (4)	11-157
USA Abn Elet & SPWAR Bd	USASSA (25)	11-500 (AA-AE) (4)
(1)	USASSAMRO (1)	11-557
USAATBD (1)	USARCARIB Sig Agcy (1)	11-587
ARADCOM (2)	USA Sig Msl Spt Agcy (13)	11-592
ARADCOM, Rgn (2)	Sig Fld Maint Shops (3)	11-597
OS Maj Comd (3)	Def Log Svc Cen (1)	17
OS Base Comd (2)	USA Corps (3)	17-51
LOGCOMD (2)	JBUSMC (2)	17-55
MDW (1)	Units org under fol TOE:	20-45
Armies (2)	(2 copies each	20-46
Corps (2)	UNOINDC)	29-56
Instl (2) except	7	30-25
Ft Monmouth (63)	7-52	30-29
USATC AD (2)	9-12	30-500 (AA-AE)
USATC Engr (2)	9-22	32-51
USATC Inf (2)	9-86	32-52
USATC FA (2)	11-5	32-56
USATC Armor (2)	11-7	32-57
USAOMC (2)	11-15	32-67
Svc Colleges (2)	11-16	32-68
Br Svc Sch (2)	11-17	37
Gen Dep (2) except	11-18	39-51
Atlanta (none)	11-32	39-401
Sig Sec, GENDEP (5)	11-37	44-12
Sig Dep (12) except	11-38	57

NG: State AG (3); units—same as Active Army except allowance is one copy for each unit.

USAR: None.

For explanation of abbreviations used, see AR 320-50.

