

D 101.11 =
11-381

DEPARTMENT OF THE ARMY
TECHNICAL MANUAL

DEPARTMENT OF THE AIR
FORCE TECHNICAL ORDER

TM 11-381
TO 31W1-2-101

CABLE ASSEMBLY
CX-1065/G
TELEPHONE CABLE
ASSEMBLIES
CX-1606/G AND
CX-1512/U, AND
TELEPHONE
LOADING COIL
ASSEMBLY
CU-260/G

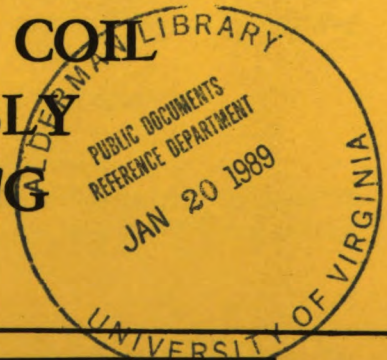

This copy is a reprint which includes current pages from Changes 4, 6 and 7.

DEPARTMENTS OF THE ARMY AND THE AIR FORCE
SEPTEMBER 1955





CHANGE)
No. 7)

HEADQUARTERS
DEPARTMENT OF THE ARMY
WASHINGTON, D.C., 12 December 1973

**CABLE ASSEMBLY CX-1065/G, TELEPHONE CABLE
ASSEMBLIES CX-1606/G AND CX-1512/U,
TELEPHONE LOADING COIL ASSEMBLY CJ-260/G,
ELECTRICAL CONNECTOR PLUGS U-176/G AND
U-226/G, AND MAINTENANCE KIT,
CABLE SPLICING MK-640/G**

TM 11-381, 20 September 1955, is changed as follows:

Page 3, paragraph 1.1. Delete paragraph 1.1 and substitute:

1.1. Indexes of Publications

a. *DA Pam 310-4*. Refer to the latest issue of *DA Pam 310-4* to determine whether there are new editions, changes, or additional publications pertaining to the equipment.

b. *DA Pam 310-7*. Refer to *DA Pam 310-7* to determine whether there are modification work orders (MWO's) pertaining to the equipment.

Paragraph 2. Delete paragraph 2 and substitute:

2. Maintenance Forms and Records

Maintenance forms, records, and reports which are to be used by maintenance personnel at all maintenance levels are listed in and prescribed by TM 38-750.

2.1. Reporting of Errors

The reporting of errors, omissions, and recommendations for improving this publication by the individual user is encouraged. Reports should be submitted on DA Form 2028, Recommended Changes to Publications, and forwarded direct to Commander, US Army Electronics Command, ATTN: AMSEL-MA-C Fort Monmouth, NJ 07703.

Page 121, appendix II. Delete appendix II in its entirety.

By Order of the Secretary of the Army:

CREIGHTON W. ABRAMS
General, United States Army
Chief of Staff

Official:

VERNE L. BOWERS
Major General, United States Army
The Adjutant General

Distribution:

Active Army:

USASA (2)
CNGB (1)
ACSC-E (2)
Dir of Trans (1)
COE (1)
TSG (1)
USAARENBD (1)
USAMB (10)
AMC (1)
Armies (2)
Corps (2)
HISA (ECOM) (2)
TRADOC (2)
ARADCOM (2)
ARADCOM Rgn (2)
OS Maj Comd (4)
LOGCOMDS (3)
MICOM (2)
TECOM (2)
USACC (4)
MDW (1)
Svc Colleges (1)
USASESS (10)
USAADS (2)
USAFAS (2)
USAARMS (2)
USAIS (2)
USAES (2)
USAINTS (2)
WRAMC (1)
USACDCEC (10)
ATS (1)
USA Dep (2)
Sig Sec USA Dep (2)
Sig Dep (2)
SIG FLDMS (1)

USAERDAA (1)
USAERDAW (1)
MAAG (1)
USARMIS (1)
Instl (2) except
Fort Gordon (10)
Fort Huachuca (10)
WSMR (1)
Fort Carson (5)
Ft Richardson (ECOM
Ofc) (2)
Army Dep (2) except
LEAD (14)
SAAD (30)
TOAD (14)
ATAD (10)
Units org under fol TOE:
(1 copy each unit)
7
11-16
11-27
11-35
11-36
11-38
11-39
11-45
11-55
11-56
11-57
11-85
11-87
11-97
11-117
11-155
11-157
11-158
11-215

11-218
11-302
11-500(AA-AC)
17

29-134
29-136
37
57

NG: State AG (3).

USAR: None.

For explanation of abbreviations used, see AR 310-50

CABLE ASSEMBLY CX-1065/G, TELEPHONE CABLE ASSEMBLIES CX-1606/G AND CX-1512/U, TELEPHONE LOADING COIL ASSEMBLY CU-260/G, ELECTRICAL CONNECTOR PLUGS U-176/G AND U-226/G, AND MAINTENANCE KIT, CABLE SPLICING MK-640/G

CHANGE }
No. 6 }

HEADQUARTERS
DEPARTMENT OF THE ARMY
WASHINGTON, D.C., 18 November 1964

TM 11-381, 20 September 1955, is changed as follows:
The title of the manual is changed as shown above.

Note. The parenthetical references to previous changes (example: page 2 of C 4) indicate that pertinent material was published in that change.

Page 3, paragraph 1 (as changed by C5, 7 Oct 63).

Delete paragraph 1 and substitute:

1. Scope

a. This manual describes cable assembly CX-1065/G, telephone cable assemblies CX-1606/G and CX-1512/G, telephone loading coil assembly CU-260/G, electrical connector plug U-176/G, electrical connector plug U-226/G, and maintenance kit, cable splicing MK-640/G and covers the construction methods, testing procedures, and repair procedures for spiral-four and spiral-five cable lines using this equipment. It also includes instructions for performing preventive and periodic maintenance services and repair functions to be accomplished by the organizational repairman. No maintenance is performed by the operator.

b. Basic nomenclature followed by () is used to indicate all models of the equipment item described in this manual.

Delete paragraph 1.1 (as added by C 5, 7 Oct 63) and substitute:

* This change supersedes C 1, 15 November 1956; C 2, 1 December 1958; and C 5, 7 October 1963.

1.1. Index of Publications

Refer to the latest issue of DA Pam 310-4 to determine whether there are new editions, changes, or additional publications pertaining to the equipment. DA Pam 310-4 is an index of current technical manuals, technical bulletins, supply manuals (types 4, 6, 7, 8, and 9), supply bulletins, lubrication orders, and modification work orders available through publications supply channels. The index lists the individual parts (-10, -20, -35P, etc) and the latest changes to and revisions of each equipment publication.

Delete paragraph 2 (as changed by C 5, 7 Oct 63) and substitute:

2. Forms and Records

a. Reports of Maintenance and Unsatisfactory Equipment. Use equipment forms and records in accordance with instructions in TM 38-750.

b. Report of Damaged or Improper Shipment. Fill out and forward DD Form 6 (Report of Damaged or Improper Shipment) as prescribed in AR 700-58 (Army), NAVSANDA Publication 378 (Navy), and AFR 71-4 (Air Force).

c. Reporting of Equipment Manual Improvements. The direct reporting by the individual user, of errors, omissions, and recommendations for improving this equipment manual is authorized and encouraged. DA Form 2028 (Recommended changes to DA Publications), will be used for reporting these improvements. This form will be completed in triplicate using pencil, pen, or typewriter. The original and one copy will be forwarded direct to Commanding General, U. S. Army Electronics Command, ATTN: AMSEL-MR-MOC, Fort Monmouth, N. J. 07703. One information copy will be furnished to the individual's immediate supervisor (e.g., officer, noncommissioned officer, supervisor, etc).

Page 8, paragraph 6b (as changed by C 2, 1 December 1958). Delete the third and fourth sentences and substitute: When two connectors are coupled, the male contacts spread the split female contacts. The rubber compound, in compression, exerts a force on the female contacts, which in turn, results in low and stable contact resistance between male and female contacts of the mating connectors.

Page 9. Add paragraph 6.1 and figure 5.1 (as added by C 2, 1 Dec 58) after paragraph 6:

6.1. Description of Electrical Connector Plug U-176/G (fig. 5.1)

Electrical Connector Plug U-176/G is similar to the universal connector (para. 6) with the following exceptions:

a. The end cap is made of high impact nylon and has segments similar to those on the connector to enable it to be tightened into the coupler assembly.

b. A black aluminum seal nut and jacket cover the cable grip and the end of the cable.

c. A short black stainless steel retaining cable attaches the end cap to the seal nut. The cable rotates freely around the seal nut and end cap to enable the end cap to be handled easily.

d. The coupler assembly is made of rubber and is spring-loaded to keep it over the segments.

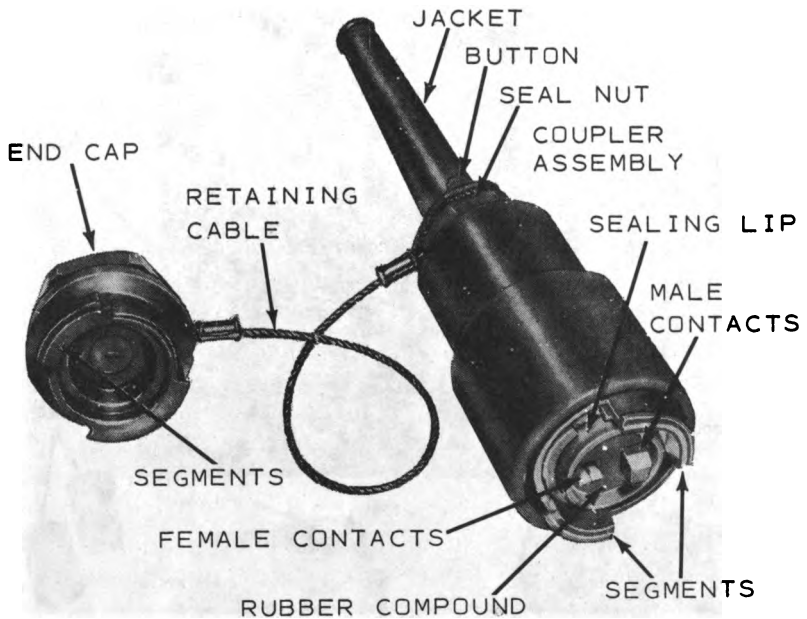

TM 381-C2-1

Figure 5.1. (Added) Electrical connector plug U-176/G.

Add paragraph 6.2 and figure 5.2 after figure 5.1.

6.2. Description of Electrical Connector Plug U-226/G (fig. 5.2)

Electrical connector plug U-226/G is a 12-inch, five-pair connector used by direct support and general support maintenance

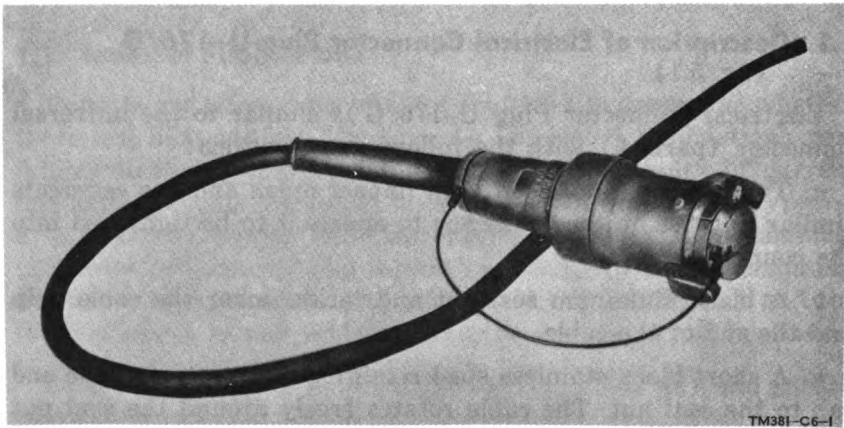

Figure 5.2. Electrical Connector Plug U-226/G.

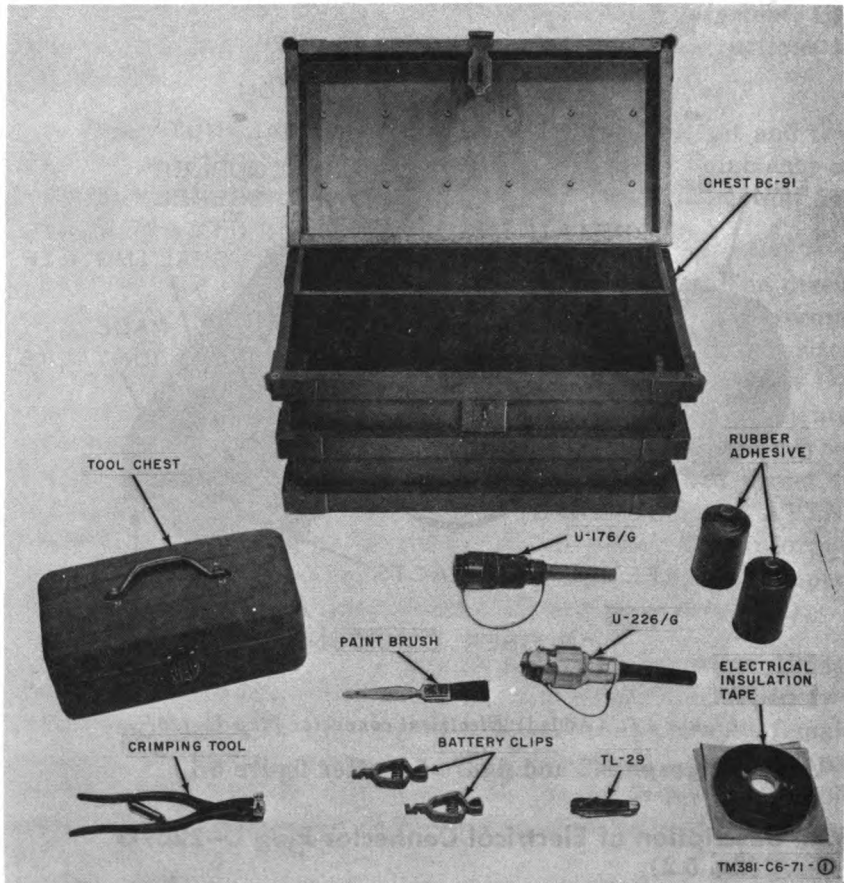

Figure 10.1. (Added) Maintenance Kit, Cable Splicing MK-640/G.

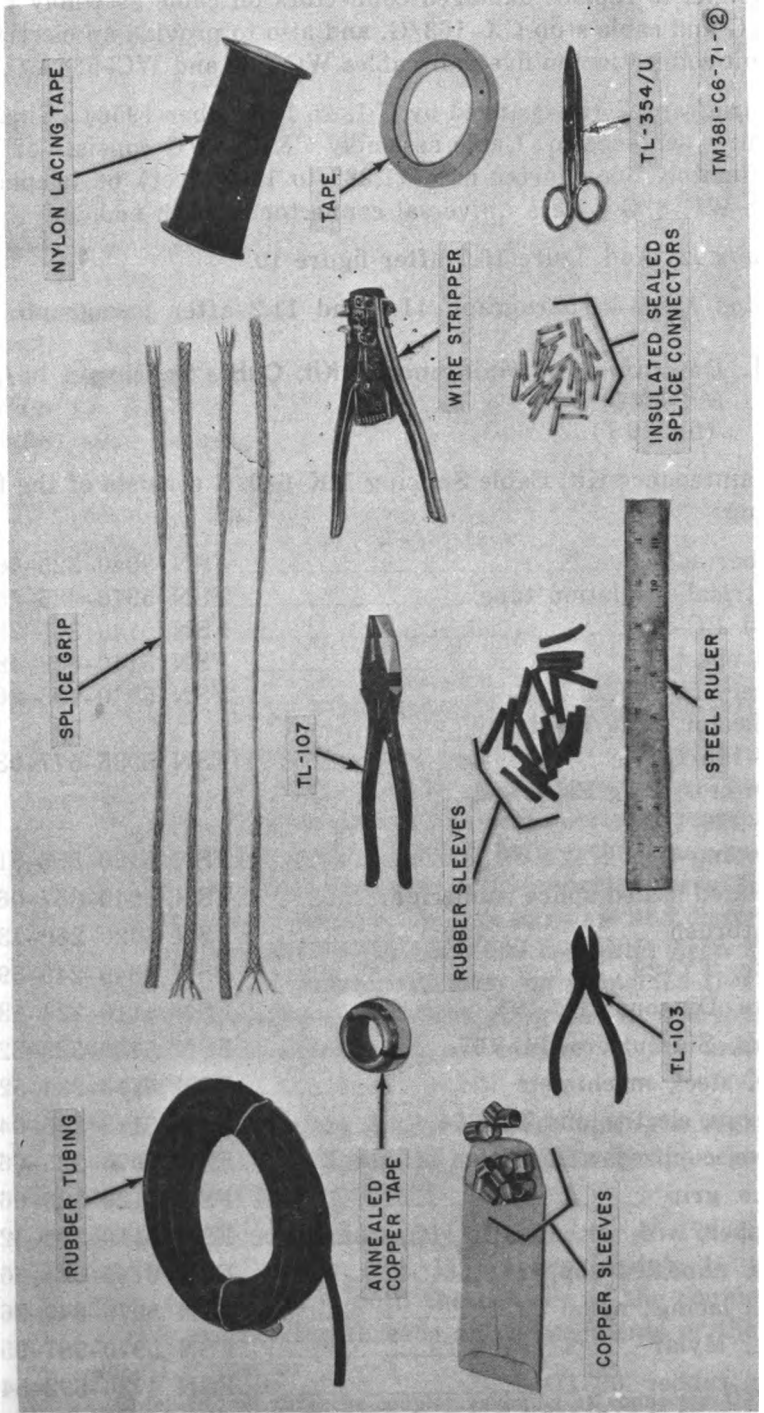

Figure 10.1.—Continued.

personnel to replace damaged connectors on cable assembly CX-162/G and cable stub CX-163/G, and also to provide an electrical circuit connection on five-pair cables WC-534 and WC-534A.

Paragraph 7 (as changed by C 1, 15 November 1956). Change the first sentence to: Cable assembly CX-1065/G consists of approximately one-quarter mile (1,280 to 1,360 feet) of telephone cable WF-8/G with a universal connector at each end.

Page 13. Add figure 10.1 after figure 10.

Page 14. Add paragraph 11.1 and 11.2 after paragraph 11:

**11.1. Description of Maintenance Kit, Cable Splicing
MK-640/G
(fig. 10.1)**

Maintenance Kit, Cable Splicing MK-640/G consists of the following:

Rubber adhesive	FSN 8040-325-6600
Electrical insulation tape	FSN 5970-325-6591
Chest BC-91	FSN 5140-315-2671
Tool chest	FSN 5140-678-4805
Battery clips	FSN 5940-195-9676
Connector, Plug Electrical U-176/G.	FSN 5935-577-0302
Connector, Plug Electrical U-226/G.	
Crimping tool	FSN 5120-856-8180
Insulated sealed splice connector	FSN 5940-857-0667
Paintbrush	FSN 8020-260-1306
Knife, TY-29	FSN 7340-240-5943
Pliers, Diagonal TL-103	FSN 5110-224-1896
Pliers, Sidecutters TL-107	FSN 5120-329-3251
Rule, steel, machinists	FSN 5210-234-5224
Scissors, electricians TL-354	FSN 5110-255-0420
Sleeve, copper	FSN 5975-325-6619
Splice grip	FSN 5120-325-6641
Stripper, wire	FSN 5110-268-4220
Tape, annealed copper	FSN 6145-325-6584
Tape, lacing; nylon	FSN 5975-340-2697
Tape, Mylar	FSN 5970-987-9550
Tube, rubber .0931D	FSN 4720-892-5416
Tube, rubber .1251D	FSN 4720-892-5415

11.2. Description of Connector Repair Toolkit (fig. 10.2)

The Connector Repair Toolkit consists of the following:

Tool chest	FSN 5140-630-6152
Crimping tool	FSN 5120-625-7920
Stretching tool	FSN 5120-625-9293
Caps (bullet shape)	FSN 6145-625-9320
Combination wrench (open-end and spanner)	FSN 5120-621-2020
Silicone grease	FSN 5970-621-0139
Spanner wrench	FSN 5120-621-2021

Add figure 10.2 after paragraph 11.2.

Page 15. Add paragraphs 14.1 and 14.2 (as added by C 2, 1 Dec 58) after paragraph 14:

14.1. Procedure for Joining and Disconnecting Electrical Connector Plug U-176/G to Universal Connector

a. Joining Connectors.

- (1) Remove the end caps from the connectors.
- (2) Grasp the universal connector (fig. 5) in your left hand (palm down) with the polarizing button facing upward.
- (3) Grasp connector U-176/G (fig. 5.1) in your right hand (palm down) with the polarizing button facing upward.

Caution: Do not rotate the rubber-covered coupler assembly on connector U-176/G before the brass coupler on the universal connector is disconnected, because the two connectors will jam. Be sure to rotate and disconnect the brass coupler on the universal connector first. If the rubber-covered coupler assembly on connector U-176/G is unintentionally turned first, retighten it, and then rotate and disconnect the brass coupler on the universal connector.

- (4) Push the connectors firmly together until the segments on one connector fit into the spaces between the segments on the other connector.
- (5) Rotate the coupler assembly of connector U-176/G in a clockwise direction (fig. 11), approximately $\frac{1}{4}$ to $\frac{1}{2}$ turn (45° to 90°), until the threads of the coupler assembly engage the threads on the segments of the universal connector.

Note. Do not turn the coupler assembly of connector U-176/G more than $\frac{1}{2}$ turn.

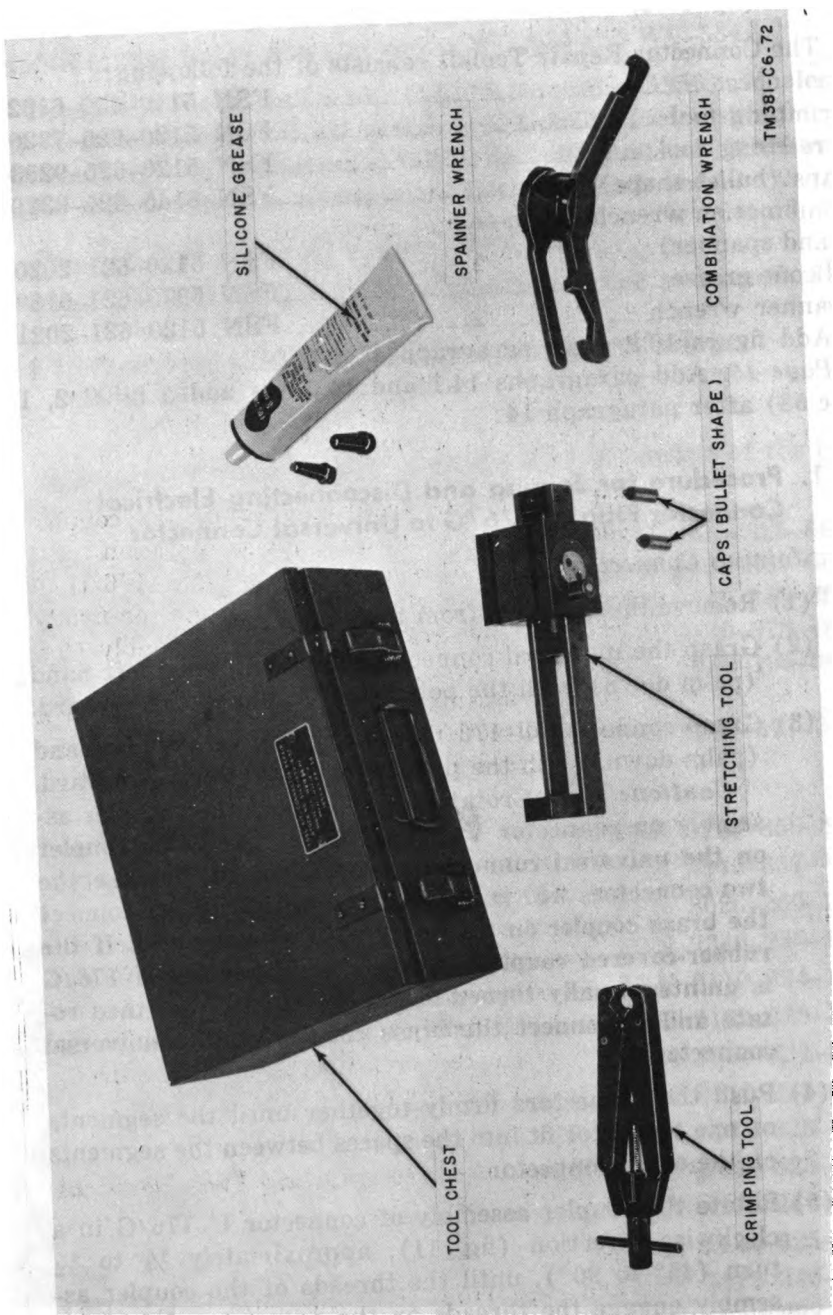

Figure 10.2. Connector repair toolkit.

- (6) Rotate the universal connector in a counterclockwise direction, holding connector U-176/G with your fingers wrapped around both the coupler assembly and the seal nut to prevent both from turning. Rotate until the universal connector is tight.
- (7) Rotate both connectors in the directions given in (5) and (6) above until a tight fit is obtained.
- (8) Insert the end cap of connector U-176/G into the end cap of the universal connector. Rotate the end caps until a snug fit is obtained.

b. Disconnecting Connectors.

- (1) Grasp connector U-176/G with your right hand so that the seal nut is held by your fingers, and the coupler assembly is held with your index finger and thumb.
- (2) Grasp the coupler of the universal connector with your left hand.
- (3) Hold connector U-176/G firmly and rotate the coupler of the universal connector in a clockwise direction until it disconnects from the threads on connector U-176/G.
- (4) Hold the boot (fig. 5) of the universal connector firmly with your left hand and grasp the coupler assembly (fig. 5.1) of connector U-176/G with your right hand.
- (5) Rotate the coupler assembly of connector U-176/G in a counterclockwise direction until it disconnects from the threads on the universal connector and the connectors come apart.
- (6) Place the end cap of the universal connector over the open end of the coupler and rotate until the end cap is firmly held on the coupler.
- (7) Place the end cap of connector U-176/G into the open end of the coupler assembly, sliding the segments on the end cap into the spaces between the segments of the connector. Hold the end cap firmly and rotate the coupler assembly in a clockwise direction until the end cap is firmly held inside the coupler assembly.

14.2. Procedure for Joining and Disconnecting Two Electrical Connector Plugs U-176/G

a. Joining Connectors.

- (1) Remove the end caps from the connectors by rotating the coupler assembly (held in your right hand) in a counterclockwise direction, while holding the end cap firmly with the left hand.

- (2) Hold one connector with your left hand around the jacket, palm down. The polarizing button should face upward.
- (3) With your right hand, rotate the coupler assembly while applying a slight pressure toward the seal nut until the coupler assembly slips over the seal nut, exposing the segments.
- (4) Hold the coupler assembly in this position ((3) above) by sliding your left hand over the jacket until your index finger and thumb are around the coupler assembly.
- (5) Grasp the other connector in your right hand, with the polarizing button facing upward, and push the two connectors together until the segments of one connector fit into the spaces between the segments on the other connector.
- (6) Rotate the coupler assembly of the right-hand connector in a clockwise direction until the threads in the coupler assembly engage the threads on the segments of the other connector. Continue rotating the coupler assembly until a tight connection is made.
- (7) Release the left-hand coupler assembly and allow it to slide against the right-hand coupler assembly.

b. Disconnecting Connectors.

- (1) Grasp the coupler assembly of one connector in your left hand (palm down) and the coupler assembly of the other connector in your right hand (palm down).
- (2) Rotate the left-hand coupler assembly in a clockwise direction and the right-hand coupler assembly in a counterclockwise direction until the coupler assembly disengages from the segments.
- (3) Pull the connectors apart.
- (4) Place the end cap of each connector into the open end of the coupler assembly, sliding the segments on the end cap into the spaces between the segments of the connector. Hold the end cap firmly and rotate the coupler assembly in a clockwise direction until the end cap is firmly held by the coupler assembly.

Page 25, paragraph 31. Delete the first sentence and substitute: Use the standard construction team signals described in TM 11-2262.

Page 28, paragraph 36. Delete the second sentence and substitute: In either case, the methods are much the same as those used for field wire (FM 24-40).

Page 32, paragraph 39d(3). Delete the last sentence.

Page 33, paragraph 40c. Add the following (as added by C 1, 15 November 1956) at the end of subparagraph *c*: Leave a small amount of slack between the cable clamps.

Page 35, paragraph 42b(1). Delete the last sentence and substitute: For additional information on the use of metal poles, refer to TB SIG 268.

Page 36, paragraph 42b(5), lines 2 and 3. Delete "or TM 11-2263."

Page 42, paragraph 44b. Delete the last sentence and substitute: For complete information on the LC-61, refer to TM 11-370.

Page 55. Delete paragraph 66d.

Page 67, paragraph 75b, line 3. Delete "TM 11-2263" and substitute: TM 11-2262.

Page 77. Delete paragraph 82 (as changed by C 5, 7 Oct 63) and substitute:

82. Scope of Organizational Maintenance

a. This section contains instructions covering organizational maintenance of the equipment. It includes instructions for performing preventive and periodic maintenance services and repair functions to be accomplished by the organizational repairman.

b. Organizational maintenance of the equipment includes:

- (1) Weekly preventive maintenance checks and services charts (paras. 86-87.2).
- (2) Touchup painting instructions (para. 87.3).
- (3) Repair of cable (paras. 88-93).

Add paragraph 82.1 after paragraph 82:

82.1. Organizational Preventive Maintenance

a. Preventive maintenance is the systematic care, inspection, and servicing of equipment to maintain it in serviceable condition, prevent breakdowns, and assure maximum operational capability. Preventive maintenance is the responsibility of all categories of maintenance concerned with the equipment, and includes the inspection, testing, and repair or replacement of parts, subassemblies, or units that inspection and tests indicate would probably fail before the next scheduled periodic service. Preventive maintenance checks and services of the equipment at the organizational maintenance level are made at weekly intervals unless otherwise specified by the commanding officer.

b. Maintenance forms and records to be used and maintained for this equipment are specified in TM 38-750.

Add paragraph 83 (as added by C 5, 7 Oct 63) after paragraph 82.1:

83. Tools, Test Equipment, and Materials Required

a. The tools and test equipment required for organizational maintenance of the equipment are listed in appendix II.

b. The materials required are as follows:

- (1) Cable Hanger PF-203/G.
- (2) Clamp Electrical Conductor, Strain PF-211/G.
- (3) Hook PF-81/G.
- (4) Wire WD-1/TT.
- (5) Insulation Tape, Electrical TL-600/U for use in arctic climate).
- (6) Insulation Tape, Electrical TL-636/U (for use in temperate climate).
- (7) Friction Tape TL-83.
- (8) Splicing sleeve, bronze.
- (9) Sleeve Compressing Tool TL-190.

Page 78, paragraph 84 (as changed by C 5, 7 Oct 63). Subparagraph b. Delete the last sentence.

Add subparagraphs c and d after the note.

c. Repair all minor cable damages (para. 92). Test all repaired cables (para. 110 and 111) before restoring them to service.

d. Replace cables that require splices or connector repairs. Delete subparagraph e.

Delete the heading of Section II (as changed by C 5, 7 Oct 63).

Delete paragraph 85 (as changed by C 5, 7 Oct 63) and substitute:

85. Preventive Maintenance Checks and Services Periods

Preventive maintenance checks and services of the equipment are required weekly. Paragraphs 86, 87, 87.1, and 87.2 specify the checks and services that must be accomplished weekly or under the conditions listed below.

a. When the equipment is initially installed.

b. When the equipment is reinstalled after removal for any reason.

c. When the equipment is placed in storage.

Page 79. Delete paragraphs 86 and 87 (as changed by C 5, 7 Oct 63) and substitute:

86. Weekly Preventive Maintenance Checks and Services Chart for Surface Cable Lines

Note. Spiral-four cable laid on the ground requires particular attention because it is subject to more types of damage than buried or aerial cable.

Sequence No.	Item	Procedure	References
1	Cable-----	Inspect the entire length of the cable carefully, especially at sharp curves or turns in the route and at points where the cable appears to be stressed. Be on the alert for stone bruises, abrasions, cuts, and sections that may have been crushed by vehicles, animals, ground troops, or shell fire.	Para 84.
2	Anchorage--	Inspect all anchorages. Be sure that they are secure and that the connections to them are in good condition. Replace all anchorages or connections that appear to be weak. Inspect the cable insulation at all anchorages.	Para 63i.
3	Connectors---	Check all connector locations carefully. Be sure that all connectors are tight. If loading coils are used, be sure that they are in place and appear in good condition. Replace all damaged loading coils.	Figs. 11 and 12 and Para 84.

87. Weekly Preventive Maintenance Checks and Services Chart for Buried Cable Lines

Note. Buried cable is relatively safe from damage but it is difficult to inspect. The principal evidence of possible damage is a disturbance of the ground surface over the cable.

Sequence No.	Item	Procedure	References
1	Cable path---	Carefully check the path of the entire length of cable. If the ground surface over the cable appears broken to a significant depth, carefully dig away the earth. Inspect the cable for damage.	Para 84.
2	Exposure----	Carefully inspect cables which have been exposed by washouts or other ground disturbances for damage. Rebury undamaged cables.	Para 84.

Page 80. Add paragraphs 87.1 and 87.2 (as added by C 5, 7 Oct 63) and 87.3 after paragraph 87:

87.1. Weekly Preventive Maintenance Checks and Services for Aerial Cable Lines

Sequence No.	Item	Procedure	References
1	Cable support	Observe the condition of all structures used to support the cable. Check all supporting ties, guys, and messenger strands for signs of weakness. Check poles and trees (supporting cable) for rotting and similar defects. Replace any defective item, if possible; otherwise make a note of the trouble and report it to the delegated supervisor.	
2	Cable-----	Examine the cable under the cable clamp or basket hitch to see if the cable is damaged. Repair all abrasions on the cable jacket.	Para 92.
3	Connectors---	Check all tension bridges at locations where connectors are placed in the span. Be sure that the cable is not being bent sharply.	Para 66.
4	Ground clearance.	Check to see that the ground clearances are adequate. Make the construction changes necessary to obtain the required clearance, if possible; otherwise report the problem to the delegated supervisor.	

87.2. Preventive Maintenance Checks and Services Chart for Cables Placed in Storage

Note. The following procedures must be accomplished when a cable is placed in or removed from storage.

Sequence No.	Item	Procedure	References
1	Continuity---	Make a continuity test. All discrepancies must be referred to higher level maintenance personnel.	
2	Connectors---	Check the connectors for damaged contact surfaces and cracked or broken bodies.	

87.3. Touchup Painting Instructions

Remove rust and corrosion from metal surfaces by lightly sanding them with fine sandpaper. Brush two thin coats of paint

on the bare metal to protect it from further corrosion. Refer to the applicable cleaning and refinishing practices specified in TM 9-213.

Section III, heading. Delete FIELD.

Paragraph 88a (as changed by C 1, 15 Nov 56).

Line 6. Delete "temporary field."

Line 11. Change "one splice" to three splices. Delete "or depot."

Delete paragraph 89 (as changed by C 1, 15 Nov 56).

Page 82. Delete figure 32.

Page 83. Delete paragraph 90 (as changed by C 1, 15 Nov 56).

Page 84. Delete figure 33.

Page 86. Delete paragraph 91 and figures 35 and 36.

Page 87, paragraph 93a. Delete "Use the splicing procedures described in paragraphs 89 and 90."

Page 88, paragraph 94. Delete the last sentence and substitute: refer to FM 24-20 for additional testing information.

Paragraph 95. Subparagraph a. Delete the last sentence and substitute: refer to TM 11-2057A for additional information.

Subparagraph b. Delete the last sentence and substitute: refer to TM 11-2017 for additional information.

Subparagraph d, last two lines. Delete (FM 24-5).

Page 89, paragraph 95. Subparagraph e. Delete the last sentence and substitute: refer to TM 11-2019 for additional information.

Subparagraph f. Delete the last sentence and substitute: Refer to TM 11-2050 for additional information.

Paragraph 97a. Delete the second sentence.

Page 90, paragraph 98a(3), line 2. After "CX-1065/G" add: and 15 ohms for Telephone Cable Assembly CX-1606/G.

Page 96, paragraph 100a (as changed by C 1, 15 Nov 56).

Line 1. Change L1 to L2. Change L2 to L1.

Line 2. Change L2 to L1.

Page 104, paragraph 113b (as changed by C 1, 15 Nov 56).

Lines 1 and 2. Change one splice to three splices (including the replacement of connectors).

Line 3. Change one splice to three splices.

Line 13. Change one splice to three splices (including the replacement of connectors).

Delete the last sentence.

Page 105, paragraph 115b, last line. Delete (par. 118).

Page 106, paragraph 115. Subparagraph c, line 2. Delete (par. 118).

Subparagraph e, heading. Change "Field" to Temporary.

Line 1. Change "field" to temporary.

Line 2. Delete (par. 118).

Paragraph 116c, line 2. Delete "using the procedures given in paragraph 118."

Page 107. Delete paragraphs 118 and 118.1 (as changed by C 1, 15 Nov 56).

Page 108. Delete figure 45.

Page 109. Delete paragraph 119.

Page 110. Delete figures 46 and 47 (as changed by C 1, 15 Nov 56).

Chapter 6.1 (as changed by C 2, 1 Dec 58).

Heading. After U-176/G add AND ELECTRICAL CONNECTOR PLUG U-226/U.

Delete paragraph 119.1 and figure 48 (as added by C 2, 1 Dec 58) and substitute:

119.1. Special Tools and Materials Required (fig. 48)

The tools and materials listed below are required in addition to Maintenance Kit, Cable Splicing MK-640/G and the connector repair toolkit.

a. Insertion tool.

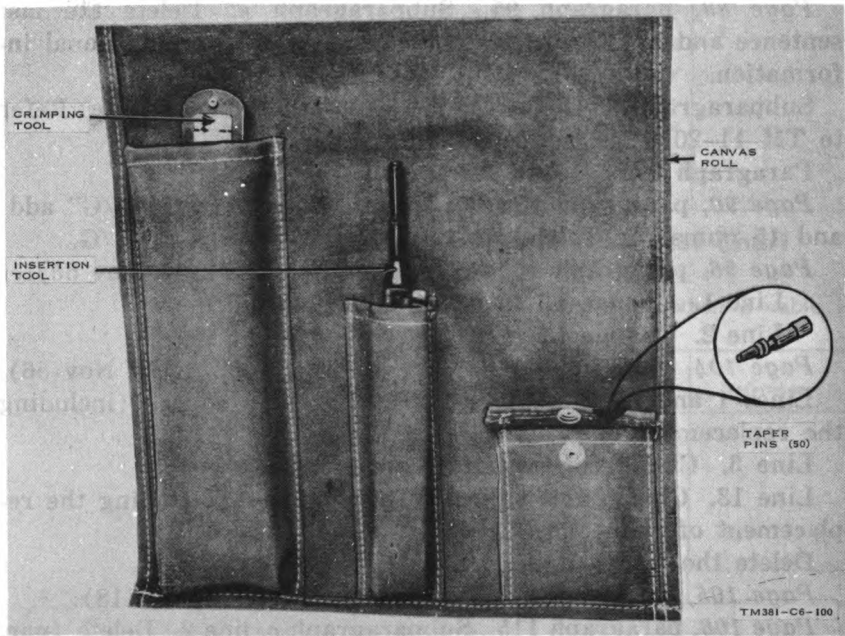

Figure 48. Special tools and materials.

b. Crimping tool.

c. Taper pins (50).

Delete figure 49 (as added by C 2, 1 Dec 58).

Add paragraphs 119.2 through 119.5 and figures 50, 51, and 52 (as added by C 2, 1 Dec 58) after paragraph 119.1.

119.2. Preliminary Preparation of Cable

a. Cut the end of the cable square.

Caution: Handle the sharp ends of the steel cable braid wires carefully to avoid injury to the hands.

b. Slide the bullet shape cap (fig. 10.2) over the squared end of the cable to prevent parts from snagging on the sharp ends of the steel cable braid wires.

c. Apply a thin film of silicone grease to a short length of the cable (5 or 6 inches) starting from the squared end, so that the parts of connector U-176/G can be pushed onto the cable more easily.

119.3. Disassembly and Placement of U-176/G on Cable (fig. 50)

The U-176/G is packed loosely assembled and can easily be disassembled. The connector parts are positioned on the cable as shown in figure 50. Slide all parts about 3 feet back on the cable to allow room for preparing the cable end.

a. Hold the end cap (17) firmly with your left hand and turn the coupler assembly (4) counterclockwise with your right hand, pulling outward to remove the end cap.

b. Hold the coupler assembly firmly with your left hand, and the seal nut (2) with your right hand. Turn the coupler assembly counterclockwise while applying a slight inward pressure toward the seal nut. This allows the steel balls inside the coupler assembly to enter the grooves on the housing (12), and thus prevents the housing from turning. Hold pressure on the coupler assembly and unscrew the seal nut; use the large open end of the combination wrench if necessary.

c. Remove the seal nut from the housing, and the jacket (6) and lockwasher (5) from the seal nut.

Note: Do not remove the lockwasher from the jacket if it remains on the jacket during disassembly.

d. Remove the spring (3) and housing from the coupler assembly.

e. Slide the seal nut, threaded end last, onto the cable (1).

f. Slide the spring, squared end first, and the coupler assembly, small end first, onto the cable.

g. Slide the lockwasher (5) onto the cable with the teeth facing the coupler assembly.

Note. If the lockwasher remains on the jacket during disassembly, *c* above, omit this step but check to see that the teeth of the lockwasher are correctly positioned.

h. Apply a small amount of silicone grease inside the hole on the small end of the jacket and slide it onto the cable.

i. Unscrew the retaining ring (8) from the housing and remove the cable grip (9) from the retaining ring; use the small open end of the combination wrench if necessary.

j. Remove the locating washer (10) and gasket (11) from the housing.

Note. If the locating washer and gasket are tightly held in the housing, omit this step.

k. Unscrew the ring guide (16) from the housing; use the spanner part of the combination wrench if necessary.

l. Remove the contact assembly (14), lockwasher (15), and ground disk (13) from the housing.

m. Push the packet containing the eyelet terminals and the copper sleeves (7) from the housing with a pencil or wooden rod inserted into the small end of the housing.

n. Slide the two copper sleeves, flared end last, onto the cable.

o. Slide the retaining ring, hexagonal end first, onto the cable.

p. Compress the cable grip longitudinally to expand its diameter and slide it, woven end first, onto the cable.

q. Slide the locating washer, bent key facing the cable grip, and the gasket, onto the cable.

Note. If the locating washer and gasket are tightly held in the housing (*j* above), they may be slid onto the cable as one unit (*r* below), but check to see that the keys on the locating washer are correctly positioned.

r. Slide the housing, small end first, onto the cable.

s. Slide the ground disk, terminal side first, onto the cable.

t. Remove the cap from the squared end of the cable.

119.4. Preparation of Cable End (fig. 51)

Clean and dry the first 10 inches of the cable with a piece of dry, lint-free cloth.

a. Cut a circular ring through the outer jacket of the cable down to the steel cable braid, $1\frac{3}{4}$ inches from the end of the cable (A, fig. 51).

b. Slit the outer jacket from the circular cut to the end, on opposite sides of the cable.

c. Use pliers to remove the outer jacket from the cable.

d. Loosen the exposed steel cable braid wires (B, fig. 51); use a screwdriver to separate the strands. Separate the strands of braid wires into two groups, equally spaced, on each side of the cable. Each group of wires will have eight strands.

e. Twist each group to form a single stranded wire (C, fig. 51).

f. Remove the cloth tape from around the inner jacket with a twisting motion.

g. Cut the cloth tape close to the outer jacket.

h. Cut a nick around the inner jacket, $\frac{1}{4}$ inch from the end of the outer jacket (D, fig. 51). Be careful to cut only part way through the inner jacket. Flex the inner jacket and conductors until the jacket separates at the nick.

i. Make two $\frac{3}{8}$ -inch longitudinal cuts through the inner jacket on opposite sides at the end of the cable (D, fig. 51). Be sure that two conductors are on each side of the cut.

j. Grasp the inner jacket and two conductors on each side of the cut, with pliers, and pull outward. The inner jacket will peel away from the insulated conductors. Be careful as you approach the nick. Do not tear the inner jacket beyond the nick.

k. Cut the polyethylene core close to the end of the inner jacket.

l. Strip $\frac{3}{8}$ inch of insulation from the end of each conductor (E, fig. 51).

m. Slide an eyelet terminal, shoulder first, on each of the twisted braid wires until the end of the eyelet is $1\frac{1}{4}$ inches from the end of the outer jacket.

n. Crimp the eyelet terminal tightly to the twisted braid wires with the crimping tool. Cut off the excess wire from beyond the end of the eyelet (E, fig. 51).

o. Bend the twisted braid wires, at the shoulder end of the eyelet terminals, so that the eyelet is at right angles to the twisted braid wires.

119.5. Assembly and Testing Procedure (fig. 50)

During this procedure, all keys and slots must line up to assemble the connector properly.

Note. Apply a small amount of antiseize compound on all threads before making connections. Silicone grease may be used in place of antiseize compound, if necessary.

a. Assembly.

- (1) Align the slot in the ground disk (13) with the key on the contact assembly.
- (2) Insert the eyelet terminals of the twisted braid wire into the holes of the ground disk terminals and solder.

Note. The end of the eyelet terminals must be pointing outward for proper connections.

- (3) Connect and solder the four insulated conductors to the proper terminals of the contact assembly (14).

Note. Be sure that the cable pairs are connected as shown in figure 38; that is, the female contacts at one end of the cable are connected to the male contacts at the opposite end of the cable, and the male contacts at one end of the cable are connected to the female contacts at the opposite end of the cable.

- (4) Take up the slack in the conductors by looping them so that the contact assembly is held firmly against the ground disk with the key on the contact assembly seated in the slot on the ground disk.
- (5) Align the slot of the housing (12) with the key on the contact assembly. Hold the housing with your left hand and pull the cable slowly with your right hand, sliding the ground disk and contact assembly into the housing. Be sure that the key of the contact assembly engages positively with the slot in the housing.
- (6) Place the lockwasher (15), with the teeth facing outward, over the contact assembly.
- (7) Screw the ring guide (16), with the slots facing outward, into the housing. Check to see that the key on the contact assembly is properly seated in the slot in the housing.
- (8) Partially tighten the ring guide with the spanner part of the combination wrench until the contact assembly is held firmly in position. The ring guide will be tightened further after the connector is fully assembled.
- (9) Push the gasket (11) into the housing as far as possible.
Note. If the gasket and locating washer are already inside the housing (para 119.3j), omit this step and the procedure given in (10) below, but check to see that the bent key on the locating washer is correctly positioned ((10) below).
- (10) Insert the locating washer (10) into the housing with the straight key engaging the slot in the housing and the bent key facing outward.
- (11) Slide the cable grip (9) into the housing by pushing on the tips of the wires and applying a rotary motion.

Note. The bent key of the locating washer must fit into one of the slots on the head of the cable grip.

- (12) Screw the retaining ring (8) into the housing and tighten it with the small open end of the combination wrench; be sure that the slot in the housing is centered across one of the corners of the hexagonal portion of the retaining ring when fully tightened. This aligns the retaining ring so that the polarizing button on the jacket can be properly positioned.
- (13) Hold the housing loosely in your left hand and roll the cable grip back and forth against a flat hard surface, applying pressure on the cable grip with the flat of your right hand to make the cable grip fit snugly against the cable.
- (14) Slide the two sleeves (7) over the cable grip. Slide the first sleeve up the cable grip. Work all the slack out of the cable grip and place the second sleeve $\frac{1}{8}$ from the end of the cable grip (fig. 52).
- (15) Crimp the second sleeve tightly on the cable grip with the crimping tool.
- (16) Stretch the cable grip around the cable with the stretching tool (fig. 52) as follows:
 - (a) Turn the knob on the stretching tool counterclockwise until the block assembly is flush against the stop block.
 - (b) Insert the hexagonal part of the retaining ring into the slot of the holding block.
 - (c) Stretch the cable straight back and insert it between the jaws of the stretching tool. Turn the knob clockwise until the jaws are firmly gripping the cable.
 - (d) Turn the knob clockwise until the geared mechanism starts slipping.
 - (e) Position the first sleeve $2\frac{1}{4}$ inches from the end of the cable grip and crimp it tightly with the crimping tool.
 - (f) Release the tension by turning the knob counterclockwise until the cable is released.
 - (g) Remove the cable and retaining ring from the stretching tool.
- (17) Slide the jacket (6) over the cable grip.
- (18) Slide the internal hexagon of the jacket over the hexagon on the retaining ring with the jacket over the hexagon correctly positioned.

Note. The correct position of the polarizing button on the jacket is facing upward when the male contact, viewed from the front, is on the right side of the contact assembly (fig. 5.1).

- (19) Apply a thin coat of silicone grease around the outside shoulder of the jacket.
- (20) Slide the lockwasher (5) on the jacket, bringing it flush against the collar of the jacket.
Note. If the lockwasher remained on the jacket during disassembly (para 119.3c), omit this step, but see that the teeth on the lockwasher are correctly positioned (para 119.3g).
- (21) Slide the coupler assembly (4) part way over the housing, aligning the steel balls inside the coupler assembly with the grooves on the housing.
- (22) Engage the segments of the spanner wrench with those on the housing. Turn the coupler assembly clockwise until the spanner wrench is held securely against the housing.
- (23) Slide the spring (3) into the coupler assembly.
- (24) Screw the seal nut (2) onto the housing and tighten it with the large open end of the combination wrench, while holding the housing firmly with the spanner wrench.
Note. Stretch the cable and jacket straight back while tightening the seal nut to offer minimum resistance to the seal nut and to prevent the jacket from slipping around the hex of the retaining ring and thus out of alignment.
- (25) Place the spanner part of the combination wrench inside the center of the spanner wrench, engaging the lugs of the spanner part of the combination wrench with the slots of the ring guide.
- (26) Hold the spanner wrench firmly with your left hand and turn the combination wrench clockwise with your right hand until the ring guide is firmly tightened against the contact assembly to provide a watertight connection.
- (27) Remove the combination wrench from the spanner wrench.
- (28) Remove the spanner wrench by turning the coupler assembly counterclockwise with the right hand, while pulling outward on the spanner wrench with the left hand.
- (29) Test the function of the spring-loaded coupler assembly. Grasp the jacket with the left hand and push the coupler assembly toward the jacket with the right hand, twisting it slightly in a clockwise direction. Release the coupler assembly slowly.
Note. The coupler assembly must slide freely and snap back into the forward position when released.

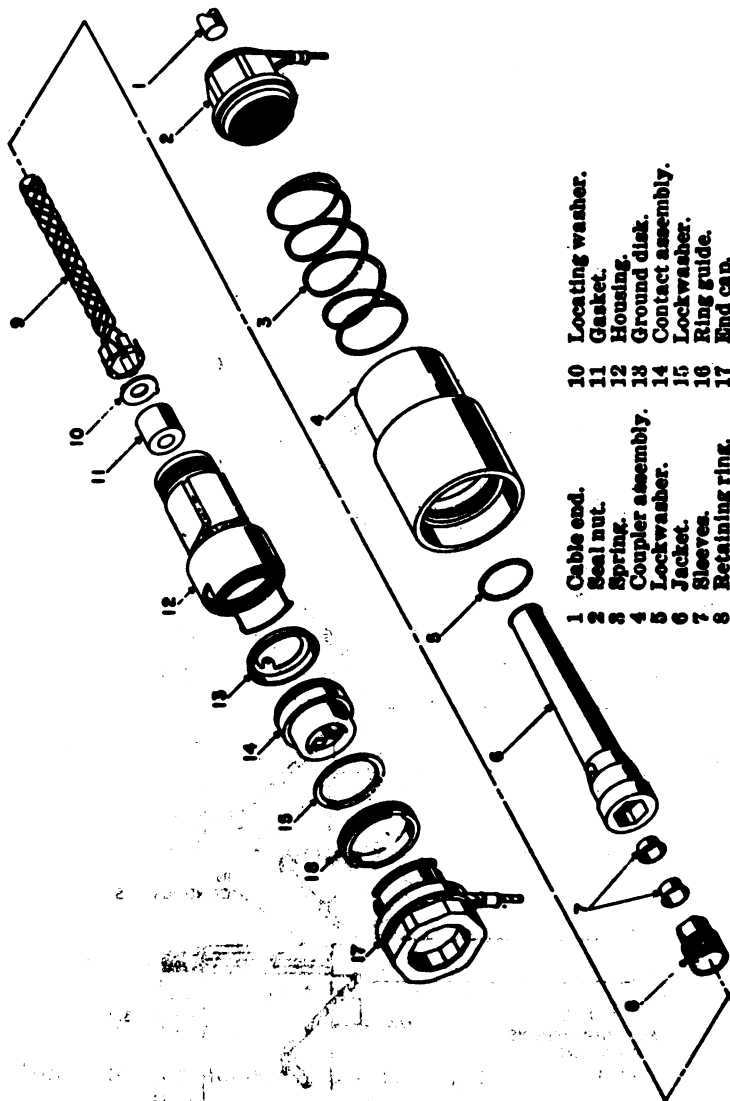

- 1 Cable end.
- 2 Seal nut.
- 3 Spring.
- 4 Coupler assembly.
- 5 Lockwasher.
- 6 Jacket.
- 7 Sleeves.
- 8 Retaining ring.
- 9 Cable grip.
- 10 Locating washer.
- 11 Gasket.
- 12 Housing.
- 13 Ground disk.
- 14 Contact assembly.
- 15 Lockwasher.
- 16 Ring guide.
- 17 End cap.

TM 361-C2-5

Figure 50. (Added) Electrical Connector Plug U-176/G, exploded view.

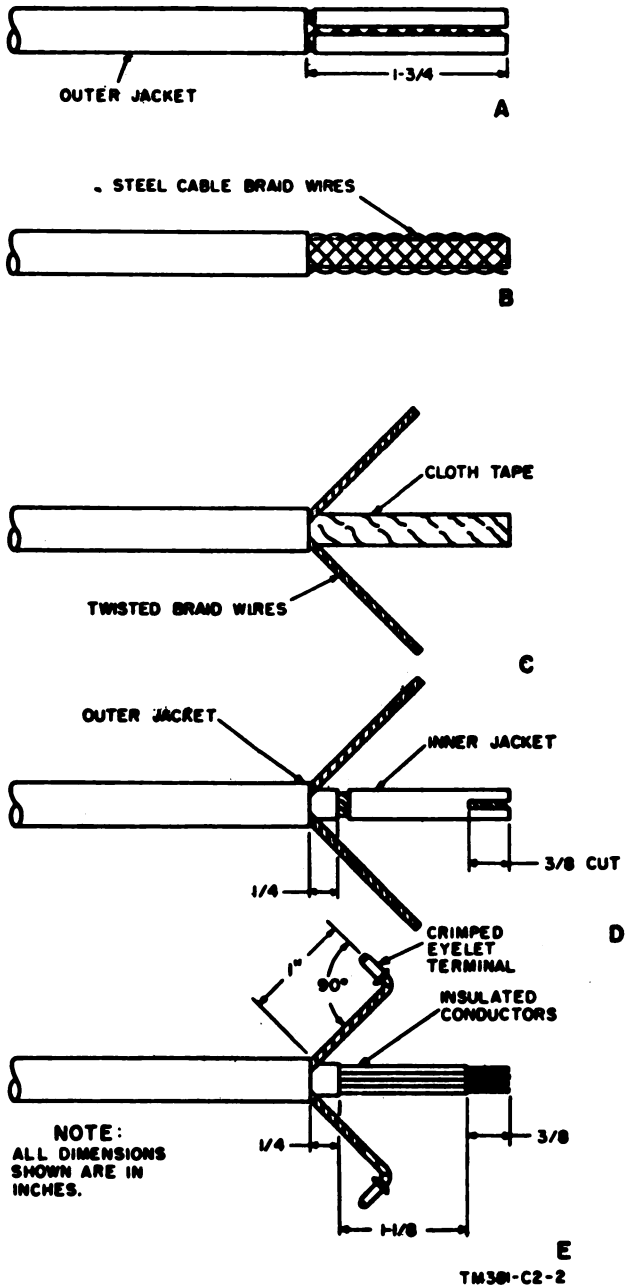

Figure 51. (Added) Preparation of cable end.

- (30) Place the end cap (17) into the front of the coupler assembly and rotate it until the segments of the end cap

fit between the segments of the housing. Hold the end cap with the right hand and the coupler assembly with the left hand, and rotate the coupler assembly counterclockwise until the end cap is tightly held by the coupler assembly. This protects the connector face from moisture, dirt, and physical damage.

b. Testing Assembly. Test the continuity of the cable assembly (para 99, 100, and 101) before returning it to service.

Add paragraphs 119.6 through 119.11 and figure 53 through 65 after figure 52.

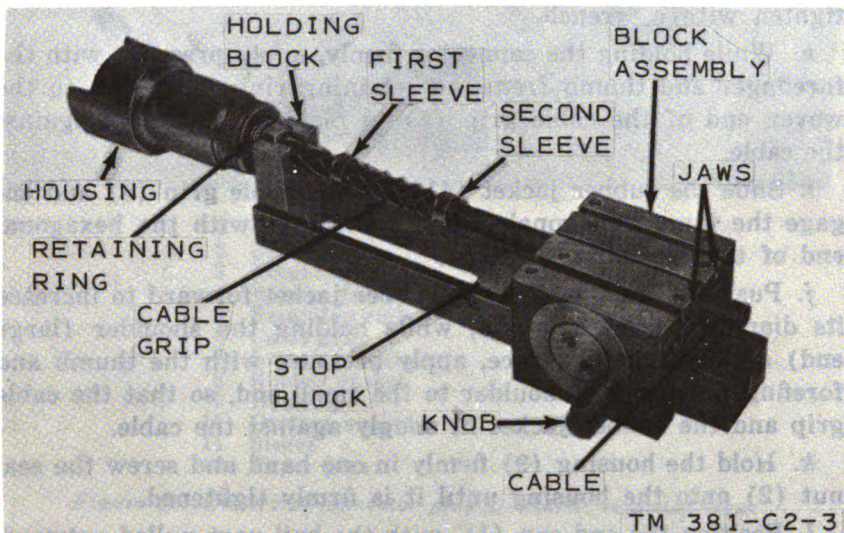

Figure 52. (Added) Use of stretching tool.

119.6. Assembly of Electrical Connector Plug U-226/G (fig. 53)

Electrical Connector Plug U-226/G is packed loosely assembled and the connector parts are positioned as shown in figure 53. Slide all parts about 2 feet back on the cable to allow room for preparing the cable.

a. Slide the contact assembly (10) into the sleeve (11), aligning the pin until it is seated in the bottom of the slot.

b. Hold the sleeve firmly with one hand and screw the housing (9) onto the sleeve with a clockwise rotation (left-hand thread). The direction of rotation is determined while looking at the front end of the connector.

Caution: Use extreme care that the sleeve does not turn; turning will cause the conductors to twist together and break.

c. Slide the rubber gasket (8) onto the housing (9) until it is firmly seated.

d. Slide the retining washer (7) into the housing (9), aligning the straight key with the groove in the housing.

e. Expand the cable grip (6) with the thumb and forefinger of one hand; slide the cable grip into the housing (9).

f. Align the bent key of the retaining ring (5) with one of the slots on the front of the cable grip (6).

g. Screw the retaining ring (5) firmly into the housing (9) and tighten with a wrench.

h. While holding the connector firmly, apply pressure with the forefinger and thumb from the retaining ring (5) down to the woven end of the cable grip (6) to make it fit snugly against the cable.

i. Slide the rubber jacket (4) onto the cable grip (6) and engage the inner hexagonal end of the jacket with the hexagonal end of the retaining ring (5).

j. Push the small end of the rubber jacket forward to increase its diameter, release it and, while holding the shoulder (large end) of the jacket in place, apply pressure with the thumb and forefinger, from the shoulder to the small end, so that the cable grip and the rubber jacket fit snugly against the cable.

k. Hold the housing (9) firmly in one hand and screw the seal nut (2) onto the housing until it is firmly tightened.

l. Position the end cap (1), with the bail part pulled outward, into the front of the housing (9).

m. Twist the bail to slide the protruding sides of the bail into the slots of the housing. Snap the bail toward the housing to lock it in place for a moistureproof and dustproof connection.

119.7. Connecting Tapered Pins to U-226/G Contact Assembly (fig. 54)

a. Inserting Tapered Pins.

(1) Place the contact assembly (10, fig. 53) male pins into the recess of the U-226/G connector cap so that it will stand firmly upright.

(2) Insert the proper conductor into the proper numbered hole in the contact assembly (b below).

Note. Seat the proper conductors in holes 5 and 10 of the contact assembly before inserting the other conductors into the holes.

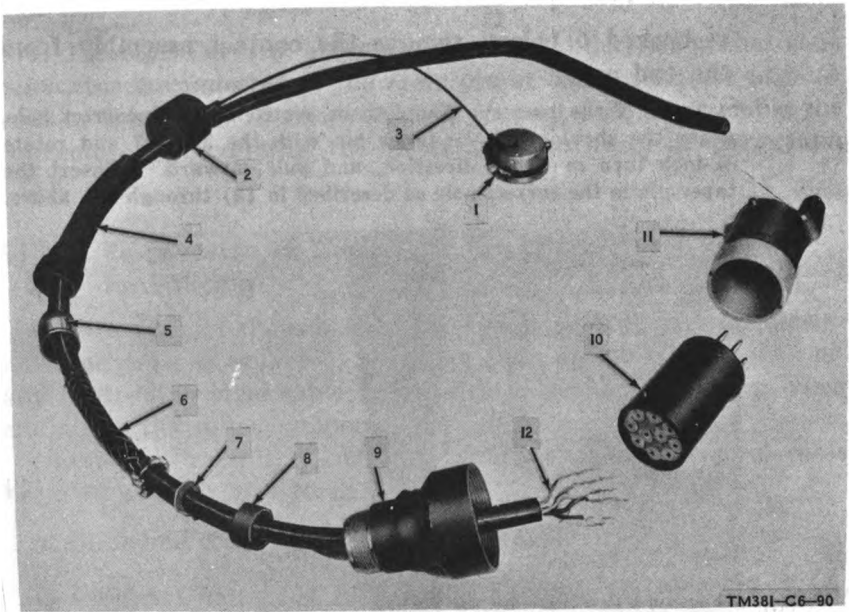

- 1 Cap
- 2 Seal nut
- 3 Retaining cable
- 4 Rubber jacket
- 5 Retaining ring
- 6 Cable grip
- 7 Locating washer
- 8 Rubber gasket
- 9 Housing
- 10 Contact assembly
- 11 Sleeve
- 12 Taper pins

Figure 53. Electrical connector plug U-226/G, exploded view.

- (3) Hold the insertion tool in the palm of one hand, with the barrel end outward and the adjusting knob upward and to the left of the slit.
- (4) Position the open part of the insertion tool barrel over and against the shoulder of the tapered pin. Turn the adjusting knob to the right with the thumb and pull back slightly to lock.
- (5) Press firmly downward against the contact assembly until the insertion tool trips.
- (6) Turn the adjusting knob to the left and remove the insertion tool from the taper pin.
- (7) Repeat the operation described in (4) through (7) above for the remaining taper pins.
- (8) After all the taper pins are seated and the pair positions

rechecked δ below, remove the contact assembly from the end cap.

Note. If the pins are found to be seated in the incorrect hole, grasp the shoulder of the taper pin with the TL-107 and rotate $\frac{1}{4}$ -inch turn in either direction, and pull outward. Reinsert the taper pin in the correct hole as described in (3) through (6) above.

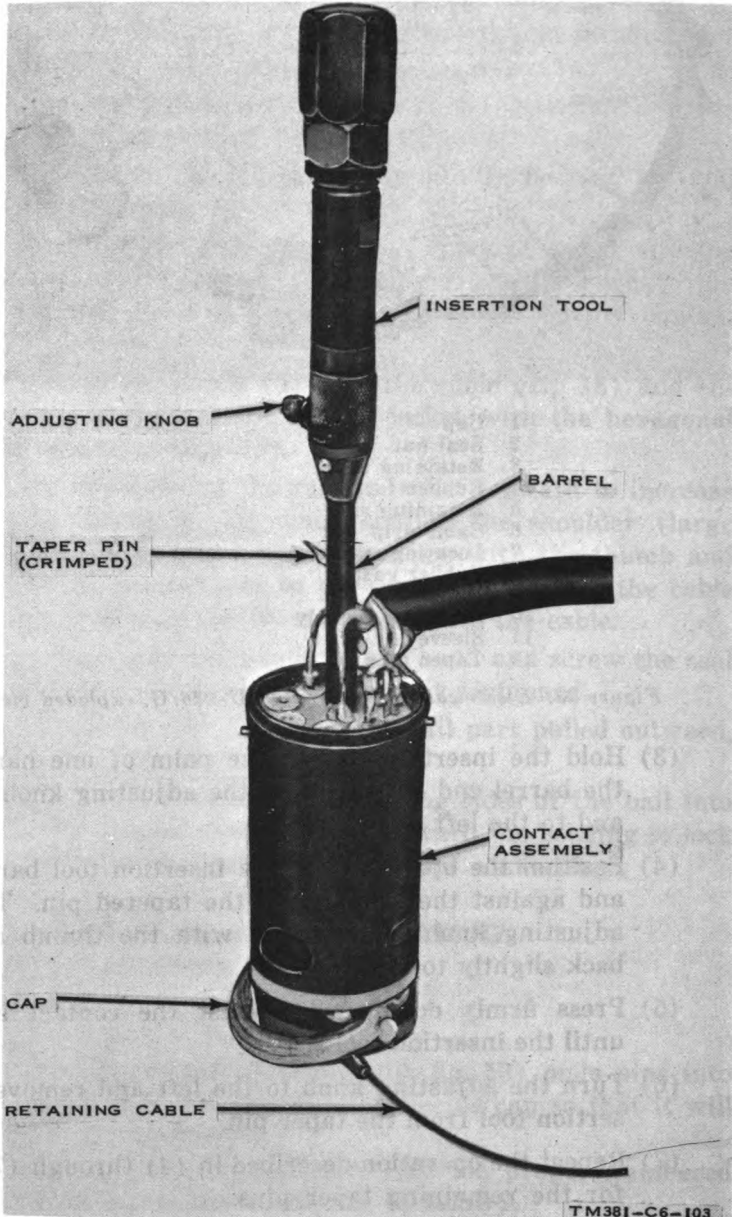

Figure 54. Use of insertion tool.

b. Testing. Perform a continuity check to determine that each conductor is connected to the *same* pin of each connector at *both* ends of the cable. If any trouble is encountered, disassemble the connector by reversing the procedures outlined in paragraph 119.6.

119.8. Preparation of Spiral-Four Telephone Cable WF-8/F for Splicing

Cut the ends of the cables that are to be spliced square. Designate one cable as cable No. 1 and the other as cable No. 2. Cut off any protruding steel cable braid wire to prevent snagging when sliding on the splice components.

Caution: Carefully handle the sharp ends of the steel cable braid to avoid injury to hands.

a. Slide one copper sleeve over each cable.

b. Slide a vinyl sleeve and copper sleeve over cable No. 1 (A, fig. 55).

c. Slide a copper sleeve and a splice grip, soldered end last, over cable No. 2 (B, fig. 55).

Note. If it is necessary to enlarge the ends of the splice grip, collapse the grip lengthwise and alternately slide the looped ends of the grip over the handle of the TL-107, pushing and twisting the splice grip up the handle. This will widen the looped end of the splice grip and make it easier to slide over the end of the cable.

d. Remove 11 inches of the outer jacket, cable braid, and stabilizing tape from cables No. 1 and No. 2 as follows:

- (1) Carefully cut two circular rings, three-quarters of an inch apart, through the outer jacket down to the steel cable braid (C, fig. 55).
- (2) Slit the outer jacket between the ringed cuts ((1) above) and remove the outer jacket with the TL-107.
- (3) Cut the steel wires of the exposed cable braid with the TL-107 as close to the outer jacket (nearest the inside of the cable) as possible (fig. 56).
- (4) Loosen the stabilizing tape (located between the steel cable braid and the inner jacket) with a twisting motion. Cut the tape close to the outer jacket.
- (5) Pull the outer jacket toward the splicing end of the cable by gripping the ends of the cable braid in the area of the two circular cuts ((1) above).

e. Remove the inner jacket from cables No. 1 and No. 2 as follows:

- (1) Cut a nick around the inner jacket, three-quarters of an inch from the end of the outer jacket. Be careful to cut only part way through the inner jacket.
- (2) Flex the inner jacket and conductor until the jacket separates at the nick, (1) above.
- (3) Make a longitudinal cut through the inner jacket, at the end of the cable, approximately one-quarter of an inch long (D, fig. 55).
- (4) Grasp the inner jacket on each side of the cut, with the TL-107 and pull outward. The inner jacket should peel away from the insulated conductors (fig. 57).
- (5) Cut the polyethylene core (fig. 58) close to the end of the inner jacket. The polyethylene core is the thin plastic cord that is entwined with the conductors.
- (6) Cut the conductors of cables No. 1 and No. 2 to the required length.

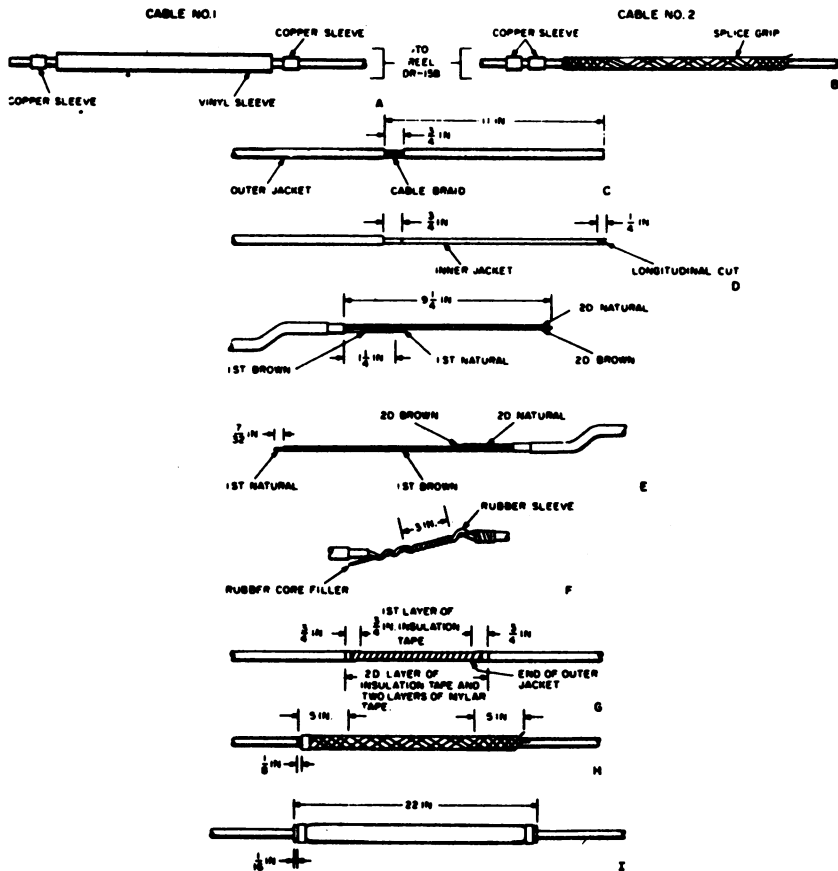

Figure 55. Preparation of spiral-four telephone cable WF-8/F for splicing.

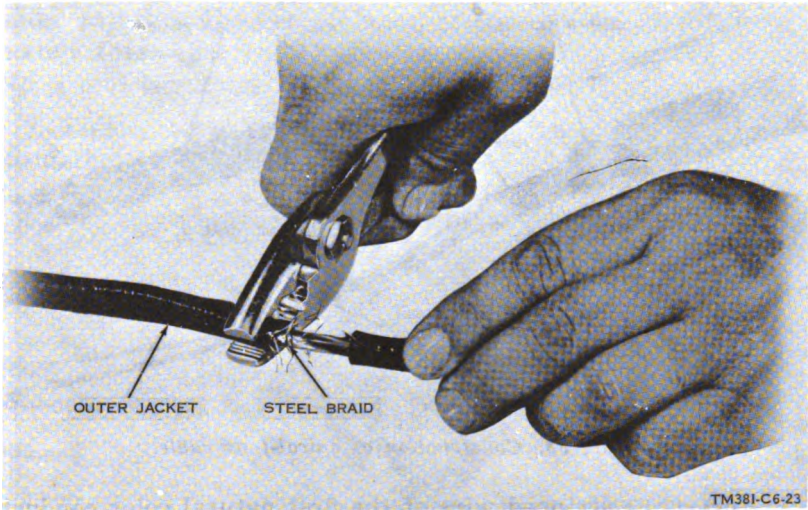

Figure 56. Cutting exposed cable braid.

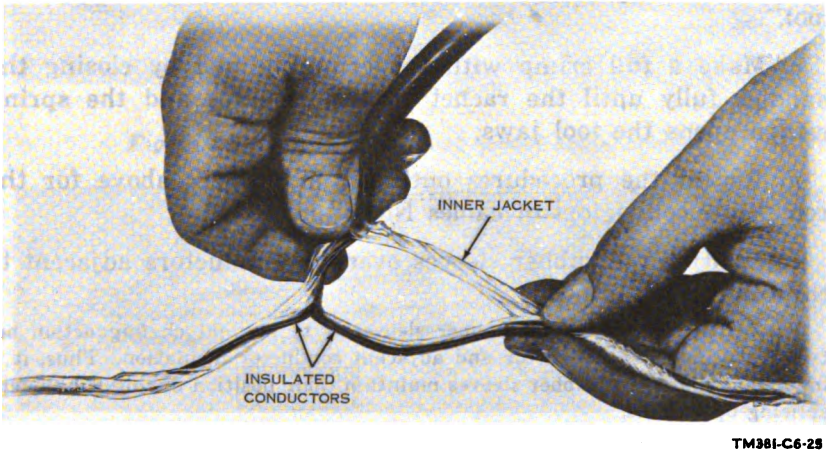

Figure 57. Stripping inner jacket from insulated conductors.

f. Remove seven thirty-seconds of an inch of insulation from each conductor of both cables (E, fig. 55).

g. Slide a rubber sleeve over the two longer conductors of each cable (F, fig. 55).

119.9. Splicing Procedure

a. Position the insulated sealed splice connector in the crimping tool so that the recessed center groove of the connector is engaged in one of the external alignment plates of the crimping tool (fig. 59).

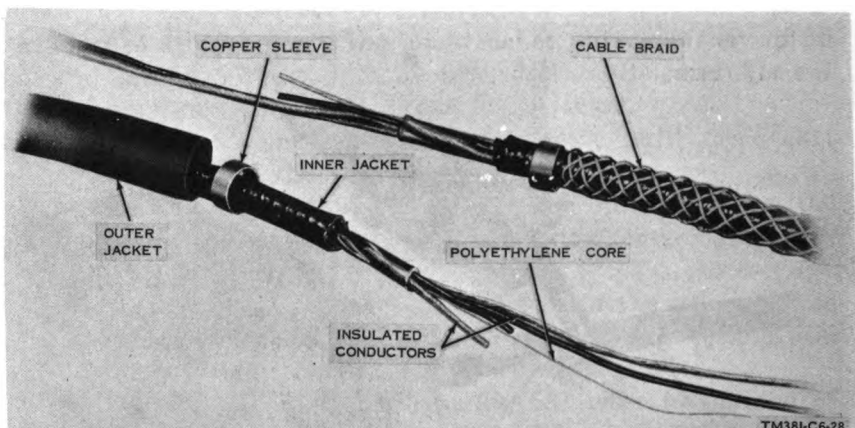

Figure 58. Construction of spiral-four cable.

b. Insert the stripped wire of the first natural color conductor of cable No. 1 into the half of the insulated sealed splice connector that is positioned under the crimping dies of the crimping tool.

c. Make a full crimp with the crimping tool by closing the handles fully until the ratchet control releases and the spring return opens the tool jaws.

d. Repeat the procedures outlined in *b* and *c* above for the remaining conductors of cables No. 1 and No. 2.

e. Position the rubber sleeves over the conductors adjacent to the connectors (fig. 60).

Note. The purpose of the rubber sleeves is to prevent chafing action between the insulated connector and adjacent conductor insulation. Thus, it is important that these rubber sleeves maintain their position during subsequent splicing operations.

f. Use electrical insulation tape and tape one end of the rubber core filler to the inner jacket of cable No. 1.

g. Wrap the portion of the conductors between the two sets of connectors in a tight close spiral about the rubber core filler. The conductors should lay flat on the core filler with no cross-overs (F, fig. 55 and fig. 61).

h. Tape the free end of the rubber core filler to the outer jacket of cable No. 2 and straighten any irregularities in the cable. Cut off any excess rubber tubing.

i. Tightly wrap two layers of electrical insulation tape over the assembled splice. The first layer of tape should cover the exposed splice and inner jackets of both cables, but not extend onto the

outer jackets. The second layer of tape should extend approximately three-quarters of an inch on the outer jackets of cables No. 1 and No. 2 (G, fig. 55).

j. Tightly wrap two layers of mylar tape over the electrical insulation tape.

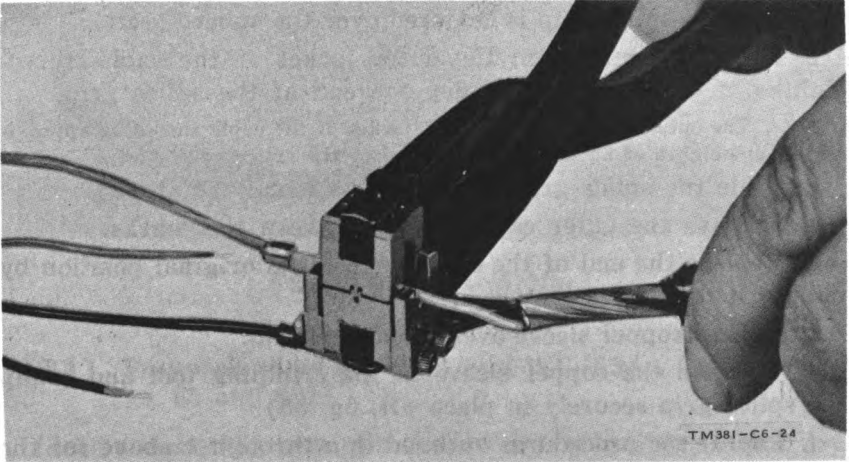

Figure 59. Crimping insulated peeled splice connectors.

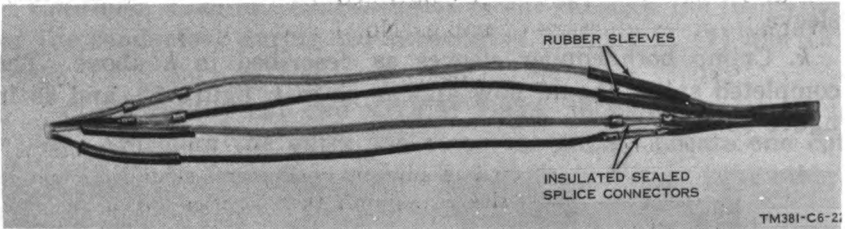

Figure 60. Positioning rubber sleeves on conductors.

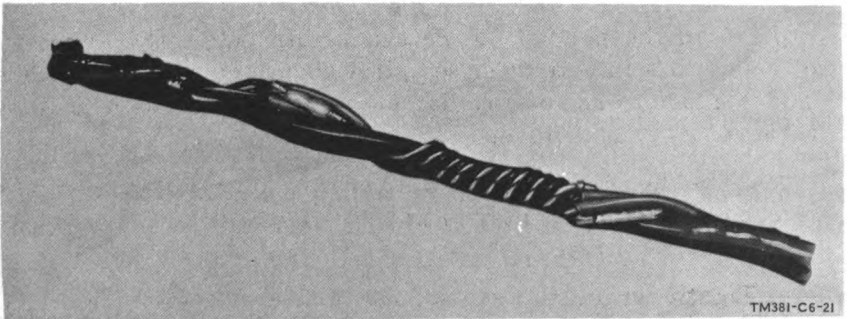

Figure 61. Placement of conductors on core filler.

119.10. Positioning and Crimping Splice Grip

a. Slide the splice grip over the taped splice (fig. 62).

Note. Approximately 5 inches of the splice grip should extend over the outer jacket of the cable on each side of the taped section.

b. Hold the center of the splice grip with one hand and draw down the ends of the splice grip to remove any slack. Check to be sure that the splice grip is centered over the spliced section.

c. Make two marks on the outer jacket of the cable, three-eighths of an inch apart, under one end of the splice grip.

Note. The outside mark on the outer jacket of the cable should be approximately one-eighth of an inch from the end of the splice grip.

d. Slide the splice grip to expose the marks (c above).

e. Remove the outer cable jacket between the marks.

f. Replace the end of the splice grip in its original position by pulling it to remove the slack.

g. Slide a copper sleeve over the cable braid.

h. Position the copper sleeve in the crimping tool and crimp the splice grip securely in place (H, fig. 55).

i. Repeat the procedures outlined in a through h above for the opposite end of the cable.

j. Slide a vinyl sleeve over the cable grip and slide copper sleeves, within one-sixteenth of an inch, onto the ends of the vinyl sleeve.

k. Crimp both copper sleeves as described in h above. The completed splice should now appear as in I, figure 55, and as in figure 63.

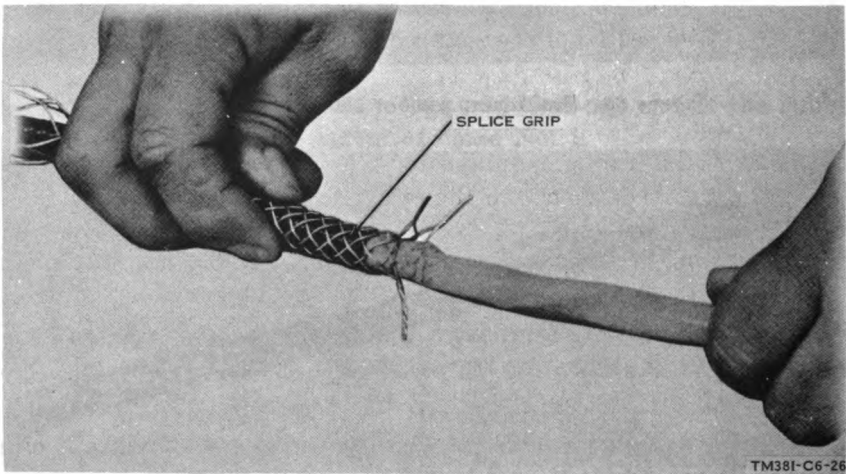

Figure 62. Insertion of splice grip on taped splice.

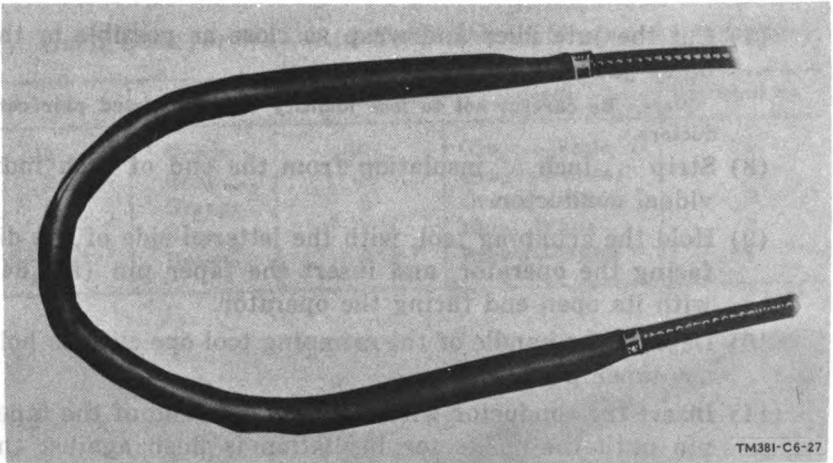

Figure 63. Completed splice.

119.11. Preparation of WC-534 and WC-534A Cable (figs. 65 and 66)

Clean and dry the first 12 inches of the cable with a clean, dry, lint-free cloth.

a. WC-534 Cable (Solid Conductor).

Caution: Take extreme care not to cut through the insulation of the conductors during the procedures outlined in (1) and (2) below.

- (1) Carefully cut two circular rings, about 6 inches apart, through the outer jacket of the cable. Locate one cut 1 inch from the squared end of the cable; and the other, 7 inches from the squared end of the cable.

Note. Be careful not to cut the outer jacket at the squared end of the cable. The 1-inch piece is required to prevent the conductor pairs from untwisting.

- (2) Make a longitudinal cut through the outer jacket from one circular cut to the other.
- (3) Flex the outer jacket until the jacket separates at the cuts. Use pliers to remove the outer jacket from the cable.
- (4) Separate each paired conductor and, while holding the end of the cable, pull each pair of conductors (one pair at a time) out of the outer jacket.
- (5) Twist each pair of conductors together to maintain pair identity.
- (6) Cut off the paired conductors 1-inch from the cable butt.

- (7) Cut the jute filler and wrap as close as possible to the outer jacket.
- Note.* Be careful not to lose identity of the twisted pair conductors.
- (8) Strip $\frac{7}{16}$ -inch of insulation from the end of each individual conductor.
 - (9) Hold the crimping tool, with the lettered side of the die facing the operator, and insert the taper pin (fig. 64) with its open end facing the operator.
 - (10) Depress the handle of the crimping tool one click to hold the taper pin.
 - (11) Insert the conductor wire into the open end of the taper pin until the conductor insulation is flush against the taper pin.
 - (12) Make a full crimp with the crimping tool by closing the handles fully until the ratchet control releases and the spring return opens the tool jaws.

b. WC-534A Cable (Stranded Conductor).

Note. The procedure for preparing the WC-534A cable is similar to that used for the WC-534 cable except that it is not necessary to strip the outer jacket back 7 inches to identify the twisted conductor pairs. In the WC-534A cable, each conductor is a different color, thus simplifying pair identification.

- (1) Carefully cut a circular ring through the outer jacket about 1 inch from the squared end of the cable.
- (2) Make a longitudinal cut through the outer jacket of the cable from the circular cut to the squared end.
- (3) Flex the outer jacket until the jacket separates at the cuts; remove the outer jacket.
- (4) Perform the procedures outlined in *a*(8) through (12) above.

c. Color Coding for WC-534 and WC-534A Cables. The following charts *d* and *e* below list the terminal numbers and color coding for WC-534 and WC-534A cables.

d. Color Code for WC-534 (Solid Copper Tinned Conductors).

Pair No.	Color	Terminal No.	Mate	Terminal No.
1	Green	10	White or natural	5
2	Red	9	White or natural	1
3	Yellow	8	White or natural	2
4	Blue	7	White or natural	3
5	Black	6	White or natural	4

e. Color Code for WC-534A Cable (Seven Stranded Conductor).

Pair No.	Color	Terminal No.	Mate	Terminal No.
1	Green	10	Green—White	5
2	Gray	9	Gray—White	1
3	Orange	8	Orange—White	2
4	Blue	7	Blue—White	3
5	Brown	6	Brown—White	4

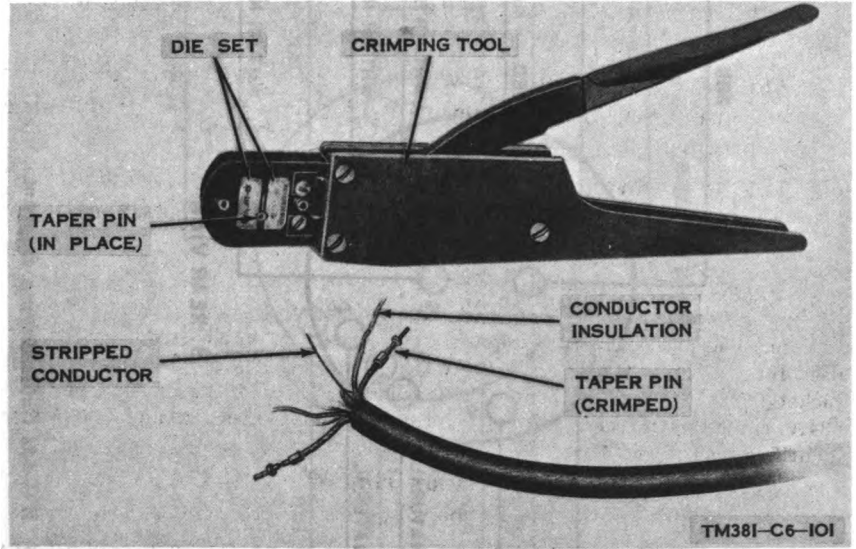
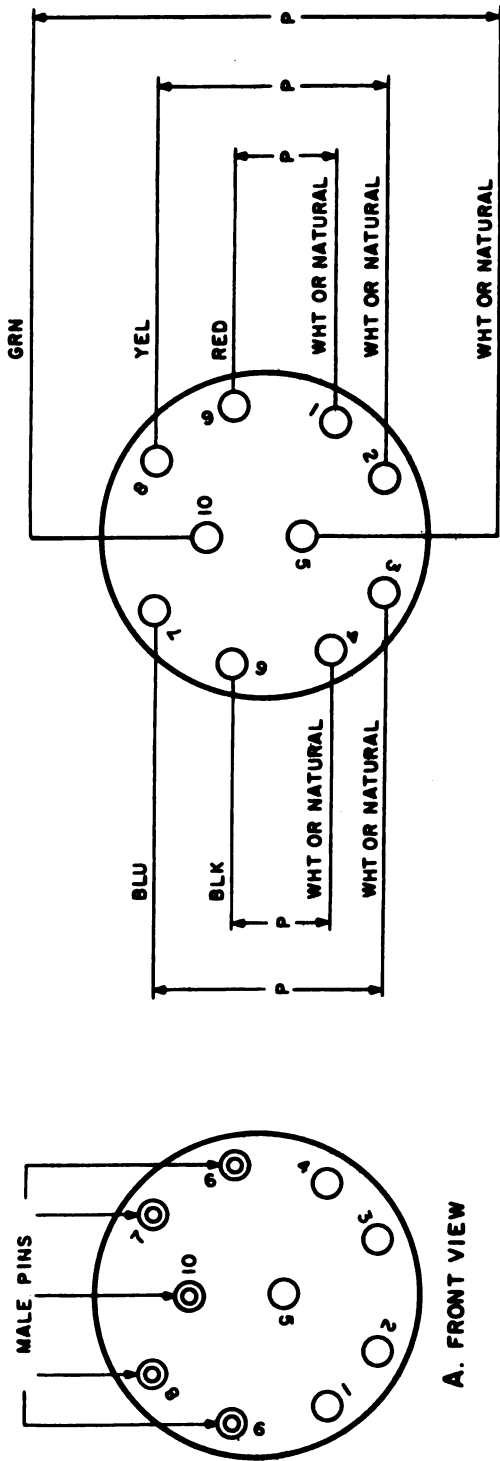

Figure 64. Use of crimping tool.



B. REAR VIEW

NOTES:

1. "P" DEMOTES PAIRED CONDUCTORS.
2. NUMBERS ON CONDUCTOR PINS FOR REFERENCE ONLY.

TM361-C6-50

Figure 65. WC-534 Cable, wiring diagram.

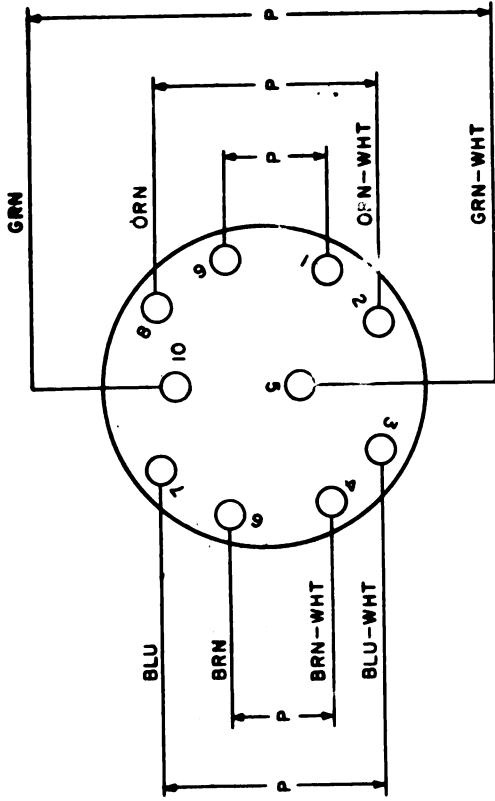

A. FRONT VIEW

NOTES:

1. "p" DENOTES PAIRED CONDUCTORS
2. NUMBERS ON CONDUCTOR PINS FOR REFERENCE ONLY.

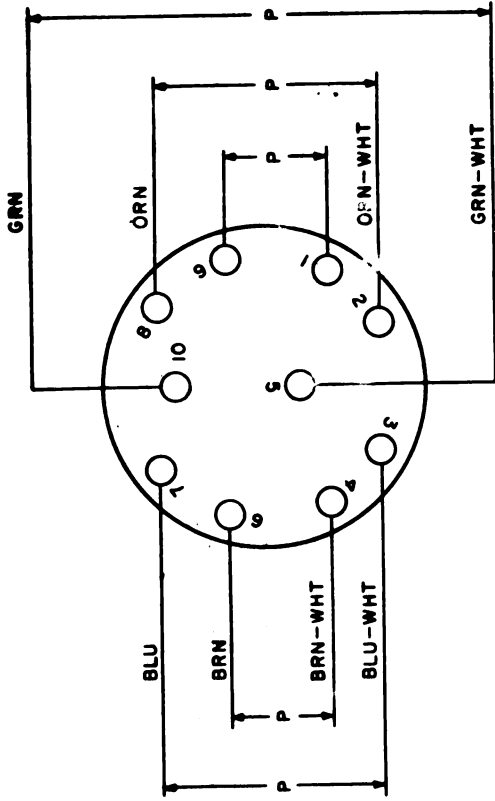

B. REAR VIEW

Figure 66. WC-534A Cable, wiring diagram.

TM381-C6-51

Page 121. Add the following appendix (as added by C 5, 7 October 1963) after chapter 8.

APPENDIX I

REFERENCES

Following is a list of applicable references available to maintenance personnel of the equipment.

- DA PAM 310-4 Index of Technical Manuals, Technical Bulletins, Supply Manuals (Types 4, 6, 7, 8, and 9), Supply Bulletins, Lubrication Orders, and Modification Work Orders.
- FM 24-20 Field Wire and Field Cable Techniques
- TB SIG 268 Use of Sectional Metal Line Construction Poles AB-308/G and AB-309/G.
- TM 9-213 Painting Instructions for Field Use.
- TM 11-370 Plow LC-61 (Cable).
- TM 11-2017 Test Sets TS-26/TSM, TS-26A/TSM, and TS-26B/TSM.
- TM 11-2019 Test Sets 1-49, 1-49-A, and 1-49-B and Resistance Bridges ZM-4A/U and ZM-4B U.
- TM 11-2050 Test Set I-48-B and Ohmmeter ZM-21A U.
- TM 11-2057A Test Set TS-27B/TSM.
- TM 11-2262 Outside Plant Wire; Construction and Maintenance.
- TM 38-750 Army Equipment Record Procedures.
- Redesignate "appendix I" (page 2 of C 4) as appendix II.
- Redesignate "appendix II" (page 7 of C 4) as appendix III.

By Order of the Secretary of the Army:

HAROLD K. JOHNSON,
*General, United States Army,
Chief of Staff.*

Official:

J. C. LAMBERT,
*Major General, United States Army,
The Adjutant General.*

Distribution:

Active Army:

USASA (2)	USACDCTA (1)
CNGB (1)	USACDCADA (1)
CC-E (7)	USACDCARMA (1)
CofT (1)	USACDCAVNA (1)
CofEngrs (1)	USACDCARTYA (1)
TSG (1)	USACDCSWA (1)
CofSptS (1)	GENDEP (OS) (2)
USCONARC (5)	Sig Sec, GENDEP (OS) (5)
USAMC (5)	Sig Dep (OS) (12)
ARADCOM (2)	Army Dep (2) except SAAD
ARADCOM Rgn (2)	(30) LXAD. TOAD (14),
OS Maj Comd (3)	FTWOAD (10) LEAD,
LOGCOMD (2)	NAAD (5), SHAD (3),
USAECOM (7)	SVAD (5), CHAD (3),
USAMICOM (4)	ATAD (4)
USASMC (2)	USASCC (4)
MDW (1)	USATC AD (2)
Armies (2) except	USATC Armor (2)
EUSA (5)	USATC Engr (2)
USAREUR (5)	USATC Inf (2)
Corps (2)	USASTC (2)
USAC (3)	WSMR (5)
11th Air Assault Div (3)	USA Tml Comd (1)
1st GM Bde (5)	Army Tml (1) except
Instl (2) except	OART (5)
Ft Monmouth (63)	POE (1)
Ft Hancock (4)	Sig Fld Maint Shops (2)
Ft Gordon (5)	WRAMC (1)
Ft Huachuca (10)	Army Pic Cen (2)
USASETAF (5)	Chicago Proc Dist (1)
USMA (5)	AMS (1)
Svc Colleges (2)	USAERDAA (2)
Br Svc Sch (2)	USAERDAW (13)
USASESCS (30)	KMAG (5)
USACDCEA (1)	Units org under fol TOE:
USACDCCBRA (1)	(2 copies each except as
USACDCCEA (1)	indicated)
USACDCCEA (Monmouth	5-600
Ofc) (1)	5-605
USACDCOA (1)	7
USACDCQMA (1)	7-52

11-5	11-155
11-6	11-157
11-7	11-215
11-16	11-218
11-25	11-500 (AA-AE) (4)
11-27	11-555
11-35	11-557
11-36	11-558
11-38	11-587
11-39	11-592
11-45	11-597
11-47	11-608
11-55	17
11-56	33-105
11-57	33-106
11-87	37
11-97	57
11-117	

NG: State AG (3); units—same as Active Army except allowance is one copy to each unit.

USAR: None.

For explanation of abbreviations used, see AR 320-50.

TM 11-381
TO 31W1-2G-121
*C 4

DEPARTMENT OF THE ARMY TECHNICAL MANUAL
DEPARTMENT OF THE AIR FORCE TECHNICAL ORDER

CABLE ASSEMBLY CX-1065/G,
TELEPHONE CABLE ASSEMBLIES CX-1606/G
AND CX-1512/U TELEPHONE LOADING
COIL ASSEMBLY CU-260/G
AND ELECTRICAL CONNECTOR PLUG U-176/G

TM 11-381 } DEPARTMENTS OF THE ARMY
TO 31W1-2G-121 } AND THE AIR FORCE
CHANGES No. 4 } WASHINGTON 25, D. C., 28 December 1962

TM 11-381/TO 31W1-2G-121, 20 September 1955, is changed as follows:

The parenthetical reference to previous changes (example: "page 1 of C1") indicates that pertinent material was published in that change.

Page 3, paragraph 2 (page 1 of C1). Add the following after subparagraph b.

c. Comments on Manual. Forward all comments on this publication direct to: Commanding Officer, U. S. Army Electronics Materiel Support Agency, ATTN: SELMS-MP, Fort Monmouth, N. J. (DA Form 1598) (Record of Comments on Publications.) DA Form 2028 (Recommended changes to DA Technical Manual Parts List or Supply Manual 7, 8 or 9), DD Form 96 (Disposition Form), or letter may be used.

Page 15, paragraph 14.1b(3) (as added by C3, 12 April 1961).

Caution: Do not rotate the rubber-covered coupler assembly on connector U-176/G before the brass coupler on the universal connector is disconnected or the two connectors will jam. Be sure to rotate and disconnect the brass coupler on the universal connector first. If the rubber-covered coupler assembly on connector U-176/G is unintentionally turned first, retighten it, and then rotate and disconnect the brass coupler on the universal connector.

Page 121.

* This change supersedes C 3, 12 April 1961.

APPENDIX I
MAINTENANCE ALLOCATION CHART
TELEPHONE, CABLE ASSEMBLY CX-1606/G
(Added)

Section I. MAINTENANCE ALLOCATION

1. General

a. This section assigns maintenance functions to be performed on components, assemblies, and subassemblies by the lowest appropriate maintenance echelon.

b. Columns in the maintenance allocation chart are as follows:

- (1) *Component.* This column shows only the nomenclature or standard item name. Additional descriptive data is included only where clarification is necessary to identify the component. Components, assemblies, and subassemblies are listed in top-down order. That is, the assemblies which are part of a component are listed immediately below that component, and the subassemblies which are part of an assembly are listed immediately below that assembly. Each generation breakdown (components, assemblies, or subassemblies) are listed in disassembly order or alphabetical order.
- (2) *Maintenance function.* This column indicates the various maintenance functions allocated to the echelons.
 - (a) *Service.* To clean, to preserve, and to replenish lubricants.
 - (b) *Adjust.* To regulate periodically to prevent malfunction.
 - (c) *Inspect.* To verify serviceability and to detect incipient electrical or mechanical failure by scrutiny.
 - (d) *Test.* To verify serviceability and to detect incipient electrical or mechanical failure by use of special equipment such as gages, meters, etc.
 - (e) *Replace.* To substitute serviceable components, assemblies, or subassemblies, for unserviceable components, assemblies, or subassemblies.

- (f) **Repair.** To restore an item to serviceable condition through correction of a specific failure or unserviceable condition. This function includes but is not limited to welding, grinding, riveting, straightening, and replacement of parts other than the trial and error replacement of running spare type items such as fuses, lamps, or electron tubes.
 - (g) **Align.** To adjust two or more components of an electrical system so that their functions are properly synchronized.
 - (h) **Calibrate.** To determine, check, or rectify the graduation of an instrument, weapon, or weapons system, or components of a weapons system.
 - (i) **Overhaul.** To restore an item to *completely serviceable* condition as prescribed by serviceability standards developed and published by heads of technical services. This is accomplished through employment of the technique of "Inspect and Repair Only as Necessary" (IROAN). Maximum utilization of diagnostic and test equipment is combined with minimum disassembly of the item during the overhaul process.
 - (j) **Rebuild.** To restore an item to a standard as near as possible to original or new condition in appearance, performance, and life expectancy. This is accomplished through the maintenance technique of complete disassembly of the item, inspection of all parts or components, repair or replacement of worn or unserviceable elements using original manufacturing tolerances and/or specifications and subsequent reassembly of the item.
- (3) **1st, 2d, 3d, 4th, and 5th echelons.** The symbol X placed in Columns 3 through 7 indicates the echelon responsible for performing that particular maintenance operation, but does not necessarily indicate that repair parts will be stocked at that level. Echelons higher than the echelon marked by X are authorized to perform the indicated operation.
- (4) **Tools required.** This column indicates codes assigned to each individual tool equipment, test equipment, and maintenance equipment referenced. The grouping of codes in this column of the maintenance allocation chart indicates the tool, test, and maintenance equipment required to perform the maintenance function.

(5) *Remarks.* Entries in this column will be utilized when necessary to clarify any of the data cited in the preceding columns.

c. Columns in the allocation of tools for maintenance functions are as follows:

(1) *Tools required for maintenance functions.* This column lists tools, test, and maintenance equipment required to perform the maintenance functions.

(2) *1st, 2d, 3d, 4th, and 5th echelon.* The dagger (†) symbol in these columns indicates the echelons normally allocated the facility.

(3) *Tool code.* This column lists the tool code assigned.

2. Maintenance by Using Organizations

When this equipment is used by signal services organizations organic to theater headquarters or communication zones to provide theater communications, those maintenance functions allocated up to an including fourth echelon are authorized to the organization operating this equipment.

Section II. MAINTENANCE ALLOCATION CHART

(1) PART OR COMPONENT	(2) MAINTENANCE FUNCTION	(3) 1ST ECH.	(4) 2ND ECH.	(5) 3RD ECH.	(6) 4TH ECH.	(7) 5TH ECH.	(8) TOO'S REQUIRED	(9) REMARKS
TELEPHONE, CABLE ASSEMBLY CX-1606/G	service inspect test		X X X				1, 8 1, 8	Tests for continuity All testing
	repair		X	X			3, 4, 5, 6, 7 3, 6, 7 1, 8 2	Splice cable Replaces U-176/G Plug, all repairs to cable.

CX-1606/G 1 A

Section III. ALLOCATION OF TOOLS FOR MAINTENANCE FUNCTIONS

(1)	(2)	(3)	(4)	(5)	(6)	(7)	(8)
TOOLS REQUIRED FOR MAINTENANCE FUNCTIONS	1ST ECH.	2ND ECH.	3RD ECH.	4TH ECH.	5TH ECH.	TOOL CODE	REMARKS
CX-1606/G (continued)							
LINEMAN'S EQUIPMENT, TE-21		†				1	
MAINTENANCE KIT, CABLE SPLICING MK-640/G			†	†	†	2	
RESISTANCE BRIDGE ZM-4A/U AND ZM-4B/U		†				3	
TELEPHONE CABLE ASSEMBLY CX-1512/U		†				4	
TEST SET 1-51		†				5	
TEST SET TS-26/TSM		†	†	†	†	6	
TEST SET TS-27/TSM		†	†	†	†	7	
TOOL EQUIPMENT TE-33		†				8	

CX-1606/G B

APPENDIX II
BASIC ISSUE ITEMS LIST, TELEPHONE,
CABLE ASSEMBLY CX-1606/G
(Added)

Section I. INTRODUCTION

1. General

This appendix lists items supplied for initial operation.

2. Columns are as follows

- a. Source, Maintenance and Recoverability Code.* Not used.
- b. Federal Stock Number.* This column lists the 11-digit Federal stock number.
- c. Designation by Model.* Not used.
- d. Description.* Nomenclature or the standard item name and brief identifying data for each item are listed in this column. When requisitioning, enter the nomenclature and description.
- e. Unit of Issue.* The unit of issue is each unless otherwise indicated and is the supply term by which the individual item is counted for procurement, storage, requisitioning, allowances, and issue purposes.
- f. Expendability.* Nonexpendable items are indicated by NX. Expendable items are not annotated.
- g. Quantity authorized.* Under "Items Comprising an Operable Equipment", the column lists the items supplied for the initial operation of the equipment.
- h. Illustrations.* Not used.

Section II. FUNCTIONAL PARTS LIST

(1)	(2)	(3)	(4)	(5)	(6)	(7)	(8)	(9)
SOURCE MAINTENANCE AND RECOVERABILITY CODE	FEDERAL STOCK NUMBER	DESIGNATION BY MODEL	DESCRIPTION	UNIT OF ISSUE	EXPENDABILITY	QUANTITY AUTHORIZED	ILLUSTRATIONS FIGURE NO.	ITEM NO.
	5995-889-0917		TELEPHONE, CABLE ASSEMBLY CX-1606/G; a 4 cond cable assy used in 4 channel and 12 channel carrier tel systems; 1320 ft - 4 in lg o/a inc term; terminated at ea end with 1 Connector, Plug, Electrical U-176/G; Sig dwg SC-DL-61927		NX			
			ITEMS COMPRISING AN OPERABLE EQUIPMENT					
	Ord thru AGC		TECHNICAL MANUAL TM 11-381 (Note: Technical Manuals will not be packed with reels of cable and should be requisitioned as required.)					
			RUNNING SPARE ITEMS					
			NO PARTS AUTHORIZED FOR STOCKAGE AT FIRST ECHELON					

CX-1606/G 1 C

By Order of the Secretary of the Army:

EARLE G. WHEELER,
General, United States Army,
Chief of Staff.

Official:

J. C. LAMBERT,
Major General, United States Army,
The Adjutant General.

Distribution:

Active Army:

DASA (6)	AMS (1)
USASA (2)	Army Pictorial Cen (1)
CNGB (1)	USA Mob Spt Cen (1)
CSigO (5)	Yuma Test Sta (2)
CofT (1)	USA Carib Sig Agcy (1)
CofEngrs (1)	Sig Fld Maint Shops (3)
TSG (1)	USA Corps (3)
USCONARC (5)	JBUSMC (2)
ARADCOM (2)	USA Elct Mat Agcy (25)
ARADCOM Rgn (2)	USA Strat Comm Comd (4)
OS Maj Comd (3)	Def Log Svc Cen (1)
OS Base Comd (2)	USMA (5)
LOGCOMD (2)	1st GM Bde (5)
MDW (1)	Units org under fol TOE: (2 copies each except as indicated)
Armies (2)	5-600
Corps (2)	5-605
Instl (2) except	6-501
Ft Monmouth (63)	7
USATC AD (2)	11-5
USATC Armor (2)	11-6
USATC Engr (2)	11-7
USATC Inf (2)	11-15
Svc Colleges (2)	11-16
Br Svc Sch (2)	11-18
GENDEP (OS) (2)	11-25
Sig Sec, GENDEP (OS) (5)	11-27
A Dep (2) except	11-36
Lexington (12)	11-37
Sacramento (17)	11-38
Tobyhanna (12)	11-39
Ft Worth (8)	11-45
Sig Dep (OS) (5)	11-47
USA CD Agcy (1)	11-55
WRAMC (1)	11-56
USA Trans Tml Comd (1)	11-57
Army Tml (1)	11-58
OSA (1)	11-85
POE (1)	11-87
AFIP (1)	

11-95	11-597
11-97	11-608
11-98	17
11-117	29-56
11-155	30-15
11-157	30-16
11-237	30-25
11-500 (AA-AE) (4)	30-28
11-555	33-105
11-557	33-106
11-558	37
11-587	39-51
11-592	57

NG: State AG (3); units—same as Active Army except allowance is one copy to each unit.

USAR: None.

For explanation of abbreviations used, see AR 320-50.

TECHNICAL MANUAL
No. 11-381
TECHNICAL ORDER
No. 31W1-2-101

} DEPARTMENTS OF THE ARMY AND
THE AIR FORCE
WASHINGTON 25, D. C., 20 September 1955

CABLE ASSEMBLY CX-1065/G, TELEPHONE CABLE ASSEMBLIES CX-1606/G AND CX-1512/U, AND TELEPHONE LOADING COIL ASSEMBLY CU-260/G

	Paragraphs	Page
CHAPTER 1. INTRODUCTION		
Section I. General -----	1, 2	3
II. Description and data -----	3- 13	3
III. Interconnection of assemblies -----	14, 15	15
CHAPTER 2. ROUTE PLANNING		
Section I. Route planning considerations -----	16- 21	17
II. Surveying route -----	22- 26	19
CHAPTER 3. CONSTRUCTION OF CABLE LINES		
Section I. Organization of construction program -----	27- 35	24
II. Construction of surface cable lines -----	36- 43	28
III. Construction of buried cable lines -----	44- 58	41
IV. Construction of self-supported aerial cable lines.	59- 74	49
V. Construction of messenger-supported aerial cable lines.	75- 77	67
VI. Connections to open wire lines and to unattended repeater equipment.	78- 81	71
CHAPTER 4. MAINTENANCE		
Section I. Preventive maintenance services -----	82- 84	77
II. Performing preventive maintenance -----	85- 87	78
III. Field repair of cable -----	88- 93	80
CHAPTER 5. TESTING		
Section I. Testing procedures -----	94-103	88
II. Proof testing as line is built -----	104-109	97
III. Maintenance tests -----	110-112	100
CHAPTER 6. REPAIR	113-119	110
7. REMOVAL AND SALVAGE OF CABLE		
Section I. Recovery procedures -----	120, 121	111
II. Recovery of surface cable -----	122-127	113
III. Recovery of aerial cable -----	128-132	116
IV. Recovery of buried cable -----	133-136	119
CHAPTER 8. DEMOLITION TO PREVENT ENEMY USE.	137, 138	121
INDEX -----		122

* This manual supersedes TB SIG 233/TO 16-35CU-260-5, 17 July 1952, including C 1, 23 October 1952.

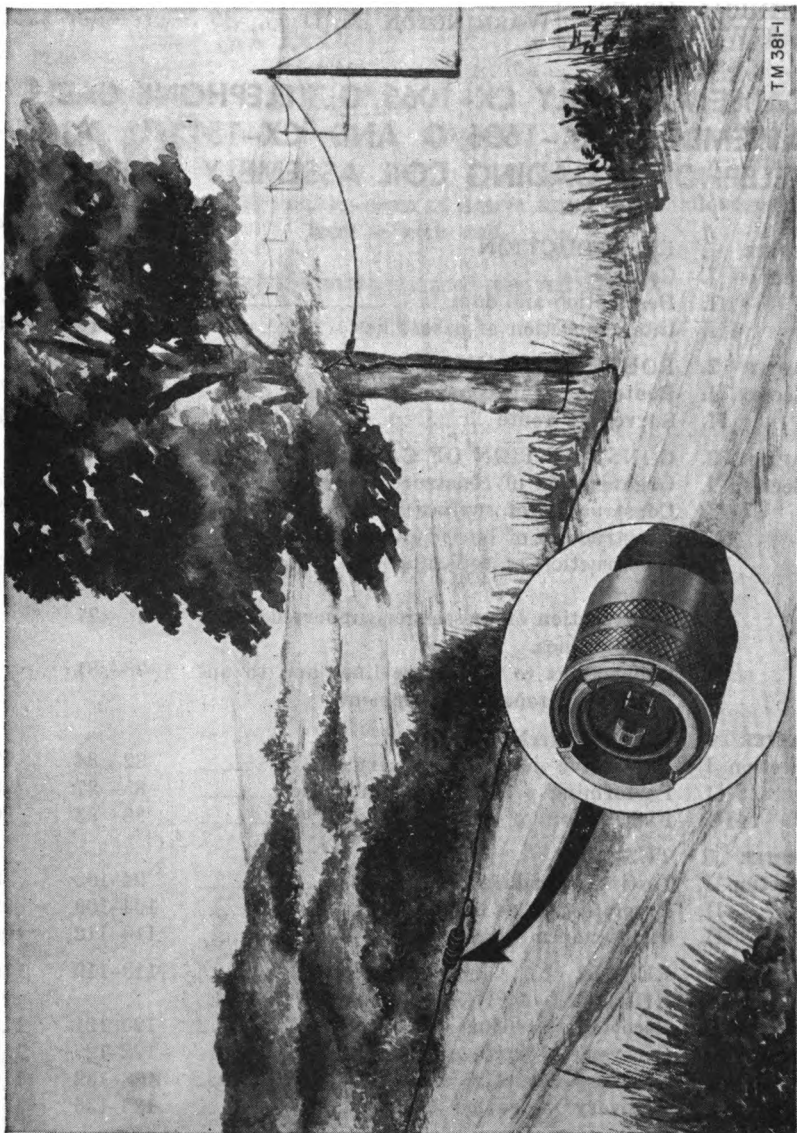

Figure 1. Typical spiral-four cable installation.

CHAPTER 1

INTRODUCTION

Section I. GENERAL

1. Scope

a. This manual contains instructions on the construction methods, maintenance procedures, testing procedures, and repair procedures for spiral-four cable lines using Cable Assembly CX-1065/G, Telephone Cable Assemblies CX-1606/G and CX-1512/U, and Telephone Loading Coil Assembly CU-260/G. The instructions are directed primarily to the officers and noncommissioned officers who supervise the operations of line construction personnel.

b. Throughout this manual, basic nomenclature followed by () refers to all models of the equipment, regardless of past or present procurement.

c. Forward any comments on this publication direct to: Commanding Officer, The Signal Corps Publications Agency, Fort Monmouth, N. J. ATTN: Standards Division.

2. Forms and Records

a. The following forms will be used for reporting unsatisfactory conditions of Army equipment and when performing preventive maintenance.

(1) DD Form 6, Report of Damaged or Improper Shipment, will be filled out and forwarded as prescribed in SR 745-45-5 (Army) ; Navy Shipping Guide, Article 1850-4 (Navy) ; and AFR 71-4 (Air Force).

(2) DA Form 468, Unsatisfactory Equipment Report, will be filled out and forwarded to the Office of the Chief Signal Officer, as prescribed in SR 700-45-5.

b. Use other forms and records as authorized.

Section II. DESCRIPTION AND DATA

3. Purpose and Use

a. General. Cable Assembly CX-1065/G, Telephone Cable Assemblies CX-1606/G and CX-1512/U, and Telephone Loading Coil Assembly CU-260/G may be used to form a four-wire transmission line to link stations of a military carrier telephone com-

munications system. The assemblies may be used in any climate. The line may be laid on the ground, laid under water, buried, or strung from poles or trees. Cable Assembly CX-1065/G is the main assembly of the group and forms the greatest portion of the transmission line.

b. Cable Assembly CX-1065/G. This cable assembly consists of one-fourth mile of Telephone Cable WF-8/G with a universal connector at each end for rapid connecting and disconnecting. These assemblies are connected together to form a transmission line of the required length.

c. Telephone Cable Assembly CX-1606/G. This cable assembly consists of 100 feet of Telephone Cable WF-8/G with a universal connector at each end. It is used to span short distances between equipments, between a piece of equipment and the end of a line, or between two Cable Assemblies CX-1065/G.

d. Telephone Cable Assembly CX-1512/U. This cable assembly consists of 12 feet of Telephone Cable WF-8/G with a universal connector at one end and exposed conductors at the other end. It is used for the following purposes:

- (1) For connections to equipments that are not provided with cable connectors.
- (2) When making local tests on some equipments.
- (3) For connections to open-wire lines.
- (4) When making tests on the cable line.

e. Telephone Loading Coil Assembly CU-260/G. This loading coil assembly is used with certain carrier telephone communications system (par. 4b and d) to decrease cable attenuation and thus permit greater spacing of repeaters. It is connected into the cable line at the junction of two Cable Assemblies CX-1065/G.

4. System Application

a. General.

- (1) Cable Assembly CX-1065/G, Telephone Cable Assemblies CX-1606/G and CX-1512/U, and Telephone Loading Coil Assembly CU-260/G have been designed specifically as the transmission medium for the four-channel carrier telephone system using Telephone Terminal AN/TCC-3 and Telephone Repeater AN/TCC-5 (*b* below). With the exception of the loading coil, the cable assemblies were also designed for the twelve-channel carrier telephone system using Telephone Terminal AN/TCC-7 and Telephone Repeaters AN/TCC-8 and AN/TCC-11 (*c* below).

- (2) The assemblies also may be used to replace Cable Assemblies CC-358 and CC-368, and Cable Stub CC-356 (TM 11-369, Cable Assembly CC-358, Cable Assembly CC-368, and Cable Stub CC-356 (Spiral Four)), which were specifically designed as the transmission medium for systems using Telephone Terminal CF-1-A or CF-1-B and Repeater CF-3-A (*d* below).

b. Use with Four-Channel AN/TCC-3 System.

- (1) When used with the four-channel AN/TCC-3 system, the transmission line is made up of Cable Assemblies CX-1065/G (par. 7) with Telephone Loading Coil Assembly CU-260/G (par. 10) connected between the mating connectors of Cable Assemblies CX-1065/G (fig. 2).
- (2) Telephone Cable Assembly CX-1606/G (par. 8) is used to span short distances in the transmission line. Additional loading coils are not required when a CX-1606/G is added to the transmission line.
- (3) Telephone Cable Assembly CX-1512/U (par. 9) is used when performing tests on the equipment and on the cable line.
- (4) Telephone Terminal AN/TCC-3 and Telephone Repeater AN/TCC-5 are equipped with connector receptacles which mate with the universal connectors on the cable assemblies. The AN/TCC-3 and AN/TCC-5 also have loading coils built into the equipment. These loading coils eliminate the need for Telephone Loading Coil Assembly CU-260/G at the connection to the equipment.

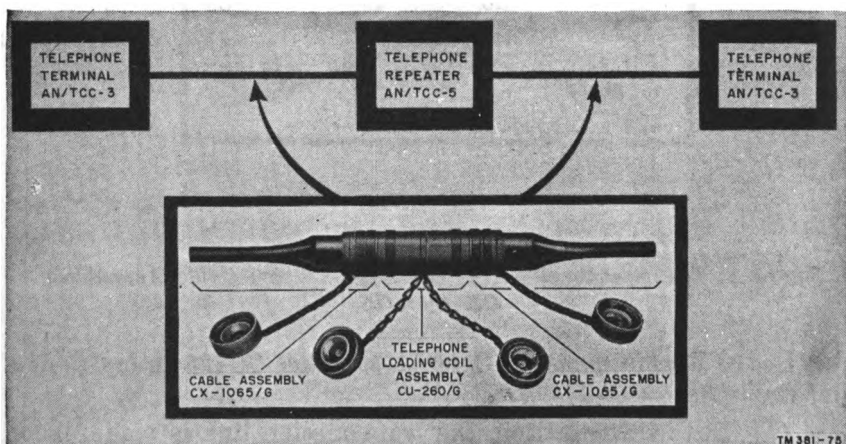

Figure 2. Four-channel AN/TCC-3 system using Cable Assemblies CX-1065/G, with Telephone Loading Coil Assembly CU-260/G connected between mating connectors.

Refer to TM 11-2142, Telephone Terminal AN/TCC-3 and Telephone Terminal AN/TCC-23, for additional information on this system.

c. Use with Twelve-Channel AN/TCC-7 System.

- (1) When used with the twelve-channel AN/TCC-7 system, the transmission line is made up of Cable Assemblies CX-1065/G. *Loading coils must not be used with this system.*
- (2) Telephone Cable Assembly CX-1606/G is used to span short distances in the transmission line.
- (3) Telephone Cable Assembly CX-1512/U is used when performing tests on the equipment and on the cable line.
- (4) Telephone Terminal AN/TCC-7 and Telephone Repeaters AN/TCC-8 and AN/TCC-11 are equipped with connector receptacles to mate with the universal connectors on the cable assemblies. Refer to TM 11-2150, Telephone Carrier Systems Using Telephone Terminal AN/TCC-7, Telephone Repeater AN/TCC-8 (AN/TCC-21), Telephone Repeater AN/TCC-11, and Telephone Test Set TS-712/TCC-11.

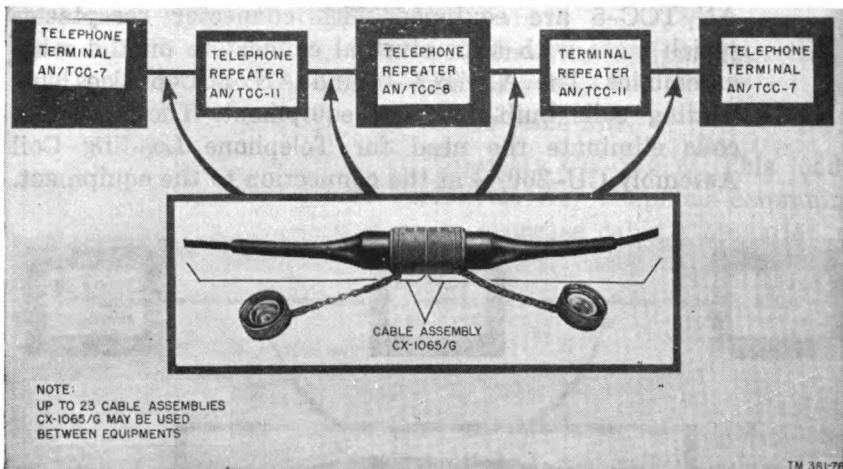

Figure 3. Twelve-channel AN/TCC-7 system using Cable Assemblies CX-1065/G.

d. Use as Replacement for Cable Assemblies CC-358 and CC-368 and Cable Stub CC-356.

- (1) In this application, the transmission line is made up of Cable Assemblies CX-1065/G with Telephone Loading Coil Assembly CU-260/G connected between the mating connectors of Cable Assemblies CX-1065/G (fig. 2).

This arrangement replaces Cable Assembly CC-358 which has the loading coils built into the connectors.

- (2) Telephone Cable Assembly CX-1606/G replaces Cable Assembly CC-368 for spanning short distances in the transmission line.
- (3) Telephone Cable Assembly CX-1512/U replaces Cable Stub CC-356 for making connections to the equipment provided with binding posts.
- (4) Telephone Loading Coil Assembly CU-260/G must be inserted between the last CX-1065/G and the equipment because the equipments do not have built-in loading coils.

Notes. Only complete sections of the transmission line between stations may be replaced because the characteristics of Telephone Cable WF-8/G are different from the characteristics of the cable it replaces.

5. Description of Telephone Cable WF-8/G (fig. 4)

Telephone Cable WF-8/G consists of four stranded-copper conductors separately insulated with polyethylene and spiraled around a polyethylene core. One pair of conductors is insulated with colored polyethylene and the other pair with natural polyethylene. The spiraled conductors are covered by an inner jacket of polyethylene, a carbon-cloth stabilizing tape, a steel braid, and a thermoplastic outer jacket. The steel braid provides the tensile strength for the cable, and permits the use of the cable of self-supported aerial cable lines. Telephone Cable WF-8/G is issued *only* as part of Cable Assembly CX-1065/G and as part of Telephone Cable Assemblies CX-1606/G and CX-1512/U.

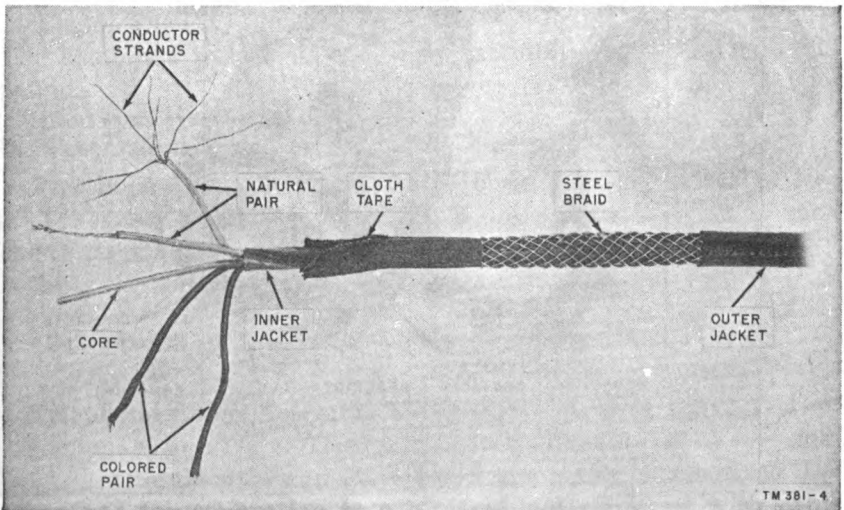

Figure 4. Telephone Cable WF-8/G, construction details.

6. Description of Universal Connector

a. The universal connector allows the connection of any two assemblies without lengthwise orientation of the assemblies. This means that proper continuity is maintained from one assembly to the next when their universal connectors are joined. The universal connector provides a high-quality, waterproof, electrical circuit connection. No tools are required to join two connectors.

b. Figure 5 shows the important parts of the universal connector. The male and the female contacts are imbedded in the rubber compound which acts as an insulator for the contacts. The male contacts are spaced further apart than the female contacts to insure a good contact when the male contacts are inserted into the female contacts of a mating connector. The female contacts are split for the same reason. The sealing lip of one connector bears against the sealing lip of a mating connector and forms a watertight seal around the contacts. The segments of one connector fit into the segments of a mating con-

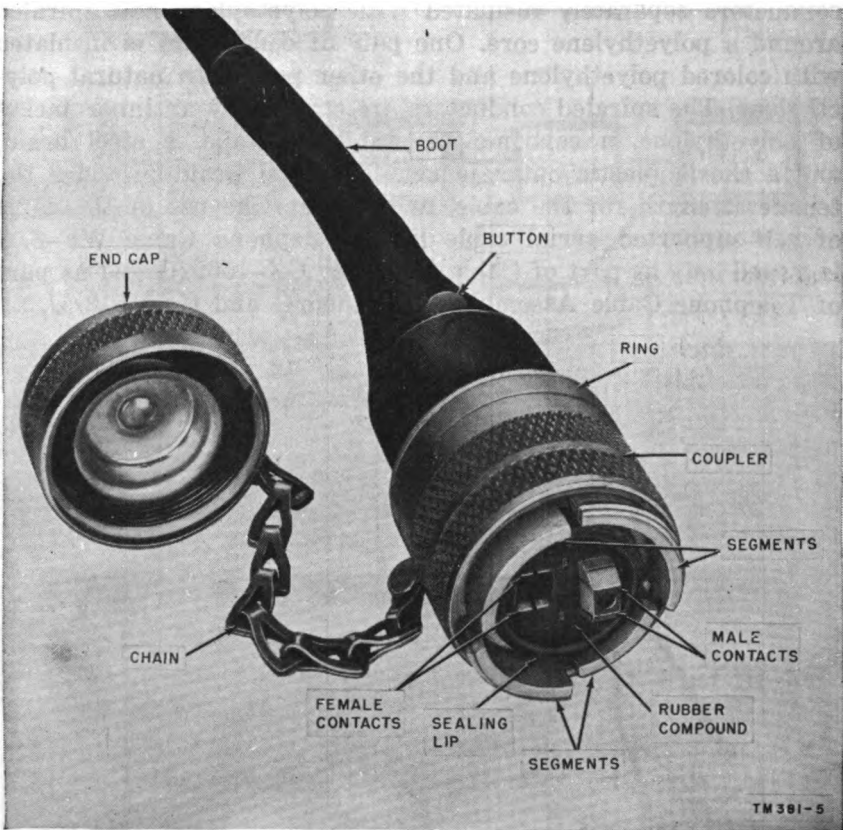

Figure 5. Universal connector.

ector and prevent twisting of the connectors when the connectors are being tightened. The coupler is threaded on the inside to engage threads on the segments of a mating connector. By twisting the coupler onto the segments of a mating connector, the connectors are drawn to each other and a tight seal is formed between the connectors. The outside of the coupler either may have knurls or flat surfaces for gripping purposes. The end cap protects the connector face when the connector is not in use. A short chain attaches the end cap to the ring on the coupler. The ring is free to rotate around the coupler to enable the end cap to be tightened. The boot prevents sharp bends from being made in the cable near the connector. These sharp bends would cause damage to the inner parts of the connector. The button on the boot is used to line up the contacts of the connector with the contacts of a mating connector (par. 14).

Caution: Always keep the end cap screwed onto the connector when the connector is not in use to protect the connector face from moisture, dirt, and damage.

7. Description of Cable Assembly CX-1065/G (fig. 6)

Cable Assembly CX-1065/G consists of an approximate one-quarter (1,280 to 1,360 feet) of Telephone Cable WF-8/G with a universal connector at each end. The exact length is stamped on a metal band attached to the cable near each universal connector. A pair of conductors is connected between the male contacts of the connector on one end of the assembly and the female contacts of the connector on the opposite end of the assembly. The steel braid is connected to the connector case at each end. The CX-1065/G is furnished on Reel DR-15-B (fig. 7). The combined weight of the cable assembly and the reel is 135 pounds.

8. Description of Telephone Cable Assembly CX-1606/G

Telephone Cable Assembly CX-1606/G consists of 100 feet of Telephone Cable WF-8/G with a universal connector at each end. Except for the length, the construction of this cable assembly is the same as for Cable Assembly CX-1065/G (par. 7).

9. Description of Telephone Cable Assembly CX-1512/U (fig. 8)

Telephone Cable Assembly CX-1512/U consists of 12 feet of Telephone Cable WF-8/G with a universal connector at one end. The four conductors and steel braid are made available at the other end for connection to equipment not equipped with cable

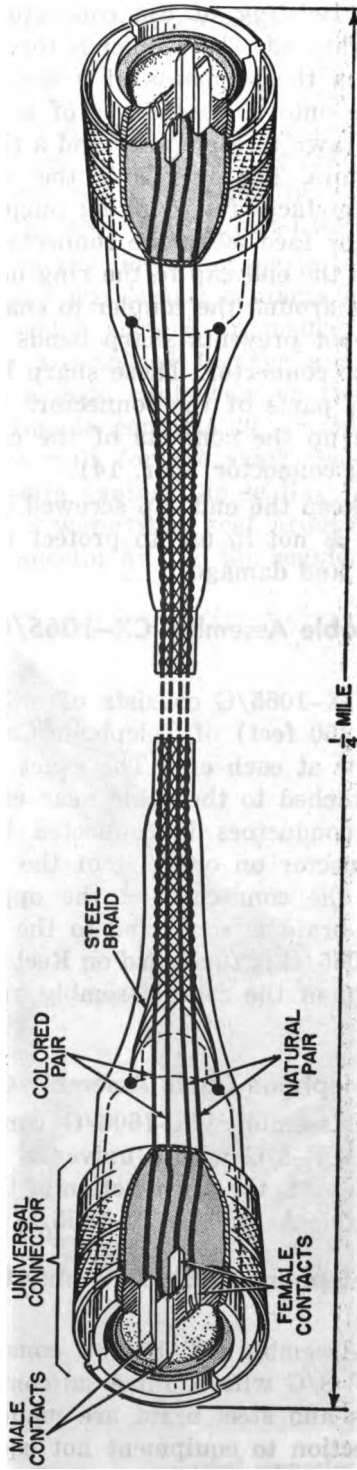

TM 38-77

Figure 6. Cable Assembly CX-1065/G, cutaway view.

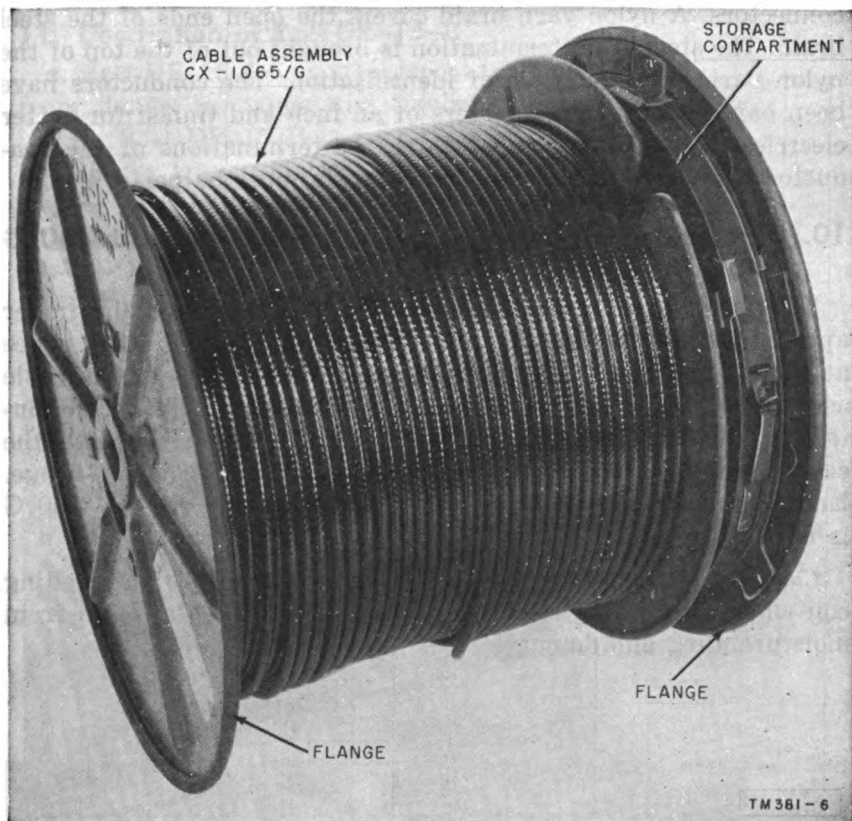

Figure 7. Cable Assembly CX-1065/G, wound on Reel DR-15-B.

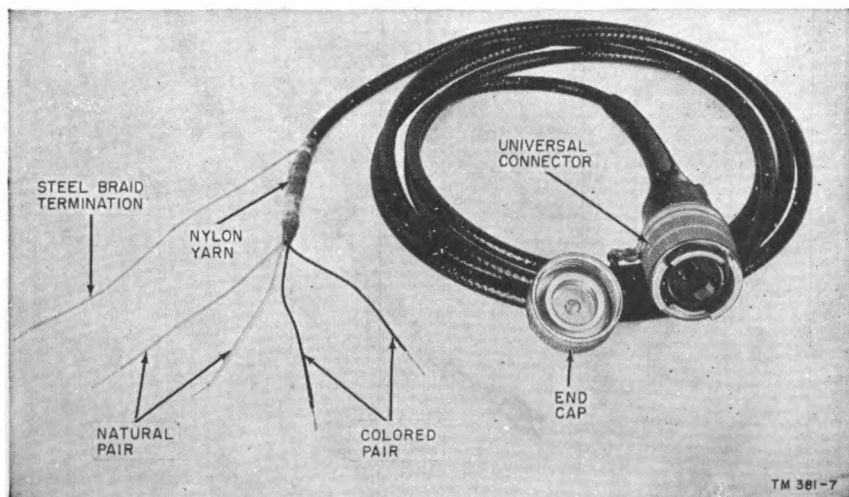

Figure 8. Telephone Cable Assembly CX-1512/U.

connectors. A nylon yarn braid covers the open ends of the steel braid. The steel braid termination is brought out of the top of the nylon yarn braid for ease of identification. The conductors have been bared about three-quarters of an inch and tinned for better electrical connection. To determine the terminations of the conductors in the connector, continuity tests must be performed.

10. Description of Telephone Loading Coil Assembly CU-260/G (fig. 9)

Telephone Loading Coil Assembly CU-260/G is a metal cylinder approximately 5 inches long and 2 inches in diameter with a face at each end for connecting the universal connectors of the cable assemblies. The assembly weighs 2 pounds. The loading coil contains a pair of 6-millihenry loading coils which decrease the cable attenuation in the 0- to 20-kilocycle (kc) frequency range. End caps are provided to protect the faces when the CU-260/G is not in use.

Caution: Always keep the end caps screwed onto the loading coil when the loading coil is not in use to protect the faces from moisture, dirt, and damage.

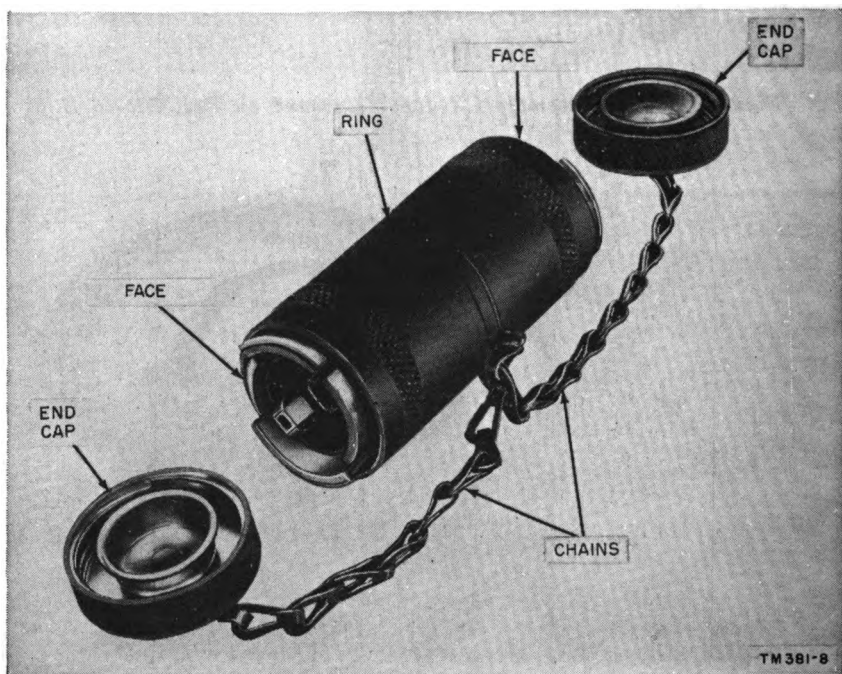

Figure 9. Telephone Loading Coil Assembly CU-260/G.

11. Description of Reel DR-15-B

a. Reel DR-15-B is a steel, spool-type container 18-inches wide from flange to flange and having a flange diameter of $19\frac{1}{4}$ inches. Reel DR-15-B is used to hold one Cable Assembly CX-1065/G for transportation, storage, or laying purposes. The reel weighs 38 pounds without the cable and fits on a 1-inch square axle. Reel DR-15-B can be used with Reel Units RL-31, RL-31-B, RL-31-C, RL-26-A, RL-26-B, RL-26-C, and RL-118/G.

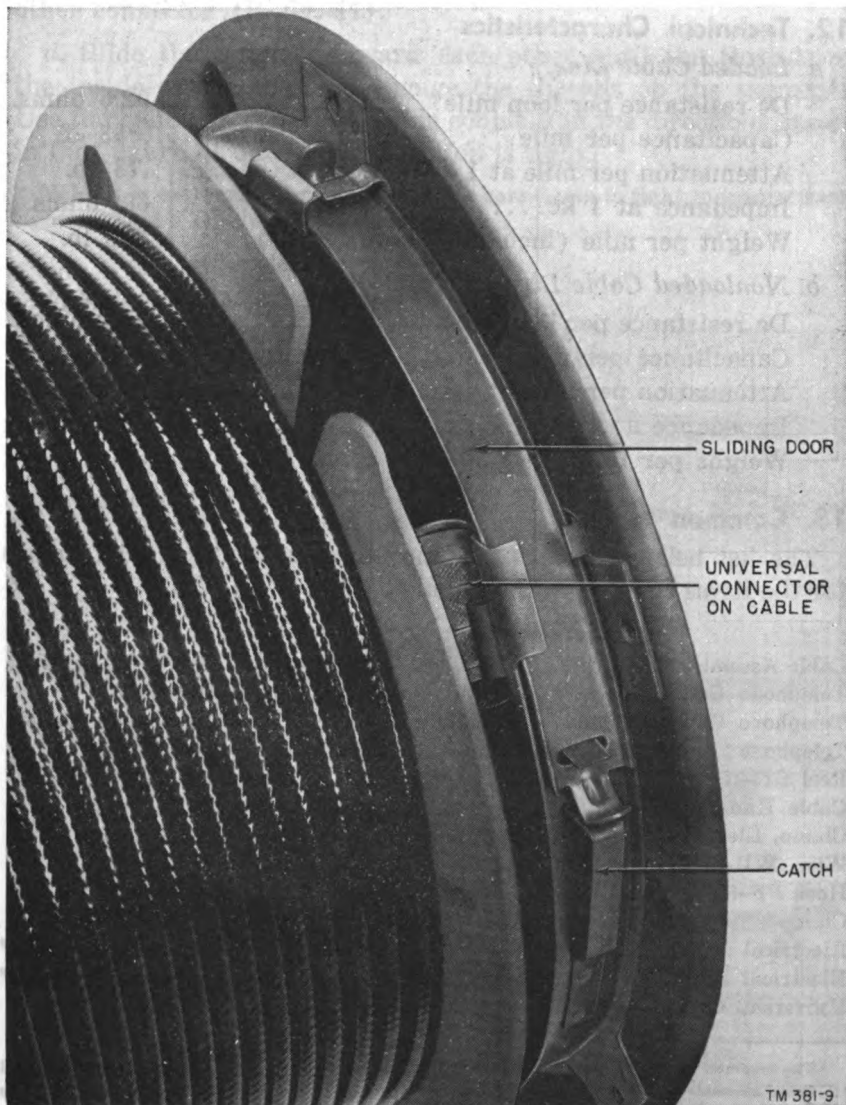

Figure 10. Reel DR-15-B, storage compartment shown with sliding door closed.

b. A storage compartment equipped with a sliding door (fig. 10) is provided to hold both connectors and about 12 feet of the inner end of the cable. This compartment protects the connectors from damage, and makes both ends of the cable available for testing. The door is opened by depressing the catch and sliding the door backward.

Caution: Be sure to put the connectors inside the compartment and close the compartment door before moving a reel.

12. Technical Characteristics

a. Loaded Cable Line.

Dc resistance per loop mile.....	92.6 ohms.
Capacitance per mile.....	.083 μ f.
Attenuation per mile at 1 kc and 68° F.....	.73 db.
Impedance at 1 kc.....	600 ohms.
Weight per mile (including loading coils).....	398 lb.

b. Nonloaded Cable Line.

Dc resistance per loop mile.....	86.6 ohms.
Capacitance per mile.....	.083 μ f.
Attenuation per mile at 1 kc and 68° F.....	1.25 db.
Impedance at 1 kc.....	400 ohms.
Weight per mile.....	390 lb.

13. Common Names

The list below contains the nomenclature and common names for the items covered in this manual.

Nomenclature	Common name
Cable Assembly CX-1065/G.....	spiral-four cable ¹
Telephone Cable Assembly CX-1606/G.....	cable stub
Telephone Cable Assembly CX-1512/U.....	spiral-four cable ¹
Telephone Loading Coil Assembly CU-260/G.....	loading coil
Reel DR-15-B.....	reel
Cable Hanger PF-203/G.....	cable hanger
Clamp, Electrical Conductor, Strain PF-211 ()/G.....	cable clamp
Wire WD-1/TT.....	field wire
Hook PF-81.....	drive hook
Clamp PF-61.....	strand clamp
Electrical Insulation Tape TL-636 ()/U.....	polyethylene tape ²
Electrical Insulation Tape TL-600/U.....	polyethylene tape ²
Universal Connector.....	connector

¹ The common name *spiral-four cable* is used when reference is made to a combination or all of these assemblies. The type number, such as CX-1065/G, is used when reference is made to a particular assembly.

² The common name *polyethylene tape* is used when reference is made to either tape. The type number, such as TL-600/U, is used when reference is made to a particular tape.

Section III. INTERCONNECTION OF ASSEMBLIES

14. Procedure for Joining Connectors

a. Remove the end caps from the connectors.

b. Grasp one connector in each hand with the thumb over the button on the boot (A, fig. 11) and line up the buttons.

c. Push the connectors together firmly until the segments on one connector fit into the spaces between the segments of the other connector (B, fig. 11).

d. Slide the couplers toward each other until the threads on the inside of the couplers engage the threads on the segments. Use the hands only, and twist the couplers in the directions shown in C of figure 11 until the connection is tight.

Note. It is extremely important that the connection is tight to insure water tightness and a good electrical connection.

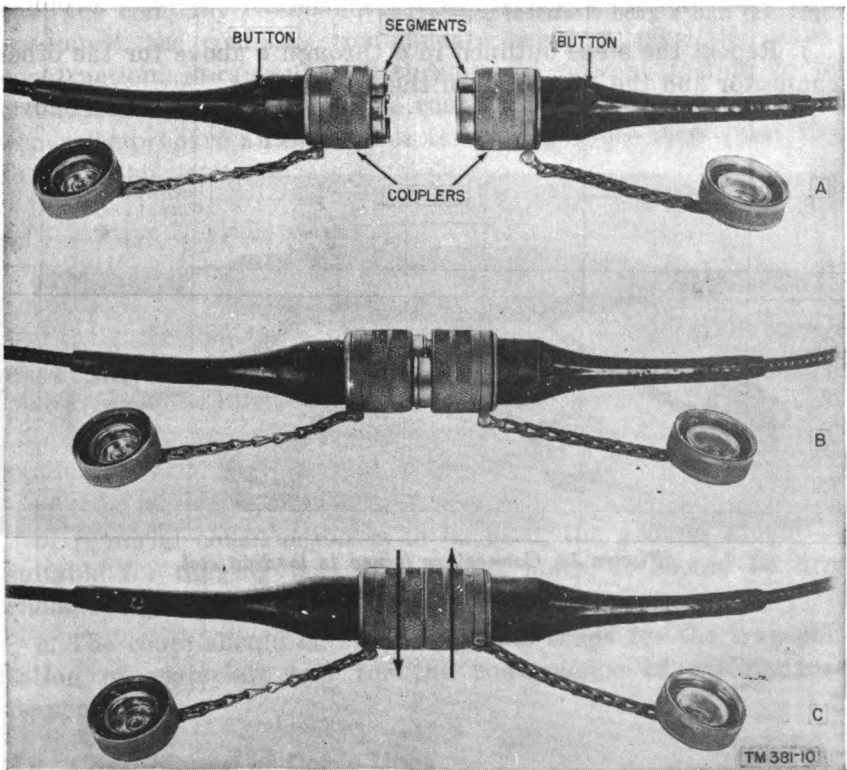

Figure 11. Joining connectors.

15. Procedure for Joining Connector and Loading Coil

- a. Remove the end caps from the connector and the loading coil.
 - b. Hold the connector in one hand and the loading coil in the other hand with the connector face and one loading coil face toward each other.
 - c. Place the connector face and the loading coil face together so that the male contacts of the loading coil are opposite the female contacts of the connector and the female contacts of the loading coil are opposite the male contacts of the connector.
 - d. Push the connector and the loading coil together until the segments on the loading coil fit into the spaces between the segments on the connector.
 - e. Slide the coupler toward the loading coil until the threads on the inside of the coupler engage the threads on the loading coil. Use the hands only, and twist the coupler onto the loading coil until the connection is tight (fig. 12).
- Note.* It is extremely important that the connection is tight to insure water tightness and a good electrical connection.
- f. Repeat the steps outlined in a through e above for the other connector and the other side of the loading coil.

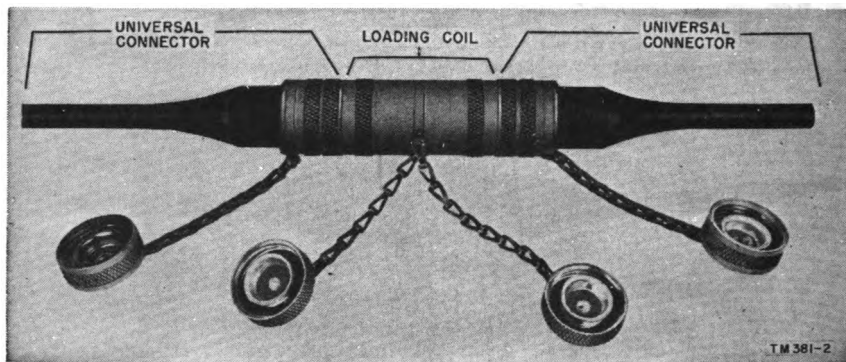

Figure 12. Connectors joined to loading coil.

CHAPTER 2

ROUTE PLANNING

Section I. ROUTE PLANNING CONSIDERATIONS

16. General Procedure

The preliminary requirements for cable construction projects are usually determined by a higher headquarters which will order the construction of the specific circuits. The orders are acted upon by the operations officer of the battalion assigned the project. The operations officer usually prepares a work order which includes a proposed line route map. The operations officer, along with the company commanders, may make a visual reconnaissance of the area by vehicle if time permits. The reconnaissance will enable the operations officer to realize some of the problems that the company commanders will encounter. After the reconnaissance, the company commanders begin to plan the actual construction. Paragraphs 17 through 20 present factors to be considered in planning the line route. The company commanders generally prepare an overlay or temporary route map (par. 21) to aid the survey team.

17. Terrain Considerations

The characteristics of the existing terrain are important considerations in determining the type of construction to be used and the route that the cable line will take. In planning the layout of the cable system, the construction officer should consider the factors outlined in *a* through *c* below.

a. Forests, swamps, jungles, very rocky ground, ravines, steep grades, or large streams, add to the difficulty of construction and should be avoided as much as possible.

b. If aerial construction is to be used, the ground should be suitable for digging pole and anchor holes. It should be firm enough to give good support.

c. The route should be accessible from roads for the transportation of materials and for the convenience of maintenance personnel.

18. Concealment of Cable Lines

If the tactical situation requires the concealment of the cable line, choose a route that offers the best concealment from aerial

observation. Woodland, the edge of forests, defiles, and similar places, offer good concealment for the cable line and for construction and maintenance personnel. Surface and buried cable lines are easier to conceal than are aerial cable lines. After the cable line has been constructed, go over the route and eliminate signs of construction that might reveal the location of the route when viewed from the air.

19. Routing Line to Avoid Hazards

a. Routing Line at Roadways. Roadways provide a convenient route along which to construct the cable line; however, such lines are subject to frequent damage by vehicles leaving the road and by air attacks on supply routes. To reduce the possibility of damage to such lines, construct the cable line at least 100 yards from the road. At road crossings, place crossing poles at least 10 feet from the usable road shoulder.

b. Routing in Active Friendly Areas. Probably the most frequent cause of cable-line trouble is damage by friendly vehicles and personnel. In areas of great activity, lines often are knocked down accidentally, run over, and otherwise mistreated. Spiral-four cable will take a reasonable amount of abuse, but it cannot withstand being run over repeatedly by heavy vehicles or machines. To maintain uninterrupted service, route the through lines so that supply depots, bivouac areas, repair stations, and concentration areas will be avoided. Use aerial or underground construction to cross roads or other routes to such areas. Avoid areas where brush, grass, or forest fires are common, and areas being cleared of trees.

c. Routing Near Other Lines. When several cable lines follow the same general route, there is the danger of confusion of lines in maintenance and recovery operations. Also, the movement of men and vehicles along a route is usually heavy where several independent lines follow the same route. Therefore, cable lines should be grouped in an orderly arrangement in a given route, or kept well separated.

d. Routing Near Power Lines. Where cable lines must run parallel to power lines, construct the cable line at least 100 yards from the power lines. If it is necessary to run the line closer, keep the length of parallel line as short as possible. *Do not attach cable lines to poles that carry power lines.*

20. Comparable Features of Surface, Buried, and Aerial Cable Lines

The chart below outlines the most apparent advantages and disadvantages of the three types of cable lines. This chart will

aid in determining the type of construction best suited to the situation.

Type of line	Advantages	Disadvantages
Surface.....	<p>Easiest to install.....</p> <p>Fastest to install.....</p> <p>Easy to maintain and repair.</p>	<p>Subject to damage by vehicles, fires, weapons, and personnel.</p> <p>Affected by temperature changes.</p>
Buried.....	<p>Less subject to damage than ground surface lines or aerial lines.</p> <p>Less affected by temperature changes.</p>	<p>Most difficult to maintain and repair.</p> <p>Takes more time to construct than surface lines.</p> <p>Difficult to recover.</p>
Aerial.....	<p>Less subject to damage than surface lines.</p> <p>Easy to maintain.....</p>	<p>Take more time to construct than surface lines.</p> <p>Affected by temperature changes.</p>

21. Preparation of Temporary Line Route Map

After the factors mentioned in paragraphs 17 through 20 have been considered, an overlay or temporary line route map should be prepared by the company commanders to indicate the general features of the proposed route. This temporary line route map (fig. 13) with any necessary added directions is given to the survey party. Typical items shown are the origin and destination of the line, the type of construction (whether surface, aerial, or buried), the approximate route, the test points, and the terminal and repeater locations.

Section II. SURVEYING ROUTE

22. General Procedure

a. General. After the advanced planning has been completed, the construction officer and his key personnel should perform a detailed survey of the route. The route survey reveals necessary changes in the advance planning, establishes the most practical way of following the proposed route, provides a basis for completing the details of the construction plan, and sets up landmarks to guide the construction teams.

EXTRACT OVERLAY FROM LINE ROUTE MAP OF TENTH
ARMY EFFECTIVE 0100, 5 AUG 1953.

MAP: SP. MAP # 65, EUAUSIA 1952
LONSIMOS SHEET
I: 250,000

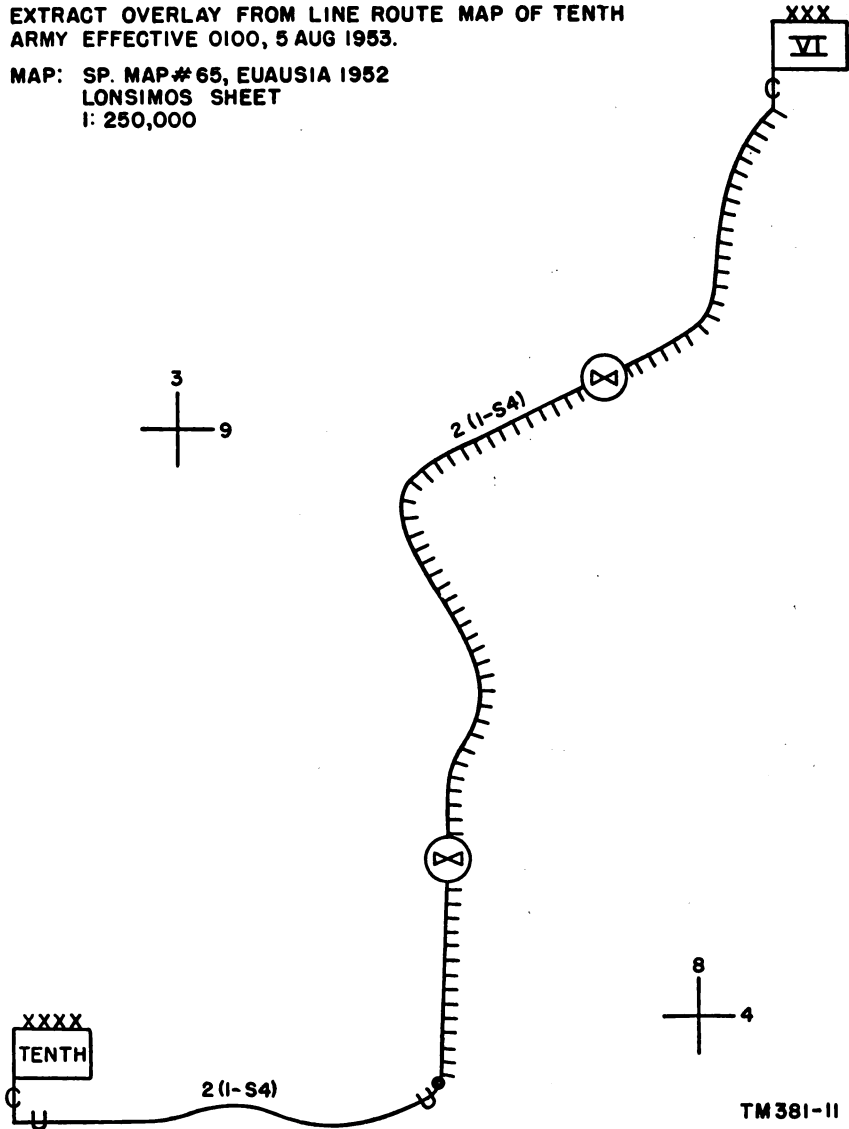

TM 381-11

Figure 13. Example of overlay of route map.

b. Performance of Survey. The route survey should be made by experienced personnel who are capable of making sound decisions regarding the details of the route and the type of construction required. Enough time should be allowed for the survey so that a thorough job can be done.

c. Completion of Line Planning. The route survey provides information that will help in the completion of the line planning.

Knowledge gained and notes taken should be in sufficient detail to provide a basis for making estimates of the materials and setting up delivery schedules, for solving special construction problems, and for organizing the personnel and equipment required for the project.

23. Survey Party and Equipment

a. Survey Party. The survey party should consist of at least four men who are experienced in line planning and construction. One of the men should be available later to act as a guide for the layout team (if the layout is not performed by the survey party) and for the construction team. This man should have a thorough knowledge of grading, guying, clearances, and other general requirements for the construction of spiral-four cable lines.

b. Survey Equipment. The equipment required by the survey party depends mainly upon the nature of terrain and prevailing conditions under which the detailed survey is made. The items listed in the chart below indicate the requirements of the average survey party, which consists of four men.

Item	Quantity per party
Axe LC-1 -----	1
Axe LC-36 -----	1
Belt LC-23 -----	1
Climbers LC-240, lineman's -----	1
Compass I-1 -----	1
Flashlight TL-122 -----	1
Gloves LC-10, leather (average size) -----	4
Hook LC-21: brush- or bush-cutting knife -----	1
Knife TL-29 -----	1
Notebook and pencil -----	2
Pliers TL-13 (or equal) -----	1
Rule: folding: 6-ft -----	1
Wooden stakes for each mile of line -----	50
Cable Marker MX-892/G, Cable Marker MX-893/G, Cable Marker MX-894/G, or Cable Marker MX-895/G -----	50
Level: hand, w/leather case and belt loop, 5 in. long -----	1
Pole: ranging, wood, 8 ft long -----	5
Tape: measuring, band chain, steel, 300 ft -----	1
Cloth: cotton, wiping -----	8
Crayon: lumberman, 4 in. black -----	12

24. Duties of Survey Party

The survey party performs the following duties:

a. Selects the most favorable route for the line, considering the factors given in paragraphs 17 through 20.

- b.* Clears away shrubs and other minor obstructions.
- c.* Observes and records landmarks, locations, and compass directions; checks unusual terrain and geological formations.
- d.* Takes notes of important findings (par. 25) to be used by the layout and construction teams.
- e.* Designates the route with visible marks such as driven stakes, rock piles, and tree blazes (par. 26).
- f.* Marks the location of pole and anchor holes if layout is not performed by a separate layout team.
- g.* Measures the route with reasonable accuracy by placing stakes that show the distance to some reference point.

25. Notes Taken During Survey

a. The survey party should take detailed notes during the survey. These notes serve the following purposes:

- (1) Ascertain that all factors revealed by the survey are available for consideration in the detailed planning.
- (2) Supply information necessary to the solution of special problems which may require reference to the authority responsible for the advance plans.
- (3) Provide a record of terrain information and other data for future reference.
- (4) Assist the guide when he retraces the route to mark it for the construction team.
- (5) Provide a basis for estimating material required for construction.

b. All notes taken should be legible, complete, and understandable. Some of these notes may be suitably recorded on the line route map overlay prepared in advance planning. Such route map modifications may include detours because of unfavorable ground, or notation of points where special construction is required (fig. 14).

c. Supplement the notes with sketches. Associate the notes with landmarks, locations, and compass directions. Select and note suitable bivouac sites for construction teams.

26. Route Marking During Survey

The survey team marks the route so that it can be retraced accurately. Route markers may be of any convenient type, such as stakes and tags, tree blazes, or rock piles. The markings should be distinctive enough to be found easily and frequent enough to afford continuity. Use these markings at points where direction changes are proposed, at road or other crossing sites, at the top of hills or cliffs, and elsewhere as good judgment dictates. A good plan is to number or otherwise identify each marker as placed and to provide suitable reference in the notes. A tag at a marking point may

be used to give specific information such as compass direction and distance to the next reference point. In marking the route, keep in mind that any device used is much easier to find if it is in contrast with its surroundings, for example, a stake driven at a considerable angle with the vertical would be easier to find among saplings than one driven vertically; in stony ground a vertical stake can be seen more easily than a rock pile.

EXTRACT OVERLAY FROM LINE ROUTE MAP OF TENTH ARMY
EFFECTIVE 0100, 5 MAY 1954.

MAP: SP. MAP #65, EUASIA 1953
LONSIMOS SHEET
1: 250,000

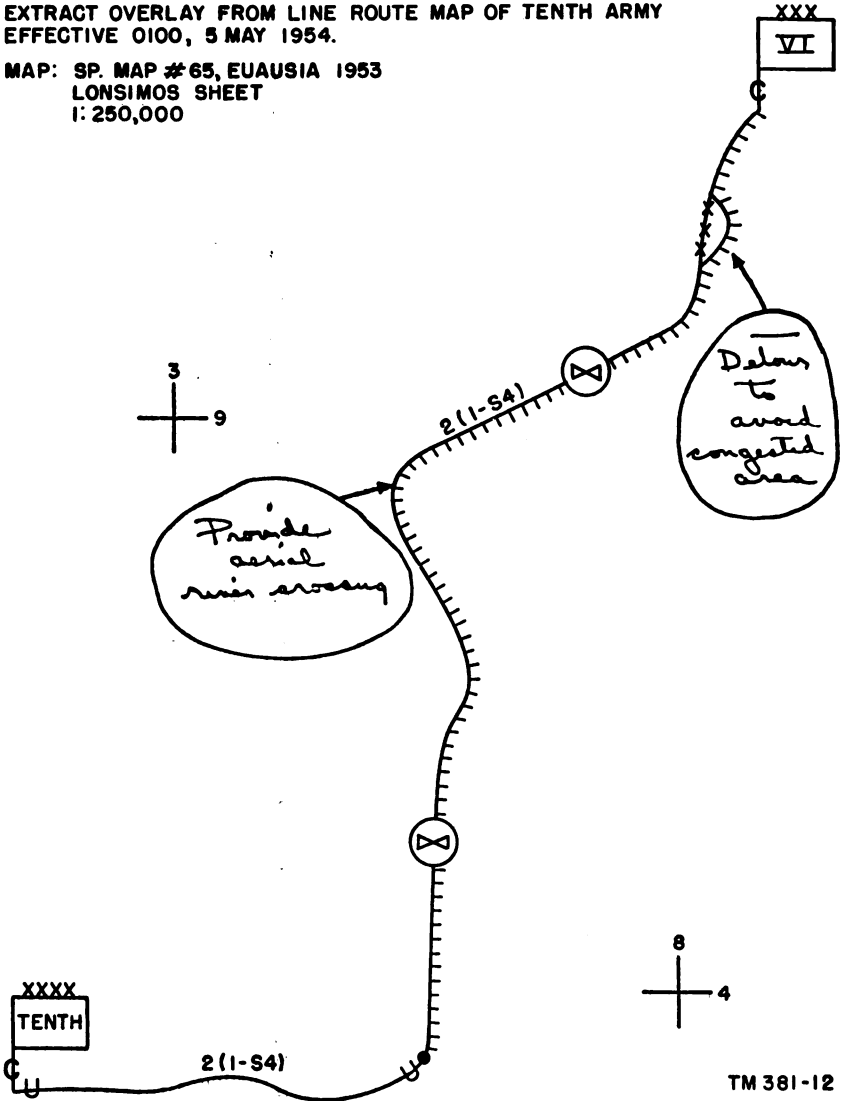

Figure 14. Overlay of line route map showing typical notes taken during survey.

CHAPTER 3

CONSTRUCTION OF CABLE LINES

Section I. ORGANIZATION OF CONSTRUCTION PROGRAM

27. General

Careful planning has an important bearing on the efficiency of the construction program. To plan a cable construction program, it is necessary to have all information concerning the route of the cable line, the materials and transportation facilities required for the construction of the line, and the personnel available for the formation of construction teams. The information on the route of the cable line is obtained from the survey party (pars. 23-26). An estimate of the materials and transportation facilities required can be made from information supplied by the survey party. Paragraphs 28 through 35 present some factors to be considered in organizing the construction program and general procedures to be followed in the construction of the cable line.

28. Estimate of Materials

Known transmission requirements and physical data taken during the survey provide a basis for completing the estimate of materials required for the line. The quantity of spiral-four cable can be estimated closely from the route mileage. An allowance of 20 percent excess is ordinarily sufficient for errors of measurement, lengths damaged during construction, and slack. Pole line and support material estimates should take into account the use of trees, existing pole lines, or other structures used to support the cable. An allowance of 10 percent in pole and support material is usually sufficient to cover measurement errors, defective or damaged material, and loss. Estimate material for special construction work separately and add it to the total.

29. Organization of Construction Personnel

To complete the construction program quickly and efficiently, the construction platoon should be divided into teams to perform specific duties. The number and type of teams will depend on the type of line construction to be used and the number of men available. Information obtained during the route survey will aid the construction officer in determining the composition of his teams.

The teams best suited for the type of construction and the equipment needed are indicated at the appropriate places in the text.

30. General Safety Precautions

Accident prevention is the responsibility of the individual soldier regardless of rank or job assignment. Use utmost caution and perform all work in a manner to avoid accidents. Be alert to recognize situations where danger exists. Report all potential safety hazards.

a. Some working conditions may be especially hazardous if proper precautions are not taken. Some examples of these safety hazards are as follows:

- (1) Power wires and equipment in the vicinity.
- (2) A large volume of vehicular traffic.
- (3) Facilities weakened by bombing, shelling, or severe weather conditions.

b. Many accidents can be avoided when lifting heavy objects by observing the following precautions:

- (1) Obtain a secure footing. Avoid awkward positions and do not spread the feet too far apart.
- (2) Bend the knees, keep the back straight, and lift by straightening the legs rather than the back.
- (3) Obtain assistance when an object is too heavy to be lifted by one person.

c. Electrocution or serious injury can be caused by improper handling of spiral-four cable used in communications systems (such as the AN/TCC-7 system) which also employ the cable for power transmission to intermediate equipment. Observe the following precautions when working with spiral-four cable used for power transmission.

- (1) Do not disconnect or handle cable connectors unless power has been removed from the cable.
- (2) Mark all cables in which power may be present.
- (3) Be careful in handling all cables in a group of cables in which one or more of the cables is carrying power.

31. Construction Team Signals

Use the standard construction team signals described in TM 11-2262, Open Wire Pole Line; Construction and Maintenance, and TM 11-2263, Lead-covered Cables; Construction and Maintenance. These signals will aid in the safe and rapid completion of the line. Use visual signals in preference to audible signals because audible signals can be misunderstood in the presence of noise or other disturbances. In the laying of the cable, a means of

communication should be provided between the driver of the vehicle and the men operating the reel in the back of the vehicle.

32. Supply of Materials During Construction

a. The supply of materials needed for the line construction must be well organized if the construction program is to proceed smoothly. Lack of materials can cause unnecessary delays.

b. A supply team or teams should be organized to keep the construction teams supplied with materials. Some materials can be distributed along the route before construction begins; other materials will have to be brought to the construction team as they are needed. The supply teams should have a sufficient number of men and vehicles to accomplish the supply procedures easily.

33. Testing Cable Assemblies

a. Before Installation. Test all cable assemblies and loading coils to be sure that they are in good condition before transporting them to the point of installation. Considerable time is lost if an installed length has to be recovered and replaced. Test each cable assembly for opens, shorts, crosses, and grounds in the conductors and opens in the steel braid. Also, measure the insulation resistance between the conductors and between each conductor and the steel braid. Perform the same tests on the loading coil except omit the test for opens in the steel braid since the loading coil does not have a steel braid. Use the procedures given in paragraphs 99 through 103.

b. During Installation. As soon as possible after an assembly is laid, the testing team should connect it to the completed section of the line and test the line back to the origin. The team laying the cable should not wait for the testing to be completed but should proceed with the laying of the next cable assembly. If trouble is found, the testing team should arrange for the replacement of the defective assembly by the laying team or a policing team. Test the cable for opens, shorts, crosses, and grounds; use the procedures given in paragraphs 104 through 109. To aid in future maintenance operations, measure and record the loop resistance from the beginning of the line to the end of each assembly added.

34. Precautions in Laying and Handling Cable

Damage to cable when laying or handling is a waste of material and time. Most instances of cable damage during installation can be traced to carelessness, inattention, or errors of judgment. Therefore, it is important that all construction personnel understand the need for constant alertness and attention to the common

sense precautions. A number of such precautions are given in *a* through *g* below.

a. Avoiding Excessive Tensions.

- (1) Avoid jerk loads or excessive pulls at all times. Vehicles from which cable is being laid should be accelerated gradually, and the reel operator should assist the starting of the reel by rotating it by hand. If there is any evidence that the cable is paying out under heavy tension, slow down or stop the vehicle immediately so that the cause of the tension can be found and eliminated.
- (2) When pulling cable by hand, never apply tension to exceed the amount one man can exert by pulling against the anchored or supported cable with one turn taken about his waist or hips. Do not use tackle blocks nor a hitch to a vehicle to tension cable.

b. Avoiding Kinks. Avoid kinking of the cable and, when kinks do occur, straighten them out by hand. Do not pull them out.

c. Precautions in Handling Reels. Do not roll reels of cable over surfaces where stumps, stones, or other hard projections may come in contact with the layers of cable on the reel. Always keep connectors inside the storage compartment on the reel (fig. 10) when moving reels. Be careful not to drop reels of cable when unloading or when removing reels from the top of stock piles or vehicles.

d. Avoiding Damage to Connectors. Always keep the end caps screwed tightly on to the cable assemblies and loading coils until ready to make connections. When connections are broken, unless tests are being made, clean the end caps thoroughly and replace.

e. Avoiding Sharp Edges and Projections. Do not pull spiral-four cable across sharp edges or corners. Take particular care to avoid pulling the cable across reel flanges, or parts of the laying vehicle and equipment.

f. Avoiding Crushing of Cable. The cable may be crushed if hard or heavy objects fall upon it, if vehicles are driven over it, or if other materials are dragged or rolled over it. Do not throw tools or empty reels where they may strike the cable. Avoid driving vehicles over cable, particularly on hard or stony ground.

g. Precautions When Using Digging Tools. When working near cable with digging tools, be careful not to strike the cable. In shoveling around or over buried cable, use a scooping rather than a digging motion. In that way, if the shovel comes in contact with the cable, it will tend to slide along rather than to cut into the cable.

35. Identification of Cables

Place a tag at the far-end connector of each length of cable, showing the line identification number, the assembly identification number of the cable assembly in the line and, if the information is available, the actual length of the cable assembly. If the cable line is to be used to supply power, include a warning to that effect on the tag. Start the assembly identification numbering system at the origin of the line. If more than one laying team is working along a given route, a specially assigned team or a policing team should go over the entire line to provide a continuous series of cable assembly numbers. This numbering is important for maintenance and testing purposes. Tag the cable at points where it connects to terminal or repeater equipment, where it crosses other cables, where underground construction begins and ends, and at frequent intervals where it parallels other cables closely. Use Cable Marker MX-892/G, MX-893/G, MX-894/G, or MX-895/G as authorized by higher authorities. Do not use markings on the tags which would disclose strategic information.

Section II. CONSTRUCTION OF SURFACE CABLE LINES

36. General Procedure

a. Construction of a cable line on the ground surface involves laying spiral-four cable from a reel on a truck, or by hand. In either case, the methods are much the same as those used for field wire. (Refer to FM 24-20, Field Wire Technique, for details on laying field wire.)

b. A typical supply of Cable Assemblies CX-1065/G contains lengths longer than the nominal length of 1,320 feet. To facilitate the replacement of a defective CX-1065/G, select some of these longer lengths (par. 7) before starting construction and hold them for this purpose.

37. Speed of Laying Cable

Rapid laying of spiral-four cable is often of utmost importance. Under favorable conditions, truck speeds of 15 miles per hour (mph) or more are possible. At truck speeds of 15 mph Reel DR-15-B will be making 5 or more revolutions per second. At such reel speeds, a slight mishap or an unexpected snarl may damage the cable, causing a loss of time and material.

38. Personnel and Equipment Required for Laying Cable

a. *Duties of Construction Personnel.* Under favorable conditions, the construction teams described in this paragraph can lay up to 5

miles of cable per hour. Where need for the line is urgent, several construction teams can work simultaneously by dividing the line into sections, each team constructing a section. The makeup of a construction team as suggested in this paragraph is variable. Men and equipment may be added or the composition of the teams varied. If, for example, a cable route involves an unusually large number of road and highway crossings, it may be necessary to use additional advance construction and policing teams. The suggested team personnel in each case includes a team leader and a driver. Suitable vehicles are indicated, but other types having approximately equivalent capability may be used. Ground conditions more difficult than usual may require substitution of vehicles better adapted to the particular conditions.

b. Construction Personnel and Equipment.

Type of construction team	Number of men	Equipment
Advance construction team.	6	1 Truck V-17/MTQ.
Laying team -----	6	1 truck, 2½ ton cargo equipped with winch and Reel Unit RL-26-(), RL-31-(), or RL-118/G.
Testing team -----	2 (2 extra men at origin of line, if wire chief is not available).	1 truck, ¼ ton 4 x 4.
Policing team -----	6	1 Truck V-17/MTQ.
Supply team -----	5	1 truck, 2½ ton cargo.

39. Procedures for Laying Cable

Caution: To avoid damage to the connector, always keep the end caps screwed onto the connector until ready to join two assemblies.

a. Laying Cable Using Vehicle. The general steps for laying and connecting the cable are as follows:

- (1) Load the cable-laying truck (2½-ton cargo) with approximately 20 reels of CX-1065/G. If the cable line is to be loaded, include one loading coil for each CX-1065/G.
- (2) Place a reel of cable on the reel unit (RL-26-(), RL-31-(), or RL-118/G).
- (3) Open the storage compartment on the reel and remove the outer end of the cable. Close and latch the sliding door on the storage compartment before unreeling any cable.

- (4) Unreel the end of the cable and fasten it to a stake, pole, or tree (par. 40). Leave enough cable beyond the point of attachment to reach the terminal or repeater equipment. Where two cable assemblies join, leave about 20 feet of slack.
- (5) Lay the cable straight from the back of the truck. *Start the truck slowly and accelerate gradually.* Start the reel by hand to avoid jerking the cable. As the truck advances, control the rotation of the cable reel so that the cable is payed out under light, steady tension. This is done with the reel brake if one is provided, or by braking on the reel flanges with a flat piece of wood or a well-gloved hand. Excessive slack causes kinking of the cable; overrunning may cause a tangle on the reel. Sudden or excessive braking causes serious harm even if it is not sufficient to cause an actual cable break. Guide the cable off the reel so that it will not catch on the storage compartment on the reel.
- (6) Signal the driver to slow down as the bottom layer of cable starts to unwind. Signal the driver to stop the truck while there are still a few turns of cable on the reel.
- (7) Unreel the remaining cable by hand, open the sliding door on the storage compartment on the reel, and remove the inner end of the cable.
- (8) Repeat (1) through (7) above for each assembly to be laid.

b. Laying Cable by Hand.

- (1) Spiral-four cable is payed out by hand in terrain where motor vehicles cannot travel. Reel Cart RL-35 may be useful under such circumstances. It is possible for two men to carry Reel DR-15-B on the axle of a reel cart or reel unit. The cable cannot be payed off the reel easily, however, because the axle is square. Rope slings placed in the round sections of the shaft and used as handles may help to overcome this difficulty. Where feasible, cable can be payed out by carrying Reel DR-15-B in Reel Unit RL-31 in stretcher fashion.
- (2) Another method is to remove the entire length of cable from a reel and lay it in three or four piles of figure 8's, each of a reasonable size and weight for one man to carry. The last man in a file carrying the piles of cable pays his cable out first, the man just ahead then starts to pay out his cable, and so on, until the entire length is laid. The advantage of the figure 8 piling is that cable can

be laid and payed out in this manner without twisting the cable.

- (3) Cable may be hand laid by dragging it over a route. In this method, the first man grips the end of the cable and draws out as much cable as he can handle. The second man then grips the cable near the reel and draws out the cable, keeping a small amount of slack ahead of him. The process is repeated until all the cable is drawn out. Excessive tensions are avoided by each man maintaining the slack. If the cable snags, stop the file and release the snag.

c. Laying Cable at Overhead Crossings.

- (1) *For self-supported cable.* Unreel enough cable at the first support (called the near pole) to allow for the vertical runs on the supports at both sides of the crossing. Be sure to provide enough slack to permit easy handling of the cable. After the slack is unreeled, tie the cable temporarily to the base of the support so that it will not be drawn out as the laying truck moves along.
- (2) *For messenger-supported cable.* Unreel enough cable at the near pole to allow for the crossing span, plus the vertical run at the near pole. The truck proceeds across and beyond the crossing as described in (1) above.

Caution: Do not place connectors in aerial spans crossing highways or other traffic routes. In some cases, the cable remaining on the reel may be too short to complete the crossing span. Coil the remainder of this cable assembly at the base of the near pole. Join on a new length, allow the usual slack for the crossing, and proceed as described in (1) and (2) above. Fasten the extra slack with lashings so that it will not become disarranged.

d. Laying Cable in Swampy Ground and in Water.

- (1) *In swampy ground.* In crossing swampy ground, it may be necessary to carry the cable in by hand (*b* above) or to pull the cable into place as described in (3) below. If possible, support the connectors above water or muck level. *Be sure that the end caps are in place on the connectors when the cable is to be carried through mud or muck.*
- (2) *In water.* In crossing streams or other bodies of water, it frequently will be possible to lay the cable on the bottom. The cable usually may be laid safely on the bottom, if there is little or no flow of water, and if there are no hazards due to navigation or sharp stones. If there is an

appreciable current flow with good bottom and otherwise satisfactory conditions, the cable may be held in place by tying weights to cable hangers attached at suitable intervals. Avoid locations where vehicles cross or animals wade. *If possible, do not place connectors under water.* The connection made by joining two universal connectors is watertight; however, placing connectors under water makes testing, maintenance, and replacement difficult. Place anchorages (par. 40) in both directions on both sides of the crossing near the point where the cable enters the water. If necessary, provide a trench where the cable enters the water.

- (3) *Procedure.* When laying the cable in shallow water, it may be possible to go across with the truck and lay the cable as on the ground surface. If the water is deep and the crossing narrow, the cable may be pulled across using the method described in (a) through (d) below. If the crossing is not narrow, use the procedures given in TB SIG 67, Laying Field Cable Under Water.
- (a) Connect a cable stub or an equivalent stub to the connector of the cable assembly to be pulled. (The equivalent stub may be the end removed from a damaged cable assembly but with an undamaged connector.)
 - (b) Tape the end caps to the connector so that they will not snag.
 - (c) Attach a cable clamp to the cable stub.
 - (d) Attach the towing line to the bail (fig. 15) of the cable clamp and draw the cable across. If excess strain occurs, the bail will break and protect the cable assembly since the bail is designed to break at less than the breaking strength of the cable.

Caution: Whenever the cable is pulled or placed under tension, the cable never should be bent sharply to apply the tension. Always apply tension to the cable by the attachment of a cable stub, or equivalent, and a cable clamp, or by wrapping the cable around the body in such a manner as to avoid sharp bends or kinks in the cable.

40. Fastening Cable to Anchorages

- a. The cable laying, testing, and policing teams should be equipped with a supply of stakes, cable clamps, field wire or marline, and tools for driving stakes.
- b. The anchorages used may be stakes, trees, or any other de-

vice that is strong enough to withstand the expected pull. Drive stakes well into the ground. For maximum holding power, slant the stake slightly toward the expected pull, not away from it.

c. Attach the cable to the anchorage with cable clamps (fig. 15). Basket hitches (par. 41) may be used if cable clamps are not available. If it is not possible to loop the bail of the cable clamp over the anchorage, use a piece of field wire or marline to attach the bail to the anchorage. Be sure that the cable clamp or basket hitch is applied to the cable so that it will resist a pull on the cable. If the pull comes from both directions, use a cable clamp in each direction.

d. Cable laid on level ground in a reasonably straight line ordinarily does not need to be tied to stakes or other anchorages, except possibly at connector points. Even at connector points, the required slack can be provided by overlapping and lashing the cable assemblies as shown in figure 16. If stakes are used at connector points, be sure that the attachment is placed between the slack section and the laying truck, and that the cable clamp is faced so that the slack will not be pulled out when laying is resumed.

e. At the point of any substantial change of line direction, place an anchorage outside the angle of direction change and fasten the cable to it with a cable clamp. If a stake is used, slant it toward the new direction so that the cable will tend to pull away from, not toward, the stake when laying is resumed in the new direction.

f. On steep slopes, fasten the cable to anchorages to prevent it from sliding down hill.

g. Secure the cable to an anchorage on each side of the crossing where the cable crosses deep ditches or gullies or goes through culverts or under railroad tracks.

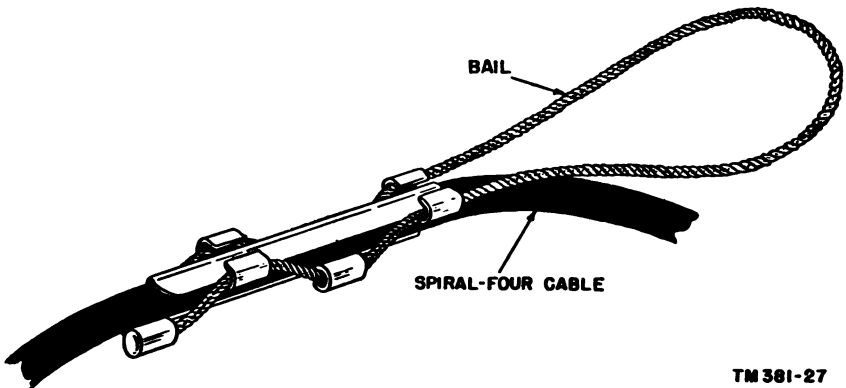

Figure 15. Cable clamp attached to spiral-four cable.

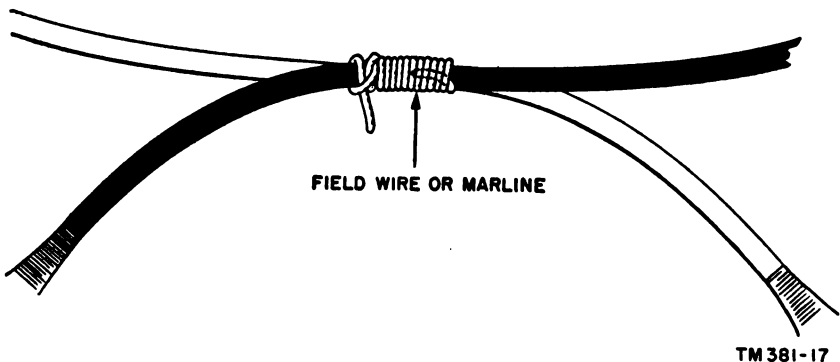

Figure 16. Lashing cable assemblies at connector points.

41. Method of Making Basket Hitch

A basket hitch (fig. 17) is the method used to attach spiral-four cable to a stake or other anchorage when cable clamps are not available. This hitch is made with one insulated conductor of field wire or with marline. Seven or eight feet of single insulated conductor ordinarily will be required to make an attachment to a stake. The basket hitch is made as follows:

a. Apply a layer of friction tape over the cable where the basket hitch is to be applied to provide a better gripping surface for the basket hitch.

b. Double the field wire to locate the center.

c. Start the attachment by making a clove hitch over the far end of the tape on the spiral-four cable.

Note. The basket hitch is always tied so that the clove hitch is toward the expected pull. If pull in two directions is expected, use two basket hitches.

d. Weave five or six crossovers of field wire onto the cable.

e. Bring the two ends together and take 2 full turns of both ends of the field wire around the anchorage.

f. Finish the hitch by taking one of the ends over the standing part of the field wire and the other one under; bring both ends around and tie them with a square knot.

42. Overhead Crossings

a. *General.* Overhead crossings are made by stringing cable between trees, poles, or other supports. Existing means of support are used if they are suitable for the purpose; otherwise, poles must be set and guyed for the purpose. If satisfactory clearances can be obtained, the cable may be strung self-supported. Refer to paragraphs 64 and 66 for clearances and span lengths. Where required clearances cannot be obtained by a self-supported span, a messen-

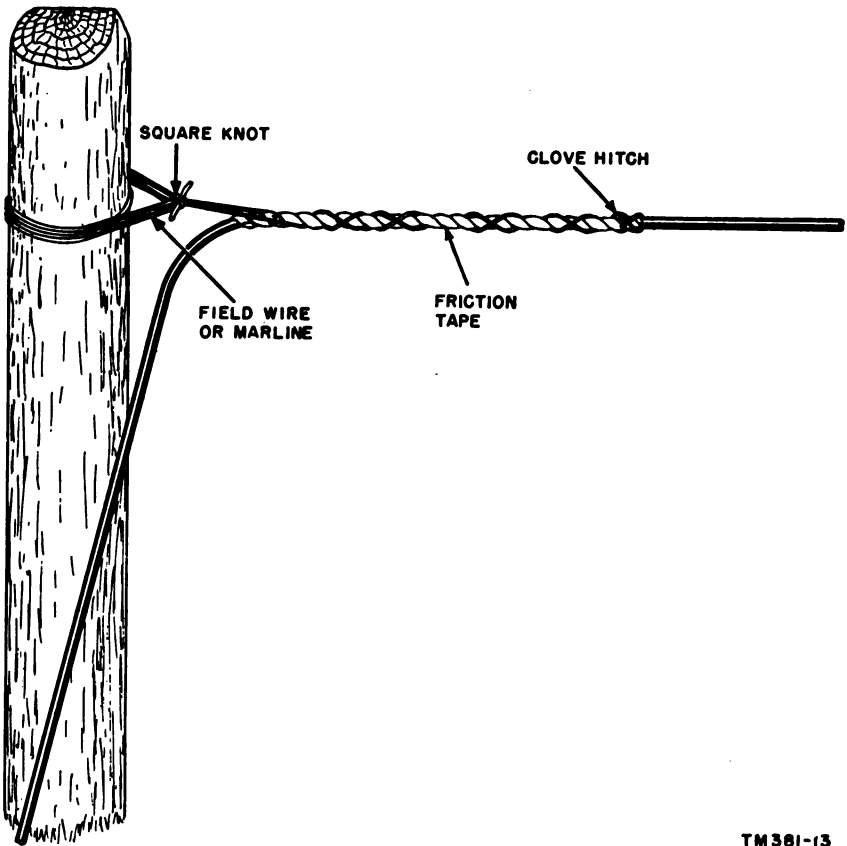

TM361-13

Figure 17. Basket hitch made with field wire or marline.

ger wire or strand is strung and the cable supported from it by cable hangers. Refer to paragraphs 59 through 77 covering aerial construction for detailed description of the materials and methods used in the specific construction operations.

b. Erecting Supports (fig. 18). When satisfactory supports are not available, supports should be erected by advance construction teams before the cable laying team reaches the crossing. The following steps are involved in erecting supports:

- (1) Provide poles of suitable strength and length. The required length of pole to give 18-foot overhead span clearance can be provided by using standard poles, native poles, trees, sectional metal poles, or lance poles. For additional information on the use of metal poles, refer to TB SIG 268, Use of Sectional Metal Line Construction Poles AB-308/G and AB-309/G.

- (2) Select suitable locations for setting the poles (par. 19). If there is a drainage ditch at the side of the road, place the poles outside the ditch. Do not set poles in the slope of embankments if other locations are available.
- (3) Install drive hooks and attach two anchor guys to each pole, and terminate an overhead guy, if used, on one of the poles. Wrap the anchor guys around the pole at a point about 6 inches from the top and fasten them with bent-over nails or staples, as shown in figure 18. Attach the overhead guy similarly, just above the anchor guys. No. 12 BWG (.109 inch) GS wire is used ordinarily for guying spans less than 200 feet long. For longer spans, follow the practices specified in paragraphs 75, 76, and 77. Each anchor guy requires a piece of wire roughly three times as long as the pole. The wire provided for the overhead guy should be about 10 feet longer than the crossing span.
- (4) Dig holes for the poles and anchors. One pole length away from the pole holes, locate the anchor holes so that the angle between the anchor guys will be from 60° to 90°, as shown in the top view of figure 18.
- (5) Set and guy the poles. Use the standard procedures for setting and guying poles outlined in TM 11-2262 or TM 11-2263. Pull up and splice the anchor guys so that both poles will have a slight rake (about 1 foot) away from the crossing span.
- (6) Attach the overhead guy, if used, to the top of the second pole. Take slack out of the overhead guy with wire pulling blocks (comealongs) and terminate it at the top of the second pole, in the manner shown in figure 18.

c. Placing Cable in Spans, Self-Supported. When ready to complete the crossing, transfer half the slack left during the laying operations (par. 39c(1)) to the other side of the road. Raise the cable at one support and attach it to the drive hook with a cable clamp or a basket hitch. Place a second clamp or basket hitch to support the vertical run. Raise the other end of the cable and pass it over the drive hook. A man stationed on the ground some distance back from the base of the pole applies tension by hand to bring the cable to the proper sag (par. 65), and a man aloft places a cable clamp or basket hitch and makes the attachment at the drive hook. Do not pull the cable over the drive hook at a sharp angle. A good way of applying tension is by means of a handline and temporary clamp or basket hitch, in the manner shown in figure 19. Additional sag is required if crossing spans are tree-

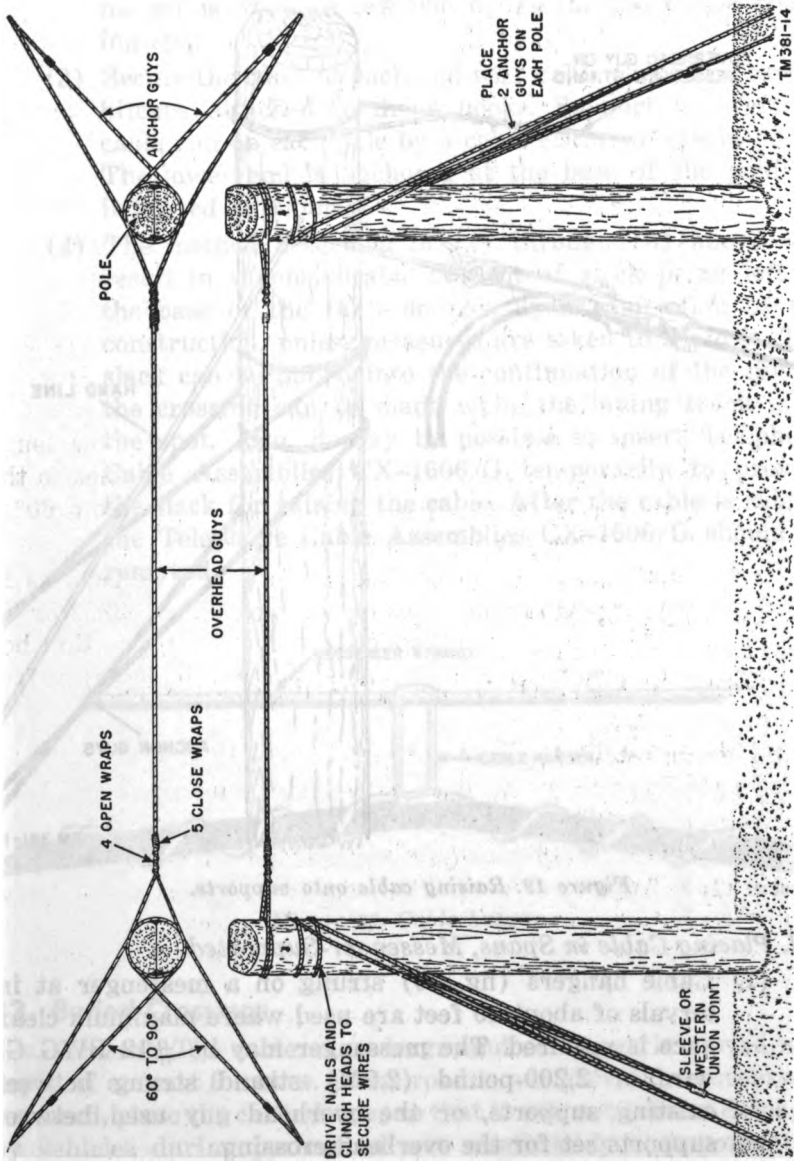

Figure 18. Overhead crossing support.

supported (par. 69d). Place a cable clamp or basket hitch at the top of the vertical run of cable and another at the base of the pole, as shown in the enlarged portions of figure 21.

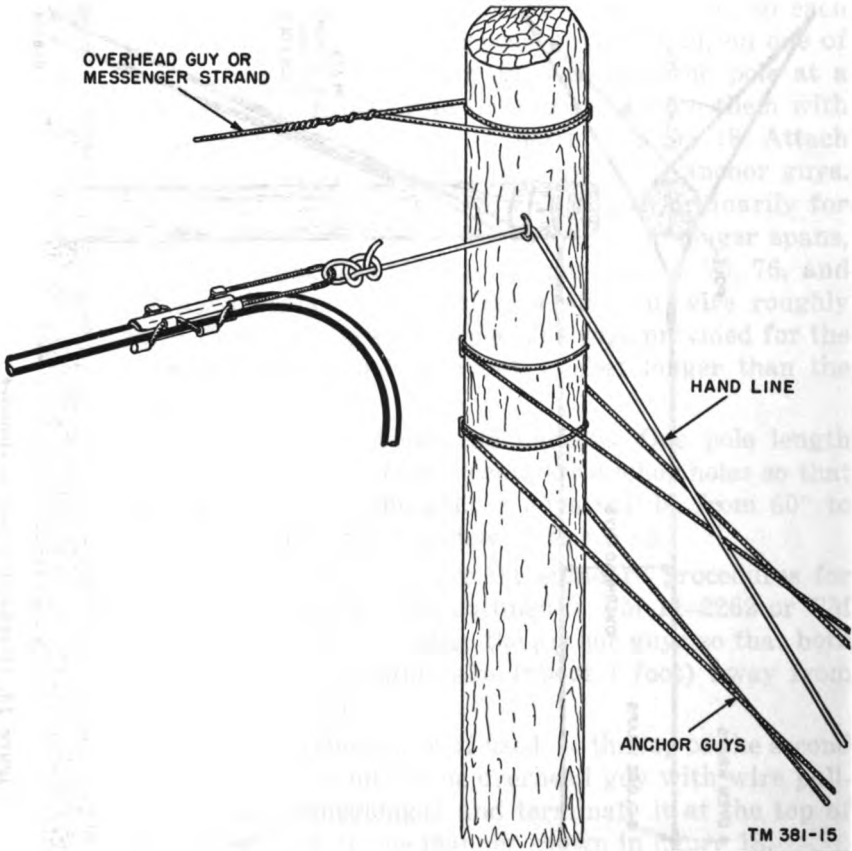

Figure 19. Raising cable onto supports.

d. Placing Cable in Spans, Messenger-Supported.

- (1) Cable hangers (fig. 20) strung on a messenger at intervals of about 10 feet are used where maximum clearance is required. The messenger may be #12 BWG GS wire or 2,200-pound (2.2M) strand strung between existing supports, or the overhead guy used between supports set for the overhead crossing.
- (2) Raise to the top of the pole the far end of the slack loop in the cable left at the base of the pole (par. 39c(2)). With a cable hanger, secure the cable to the messenger near the pole. A man on the ground pulls the cable toward the other pole until the hanger is

about 10 feet out on the messenger. A second hanger then is attached to the cable by the man on the pole and the cable again is pulled out about 10 feet. This procedure is continued in 10-foot steps until the first hanger is within a few feet of the far end of the crossing span.

- (3) Secure the cable at each end with cable clamps or basket hitches attached to drive hooks. Support the vertical cable run on each pole by a cable clamp or basket hitch. The lower end is anchored at the base of the pole, as indicated in figure 21.
- (4) The method described in (1) through (3) above will result in a considerable amount of slack being left at the base of the far side pole upon completion of the construction, unless measures are taken to avoid it. The slack can be pulled into the continuation of the line if the crossing can be made while the laying truck is at the spot. Also, it may be possible to insert Telephone Cable Assemblies CX-1606/G temporarily to provide the slack for raising the cable. After the cable is raised, the Telephone Cable Assemblies CX-1606/G should be removed.

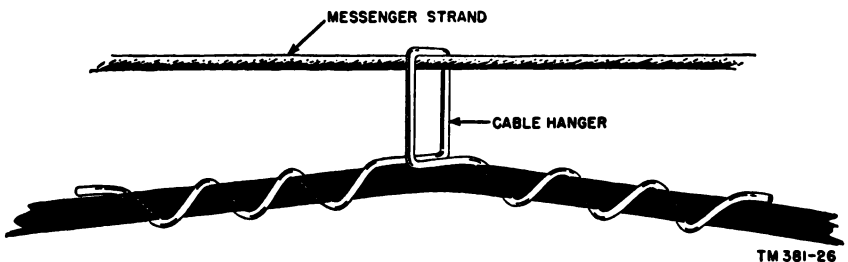

Figure 20. Cable hanger.

43. Buried Crossings

a. General. The cable at underground crossings is buried at a depth of at least 6 inches. If the road is not graveled or otherwise surfaced, place the cable deeper so that it will not become damaged by vehicles during periods of wet weather. It is important to extend the cable trench far enough on either side of the road so that the cable will be protected from vehicles that may be driven off the road. After the cable has been buried, backfill and tamp the trench. Restore the road surface as well as circumstances permit.

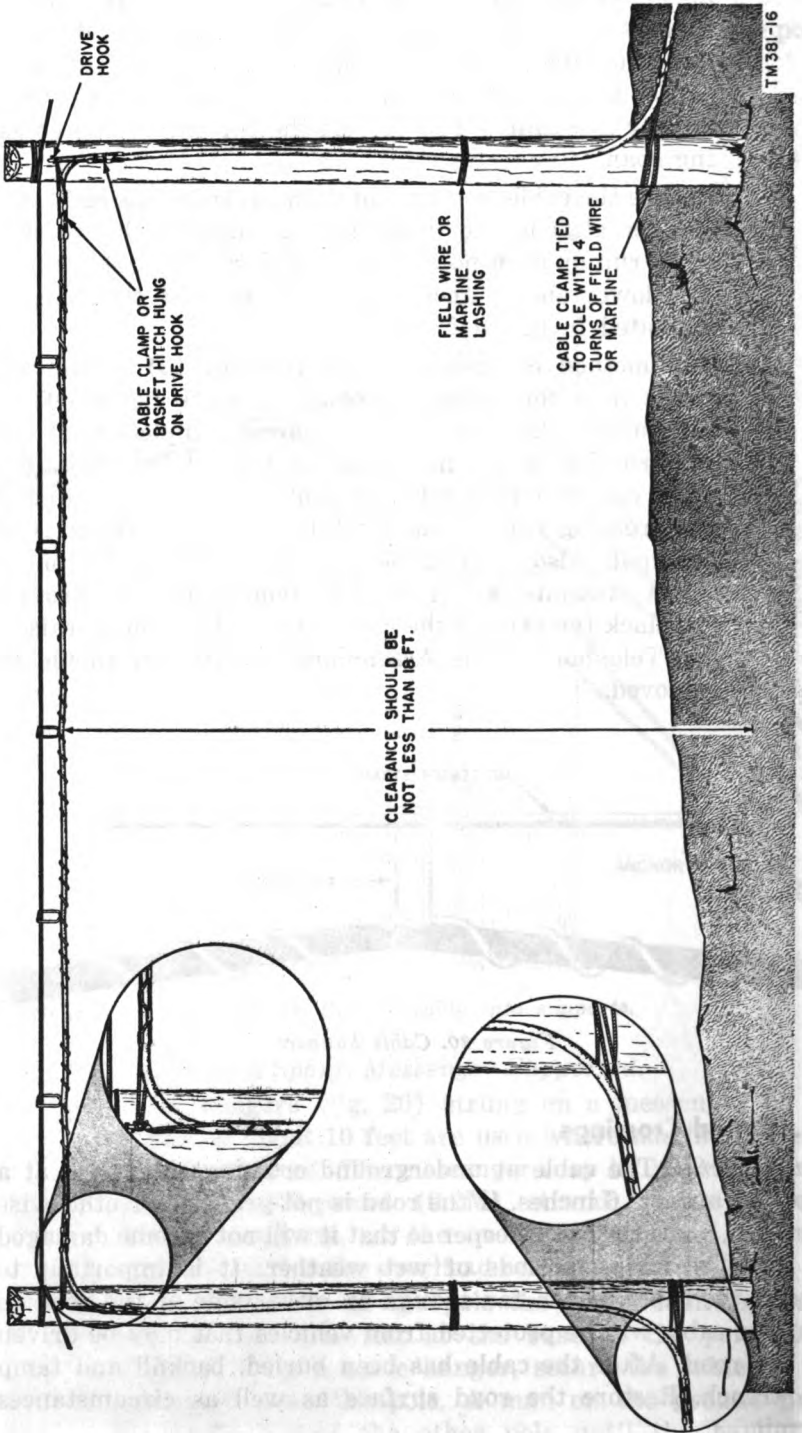

Figure 21. Completed overhead crossing, messenger-supported.

b. Railroad Crossings. Where the cable line crosses a railroad track, pass the cable under the rails alongside a railroad tie. Remove ballast (the stone around the ties) and use it to cover the cable. Bury the cable on each side of rail crossings for several feet to protect it from hot coals dropped from the locomotive fireboxes. If the railroad crossing is less than 200 yards from the last connector placed, send the truck to the far side of the tracks, pull the cable off the reel, and feed it back under the rails to the last connector. Be careful not to damage the cable when pulling it under the rails. If the railroad crossing is more than 200 yards from the last connector, connect the new reel in the usual manner, and proceed with laying until the truck reaches the tracks. Remove the rest of the cable from the reel, lay it in figure 8s, and feed it under the tracks by hand; be sure that no kinks occur. Avoid railroad sidings, switch points, and other points of activity wherever possible. If this cannot be done, bury the cable for sufficient distance on both sides of the tracks to give it adequate protection.

c. Culverts. Spiral-four cable may be run through culverts under railroad tracks or highways. Do not use culverts showing evidence of heavy flow of water or passage of stones and debris. Proceed in a manner similar to that described in *b* above for railroad crossings. When drawing the cable through the culvert, avoid pulling it across sharp corners. Wherever the cable will rest against sharp corners of culvert structure, wrap the cable with friction tape. Do not place connectors in culverts. Secure the cable to anchorages (par. 40) at both ends of the culvert, out of the line of water flow. Use two cable clamps to secure the cable in both directions from each anchorage. Pull the cable against the side wall of the culvert, as high up as possible, when attaching the cable clamps to the anchorages. Place an identifying tag at the connection to each anchorage (par. 35).

Section III. CONSTRUCTION OF BURIED CABLE LINES

44. General

a. Cable may be installed underground by using Plow LC-61, by hand, or by machine trenching. Trenching usually is confined to short distances. Plowing-in is the preferred method if any substantial length of cable is to be buried. Spiral-four cable previously laid out on the ground may be picked up directly and plowed in by the moving plow. Cable also may be buried directly from a reel mounted on the front of the plow or on a trailer.

b. The information in this section covers the plowing-in of spiral-four cable in sufficient detail to enable a skilled crew, pro-

vided with cable, a truck, a plow, and general knowledge to proceed with an ordinary cable-plowing job. For complete information, refer to TM 11-370, Plow LC-61 (Cable), which describes in detail the operation and maintenance of Plow LC-61.

45. Use of Cable Plow

a. General Features of Plow LC-61.

- (1) It can bury spiral-four cable at speeds up to 5 mph under favorable conditions.
- (2) It may be adjusted to plow at depths from 6 to 18 inches.
- (3) It is rugged and can easily pass over underground obstructions thus causing a minimum of delay to the plowing operations (par. 55).

b. Soil and Terrain Factors.

- (1) The plow may be operated satisfactorily in a wide variety of soils. Ground unsuited to plowing usually can be identified by inspection; where it cannot, an attempt to use the plow will provide the necessary information.
- (2) If possible, avoid ground that is too soft to provide traction for the towing truck because the alternative of using a winch to pull the plow through any substantial distance in such locations is a slow and difficult process. Wet, heavy clay soils may not offer enough traction for the towing truck.
- (3) The plow will cut through fairly heavy roots more easily than might be expected, and plowing operations may be undertaken in moderately wooded areas which at first might be considered entirely unsuitable for buried installations.
- (4) Soil frozen to a depth of more than a few inches is not suitable for plowing.
- (5) Plowing operations across roads are usually possible except in the case of deep stone base or concrete highways.

46. Personnel and Equipment Required for Burying Cable

The composition of teams is similar to that used for surface laying of cable (par. 38), except that a plowing team is required in place of a cable laying team. A typical plowing team and its equipment is as follows:

<i>Personnel</i>	<i>Equipment</i>
6 men, including a team chief and a driver.	1 truck, 2½-ton cargo.
	1 Plow LC-61.
	1 Reel Unit RL-26-(), RL-31-(), or RL-118/G.

47. Duties of Personnel

a. *Plowing Team.*

- (1) The towing truck driver usually will be busy operating his vehicle; therefore, when the route to be plowed may not be identified easily by the driver, a guide in a light vehicle should precede the plowing truck over the exact course the plow is to follow. The guide should have a thorough knowledge of the route and a good understanding of terrain conditions suited to plowing.
- (2) In plowing-in cable from reels, plowing teams' assignments should include a plow operator and an assistant; a man to tend the reels; and a general utility man to help change reels, to assist the driver in following the course, and to undertake any other required duties.
- (3) In plowing-in cable laid on the ground, the assignments are the same as in (2) above, except that a man is not required to tend the reels.

b. *Supply Team.* If cable is being plowed from reels, the supply team must keep the plowing team supplied with reels of cable. Reels of cable may be distributed in advance along the route, or brought to the plowing team as the need arises.

c. *Testing Team.* A testing team will be required when spiral-four cable is being plowed in from reels. This team makes electrical tests of the line as each length is added (pars.104-109).

d. *Policing Team.* The policing team follows the plowing team to bury connectors and slack, to trench at obstructions, to mark connector locations, to pick up reels of defective cable, and to dress up the installation where necessary.

48. Precautions in Plowing

The operation of Plow LC-61 is simple and a construction team can become familiar with its operation in a short time. A few fundamental precautions should be observed. These precautions are given in *a* through *f* below.

a. *Avoid excessive speed.* Excessive speed puts unnecessary strain on cable, equipment, and personnel. Keep a steady pace at walking speed (or somewhat faster where the ground is smooth).

b. *Avoid forcing through obstacles.* Leave the cable on the ground to be buried by hand or installed in some other way.

c. *Handle the plow with care.* It is durable, but can be damaged by misuse.

d. *Use safe practices.* The plow is a heavy piece of equipment with a strong pull on it. Do not be deceived by the apparent ease

with which it operates. Stand at a safe distance when the standard is tripped.

e. Handle the cable with care. Cable is most likely to be injured by kinks, excessive tension, or rough handling.

f. Do not attempt sharp changes in direction of plowing while the standard is in the ground. When it is necessary to change direction sharply, raise the standard and set up the plow for the new direction. The policing team will bury the cable at the point where the direction is changed.

49. Depth of Plowing

The cable should be plowed in deep enough to protect it from activity disturbances on the ground surface. In some places, 6 inches is an adequate depth; in others, 1 foot or more is required. Maintain a consistent plowing depth. Soft ground and stony soil require deeper plowing than ordinary hard ground. In cultivated land, bury the cable at least 12 inches deep to get it below usual tillage levels. Avoid ground that is too soft or too unstable to provide traction for the truck with the plow in tow.

50. Plowing Speed

Plow LC-61 will bury cable at walking speeds up to 5 mph under favorable conditions. The usual tractive equipment for the plow will be the standard 2½-ton, 6 x 6 cargo truck equipped with a winch. Plow LC-61 is designed to withstand the maximum direct pull of the truck. The use of prime movers that have more drawbar pull than this truck is not recommended, because the plow may become damaged. The cargo truck is capable of drawing the plow at full depth under all reasonable plowing conditions. Ordinarily, obstructions will stall the truck without damage to the plow. Use tire chains on the truck whenever necessary to get proper traction.

51. Lubricating the Cable

a. Some lengths of cable will pass through the feeding channel of the plow with very little friction; other lengths will tend to drag when drawn through. If the friction (tendency to drag) is high, the cable when placed underground will have an undesirably high tension. Avoid this by lubricating the cable whenever necessary.

b. The tendency of cable to offer high or low pulling friction may be estimated by pulling the cable through the closed hand under some finger pressure. If the cable passes readily through the fingers, it will probably pass freely through the plow; if it

binds, it must be lubricated. The appearance of cable is also some indication of how it will pass through the plow. Generally, cable which is more or less glossy in appearance will pass through the plow without difficulty; cable which is dull black may bind.

c. Another test often, will be effective in determining whether the cable is leaving the plow under an objectionable tension. As the plow proceeds, hold the cable firmly in the hand at a connector point and observe the amount of pull necessary to draw slack. Slack should come fairly easily. If the tension is excessive, a noticeable pull will exist on the cable at the connector point even after the plow has gone a considerable distance. The amount of pull will vary with the fallback of the earth in the slot made by the plow.

d. Lubricate the cable surface if it appears that the friction in the feeding channel is high and the cable is under severe tension. This is accomplished best by applying talc (powdered soapstone) with Talc Box M-401, according to the instructions given in TM 11-370.

e. If Talc Box M-401 is not available, run the cable through a cloth to which talc is added freely. If the cable is being laid from a reel, dust the talc lightly on the surface layers of cable as the reel turns. Water, while not convenient to use, is a satisfactory lubricant. A device can be made whereby a small tube will supply a trickle of water to the feeding passage from a can or drum carried on the plow or truck.

52. Preparation for Plowing

a. At the point where plowing is to start, fasten the cable to a stake, pole, or tree (par. 40). Leave enough cable stored at this point to reach the equipment to which the spiral-four cable is to be connected.

b. Set up the plow at the starting point according to the instructions given in TM 11-370. If the cable is to be plowed in from reels, put the cable in the center and rear cable sheaves and guides and in the feeding channel. If the cable is laid on the ground, put the cable in the front and rear sheaves and guides and in the feeding channel.

c. Hitch the plow to the truck and start plowing. Paragraphs 53 and 54 describe the plowing procedures when the cable is on reels and when it is on the ground.

53. Plowing-in Cable from Reels

a. When plowing from a reel, it may be necessary to assist the rotation of the reel by hand (particularly during starting) to prevent tension from being put on the cable that is entering the plow. Do not run the reel so fast that a loop of cable drags on the ground.

b. Connectors cannot pass over the sheaves or through the cable guides on the plow. When approaching the end of the cable length on the reel, proceed as follows:

- (1) Slow the forward movement of the vehicle and stop plowing just before the last turn of cable is ready to come off the reel.
- (2) Unwind the remaining cable by hand and remove the connector from the storage compartment on the reel.
- (3) Remove the cable from the plow guides and release the gate.
- (4) Strip a few feet of cable out of the plow cut, back the plow to the end of the cut, and trip the plow.
- (5) Remove the empty reel from the reel supports on the plow or from the reel unit in the truck. Put on a full reel of cable and thread the new length through the plow. Replace the gate on the plow.
- (6) Join the connectors (or connectors and loading coil). Allow about 4 feet of cable at the connector location. This is done by making a loop about 4 feet in circumference, including the connectors and applying a firm 2-inch seizing of marline or field wire where the cables overlap (fig. 16).
- (7) Resume plowing operations. The policing team will bury the connectors (par. 57).

Caution: In backing or tripping the plow, be sure that the cable is in the clear and will not be damaged. Do not raise the standard or back the plow with cable in the feeding channel.

54. Plowing-in Cable Laid on Ground

a. General.

- (1) Spiral-four cable laid out on the ground usually will feed smoothly into the front sheaves and guide as long as there is a reasonable slack loop on the ground outside and back of the front sheave. A loop that reaches back to a point opposite the step on the plow is adequate and can be watched easily by the plow operator.
- (2) Tension in the cable entering the feeding channel increases the friction greatly and may cause injurious stress in the cable back of the plow. If the cable is taut as it enters the front sheave of the plow, it is almost sure to be damaged.
- (3) An excessive slack loop alongside and back of the plow is difficult to watch closely and may become caught on an obstruction. Wherever possible, dispose of the slack at

connector locations. If there is any risk of damaging the cable as a result of working with a long loop, remove the excess at once (*b* below).

b. Removing Excess Slack.

- (1) Lift the standard and stop the plow.
- (2) Pull the excess slack through the feeding channel.
- (3) Fasten the cable to an anchorage (par. 40) and leave it for the policing team to bury (par. 57).
- (4) Resume plowing operations.

c. By-passing Connectors. Connectors cannot pass over the sheaves or through the cable guides on the plow. When approaching connectors in the cable line, proceed as follows:

- (1) Slow the vehicle, release the gate, depress the lifting hook lever, and stop plowing before the connectors reach the front sheave and guide.
- (2) Remove the cable from the plow guides.
- (3) Strip a few feet of cable out of the plow cut, back the plow to the end of the cut, and trip the plow.
- (4) By-pass the connectors and thread the next length of cable through the plow. Replace the gate on the plow.
- (5) Join the connectors or the connectors and loading coil, if used. Allow about 4 feet of cable at the connector location. This is done by making a loop about 4 feet in circumference, which includes the connectors, and applying a firm 2-inch seizing of marline or field wire where the cables overlap (fig. 16). The policing team will bury the connectors (par. 57).

Caution: In backing or tripping the plow, be sure that the cable is in the clear and will not be damaged. Do not raise the standard or back the plow with the cable in the feeding channel.

55. Procedure at Road Crossings

a. General. Plow LC-61 can be used to cross unimproved roads, or those having a light stone or gravel base, by direct pull or by winch line. In some cases, it may help to make a shallow preliminary cut without the cable in the plow to break up light paving material or hard-pack earth or gravel. The cable should be laid at a depth of at least 6 inches at road crossings, and preferably as deep as 12 inches. The latter depth is considered a minimum if the road surface is one which will soften during wet weather or if there is danger of the cable being crushed between stones under heavy traffic.

b. Use of Culverts. If culverts are available, they may be used for road crossings in the same manner as recommended for cable laid on the ground surface (par. 43).

56. Plowing in Water and Soft or Swampy Ground

a. Plowing in Water. Plow LC-61 can be operated across streams or other water if the approaches and bottom conditions are suited to plowing. The water will not damage the plow. If banks are steep, it may be necessary to cut approaches to the water. Be sure that there is enough spiral-four cable to make the crossing from one reel length. Proceed with the plowing as follows:

- (1) Set up the truck on the far side of the water.
- (2) Take the winch line across and attach to the hitch plate hook.
- (3) Pull the plow across with the winch line. The expanse of water which can be crossed usually will be determined by the available length of winch line.

Caution: Do not place connectors under water unless absolutely necessary. The connection formed by joining two connectors is watertight; but placing the connectors in water makes maintenance and repair difficult.

b. Plowing in Swamps and Soft Ground. Ordinarily, it will not be necessary to plow cable in swampy ground since vehicles cannot run over it. When it is necessary to plow for short distances through marshy soil, set the truck up on the far side and pull the plow through with the winch. Use duck boards under the wheels of the plow if it appears likely to become stuck in the soft ground.

57. Burying Connectors and Marking Location

Connectors usually are buried by a policing team. This team also checks for tags at connector points, places any additional tags needed (par. 35) and removes any cable clamps that have been placed at connector points or elsewhere by preceding teams. The connectors then are laid in a hand-dug excavation in the earth approximately at the depth of the plowed cable. It is important that the location of connectors in buried spiral-four cable be marked in a reasonably permanent manner. A suggested method is to dig a hole about 6 inches deep and 3 feet in diameter, 6 feet from the line and directly to the right or left of the connectors (fig. 22). Leave this hole unfilled and use the earth taken from it to make a mound over the point where the connectors are buried. For convenience in maintenance a stake, bearing the same information as the buried tag, is driven in the borrow pit at the point nearest the cable.

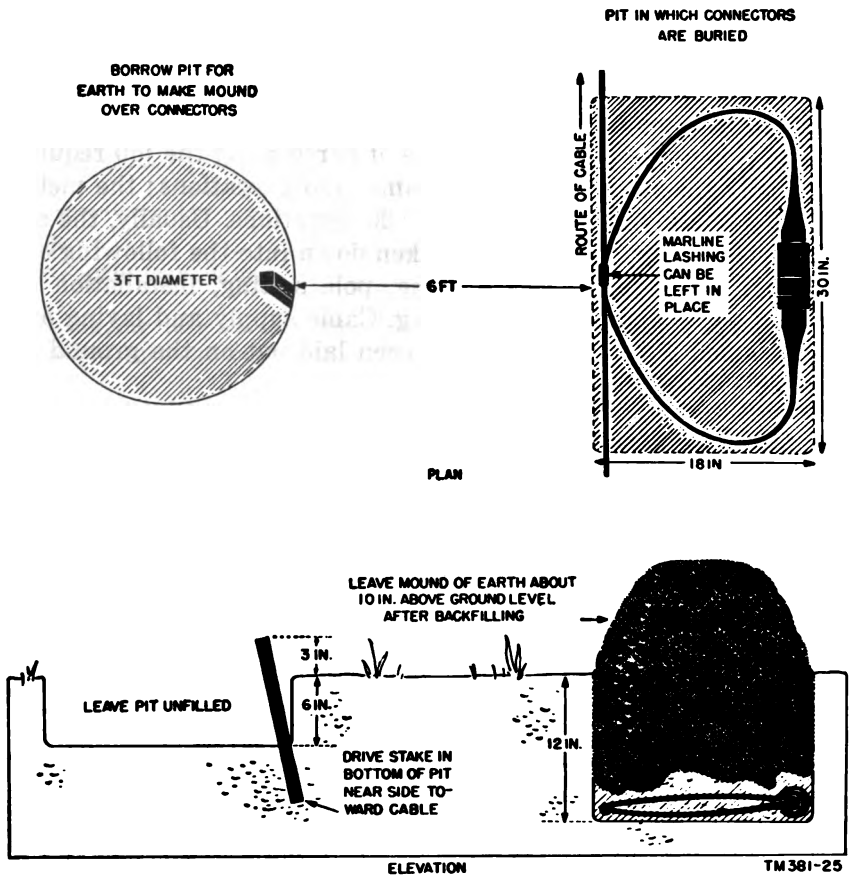

Figure 22. Burying connectors and marking the location.

58. Restoring Ground Surface

The simplest and most effective method of restoring the ground surface after plowing is to iron out the trace with dual-tired truck wheels. An improvised drag made from pieces of scrap lumber, or other material, also can be used to smooth out the plow trace. Neither method will remove the plow mark entirely, but either will render it much less conspicuous and reduce the chances of washing-out or softening in wet weather. In special cases, it may be necessary to use regular camouflage methods.

Section IV. CONSTRUCTION OF SELF-SUPPORTED AERIAL CABLE LINES

59. General

The aerial construction methods described in this manual are principally those using poles or supports which can be erected

rapidly. The methods of cable suspension for this type of construction are also useful where other kinds of supports, such as trees, existing pole lines, etc., are available. Generally, it is assumed that most spiral-four cable lines originally will be laid on the ground, although in some instances, the cable will be installed aerially as soon as it is unreeled. Both methods of performing the job require essentially the same equipment, teams, and operations; the methods differ mainly in the order of work operations. Usually, the actual aerial construction can be broken down into the following operations: pole supply, hole digging, pole setting, installation of cable on poles, and electrical testing. Cable supply and laying are also included if the cable has not been laid out on the ground in advance.

60. Storm Resistance Limitations

a. The type of line described is not designed to withstand severe and unusual weather conditions. Therefore, aerial installations of spiral-four cable in areas subject to high winds or sleet (glaze) storms should be built with these weather hazards in mind. Increased resistance to damage by severe weather conditions can be gained by shorter span lengths, more frequent guying, and deeper setting of poles. Any or all of these measures may be taken as determined by judgement and knowledge of conditions. When determining clearance at aerial crossings, consider the possibility of sleet loads, particularly at long spans.

b. Particular care is necessary when building spiral-four aerial cable line to withstand storm conditions where trees are used to support the line. If trees are to be used as supports, be sure to follow the procedures given in paragraph 69. If precautions are not taken, the cable may become damaged badly by the loads developed as the result of tree movement due to wind.

61. Speed of Construction

a. The rate at which spiral-four cable aerial lines can be built will vary considerably. Under good conditions, a fully equipped and efficient construction team can build 5 or more miles of line a day, and a platoon, 10 miles or more.

b. Smooth teamwork is of highest importance, both within and among the various teams. Before a job is started, all personnel and all teams should be oriented so that each man and each team understands the work assignments.

c. Flexibility in organization is desirable so that assignments of personnel may be fitted to the varying requirements of the job. The line construction officer should shift manpower or vehicles as necessary to meet work load variations.

62. Personnel and Equipment Required for Aerial Construction

A suggested organization of teams and the assignment of equipment are shown in the chart below. The number of men indicated in each case includes the team leader and a driver.

Personnel	Equipment
Guide -----	
Pole supply team, 6 men-----	1 truck, 2½-ton cargo. 1 Trailer K-36.
Hole digging team, 4 to 8 men (dependent upon method used).	1 truck, 2½-ton line construction. or 1 truck, ¾-ton weapon carrier.
Pole setting team, 6 men-----	1 truck, 2½-ton line construction.
Cable installation team, 6 men-----	1 truck, ¾-ton weapon carrier.
Cable supply team (not required if cable previously has been laid on the ground and connected).	1 truck, 2½- or 4-ton cargo.
Cable laying team (not required if cable previously has been laid on the ground and connected).	1 truck, 2½-ton cargo equipped with Reel Unit RL-26-(), RL-31-(), or RL-118/G.
Testing team, 2 men (required when electrical tests are being made as a part of the construction work).	1 truck, ¼-ton 4 x 4.

63. Line Construction Materials

Relatively few items of material are needed to build the type of spiral-four cable aerial lines described. The various items are described briefly and their functions indicated in *a* through *j* below.

a. Poles and Supports. Use standard poles, if available. The usual length is 20 feet. Natural poles obtained locally are satisfactory substitutes if they have a 4½-inch top diameter and are reasonably straight. Trees may be used if poles are not available.

b. Cable Hanger PF-203/G. The cable hanger illustrated in figure 20 is a single piece of galvanized-steel wire, formed into two open helixes separated by a supporting loop. It is used as an intermediate attachment at supports and also to suspend cable from the messenger strand.

c. Clamp, Electrical Conductors, Strain PF-211()/G. Cable clamps (fig. 15) are used for dead ending or for any other purpose where a nonslipping grip on the cable is required.

d. Hook PF-81 (Drive Hook). The drive hook is driven into a ⅜-inch lead hole in the support to receive cable attachments.

e. Strand. Either 2.2M or 6M, galvanized-steel messenger strand is used for guys and messenger.

f. *Clamp PF-61 or Clamp FT-56.* Clamp PF-61 is used for clamping the 2,200-pound (2.2M) strand. Clamp FT-56 is used for clamping the 6,000-pound (6M) strand.

g. *Galvanized-Steel Wire.* No. 12 BWG (.109 inch) galvanized-steel wire is used as a general purpose wire.

h. *Steel Sleeves.* Single-tube, galvanized-steel sleeves are used for splicing #12 BWG galvanized-steel wire.

i. *Anchors.* Use any standard anchor available. If standard anchors are not available, they can be made from halves of 86-inch 3 by 4 crossarms of other timbers or logs of equivalent size or larger.

j. *Miscellaneous Materials.*

- (1) Use field wire for making ties, tension bridges, basket hitches, and for suspending cable hangers from trees.
- (2) Marline is used for some of the same purposes and as a general utility material in construction work.
- (3) Friction tape and polyethylene tape may be used to protect the cable at points of contact and to repair minor damage to the cable jacket.

64. Span Length Requirements

a. Where 20-foot poles are used, the span length ordinarily is limited by clearance requirements to 150 feet or less, although span lengths up to 300 feet are permissible if sag and clearance requirements (pars. 65 and 66) can be met. For example, at a stream or ravine crossing, the height of the banks may make it possible to get satisfactory clearance with the longer spans. For span lengths greater than 300 feet, use messenger-supported cable (pars. 75-77).

b. If poles are to be used for open-wire lines also, space the poles at 150-foot intervals. However, in some instances, the desired vertical clearance of the spiral-four spans may not be obtainable with this pole spacing.

65. Sag Requirements and Methods of Measurement

a. *Sag Requirements.*

- (1) Allowable sags for spiral-four cable aerial spans are based on tensions of 100 pounds at 60° F. The chart below shows sags for various span lengths of self-supported, spiral-four cable, carried on poles or frames in medium loading areas. Allow a greater sag to cable that is attached directly to trees (par. 69).

Note. Normally, wires and cables increase in length when the temperature increases. Because of its construction, spiral-four

cable decreases in length when temperature increases. Because of this, greater sags are provided at the lower temperatures than at the higher temperatures.

Minimum sags for self-supported spiral-four cables on pole lines (medium loading areas)

Span length (ft)	Sag (in.)				
	0° F.	30° F.	60° F.	90° F.	120° F.
100	13	12	11	11	10
125	19	18	17	16	15
150	28	26	25	24	23
175	40	38	37	35	34
200	68	66	64	62	61
250	139	137	136	134	132
300	224	222	221	219	217

(2) The sags for span lengths between those shown in the table above may be found by substituting values from the table in the formula given below.

$$b \text{ (the unknown sag)} = \frac{(B-A) \times (c-a) + a}{(C-A)}$$

Where B = the span length for which the sag is required.

A = the span length in the table just before B.

C = the span length in the table just after B.

a = the sag given in the table for span length A.

c = the sag given in the table for span length C.

Example: Find the sag for a span length of 130 feet at 60° F. In this case, B in the formula is 130. The span length just before 130 feet in the table is 125 feet and the sag at 60° F. for this span length is 17 inches. Therefore, A in the formula is 125 and a is 17. The span length just after 130 feet in the table is 150 feet and the sag at 60° F. for this span length is 25 inches. Therefore, C in the formula is 150 and c is 25. Substituting these values in the formula gives the following results:

$$\begin{aligned}
 b \text{ (the unknown sag)} &= \frac{(130-125) \times (25-17) + 17}{(150-125)} \\
 &= \frac{5 \times 8 + 17}{25} \\
 &= 19 \text{ inches (approx)}
 \end{aligned}$$

Sags for span lengths between those shown may be interpolated.

For example, the sag of a 130-foot span at 60° F. should be

$$\frac{130-125}{150-125} \times (30-21) + 21 = 23 \text{ inches (approx).}$$

- (3) The specified sags provide a reasonable factor of safety against overstressing the cable. Smaller sags require increased tensions, which may result in damage to the conductors.

b. Sag Measurements. Sags always are measured at the center of the span. Measurements may be made either by sighting or by the oscillation method. The oscillation method makes use of the fact that there is a direct relation between the sag and the period of oscillation of a suspended member. After the cable has pulled up to approximately the correct tension, select a span which does not have connectors or splices in it and which is free from contacts with trees or other objects. Sag is measured by the oscillation method as follows:

- (1) Strike the cable sharply with the hand at a point about 2 or 3 feet from a pole. At the same time, start a stop watch.
- (2) Hold fingers lightly against the cable and as the first return wave is felt, count *one*. Upon the second return, count *two* and so on.
- (3) In spans with estimated sags of 50 inches or less, count the number of oscillations, or return waves, in 10 seconds.
- (4) In spans with estimated sags of more than 50 inches, measure the time in seconds for three complete oscillations.
- (5) On the longer spans, better results may be obtained by swinging the cable across the direction of the line, as a pendulum, and counting the number of swings. Swing the span as a unit.
- (6) Compare the observed results with the chart below and make sag adjustments (increase or decrease tension) to conform to span length and temperature as given in *a*(1) above.

Oscillations per unit of sag

Sag—50 inches or less		Sag—More than 50 inches	
Sag (in.)	No. of oscillations in 10 seconds	Sag (in.)	Time in seconds for three oscillations
12	10	51-54	6¼
13-14	9½	55-58	6½
15-16	9	59-62	6¾
17	8½	63-67	7
18-19	8	68-71	7¼
20-22	7½	72-77	7½
23-26	7	78-82	7¾
27-30	6½	83-87	8
31-36	6	88-93	8¼
37-43	5½	94-99	8½

Oscillations per unit of sag

Sag—50 inches or less		Sag—More than 50 inches	
Sag (in.)	No. of oscillations in 10 seconds	Sag (in.)	Time in seconds for three oscillations
44-50	5	100-104	8¾
		105-111	9
		112-117	9¾
		118-123	9½
		124-130	9¾
		131-138	10

66. Vertical Clearance Requirements

a. Spiral-four cable aerial lines should have minimum vertical clearances above ground as follows:

- (1) 18 feet over main traffic arteries and paved roads.
- (2) 14 feet over secondary roads and at other points where vehicles may travel.
- (3) 8 feet over land which is not passable by vehicles. (Where this clearance is used, be sure that no traffic other than persons on foot will pass under the line.)

b. Spiral-four cable aerial lines may pass under but not over aerial power lines. When underpassing such lines, obtain maximum possible clearances consistent with satisfactory ground clearances. Clearance between power wires and spiral-four cable never should be less than 6 feet. Use buried construction if necessary.

c. Never install aerial cable over railroad crossings. Install buried cable (par. 43).

d. For additional information on clearances, see TM 11-2261, Telephone Outside Plant Engineering.

67. Spacing from Roads, Power Lines, and Buildings

a. *Spacing from Railroads.* Set poles at railroad crossings so that the dead end anchors will be at least 12 feet from the nearest rail, preferably much farther. Lines paralleling railways should be kept at least 100 yards away from rail right of way. The vicinity of yards and sidings should be avoided.

b. *Spacing from Highways.* Maintain at least 100 yards separation from paralleling highways. In crossing highways, place crossing poles at least 10 feet from the usable road shoulder.

c. *Spacing from Power Lines.* When constructing cable lines parallel to power transmission lines, maintain a distance of at least 100 yards. If it is necessary to run closer, keep the length of paralleling line as short as possible. Do not attach spiral-four cable to power line poles.

d. Spacing from Buildings. Maintain enough separation from buildings, trees, and similar obstructions at intermediate points in the span to insure that the cable will not make contacts that will damage the jacket.

68. General Considerations in Preparing the Cable for Installation on Poles

a. Cable not Previously on Route. In an initial installation, the cable is brought out on the ground, tested, connected, and tagged in the same way as for construction on the ground surface (pars. 39-43). At connector locations, a tension bridge (par. 70) is provided. The connector loop should be free of kinks and twists. The connector location is tagged in the usual manner (par. 35).

b. Cable in Service. Cable in service as a surface installation ordinarily will have excess slack which must be worked out of the line. When slack is to be stored at a pole, coil the excess cable into a figure 8 of convenient size, bind it at several points, including the cross-over, and support the coiled slack on the pole by lashings of field wire or marline. Make a dead end attachment (cable clamp or basket hitch) to the cable in both directions.

69. General Considerations in Preparing the Cable for Installation on Trees

a. Method of Securing Cable to Supports. If trees are used as aerial supports, a different method of construction is required. The principal reason for this is that in heavy wind, two trees supporting an aerial span may sway several inches in opposite directions at points of attachment. Movement of a few inches of the support in a span with normal sag will cause enough increase in tension to break or damage the cable or its supporting attachments. There are two ways of compensating for the sway of trees to which cable is attached: one way is to provide more than normal sag; the second way is to use a floating suspension with slings (par. 72). The floating suspension method is the preferred method. The use of either method requires that the laying-out of the cable be suited to that particular method. Construction on trees requires extra care when laying-out and when building the line.

b. Disadvantages in Use of Additional Sag. Conditions seldom will permit the use of additional sag as a means of allowing for tree sway. In any such span, $7\frac{1}{2}$ feet of sag must be allowed, in addition to that listed in the chart in paragraph 65, to compensate for the span length increase caused by tree sway. Where this method is used, however, a proper allowance of slack should be laid to provide for the extra sag. Note that the greater the sag, the higher the point of attachment must be and, the higher the point of at-

tachment, the greater the wind sway. Thus, any considerable amount of such construction requires tall, fairly evenly spaced trees with little or no low limb growth to obtain the required clearance.

c. Selecting Trees. The guide, working in advance of the cable-laying team, selects and plainly marks the trees to which attachments are to be made. These markings include indication of the side of the tree to which attachment is to be made. When possible, supporting trees are selected so that a minimum of trimming will be required and spans will be in the range of 100 to 200 feet. When it can be achieved, a slight pull away from the supporting tree is desirable. When the line changes direction, the cable always is placed on the side of the tree facing the direction of pull. Trees to which the cable is to be attached should be tall enough to allow standard vertical clearances (par. 66) at the midpoints of the cable spans. To meet these various conditions, poles may have to be inserted where suitable trees are not available or where the route otherwise would be winding or indirect.

d. Laying Cable. If the cable has not been laid previously, the cable-laying and testing teams lay the cable on the ground, test it, and connect it (pars. 39-43). A tension bridge (par. 70) is placed at connector locations. The only procedures requiring special attention are placement of the cable on the proper side of each supporting tree and laying it in a line which will not be obstructed by intervening trees when the cable is raised. Where the laying truck cannot pass on the proper side of a supporting or intermediate tree, it may be necessary to dismount the reel and carry it by hand around the tree.

70. Placing Tension Bridges at Connector Locations

Note. If possible, avoid placing connectors in the span. Instead, pull back the connector to the pole before the span and terminate the assembly. Tie the excess slack to the pole in a neat figure 8.

This procedure is of utmost importance to permit easy access to connectors for testing purposes, to permit ready insertion or removal of loading coils when changing from 4- to 12-channel operation or vice versa, and to provide slack that may be required when a damaged cable section is replaced.

a. Whenever connectors must be placed in the span, a tension bridge, made with cable clamps or basket hitches, must be placed at the connector location. The bridge serves three purposes: It prevents tension being placed upon the connectors, it provides a means for opening the line at connector locations without pulling the slack, and it gives support to the suspended connectors.

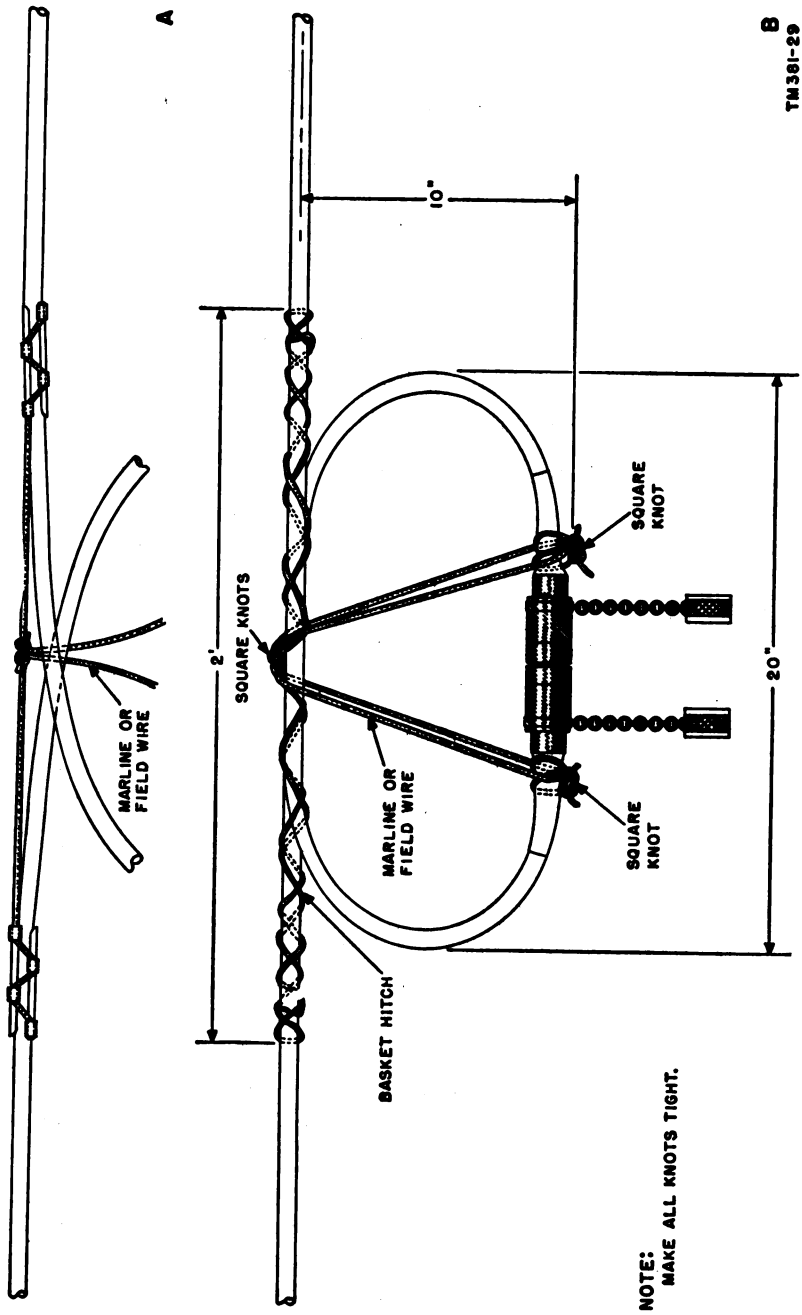

B
TM391-29

Figure 23. Tension bridge at connector locations, aerial construction.

b. Two forms of tension bridge are shown in figure 23. The bridge is installed before stringing tension is applied to the cable, usually at the time the cable is laid out and tested.

c. If a ground surface installation is being converted to aerial installation, check all connector locations for proper tension bridges before raising the cable to its aerial position. Lay connectors in the clear so that they will not catch on brush or other obstacles when the cable is pulled up. See that identifying tags (par. 35) are attached and are in good condition.

d. Do not place connectors in spans over highways or other traffic routes or in adjacent spans. They reduce the clearance, and traffic may prevent their being lowered for access in maintenance work.

71. Raising Cable onto Poles

a. *Securing Cable to First Pole of Line.*

- (1) In the following description of the methods of placing cable on poles, the end pole of the line, or the pole where construction starts, is referred to as the *zero pole*.
- (2) Leave enough cable at the base of the zero pole to reach the equipment to which the cable is to be connected. If the run from the zero pole to the equipment is either to be along the ground or buried, fasten the cable to the base of the pole with a cable clamp or basket hitch, as shown in the lower enlarged portion of figure 21. At the top of the zero pole, use two similar fastenings; one to support the vertical run of cable, the other to dead-end the first aerial span, as shown in the upper enlarged portion of figure 21.

b. *Raising and Sagging Cable in Straight Sections of Line.* As many as five or six spans of spiral-four cable may be tensioned at one time in straight sections of line. With the cable terminated at the zero pole, proceed as follows:

- (1) Raise the cable with a wire raising pike, or by a climber carrying it and laying it over the drive hooks at poles 1 through 5.
- (2) From a position near the base of pole 6, apply tension *by hand*. One man can pull approximately his own weight by snubbing the cable with a one-half-turn around his hips. This is the maximum pull that should be put on spiral-four cable, normal stringing tension being 100 pounds. *Do not use a block and tackle on spiral-four cable.* Do not pull the cable over the drive hook at a sharp angle.

- (3) The lineman on pole 5 should estimate the sag and call for more or less tension, as required. The sags specified in paragraph 65 are the minimum sags. Wherever clearances will permit, greater sags are desirable.
- (4) When the sag is correct, the lineman on pole 5 should place a cable clamp or basket hitch to hold the tension in the section which has been sagged. Brace pole 5 with a pike hole, or guy temporarily, before the man on the ground near pole 6 releases the head tension.
- (5) Repeat the procedure described in (1) through (4) above in succeeding sections until a corner or dead-end is reached (par. 73).

c. Securing Cable to Intermediate Poles.

- (1) *Direct attachment to drive hook.* After a section of cable has been raised and sagged (*b* above), other members of the cable-installation team start at pole 1 and place cable hangers at each point of support. The hangers may be placed by men working from scaling ladders or from an ordinary ladder lashed to the side of a truck.
- (2) *Suspending hangers from drive hooks by means of field wire.* Lengths of field wire may be tied to the hangers and used to raise and support the cable at points where connectors are suspended in the spans, or at other locations where it may be desirable to arrange for easy lowering of the cable. After the cable hanger has been placed on the cable, use a piece of twisted-pair field wire, long enough to reach from the ground to the drive hook and back, and tie one end securely to the eye of the hanger. Pass the wire over the drive hook. By pulling on the free end of the wire, draw the cable up until the hanger is suspended just below the drive hook. Tie the wire securely around the pole at a convenient height to hold the cable in its fully raised position. Coil the surplus wire and tie it to the pole, so that it will be available for later use in lowering and raising the cable. Use this method of support on both poles adjacent to a connector in the span.

d. Placing Cable on Existing Pole Lines. Place cable on existing pole lines in the same manner as on pole lines built specifically for spiral-four cable. Place drive hooks at heights sufficient to give the required vertical clearance with specified sags (but not closer than 6 inches to the lower cross arm of an open-wire line). *Spiral-four cable should not be placed on poles carrying power lines.* Except for these limitations, the procedure in placing spiral-four cable on existing pole lines is the same as that described in *a* through *c* above.

e. Securing Two Cables to One Drive Hook. Two spiral-four cables may be suspended by hangers, basket hitches, or cable clamps from one drive hook. When this type of construction is used, make an attempt to introduce small differences in the amount of sag given the two cables to reduce cross talk.

f. Placing Cable at Dead-ends. Make the attachments at dead-ends the same as for the zero pole (*a* above). Store at the base of the pole any left over cable in the length.

72. Raising Cable onto Trees

a. Securing Cable to First Tree of Line. A floating suspension using slings is used to attach spiral-four cable to trees to allow for movement of the trees in the wind. Figure 24 shows this suspension for the first tree of the line. The procedure for making the suspension is described in (1) through (5) below.

- (1) Install a drive hook on the side of the tree facing the cable. Locate the hook 3 feet or more above the point where the cable is to be suspended.
- (2) Use #12 BWG wire and a rolled sleeve, or field wire, to make a sling long enough to reach from the drive hook to the point where the cable is to be suspended. Hang the sling over the drive hook.
- (3) Use field wire or #12 BWG wire and a rolled sleeve, to make a guy in the form of a long loop threaded through the sling and passing from that point to a convenient anchorage about 50 feet away from the tree. Choose the location of the anchorage so that the guy will oppose the load of the first span of cable and so that the lower end of the sling loop will be pulled out about 6 inches from the tree when the cable is tensioned. Adjust the length of the guy so that with the cable under tension, the sling will appear to hang approximately vertically when the drive hook is viewed head on. Hang strips of cloth at frequent intervals on that part of the guy which will not clear pedestrian or occasional vehicular traffic.
- (4) Raise the cable and attach two cable clamps or basket hitches, one to take up the load of the first span and the other to support the vertical run of cable. The bails of the cable clamps or the ends of the basket hitches should be threaded through both the sling and the guy loops.
- (5) Fasten the cable to the base of the tree with field wire or marline. A cable clamp or basket hitch also may be used to take up any pull on the ground run of the cable.

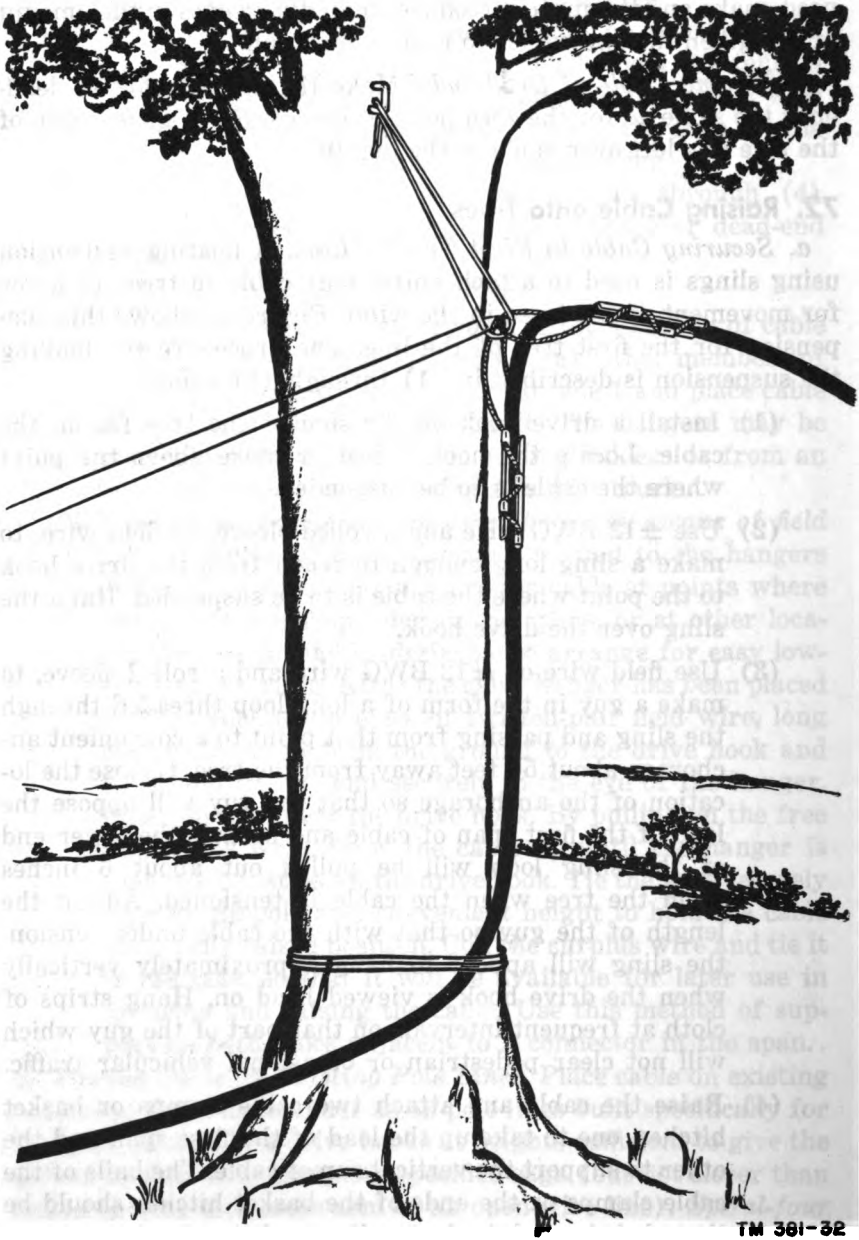

TM 361-32

Figure 24. Securing cable to first tree.

b. Securing Cable to Intermediate Trees. Use the procedures described in (1) through (6) below for straight sections of the line where the pull of the line away from the tree is less than 20 feet. If the pull is more than 20 feet, use the procedures described in paragraph 74.

- (1) On the side of the tree facing the cable, install a drive hook in the tree at a point 3 feet or more above the desired cable position. Place the cable over this drive hook.
- (2) A man 100 feet or more beyond this tree should apply tension to the cable while a man on the tree checks the sag. When the sag is correct, the cable should be marked at the point where a cable hanger is to be placed. In applying tension to the cable hanger, it may be necessary to use a handline attached to a cable clamp temporarily attached to the cable to direct the pull over the drive hook.
- (3) When the hanger location has been marked, lower the cable to the ground and attach the cable hanger.
- (4) If it is desired to arrange for easy lowering of the cable, select a piece of field wire long enough to reach from the ground to the drive hook and back down to the ground. Attach one end of the field wire to the eye of the cable hanger and pull up the cable within not less than 3 feet of the drive hook. Tie the other end of the field wire to the base of the tree, as shown in figure 25.
- (5) If easy lowering is not a consideration, terminate the field wire at the drive hook and remove the excess field wire. A sling of #12 BWG wire can be used in place of the field wire for the suspension.
- (6) Repeat the steps outlined in (1) through (5) above at successive supporting trees in straight sections of the line. Check the tension in each case to see that the suspension hangs properly at the preceding tree. Check each point of support to see that the cable does not pull against the tree.

c. Securing Cable at Dead-ends. Make the attachments at dead-ends the same as for the first tree (*a* above). Store at the base of the pole any leftover cable in the length.

73. Securing Cable at Corners Using Poles

a. Where it is necessary to stabilize the pole against temporary unbalanced loads, use pike poles or rope guys to supplement existing corner and dead-end guys.

b. At corners having a pull of 20 feet or more, proceed as follows:

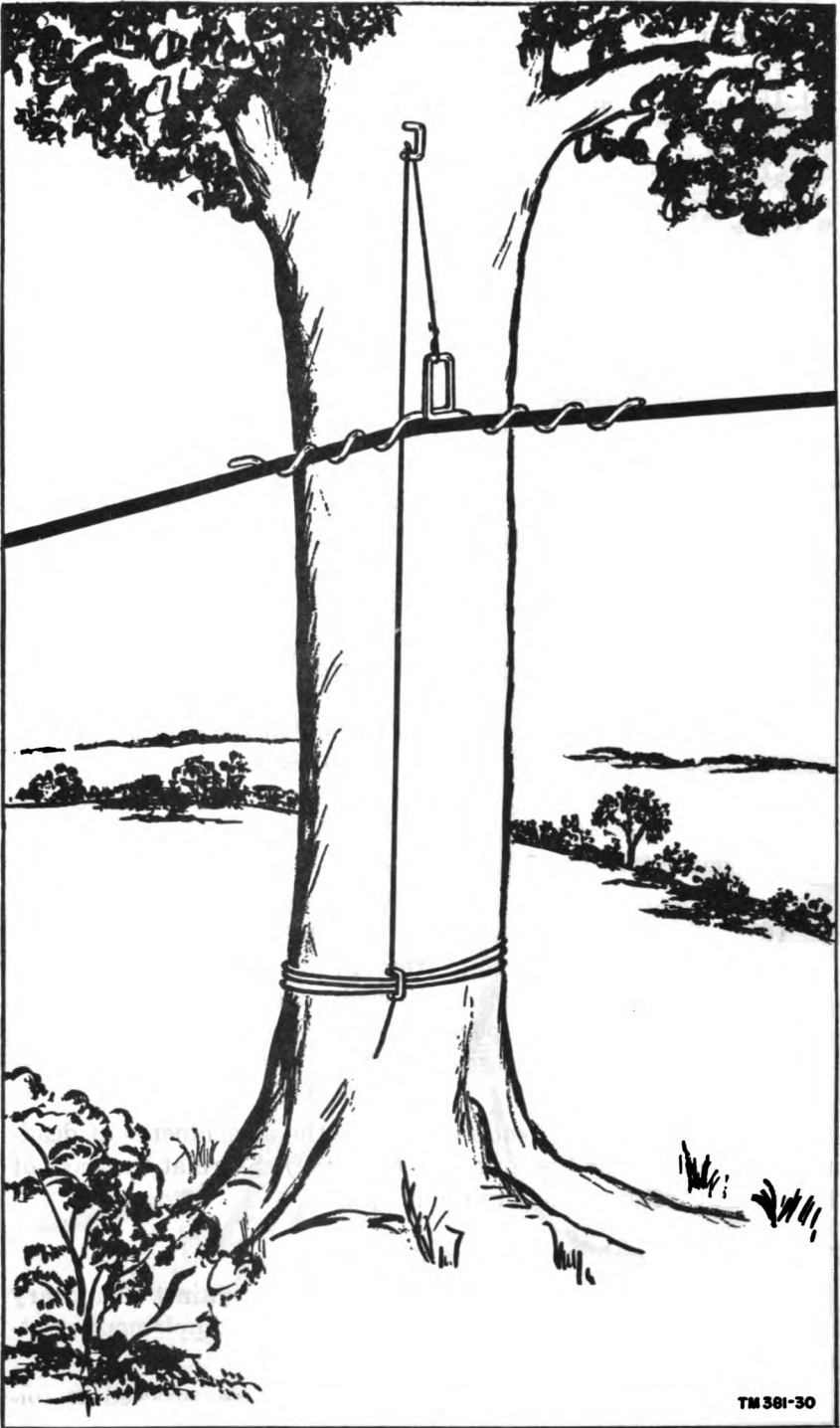

TM 381-30

Figure 25. Tying cable to tree, using field-wire sling.

- (1) Support the cable on the drive hooks of the poles before the corner.
- (2) Take a position at the base of the corner or dead-end pole. Apply a temporary cable clamp or basket hitch to the cable at a point about 3 feet from the pole. Fasten the end of a handline to the cable clamp or basket hitch.
- (3) Pass the handline over the drive hook on the corner or dead-end pole and pull the cable up to final tension. Place a regular cable clamp or basket hitch dead-end attachment on the drive hook.
- (4) Remove the temporary cable clamp or basket hitch and the handline.
- (5) Place a second cable clamp or basket hitch on the other side of the drive hook to take up the tension when stringing the cable beyond the corner. Allow a small amount of slack between the two dead-end cable clamps, so that the cable will not be pulled taut when tension is applied (fig. 26).

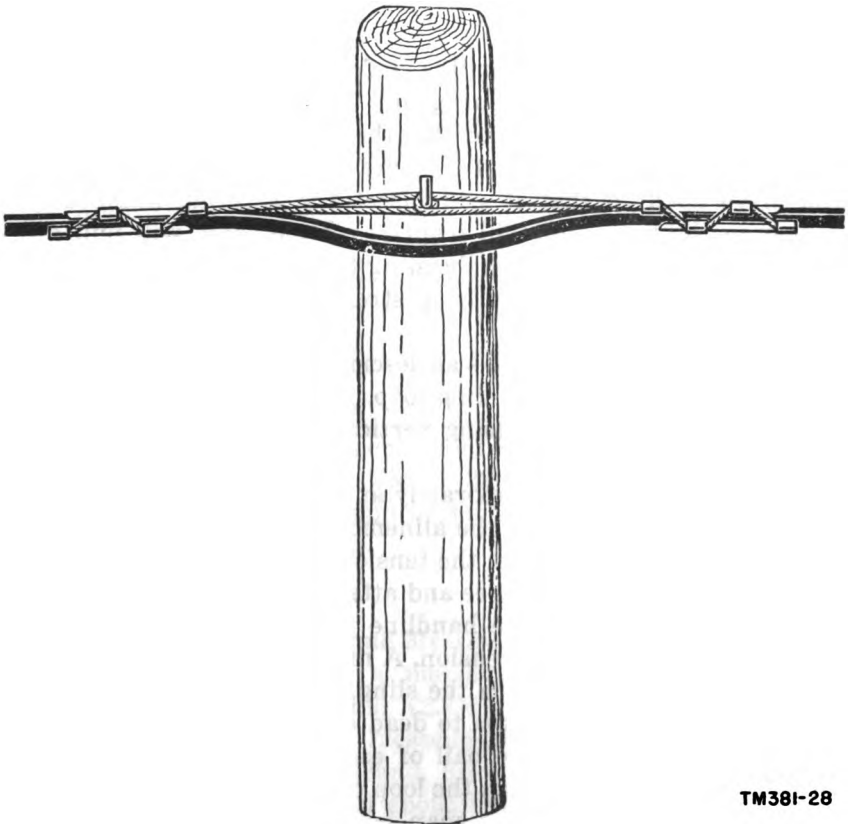

TM381-28

Figure 26. Double dead end attachment made with cable clamps.

c. If a corner has a pull of less than 20 feet, cable hangers may be used as supports, except when a connector location normally would fall within a span adjacent to the corner pole (*d* below). When hangers are used, the cable is strung in the same manner as for a straight section of line (par. 71c(1)).

d. When connectors are adjacent to corner poles, the field-wire suspension described in paragraph 71c(1) may be used if the pull is less than 10 feet. The method described in *e* below, however, is the preferred method.

e. If a connector location normally would fall within a span adjacent to a corner with 10 feet or more of pull, locate the connectors at the corner pole or the pole preceding the corner. Dead-end the cable in both directions with cable clamps (fig. 26) or basket hitches. Coil (in figure 8's) any excess cable resulting from moving the connector location to the pole, bind the coil, and lash it to the pole. Suspend the connectors at a convenient height from the ground.

74. Securing Cable at Corners Using Trees (fig. 27)

a. At corners where the pull is 20 feet or more, use a sling similar to the one described in paragraph 72a for the first tree, adding a second guy in such a position that the two guys will hold the lower end of the sling loop at least 6 inches from the corner tree. Place the drive hook so that it will bisect the *external* angle of the corner in the line. This will insure that the cable will pull away from the tree and will allow the sling to move out from the tree in a direction which will minimize stress on the guys due to tree sway.

b. Make the sling and guys as described in paragraph 72a, passing both guys through the sling loop. Adjust the two guys so that the sling loop appears to hang vertically when the drive hook is viewed head on.

c. Tension the cable temporarily at the base of the corner tree, judging proper tension by the alinement of the preceding suspension. Place a cable clamp on the tensioned cable at a point about 4 feet from the base of the tree and attach a handline to the bail of this cable clamp. Pass the handline through the sling loop and again pull the cable up to tension. A man on the tree should aid in easing the handline through the sling.

d. Place two cable clamps to dead end the cable in each direction at the sling. Pass the bail of each cable clamp through the sling loop as well as through the loop of the guy which leads in the opposite direction from the span being dead ended. Release the handline and remove the temporary cable clamp to which it is tied.

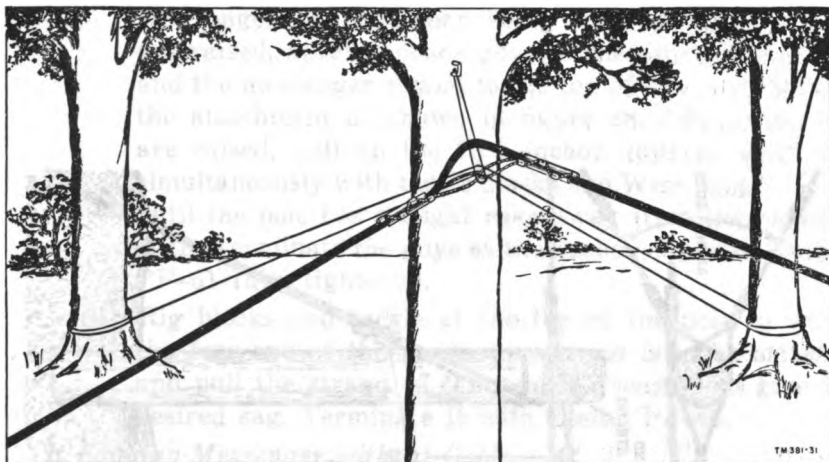

Figure 27. Securing cable to trees at corners and bends in route.

Section V. CONSTRUCTION OF MESSENGER-SUPPORTED AERIAL CABLE LINES

75. General

a. Where occasional span lengths of 300 feet to 500 feet are found necessary, or where proper clearances cannot be obtained in spans under 300 feet in length (par. 64), messenger-supported aerial cable lines of the general type shown in figure 28 should be used. A messenger strand, correctly sagged, is strung between two poles of suitable height which have been properly guyed. The cable is put onto the strand with cable hangers or cable rings, or by lashing. The general construction requirements for normal length spans are used (pars. 59-74), with the exceptions given in paragraphs 76 and 77.

b. If the major portion of the line is to be messenger-supported, the poles, guys, and messenger strand should be erected according to the instructions given in TM 11-2263. The cable should be secured to the messenger strand by using cable hangers (par. 77) or cable rings, or by lashing.

76. Erecting Supports

a. *Placing Anchor Guys and Messenger Strand.*

- (1) Figure 28 shows a messenger-supported aerial cable span. A 2,200-pound (2.2M) galvanized-steel strand is used for guys and messengers. Clamps PF-61 are used to terminate the strand. For each anchor guy, provide a piece of guy strand about twice the length of the poles to be guyed. The messenger strand should be about 20

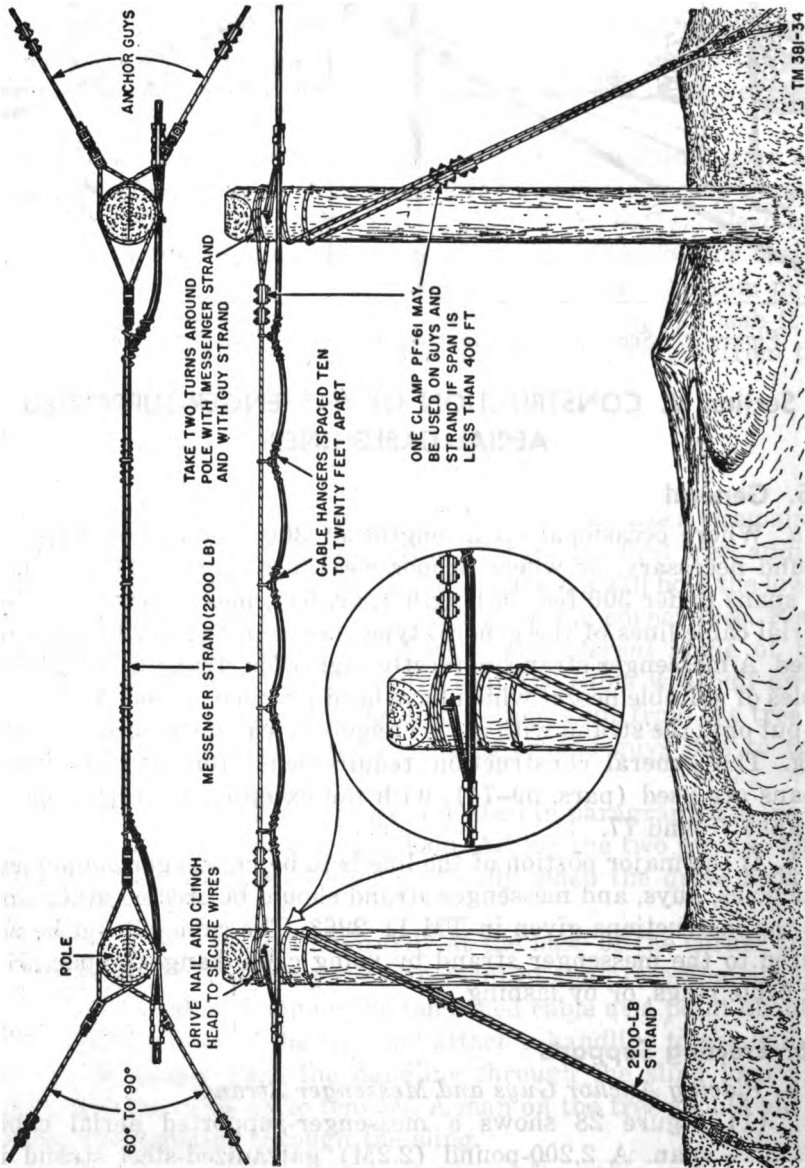

Figure 28. Messenger-supported aerial cable span.

feet longer than the span being built. Before the poles are raised, attach anchor guys to the top of both poles and the messenger strand to the top of one pole, making the attachment as shown in figure 28. After the poles are raised, pull up the two anchor guys on each pole simultaneously with tackle blocks and Wire Grips LC-28, until the pole has a slight rake away from the crossing span. Terminate the guys at the anchor end with Clamps PF-61 fully tightened.

- (2) Rig blocks and tackle at the top of the pole to which the free end of the messenger strand is to be attached and pull the strand to the tension required to give the desired sag. Terminate it with Clamp PF-61.

b. Sagging Messenger without Cable.

- (1) Chart A on page 70 gives the minimum sags at various temperatures for 2.2M strand to which one spiral-four cable is to be attached. Values are given for the strand to which cable will be attached by cable hangers or cable rings and by lashing, in medium loading areas.
- (2) Note that the sags given for installation of the cable on cable hangers or cable rings are considerably greater than those given for installation of the cable by lashing. The difference occurs because the ice and wind load is assumed to be greater for cable installed on cable hangers or cable rings. Also note that the large sags given for the longer spans are practical only where proper clearances can be obtained, such as in crossing valleys or streams with high banks.
- (3) The sags given in (1) above may be measured by the oscillation method described in paragraph 65b. This method is applicable to the strand only. It does not apply when cable is suspended from the strand. Chart B on page 70 gives the time for 10 oscillations in spans of given lengths, at proper sags, and at the stated temperatures. Values are given for strand to which one spiral-four cable will be attached by cable hangers or cable rings, and by lashing. If the time exceeds that given in the table, pull up the strands; if it is less than that given, slack off the strand.

c. Sagging Messenger with Cable Attached. In some instances, such as in crossing wide streams, it is difficult to attach the cable to the messenger after the messenger has been strung. In these instances, the cable is lashed to the messenger before stringing; the messenger and cable then are sagged as a unit. The chart

Chart A

Minimum sags for 2.2M strand at various temperatures
(medium loading areas)

Span length (ft)	Sag (in.)														
	For installation of cable on cable hangers or cable rings				For installation of cable by lashing				For installation of cable by lashing						
	0° F.	30° F.	60° F.	90° F.	120° F.	0° F.	30° F.	60° F.	90° F.	120° F.	0° F.	30° F.	60° F.	90° F.	120° F.
200	11	14	17	22	27	7	8	10	13	16	7	8	10	13	16
300	78	83	88	93	97	49	56	62	69	76	49	56	62	69	76
400	174	179	183	187	192	130	136	142	147	153	130	136	142	147	153
500	307	311	315	319	323	235	240	246	251	256	235	240	246	251	256

Chart B

Time for oscillations in 2.2M strand at various temperatures

Span length (ft)	Time (seconds)														
	For installation of cable on cable hangers or cable rings				For installation of cable by lashing				For installation of cable by lashing						
	0° F.	30° F.	60° F.	90° F.	120° F.	0° F.	30° F.	60° F.	90° F.	120° F.	0° F.	30° F.	60° F.	90° F.	120° F.
200	9.6	10.8	11.9	13.5	15.0	7.6	8.2	9.1	10.4	11.5	7.6	8.2	9.1	10.4	11.5
300	25.5	26.3	27.1	27.8	28.4	20.2	21.6	22.7	24.0	25.2	20.2	21.6	22.7	24.0	25.2
400	38.1	38.5	39.0	39.5	40.0	32.9	33.7	34.4	35.0	35.7	32.9	33.7	34.4	35.0	35.7
500	50.6	50.9	51.2	51.6	51.9	44.3	44.7	45.3	45.8	46.2	44.3	44.7	45.3	45.8	46.2

below lists the sags at various temperatures for one cable lashed to 2.2M strand in medium loading areas.

Minimum sags for 2.2M strand with one spiral-four cable attached (medium loading areas)					
Span length (ft)	Sag (in.)				
	0° F.	30° F.	60° F.	90° F.	120° F.
200	12	14	17	20	23
300	57	62	67	72	77
400	138	143	148	153	158
500	241	246	251	257	261

77. Placing Cable in Messenger-Supported Spans

Slack cable equal to the lengths of the long span, plus the height of the near pole, is made available at the near pole (par. 39c). The cable is placed on the strand with cable hangers and the installation is otherwise completed as described in paragraph 42, except that the eye of each hanger is twisted about 45° to prevent the hanger from binding on the strand as the cable is pulled out into the span. If it is feasible to string the cable in the long span immediately upon arrival of the cable-laying truck, hold the truck at the location during this operation to avoid the necessity for storing the considerable slack that otherwise would be left at the base of the far pole when the work is completed. Enough Telephone Cable Assemblies CX-1606/G may be inserted beyond the crossing to provide extra length, equal to the crossing span, if it is desirable to keep the cable-laying truck moving. These cable assemblies are removed later by the team which has completed the aerial crossing, and the cable is connected through in normal fashion.

Section VI. CONNECTIONS TO OPEN WIRE LINES AND TO UNATTENDED REPEATER EQUIPMENT

78. Connecting Spiral-four Cable to Open Wire Lines (fig. 29)

a. Prepare a cable stub by splicing a few feet of insulated paired Wire W-69-A to each pair of cable-stub conductors, as described in (1) through (5) below.

- (1) Skin the insulation from the ends of two 4-foot pieces of twisted-pair wire. If a pressed sleeve splice is to be used, skin the insulation for a distance equal to half the length of the splicing sleeve. If a twisted conductor joint is to be used, skin about 3½ inches of insulation

from each wire. Do not nick the conductors. Clean the skinned conductors. Remove an additional 2 inches of braid from the conductors.

- (2) Splice one pair of insulated wires to the colored pair of the cable stub and the other pair of insulated wires to the natural pair of the cable stub. Use the pressed sleeve method described in paragraph 89 or the twisted conductor method described in paragraph 90.
- (3) Insulate the spliced conductors individually with polyethylene tape, extending the tape to cover $\frac{3}{4}$ inch of insulation on twisted pair and cable-stub conductors. Apply the tape in the manner described in paragraph 89.
- (4) Place a serving of polyethylene tape over the entire splice, extending it to the insulation of the twisted pair and 2 inches over the jacket of the cable. The steel braid termination of the cable stub does not need to be connected to a wire or to ground; it may be laid up with four spliced conductors under the polyethylene tape serving.
- (5) Apply two half-lapped layers of friction tape, carrying them 1 inch beyond the ends of the polyethylene tape.

b. Place bridle rings on the underside or in back of the open-wire dead end cross arm, spaced at approximately 8- or 10-inch intervals, from the pole to a point midway between the two open-wire pairs to which the cable is to be connected. Thread the insulated wires and the end of the cable stub through these bridle rings until the splice is adjacent to the last ring. If necessary, tie the end of the cable stub to the pole or cross arm to prevent it from slipping back out of the rings.

c. Terminate the twisted-pair wires on the open wire with bridging connectors as shown in the detailed view of figure 29. Use No. 2A bridging connectors with 080 line wire; use No. 3A with 104 wire.

d. Coil any excess cable and tie the coil to the pole. Leave the connectors free, so that they can be connected and disconnected without disturbing the lashings and ties of the coil. Join the connectors and tie them to the coil. The completed job should appear as shown in figure 29.

79. Siting Telephone Repeater AN/TCC-11

Telephone Repeater AN/TCC-11 is the unattended repeater used with the 12-channel carrier telephone system (par. 4c). Under normal conditions, Telephone Repeater AN/TCC-11 is pole-mounted (par. 80) when the spiral-four cable is installed as

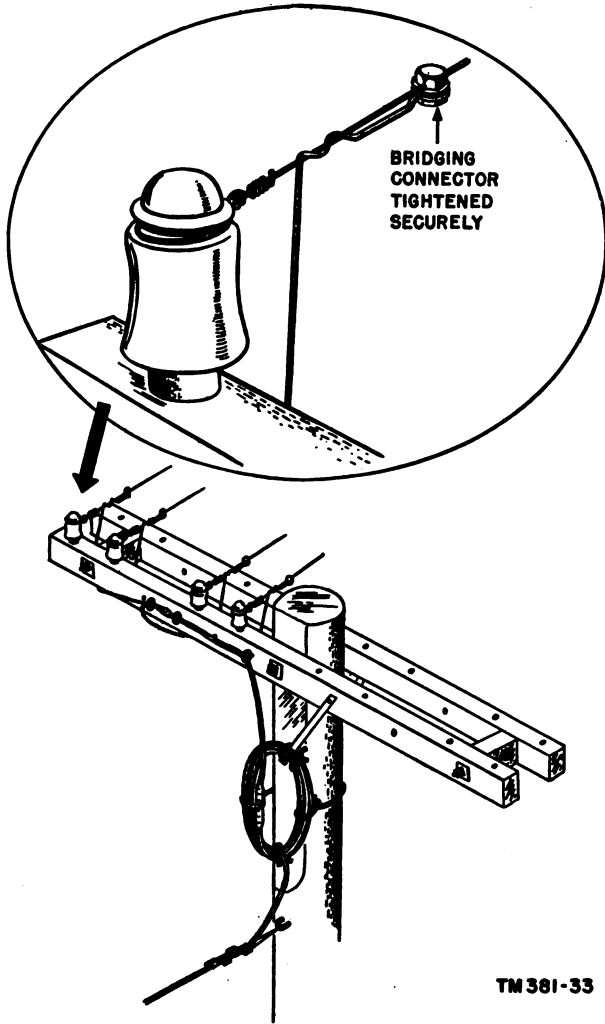

Figure 29. Connecting spiral-four cable to open-wire line.

an aerial line or placed on the ground when the spiral-four cable is installed as a surface line. If the cable is buried, the repeater should be covered with tarpaulin or some similar protective material and buried. For best performance, Telephone Repeater AN/TCC-11 should be installed so that its temperature will remain about the same as that of the cable, regardless of changing conditions. Figure 30 shows preferred and bad locations for the AN/TCC-11.

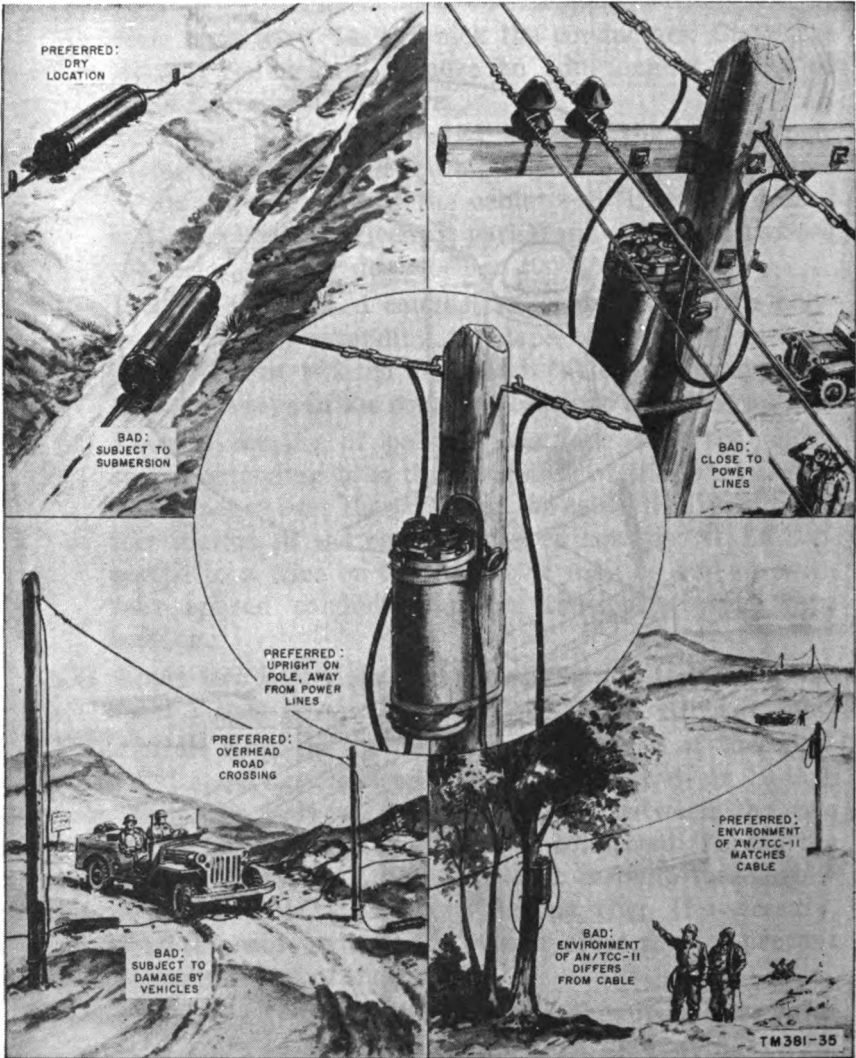

Figure 30. Siting Telephone Repeater AN/TCC-11.

80. Installation of Telephone Repeater AN/TCC-11 on Pole (fig. 31)

Telephone Repeater AN/TCC-11 is mounted in an upright position on telephone poles, or trees, with the J1 end on top. Install Telephone Repeater AN/TCC-11 in the following manner:

- a. Install two drive hooks vertically at the desired height, about 2 feet apart, into the opposite side of the pole from the side on which the répeater is to be mounted.

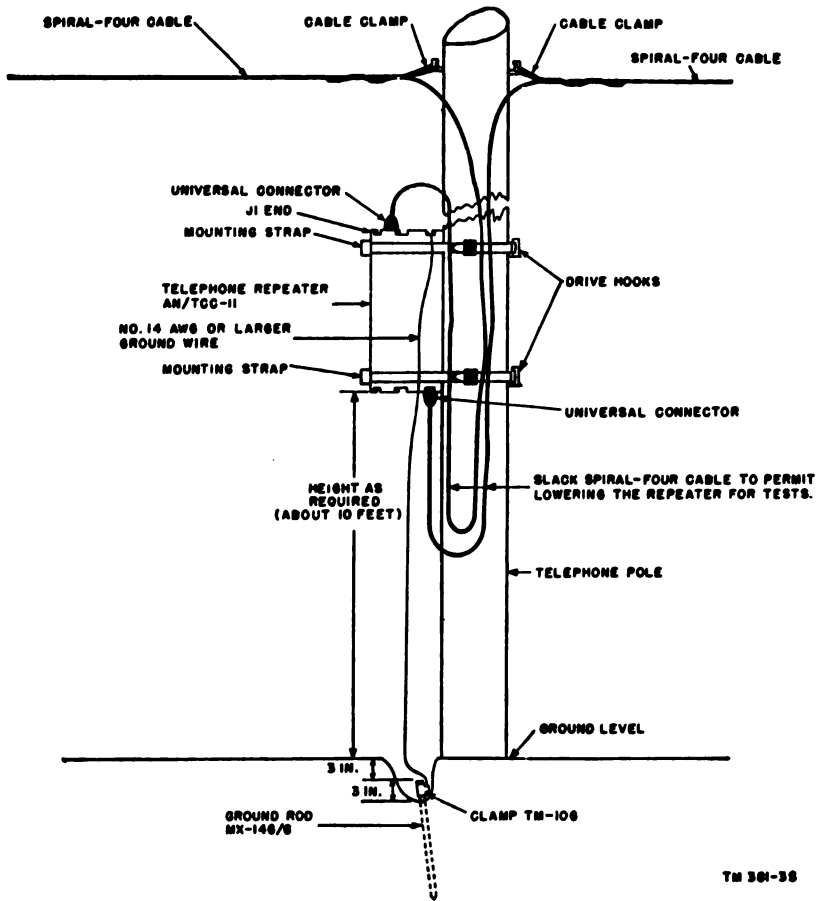

Figure 31. Telephone Repeater AN/TCC-11, mounted on pole.

- b. Unbuckle the two 7-foot webbing straps and remove both from the repeater case. Pass one strap through each strap-retaining bracket.
- c. Use a suitable pulley, a block and tackle, or other means to raise the repeater. Place the repeater against the pole with the J1 end on top.
- d. Wrap both straps around the repeater and the pole about 2 feet apart, and pass the straps through the two drive hooks, as many times as the lengths of the strap will permit.
- e. Buckle both straps and pass the ends under a preceding turn.
- f. Attach spiral-four cables from both directions to the top of the pole with cable clamps or basket hitches.

g. Allow enough slack cable to loop between the cable clamps or basket hitches and the repeater to permit lowering of the repeater to the ground for making operational checks.

h. Connect Telephone Repeater AN/TCC-11 to a suitable ground (par. 81).

i. Insert the connector on the cable from one attended point into receptacle J1 on the J1 end of the repeater. The carrier equipment attendants will determine which cable to connect.

j. Insert the connector on the cable from the other attended point into receptacle J2 on the J2 end of repeater.

81. Grounding Telephone Repeater AN/TCC-11

Telephone Repeater AN/TCC-11 must be grounded to protect personnel and equipment from lightning and other sources of high voltage. Use the following procedure to ground the equipment:

a. Connect one end of a suitable length of #14 AWG wire or larger to the GND binding post on the J1 end panel and tighten the wingnut on the binding post.

b. Scoop out a small hole approximately 6 inches deep at the location selected for the ground rod.

c. Clean paint or grease from Ground Rod MX-148/G.

d. Drive the ground rod into the hole until the top of the rod is approximately 3 inches above the bottom of the hole.

e. Connect Clamp TM-106 to the protruding portion of the ground rod.

f. Connect the wire from the GND binding post to the clamp.

g. Saturate the ground around the rod with water.

h. Utilize all existing buried metal piping or other ground whenever possible.

CHAPTER 4

MAINTENANCE

Section I. PREVENTIVE MAINTENANCE SERVICES

82. Definition of Preventive Maintenance

Preventive maintenance is work performed on equipment to keep it in good working order, so that breakdowns and needless interruptions in service will be kept to a minimum. Preventive maintenance includes servicing, cleaning, tightening, inspection, and minor repairs as may be made at organizational maintenance level. Preventive maintenance differs from troubleshooting and repair, because its object is to prevent certain troubles from occurring.

83. Preventive Maintenance Tools, Test Equipment, and Materials

The tools, test equipment, and materials listed in *a* through *c* below are issued for use in performing organizational maintenance.

a. Tools.

- (1) Lineman's Equipment TE-21.
- (2) Tool Equipment TE-33.

b. Test Equipment.

- (1) Test Set TS-26 ()/TSM.
- (2) Test Set TS-27 ()/TSM.
- (3) Telephone Set TA-43/PT or equal.

c. Materials and Supplies.

- (1) Telephone Loading Coil Assembly CU-260/G.
- (2) Telephone Cable Assembly CX-1512/U.
- (3) Telephone Cable Assembly CX-1606/G.
- (4) Cable Assembly CX-1065/G.
- (5) Cable Hanger PF-203/G.
- (6) Clamp Electrical Conductor, Strain PF-211 ()/G.
- (7) Hook PF-81.
- (8) Wire WD-1/TT.
- (9) Insulation Tape, Electrical TL-600 ()/U (for use in arctic climate).
- (10) Insulation Tape, Electrical TI-636 ()/U (for use in temperate climate).
- (11) Friction Tape TL-83.

(12) Splicing sleeve, bronze (SN 6N5617.1).

(13) Sleeve Compressing Tool TL-190.

Note. The Cable Assemblies CX-1065/G listed in (4) above are the longer lengths set aside for maintenance purposes before construction (par. 36). The minimum length is 1,320 feet.

84. General Preventive Maintenance Techniques

a. Preventive maintenance of cable circuits is performed by trained personnel who make routine patrols and inspections of the cable route. The amount of preventive maintenance, as well as the organization and the equipment of the maintenance teams, generally will be determined by local conditions and the type of cable line construction. Wire patrol teams, to be effective, must carefully inspect every foot of the cable route in the sections that they cover. Minor troubles, easily overlooked, may cause line failures as serious as those caused by direct bomb hits.

b. Ordinarily, aerial or surface cable lines require more preventive maintenance than buried lines. Preventive maintenance patrol teams should locate and remedy any potential sources of line failure and, in general, improve line construction. If the repair or replacement work is beyond the capacity of the wire patrol team, the location, type of remedial action required, and estimate of materials needed should be recorded and submitted to a delegated superior upon completion of the patrol. Construction or trouble clearing teams then will be dispatched. If immediate major repairs are necessary, the patrol should communicate at once with the nearest repeaterman, wire chief, or a designated officer. Preventive maintenance techniques for the three basic types of cable construction are contained in paragraphs 85, 86, and 87.

Note. Never open a cable circuit for repairs until the wire chief has been consulted and until it has been ascertained that working circuits will not be affected.

Section II. PERFORMING PREVENTIVE MAINTENANCE

85. Preventive Maintenance of Surface Cable Lines

a. Spiral-four cable laid on the ground requires particular attention because it is subject to many more types of damage than buried or aerial cable. The entire length of the cable line should be examined carefully, especially at sharp curves or turns in the route and at points where the cable appears to be stressed. Be on the alert for stone bruises, abrasions, cuts, and sections that may have been crushed by vehicles, animals, ground troops, or shell fire.

b. Inspect all anchorages. Be sure that they are secure and that the connections to them are in good condition. Replace all anchorages or connections that appear to be weak. Inspect the cable insulation at all anchorages.

c. Check all connector locations carefully. Be sure that all connectors are tight. If loading coils are used, be sure that they are in place and appear in good condition. Replace all damaged loading coils.

d. Repair all minor damages to the cable (par. 92). Test all repaired assemblies (pars. 110 and 111) before restoring them to service.

e. Replace cable assembly in which the conductors have been damaged and return it to the depot for repair. If time does not permit replacement, make a temporary field repair (pars. 88-90) and replace as soon as possible. Be sure that the replacement length is long enough to replace the defective length.

86. Preventive Maintenance of Buried Cable Lines

a. Buried cable is relatively safe from damage but it is difficult to inspect. The principal evidence of possible damage is a disturbance of the ground surface over the cable. If the ground surface over the cable appears broken to any significant depth, carefully dig the earth away and inspect the cable for cuts and abrasions.

b. Cuts that have penetrated the cable covering but have not damaged the conductors should be taped (par. 92) to make the repaired section waterproof. Cable assemblies in which the conductors have been damaged are handled as described in paragraph 85e. Test all repaired assemblies (pars. 110 and 111) before restoring them to service.

c. Cable which has been exposed by washouts or other ground disturbances should be examined for damage, repaired if necessary, and buried again. Take any steps necessary to prevent recurrence of the situation.

87. Preventive Maintenance of Aerial Cable Lines

a. Observe the condition of all structures used to support the cable. Check all supporting ties, guys, and messenger strands for signs of weakness. Check poles and trees (supporting cable) for rotting and similar defects. Replace any defective item, if possible; otherwise, make a note of the trouble and report it to the delegated supervisor.

b. Examine the cable under the cable clamp or basket hitch to see if the cable is damaged. Repair all abrasions on the cable jacket (par. 92).

c. Check all tension bridges at locations where connectors are placed in the span. Be sure that the cable is not being bent sharply.

d. Check to see that the ground clearances are adequate (par. 66). Make the construction changes necessary to obtain the required clearance, if possible; otherwise, report the problem to the delegated supervisor.

Section III. FIELD REPAIR OF CABLE

88. General

a. After a cable fault has been located, communication over the cable should be restored as soon as possible. In many cases, the fastest method of restoring service over a faulty cable is to replace the defective section with another Cable Assembly CX-1065/G. If replacement of the defective section is time consuming, cut out the defective portion and make a temporary field splice (pars. 89 and 90). *As soon as practical, replace the spliced cable section with a good Cable Assembly CX-1065/G.* The replacement CX-1065/G should be one of the longer lengths set aside for this purpose before construction (par. 36) and must have not more than one splice, including factory or depot splices. The minimum length is 1,320 feet.

b. When replacing or splicing aerial cable, special precautions are required when lowering the cable to the ground. Before lowering the cable, back guy the poles on each end of the ¼-mile section being lowered or at the points where slack is stored to prevent the unbalanced load from stressing the poles, pins, cross arms, and cable ties. If the cable is supported by cable hangers at these poles, replace the cable hangers with cable clamps to prevent the slack from running in both directions as the cable is lowered to the ground.

c. When replacing or splicing buried cable, it may be necessary to locate the cable if the cable path is not marked clearly. A method of tracing the path of the cable is given in paragraph 112. Methods of recovering buried cable are given in paragraphs 133 through 136.

89. Procedure for Making Field Splices with Sleeves

Note. The field splice (*a-n* below) has very little tensile strength. Cable clamps must be used to take tension off the finished splice (par. 91). If cable clamps are not available, prepare a basket hitch with field wire. Replace spliced cable sections with new cable sections as soon as possible. Prepare both cable ends for splicing by following the procedure outlined in *a* through *f* below. Complete the splice by following the procedure outlined in *g* through *o* below.

a. Cut through the outer jacket completely around the cable (A, fig. 32) about 2 inches from the point to be spliced. Make two longitudinal slits in the jacket on opposite sides of the cable. Extend the slits from the cut to the point to be spliced. Use pliers to remove the cut pieces of the outer jacket from the cable.

b. Loosen the exposed wire braid. Use a screwdriver to separate the strands (B, fig. 32). Apply a few turns of friction Tape TL-83 around the outer jacket just back of the cut end so that when the braid is folded back, the ends of the braid will not penetrate the outer jacket. Fold the braid wires over the friction tape and tape them tightly against the cable (C, fig. 32).

Caution: The ends of the braid wire are sharp. Handle them carefully to avoid injury to the hands.

c. Remove the cloth tape (C, fig. 32) from the inner jacket.

d. One-half inch from the end of the outer jacket, cut a nick all the way around the inner jacket (D, fig. 32). Be careful to cut only part way through the inner jacket. Flex the inner jacket and conductors until the inner jacket separates at the nick. Make a $\frac{1}{4}$ -inch longitudinal cut through the inner jacket at the end of the cable (D, fig. 32). Make the cut in such a manner that two conductors are on each side of the cut. Grasp one cut end of the inner jacket with side cutting pliers and pull outward. The inner jacket will peel away from the insulated conductors. Remove the other end of the inner jacket in the same manner.

e. Cut the central filler close to the end of the inner jacket.

f. Remove the insulation from the conductor for a distance equal to half the length of a bronze splicing sleeve (stock No. 6N5617.1) and clean each conductor. Do not nick the conductors.

g. Push one of the skinned conductors into one end of the splicing sleeve until the insulation touches the sleeve. Push a conductor from the other cable into the other end of the sleeve (A, fig. 33). Be careful to splice together conductors of the same color. Compress the sleeve with Sleeve Compressing Tool TL-190. Crimp the sleeve in two places over each conductor end.

h. Wrap the sleeve with two half-lapped layers of polyethylene tape (B, fig. 33). Stretch the tape to approximately twice its original length while wrapping it about the sleeve. Start the polyethylene tape at the center of the sleeve and wrap the tape to one-fourth inch beyond the end of the conductor insulation. Reverse, and wrap to one-fourth inch beyond the end of the conductor insulation at the other end of the sleeve. Reverse again and end the wrapping at the center of the sleeve. Cover the polyethylene tape with a layer of friction Tape TL-83 wrapped spirally from one end of the splice to the other (B, fig. 33).

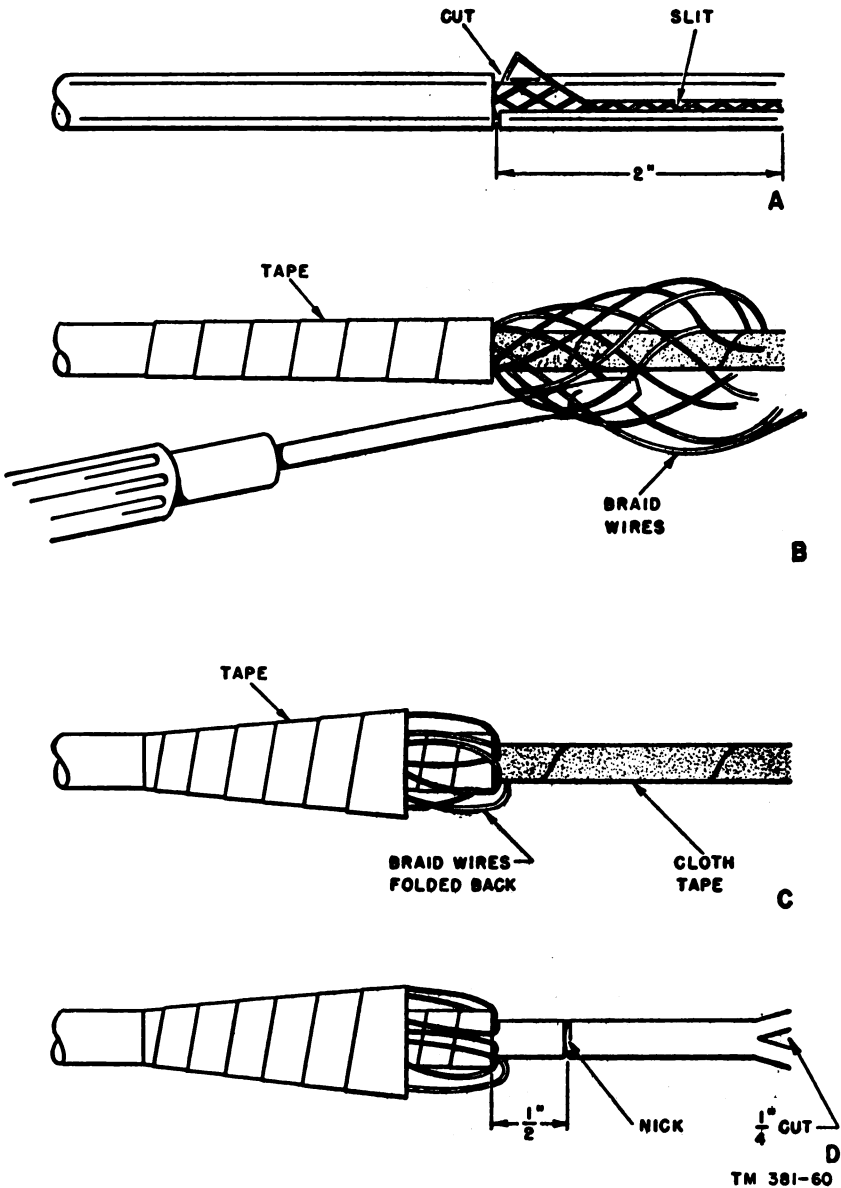

Figure 32. Preparing ends of cable for field splice with sleeves.

i. Repeat the procedure outlined in *g* and *h* above for each of the other three conductors. Be sure to splice together conductors of the same color.

j. Wrap the four spliced conductors with several layers of polyethylene tape. Cover the polyethylene tape with a layer of friction Tape TL-83 (C, fig. 33).

k. To establish electrical continuity through the severed steel braid, connect the steel braid on one side of the splice to the braid on the other side in the following manner. Tightly wrap the exposed steel braid on one side of the splice with 6 turns of copper wire. Lock the end of the copper wire over the second turn and under the third turn. Carry the copper wire spirally across the splice and wrap 6 tight turns around the exposed braid at the other end of the splice (C, fig. 33). The wire for this purpose may be any copper wire .025 inch in diameter (#22 AWG) or larger. A piece of copper conductor removed from damaged cable may be used.

l. Clean and dry the surface of the cable adjoining the splice.

m. Wrap the entire splice with two half-lapped layers of polyethylene tape. Stretch the tape to approximately twice its original length while wrapping it around the splice. Start the polyethylene tape at the center of the splice and wrap to 1 inch beyond the severed steel braid. Reverse, and wrap to 1 inch beyond the severed steel braid at the other end of the splice. Reverse again and end the wrapping at the center of the splice.

n. Wrap a half-lapped layer of friction Tape TL-83 around the splice, starting one-half inch beyond the polyethylene tape and continuing across the splice. End the friction tape one-half inch beyond the polyethylene tape at the other end of the splice (D, fig. 33).

o. Test the splice (par. 99-101) before restoring the cable assembly to service.

Note. In splicing the cable in darkness, make an effort to splice conductors of the same color. If the color cannot be determined, splice the conductors in rotation around the cable. Notify the attendant at the nearest attended point to check for proper pairing of conductors. This is done by inserting two cable stubs with the wire ends together and connecting the wires to give proper continuity.

90. Procedure for Making Field Splices without Sleeves

If expedient field splices must be made when sleeves are not available, use the procedure outlined in *a* through *i* below.

a. Remove $4\frac{1}{2}$ inches of the outer jacket from the ends of the cable to be spliced (A, fig. 34). Use the technique outlined in paragraph 89*a*.

b. Cut the exposed steel braid to a length of approximately 2 inches.

c. Follow the procedure outlined in paragraph 89*b* through *e*.

d. Remove the insulation from each conductor to within one-half inch of the inner jacket (A, fig. 34). Clean the conductors.

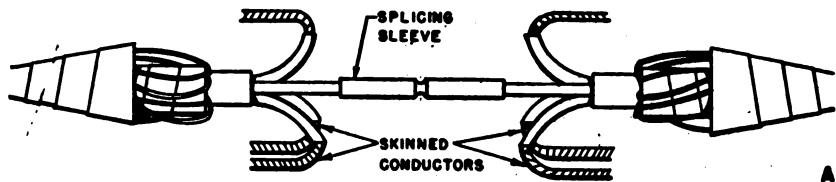

A

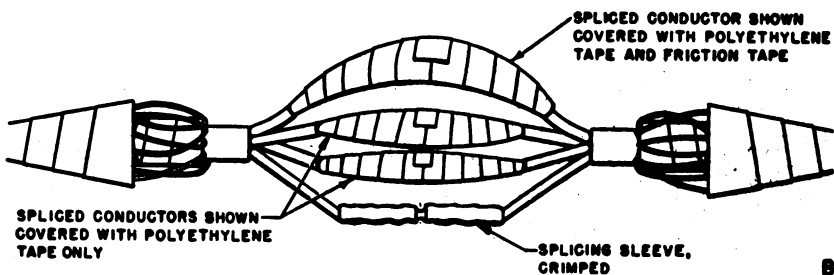

B

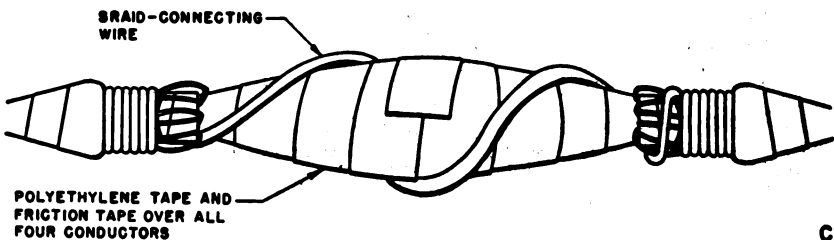

C

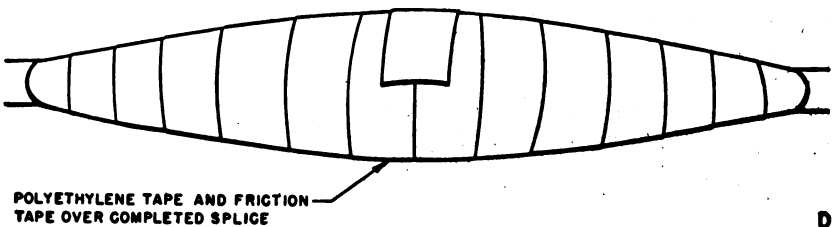

D

TM 381-61

Figure 33. Field splice with sleeves.

e. Select one conductor from each end of the cables to be spliced. Be careful to select conductors with the same color insulation.

f. Twist these conductors together in two loose twists totaling 1 inch in length (B and C, fig. 34). Twist each loose end tightly around the other conductor until the conductor insulation is reached (at least 5 turns) (D, fig. 34).

g. Wrap the splice with two half-lapped layers of polyethylene tape. Stretch the tape to at least twice its original length while wrapping it about the splice. Start the polyethylene tape at the

center of the splice and wrap to one-fourth inch beyond the end of the conductor insulation. Reverse and wrap to one-fourth inch beyond the end of the conductor insulation at the other end of the splice. Reverse again and end the wrapping at the center of the sleeve. Cover the polyethylene tape with a layer of friction Tape TL-83 wrapped spirally from one end of the splice to the other.

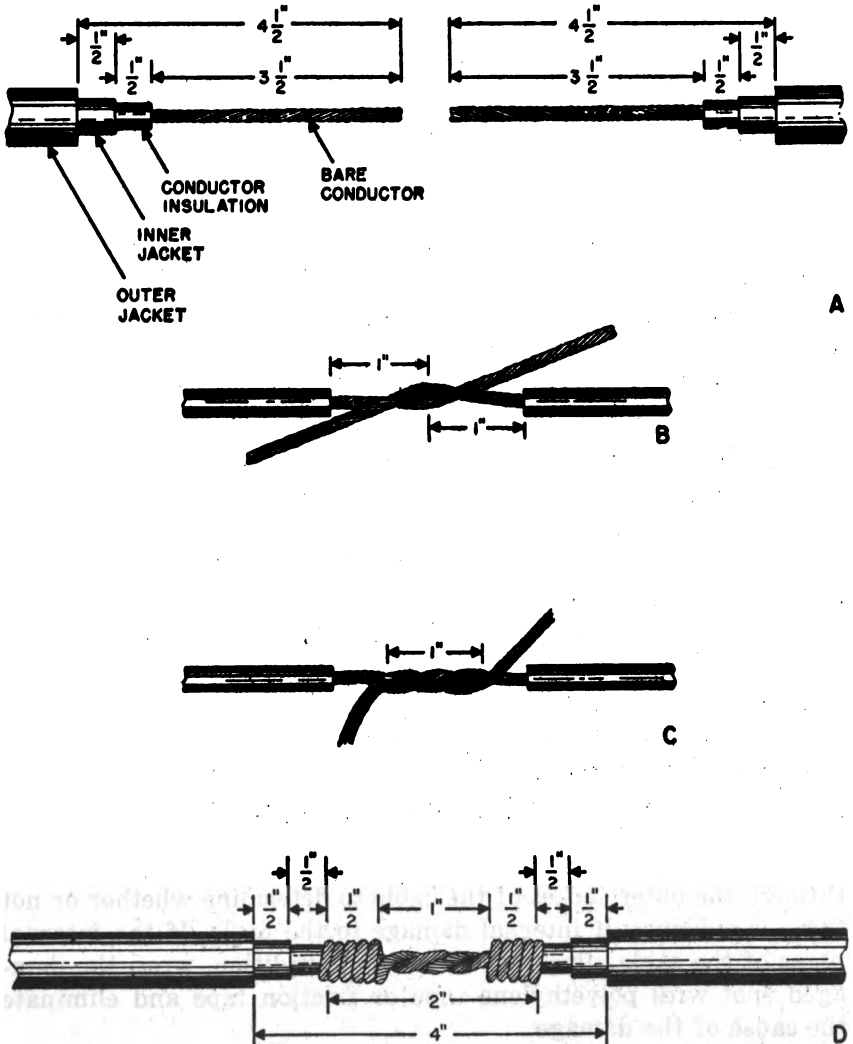

NOTE:
 ONLY ONE CONDUCTOR OF SPIRAL
 FOUR CABLE IS SHOWN.

TM 381-39

Figure 34. Splicing conductor, field splice without sleeves.

h. Repeat the procedure outlined in *e* through *g* above for each of the other three conductors.

i. Use the procedure outlined in paragraph 89*j* through *o* to complete the splice.

91. Tension Bridge for Field Splice

In underground construction, an expedient splice may be buried without any further protection. In surface construction and aerial construction, reinforce the cable by bridging the splice with two cable clamps or basket hitches as shown in figures 35 and 36. When bridging a long splice with cable clamps, tie the two clamps together with a double length of field wire.

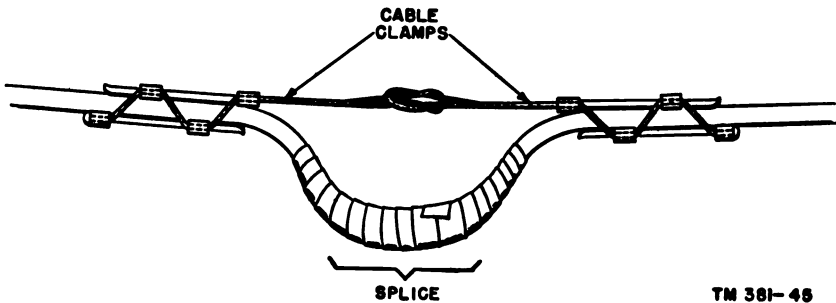

Figure 35. Tension bridge over field splice with cable clamps.

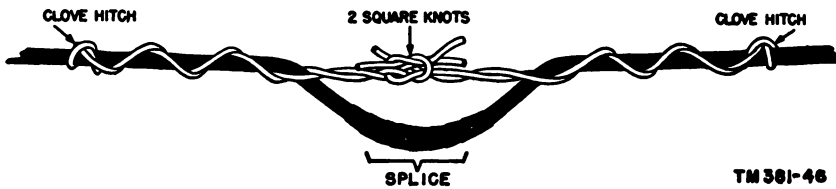

Figure 36. Tension bridge over field splice with basket hitches.

92. Repair of Abraded Cable Jackets

Examine cuts and abraded spots extending only part way through the outer jacket of the cable to determine whether or not there is evidence of internal damage to the cable. If the internal parts of the cable appear to be in good condition, wrap the damaged spot with polyethylene tape or friction tape and eliminate the cause of the damage.

93. Maintenance of Connectors and Loading Coils

a. Procedure at Damaged Connectors or Loading Coils. Damaged connectors and loading coils cannot be repaired and will

have to be replaced. To replace the connector, cut off the damaged connector and splice on a cable stub or an undamaged connector removed from a damaged cable assembly. Use the splicing procedures described in paragraphs 89 and 90. To replace the loading coil, disconnect the damaged coil and insert the new one (par. 15).

b. Cleaning Connector Faces. Occasionally, trouble (especially crosstalk and noise) will occur in a line because moisture has penetrated past the sealing lip (fig. 5). To correct this condition, separate the connectors and clean the connector faces. Use a clean, dry, lintless cloth to remove dirt and moisture. Examine the sealing lips for cuts or other defects which will prevent a tight seal. If the sealing lip or other parts are defective and permit moisture to enter, replace the connector or loading coil, whichever contains the connector face (a above).

CHAPTER 5

TESTING

Section I. TESTING PROCEDURES

94. General

This chapter covers the electrical testing that is required to insure the satisfactory condition of a spiral-four cable line and its component parts (cable assemblies) as it is being built, and upon completion of its installation. The chapter also includes the testing methods used to locate faults that occur after the cable line has been put into service. Refer to FM 24-5, Signal Communications; TM 11-757, Principles of Line Fault Location; and FM 24-20, Field Wire Technique, for additional testing information.

95. Test Equipment Required

The following equipment is used in the electrical testing of spiral-four cable:

a. Test Set TS-27B/TSM. This test set provides a direct-current (dc) bridge for measurements of conductor and insulation resistance and for the location of grounds, crosses, and shorts. It also provides an alternating-current (ac) bridge for measurement of capacitance and for the location of opens. Refer to TM 11-2057A, Test Set TS-27B/TSM.

b. Test Set TS-26()/TSM. This voltohmmeter may be used to detect grounds, crosses, shorts, and opens, and to measure insulation and conductor resistance as well as line and battery voltage. It also may be used for the short or long range location of opens by means of the capacitance kick method. Refer to TM 11-2017, Test Sets TS-26/TSM, TS-26A/TSM, and TS-26B/TSM.

c. Telephone Set TA-43/PT. This is a field telephone primarily used for communication between points along a line.

d. Headset or Telephone Receiver and Battery. This arrangement forms one of the simplest outfits for testing continuity of a circuit. It may be used when testing for any of the common circuit faults, such as opens, grounds, crosses, and shorts (FM 24-5).

e. Test Set I-49 or Resistance Bridge ZM-4A/U or ZM-4B/U. These are compact portable bridges used for dc measurements.

Resistance Bridges ZM-4A/U and ZM-4B/U are essentially the same as Test Set I-49. When provided with auxiliary apparatus such as a buzzer or an oscillator, a capacitor, and a telephone receiver, they can be used also for ac measurements to locate opens. Refer to TM 11-2019, Test Set I-49 and Resistance Bridges ZM-4A/U and ZM-4B/U.

f. Test Set I-48-B or Ohmmeter ZM-21A/U. These are portable, self-contained test sets for the measurement of insulation resistance. Refer to TM 11-2050, Test Set I-48-B and Ohmmeter ZM-21A/U.

96. Testing Precautions

a. Be careful when working on cables that are connected to a working system. The 12-channel carrier telephone system (par. 4) uses the cable to carry power to the unattended repeaters. The voltage used is dangerous and could cause death by electrocution. Have the power removed from the cable before attempting to perform tests on it.

b. Always obtain permission from the attendants at the carrier stations before opening the line to perform tests. Opening the line without first removing power will cause alarms to be indicated at the carrier stations and will result in unnecessary testing and confusion.

c. To obtain accurate results, be sure to make a good electrical connection between the points under test and the test equipment. When making tests on the male and female contacts of the connectors, hold the test probe at an angle to the contact to avoid damaging the plating on the contact.

97. Description of Faults

a. Opens, shorts, grounds, and crosses are common faults in spiral-four cable. These faults (fig. 37) are defined, and methods of detecting and identifying them are covered in FM 24-5. Because of the construction of spiral-four cable, grounds often will be the result of contact between a conductor and the steel braid used to give mechanical strength to the cable. In addition, opens in the steel braid sometimes may be encountered.

b. There are other types of faults of less common occurrence, resulting in noise, crosstalk, poor transmission, singing repeaters, etc. Capacitance or resistance unbalance may cause audible or objectionable crosstalk. Power inductance coupled with unbalances in the cable may cause noise, while various abnormal conditions may cause singing or poor transmission. The determination of the cause of such troubles and the elimination of the cause will be under the direction of the wire chief.

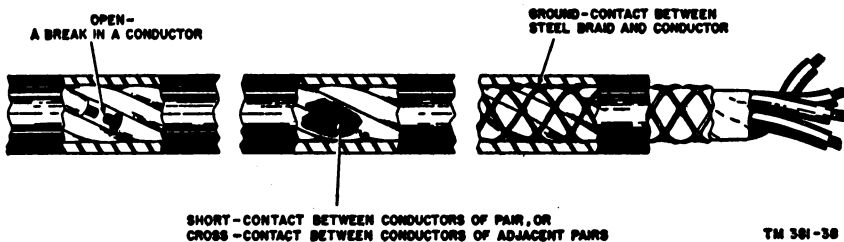

Figure 37. Examples of an open, short, cross, and ground.

98. Test Data

The electrical characteristics of spiral-four cable used in testing and fault location are given in *a* through *c* below. Resistance measurements are used in the location of crosses, grounds, and shorts, and in checking the length of cables. Capacitance measurements are used in the location of opens. Insulation resistance is used as a measure of the condition of the line; that is, when the insulation resistance is high, the line is in better condition for the transmission of electric currents than it is when the insulation resistance is low.

a. Resistance.

- (1) The chart below lists the dc resistance of spiral-four cable at several temperatures. The values shown are approximate.

Temperature (° F.)	Resistance (ohms per loop mile)
— 20	70
0	73
20	77
40	81
60	85
70	87
80	88
100	92
120	96

- (2) The dc resistance of Telephone Loading Coil Assembly CU-260/G is about .75 ohm per winding. Each coil, therefore, contributes 1.50 ohms to the loop resistance of the pair to which it is connected (fig. 42).

- (3) The resistance of the steel braid is approximately 200 ohms for a single Cable Assembly CX-1065/G.

b. Capacitance. The approximate mutual capacitance between conductors of a pair is .021 microfarad (μf) per Cable Assembly CX-1065/G and .083 μf per mile.

c. Insulation Resistance (IR).

- (1) The minimum insulation resistance for one Cable Assembly CX-1065/G or for one mile (four Cable Assemblies CX-1065/G) of new spiral-four cable is 1,000 megohms. The actual values are much higher, but the test equipment available in the field cannot accurately measure insulation resistances over 1,000 megohms. For lengths greater than 1 mile, the minimum insulation resistance allowed can be obtained by dividing 1,000 by the number of miles of cable. As an example, assume that 10 miles of cable (40 Cable Assemblies CX-1065/G) are to be tested. The minimum IR allowed is 1,000 divided by 10 or 100 megohms.
- (2) A cable line may develop low insulation resistance due to numerous causes. If the insulation resistance drops below 1 megohm, regardless of the length of line, the cable line (either loaded or unloaded) is deteriorating to the extent that its usefulness may be impaired. Locate and remove the cause of the low insulation resistance.
- (3) For complete testing of a cable, the insulation resistance must be measured between each conductor in turn, with the other three conductors connected to the steel braid. This arrangement permits a complete test in four measurements.

99. Test for Opens

a. Ends of Cable at Same Point. The following method of testing is to be used when both ends of the cable are available at the same point, such as on a reel.

- (1) With an ohmmeter or other suitable test instrument, make contact to a conductor at one end of the length, and then check to identify this conductor at the opposite end (fig. 38). Lead L1 is connected to wire 1 at end A, and L2 is connected to wire 1 at end B. If an ohmmeter is used, it will indicate the resistance of one conductor. For a single Cable Assembly CX-1065/G, this will be about 10 ohms.
- (2) Lead L1 then is transferred to wire 2 (end A), and L2 is transferred to the other end of wire 2 (end B). In the same way, conductors 3 and 4 are identified and their continuity is checked. If conductors 1 and 2 are terminated on the male contacts of the connector at one end, they should be found in the female contacts at the other end. Similarly, if conductors 3 and 4 are connected to the

female contacts at end A, they should be found on the male contacts at end B.

- (3) To check the continuity of the steel braid, connect each terminal of the ohmmeter to a segment of a connector at each end of the cable assembly. The ohmmeter should indicate approximately 200 ohms.

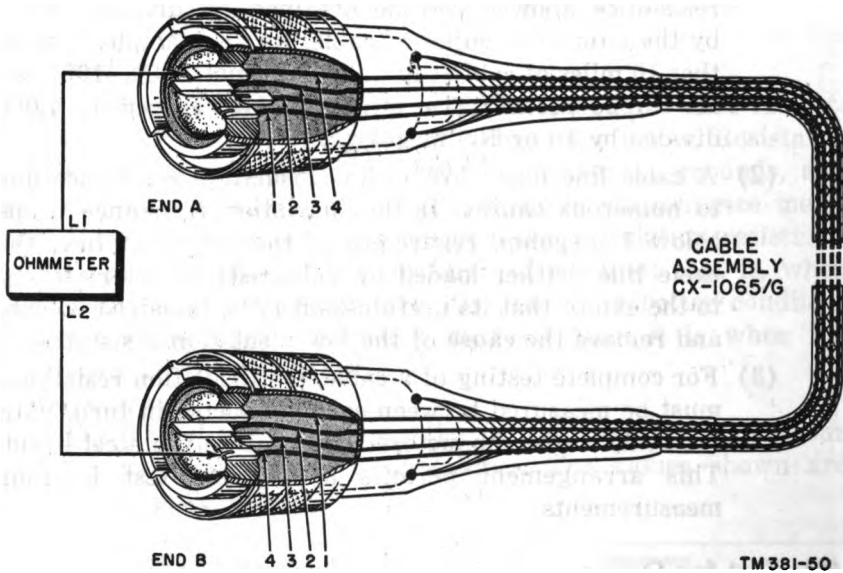
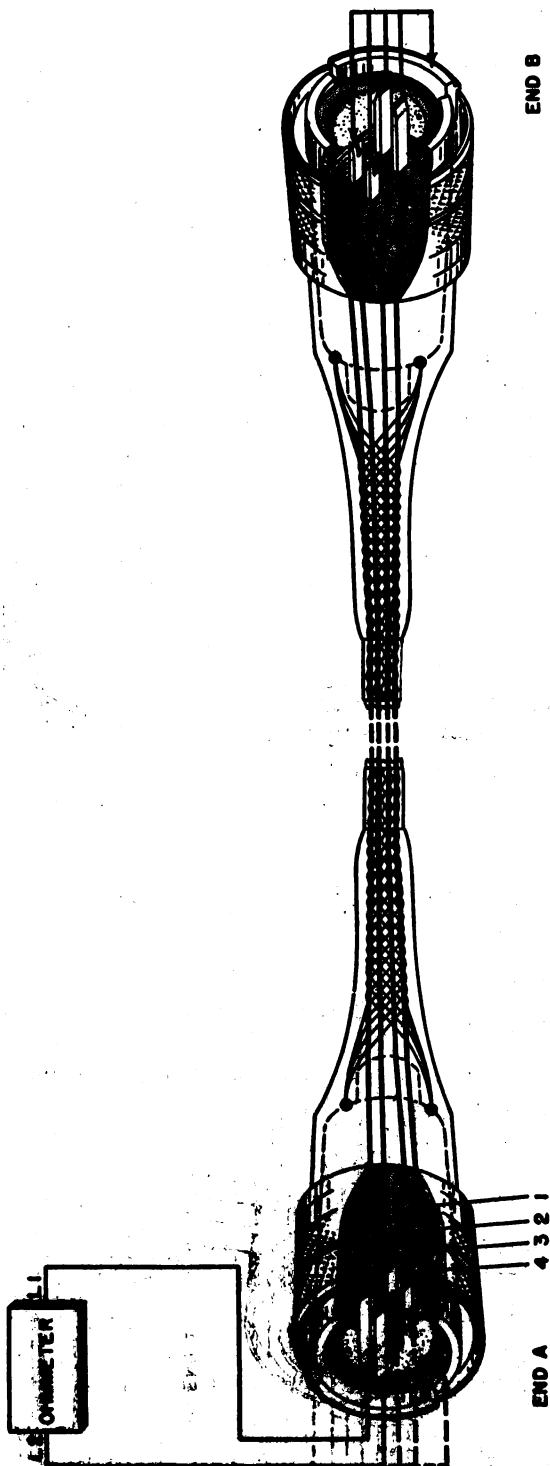

Figure 38. Test for opens, ends of cable at same point.

b. Ends of Cable at Different Points.

- (1) Arrange the far end of the cable (end B) as shown in figure 39.
- (2) Connect lead L1 of the ohmmeter to wire 1. Connect lead L2 to wires 2, 3, and 4 in turn. The ohmmeter should indicate 20 ohms as the loop resistance of the two wires tested in each case.
- (3) With lead L1 still connected to wire 1, connect lead L2 to a segment on the connector to check the continuity of the steel braid. The ohmmeter should indicate 210 ohms as the loop resistance of the wire and the steel braid.
- (4) If a reading is not obtained in any case, replace the assembly with a good one and return the defective assembly to the depot for repair.



**CABLE ASSEMBLY
CX-1065/G**

Figure 39. Test for opens, ends of cable at different points.

END B

END A

TM 391-101

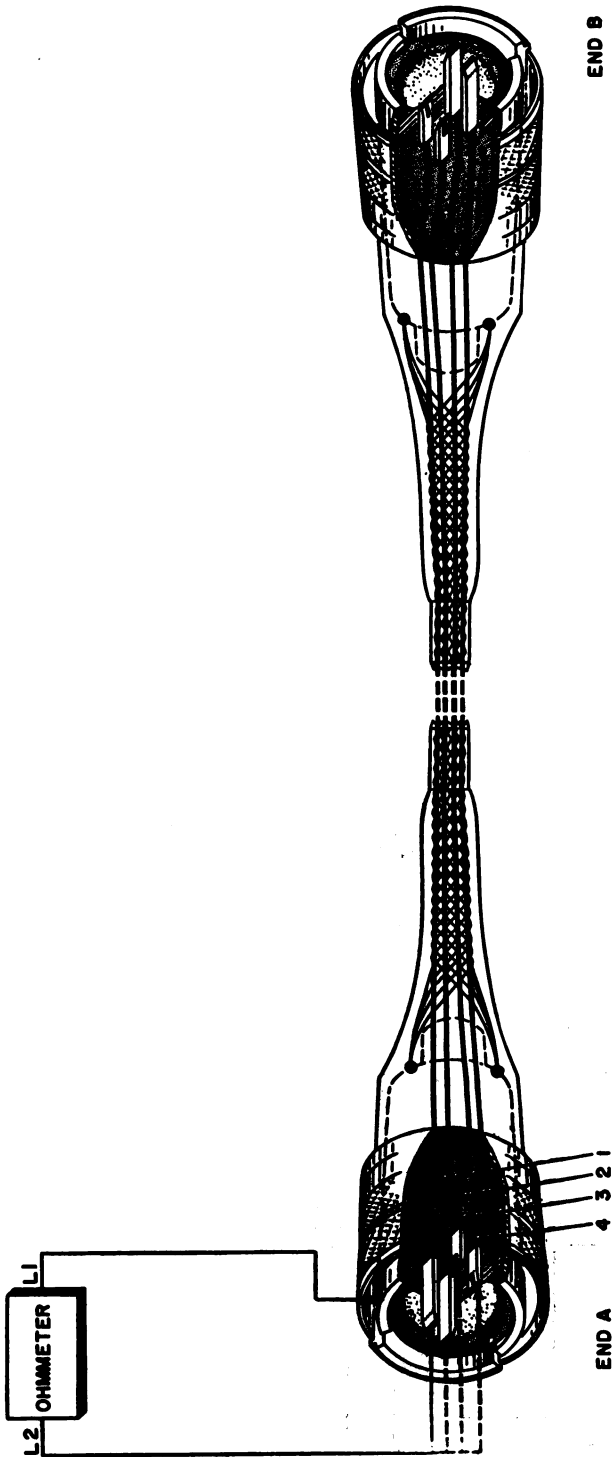

END B

TM 381-62

**CABLE ASSEMBLY
CX-1065/G**

Figure 40. Test for grounds.

END A

L2
OHMMETER
L1

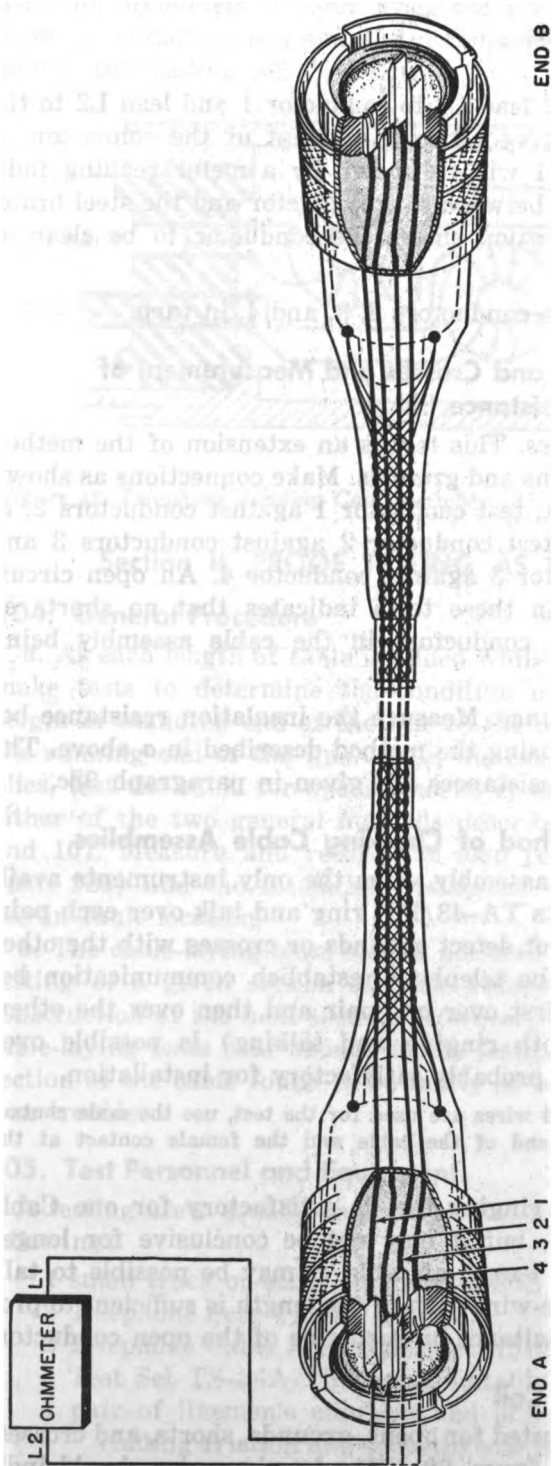

**CABLE ASSEMBLY
CX-1065/G**

TM 381-53

Figure 41. Test for shorts and crosses.

100. Test for Grounds (fig. 40)

a. At end A, connect lead L1 to conductor 1 and lead L2 to the steel braid by connecting L2 to a segment of the connector. A ground on conductor 1 will be shown by a meter reading indicating a closed circuit between this conductor and the steel braid. Absence of such indication shows the conductor to be clear or not grounded.

b. Repeat the test on conductors 2, 3, and 4, in turn.

101. Tests for Shorts and Crosses and Measurement of Insulation Resistance (IR)

a. *Shorts and Crosses.* This test is an extension of the method used in testing for opens and grounds. Make connections as shown in figure 41. At end A, test conductor 1 against conductors 2, 3, and 4, in turn; then test conductor 2 against conductors 3 and 4; finally, test conductor 3 against conductor 4. An open circuit (infinite resistance) in these tests indicates that no shorts or crosses exist between conductors in the cable assembly being tested.

b. *Insulation Resistance.* Measure the insulation resistance between the conductors using the method described in *a* above. The minimum insulation resistances are given in paragraph 98c.

102. Alternative Method of Checking Cable Assemblies

a. To check a cable assembly when the only instruments available are Telephone Sets TA-43/PT, ring and talk over each pair. (Generally, this will not detect grounds or crosses with the other pair.) By means of the telephone, establish communication between the two ends, first over one pair and then over the other. If communication (both ringing and talking) is possible over each pair, the cable is probably satisfactory for installation.

Note. To be sure paired wires are used for the test, use the male contact of the connector at one end of the cable and the female contact at the opposite end each time.

b. The talking and ringing test is satisfactory for one Cable Assembly CX-1065/G, but it may not be conclusive for longer lengths. In the longer length of cable, it may be possible to talk and ring through a one-wire open, if the length is sufficient to provide considerable capacitance on each side of the open conductor.

103. Test of Loading Coil

The loading coil is tested for opens, grounds, shorts, and crosses, the same as the cable (pars. 99-101). An ohmmeter should indi-

cate approximately .75 ohm when continuity is obtained between a male contact on one end and a female contact on the opposite end of the loading coil (fig. 42).

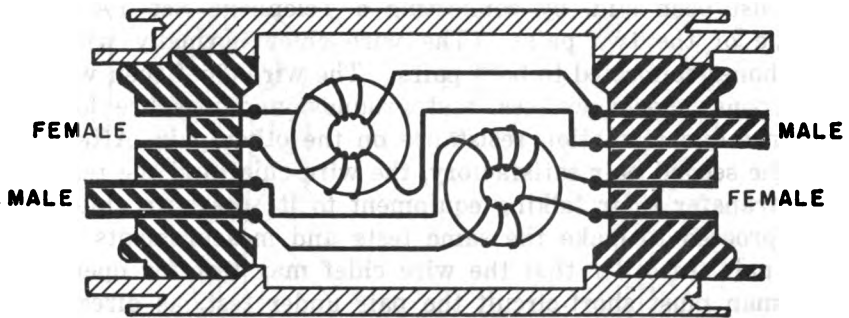

TM 381-49

Figure 42. Telephone Loading Coil Assembly CU-260/G, schematic diagram.

Section II. PROOF TESTING AS LINE IS BUILT

104. General Procedure

a. As each length of cable is added while the line is being built, make tests to determine the condition of the cable from the origin or standing end of the line to the outermost connector at the running end of the line. As in the case of individual assemblies, test the cable for opens, shorts, crosses, and grounds. Use either of the two general methods described in paragraphs 106 and 107. Measure and record the loop resistance of each pair (par. 98a) and the insulation resistance (par. 101) for future use in fault location.

b. The cable-laying team should not wait for completion of the testing of a given section of cable before proceeding with the construction of the next section. However, be careful to keep the cable-laying team near enough to the testing team to replace any section of the cable found to be faulty or to correct any installation trouble.

105. Test Personnel and Equipment

A testing crew usually consists of two men provided with the following:

- 1 small truck or other suitable vehicle.
- 2 Telephone Sets TA-43/PT.
- 2 Telephone Cable Assemblies CX-1512/U.
- 1 Test Set TS-26A/TSM or a suitable voltohmmeter.
- 1 pair of linemen's climbers and other linemen's tools, including friction and polyethylene tape.

106. Procedure With Wire Chief Available

a. Establish communication with the wire chief or other tester at the standing end of the cable, from the end of the cable that has just been laid, by connecting a Telephone Set TA-43/PT to one of the two pairs. (The wire chief normally will have telephones connected to both pairs.) The wire chief then will test for opens, shorts, crosses, and grounds, and measure loop resistance and insulation resistance on the other pair. After finding the second pair satisfactory, the wire chief and the test man will transfer their talking equipment to it; the wire chief then will proceed to make the same tests and measurements on the first pair. In order that the wire chief may test for opens, the test man must short-circuit the pair under test, as directed by the wire chief.

b. When the wire chief's tests have proved the cable to be in a satisfactory condition, the cable testing team will remove the connections, couple on the next length of cable by joining the two connectors, and proceed to carry out the same procedures at the next connector location.

107. Test Method With Wire Chief Not Available

a. If a wire chief with his testing equipment is not available at the origin of the line, an alternative method may be used to test the cable as lengths are added. Each pair should be short-circuited at the origin of the line (end A) as shown in figure 43.

b. Test the cable from end B. Measurement of loop resistance of each pair (as shown in A, fig. 43 for one pair) will indicate with reasonable accuracy whether the proper number of cable assemblies is accounted for up to this point, and whether there are opens or short circuits in either pair. A test for possible connections between pairs (B, fig. 43) will be a check for crosses, and a test between each pair and the braid will be a check for grounds.

108. Procedure If Faults Are Found

a. If the tests show troubles in the cable line, localize and clear the troubles or replace the faulty cable assemblies with good ones. When tests are coordinated with cable installation, faults detected generally will be in the last section laid. Usually, it will be possible for the cable-laying team to install a replacement length of Cable Assembly CX-1065/G before proceeding with further laying. Otherwise, a policing or repair team must replace or repair the defective section. Such replacement, especially in the case of buried or aerial construction, may be only temporary

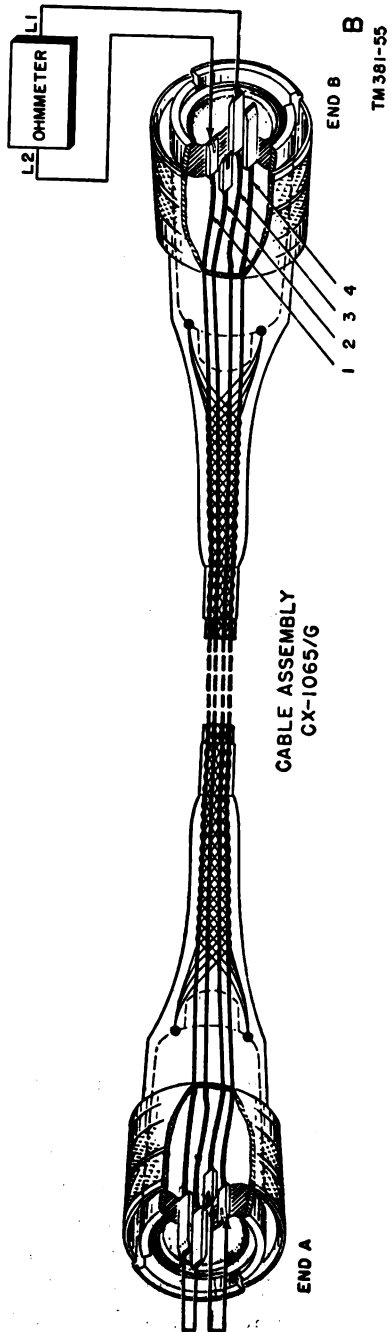
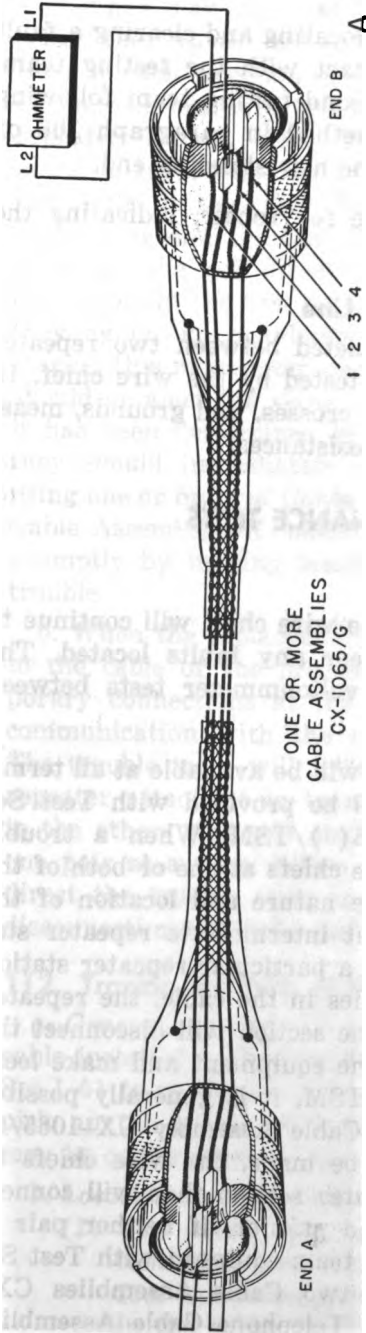

Figure 43. Test arrangement when tests are made without wire chief.

until the installation team can be brought back to make more permanent repairs.

b. If there is considerable delay in locating and clearing a fault and the cable-laying team loses contact with the testing team, set up a second test point with a second testing team following the cable-laying team. Follow the method in paragraph 106 or detail a man to act as wire chief at the new standing end.

c. Mark defective lengths of cable for repair, indicating the type and probable cause of the fault.

109. Tests on Completion of Cable Line

When a cable line has been completed between two repeater stations, the overall lengths will be tested by the wire chief. In addition to testing for opens, shorts, crosses, and grounds, measure and record wire and insulation resistances.

Section III. MAINTENANCE TESTS

110. General Procedure

a. After the cable is in service, the wire chief will continue to make tests of its condition and clear any faults located. The tests may consist of voltmeter or voltohmmeter tests between two stations.

b. Wire chiefs or testers normally will be available at all terminals and repeater stations, and will be provided with Test Set TS-27B/TSM and Test Set TS-26()/TSM. When a trouble affects the spiral-four cable, the wire chiefs at one or both of the terminals will test to determine the nature and location of the trouble. By contacting attendants at intermediate repeater stations, the trouble can be localized to a particular repeater station or repeater section. If the trouble lies in the cable, the repeater attendants at one or both ends of the section will disconnect the cable in the affected section from the equipment and make location tests. With Test Set TS-27B/TSM, it is generally possible to localize the trouble to a single Cable Assembly CX-1065/G. If a precise determination cannot be made, the wire chiefs or attendants at each end of the repeater section then will connect Telephone Set TA-43/PT to a good pair or, if neither pair is good, to one of the pairs. A trouble team equipped with Test Set TS-26()/TSM, two cable stubs, two Cable Assemblies CX-1065/G on Reels DR-15-B, several Telephone Cable Assemblies CX-1606/G, and two Telephone Sets TA-43/PT then will be dispatched to the trouble location.

111. Procedure for Trouble Team

a. When they arrive at the fault location, the trouble team will select the nearest connectors, disconnect them, and terminate them in each direction with a cable stub. They then will establish communication with the wire chief at one or both ends of the repeater section, using Telephone Set TA-43/PT on different pairs, in turn. Presumably, the line will be clear to one repeater and faulty to the other. The wire chief on the faulty end should make a second location test using Test Set TS-27B/TSM. If necessary, he will direct the trouble team to close through the connectors at the first point and proceed to a second point, where they again will establish communication with the wire chief. During this move from one location to another, the trouble team should be alert for signs of possible trouble on the cable. When it has been determined in which cable assembly the fault lies, they should immediately replace the defective cable assembly, using one or more of Cable Assemblies CX-1065/G and Telephone Cable Assembly CX-1606/G, unless service can be restored more promptly by making temporary repairs at the actual point of trouble.

b. When the replacement cable has been laid, connect one end to the cable of the preceding repeater station, and make temporary connections at the other end with cable stubs so that communication with the repeater stations can be maintained. The trouble team will follow directions from the wire chief or repeater attendant in transferring its telephone from one pair to the other; this will enable the wire chief to test through on one pair at a time. When no fault remains, the wire chief will direct the trouble team to make the connection permanent by disconnecting the stubs and connecting the two cable connectors.

112. Tracing the Path of Buried Cable

a. *General.* At times, it will be necessary to trace the path of cable installed underground. This may be done by using a Test Set I-51 to produce a tone on the cable and an exploring coil to pick up the energy radiated from the cable. The loading coil may be constructed as shown in figure 44.

b. *Location by Tone Test Set and Exploring Coil.*

- (1) The cable may be located readily by connecting the tone from Test Set I-51 between one conductor (or all four conductors shorted together) and the steel braid in the cable, or a good ground. At the distant end of the section to be traced, the same wire or the wire braid is connected to ground. This allows current to flow

PREPARE ENDS WITH ONE LAYER
2 IN. FRICTION TAPE ON THE
BOTTOM AND 2 IN. RUBBER TAPE
ON TOP HELD TEMPORARILY WITH
TWISTED WIRE

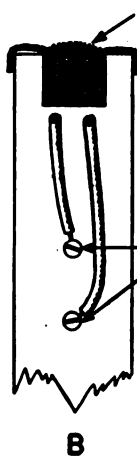
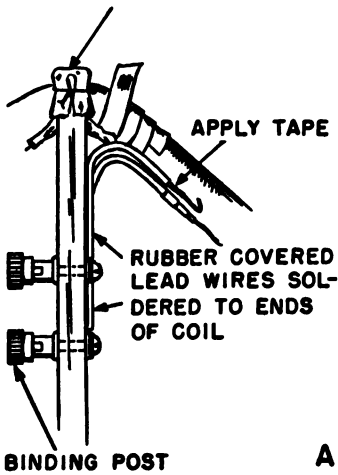

WIND ABOUT
400 TURNS
24 GA (APPROX)
DOUBLE
COTTON WIRE

MAKE 2 OF
1/2 IN. STOCK.
DRILL ONE FOR
BINDING POST
SHOWN IN FIG. A.
FIT TOGETHER
AS SHOWN IN
FIG. D.

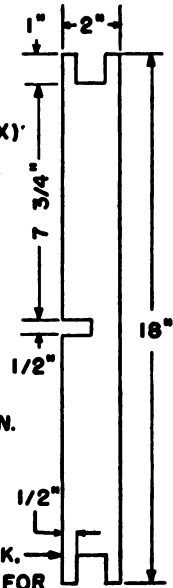

START 3/4 IN. RUBBER
TAPE FOR FIRST LAYER

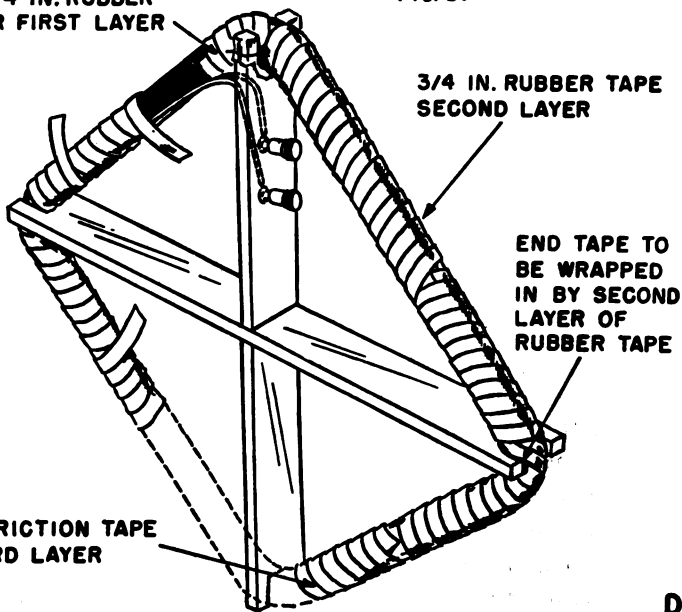

AFTER WIRE HAS BEEN WOUND ON THE FORM
APPLY 3 LAYERS OF TAPE. AFTER TAPING
APPLY 2 COATS OF ASPHALT PAINT.

TM 381-56

Figure 44. Method of constructing exploring coil.

through the conductor or the wire braid in the section to be traced. An exploring coil (fig. 44), which is connected to a head receiver (preferably through a portable amplifier), then is carried over the ground in the vicinity of the cable, with the exploring coil held so that the plane of the coil is horizontal. When the axis of the coil is perpendicular to the axis of the cable, the center of the coil is directly over the cable and no tone will be heard in the receiver. As the coil is moved slightly from side to side, tone will be heard, but the exact location of the cable will be indicated by the null (no tone) position of the coil.

- (2) When the section to be traced is longer than a single Cable Assembly CX-1065/G, connect the tone to one of the wires in the cable rather than to the steel wire braid. The braid is connected electrically to the connectors and this grounds the steel wire braid at each connector; if the ground is reasonably good (low in resistance), there would be considerable loss of tone current at each of these points with consequent loss of tone current as successive connectors are passed.

CHAPTER 6

REPAIR

113. General Procedures

a. All recovered spiral-four cable and some damaged and undamaged line materials are returned to a depot for inspection, repair, and testing. The information in this chapter covers primarily the repair of cable assemblies and loading coils and also covers support and attachment materials to a minor extent.

b. Cable Assembly CX-1065/G must have not more than one splice and must be 1,320 feet \pm 40 feet long. Cable Assemblies CX-1065/G with more than one splice required may be converted to Telephone Cable Assembly CX-1606/G using that portion of the CX-1065/G that contains a good connector. The length must be 100 feet \pm 5 feet. Telephone Cable Assemblies CX-1606/G with more than one splice required may be converted to Telephone Cable Assemblies CX-1512/U using that portion of the CX-1606/G that contains a good connector. The length must be 12 feet \pm 6 inches. Shorter and longer lengths of cable with good connectors can be used for replacing damaged connectors (par. 116). A record must be kept of the various lengths of good cable which can be spliced with one splice to make a Cable Assembly CX-1065/G which will meet the physical and electrical requirements specified in this chapter. All field splices must be replaced with depot splices.

c. The general steps in reconditioning cable assemblies are outlined in (1) through (5) below.

- (1) Cable Assemblies CX-1065/G and other lengths of spiral-four cable ordinarily should be returned to depot wound on reels. Test all lengths electrically before rewinding and inspecting. These tests detect the presence of faults and, in some instances, they indicate the location.
- (2) Rewind the cable to another reel to permit foot-by-foot inspection for defects (par. 114). When rewinding and inspecting, clean the cable of mud or dirt so that the defects will not be overlooked.
- (3) Repair all defects in the cable and connectors to the extent required (par. 115).

- (4) Make electrical tests (par. 119a) to be sure that reconditioned cable assemblies are satisfactory for reissue.
- (5) Attach tags (par. 119b) with suitable markings on all lengths of reconditioned cable assemblies.

114. Inspection of Recovered Cable

a. Method of Performing Inspection. To aid in the inspection of recovered cable, wind it slowly from the Reel DR-15-B on which it is received onto an empty Reel DR-15-B which may be mounted on Reel Unit RL-26-(), RL-31/(), or RL-118/G. As the cable is being transferred from one reel to the other, inspect it foot by foot for kinks, cuts, tears, crushed sections, or other injuries. Transfer the entire cable length, noting its overall condition and marking points that might require repairing, before stopping to make any repairs. If several damaged points occur in a short length, it will be more practicable to cut out the length and replace it than to repair every damaged point.

b. Performance of Rewinding. Insert into the storage compartment on the empty reel the connector of the cable length to be inspected. Be careful not to introduce sharp bends in the cable. Wind the cable onto the empty reel in close, smooth, successive layers across the reel drum until the winding is completed. Place the outer connector in the storage compartment and space the turns in the last layer of cable wound on the reel to make a neat, compact winding without unnecessary slack in the cable. Be careful not to let the outer turns of cable slip over the reel flange or over the storage compartment.

c. Cleaning Cable During Rewinding. As the cable is rewound, clean the entire surface with a stiff scrub brush, so that injuries covered by mud or dirt can be seen.

115. Types of Faults and Method of Repair

a. Light Abrasions or Cuts. No repair is needed if the cable core appears undamaged and if none of the steel braid wires are broken or exposed.

b. Cuts or Gouges through Jacket. Cut off the jacket in the damaged area and examine the interior of the cable. If the braid wires are not broken and there is no evidence of core injury, repair the jacket by applying several layers of polyethylene tape and friction tape. If the damage extends beyond the outer jacket, cut out the damaged section and make a splice (par. 118).

c. Points Damaged by Crushing or Kinking. Straighten out kinks or sharp bends. Because kinking or crushing is likely to have caused damage to the steel braid wires or core, remove the

jacket and inspect the interior of the cable at such points. Either restore the jacket (par. 117) or cut and splice the cable (par. 118).

d. Opens, Crosses, Shorts, or Grounds. To correct these faults, cut out the damaged section and resplice the cable (par. 118).

e. Presence of Field Splices. Remove the field splices and make permanent splices (par. 118).

f. Damaged Connectors. Replace damaged connectors unless the damage is very slight (par. 116).

116. Reconditioning and Replacing Connectors

a. General. Examine all connectors for injuries or defects. Be sure that the connector will engage in another connector that is in good condition. An open in a connector can be repaired only by replacing the connector. When an open is found in testing a cable assembly (possibly in a connector or approximately at the point where the connector is joined to the cable), determine which connector is defective. A telephone and buzzer test usually will indicate whether or not an open is near the testing point. If the open is near, the capacitance is small and only a faint tone will be heard. If the open is some distance away, the capacitance will be greater and a considerable volume of tone will be heard. By this method, it is usually possible to determine at which end of the cable the open is located. The defective connector then can be replaced (*c* below).

b. Reconditioning Connectors. Thoroughly clean all connectors and end caps. Be sure that the ends of the connectors and the brass segments are free of dust and dirt. Remove dirt that may be between the female terminals by using a pipe cleaner or a swab made of clean cloth over a piece of wire. After the connectors have been cleaned, replace the end cap. Be sure that the end caps are tight.

c. Replacing Damaged Connectors. Cut off the damaged connector and splice on a good cable stub using the procedures given in paragraph 118. An undamaged connector and cable salvaged from a damaged cable assembly may be used as a cable stub provided it is over 3 feet long.

117. Repair of Cable Jacket

If the jacket is cut or gouged so that the steel braid is exposed or if the cable is kinked, cut off the jacket, straighten out the kinks, and examine the damaged area. If the steel braid is not broken and the core is not injured, restore the jacket by applying several layers of polyethylene tape and friction tape.

118. Depot Splicing Procedure

a. Cut through the outer jacket around the cable, about 2 inches from the point to be spliced (A, fig. 45). Make two longitudinal slits in the jacket on opposite sides of the cable. Extend the slits from the cut to the point to be spliced. Use pliers to remove the cut pieces of the outer jacket from the cable.

b. Loosen the exposed wire braid. Use a screw driver to separate the strands (B, fig. 45). Group the strands of wire braid into four bunches equally spaced around the cable. Each bunch will have four strands. Twist each bunch to form a single stranded wire and cut to a length of $1\frac{5}{8}$ inches (C, fig. 45).

c. Remove the cloth tape (C, fig. 45) from the inner jacket.

d. One-half inch from the end of the outer jacket, cut a nick all the way around the inner jacket (D, fig. 45). Be careful to cut only part way through the inner jacket. Flex the inner jacket and conductors until the jacket separates at the nick. Make a one-fourth-inch longitudinal cut through the inner jacket at each end of the cable (D, fig. 45). Be sure that two conductors are on each side of the cut. Grasp one cut end of the inner jacket with side-cutting pliers and pull outward. The inner jacket will peel away from the insulated conductors. Remove the other end of the inner jacket in the same manner.

e. Cut the central filler close to the end of the inner jacket.

f. Join the four bunched steel wires of one cable end to those of the other cable end (A, fig. 46) by means of a nickel-steel splicing sleeve (stock No. 6N5608-6) or a bronze splicing sleeve (stock No. 6N5617.1). Be sure that each bunch is inserted into the sleeve until it reaches the ringed stop. Crimp the sleeve in two places, on each side of the center, with Sleeve Compressing Tool TL-190. To protect the inner conductors against pinching by the braid wires, wrap each bunch with a layer of friction tape. Extend the wrappings beyond the ends of the inner jacket. Wrap the bunches together with a layer of friction tape (B, fig. 46).

g. Remove the insulation from the conductors for a distance equal to one-half the length of a bronze splicing sleeve (stock No. 6N5617.1) and clean each conductor. Do not nick the conductors.

h. Push one of the skinned conductors into one end of the splicing sleeve until the insulation touches the sleeve. Push a conductor from the other cable end into the other end of the sleeve (B, fig. 46). Be careful to splice together conductors of the same color. Compress the sleeve with Sleeve Compressing Tool TL-190. Crimp the sleeve in two places over each conductor.

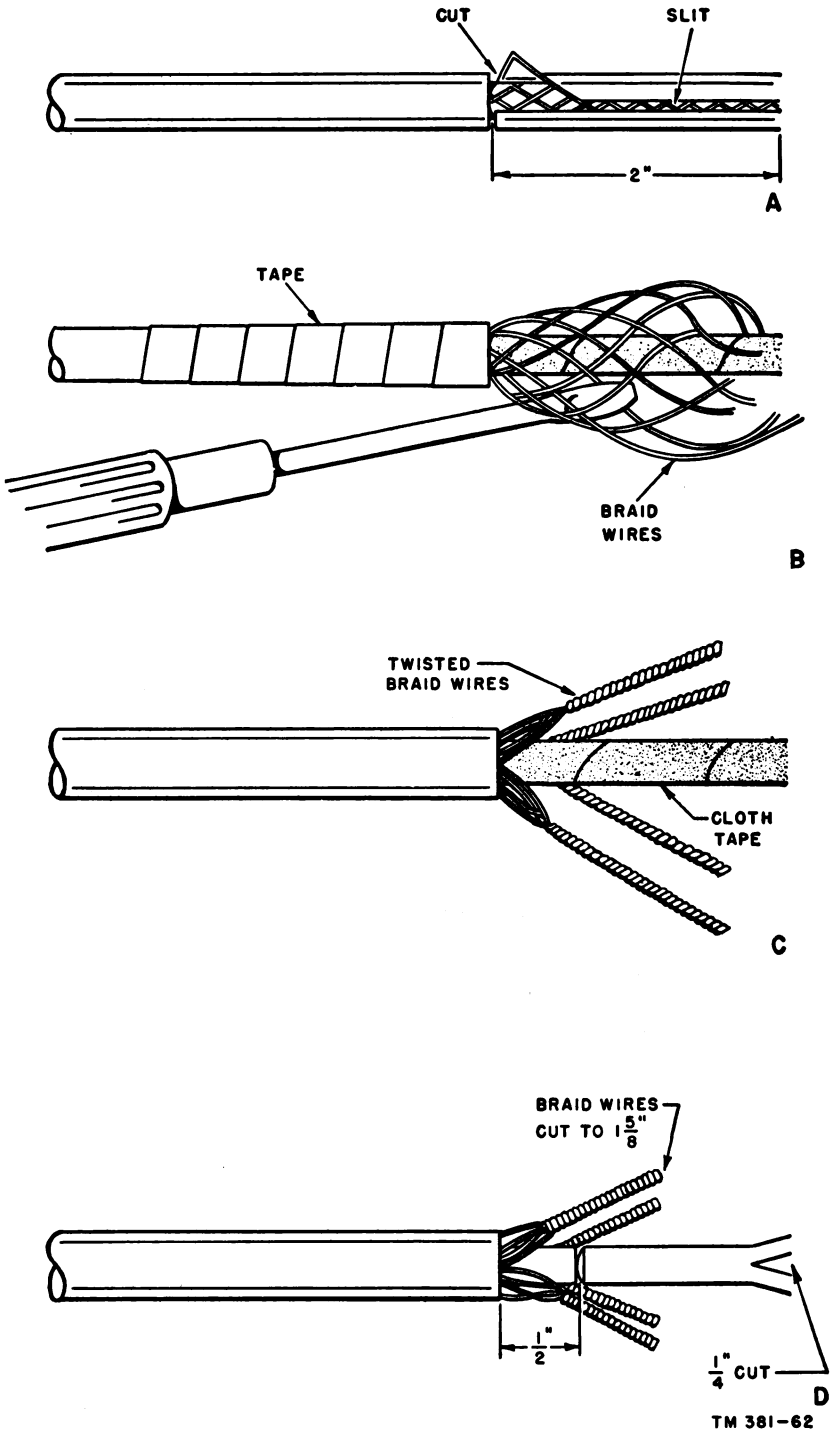

Figure 45. Preparing ends of cable for depot splice.

i. Wrap the sleeve with two half-lapped layers of polyethylene tape (C, fig. 46). Stretch the tape to approximately twice its original length while wrapping it about the sleeve. Start the tape at the center of the sleeve and wrap it to one-fourth inch beyond the end of the conductor insulation. Reverse, and wrap to one-fourth inch beyond the end of the conductor insulation at the other end of the sleeve. Reverse again and end the wrapping at the center of the sleeve. Cover the polyethylene tape with a layer of friction tape, wrapped spirally from one end of the splice to the other.

j. Repeat the procedure outlined in *h* and *i* above for each of the other three conductors.

k. Wrap the four spliced conductors with several layers of polyethylene tape. Cover the polyethylene tape with a layer of friction tape.

l. Clean and dry the surface of the cable adjoining the splice. Wrap the entire splice with two half-lapped layers of polyethylene tape. Start the polyethylene tape at the center of the splice and wrap to one inch beyond the end of the outer jacket. Reverse and wrap to one inch beyond the end of the outer jacket at the other end of the splice. Reverse again and end the wrapping at the center of the splice.

m. Wrap a half-lapped layer of friction tape around the splice, starting one-half inch beyond the polyethylene tape and continuing across the splice. End the friction tape one-half inch beyond the polyethylene tape at the other end of the splice (D, fig. 46).

119. Final Testing and Marking

a. Electrical Tests. Test all lengths of repaired or recovered cable for opens, shorts, crosses, grounds, and insulation resistance (pars. 98 through 102). Place splices under hand tension during this test to reveal any opens that may have been pulled back into contact. Verify the continuity of the conductors from the male terminals at one connector to the female terminals at the other end.

b. Marking. Tie a tag, such as Cable Markers MX-892/G, MX-893/G, MX-894/G, or MX-895/G, to each length of cable that has been repaired or found suitable for reuse. Attach the tag around the cable at the outer connector on the reel. One side of this tag may be used for depot information. The other side should be left blank for application of a serial number and other line information when the cable is installed in a line.

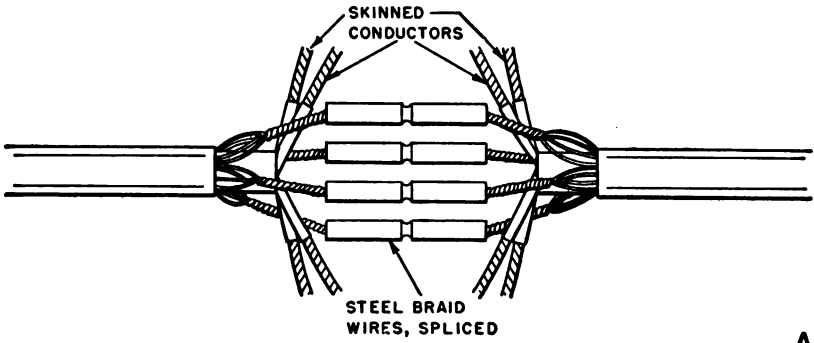

A

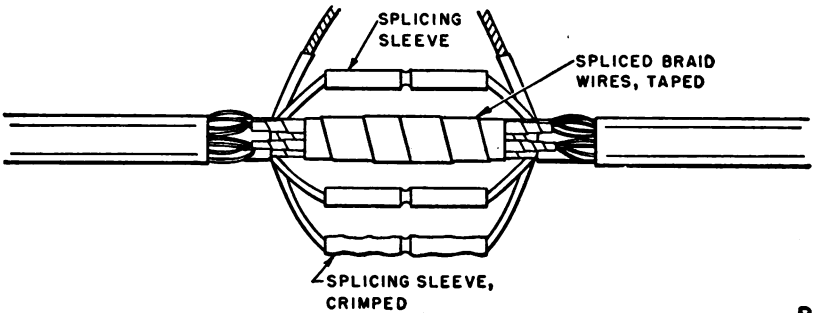

B

SPLICED CONDUCTORS SHOWN COVERED WITH POLYETHYLENE TAPE ONLY

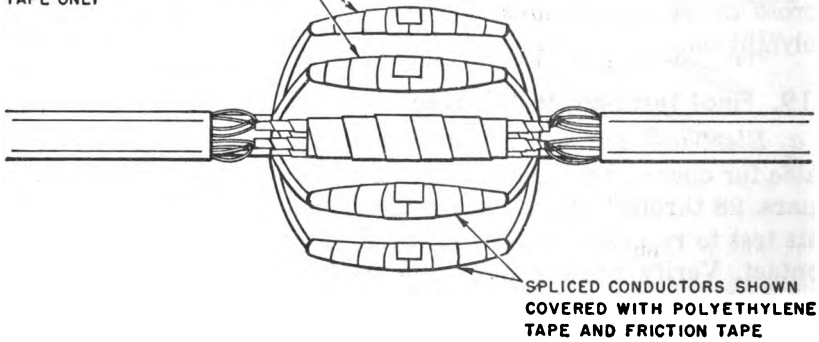

C

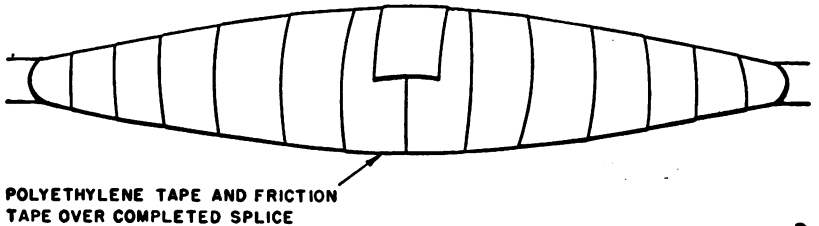

D

Figure 46. Depot splice of cable.

TM 381-63

CHAPTER 7

REMOVAL AND SALVAGE OF CABLE

Section I. RECOVERY PROCEDURES

120. General

a. Spiral-four cable that is no longer needed for service in its existing location is recovered whenever possible. Unless specifically directed, field recovery teams do not attempt to decide what lengths of cable are suitable for recovery. All cable is taken up on Reels DR-15-B and returned as directed for the specific job. Handle the cable carefully during recovery operations.

b. Aerial cable and buried cable must first be converted to ground surface cable before they can be recovered. After this is done, the repositioned cable is recovered by methods similar to those used for recovering surface-laid lines.

121. Organization of Personnel and Equipment

a. Surface Installations.

- (1) The suggested personnel (including a team leader and a driver) for recovery of spiral-four cable from surface installations is as follows:

Personnel	Equipment
Cable pickup team (7 or 8 men)-----	1 truck, 2½-ton cargo. 1 Reel Unit RL-26-(), RL-31-(), or RL-118/G. 20 (approx) empty Reels DR-15-B.

- (2) This team and equipment are used also for the recovery of aerial and buried spiral-four cable installations. Additional teams and equipment are required for speedy recovery of aerial or buried installations. (b and c, below)

b. Aerial Installations.

- (1) To recover spiral-four cable installed aerially, the following additional teams are suggested:

Personnel	Equipment
Dismantling team (9 or 10 men) -----	1 truck, 2½-ton line construction with winch and LM derrick. 4 scaling ladders.
Line material recovery team (5 men)	1 truck, 2½-ton cargo. 1 Trailer K-36 or K-37.

- (2) If recovered materials must be hauled some distance to a salvage dump or depot, this dismantling team may take the line down faster than a single recovery team can haul it away. Additional recovery teams may be assigned or the dismantling team may assist in the recovery operations upon completion of their regular assignment.

c. Buried Installations. Buried cable recovery operations are likely to be slow and difficult. The recovery method used will depend on terrain conditions and on the length of time the cable has been buried. However, before recovery procedures can begin it usually will be necessary to have a trenching team remove most of the soil covering the cable.

- (1) A typical team for the trenching operation is as follows :

Personnel	Equipment
4 or 5 men -----	1 truck, 2½-ton cargo. 1 Plow LC-61, with trenching attachment; hand-digging tools.

- (2) If the trace of the cable plow cannot be seen, a locating team covers the course with an exploring coil and marks the cable route at frequent intervals to enable trenching teams to follow the cable path accurately. A locating team should consist of the following personnel and equipment:

Personnel	Equipment
3 men -----	1 truck, ¼-ton 4 x 4. 1 Test Set I-51 and exploring coil equipment. Stakes or markers.

Section II. RECOVERY OF SURFACE CABLE

122. Applications of Methods of Recovery

The recovery procedures given in paragraph 123 are used for the recovery of all surface cable lines, except in particular sections of the line which require special treatment, such as aerial crossings (par. 124), underground crossings (par. 125), underwater crossings (par. 126), or sections inaccessible to recovery trucks (par. 127). These methods also apply to the recovery of aerial cable and buried cable after they have been converted to surface cable.

123. Recovery Procedures

a. General Procedure. The cable is taken up on a reel mounted on a reel unit on a truck. The truck is driven along the line of the cable and a few feet away from it. The truck must not be driven across the cable. The speed of the truck is synchronized with the reel rotation speed to establish and maintain a reasonably sized loop of cable behind the truck (*c* below). The reel unit may be either power-driven (RL-26-()) or RL-118/G) or hand-turned (RL-31-()). The end caps are screwed on as the connectors are placed in the storage compartment of the reels.

b. Handling Cables at Reels.

- (1) Place the end connector of Cable Assembly CX-1065/G, cable end down, in the storage compartment on an empty Reel DR-15-B, mounted on the spindle of Reel Unit RL-26-(), or RL-31-(), or RL-118/G. As the truck starts to move, one lineman turns the reel and rotates it in the direction which will not cause the cable to be bent back on itself at the connector. The reel is mounted on the reel unit to maintain this direction of rotation with the cable feeding to the top of the reel. The turning speed of the reel is regulated according to the speed of the truck to maintain a loop of cable about 10 feet in length behind the truck.
- (2) Another lineman guides the cable so that the turns go on the reel evenly and the layers build up uniformly. If the cable is wound on haphazardly, it will extend beyond the edges of the flanges on the reel, making it awkward for handling and storing. If the cable is muddy, the lineman guiding it to the reel may be able to clean it partially by feeding it through a gunny sack or by wiping it. The lineman guiding the cable to the reel stays outside the loop to avoid injury.

- (3) Although all ties and attachments are removed when the cable is freed from the stakes and tie points, the lineman guiding the cable is responsible for seeing that clamps, ties, or other attachments are not reeled up with the cable.

c. Synchronizing Speed of Truck and Reel. The slack loop behind the truck may catch or snag if it gets too long. The cable will be pulled onto the reel at a bad angle if the loop is too short. To synchronize the truck and reel speeds thus maintaining the proper size loop, arrange signals between the driver and the team chief in the truck.

d. Other General Operating Features. One lineman may be stationed on the running board to assist the driver in following the cable and to warn the driver when approaching stakes, ties, obstructions and connector locations. The recovery operation cannot be performed at high speeds. Set and keep a moderate pace.

e. Reeling-in Procedures at Tied or Staked Points. At such points, halt the truck long enough for a lineman to cut away the tie (usually marline or field wire) and remove any cable clamps. Pull up and recover all stakes.

f. Reeling-in Procedures at Connector Locations. When a connector location is approached, slow down and then stop the truck and reel unit before the connectors reach the reel. Separate the connectors and slowly reel up all remaining cable in the length. Place the end cap on the connector and put the connector into the storage compartment on Reel DR-15-B. If there is slack cable in the last turn, remove it by respacing a few of the turns in the top layer of the cable. Remove the full reel from the spindle and put an empty reel in its place. Resume reeling-in operation.

g. Recovering Telephone Cable Assemblies CX-1606/G. Replace and tighten the end caps. Coil the CX-1606/G by hand and tie it in at least two places, securing both connectors with the ties.

h. Storage of Reels in Trucks. Arrange the storage of the reels in the truck so that full reels will not interfere with access to the empty reels. A full load for a 2½-ton cargo truck is about 20 reels, depending on other material carried. The 1½-ton line construction truck will carry so few full reels (about 8 plus other normal cargo) that frequent transfers of the load to a 2½- or 4-ton cargo carrier are necessary if many cable lengths are to be recovered. If a smaller truck is used (¼- or ¾-ton vehicle), leave the full reels on the ground to be picked-up by a cargo carrier.

124. Recovery Procedure at Aerial Crossings

a. Self-Supported Aerial Cable. If traffic conditions permit, self-supported cable can be lowered to the ground and normal recovery procedures can be followed. If the traffic is heavy, rig snatch blocks at the top of each crossing support and run the cable through them. Separate the connectors nearest the crossing and attach a rope to the crossing cable near the connector. With tension applied at the far side of the crossing, and back tension held on the rope at the connector, release the pole attachments and draw the cable across the span. The connectors will not pass through snatch blocks, so they will have to be by-passed by a man on the pole. Maintain only enough back tension to keep an adequate overhead clearance as the cable is pulled over the crossing. Continue pulling until the entire cable end and the rope are across. Disconnect the rope and reel up the cable in the usual manner.

b. Messenger-Supported Aerial Cable. If a reduction in the normal clearances can be permitted, place the cable in snatch blocks and free the attachments at the supports. Draw the short end of the cable toward the crossing under moderate back tension and remove the cable hangers as they are pulled to the far side crossing support. In this case, the span is unsupported when all hangers have been removed. If the clearance is reduced to a point where it interferes with traffic, hangers should be placed on the cable at the near side support, drawn across, and removed at the far side until the entire short end has been pulled across.

125. Recovery Procedure at Underground Crossings

a. Buried Crossings. Buried crossings must be dug out by hand. Be careful not to damage the cable with digging tools (par. 34g). Restore the road surface after the cable is removed.

b. Crossings Through Culverts and Under Railroad Tracks. Reverse the installation procedure (par. 43) to remove crossings through culverts. Pull the short end of the cable through; be sure that the cable is not pulled across sharp corners. If any substantial length is to be pulled through, station men at intervals along the cable to pull it back toward the culvert. Be sure to avoid excessive tensions when pulling the cable. Remove rail crossings which are under a layer of ballast by clearing away enough ballast to allow the cable to be drawn freely under the rails. Station a man at the crossing to see that the operation proceeds smoothly. After the cable has been removed, replace the ballast around the railroad ties.

126. Recovery Procedure at Underwater Crossings

Underwater cables sometimes can be dragged out if the submerged length is small. Shallow water with a firm floor may be crossed with the truck, using regular recovery procedures. Deeper water requires the use of a boat or raft, particularly if the cable has been weighted. A serious need for cable would justify the use of more difficult recovery procedures.

127. Recovery Procedure in Inaccessible Areas

a. Spiral-four cable can be dragged out of locations where direct access is difficult or impossible. Bring the closer end of the cable, and all the cable between it and the terrain to the edge of the inaccessible area. Pull the cable through by hand from the opposite side.

b. Cable on ground impassable to trucks (heavy forest, swamp, large boulders) can be carried or dragged out by hand; men stationed at frequent intervals can handle the cable readily. Reel Cart RL-35, or Reel Unit RL-36-(), used as litters, may be used in hand recovery operations. If cable is pulled by hand, avoid pulling on connectors and do not exceed the pull that two men can exert.

Section III. RECOVERY OF AERIAL CABLE

128. General Procedure

The recovery of materials used in spiral-four aerial installations involves the steps outlined below:

- a. Dismantling and lowering the cable lines to the ground (par. 129).
- b. Recovering the cable strung out on the ground (pars. 122 and 123).
- c. Recovering the pole line supports, hardware, and line fixtures (par. 132).

129. Lowering Aerial Cable in Straight Sections of Line

a. *General Procedure.* This method requires a team of four men working from span to span and lowering the cable by following the procedures outlined in *b* below. In the following description, the four linemen are called A, B, C, and D.

b. *Lowering Cable.*

- (1) Lineman A climbs the first pole and removes all lashings, ties, and attachments, except the dead end cable clamp or basket hitch. He attaches a rope to the cable on the

side toward the second pole and passes this rope over the drive hook.

- (2) Lineman B, stationed 100 to 150 feet behind the pole (in line with the cable opposite pole No. 2), applies tension on the rope, while A lifts the bail of the cable clamp off the drive hook. Lineman A moves on to pole No. 3.
- (3) Lineman C climbs pole No. 2 and releases the hanger from the drive hook. Lineman C moves to pole No. 4. Line B releases the rope tension enough to allow the cable to be lowered so that it can be reached from the ground near pole No. 2.
- (4) Lineman D grasps the lowered cable at a point near pole No. 2 and maintains tension on the cable so that the hanger can be removed from the drive hook on pole No. 3. Lineman B lowers the end of the cable to the ground and removes the rope.
- (5) From this point on, the four-man team proceeds along the line by *leapfrogging*. Two men climb poles alternately and two men successively maintain tension from a point one or two spans before the lowered cable. Each lineman removes cable hangers, cable clamps, or other attachments and leaves them at the base of the pole, to be picked up by the salvage team. The two men climbing the poles carry the cable down the pole or lower it with a hand line. They must not drop it. The men maintaining tension on the cable then can adjust the tension to allow for the added length. The sudden jerk of a dropped cable can break off the next pole on which the cable is still supported. If the operation is stopped for any reason, maintain tension on the cable by attaching a rope and securing it to the base of a pole from which the cable has been removed. Connector locations at poles usually include a small coil of cable. Securely lash the bails of the cable clamps together at these points before they are lifted from the drive hooks. This will prevent slack from being introduced with a jerk when the lineman on the pole unhooks the bails.

c. Handling Lowered Cable. Ground workers (who tension the cable while it is being lowered) should move the cable 10 feet or more from the pole line, if possible, to clear the cable from the path of recovering vehicles.

130. Lowering Aerial Cable at Corners

a. Choose the method of lowering cable from corner poles to fit the conditions. Try to prevent injury to the men or the cable. If

the cable attachment is a cable clamp or cable hanger without lashings, and if the line has been slackened off because the cable has been lowered in three or four spans on each side of the pole, the cable can be lowered by using wire pikes and not climbing the poles.

b. When releasing the attachments, inspect the pole to determine whether a temporary rope guy or pike pole is needed. This is advisable if the pole is decayed at the base or has any decided rake because of the presence of the regular wire guy. The temporary rope guy is tensioned by a man on the ground who pulls in a direction that compensates for the unbalanced load caused by removing the attachments.

c. Relieve the line tension to permit the man on the pole to lift off the cable hangers or cable clamps. This can be done by using a rope which is attached to the cable, passed over the drive hook, and tensioned by a man on the ground.

131. Taking Down Aerial Cable, Other Methods

a. Another method of lowering the cable requires only three men. The first man lowers the cable from alternate poles, starting at the pole next to the dead end pole. This can always be done by men with scaling ladders, and often by the use of wire pikes (without pole climbing), if the attachments are cable hangers without lashings. Lowering the cable from alternate poles doubles the span length. The second man follows and lowers the cable from the alternates of the remaining supporting poles, starting at the second pole from the dead end pole. Each span is now four times its usual length, and between poles the cable will rest on the ground for a considerable distance. The third man lowers the dead end, moves the cable away from the line of poles, and lowers it from the poles to which it still is attached. Each man removes cable hangers, cable clamps, or other attachments after he lowers the cable, and leaves them at the base of the pole.

b. A third method of lowering cable involves lifting the pole from the ground with the cable in place and lowering the cable with the pole. This can be done with the pole derrick or sometimes by hand. Each pole in turn is lifted and lowered to the ground; then the cable is detached. This method requires extreme care to avoid damaging the cable and is not recommended for general use.

132. Recovery of Line Supports and Fixtures

a. The line recovery team takes down poles, fills in pole holes, removes and recovers hardware and fixtures, and transports recovered material to designated points of delivery. This work re-

lates primarily to the recovery of materials used in aerial line construction, but may also be used in recovery of supports used for overhead crossings in surface-laid lines.

b. Before taking down poles, cut guys below the ground line and beat down the cut ends so that they are not a hazard to men or machinery. With the guys free, the poles frequently can be shaken loose and lifted out by hand. Use a sling or derrick if necessary. Backfill the pole holes. Remove drive hooks, other line hardware, and projecting nails, and place them in boxes on the truck. Dispose of pieces of guy wire for safety. Load poles on Trailer K-36 or a similar trailer.

Section IV. RECOVERY OF BURIED CABLE

133. General Procedure

a. To recover buried cable lines, remove the cable from the soil and leave it strung out on the ground surface to be taken up by the methods indicated in paragraph 123. The method chosen for unearthing the cable will depend on its depth of burial and on the terrain. Select a method that will permit removal of the cable with minimum damage.

b. If unearthing the cable requires loosening or removing some of the soil, it is necessary to know the burial depth and exact location of the cable route. Without this information, digging or plowing tools cannot be used effectively and the cable may be injured. If the buried line path cannot be determined from plow traces made during installation, the path must be located by electrical test methods (par. 112), and the route marked with stakes or other markers.

c. As the cable is removed and strung out on the ground surface, place the cable to one side of the trench where it can be picked up by the truck.

134. Tests to Select Removal Method

Pull up test lengths of cable by hand to see if a direct-pull method of removal can be used without injuring the cable. If the soil is loose and there are no rocks or roots to snag or injure the cable, select one of the direct pulling methods listed in paragraph 135. Hand digging can be used at difficult points. If direct pulling is not applicable, use the plowing method described in paragraph 136.

135. Removal by Direct Pull

a. When the direct pull method can be used, a precise knowledge of the cable route is not necessary. The pulling begins where a

cable end is found and continues wherever the cable line leads. The cable should be pulled up vertically, rather than pulled back over itself. Do not use greater tension than one man can exert.

b. The cable can be under-run through a 9-inch snatch block, suspended from the pintle of a slow-moving truck. However, there is danger of injuring the cable if it is caught under roots or stones.

c. If hand-digging tools are used at difficult points, use a scooping motion along the line of the cable, rather than a cutting or digging motion at right angles, to avoid injuring the cable.

136. Use of Plows for Unearthing

a. Pull a plow behind a truck to loosen or remove the earth not deeper than approximately 2 inches above the cable. An agricultural plow may be used. When plow removal methods are used, the connectors should be previously dug up and placed where they are clearly visible to the plow-operating team.

Caution: If the plow that is used is not especially designed for cable removal, the share should be examined for sharp edges.

b. When using a plow, the truck driver proceeds along the route, guided by signals from the plow operator and from a man riding on the running board of the truck. At connector locations, the plow is raised out of the ground to avoid contact with the connector of the slack cable usually left at these locations. The standard of Plow LC-61 can be raised just before the connector is reached and then tripped after passing it. The truck driver slows down when approaching a connector and slowly proceeds beyond it. After passing the connector, he stops the truck. The plow operator then controls further movements of the truck by using signals.

c. A team closely follows the plow and pulls the cable through the remaining earth and out of the furrow. The team backfills the plow furrow by using hand tools or by drawing a drag over the furrow.

CHAPTER 8

DEMOLITION TO PREVENT ENEMY USE

137. Authority for Destruction of Equipment

Demolition of the equipment will be accomplished only by the order of the commanding officer. Demolition procedures outlined in paragraph 138 will be used to prevent the enemy from using or salvaging the equipment.

138. Destruction Procedures

a. Knock Down. Knock down all pole line construction with a tank, tractor, or heavy vehicle.

b. Smash. Smash terminals, repeaters, test equipment, cable reels, cable connectors, loading coils, and all other associated equipment; use sledges, axes, hand axes, pickaxes, hammers, crowbars, or any other heavy tools.

c. Cut. Cut cables into small pieces and cut off cable connectors. Cut all wires used for switching circuits at terminal boards and chop down all poles; use axes, pickaxes, and machetes.

d. Bend. Bend cable reels, carrying cases, panels, chassis, and other associated equipment; use sledges, crowbars, and hammers.

e. Burn. Burn supplies of poles, cable, wire, splicing tape, route maps, diagrams, and manuals; use kerosene, oil, flame throwers, and incendiary grenades.

f. Explode. Destroy all poles, cables reels, and supplies with explosives, if necessary; use firearms, grenades, or TNT.

g. Dispose. Bury or scatter splicing sleeves, tools, hardware, and any other supplies after they have been destroyed. Bury the destroyed parts in slit trenches, fox holes, and other holes; throw them in streams.

h. Destroy. Destroy everything; use anything immediately available to assist in the destruction of the equipment.

INDEX

	<i>Paragraphs</i>	<i>Page</i>
Aerial cable:		
Comparison to buried and surface cable lines.....	20	18
Line construction:		
General	59	49
Materials	63	51
Personnel and equipment required	62	51
Sag measurements	65b	53
Sag requirements	65a	52
Span length requirements	64	52
Speed of construction	61	50
Storm resistance limitations	60	50
Preventive maintenance	87	79
Recovery:		
Alternate methods	131	118
At corners	130	117
At crossings	124	115
General procedures	123	116
Straight sections of line	129	116
Aerial crossings:		
Constructions	42	34
Recovery	124	115
Alternate methods of testing cable	102	96
Anchors	63i	52
AN/TCC-11, Telephone Repeater	79-81	72
Applications, system	4	4
Assembly, cable (<i>See</i> Cable assembly.)		
Avoiding excessive tensions, kinks, and crushing	34	26
Avoiding hazards when routing line	19	18
Authority for destruction of cable	137	121
Basket hitch	41	34
Bridges, tension:		
At connectors	70	57
For field splices	91	86
Buried cable:		
Comparison to aerial and surface cable lines.....	20	18
Line construction:		
Depth of plowing	49	44
General	44	41
Plowing operations:		
Cable laid on ground	54	46
Cable on reels	53	45
In water and soft or swampy ground	56	48
Lubrication	51	44
Precautions	48	43
Preparations	52	45
Speed	50	44

Buried Cable—Continued

Line construction—Continued

Procedures at:

Connector points	54	46
Road crossings	53	45
Underground obstructions	55	47
Use of cable plow	45	42

Recovery:

Direct-pull method	135	119
General procedure	133	119
Plow method	136	120
Tests to select method	134	119

Preventive maintenance	86	79
------------------------------	----	----

Buried connectors, marking	57	48
----------------------------------	----	----

Cable assembly:

CC-358, Cable Assembly	4d	6
CC-368, Cable Assembly	4d	6
CX-1065/G, Cable Assembly	3b	4
CX-1512/U, Telephone Cable Assembly	3d	4
CX-1606/G, Telephone Cable Assembly	3c	4

Cable consideration for installation:

Poles	68	56
Trees	69	56

Cable Hanger PF-203/G	63b	51
-----------------------------	-----	----

Cable identification	35	28
----------------------------	----	----

Cable jacket repair	117	106
---------------------------	-----	-----

Cable lines concealment	18	17
-------------------------------	----	----

Cable Stub CC-356	4d	6
-------------------------	----	---

Cable, Telephone, WF-8/G	5	7
--------------------------------	---	---

Capacitance, test data	98b	90
------------------------------	-----	----

Carrier systems:

4-channel system	4b	5
12-channel system	4c	6

Characteristics, technical	12	14
----------------------------------	----	----

Clamp PF-61	63b	51
-------------------	-----	----

Clamp PF-211()/G	63c	51
-------------------------	-----	----

Cleaning:

Cable during re-reeling	114c	105
Connector faces	93b	87

Clearance, vertical	66	55
---------------------------	----	----

Coil, loading	10	12
---------------------	----	----

Common names	13	14
--------------------	----	----

Comparable features of surface, buried, and aerial cable	20	18
--	----	----

Concealment of cable lines	18	17
----------------------------------	----	----

Connection of cable to open wire and equipment	78	71
--	----	----

Connector:

Burying and marking location	57	48
------------------------------------	----	----

Description	6	8
-------------------	---	---

Joining	14	15
---------------	----	----

Joining with loading coil	15	16
---------------------------------	----	----

Maintenance	93	86
-------------------	----	----

Reconditioning and replacing	116	106
------------------------------------	-----	-----

Connector locations:		
Procedures, buried cable lines:		
Cable on ground	54	46
Cable on reels	53	45
Tension bridges	70	57
Construction:		
Organization	27	24
Personnel	29	24
Supply of materials	32	26
Team signals	31	25
Construction of:		
Aerial cable lines. (<i>See</i> Aerial cable line construction.)		
Buried cable lines. (<i>See</i> Buried cable line construction.)		
Surface cable lines. (<i>See</i> Surface cable line construction.)		
Corners:		
Securing cable when using poles	73	63
Securing cable when using trees	74	66
Crosses, tests	101	96
Crossings:		
Construction:		
Buried	43	39
Overhead	42	34
Road (buried)	55	47
Recovery:		
Overhead	124	115
Underground	125	115
Underwater	126	116
Cuts or gouges in cable jacket, repair	115b	105
Damaged connectors, repair	115f	106
Data, test	98	90
Definition of preventive maintenance	82	77
Depot splicing procedures	118	107
Depth of plowing	49	44
Description:		
Cable Assembly CX-1065/G	7	9
Cable faults	97	89
Connector	6	8
Reel DR-15-B	11	13
Telephone Cable Assembly CX-1512/U	9	9
Telephone Cable Assembly CX-1606/G	8	9
Telephone Cable WF-8/G	5	7
Telephone Loading Coil Assembly CU-260/G	10	12
Destruction of equipment:		
Authority	137	121
Procedure	138	121
Direct-pull method of removing buried cable	135	119
Drive hook	63d	51
DR-15-B, Reel	11	13
Duties of:		
Buried cable construction teams	47	43
Electrical testing team	47	43
Surface cable construction teams	38	28
Survey party	25	22

	<i>Paragraphs</i>	<i>Page</i>
Electrical tests, final	119a	109
Equipment:		
Destruction	137	121
Recovery	121	111
Required for construction	38	28
Erecting supports at overhead crossings	42	34
Estimate of materials	28	24
Fastening cable to stakes	40	32
Field repair:		
Cable, general	88	80
Cable jackets	92	86
Loading coils and connectors	93	86
Field splices:		
Tension bridge	91	86
With sleeves	89	80
Without sleeves	90	83
Final testing and marking	119	109
Grounds, tests	100	96
Guying, messenger strands	76	67
Handling cable, precautions	34	26
Hitch, basket	41	34
Hook PF-81	63d	51
Identification of cables	35	28
Inspection of recovered cable	114	105
Installation of Telephone Repeater AN/TCC-11	80	74
Insulation resistance:		
Test	101	96
Test data	98c	91
Joining connectors	14	15
Joining connectors with loading coils	15	16
Laying cable:		
Buried crossings	43	39
In swampy ground or water	39d	31
Overhead crossings	42	34
Personnel and equipment required	38	28
Precautions	34	26
Procedures	39	29
Speed	37	28
LC-61, Plow	45	42
Line routing to avoid hazards	19	18
Line supports and fixtures, recovery	132	118
Loading coils:		
Description	10	12
Maintenance	93	86
Reconditioning and replacing	116	106
Testing	103	96
Location of trouble by use of tone set and exploring coil	112b	101

	Paragraphs	Page
Lowering aerial cable:		
Alternate methods -----	131	118
At corners -----	130	117
In straight line sections -----	129	116
Lubrication of cable -----	51	44
During rewinding -----	114c	105
Maintenance:		
Connectors and loading coils -----	93	86
Preventive. (<i>See Preventive Maintenance.</i>)		
Testing:		
General -----	110	100
Procedure of trouble team -----	111	101
Tracing path of buried cable -----	112	101
Map preparation -----	21	19
Materials:		
Aerial cable lines -----	63	51
Estimate for construction -----	28	24
Supply during construction -----	32	26
Names, common -----	13	14
Notes taken during survey -----	25	22
Opens, test -----	99	91
Open wire, connections to cable -----	78	71
Operations, plowing -----	53, 54	45, 46
Organization of construction, general -----	27	24
Personnel -----	29	24
Overhead crossings, procedures -----	42	34
Personnel and equipment for plowing -----	46	42
Personnel, organization for construction -----	29	24
PF-61, Clamp -----	63f	51
PF-81, Hook -----	63d	51
PF-211()/G, Clamp -----	63c	51
PF-203/G, Cable Hanger -----	63b	51
Planning route -----	16-21	17
Plow LC-61 -----	45	42
Plowing:		
Depth -----	49	44
In water, soft ground, or swamps -----	56	48
Operations:		
Cable on reels -----	53	45
Cable laid on ground -----	54	46
Preparations -----	52	45
Speed -----	50	44
Team duties -----	47	43
Poles and supports -----	63a	51
Precautions in laying and handling cable -----	34	26
Precautions, safety -----	30	25
Preparation of route map -----	21	19
Preventive Maintenance:		
Aerial cable lines -----	87	79
Buried cable lines -----	86	79
Definition -----	82	77

	<i>Paragraphs</i>	<i>Page</i>
Preventive Maintenance—Continued		
Surface cable lines.....	85	78
Techniques	84	78
Tool, test equipment, and materials.....	83	77
Proof testing (as line is built):		
General procedure	104	97
Procedure if faults are found.....	108	98
Procedure with wire chief available.....	106	98
Procedure without wire chief.....	107	98
Test personnel and equipment.....	105	97
Tests on completion of line.....	109	100
Purpose and use.....	3	4
Raising cable onto poles.....	71	59
Raising cable onto trees.....	72	61
Reconditioning and replacing connectors.....	116	106
Records and forms.....	2	1
Recovery of aerial cable:		
Alternate methods	131	118
Corners	130	117
General procedures	128	116
Straight line sections.....	129	116
Supports and fixtures.....	132	118
Recovery of buried cable:		
Direct pull	135	119
General procedures	133	119
Tests to select method of recovery.....	134	119
Using plow	136	120
Recovery of surface cable:		
Aerial crossings	124	115
Application of methods.....	122	113
Inaccessible areas	127	116
Recovery procedures	123	113
Underground crossings	125	115
Underwater crossings	126	116
Recovery procedures:		
General	120	111
Organization of personnel and equipment.....	121	111
Repair, field:		
Cable jackets	92	86
General	88	80
Splices	89, 90	80, 83
Reel DR-15-B	11	13
Repair instructions:		
General procedures	113	104
Inspection of recovered cable.....	114	105
Repair of cable jacket.....	117	106
Repair of faults.....	115	105
Repeater, Telephone AN/TCC-11.....	79-81	72
Replacing old type cable with new type cable.....	4d	6
Requirements:		
Sag on aerial lines.....	65a	52
Span lengths on aerial lines.....	64	52
Rewinding cable	114b	105

	<i>Paragraphs</i>	<i>Page</i>
Route map preparation-----	21	19
Route marking during survey-----	26	22
Route planning, general-----	16	17
Routing line to avoid hazards-----	19	18
Safety precautions-----	30	25
Securing cable:		
Corners:		
Using poles-----	73	63
Using trees-----	74	66
Intermediate supports-----	72	61
Shorts, tests for-----	101	96
Signals used by construction team-----	31	25
Siting Telephone Repeater AN/TCC-11-----	79	72
Spacing from roads, power lines, and buildings-----	67	55
Span construction-----	75, 77	67, 71
Speed of plowing-----	50	44
Splices:		
Depot-----	118	107
Field, with sleeves-----	89	80
Field, without sleeves-----	90	83
Speed of laying cable-----	37, 61	28, 50
Surface cable lines:		
Comparison to aerial and buried cable lines-----	20	18
Construction:		
Fastening cable to stakes-----	40	32
General procedures-----	36	28
Laying cable in swampy ground and water-----	39d	30
Procedures at buried crossings-----	43	39
Procedures at overhead crossings-----	42	34
Procedures for laying cable-----	39	29
Survey:		
Equipment-----	23b	21
Notes-----	25	22
Party-----	23a	21
Party duties-----	24	21
Route marking-----	26	22
Surveying route, general procedures-----	22	19
System applications-----	4	4
Team signals-----	31	25
Technical characteristics-----	17	17
Techniques of preventive maintenance-----	84	78
Telephone Cable Assembly CX-1512/G-----	9	9
Telephone Cable Assembly CX-1606/G-----	8	9
Telephone Cable WF-8/G-----	5	7
Telephone Loading Coil Assembly CU-260/G-----	10	12
Telephone Set TA-43/PT-----	95c	88
Tension bridges at:		
Connector points-----	70	57
Field splices-----	91	86
Test data-----	98	90
Test equipment-----	95	88

	<i>Paragraphs</i>	<i>Page</i>
Testing cable assemblies:		
Before installation -----	33a	28
During installation -----	33b	26
Testing, general -----	94	88
Testing precautions -----	96	89
Tests, alternate methods -----	102	96
Tests for:		
Grounds -----	100	96
Opens -----	99	91
Shorts and crosses -----	101	96
Tests upon completion of line -----	107	98
Tools and test equipment -----	95	88
For cable testing -----	95	88
For preventive maintenance -----	83	77
Use -----	3	1
Vertical clearance requirements -----	66	55

BY ORDER OF THE SECRETARIES OF THE ARMY
AND THE AIR FORCE:

MAXWELL D. TAYLOR,
General, United States Army,
Chief of Staff.

OFFICIAL:

JOHN A. KLEIN,
Major General, United States Army,
The Adjutant General.

N. F. TWINING,

OFFICIAL:

Chief of Staff, United States Air Force.

E. E. TORO,
Colonel, United States Air Force,
Air Adjutant General.

DISTRIBUTION:

Active Army:

CNGB (1)
Tec Svc, DA (1)
Tec Svc Bd (1)
Hq, CONARC (5)
CONARC Bd (Incl ea Test
Sec) (1)
Army AA Comd (2)
OS Maj Comd (5)
OS Base Comd (5)
Log Comd (5)
MDW (1)
Armies (5)
Corps (2)
Tng Div (2)
Ft & Cp (2)
Gen & Br Svc Sch (5) ex-
cept Sig Sch (25)
USMA (5)
Gen Depots (2) except At-
lanta Gen Depot (None)
Sig Sec, Gen Depots (10)
Sig Depots (20)
POE (2)
OS Sup Agencies (2)
Sig Fld Maint Shops (3)
Sig Lab (5)
Mil Dist (1)

Units organized under following TOE:
11-7R, Sig Co, Inf Div (2)
11-15R, Sig Bn, Corps or Abn
Corps (2)
11-16R, Hq & Hq Co, Sig Bn, Corps
or Abn Corps (2)
11-18R, Wire and Rad Relay Opr
Co (2)
11-25R, Sig Cons Bn (2)
11-27R, Sig Cons Co (2)
11-57R, Armd Sig Co (2)
11-95R, Sig Opr Bn (2)
11-97R, Wire Opr Co (2)
11-98R, Rad Opr Co (2)
11-117R, Sig Spt Co (2)
11-127R, Sig Rep Co (2)
11-128R, Sig Depot Co (2)
11-500R (AA-AE), Sig Svc Org
(2)
11-537R, Sig Co, Amph Spt Brig
(2)
11-557R, Abn Sig Co (2)
11-587R, Sig Base Maint Co (2)
11-592R, Hq & Hq Co, Sig Base
Depot (2)
11-597R, Sig Base Depot Co (2)
20-300R, Amph Spt Brig (2)
57R, Abn Div (2)

NG: State AG (6); Units—same as Active Army except allowance is
one copy per unit.

USAR: None.

For explanation of abbreviations used, see SR 320-50-1.

