

TM 5-9062

✓ 1/4 lb U113
.2
tm

U.S. 1943
Dept. of Army

**WAR DEPARTMENT
MAINTENANCE MANUAL
AND PARTS CATALOG**

**POWER CONTROL UNIT, CABLE
OPERATING, LE TOURNEAU
MODEL HN**

**R. G. LeTOURNEAU, INC.
PEORIA, ILL.**

APRIL 7, 1943

TM5-9062

War Department

TM5-9062, Maintenance Manual and Parts Catalog,
Power Control Unit, Model HN, published by the
R. G. LeTourneau, Inc., is furnished for the
information and guidance of all concerned.

(AG 300.7 (8/12/43) PC (C), June 10, 1941.)

G. C. MARSHALL
Chief of Staff

Official:

J. A. ULIO

Major General,
The Adjutant General

*Doc will
gift
non civic*

TABLE OF CONTENTS

U113
2
TM 5:9062
1943

OPERATION SECTION



	PAGE
Description of Power Control Unit	Preface
Introduction	1
Cable	2
Cable Threading	2
Operation, including Safety Precautions	3
Functions of Power Control Unit	5
Specifications	6
Preparation for Initial Operation	6
Cut-away view of Unit showing points of Lubrication and Adjustment that can be taken care of by Operators	7
Operator's Adjustments	8
Lubrication	14
Operation under Dusty, Muddy, Low Temperature and other Abnormal Conditions	16
Preparation for Storage	16

REPAIR SECTION



Care of Power Control Unit	1
Adjustments	1
Disassembling	8
Removing Power Control Unit	18
Re-Assembling	20
Installing	25
Clutch and Brake Facings	27
Table of Clearances and Tolerances of Bearings and Adjustable Parts	31
Trouble Shooter's Guide	32

PARTS CATALOG



Case Cross Section	1
Case Group (Exploded)	2
Brake Group (Exploded)	3
Main Gear and Driving Cone (Exploded)	4
Secondary Idler Group (Exploded)	5
Primary Idler Group (Exploded)	6
Cable Drum Group (Exploded)	7
Handle Group (Exploded)	8

M574500

INDEX

	Page
Adjustments (Operator's)	8 (Operation Sect.)
Adjustments (Maintenance & Repair Men's)	1 (Repair Sect.)
Assembling	20 (Repair Sect.)
Brake Adjustment	8 (Operation Sect.)
Brake Facings	27 (Repair Sect.)
Brake Group Parts Illustration (Exploded)	3 (Parts Catalog)
Brake Shaft Bearing Adjustment	10 (Operation Sect.)
Cable	2 (Operation Sect.)
Cable Drum Bearing Adjustment	2 (Repair Sect.)
Cable Drum Group Parts Illustration (Exploded)	7 (Parts Catalog)
Cable Threading	2 (Operation Sect.)
Care of Clutch & Brake Facings	27 (Repair Sect.)
Care of Power Control Unit	1 (Repair Sect.)
Case Cross-Section Parts Illustration	1 (Parts Catalog)
Case Group Parts Illustration (Exploded)	2 (Parts Catalog)
Clutch Adjustment	11 (Operation Sect.)
Clutch Facings	27 (Repair Sect.)
Description of Power Control Unit	Preface
Disassembling	8 (Repair Sect.)
Functions of Power Control Unit	5 (Operation Sect.)
Handle Group Parts Illustration (Exploded)	8 (Parts Catalog)
Installing Power Control Unit	25 (Repair Sect.)
Installing Clutch & Brake Facings	29 (Repair Sect.)
Lubrication	14 (Operation Sect.)
Main Gear Bearing Adjustment	5 (Repair Sect.)
Main Gear and Driving Cone Parts Illustration (Exploded)	4 (Parts Catalog)
Operation	3 (Operation Sect.)
Operator's Adjustments	8 (Operation Sect.)
Operation under Dusty, Muddy, Low Temperature and other Abnormal Conditions	16 (Operation Sect.)
Points of Lubrication and Adjustment that can be taken care of by Operator	7 (Operation Sect.)
Preparation for Initial Operation	6 (Operation Sect.)
Preparation for Storage	16 (Operation Sect.)
Primary Idler Group Parts Illustration (Exploded)	6 (Parts Catalog)
Re-Assembling	20 (Repair Sect.)
Re-Installing	25 (Repair Sect.)
Removing Power Control Unit	18 (Repair Sect.)
Safety Precautions	3 (Operation Sect.)
Secondary Idler Group Parts Illustration (Exploded)	5 (Repair Sect.)
Specifications	6 (Operation Sect.)
Table of Clearances & Tolerances of Bearings and Adjustable Parts	31 (Repair Sect.)
Trouble Shooter's Guide	32 (Repair Sect.)
Working Principle	5 (Operation Sect.)

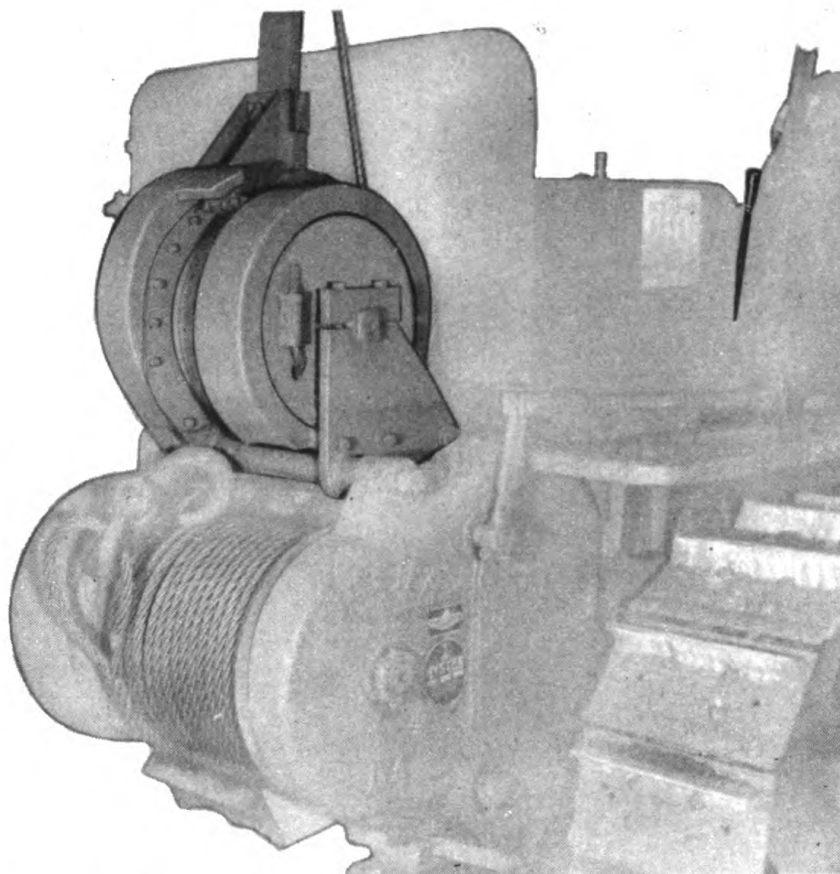

THE LETOURNEAU MODEL HN POWER CONTROL UNIT

Designed for use with Caterpillar D4 and R4 Tractors, the LeTourneau Model HN Power Control Unit provides the means by which the operator can accurately control the 'Dozer on the front of the tractor.

The Power Control Unit is mounted directly on top of the Hyster D4 Towing Winch at the rear of the tractor, and is driven by a take-off idler gear inside the winch.

The control cable (wire rope) extends from the Power Control Unit cable drum up over the 'Dozer A-Frame and down to the 'Dozer bowl at the front of the tractor.

By movement of the Power Control Unit control lever, the operator can at will cause the control cable to be either spooled on or unspooled off the cable drum, thereby causing the 'Dozer bowl to be either raised or lowered. (Refer to 'Dozer manual.)

The Model HN Power Control Unit is a compact unit, and embodies somewhat the same features as other LeTourneau Power Control Units. Like other LeTourneau Units, it places positive, instant control in the hands of the operator. If properly operated and serviced, it should give an almost unlimited amount of trouble-free operation.

SECT.

OPERATION SECTION

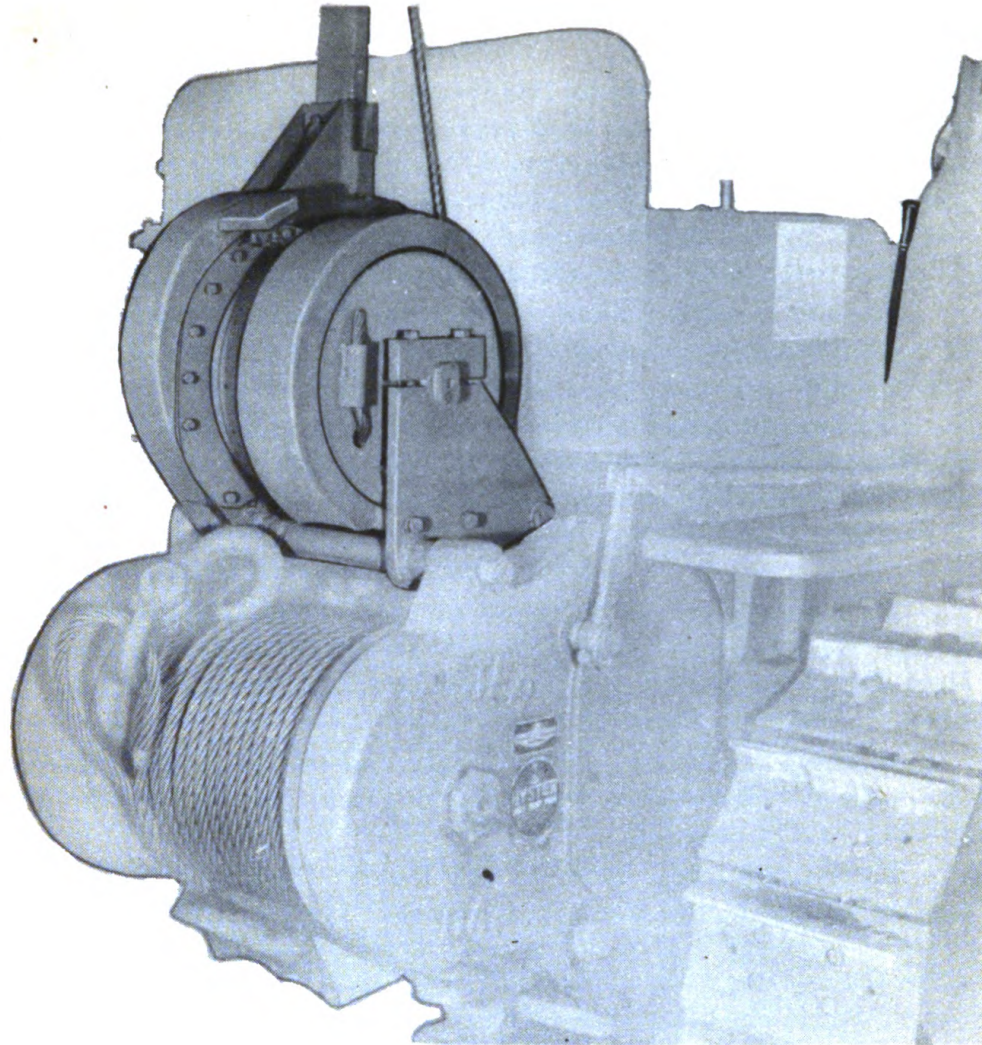

OPERATION SECTION

It has often been said that "No machine is better than the operator behind the controls."

This statement carries with it a great amount of truth, and is especially true of equipment used in earthmoving.

Not only is the performance of the equipment dependent upon the skill with which the operator handles the operation, but also upon the every day maintenance performed by the operator.

Since the effectiveness of the 'Dozer and tractor is to a large extent dependant upon the performance of the Power Control Unit, it is very important that the Unit be correctly operated and serviced.

On the following pages will be found the recommended procedures to be followed by the operator in operating and servicing the Power Control Unit.

CABLE

The LeTourneau Model HN Power Control Unit is designed for use with Tournarope or other high quality wire rope meeting the following specifications:—6 x 19 wire rope of Warrington construction with strand center, preformed, Langlay, and made from improved plow steel. It should be internally lubricated during the manufacturing process. (Other cable of equal construction can be used without harmful results.)

For size of cable (diameter and length), refer to the Parts Catalog covering the particular piece of equipment being operated by the Power Control Unit.

Do not use larger diameter cable than that specified in the Parts Catalog or damage to the equipment may result. If smaller cable than specified is used, frequent cable breakage may occur.

CABLE THREADING

To correctly thread the cable onto the Power Control Unit cable drum, first thread the cable through the 'Dozer A-Frame, leaving the front end of the cable unsecured at the cable wedge on the front of the 'Dozer. (Refer to 'Dozer Manual.)

As a safety measure, do not thread the cable onto the cable drum (as outlined below) when the tractor engine is running with the tractor flywheel clutch engaged.

Extend the cable down to the Power Control Unit cable drum, pulling several feet of slack in the cable. Then extend the end of the cable out through hole A in the cable drum flange, pulling a few feet of cable through the hole. Then insert the cable back through hole B and out through hole C, not drawing cable tight through holes. Extend the end of the cable through loop D, allowing approximately 1" of the cable to protrude from end of loop.

Hold the end of the cable in this position and pull all slack between loop D and hole C back through hole C. Then pull all slack between holes C and B out through hole B and all slack between holes B and A back through hole A, drawing the cable tight.

Anchor the cable at the cable wedge at the front of the 'Dozer, a few inches from the end of the cable. Then spool the slack cable evenly onto the cable drum by engaging the clutch slowly, using little force on the control lever. During this operation, idle the tractor engine at low speed to cause the cable drum to turn slowly.

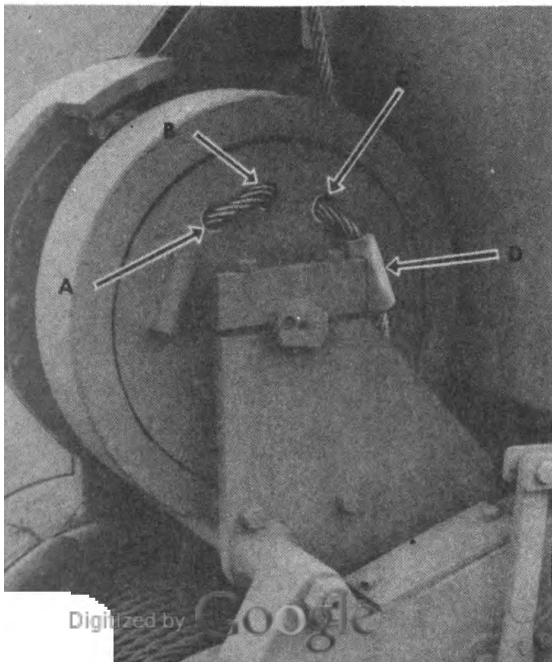

OPERATION

The Power Control Unit is operated by moving the control lever, located at the right of the operator in front of the tractor seat.

The control lever is normally in neutral position. To engage the clutch and thereby spool cable onto the cable drum, move the control lever to the rear with a quick, full movement. To disengage the clutch and thereby stop the spooling of the cable onto the drum, allow the control lever to return to neutral position.

The Power Control Unit brake automatically releases when the clutch is engaged and automatically takes hold when the clutch is disengaged with the control lever in neutral position. To release the brake to permit free-spooling of the cable off the cable drum, move the control lever forward from neutral position. To stop the free-spooling of the cable, move the control lever back into neutral position, thereby allowing the brake to take hold.

In order to avoid clutch and brake slippage and the resultant over-heating of the Power Control Unit clutches and brakes, the operator should always fully engage and disengage the clutch with a quick, full movement of the control lever. Overheating of the Power Control Unit from improper operation may cause the leather in the oil seals to harden and result in oil and grease leakage.

The extreme forward position of the control lever is known as the "lock-out" position. When in this position, the brake is fully released and the cable drum can be turned in either direction by hand.

Instructions which pertain to the use of the Power Control Unit with 'Dozers, etc. will be found in the manuals covering those machines.

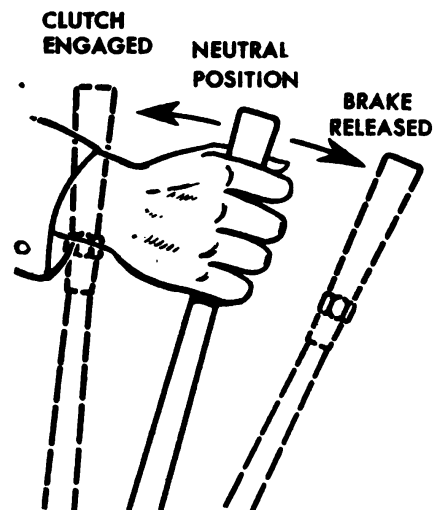

HYSTER CONTROL LEVERS HAVE NO AFFECT ON OPERATION OF POWER CONTROL UNIT.

SAFETY PRECAUTIONS

1. When operating the Power Control Unit, keep the hands free from the cable and working parts.
2. Do not use weak, frayed cable which might break when under tension.
3. Always lower 'Dozer bowl to the ground before working on Power Control Unit. Do not work on Unit while tractor engine is running with the flywheel clutch engaged.
4. When Power Control Unit has been idle for a period of a few days, move control lever into lock-out position and check band to make sure it is not "frozen" tight on drum before operating.

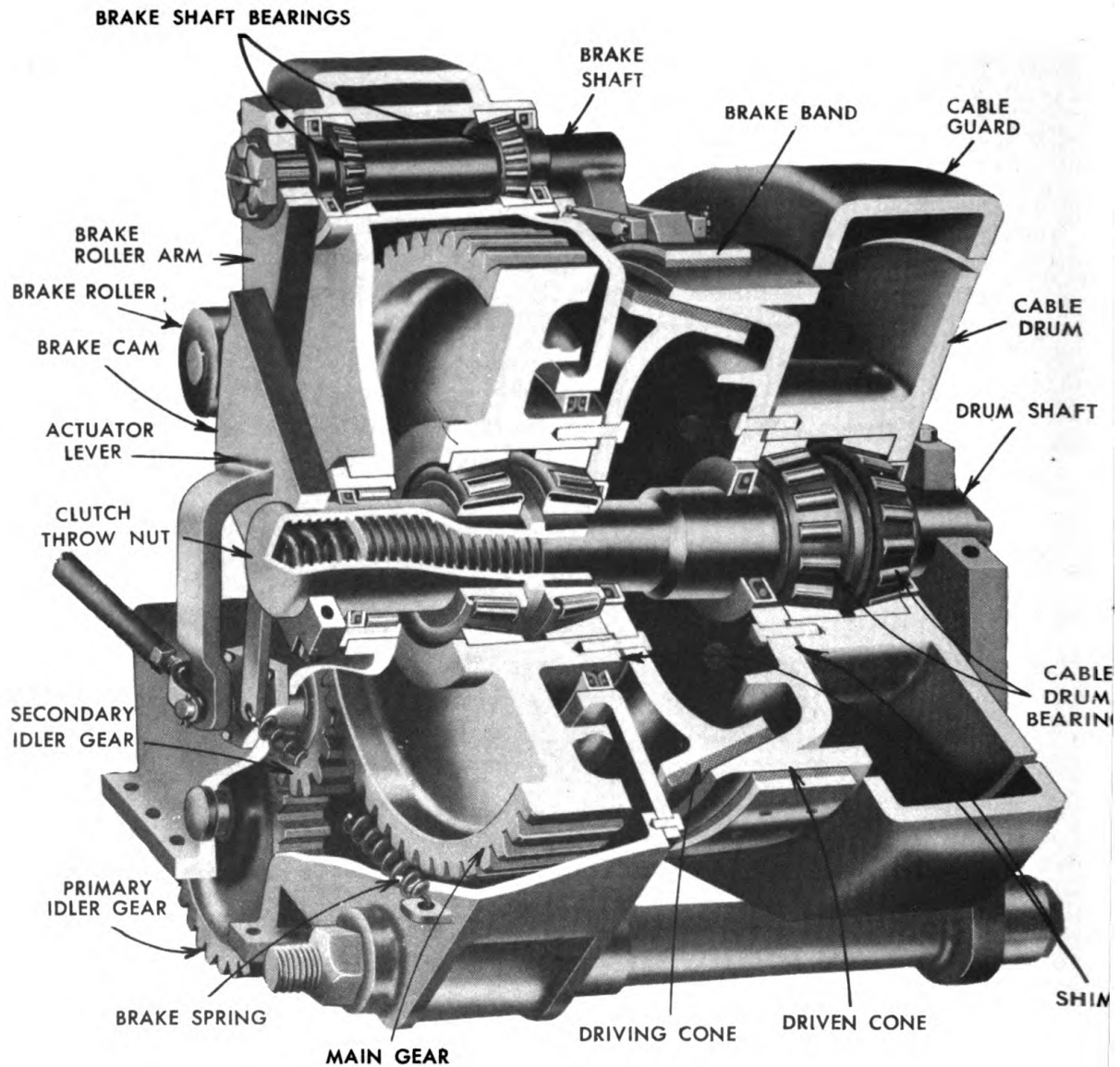

Cutaway view of model HN Power Control Unit.

WORKING PRINCIPLE

When tractor engine is running with flywheel clutch engaged, the engine turns take-off idler gear in Hyster winch. Take-off idler gear turns Power Control Unit primary idler gear (1) which turns secondary idler gear (2) which turns main gear (3). Main gear and driving cone (assembled together as one unit) ride on bearings on clutch throw nut and turn constantly when engine is running with flywheel clutch engaged.



To engage clutch and thereby spool cable onto cable drum, control lever is moved to the rear. This moves control rod (4) forward, which causes actuator lever (5) to turn clutch throw nut (6) in clockwise direction, advancing throw nut to right on threads on drum shaft (7). Rotating main gear and driving cone move to right with throw-nut, bringing driving cone into contact with driven cone (8), engaging clutch. Driven cone and cable drum now turn, spooling cable onto drum.

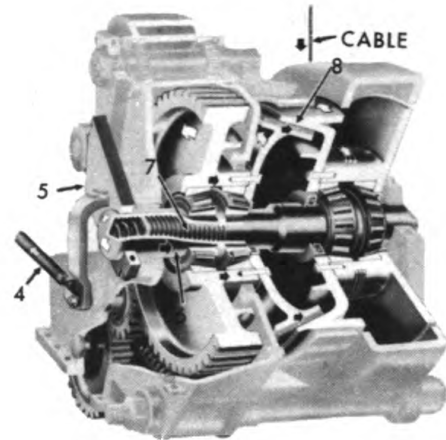

To disengage clutch and thereby stop spooling of cable onto cable drum, control lever is returned forward to neutral position. This moves control rod (4) to the rear, which causes actuator lever to turn clutch throw nut counter-clockwise, thereby moving throw-nut, gear and driving cone to the left, disengaging clutch. Cable drum is held by self energizing brake which takes hold when control lever is in neutral.

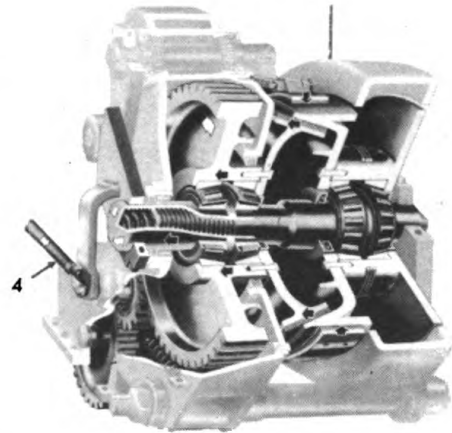

To release brake to permit un-spooling of cable off cable drum, control lever is moved forward from neutral position. This moves control rod (4) to the rear, causing actuator lever and brake cam to move forward against brake roller (10), moving bottom of roller arm (11) forward. This turns brake shaft (12) clockwise, and linkage connecting right end of shaft with brake band (13) raises band away from drum, releasing brake.

To engage brake, return control lever to neutral position.

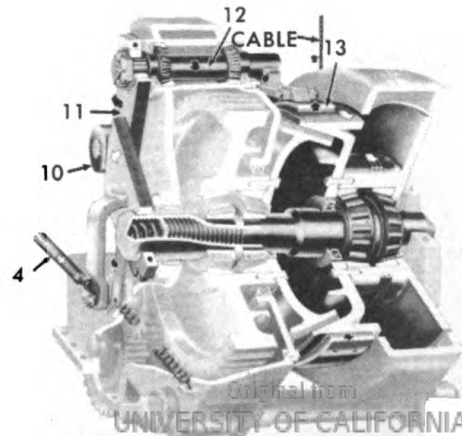

SPECIFICATIONS

MODELHN

FOR USE WITH.....Caterpillar D4 and R4 Tractors

DRUMS:

Number and Mounting.....Single—Rear
 Diameter6⁵/₈"
 Length4"
 Flange Diameter.....13"

OPERATION.....Mechanical From Tractor Gears in conjunction
 with Willamette Hyster Towing Winch

GEAR REDUCTION5.82:1

LINE PULL:

Bare Drum.....3075 lbs.
 Full Drum.....1825 lbs.

LINE SPEED:

Bare Drum308 ft. per minute
 Full Drum.....518 ft. per minute

CABLE CAPACITY, 1/2" CABLE.....111 Ft.

NET WEIGHT.....Approx. 480 lbs.

PREPARATION FOR INITIAL OPERATION

Before placing a newly delivered Power Control Unit in operation, check the following:

1. Make sure that the cork is removed from the breather hole in the oil fill plug.
2. Check oil level in Hyster winch. The oil should never be permitted to drop below the oil level plug.
3. Check the threading of the cable on the cable drum for correctness. (Refer to cable threading instructions on page 2 of Operation Section).
4. Make sure brake band is not "frozen" to driven cone by moving control lever to lock-out position. Then check band to make sure it is free before operating unit.
5. Check clutch and brake adjustments. (Refer to adjustment instructions on pages 8 and 11 of Operation Section.) Make any needed corrections.

BRAKE SHAFT BEARINGS
Check adjustment every 1,024 hours.
Hand packed with lubricant every 2,048 hours, usually by maintenance and repair men, rather than operators.

BRAKE
Check adjustment every 8 hours.

CLUTCH
Make adjustment when needed.

BRAKE ROLLER
Lubricate every 4 hours.

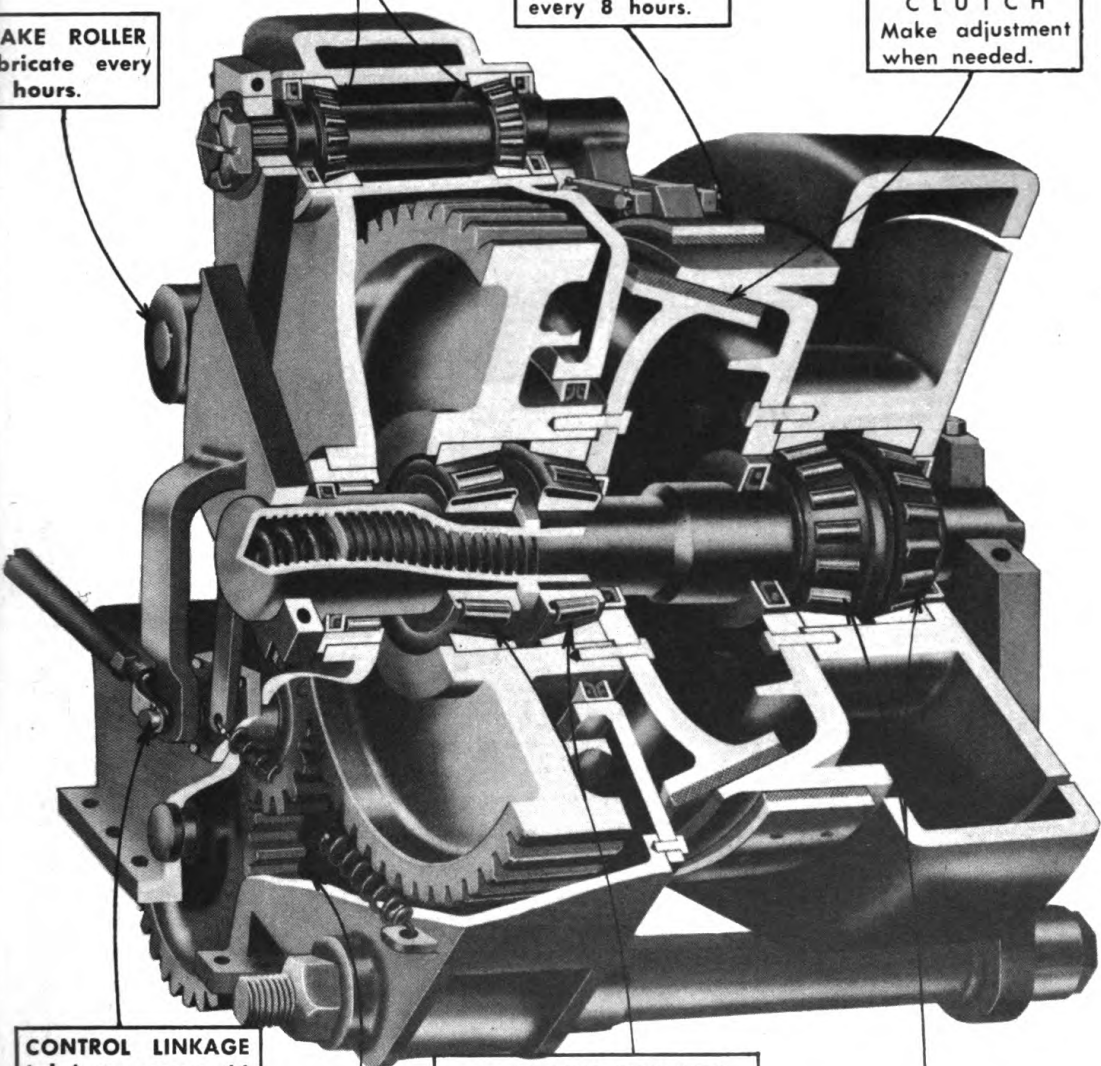

CONTROL LINKAGE
Lubricate every 64 hours.

MAIN GEAR BEARINGS
Adjustment checked every 256 hours by maintenance and repair men.

GEAR CASE
Check oil level every 64 hours.
Change oil every 1,024 hours.

CABLE DRUM BEARINGS
Hand packed with lubricant every 1,024 hours, usually by maintenance and repair men, rather than operators.
Adjustment checked every 256 hours by maintenance and repair men.

Cutaway view of unit, showing points of lubrication and adjustment that can be taken care of by operator.

Generated on 2017-03-08 12:26 GMT / http://hdl.handle.net/2027/uc1.b3241428
Public Domain, Google-digitized / http://www.hathitrust.org/access_use#pd-google

ADJUSTMENTS

The successful operation of the LeTourneau Power Control Unit is more dependent upon proper adjustment than any one other thing. If properly adjusted, the Unit should give trouble-free operation. However, if not in the correct adjustment, difficulty in its operation may result.

The clutch adjustment, brake adjustment, and brake shaft bearing adjustment can be made without disassembling the unit, and can therefore be taken care of by the operator (refer to instructions which follow). The cable drum bearing adjustment and main gear bearing adjustment require partial disassembly of the unit, and are therefore usually taken care of by maintenance and repair men. (For instructions, refer to Repair Section.)

BRAKE ADJUSTMENT

Occasional adjusting of the Power Control Unit brake is necessary because of brake lining wear.

Check brake adjustment every 8 hours of operation. To check adjustment, follow the instructions below:

HOW TO CHECK ADJUSTMENT

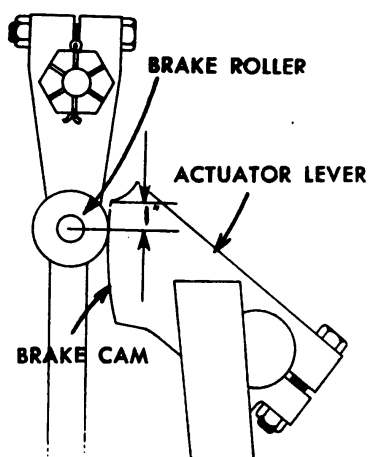

With the control lever in neutral position, check the position of the brake roller against the brake cam on the front of the actuator lever.

The accompanying drawing illustrates the correct relative position of the brake roller against the cam when the control lever is in neutral position (with slack in cable.)

If the position of the roller against the cam is not approximately as illustrated, an adjustment should be made.

IF ADJUSTMENT IS INCORRECT

If the unit should be operated with the brake roller not correctly positioned against the brake cam (refer to illustration above) the action of the brake cam against the roller will be affected and may cause the brake to not properly release.

Also, the tension of the brake spring will be affected, possibly resulting either in brake slippage or in more effort being required to disengage the brake than should be necessary.

HOW TO MAKE BRAKE ADJUSTMENT

1. Loosen clamp bolt at upper end of brake roller arm. (The use of two wrenches may be necessary to prevent bolt from turning with nut.) Brake spring will pull roller arm back against brake cam when bolt is loosened, moving actuator lever upward.

2. Place a wrench on right end of brake shaft and tighten brake band on drum by moving wrench forward, using force. Hold the wrench in this position and insert a pry bar over top of actuator lever (1), with one end of bar extending under nut (2). Push down on pry bar far enough to bring brake roller into correct position against brake cam. (approximately 1" down from lock-out position).

3. While holding pry bar in this position with left hand, release right hand from wrench at end of brake shaft and tighten bolt at upper end of brake roller arm. (CAUTION: If pry bar is moved before bolt is tightened, the position of brake roller against brake cam will change, affecting the adjustment, and it will be necessary to repeat steps 2 and 3.) Give bolt final tightening by using two wrenches as in step 1.

After completing step 3, check the adjustment.

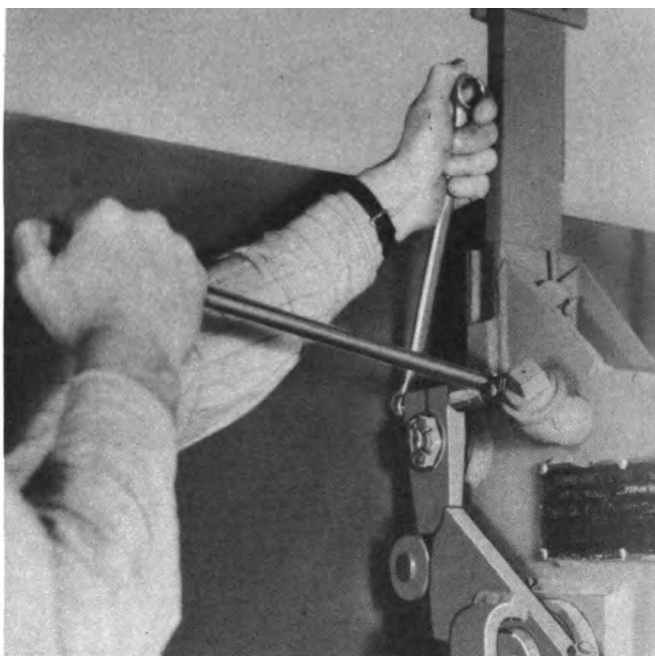

BRAKE SHAFT BEARING ADJUSTMENT

Since the brake shaft only rotates a part of a turn during operation, there is very little wear on the bearings. Therefore, the adjustment does not require frequent attention.

Check the brake shaft bearings for correct adjustment every 1024 hours of operation or when brake slippage is experienced and cannot be traced to any other source.

HOW TO CHECK ADJUSTMENT

To check for bearing looseness, insert a pry bar or similar tool between brake roller arm and gear case, and by prying in and out, detect any end movement of shaft. If end movement is noticeable, the bearings are loose.

To check for bearing tightness, remove brake spring and disconnect brake band from brake shaft. Then rotate shaft by hand. If shaft does not turn freely, the bearings are adjusted too tight.

If bearings are adjusted either too tight or if there is noticeable looseness, an adjustment should be made.

IF ADJUSTMENT IS INCORRECT

If the Power Control Unit is operated with the bearings adjusted too tight, brake slippage may result. If the bearings are noticeably loose, the brake shaft and linkage will have excessive play, affecting the brake action, and the life of the bearings may be shortened.

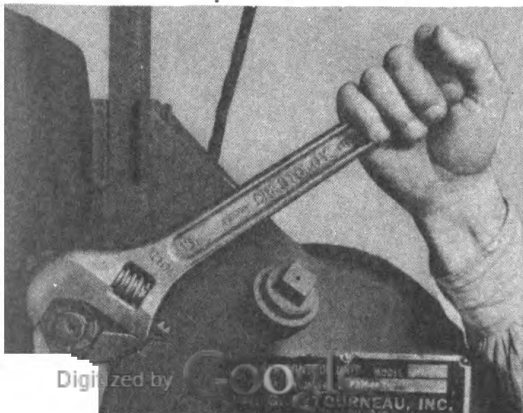

HOW TO MAKE ADJUSTMENT

To make adjustment, first remove brake spring at side of gear case. Then proceed as follows:

1. Remove cotter pin from castellated nut at end of brake shaft.
2. To tighten the bearings, turn the castellated nut clockwise. To loosen the bearings, turn the nut counterclockwise.

The adjustment is correct when the bearings are free rolling and without end play.

When correct adjustment is reached, re-install cotter pin and install brake spring.

CLUTCH ADJUSTMENT

There are no set intervals for checking the clutch adjustment. Rather, the operation of the Unit by the operator serves as a constant check on the adjustment.

If operating a Power Control Unit having an incorrectly adjusted clutch, the operator will have difficulty in making the Power Control Unit function properly, and there will be symptoms which will indicate to him that an incorrectly adjusted clutch is probably the cause of the trouble. These symptoms are: (1) Control lever strikes operator's seat, (2) Clutch won't fully engage, (3) Clutch slippage, (4) Clutch won't release, (5) Clutch dragging, (6) Brake won't fully release, (7) Overheating as a result of the above.

If troubled by one or more of the above symptoms when operating the Unit, a clutch adjustment should be made.

There are three factors which affect the clutch adjustment and which sometimes cause the symptoms listed above:

1. *Incorrect amount of clearance between driving cone and driven cone when control lever is in neutral.* This clearance regulates the distance the driving cone must travel to fully engage the driven cone. Since this clearance cannot be measured accurately without difficulty, it is usually thought of in terms of the distance the control lever travels between neutral and the fully engaged position. If the cones are spaced too far apart, the travel of the control lever from neutral to the fully engaged position will be so great that the control lever will strike the operator's seat before the clutch becomes fully engaged. If spaced too close, the driving cone may drag on the driven cone when the clutch is in neutral position. The clearance between the driving and driven cones is correct when the travel at the top of the control lever from neutral to the fully engaged position is approximately 8". (Slightly less on early Units, due to limited travel of control lever.)



2. *Main gear incorrectly spaced inside gear case.* If spaced too far to the right, the gear will strike right side of gear case as control lever is moved to the rear, preventing the clutch from fully engaging. If spaced too far to the left, it will strike against left side of gear case as control lever is moved forward from neutral, preventing actuator lever from moving into lock-out position, and possibly preventing the brake from fully releasing.

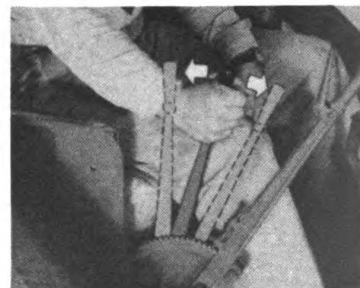

3. *Insufficient clearance between the actuator lever and throw-nut bushing.* If there is insufficient clearance at this point, the actuator lever will ride against the throw-nut bushing before the driving cone becomes fully engaged in the driven cone, thereby preventing the clutch from fully engaging. With the control lever in the fully engaged position there should be some clearance at this point.

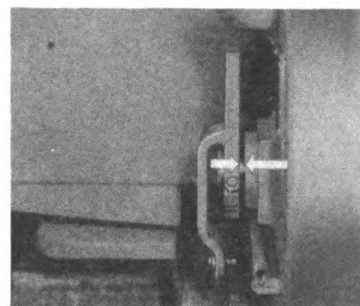

By making the clutch adjustment as outlined on the following page, the three possible sources of trouble listed above will be corrected. If the same symptoms are present after making the adjustment, the difficulty is caused from some other source, and a different correction must be made. (Refer to Trouble Location Chart in Repair Section.)

HOW TO MAKE CLUTCH ADJUSTMENT

To make the clutch adjustment, first make sure that brake roller is correctly positioned against brake cam (refer to brake adjustment instructions on page 8.)

Then proceed as follows:

1. Move control lever forward, into the lock-out position. (Illustration shows relative position of actuator lever and brake roller when control lever is in lock-out position.) Leave lever in this position.

2. Loosen clamp block capscrews at right end of drum shaft.

3. With control lever in lock-out position, turn drum-shaft in clockwise direction as far as it will go. This will bring clutch driving cone and driven cone together tight.

4. Insert pry bar between drum shaft support plate and cable drum and move drum assembly to the left as far as it will go.

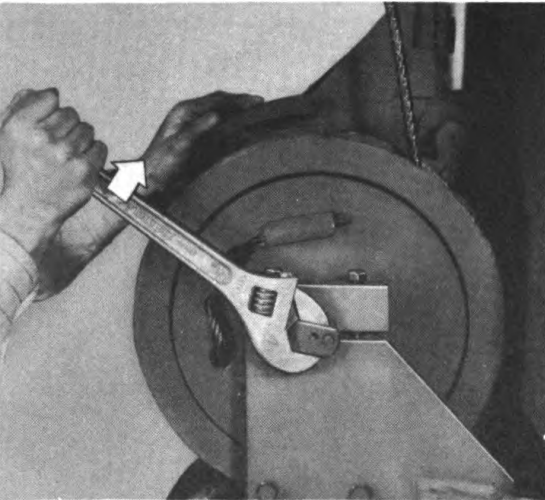
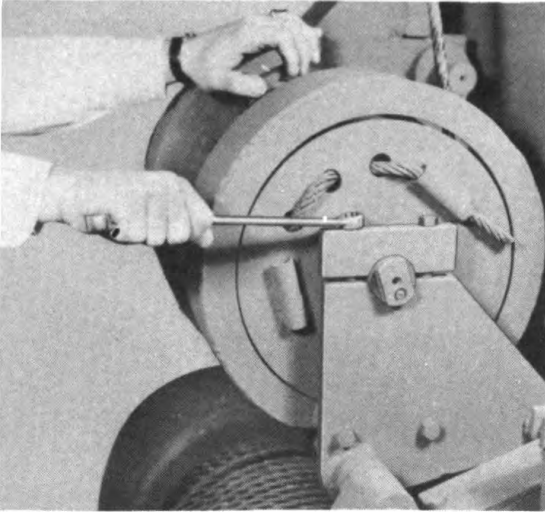
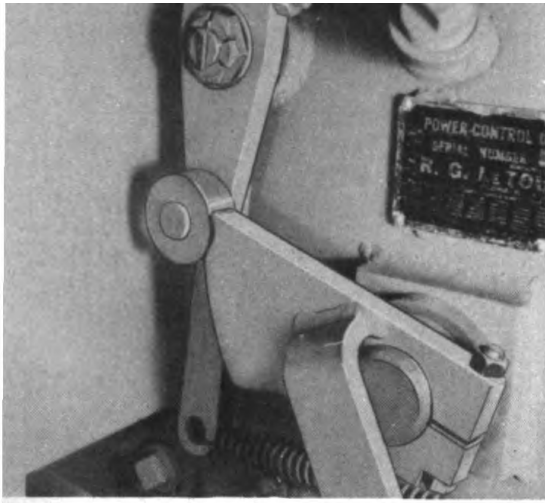

5. Insert pry bar between the lined driving cone and gear case and move driving cone toward drum shaft support plate a distance of $\frac{1}{8}$ " to $\frac{3}{16}$ ". This will correctly space main gear inside gear case.

6. Move control lever from lock-out position, back to a point approximately 6" past neutral position. The drum shaft will turn with the control lever in making this part of the adjustment. (The above 6" travel of control lever from neutral to the fully engaged position will give approximately 8" travel of lever in actual operation after adjustment has been completed.) On early units, it may be necessary to reduce travel of lever to keep it from striking seat when in fully engaged position.

7. Hold the control lever in this position and clamp the drum shaft to the support plate by tightening the clamp block capscrows, drawing capscrows down evenly. (Neither the control lever nor the drum shaft can be allowed to move during this operation.) Then allow control lever to return to neutral position.

8. Fully engage clutch and check for clearance between actuator lever and throw-nut bushing. There should be some clearance at this point. If there is no clearance, release clamp bolt from actuator lever and space lever further out on clutch throw-nut, without changing the relative position of the actuator lever. Then re-tighten clamp bolt.

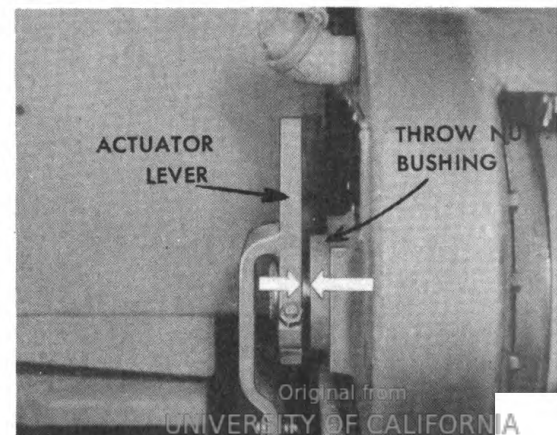
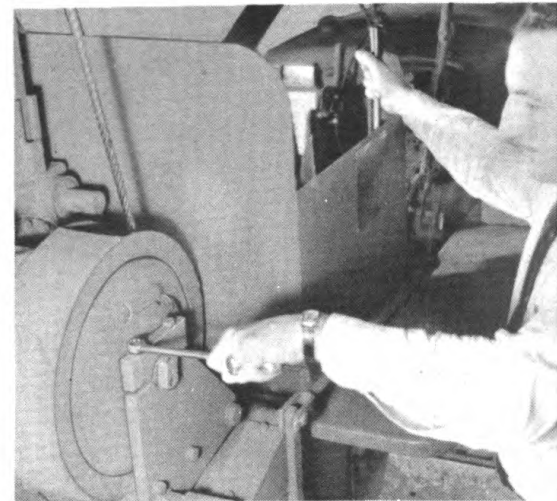
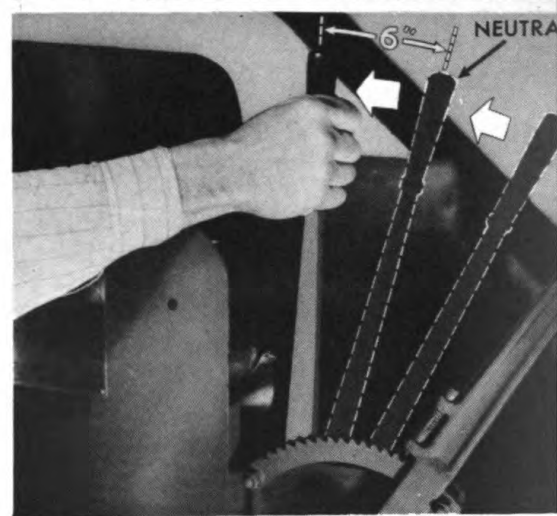
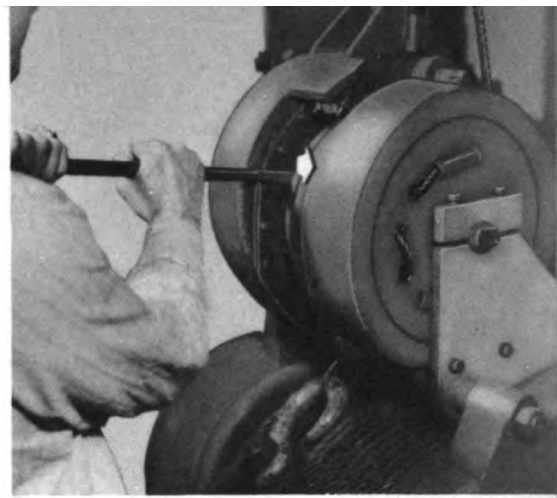

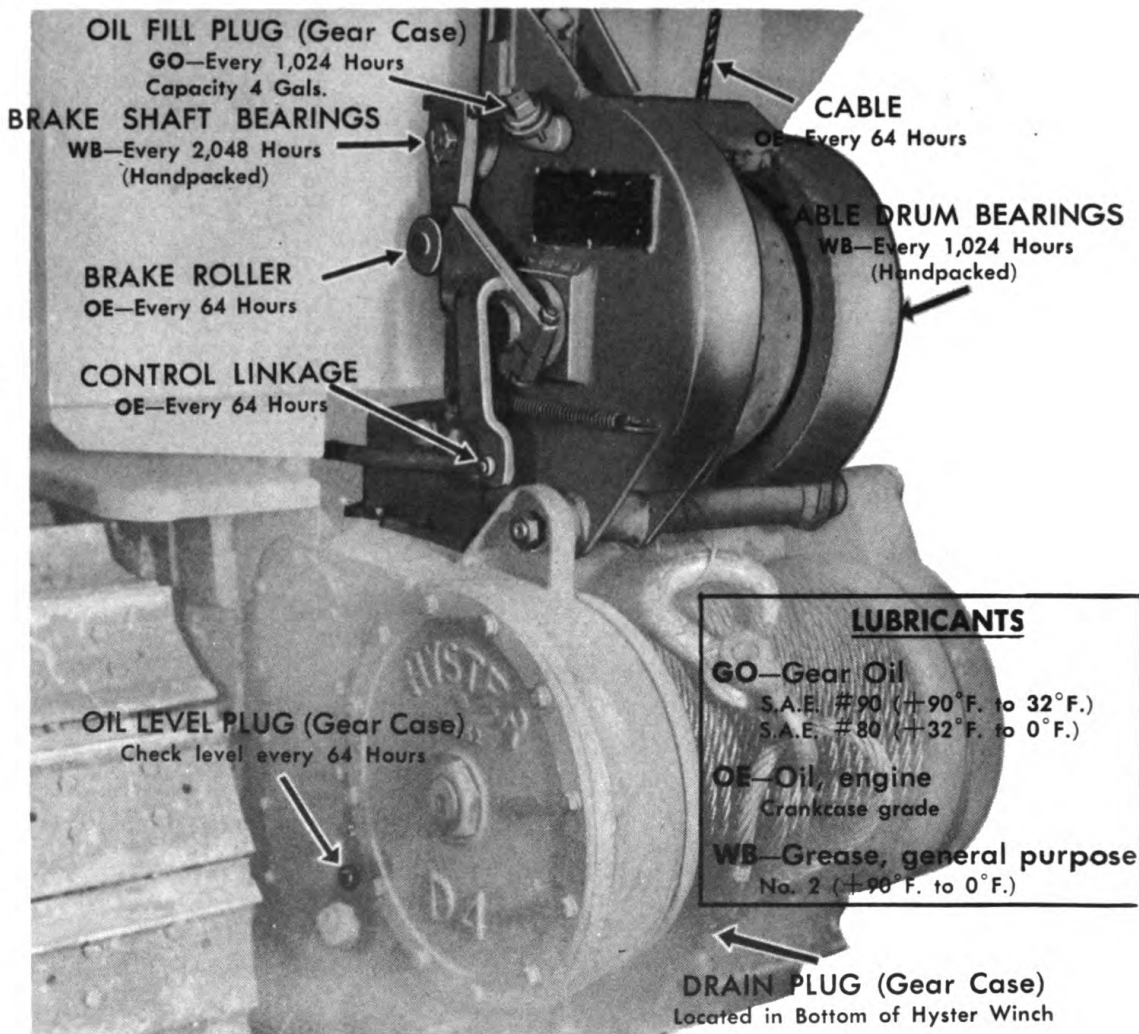

LUBRICATION

GEAR CASE

All gears, bearings, and working parts inside the Power Control Unit gear case receive lubrication by the "splash" system from the oil in the lower part of the Hyster winch. The oil is carried up into the gear case by the gears, and the constant spray of oil resulting therefrom provides ample lubrication.

The oil should be kept up to the oil level plug (see illustration) at all times. Check oil level every 64 hours of operation.

Drain, flush, and refill up to oil level plug every 1024 hours of operation. Use GO oil, S.A.E. #90 in temperatures from +90°F. to +32°F., and S.A.E. #80 in temperatures from +32°F. to 0°F. (For recommendations in temperatures above +90°F., refer to Corps of Engineers High Temperature Bulletin. In temperatures below 0°F., refer to Cold Weather Bulletin.)

CABLE DRUM BEARINGS

Hand-pack cable drum bearings with recommended lubricant every 1024 hours of operation or when disassembled.

Use WB #2 grease in temperatures between +90°F. and 0°F. (For recommendations in temperatures above +90°F., refer to Corps of Engineers High Temperature Bulletin. In temperatures below 0°F., refer to Cold Weather Bulletin.)

Before hand-packing, remove old grease and wash grease chamber and bearings with kerosene or gasoline. Then apply lubricating oil to the bearings.

With the drum shaft removed from cable drum and bearing cones installed on shaft, apply grease to bearing cones, packing it in around rollers and on ends of rollers. With bearing cup installed in right end of cable drum, insert drum shaft into position in drum and then pack drum only 2/3 full of recommended grease, tilting and revolving shaft in drum to provide opening through which to insert grease. Then install remaining bearing cup, and re-assemble cable drum assembly.

For emergency lubrication, a drilled grease duct is provided in the drum shaft, extending from the rear of the shaft to the grease chamber inside of the cable drum. In event an excessive amount of grease is lost around the cable drum oil seals and for some reason it is impractical to disassemble the unit until after a few more hours of operation have been completed, the bearings may be temporarily supplied with lubricant by removing the brass plug from the rear of the drum shaft and inserting a grease fitting in its place. Then inject enough grease through the grease fitting to replace that which was lost around the seals, using a conventional pressure grease gun.

As soon as possible thereafter, the cable drum assembly should be removed and disassembled to replace the leaky oil seals and the drum should again be hand packed 2/3 full of recommended lubricant.

BRAKE SHAFT BEARINGS

Hand-pack brake shaft bearings with recommended lubricant every 2048 hours of operation or when disassembled.

Use WB #2 grease in temperatures from +90°F. to 0°F. (For recommendations in temperatures above +90°F., refer to Corps of Engineers High Temperature Bulletin. In temperatures below 0°F., refer to Cold Weather Bulletin.)

BRAKE ROLLER AND CONTROL LINKAGE

Lubricate brake roller and control linkage with OE #10 or #30 every 64 hours of operation, using an oil can.

CABLE LUBRICATION

Lubricate cable with OE #10 or #30 when needed. (CAUTION: If the Unit is equipped with woven clutch and brake facings, do not apply lubricant to that portion of cable which leads onto cable drum, because of danger of oil getting onto clutch and brake, causing slippage.)

OPERATION UNDER DUSTY, MUDDY, LOW TEMPERATURE AND OTHER ABNORMAL CONDITIONS

Few special instructions are required for operating the Power Control Unit in dusty, muddy, low temperature or other abnormal conditions.

1. When operating in extreme dusty conditions, apply lubricant rather sparingly to the cable. The reason for this is that the particles of dust, when mixed with the lubricant on the cable, may become abrasive, acting similar to a cutting compound and damaging the cable.

2. When operating in extreme muddy conditions, try to keep the clutch, brake, brake spring, and cable drum free of mud. Remove all mud from Unit after completing a day's work.

3. In cold weather, always make sure the brake band is not frozen to drum before starting operation by moving control lever into lock-out position and tapping on brake band with hammer.

4. Use lighter weight lubricants when operating in cold temperatures than when operating in warm temperatures. (Refer to lubrication instructions on page 15 of Operation Section.)

PREPARATION FOR STORAGE

To prepare the Power Control Unit for storage, follow the instructions below:

1. Clean all mud, grease, oil and dirt from Power Control Unit.

2. Apply paint to any unpainted spots to prevent rust.

3. Close breather hole in oil fill plug with a small cork to prevent dirt from entering gear case.

4. If unit is dismantled from Hyster winch, apply a thin coat of grease to primary idler gear and lower gear housing and then place a guard over lower opening to protect gear and keep dirt out of Power Control Unit Case.

FOR EXPORT SHIPMENT

No special instructions are required for shipping the Power Control Unit export if the Power Control Unit is mounted on the tractor.

However, if the Power Control Unit is shipped un-mounted, the primary idler gear and lower gear housing should be coated with a thin coat of grease and the lower opening then covered with water-proof paper. The Power Control Unit should then be securely packed in a strong wooden box, lined with water-proof paper. The weight of the Unit should not rest on the primary idler gear.

REPAIR SECTION

SECT. 5

REPAIR AND MAINTENANCE

The LeTourneau Model HN Power Control Unit is a well designed, strongly built piece of equipment which, if properly serviced at the correct intervals, should give trouble-free operation.

CARE OF POWER CONTROL UNIT

Time spent on inspection and care of the Power Control Unit will be many times repaid in long life and trouble-free operation.

The Power Control Unit should be serviced as specified below at the intervals shown:

WHEN POWER CONTROL UNIT IS DELIVERED

Remove cork from breather hole in oil fill plug.

Check all points of adjustment and make any necessary corrections.

Check oil level in gear case of Hyster winch.

Check threading of cable on cable drum.

WHEN NEEDED

Make clutch adjustment.

ONCE EVERY 8 HOURS

Check brake adjustment.

ONCE EVERY 64 HOURS

Check gear case oil level.

Lubricate brake roller and control linkage.

ONCE EVERY 256 HOURS

Check cable drum bearings.

Check main gear bearings.

ONCE EVERY 1024 HOURS

Check brake shaft bearing adjustment.

Change oil in gear case.

Hand-pack cable drum bearings with grease.

ONCE EVERY 2048 HOURS

Hand-pack brake shaft bearings with grease.

LUBRICATION

For lubrication instructions, refer to page 14 of Operation Section.

ADJUSTMENTS

CLUTCH, BRAKE, AND BRAKE SHAFT BEARING ADJUSTMENTS

The clutch adjustment, brake adjustment, and brake shaft bearing adjustment are of a type which can be made by the operator. For instructions, refer to pages 8 through 13 of the Operation Section.

CABLE DRUM BEARING AND MAIN GEAR BEARING ADJUSTMENTS

The cable drum bearing adjustment and the main gear bearing adjustment are of a type which would not normally be made by the operator.

Complete instructions as to how to check and make these adjustments will be found on the following pages.

CABLE DRUM BEARING ADJUSTMENT

Occasional adjusting of the cable drum bearings is necessary because of bearing wear.

Check the cable drum bearing adjustment every 256 hours of operation.



HOW TO CHECK ADJUSTMENT

To check the adjustment, insert a pry bar between the drum shaft support plate and cable drum, and firmly engage and disengage the clutch while prying against cable drum with the bar. If the drum bearings are loose, the cable drum will move back and forth on the drum shaft and the end of the pry bar will also move. The "feel" of this movement will be very noticeable to the one holding the end of the bar.

If movement is noticeable, the bearings are loose and an adjustment should be made.

For a more accurate check, clamp a dial indicator against cable drum, and repeat above operation, noticing end movement as recorded on indicator.

IF BEARINGS ARE LOOSE

If the unit should be operated with the bearings in a loose adjustment, the cable drum and clutch driven cone will assume an off-center position on the drum shaft, and will be in misalignment with the clutch driving cone, as shown in the drawing, thus causing spongy, erratic clutch action. With loose bearings, the driven cone may move to the right or to the left with the driving cone as the control lever is moved, thereby preventing proper releasing of the clutch, and causing the throw of the

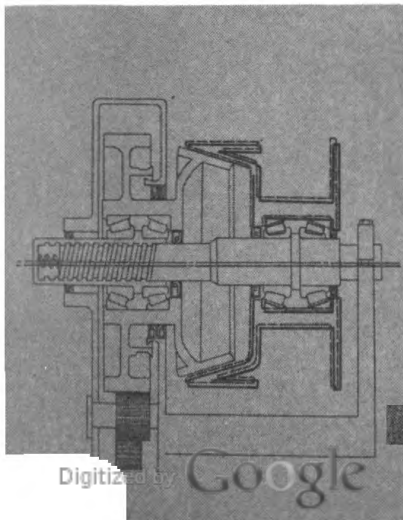

control lever to be increased, possibly resulting in the lever striking against the tractor seat. It may also cause the driven cone to drag on the driving cone when the control lever is in neutral position, resulting in over-heating of the clutch, which in turn may cause oil seal leakage, due to hardening of leather in seals. Also, loose cable drum bearings may result in cable breakage, due to a delay in quick clutch disengagement.

HOW TO MAKE ADJUSTMENT

To make cable drum bearing adjustment, first remove cable drum assembly from unit. (Refer to disassembly instructions on page 8 of the Repair Section.) Then proceed as follows:

1. With hammer and center punch, mark cable drum and driven cone at points illustrated in order to assure proper alignment when re-assembled.

2. Remove capscrews which secure driven cone to cable drum. Then slide driven cone off drum shaft, being careful not to damage oil seal.

3. Remove bearing adjusting shim (or shims) from between driven cone and cable drum to take up adjustment. (Shims are of two thicknesses, .004" and .007", in order to make possible a fine variation in adjustment.) Remove shims one at a time in making adjustment.

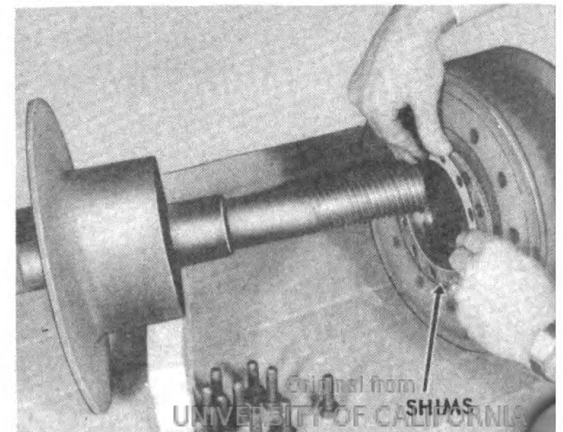
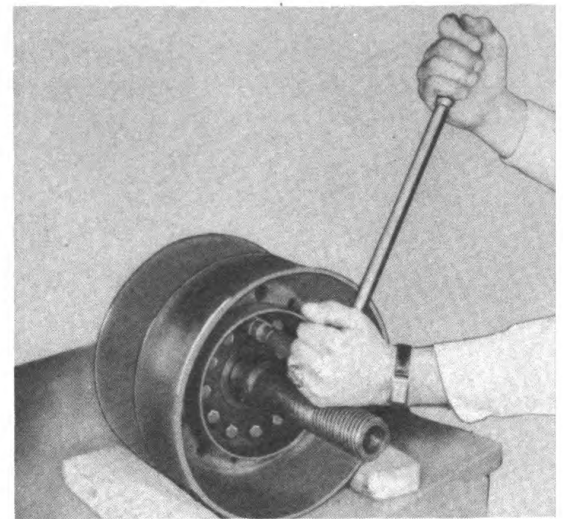
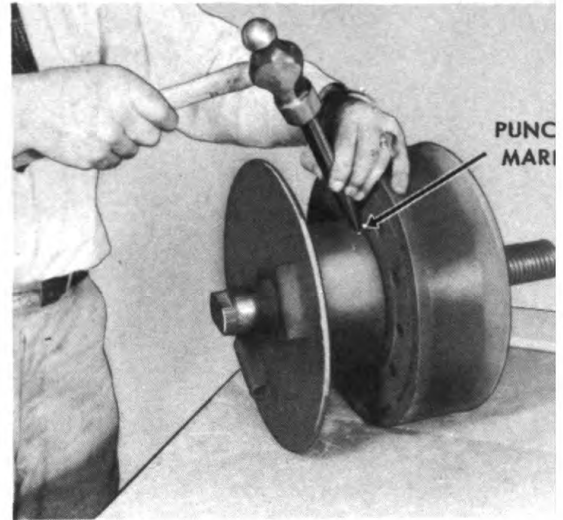
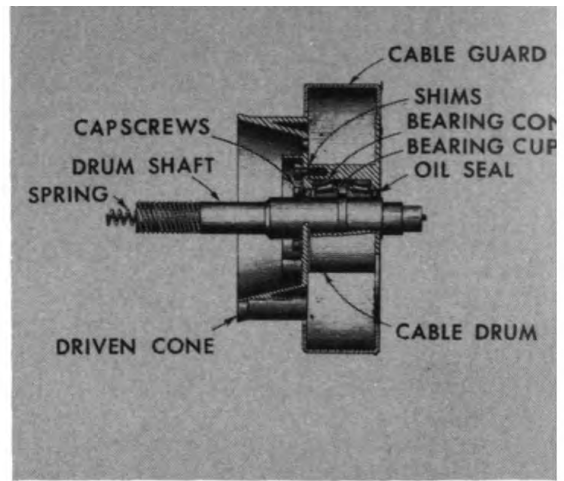

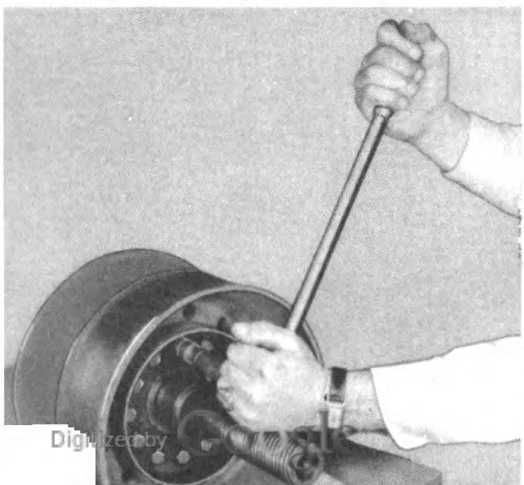
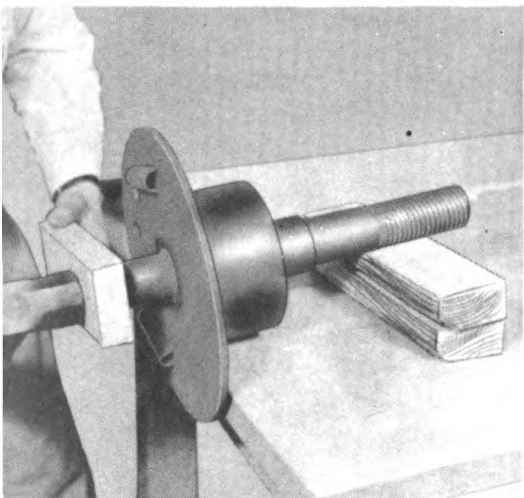
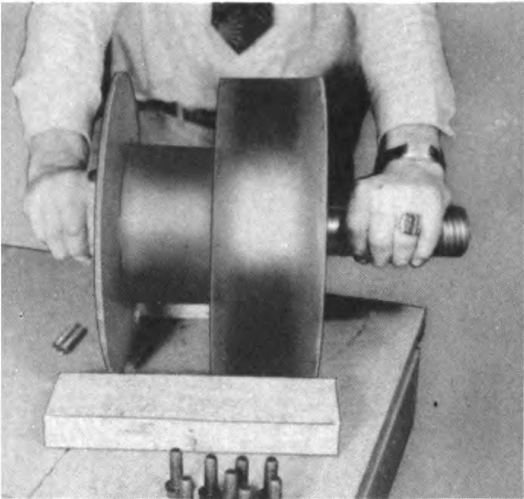
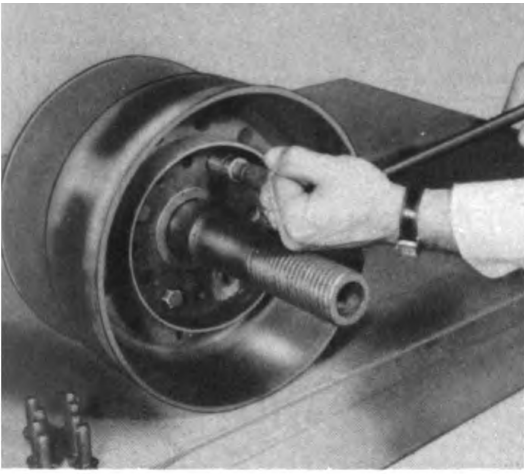

4. Reinstall driven cone on cable drum, lining up center punch marks on cone and drum. (This operation is done only to determine bearing tightness. Therefore, it is only necessary to install capscrews in every third cap-screw hole. Do not use lockwashers in this operation, due to damage to washers.) Turn capscrews up tight. If new oil seals are to be installed, leave them out until after the following test has been made.

5. Test adjustment by turning drum shaft in cable drum, using both hands. If adjustment is correct, there will be a definite drag on the drum shaft during this operation. Unless there is a noticeable drag on the drum shaft, the bearings are still loose and another shim must be removed.

Repeat the above operation until the correct adjustment is reached.

6. In event the bearings are drawn up so tight in the above operation that the drum shaft cannot be turned by hand, it will be necessary to again remove the driven cone and then drive against the short end of the drum shaft, using a wooden block and sledge, thereby freeing the bearings. Then add one .004" shim and repeat operations 4 and 5.

7. When correct adjustment is reached, install capscrews and lockwashers in driven cone, drawing them up tight. If oil seals have been omitted or if release spring has been removed from end of drum shaft, install them in place. Then re-install drum assembly in unit.

NOTE: The cable drum bearings should be hand-packed with lubricant whenever the drum assembly is disassembled. This should therefore be done when making the above adjustment. (Refer to page 15 of Operation Section.)

MAIN GEAR BEARING ADJUSTMENT

Occasional adjusting of the main gear bearings is necessary because of bearing wear.

Check the main gear bearing adjustment every 256 hours of operation.

HOW TO CHECK ADJUSTMENT

1. Fully engage clutch, using considerable force on control lever. With clutch engaged, wedge driving cone tightly into driven cone by driving two chisels or wedges between the cover plate and driving cone, on opposite sides of cone. Also disconnect control rod from actuator lever.

2. If dial indicator is available, clamp indicator to Unit with contact point bearing against end of throw-nut at center. Move actuator lever slowly out of fully engaged position, back toward neutral, using little force. In other words, take up only the free-travel of actuator lever. (Check to make sure driving cone is not moving in and out by placing finger between driving cone and cover plate, with which to feel any movement.) While moving actuator lever back and forth, check reading on indicator. If bearings are loose, throw-nut will move in and out and indicator will show within approximately .002" amount bearings are loose. (As much as .002" of movement may not be due to loose bearings.)

3. If dial indicator is not available, fully engage clutch and drive wedges behind cone as in step 1. Scribe a mark part way around clutch throw-nut with a sharp tool such as a knife. (Mark should be right up against throw-nut oil seal.) Then move actuator lever, as in step 2, while closely watching mark on throw-nut. If bearings are loose, throw-nut will move in and out and this movement will be visible to the eye when watching mark. The amount of movement determines extent to which bearings are loose.

If dial indicator shows an end movement of as much as .005" (step 2), or if there is visible end movement of mark (step 3) an adjustment should be made.

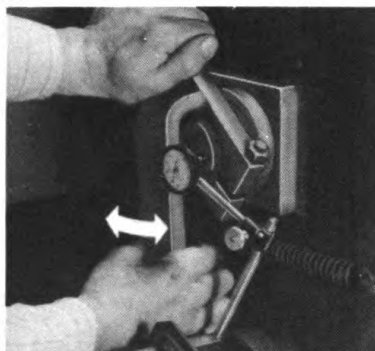

IF BEARINGS ARE LOOSE

If the Power Control Unit should be operated with the gear bearings in a loose adjustment, the driving cone may become misaligned with driven cone thus causing spongy, erratic clutch action. Also the driving cone may "hang up" in the driven cone when disengaging clutch, resulting in cable breakage. In addition the clutch cones may drag when in neutral position, resulting in overheating of the unit. This in turn may cause oil seal failure.

HOW TO MAKE MAIN GEAR BEARING ADJUSTMENT

To make main gear bearing adjustment, first remove cable drum assembly from unit. (Refer to disassembly instructions on page 8 of Repair Section.) Then proceed as follows:

1. Remove actuator lever from clutch throw-nut.

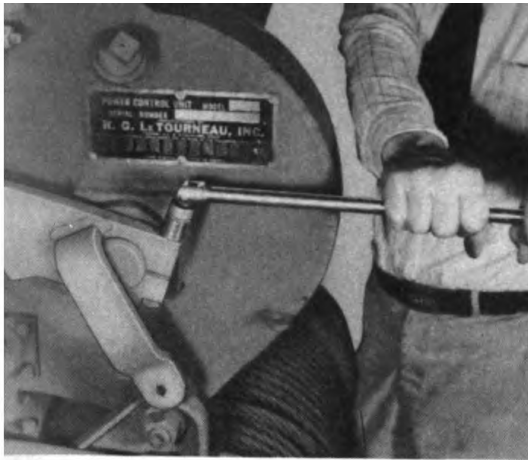

2. Turn clutch throw-nut by hand in order to feel amount of drag on throw-nut caused by oil seals. (If bearings are loose, the only drag on throw-nut should be from oil seals, and this should be very little.)

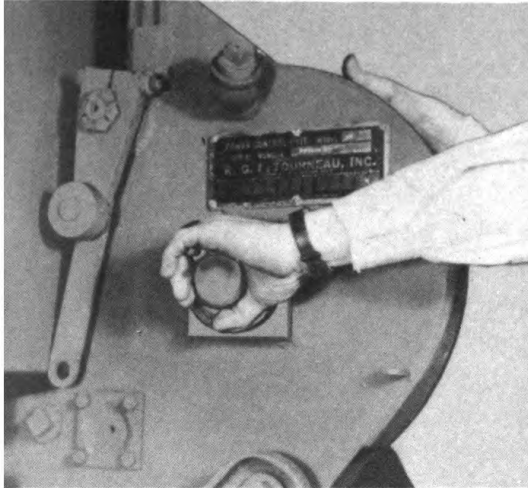

3. Remove capscrews which secure driving cone to hub of main gear. Then remove driving cone.

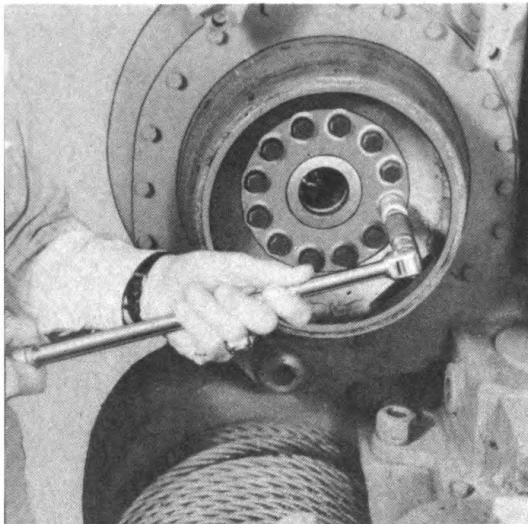

4. Remove bearing adjusting shim (or shims) from between driving cone and gear hub in order to take up adjustment. (Shims are of two thicknesses, .004" and .007", in order to make possible a fine variation in adjustment.) Remove shims one at a time when making adjustment.

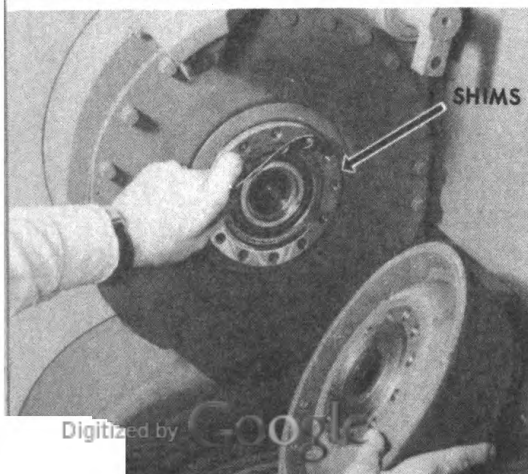

5. Reinstall driving cone on gear hub. (This operation is done only to determine bearing tightness. Therefore, it is only necessary to install capscrews in every third capscrew hole. Do not use lockwashers in this operation, due to damage to washers.) Turn capscrews up tight.



6. Check bearing tightness by turning throw-nut by hand. The bearings are correctly adjusted when all end play of the throw-nut in the gear hub has been eliminated, without heavy drag on the throw-nut. (The drag may be slightly more than in step 2, but should not be great enough to prevent throw nut from being turned with one hand.)

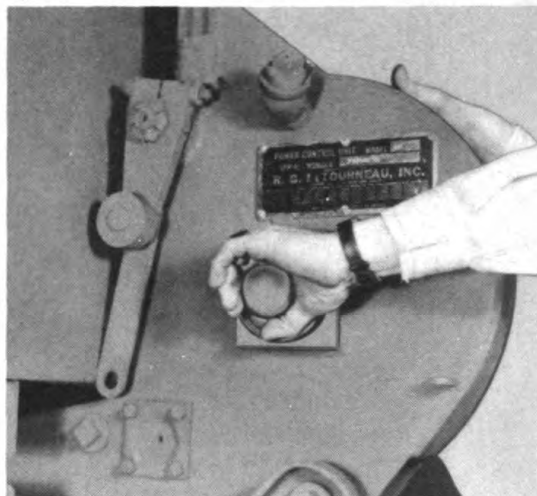

7. In event the bearings are drawn up so tight in the above operation that there is a heavy drag on throw-nut, it will be necessary to again remove the driving cone, and then drive against throw-nut, using wooden block and sledge, thereby freeing bearings. Then add one .004" shim and repeat operations 5 and 6.

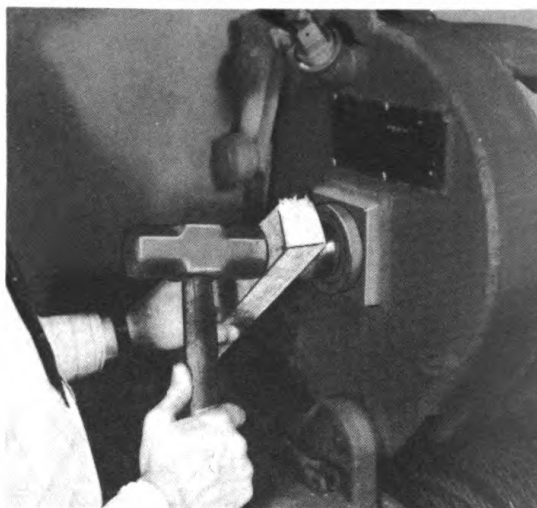

8. When correct adjustment is reached, install capscrews and lockwashers in driving cone, drawing them up tight. Examine oil seal in hub of driving cone and replace if necessary. Then reinstall drum assembly and drum shaft support plate.

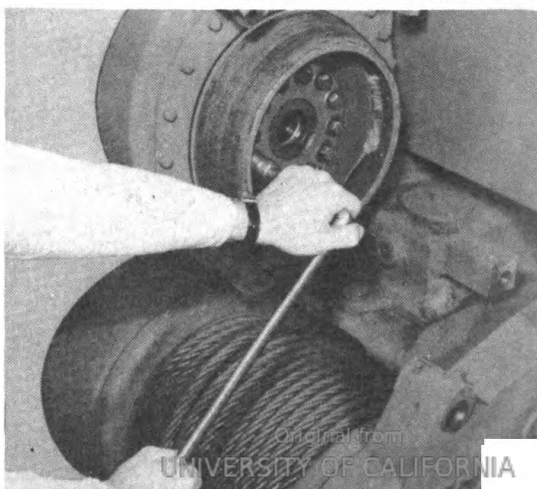

DISASSEMBLING

When disassembling a Power Control Unit to replace a worn part, install new clutch or brake facings, remove bearing adjusting shims, etc., the length of time that is consumed is quite often an important matter, especially if the disassembly results in other equipment being shut down during that period. Therefore the instructions which follow explain the quickest and easiest method of correctly removing and disassembling each assembly or group of related parts.

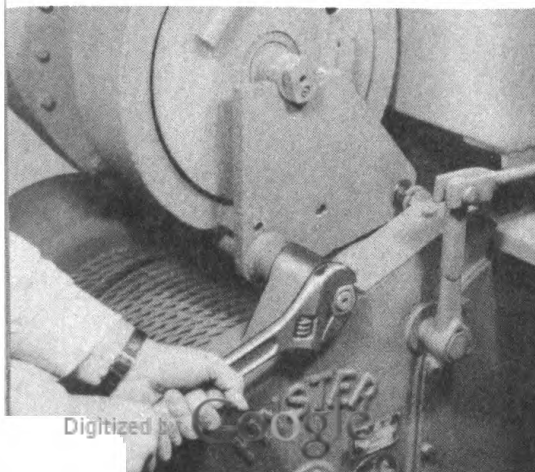
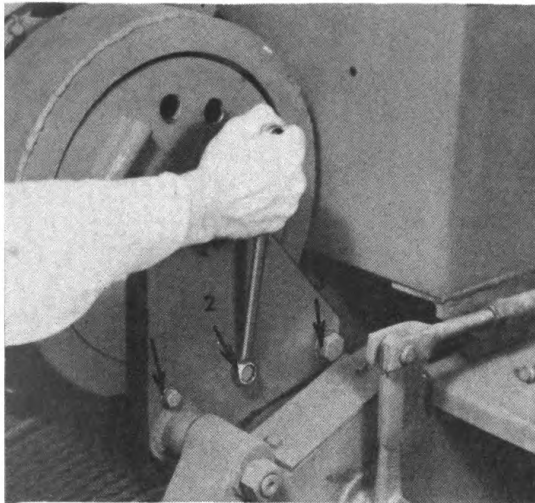
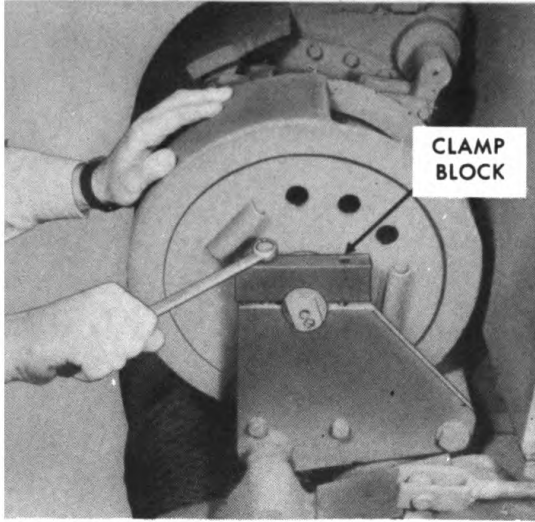

REMOVING CABLE DRUM ASSEMBLY

The cable drum assembly can be removed without removing the Power Control Unit from the tractor. To remove the assembly, first remove cable from the cable drum. Then proceed as follows:

1. Remove clamp block cap screws and then remove clamp block from end of drum shaft.

2. Remove cable guard cap screws (1) and (2) and then back out cap screw (3) as far as it will go.

3. Remove hex nut from end of tie rod which extends through top of Hyster Winch and bottom of Power Control Unit.

REPAIR

4. Remove tie rod by driving it out through side of unit.

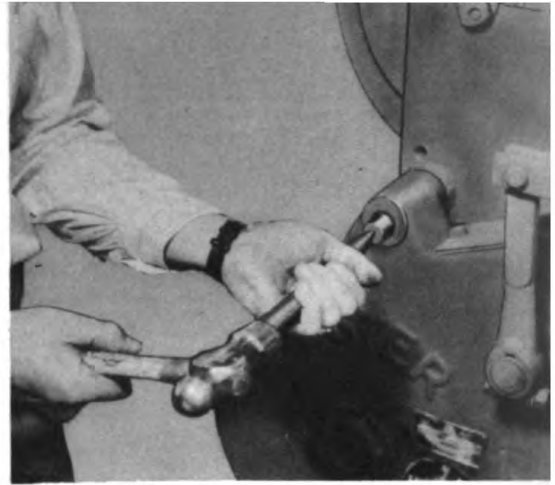

5. Remove drum shaft support plate by sliding it to the rear, away from the unit. (It may be necessary to slightly raise end of drum shaft during this operation.)

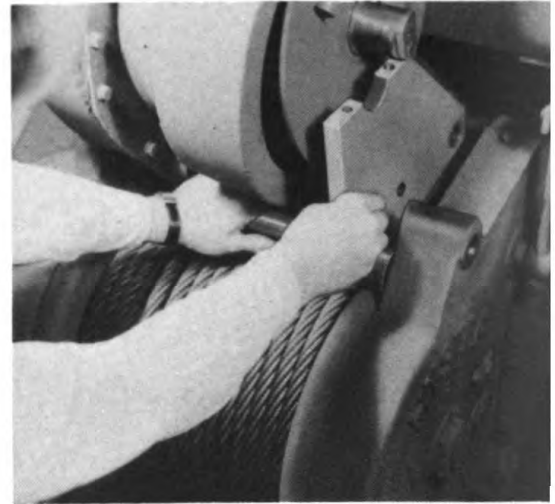

6. Remove cable guard, sliding it off over cable drum. Also remove brake band. (Refer to instructions for removal of brake band on page 16 of Repair Section.)

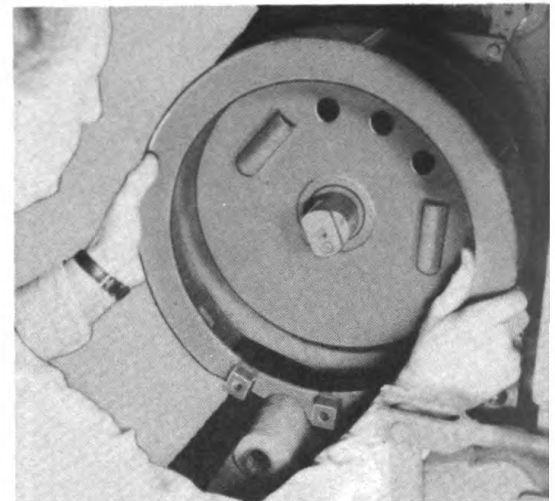

7. Remove cable drum assembly by turning drum shaft out of clutch throw-nut, turning it counter-clockwise with a wrench. In this operation, it is necessary to support the cable drum in order to prevent damaging the oil seal in the hub of the driving cone as the drum shaft passes through the seal.

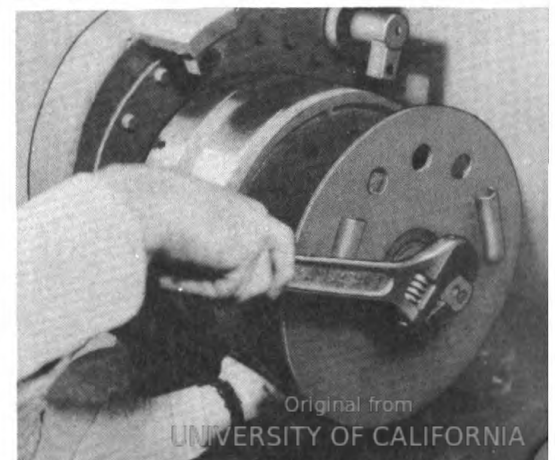

DISASSEMBLING CABLE DRUM ASSEMBLY

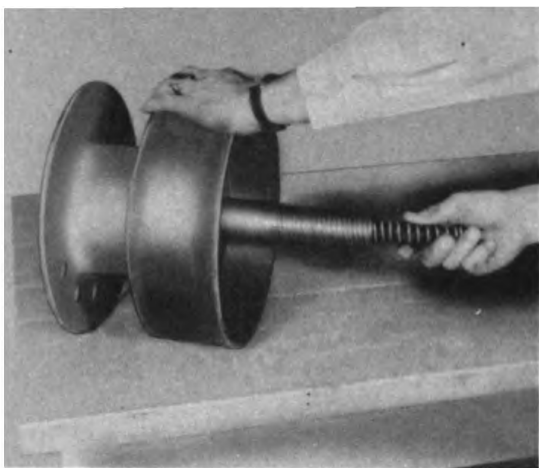

1. If spring at end of drum shaft is to be removed, pull it out of end of shaft.

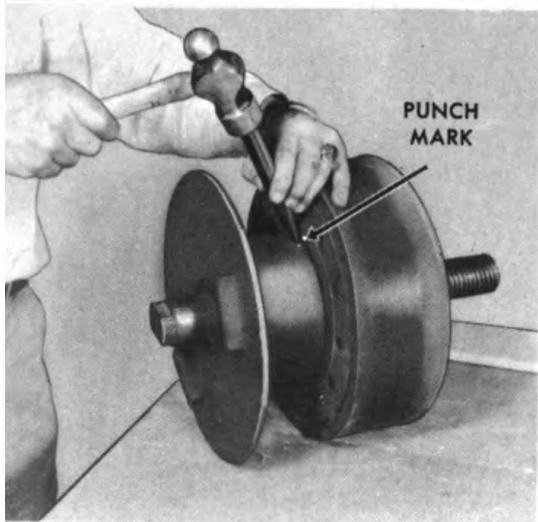

2. With hammer and center punch, mark cable drum and driven cone at the points shown. This is done in order to assure proper alignment when reassembled.

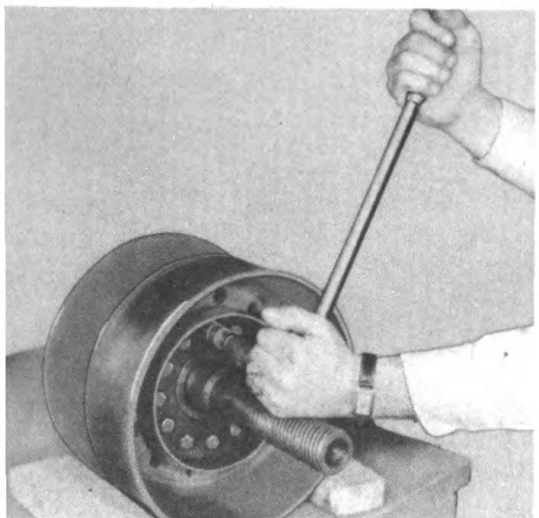

3. Remove capscrews which secure driven cone to cable drum. Then slide driven cone off over end of drum shaft, being careful not to damage hub oil seal.

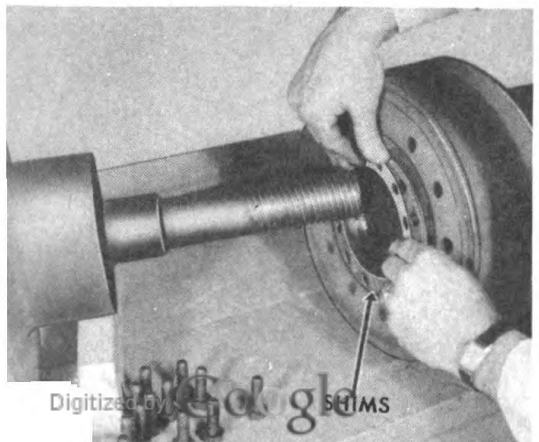

4. Remove bearing adjusting shims from between cable drum and driven cone. To avoid loss of shims, wire them together.

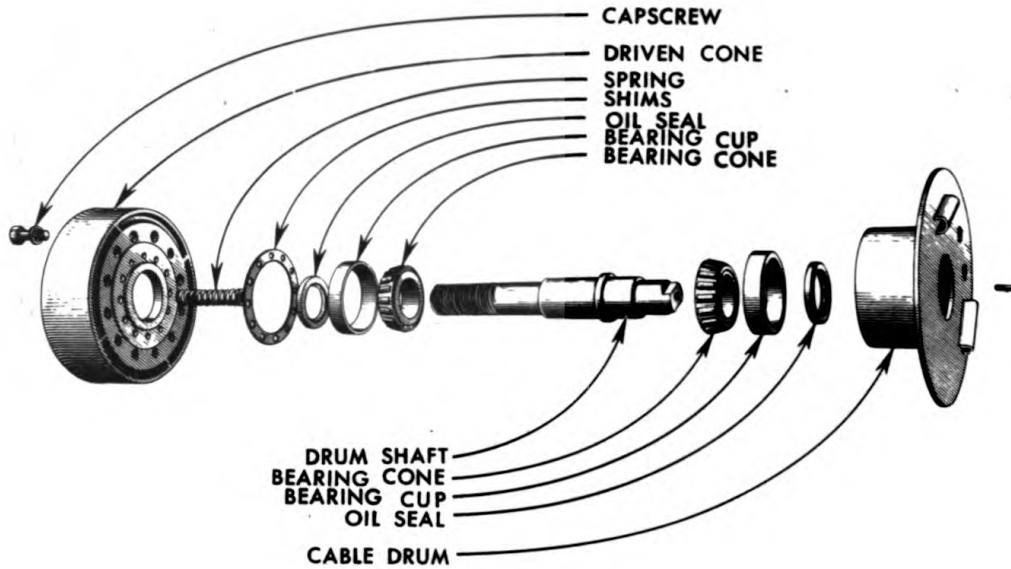

5. Remove drum shaft from cable drum by driving against short end of shaft, using a wood block and sledge. The bearing cup at opposite end of cable drum will be removed during this operation.

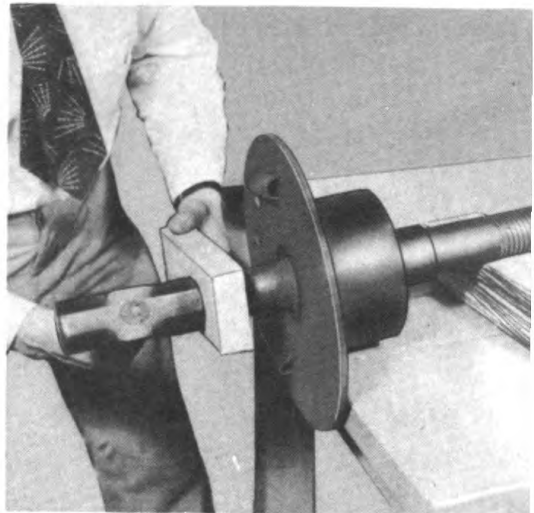

6. If bearing cones are to be replaced, drive or pull them off drum shaft. Also, the cable drum oil seal and the remaining bearing cup can be removed from the cable drum.

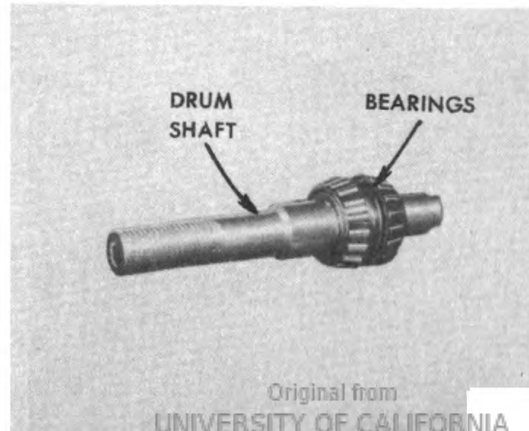

REMOVING MAIN GEAR AND DRIVING CONE ASSEMBLY

The main gear and driving cone assembly can be removed without removing the Power Control Unit from the tractor.

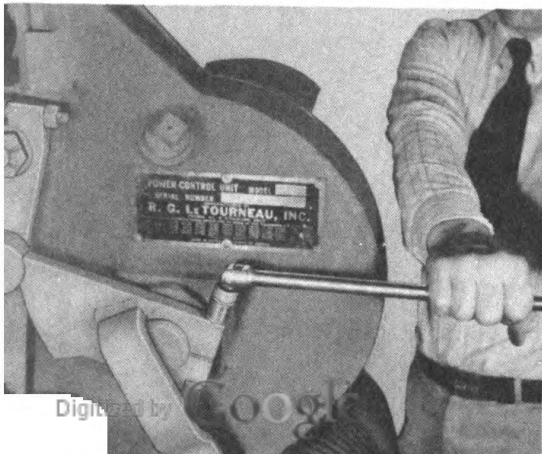
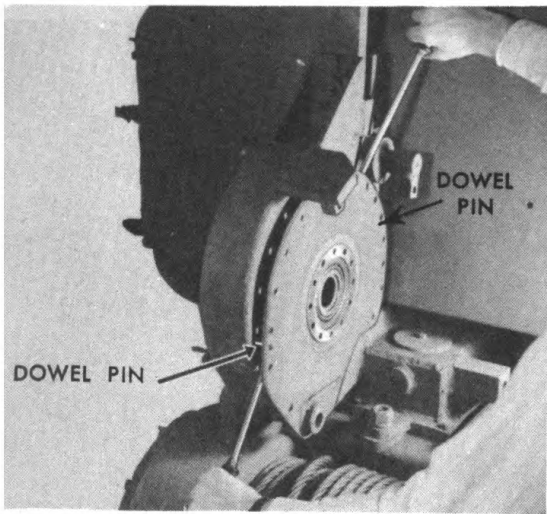
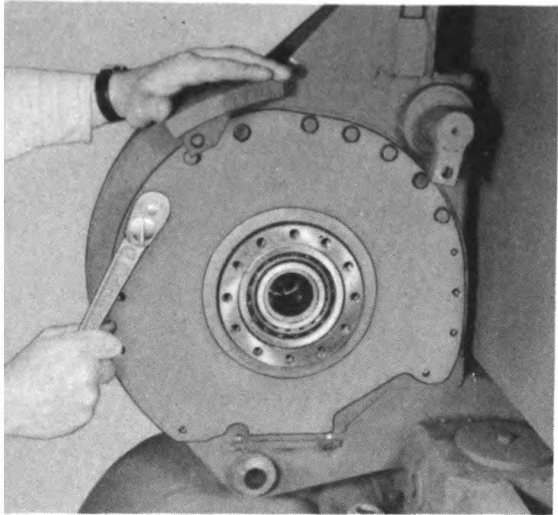

1. First remove cable drum assembly, as outlined in preceding instructions. Then remove driving cone by removing capscrews which secure it to hub of main gear. Remove bearing adjusting shims from back side of driving cone. (To avoid loss of shims, wire them together.) If driving cone oil seal is to be replaced, remove it from hub of driving cone.

2. To remove main gear, gear bearings, or clutch throw-nut, proceed by removing capscrews which secure cover plate to gear case.

3. Insert two screw drivers or similar tools behind opposite sides of cover plate and pry cover plate away from gear case as illustrated. Care should be used to pry cover plate off evenly in order to avoid damaging the two dowel pins and oil seal. Remove oil seal from cover plate if it is to be replaced.

4. Remove clamp bolt from actuator lever and remove actuator lever from clutch throw-nut. (For convenience, the brake spring should be released before removing the actuator lever.)

REMOVING CLUTCH THROW-NUT BEARING, OIL SEAL AND BUSHING

The clutch throw-nut bearing, oil seal, and bushing can be removed without the Power Control Unit removed from tractor.

1. To remove clutch throw-nut bearing and oil seal, first remove throw-nut and main gear as outlined in previous instructions. Then drive bearing out of bushing from inside of gear case, using a hammer and wood block. The oil seal will be forced out of bushing ahead of bearing.

2. The clutch throw-nut bushing is pressed tightly into the gear case and very seldom requires replacing. However, if the inner bearing surface should become worn to the point that replacement is necessary, the bushing can be driven out of the gear case by using a steel punch and hammer.

REMOVING SECONDARY IDLER GEAR AND PIN

The secondary idler gear and pin can be removed without removing Power Control Unit from tractor.

1. First remove main gear as outlined in previous instructions. Then remove capscrews from flange on end of idler pin.

2. Pull idler pin out of gear case from left side, using small pry bar if necessary. Then lift idler gear out of gear case. If bushing is to be replaced, press it out of gear.

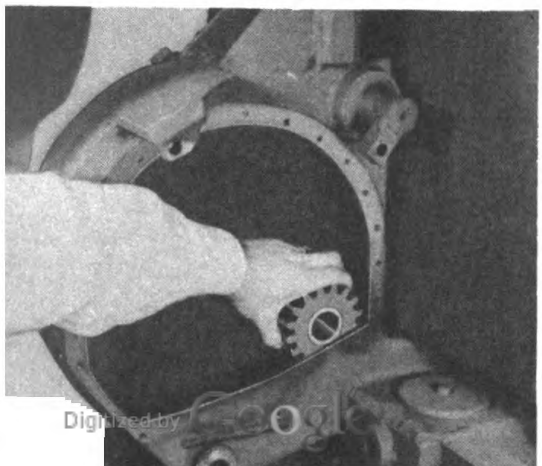
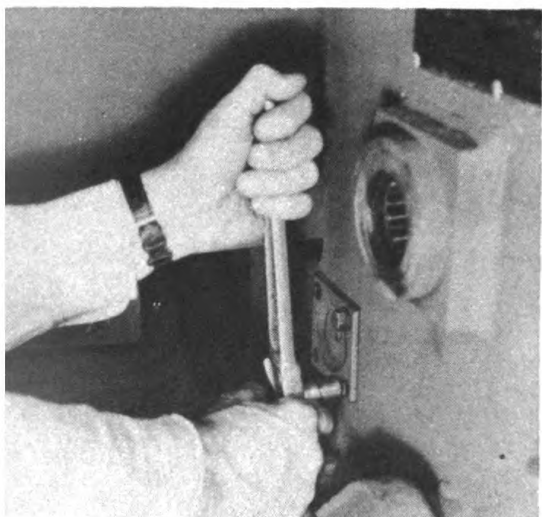
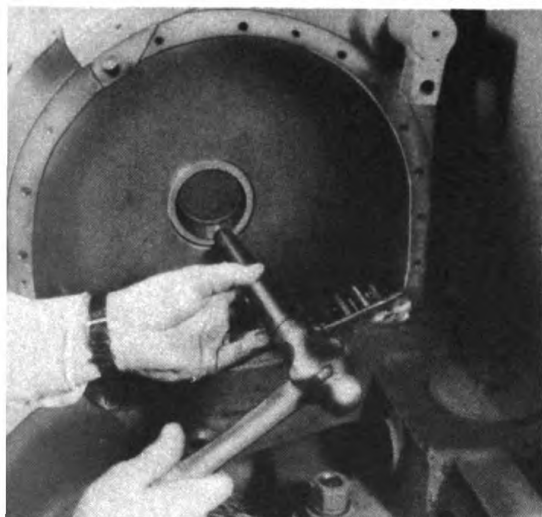
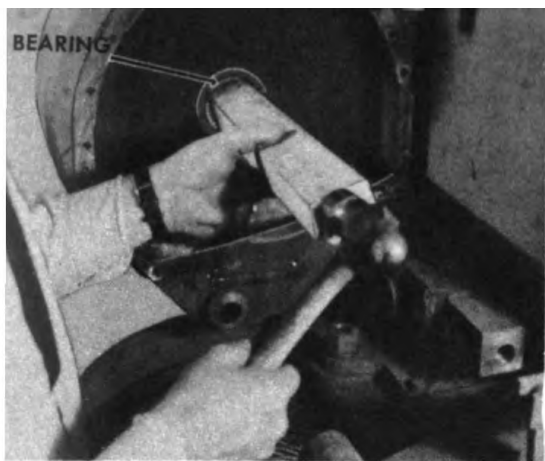

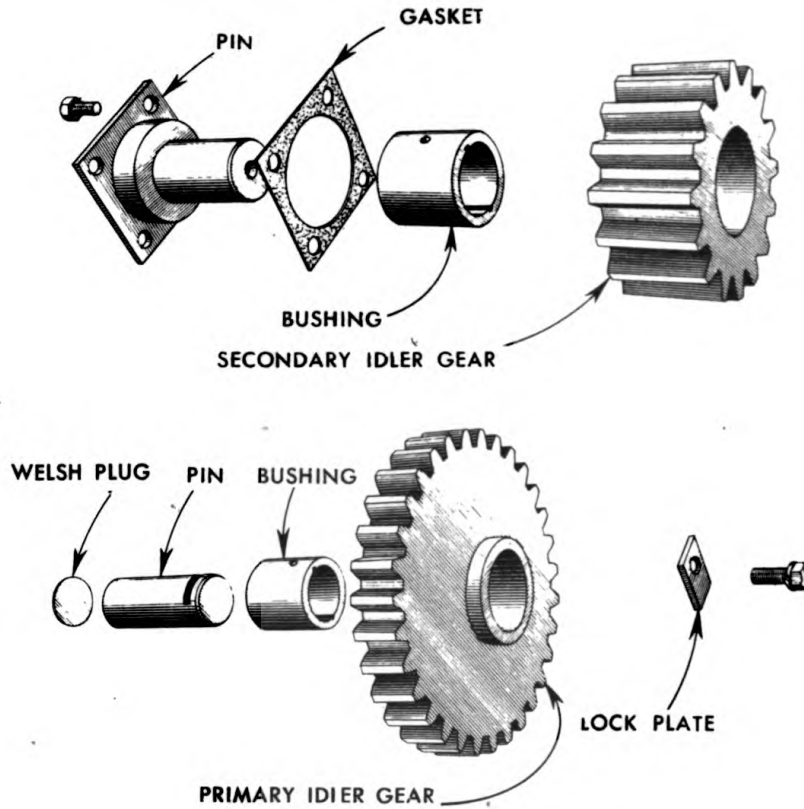

REMOVING PRIMARY IDLER GEAR AND PIN

Before primary idler gear can be removed, the Power Control Unit must first be removed from Hyster Winch on rear of tractor. (Refer to instructions on page 18 of Repair Section.)

1. Remove small lock plate from end of pin by backing out capscrew as illustrated.

2. Then drive out pin and remove gear. The welsh plug at end of pin will be driven out ahead of pin.

If bushing is to be replaced, press it out of gear.

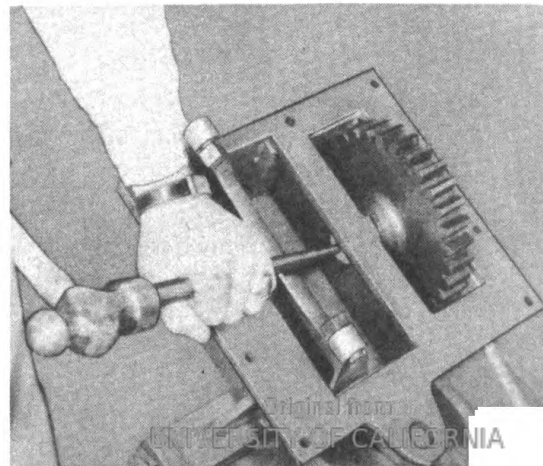
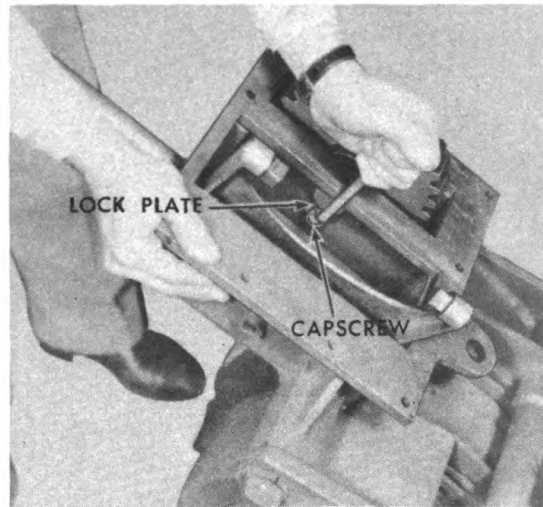

REMOVING BRAKE ASSEMBLY

All parts of the brake assembly can be removed without removing the Power Control Unit from tractor.

1. Before removing any part of the brake assembly, it is usually advisable to first release brake spring from lug on side of gear case.

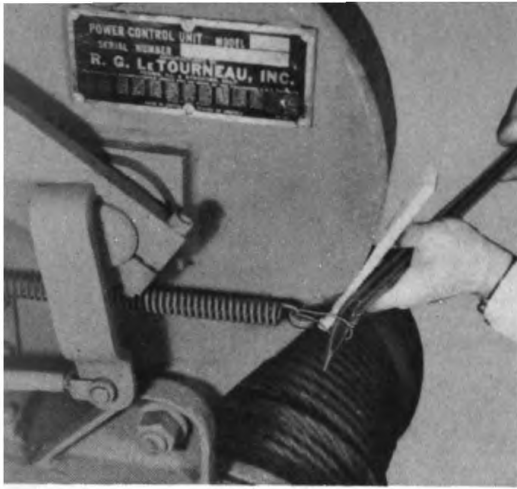

2. To remove brake band, first remove cable guard (refer to disassembly instructions on page 9 of repair section.) Then remove link pins (1) and (2) leaving brake links connected to brake band.

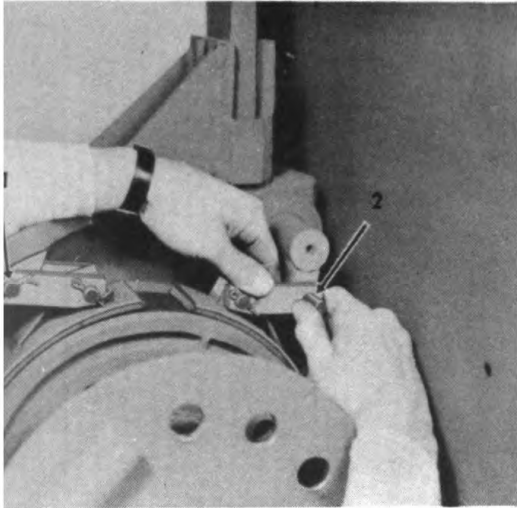

3. Slide brake band off over cable drum.

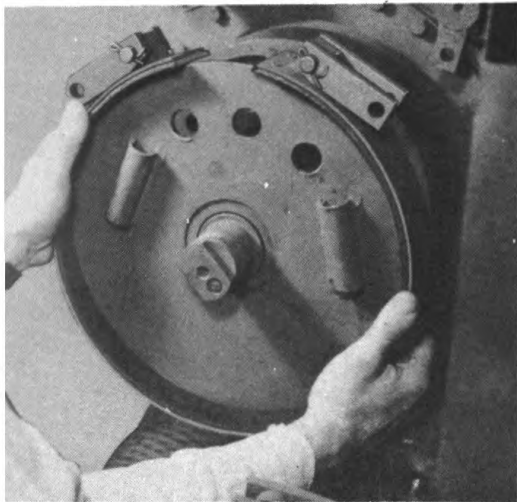

4. To remove brake roller arm, remove cotter pin from end of brake shaft. Then turn castellated nut off end of shaft.



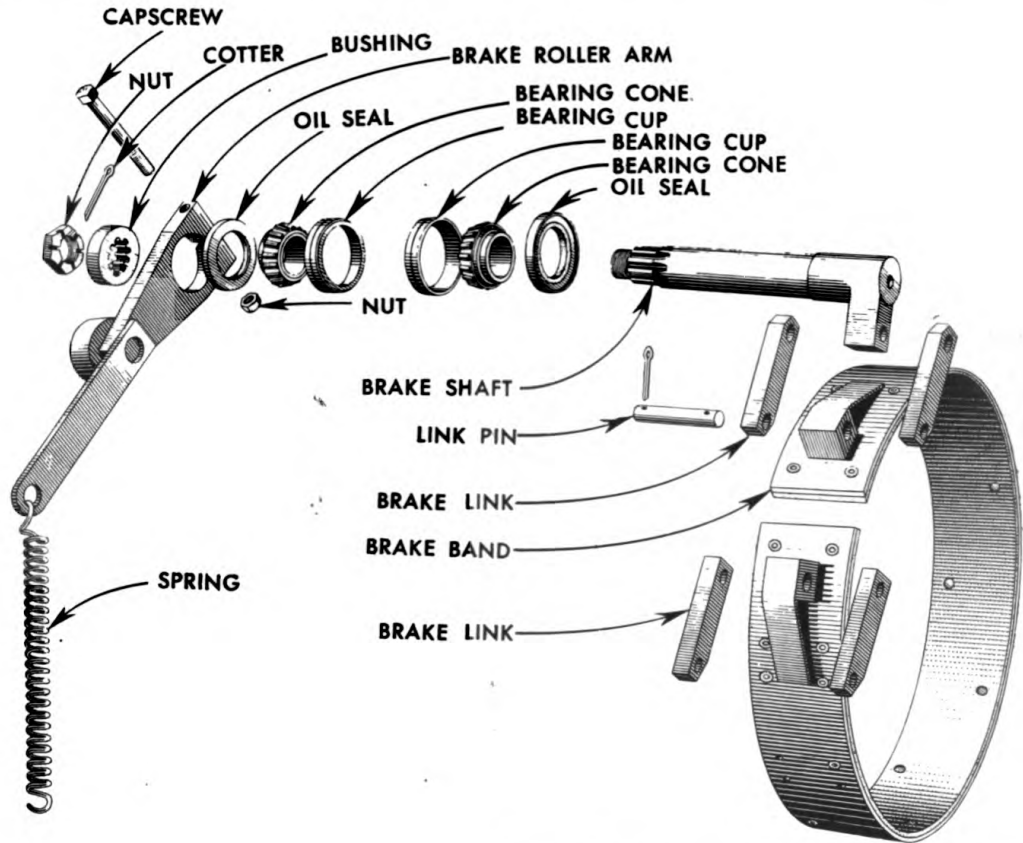

5. Remove brake roller arm off end of brake shaft, using pry bar if necessary. If splined bushing is to be removed from roller arm, loosen clamp bolt at upper end of roller arm and drive out bushing.

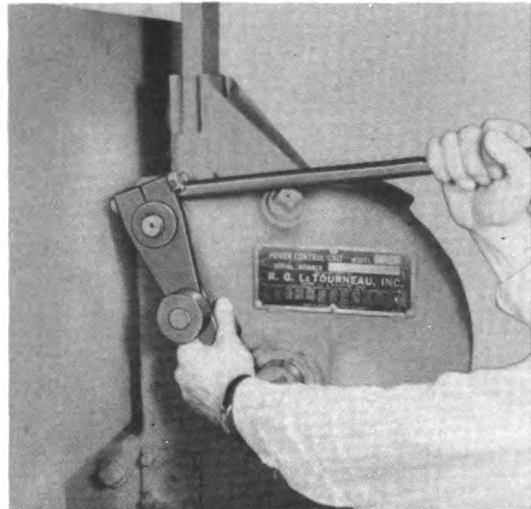

6. If brake shaft is to be removed, drive it out of gear case, using wood block and hammer. The right bearing cone and oil seal can then be removed from shaft and the left bearing cone and oil seal from housing. If bearing cups are to be removed, pull them out of housing.



REMOVING POWER CONTROL UNIT AND DISASSEMBLING HYSTER SHIFTER FORK

1. To remove the Power Control Unit from the Hyster Winch, first remove cable from cable drum. Then drive out link-bar pin and lower the front of 'Dozer A-Frame onto wood block on tractor hood. (Refer to 'Dozer Manual.)

2. Remove pin (1) from Hyster brake control linkage. Then remove seat from tractor, leaving Hyster tie plates attached to seat. Also leave Hyster brake lever attached to tie plates.

3. Remove tie rod (2) which extends through bottom of Power Control Unit and top of Hyster Winch. Also remove anchor bolt (3).

4. Remove pin (4) from control linkage. Then remove lever brackets (5) and (6) from tractor and remove levers, linkage, and brackets as one unit. Also remove Hyster shifter lever (7) and bracket (8) from end of shifter shaft. (IMPORTANT—If spacers are used under bracket (8), wire them to bracket to assure use when re-installing.)

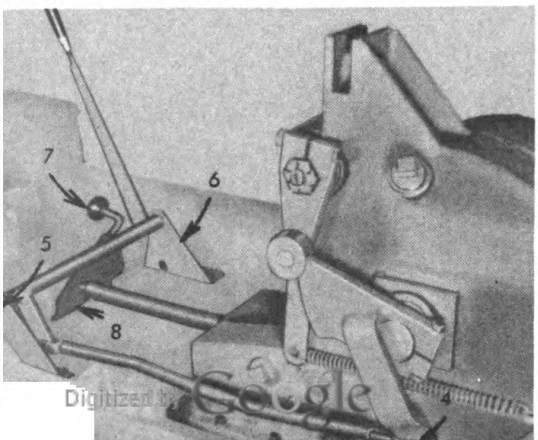
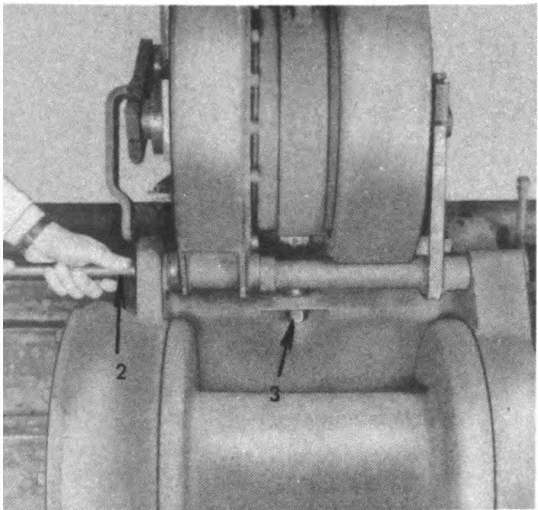
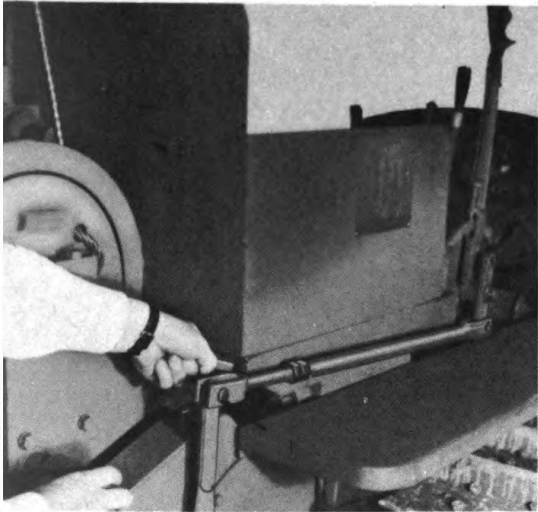
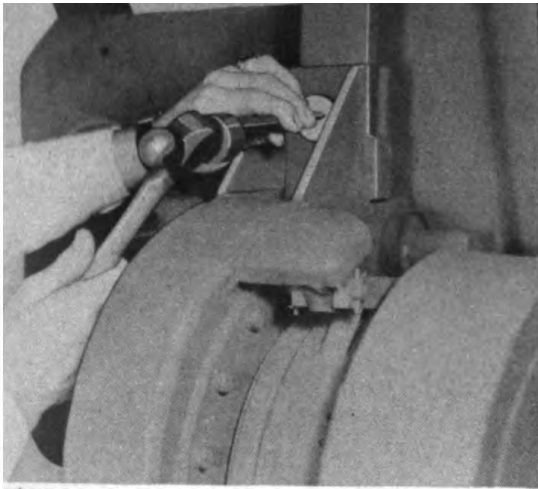

5. Connect hoist or Crane to Power Control Unit, with which to lift unit off Hyster Winch after removal of mounting bolts. Then remove mounting bolts.

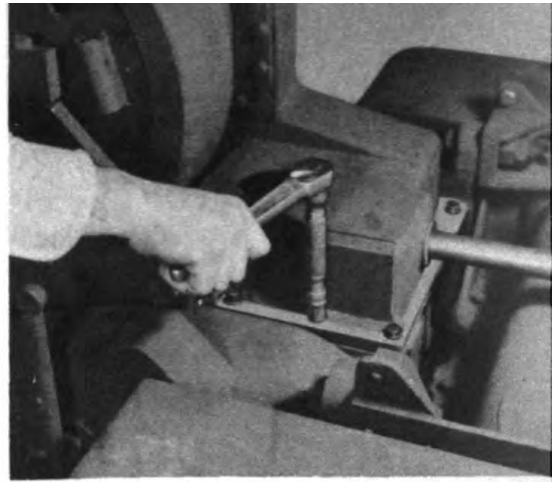

6. Hoist power control unit off Hyster Winch, raising it straight up until shifter fork in bottom of Unit has been raised free of Hyster sliding gear. Then lower Unit to bench or floor. (CAUTION—Some units having serial numbers P-31267 HN and below were shipped from the factory with metal washers installed in cap-screw holes in gasket. Do not shift gasket and permit these washers to fall in Hyster gear case when removing.) Keep exposed gears, etc., in bottom of power control unit free of dirt, grit, etc. Also, cover opening in top of Hyster gear case.



7. If the Hyster shifter fork or shaft is to be removed from unit, turn unit upside down and remove wire from set screw (9). Then back out set screw.

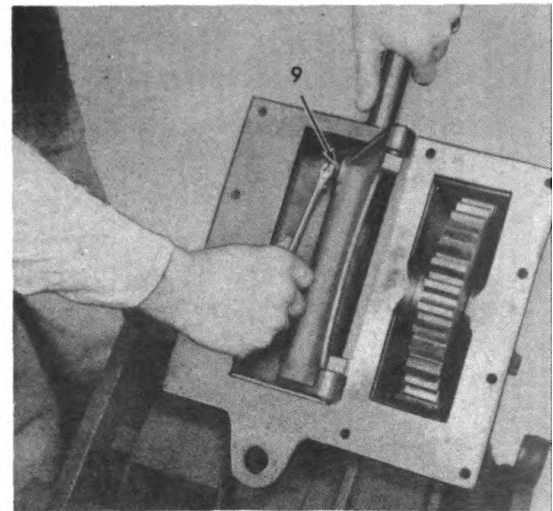

8. Pull shifter shaft (10) out of shifter fork (11). In doing this, remove keys from key-ways in shaft as it moves out of fork. (CAUTION:—Do not drop or hammer shifter fork.)

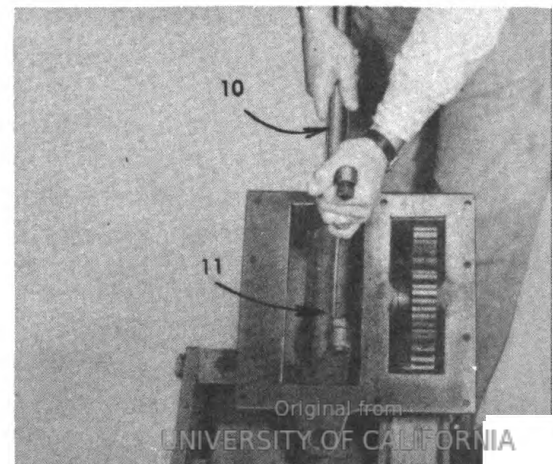

REASSEMBLY**INSPECTION OF PARTS**

Before re-assembling the Power Control Unit, the following inspection and care of parts should be made:

1. Carefully examine oil seals before re-installing. Replace any oil seals which do not appear to be in good condition.
2. Make new oil seals pliable by soaking in light weight oil and by running a round object, such as the shank of a screw-driver or hammer handle, around the inner circumference of the seal, thus working the leather.
3. Replace all working parts that are worn excessively.
4. Examine bearings before re-installing. Use none that may have become Brinelled, pitted, or excessively worn.
5. Replace bearing cups when replacing bearing cones, and vice-versa.
6. Replace bushings in idler gears if excessively worn.
7. Examine clutch and brake facings before re-installing driving cone or brake band. Wash oil soaked woven facings with gasoline or naphtha. Roughen woven facings that have become glazed with a rasp or wire brush. Make sure facings are tight on driving cone or brake band before re-installing. If a driving cone has been newly re-lined with metallic facing, the facing should be machined to a 15° taper to take off any high spots.
8. Replace brake spring if it has become stretched and lost its tension.
9. Keep all parts clean and free from foreign particles during assembly.

ASSEMBLING

The procedure for assembling the Power Control Unit is the reverse of that for disassembling the Unit. (Refer to Disassembling Instructions.)

If the primary idler gear or Hyster shifter fork has been removed from the Unit, these parts must be re-installed before the Unit can be installed on the Hyster winch. However, the remainder of the parts can be installed with the Unit either installed on or removed from the Hyster winch.

The parts can be assembled in the following order:

BRAKE ASSEMBLY

Install bearing cone and oil seal (same as 1 and 3) onto right end of brake shaft (7), if removed. Also press bearing cups (2) into left and right ends of housing. Then insert brake shaft (7) through housing from right side and install remaining bearing cone (1) and oil seal (3) over left end of brake shaft, up against the bearing cup. (NOTE:—During assembly, the brake shaft bearings should be handpacked and the

REPAIR SECTION

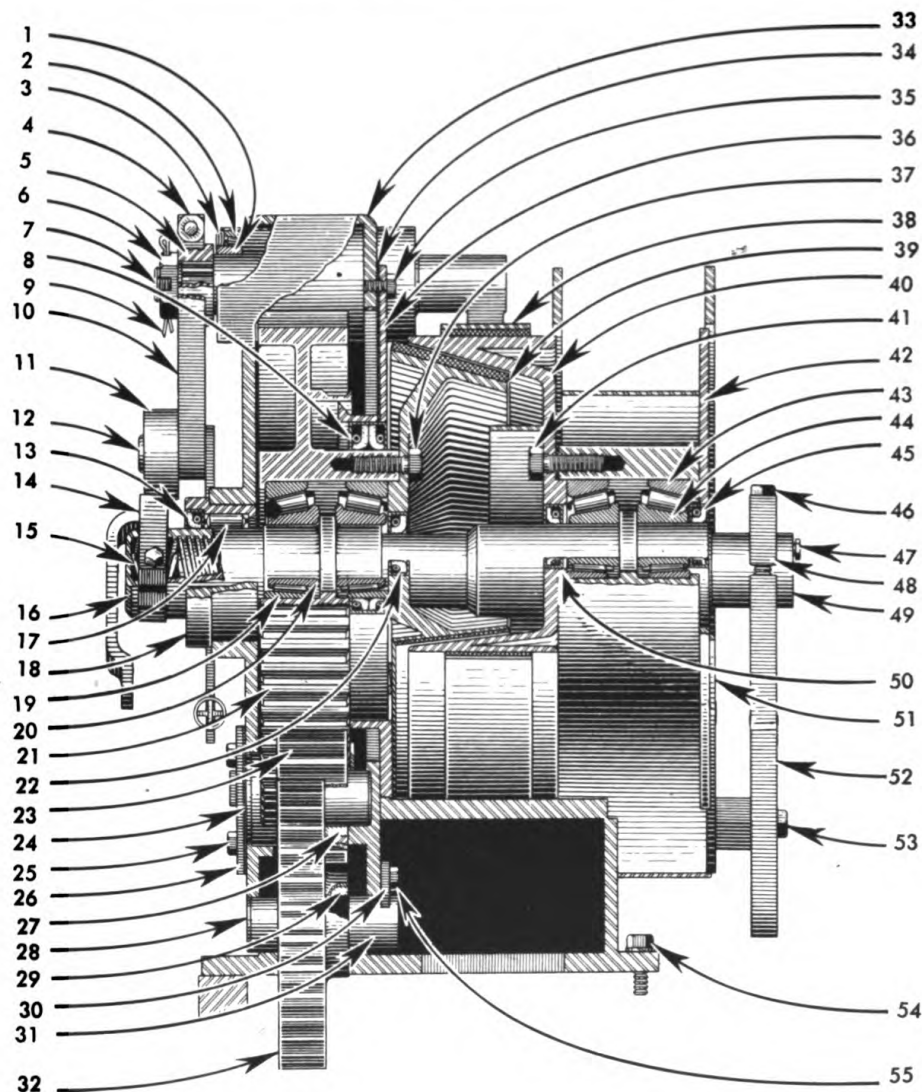

housing filled with WB #2 grease, as outlined in Lubrication Instructions on page 15 of the Operation Section.) Install splined bushing (5) in upper end of brake roller arm (10) and install and tighten clamp bolt and lockwasher (4) in upper end of roller arm. Install roller arm (10) on end of brake shaft (7) and then turn castellated nut (6) onto threads on end of shaft. Tighten nut (6) to the point where all end play of shaft is eliminated, but without drag on brake shaft bearings. Then install cotter pin (9) in end of shaft, thereby locking nut (6).

The brake band (38) is installed later during cable drum installation. Also, the brake spring is usually installed after the unit has been completely assembled.

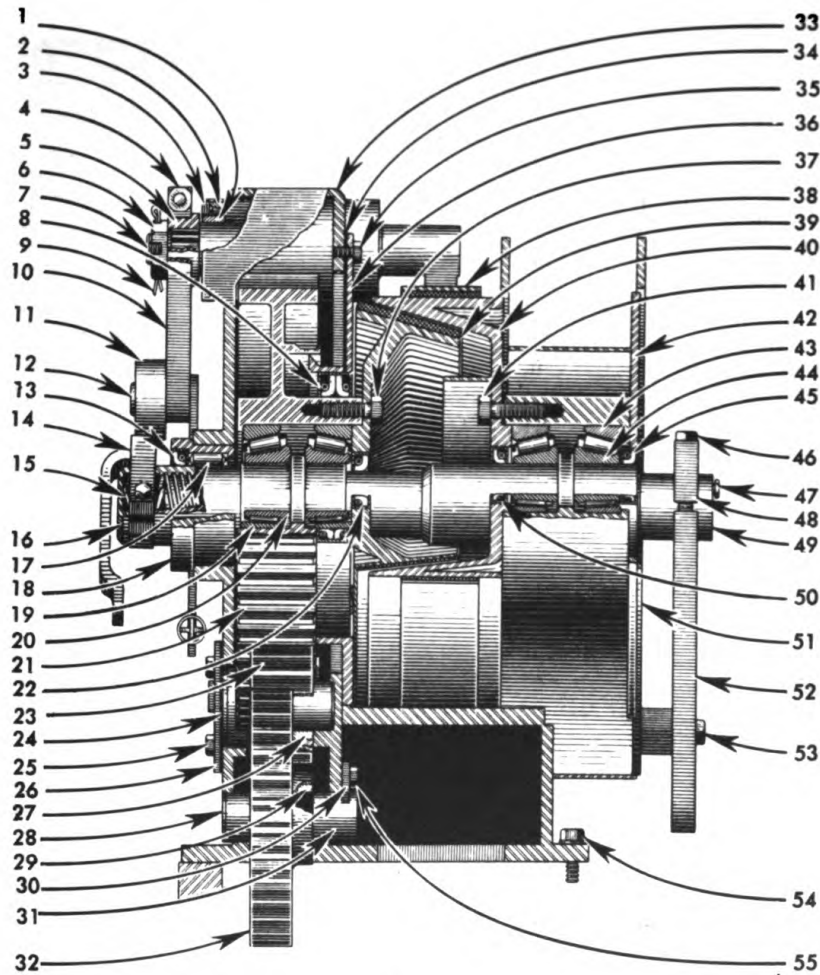

screws installed in their place. Use care when installing the driving cone on the gear hub, to avoid peeling off a burr which might become deposited between the gear hub and cone and thereby cause misalignment.

CABLE DRUM ASSEMBLY

Press bearing cone (44) onto drum shaft (49), if removed. Also press bearing cup (43) into right end of cable drum (42).

Install oil seal (45) in right end of cable drum with leather cupped inward. Insert drum shaft (49) into cable drum from left side of drum and then install remaining bearing cup (43) in cable drum from left side, not installing it tight against bearing cone until later. (Avoid damaging or reversing leather in oil seal (45) when inserting shaft into cable drum.) Install oil seal (50) in hub of driven cone (40) with leather cupped toward right side of cone. Place clutch driven cone (40) in

position against cable drum (42) inserting between the two the number of shims required to correctly adjust the cable drum bearings, (refer to cable drum bearing adjustment instructions on page 2 of Repair Section). and install capscrews and lockwashers (41), drawing them up tight. (NOTE: During Assembly, the cable drum bearings should be hand-packed, and the grease chamber inside the drum filled 2/3 full of WB #2 grease, as outlined in Lubrication Instructions on page 15 of the Operation Section.) Insert spring (15) in end of drum shaft (49).

Raise drum assembly up to right side of gear case and turn drum shaft (49) into clutch throw-nut (16), using a wrench on right end of shaft. (Be very careful in this operation not to damage leather in oil seal (22) as threads on end of shaft pass through seal.) Slide brake band (38) over cable drum and onto driven cone (40). Connect front end of band with right end of brake shaft (7) and rear end of band with lug on gear case by means of brake links and pins. Slide cable guard (51) over cable drum (42). Install drum shaft support plate (52) in position and secure it to gear case by installing capscrew and lockwasher. Secure cable guard (51) to support plate (52) by installing the two capscrews and lockwashers (53). Then install clamp block (48) over drum shaft (49) by installing the two capscrews (46), turning them tight into tapped holes in support plate (52).

The actuator lever (14) can then be clamped onto clutch throw-nut (16) at left side of Unit.

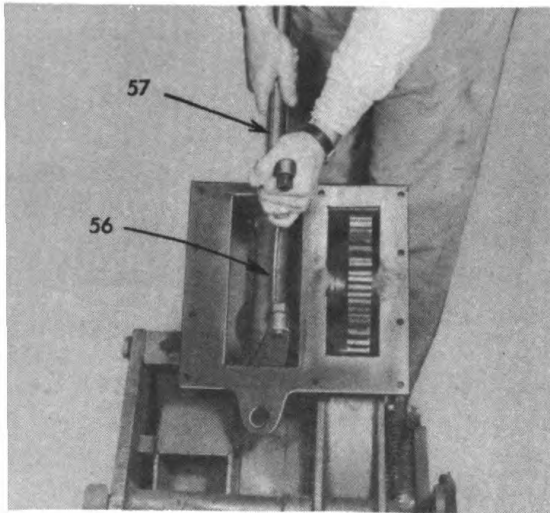

HYSTER SHIFTER FORK

To install Hyster shifter fork in bottom of Power Control Unit, hold shifter fork (56) in position in bottom of case, with faced end of fork facing front end of Unit. Push shaft (57) through hole in front of case and through fork, until shoulder on shaft comes against fork. (Keys should be in place in key-ways in shaft during this operation.)

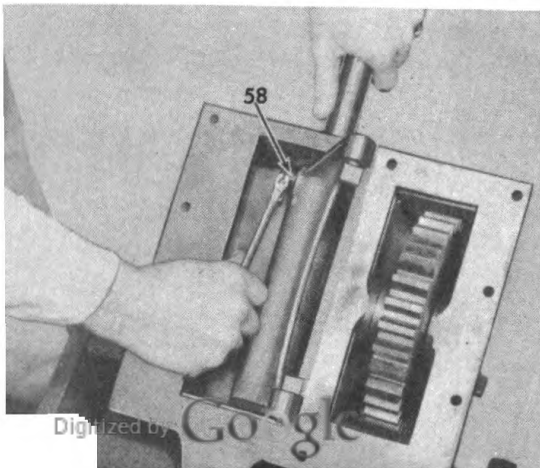

Tighten set screw (58) and then insert wire through hole in head of set screw and wire set screw to shifter fork to prevent screw from backing out and dropping into gear case.

INSTALLING POWER CONTROL UNIT

1. To install the Power Control Unit, first remove tractor seat and inspection plate from top of Hyster Winch (If not already removed.) If Hyster sliding gear is blocked in place, remove blocks. Then position gasket (or gaskets) on top of winch, using dowel pins to hold in place. **IMPOR-**

TANT: — The back-lash between Hyster take-off idler gear and Power Control Unit primary idler gear is determined by thickness of gasket. To obtain the required amount of back-lash, gasket must be of the correct thickness. (Units having serial number P-31267-HN and below use a .062" thick gasket. Units having higher serial numbers use a .010" thick gasket. Refer to Parts Catalog for part numbers.)

2. With Power Control Unit completely assembled, (including Hyster shifter fork) raise Unit directly over winch, using a Crane or hoist.

3. Lower Unit slowly into position on top of winch, lining up shoes on shifter fork with groove in Hyster sliding gear as unit is lowered. It may be necessary to touch starter button (tractor transmission in neutral, fly-wheel clutch engaged, and ignition turned off or compression released) to cause Hyster take-off idler gear to mesh with Power Control Unit primary idler gear and thereby permit Unit to lower into position.

4. Install mounting capscrews and lockwashers in holes around face plate. (Do not turn capscrews down tight until after tie rod and large anchor bolt have been installed at rear of unit.)

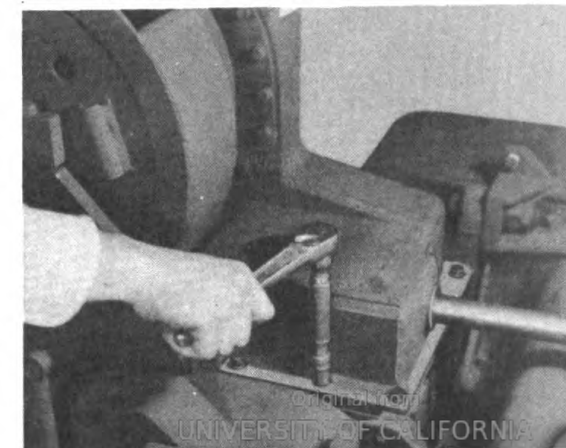
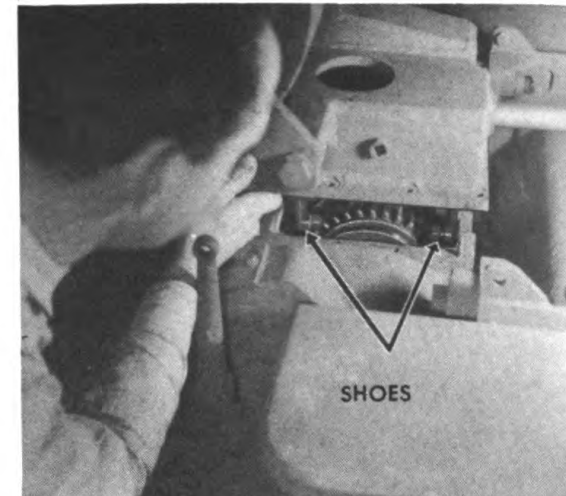
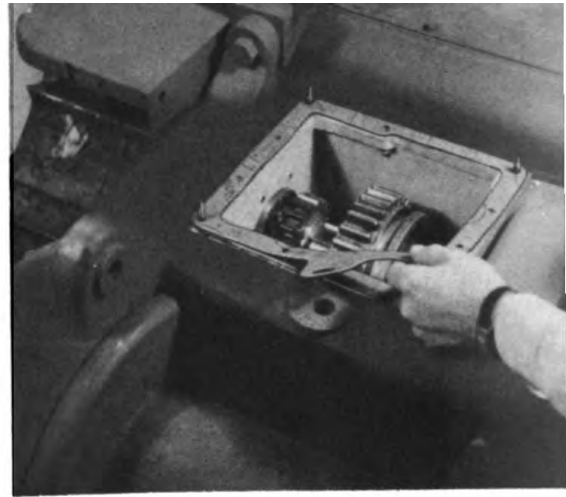

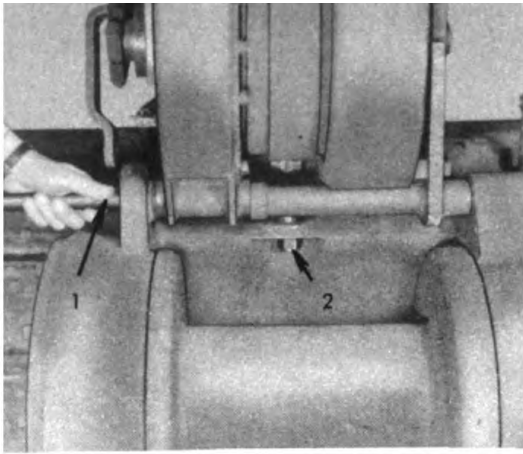

5. Install tie rod (1) through rear of unit. Turn hex nuts onto ends of tie rod and tighten. Also install anchor bolt (2). Then turn mounting bolts around face plate down tight.

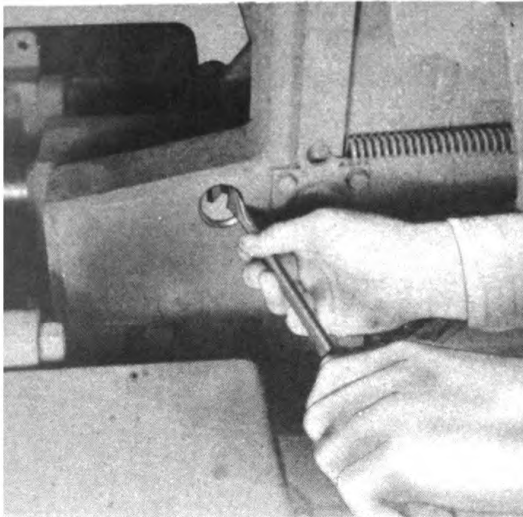

6. Check for back-lash between Hyster take-off idler gear and Power Control Unit primary idler gear by removing pipe plug from left side of unit. To check for back-lash, insert screw driver or similar tool through pipe plug opening and rock gear back and forth. If no back-lash is found, damage may result if Unit is operated, and the cause must be investigated and corrected. (Possibly gasket has been omitted).

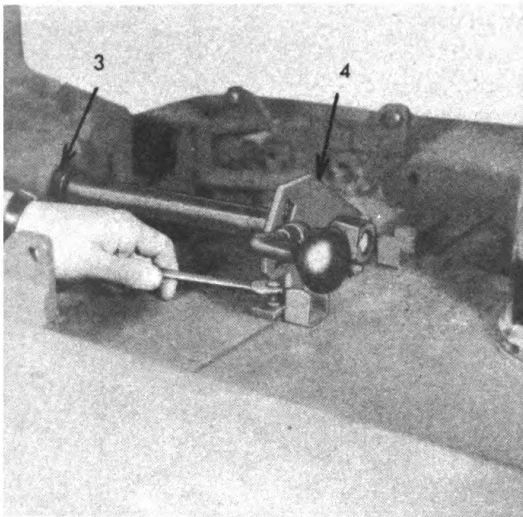

7. Slide set collar (3) over shifter shaft and install bracket (4) and shifter lever at end of Hyster shifter shaft. (NOTE:—In installing bracket, it may be necessary to use a spacer under either side in order to align “neutral” slot in bracket with actual neutral position of shifter lever.) Then by sliding shifter shaft back and forth, find position where fork is centered over Hyster sliding gear. With fork centered, hold set collar (3) against case and tighten set screw.

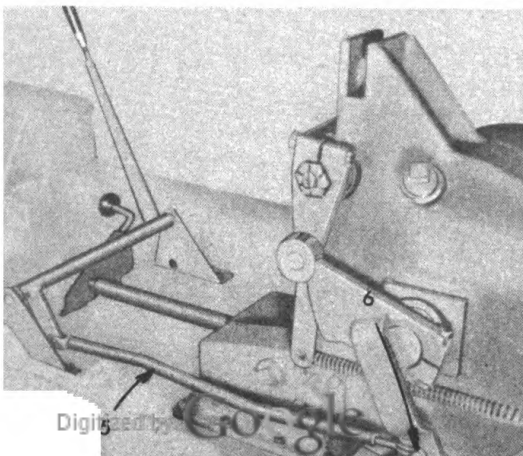

8. Install Power Control Unit control levers, linkage and brackets on tractor deck. Turn clevis (6) far enough into end of rod (5) to space link pin in clevis 28¼" from link pin at front end of control rod. (Repositioning of this clevis may be necessary to obtain correct position of control lever in step 10 after step 9 has been completed, especially on early Units.)

9. Re-install tractor seat and connect Hyster brake linkage. Make Power Control Unit clutch and brake adjustments. (Refer to adjustment instructions on page 8 and 11 of Operation Section.)

10. After correctly positioning brake roller against brake cam in making brake adjustment, move control lever into lock-out position. If lower end of control lever strikes against bracket before control lever reaches lock-out position, it will be necessary to turn clevis out of end of control rod (refer to step 8) just far enough to permit control lever to be moved to lock-out position. (If right hand bracket has notch cut in it, control lever should set back in notch when in lock-out position.)

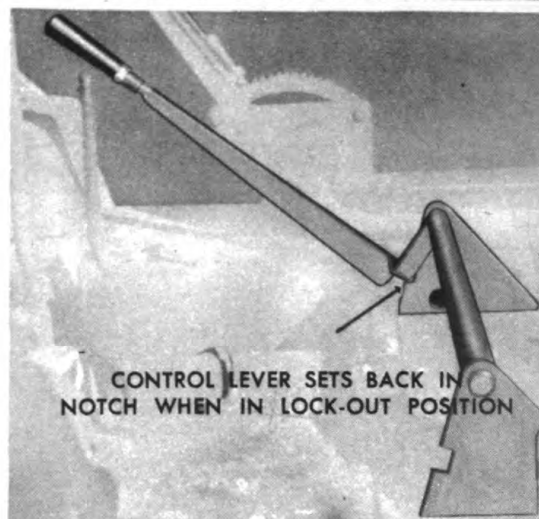
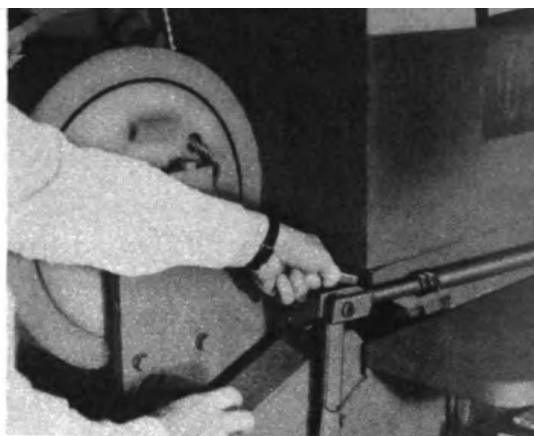

CLUTCH AND BRAKE FACINGS

TYPES OF FACINGS

LeTourneau Power Control Units may be equipped with either woven or metallic clutch and brake facings. Both types of facings used are of the highest grade, and both have a comparatively high co-efficient of friction. The metallic lining is especially resistant to wear, and ordinarily lasts somewhat longer than the woven lining.

CARE OF FACINGS

The clutch and brake facings usually require very little attention after having been properly installed. There are, however, a few things that can be done to the facings under certain conditions which help the operation of the Power Control Unit. There are also other practices which are sometimes resorted to which do not help the operation and which should be avoided, as discussed below.

(a) WOVEN FACINGS:

Woven facings must be kept free of oil if proper operation is to be expected. If oil or grease should leak onto the facings, the cause of this

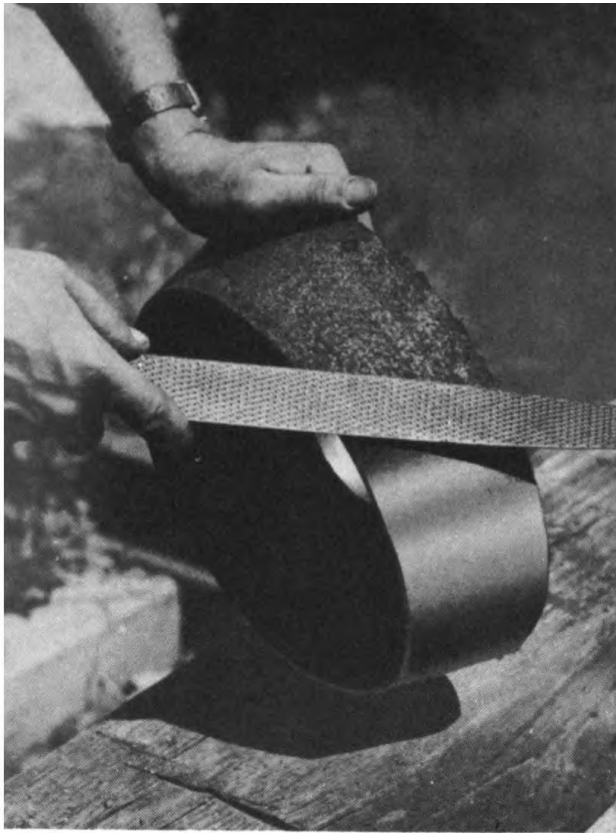

oil leakage should be determined, and the necessary corrections should be made. Unless the clutch and the brake facings are too badly oil soaked, the oil can usually be removed from the facing by washing the facing in naphtha or gasoline.

Facings sometimes become glazed after they have become worn, and in a case of this kind, the surface of the facings may be roughened with a rasp to improve operation, and to prevent having to replace the lining before it has received its maximum amount of wear.

If the clutch or brake facings overheat during operation,

do not pour water on them to cool them off. Instead, check the Unit and the operation to determine the cause of the overheating, and allow the lining to cool slowly by its contact with the air. Pouring cold water on a hot clutch will often cause the clutch cones to warp.

The most common causes of overheating of either the clutches or brakes are improper adjustment and slow engaging and disengaging of the clutch and brake by the operator.

(b) METALLIC FACINGS:

To obtain the maximum usefulness from metallic clutch and brake facings, a small amount of light weight oil, such as fuel oil, may be poured on them each day. This helps to keep the facings free from dust and other foreign particles, and makes for longer facing life.

(NOTE: It is recommended that if the clutch facings are metallic, the brake facings should also be metallic, and vice-versa. This is due to the fact that oil may be applied to one type facing but must not be applied to the other, and it is practically impossible to apply oil to either the clutch or brake facing without the oil also leaking onto the other.)

If either the clutch or brake should overheat during operation, do not pour cold water onto the facings to cool them off. Cold water applied to a hot clutch sometimes causes the clutch cones to warp. If overheating does occur, determine the cause, and make the necessary corrections. The most common causes of overheating of either the clutches or brakes are improper adjustment and slow engaging and disengaging of the clutch by the operator.

RELINING CLUTCH DRIVING CONES

(a) WOVEN CLUTCH FACINGS:

To install a new facing on a driving cone, remove the cone from the Power Control Unit. (Refer to disassembly instructions.) Remove the worn facings and rivets from the cone. Proceed with the installation by heating the new facing either in hot water or in an oven, causing it to expand. Then place the facing on a bench with the smaller diameter on the bottom, or in an up-turned driven cone. Lower the unlined driving cone into the heated facing, making certain that the cone and facing are in perfect alignment with each other. Also, in doing this, line up the seam in the lining with the proper rivet holes in the cone, as illustrated.



Place the cone and facing under a press and force the cone tight into the facing. (If a press is not available, other means of exerting heavy pressure on the cone may be used.) Make certain that the cone is not obstructed from being pressed extremely tight in the facing because of coming in contact with the bench during this operation. (Other methods of installing the facings are also sometimes used with fairly satisfactory results, such as hammering the facing tight onto the cone, etc.) Check to determine whether the facing is tight on the cone by striking around the surface of the facing with a hammer. If the facing is tight, a clear "ring" will be heard. Any points where the facing is not tight will show up by giving off a dull noise with no "ring". Drill or punch rivet holes into the facing, making them line up with the rivet holes in the cone. Counterbore each rivet hole to a depth not less than half the thickness of the facing, and not more than 2/3 the thickness of the facing, using a 3/8" counterbore. Then insert the rivets and rivet the facing to the cone.

Unless the facing is installed exceptionally tight on the cone, spongy clutch action may result. If the facing should be installed eccentric and out of alignment with the cone, clutch drag will occur and the clutch will overheat.

(b) METALLIC CLUTCH FACINGS:

Metallic clutch facings come in segments, shaped to fit the outer circumference of the driving cone, and with the rivet holes already drilled in them. To install the segments on the cone, merely line the holes in the segments up with the holes in the outer circumference of the cone, and rivet the facing to the cone. The rivets should be drawn down very tight in order to prevent the segments from breaking loose when the cone is placed in operation. Only steel rivets should be used.

If possible, the newly lined cones should be placed in a lathe and any high spots or irregularities in the thickness of the different segments machined off. (The facings should be machined to a 15° taper.)

If the clutch surface of the driven cone has worn rough or grooved, it may be advisable to either replace the cone or to machine a very thin cut off the surface of the cone. This machining should also be done on a 15° taper.

RE-LINING BRAKE BANDS**(a) WOVEN LINING:**

To re-line a brake band with woven lining, first remove the brake band from the Power Control Unit. (Refer to disassembly instructions.) Remove the worn lining and rivets from the brake band.

Extend the brake lining around the inner circumference of the brake band, and rivet one end of the lining to the band. Push the lining snug against the band with the hand, around the entire circumference of the band. Then move the lining back about $\frac{1}{4}$ " at the unriveted end, and install the rivets at this end of the band. A small hump will be formed by the lining at the center of the band with this procedure, which should be forced down, causing the lining to be pressed very tight against the brake band. Then install the remaining rivets.



and not more than $\frac{2}{3}$ the thickness of the lining to provide for the heads of the rivets. Use a $\frac{3}{8}$ " counterbore. Then install the rivets, cinching them down very tight.

To install the rivets, drill or punch the rivet holes in the lining, and counterbore these holes to a depth of not less than $\frac{1}{2}$

(b) METALLIC LINING:

To reline a brake band with metallic lining, first remove the brake band from the Power Control Unit. (Refer to Disassembly Instructions.) Remove the worn segments and rivets from the brake band.

To install the new segments, place them in position on the inner circumference of the brake band, line the rivet holes in each segment up with the corresponding rivet holes in the brake band, and rivet the segments to the band, using steel rivets. Draw the rivets up very tight in order to prevent the segments from breaking loose when the brake band is placed in operation.

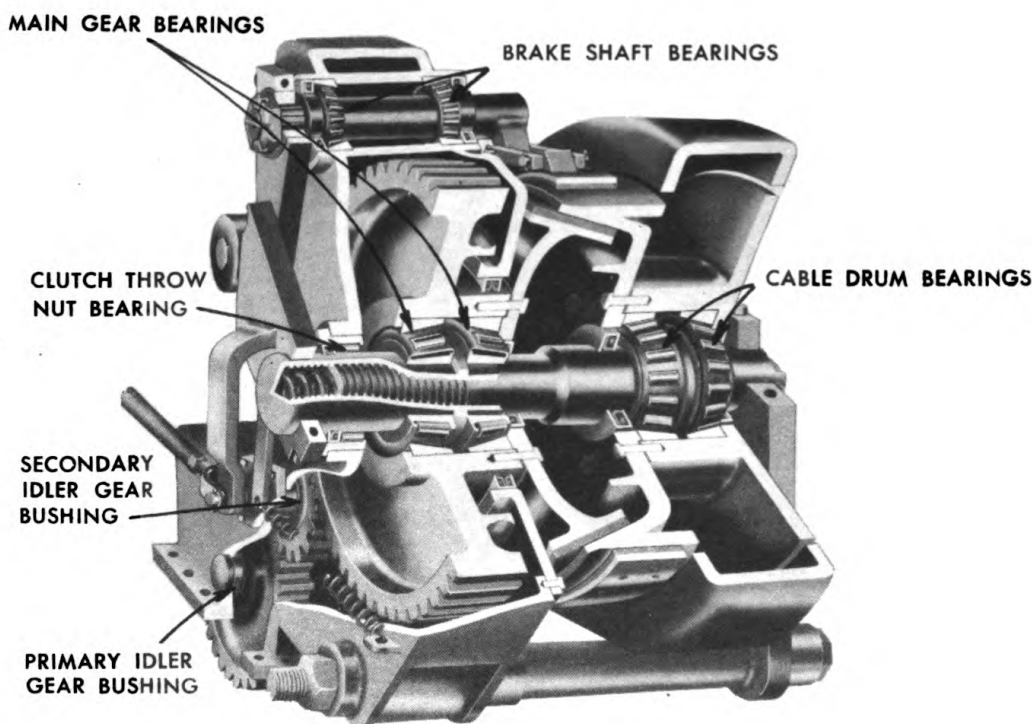

TABLE OF CLEARANCES AND TOLERANCES OF BEARINGS AND ADJUSTABLE PARTS

POINT OF ADJUSTMENT	CORRECT ADJUSTMENT	ALLOWABLE TOLERANCE
Main Gear Bearings	.002" pre-load	.000" to .003" pre-load
Cable Drum Bearings	.005" pre-load	.003" preload to .006" pre-load
Brake Shaft Bearings	.000"	.002" loose to .001" pre-load
Clutch Throw-Nut Bearing	Non adjustable
Primary Idler Gear Bushing	Non adjustable
Secondary Idler Gear Bushing	Non adjustable

TROUBLE SHOOTER'S GUIDE

CLUTCH SLIPPAGE

CAUSE	REMEDY
<i>Actuator lever installed too far to the right on clutch throw-nut and therefore riding against throw-nut bushing as control lever is moved, preventing driving cone from fully engaging driven cone.</i>	Space actuator lever farther to the left on clutch throw-nut. (Refer to step 8 of clutch adjustment.)
<i>Main gear incorrectly spaced inside gear case, thereby riding against right side of gear case when control lever is moved to the rear, preventing driving cone from fully engaging driven cone.</i>	Make clutch adjustment, correctly spacing main gear inside gear case.
<i>Oily or greasy clutch facing (woven facing only).</i>	Remove driving cone and either replace facing or wash facing with naphtha or gasoline. Also prevent further oil or grease from reaching clutch surfaces as follows: — Correct oil seal leakage, if present (refer to "Oil Seal Leakage" corrections). Do not lubricate that portion of cable which wraps onto cable drum. Never apply oil to woven facings.
<i>Clutch facing installed eccentric on driving cone (woven facing) or high spots on facing not having been machined off (metallic facing), causing only a part of clutch facing to bear against driven cone when clutch is fully engaged.</i>	If woven facing, either remove facing and install it concentric on cone or machine surface of facing true with cone, using a grinder. If metallic facing, machine off high spots.
<i>Worn out clutch facing.</i>	Either install new facing on driving cone or install a replacement lined driving cone.
<i>Smooth, glazed clutch facing.</i>	Remove driving cone and roughen clutch facing with a rasp.

CLUTCH WON'T RELEASE — CLUTCH DRAGGING

CAUSE	REMEDY
<i>Clutch adjustment incorrect, with travel of control lever from neutral to fully engaged position set at less than the recommended distance, thereby providing insufficient clearance between driving and driven cones when in neutral.</i>	Make clutch adjustment, correctly setting travel of control lever from neutral to fully engaged position.
<i>Main gear bearings in a loose adjustment, causing driving cone to drag on driven cone when control lever is in neutral position.</i>	Correctly adjust main gear bearings.
<i>Cable drum bearings in a loose adjustment, causing driven cone to drag on driving cone when control lever is in neutral position.</i>	Correctly adjust cable drum bearings.
<i>Clutch facing loose on driving cone, resulting in facing dragging on driven cone when control lever is in neutral.</i>	Remove driving cone and either re-install facing on driving cone or install new lined cone.
<i>Threads excessively worn on drum shaft or clutch throw-nut, resulting in full travel of control lever being required to take up play in threads instead of moving driving cone away from driven cone.</i>	Replace worn drum shaft or throw-nut.

TROUBLE SHOOTER'S GUIDE

CLUTCH WON'T ENGAGE

CAUSE	REMEDY
<i>Actuator lever installed too far to the right on clutch throw-nut, therefore riding against throw-nut bushing as control lever is moved, preventing driving cone from fully engaging driven cone.</i>	Space actuator lever farther to the left on clutch throw-nut. (Refer to step 8 of clutch adjustment).
<i>Main gear incorrectly spaced inside gear case, thereby riding against right side of gear case when control lever is moved to the rear, preventing driving cone from fully engaging driven cone.</i>	Make clutch adjustment, correctly spacing main gear inside gear case.
<i>Control lever striking against operator's seat before clutch becomes fully engaged.</i>	Adjust clutch, correctly setting distance of travel of control lever from neutral to the fully engaged position. (Refer to clutch adjustment instructions).

CLUTCH WON'T HOLD ADJUSTMENT

CAUSE	REMEDY
<i>Clamp block at right end of drum shaft insufficiently tightened, allowing drum shaft to turn.</i>	Re-adjust clutch and tighten clamp block on drum shaft by turning capscrews down tight, using force.
<i>Actuator lever not clamped tight on clutch throw-nut, allowing lever to slip on throw-nut.</i>	Clamp actuator lever tight on clutch throw-nut by turning clamp bolt up tight, using force. Then re-adjust clutch.
<i>Brake roller arm not clamped tight on bushing at left end of brake shaft, allowing roller arm to slip on bushing.</i>	Re-adjust brake and tighten clamp bolt at upper end of roller arm, using force.

SPONGY CLUTCH

CAUSE	REMEDY
<i>Main gear bearings in a loose adjustment, allowing end play of driving cone on clutch throw-nut, and mis-alignment of driving cone with driven cone.</i>	Correctly adjust main gear bearings.
<i>Cable drum bearings in a loose adjustment, allowing end play of cable drum and driven cone on drum shaft and mis-alignment of driven cone with driving cone.</i>	Correctly adjust cable drum bearings.
<i>Clutch facing not tight on driving cone, thereby tending to "give" and become "spongy" when engaging and disengaging clutch.</i>	Remove driving cone and re-line or install a replacement lined cone.
<i>Clutch facing installed eccentric on driving cone, causing only a portion of facing to contact driven cone when engaging clutch, resulting in slippage until heavy force is applied on control lever, giving "spongy" action.</i>	Remove driving cone and machine surface of facing true with cone.

TROUBLE SHOOTER'S GUIDE

BRAKE SLIPPAGE

CAUSE	REMEDY
<i>Brake roller positioned too low against brake cam, causing lower end of roller arm to be positioned too far to the rear, thereby decreasing tension of brake spring.</i>	Make brake adjustment, correctly positioning brake roller against brake cam (1" down from lock-out position.)
<i>Brake shaft bearings adjusted too tight, preventing free rotation of brake shaft and causing shaft to bind, sometimes holding brake band away from drum.</i>	Correctly adjust brake shaft bearings.
<i>Oily or greasy brake lining (woven lining only).</i>	Remove brake band and either replace or wash lining with naphtha or gasoline. Also prevent further oil or grease from reaching brake lining as follows:—If oil seals are leaking, correct leakage (refer to "Oil Seal Leakage" corrections). Do not lubricate that portion of cable which wraps onto cable drum. Never apply oil to woven lining.
<i>Tension of brake spring decreased, due to old age or long period of operation.</i>	Replace brake spring.
<i>Mud, rocks or other obstacles lodged in brake spring or behind brake roller arm or linkage.</i>	Remove mud, rocks, or other obstructions.
<i>Worn out brake lining.</i>	Replace brake lining.
<i>Brake band improperly formed to fit drum, possibly through accident.</i>	Replace or re-shape brake band.

BRAKE WON'T RELEASE

CAUSE	REMEDY
<i>Brake roller positioned too high against brake cam, preventing cam from moving roller arm forward far enough to cause brake to release when control lever is moved.</i>	Make brake adjustment, correctly positioning brake roller against brake cam (1" down from lock-out position).
<i>Brake roller arm not clamped tight on bushing at end of brake shaft, allowing roller arm to slip on bushing.</i>	Correctly adjust brake and tighten clamp bolt at upper end of roller arm, using force.
<i>Main gear incorrectly spaced inside gear case, thereby riding against left side of gear case as control lever is moved forward, limiting travel of control lever and preventing brake from fully releasing.</i>	Make clutch adjustment, correctly spacing gear inside gear case.
<i>Brake band frozen to drum.</i>	Move control lever into lock-out position and tap on brake band with hammer.

TROUBLE SHOOTER'S GUIDE

OVERHEATING

CAUSE	REMEDY
<i>Operator not engaging and disengaging clutch fully and quickly, causing short intervals of clutch slippage and overheating.</i>	Engage and disengage clutch with a quick, full movement of control lever.
<i>Brake slipping.</i>	Correct the cause for brake slippage. (Refer to "Brake Slippage" corrections).
<i>Clutch slipping.</i>	Correct the cause for clutch slippage. (refer to "Clutch Slippage" corrections).
<i>Clutch dragging.</i>	Correct the cause for clutch dragging. (refer to "Clutch Dragging" corrections).

OIL SEAL LEAKAGE

CAUSE	REMEDY
<i>Power Control Unit overheating and thereby burning and hardening leather in oil seals.</i>	Correct cause for overheating (refer to "Overheating" chart above). Also replace leaky oil seals.
<i>Cable drum filled more than 2/3 full of grease (Possibly by inserting grease through rear end of drum shaft with grease gun) causing grease to be forced out around seals as pressure is built up inside drum through heat of operation.</i>	Remove cable drum and hand-pack only 2/3 full of recommended lubricant. Also replace leaky oil seals. Lubricate through holes in drum shaft only in case of emergency.
<i>Lubricants may not be those which are recommended. Oils lighter than recommended may seep out under seals, while incorrect type grease may break down and become fluid from heat of operation.</i>	Remove incorrect lubricants and replace with lubricants which are recommended.
<i>Main gear bearings in a loose adjustment, causing gear and driving cone to wobble, thereby whipping out leather in oil seals.</i>	Correctly adjust main gear bearings. Also replace leaky oil seals.
<i>Cable drum bearings in a loose adjustment, allowing cable drum to raise and lower on drum shaft each time load is raised and lowered, thereby working cable drum oil seals up and down on shaft, permitting grease to escape.</i>	Correctly adjust cable drum bearings. Also replace leaky oil seals.
<i>Oil seals damaged during assembly.</i>	Replace leaky oil seals, being careful not to damage replacement seals.
<i>Oil seals incorrectly installed during assembly, with leathers cupped outward, away from oil or grease chamber.</i>	Remove oil seals and install with leathers cupped inward, toward oil or grease chamber. Double leather oil seals should be installed with heavy leather facing inward.
<i>Breather hole in oil fill plug not open, causing a pressure to be built up inside the gear case, forcing oil out around the seals.</i>	Remove cork (or dirt) from breather hole in fill plug. Also replace leaky oil seals.

PARTS CATALOG

WARNING

SPARE PARTS can be supplied promptly and accurately only if positively identified by correct part number and correct part name.

FURNISH THIS INFORMATION ON ALL REQUISITIONS. WITHOUT FAIL, on all requisitions, give name of machine, name of manufacturer, model or size, manufacturer's serial number of each machine and subassemblies attached to machine, and components and accessories for which spare parts are required.

List spare parts for only one make or kind of machine on each requisition.

Requisitions must be double spaced to provide room for office notations when necessary.

SECT. 3

PREPARATION OF REQUISITIONS

SAMPLE COPY FOR USE IN THE PREPARATION OF REQUISITIONS

State PERIOD designation by use of one of the following terms:

- (1) "INITIAL" — first requisition of authorized allowances.
- (2) "REPLENISHMENT" — subsequent requisitions to maintain authorized allowances.
- (3) "SPECIAL" — requisitions for necessary repairs not covered by allowances.

Emergency requisitions sent by telephone, telegraph, or radio must always be confirmed immediately with requisition marked: "Confirming (state identifying data)"

Prepare a separate requisition for each different machine.

Type "SPARE PARTS" in upper right hand corner of requisition form.

Give complete shipping instructions. Special instructions for packing, marking, routing, etc. should be given at the end of the requisition.

State proper nomenclature of machine and make, model, serial number and registration number.

State basis or authority, and date delivery is required, immediately below description of machine.

State manufacturers' parts numbers and nomenclature descriptions accurately and completely. Do not use abbreviations.

Group parts required under group headings as shown in manufacturers' parts catalogs.

Double space between items.

Nonexpendable items must be accounted for.

WAR DEPARTMENT
Q. M. C. Form No. 400
(Revised Apr. 6, 1941)

(SAMPLE)
REQUISITION

SPARE PARTS

To: Engineer Supply Officer, No. of Sheets 1 Sheet No. 1
Columbus Quartermaster Depot, Columbus, Ohio

Requisition No. E-531-3-43 Date August 14, 1942 Period Special

SHIP TO Engineer Property Officer, Pine Camp, New York

MARKED FOR: Engineer Supply Officer, 802nd Engr. Battalion, Pine Camp, N.Y.

Requisitioned By (show Signature, Rank, Organization, Destination. If different from "SHIP TO" include address):
Robert E. Roe
Robert E. Roe,
Major, C.E.,
Engineer Property Officer

APPROVED:
John E. Doe
John E. Doe,
Col., C.E.,
Executive Officer

STOCK No	ARTICLES	UNIT	ON HAND AND DUE	CONSUMED	REQUIRED	APPROVED
PARTS FOR LetOURNEAU POWER CONTROL UNIT, MODEL "EM", SERIAL NUMBER P-20000-EM						
Basis: Repair of disabled equipment						
Delivery is requested by August 30, 1942						
CASE GROUP						
<u>E-3334</u>	ACTUATOR	ea	0	4	4	
<u>E-3536</u>	CASE	ea	0	4	4	
CABLE DRUM GROUP						
<u>C-324</u>	DRUM	ea	0	4	4	
<u>C-8</u>	CUP	ea	0	4	4	
<u>C-7</u>	CONE	ea	0	4	4	
<u>C-327</u>	SHAFT	ea	0	4	4	
NONEXPENDABLE ARTICLES SHOWN HAVE BEEN PLACED ON I & I REPORT (REPORT OF SURVEY, ETC.)						

PREPARATION OF REQUISITIONS

A Sample requisition in the correct form for submission by the Engineer Property Officer is shown on the opposite page.

THIS SHALL BE FOLLOWED IN MAKING OUT REQUISITIONS.

In order to eliminate duplication of work, Property Officers may authorize organizations to prepare requisitions in final form, leaving requisition number space blank for completion by Property Officer.

THE FOLLOWING RULES WILL BE OBSERVED CAREFULLY IN PREPARING REQUISITIONS FOR SPARE PARTS:

- a. Prepare a separate requisition for each different machine.
- b. Type "SPARE PARTS" in upper right hand corner of requisition form.
- c. State PERIOD designation by use of one of the following terms:
 - (1) "INITIAL"—first requisition of authorized allowances.
 - (2) "REPLENISHMENT"—subsequent requisitions to maintain authorized allowances.
 - (3) "SPECIAL"—requisitions for necessary repairs not covered by allowances.
- d. Give complete shipping instructions.
- e. State proper nomenclature of machine, and make, model, serial number and registration number.
- f. State basis or authority, and date delivery is required, immediately below description of machine.
- g. Group parts required under group headings as shown in manufacturers' parts catalogs.
- h. State manufacturers' parts numbers and nomenclature descriptions accurately and completely. Do not use abbreviations.
- i. Double space between items.
- j. Emergency requisitions sent by telephone, telegraph, or radio must always be confirmed immediately with requisition marked: "Confirming (state identifying data)".
- k. Nonexpendable items must be accounted for.

(EFFECTIVE WITH SERIAL NO. P25197 HN THRU P-31266 HN)

MODEL HN POWER UNIT

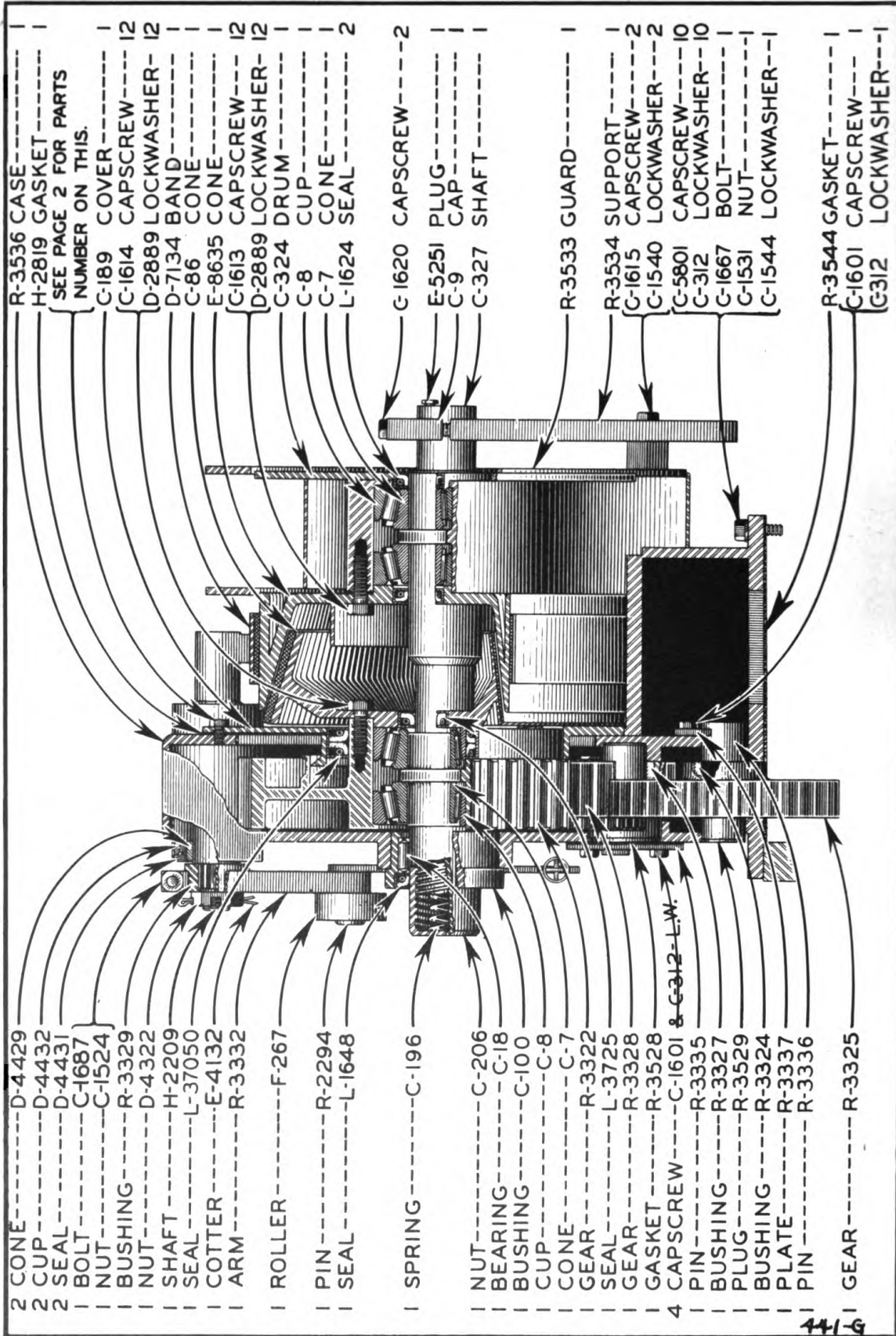

- | | |
|----------------------------------|------------------------|
| 2 CONE-----D-4429 | R-3536 CASE-----1 |
| 2 CUP-----D-4432 | H-2819 GASKET-----1 |
| 2 SEAL-----D-4431 | { SEE PAGE 2 FOR PARTS |
| 1 BOLT-----C-1687 | NUMBER ON THIS. |
| 1 NUT-----C-1524 | C-189 COVER-----1 |
| 1 BUSHING---R-3329 | C-1614 CAPSCREW---12 |
| 1 NUT-----D-4322 | D-2889 LOCKWASHER-12 |
| 1 SHAFT-----H-2209 | D-7134 BAND-----1 |
| 1 SEAL-----L-37050 | C-86 CONE-----1 |
| 1 COTTER---E-4132 | E-8635 CONE-----1 |
| 1 ARM-----R-3332 | C-1613 CAPSCREW---12 |
| 1 ROLLER---F-267 | D-2889 LOCKWASHER-12 |
| 1 PIN-----R-2294 | C-324 DRUM-----1 |
| 1 SEAL-----L-1648 | C-8 CUP-----1 |
| 1 SPRING---C-196 | C-7 CONE-----1 |
| 1 NUT-----C-206 | L-1624 SEAL-----2 |
| 1 BEARING---C-18 | G-1620 CAPSCREW---2 |
| 1 BUSHING---C-100 | E-5251 PLUG-----1 |
| 1 CUP-----C-8 | C-9 CAP-----1 |
| 1 CONE-----C-7 | C-327 SHAFT-----1 |
| 1 GEAR-----R-3322 | R-3533 GUARD-----1 |
| 1 SEAL-----L-3725 | R-3534 SUPPORT-----1 |
| 1 GEAR-----R-3328 | C-1615 CAPSCREW---2 |
| 1 GASKET---R-3528 | C-1540 LOCKWASHER---2 |
| 4 CAPSCREW---C-1601 & C-312-L.W. | C-5801 CAPSCREW---10 |
| 1 PIN-----R-3335 | C-312 LOCKWASHER---10 |
| 1 BUSHING---R-3327 | C-1667 BOLT-----1 |
| 1 PLUG-----R-3529 | C-1531 NUT-----1 |
| 1 BUSHING---R-3324 | C-1544 LOCKWASHER---1 |
| 1 PLATE-----R-3337 | R-3544 GASKET-----1 |
| 1 PIN-----R-3336 | C-1601 CAPSCREW---1 |
| 1 GEAR-----R-3325 | G-312 LOCKWASHER---1 |

CASE CROSS SECTION

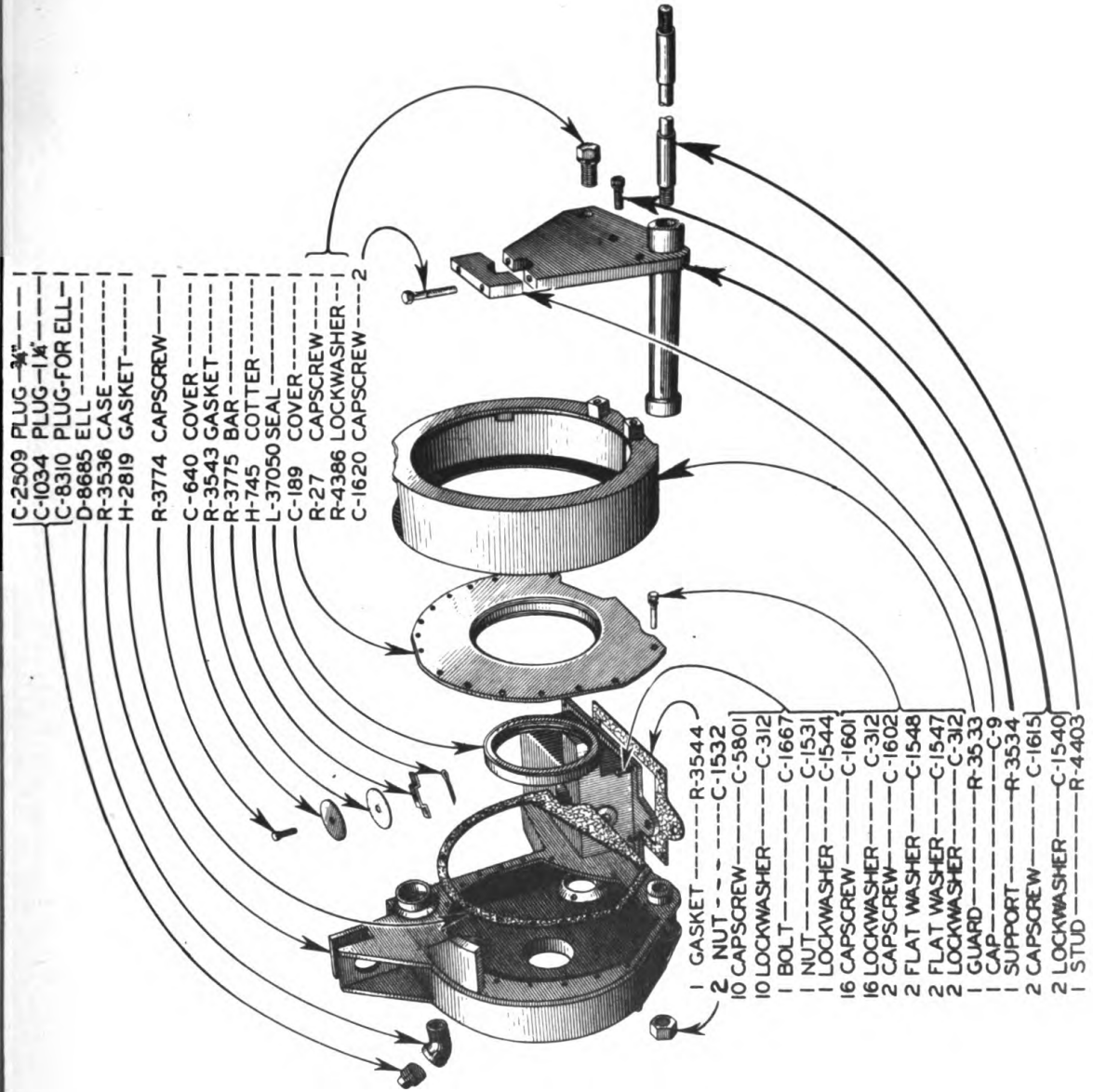

- C-2509 PLUG-3/4"
- C-1034 PLUG-1/4"
- C-8310 PLUG-FOR ELL
- D-8685 ELL
- R-3536 CASE
- H-2819 GASKET
- R-3774 CAPSCREW
- C-640 COVER
- R-3543 GASKET
- R-3775 BAR
- H-745 COTTER
- L-37050 SEAL
- C-189 COVER
- R-27 CAPSCREW
- R-4386 LOCKWASHER
- C-1620 CAPSCREW-2

- 1 GASKET-----R-3544
- 2 NUT-----C-1532
- 10 CAPSCREW-----C-5801
- 10 LOCKWASHER-----C-312
- 1 BOLT-----C-1667
- 1 NUT-----C-1531
- 1 LOCKWASHER-----C-1544
- 16 CAPSCREW-----C-1601
- 16 LOCKWASHER-----C-312
- 2 CAPSCREW-----C-1602
- 2 FLAT WASHER-----C-1548
- 2 FLAT WASHER-----C-1547
- 2 LOCKWASHER-----C-312
- 1 GUARD-----R-3533
- 1 CAP-----C-9
- 1 SUPPORT-----R-3534
- 2 CAPSCREW-----C-1615
- 2 LOCKWASHER-----C-1540
- 1 STUD-----R-4403

442-G

CASE GROUP-EXPLODED

IA

MODEL HN POWER UNIT

(EFFECTIVE WITH SERIAL NO. P31267 HN AND UP)

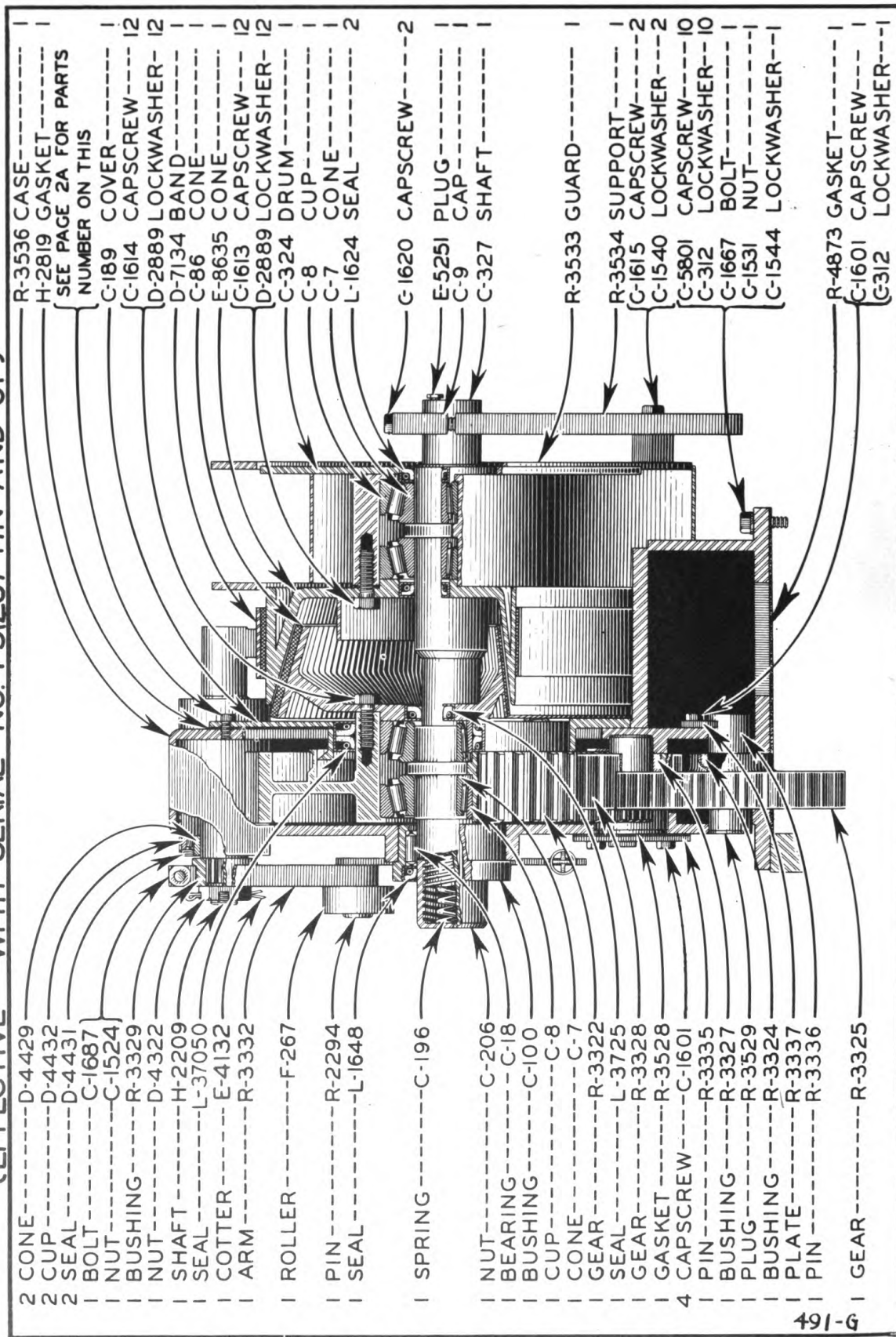

- | | |
|---------------------|-------------------------|
| 2 CONE-----D-4429 | R-3536 CASE----- |
| 2 CUP-----D-4432 | H-2819 GASKET----- |
| 2 SEAL-----D-4431 | { SEE PAGE 2A FOR PARTS |
| 1 BOLT-----C-1687 | NUMBER ON THIS |
| 1 NUT-----C-1524 | C-189 COVER----- |
| 1 BUSHING---R-3329 | C-1614 CAPSCREW---12 |
| 1 NUT-----D-4322 | D-2889 LOCKWASHER-12 |
| 1 SHAFT---H-2209 | D-7134 BAND----- |
| 1 SEAL---L-37050 | C-86 CONE----- |
| 1 COTTER---E-4132 | E-8635 CONE----- |
| 1 ARM-----R-3332 | C-1613 CAPSCREW---12 |
| 1 ROLLER---F-267 | D-2889 LOCKWASHER-12 |
| 1 PIN-----R-2294 | C-324 DRUM----- |
| 1 SEAL---L-1648 | C-8 CUP----- |
| 1 SPRING---C-196 | C-7 CONE----- |
| 1 NUT-----C-206 | L-1624 SEAL-----2 |
| 1 BEARING---C-18 | G-1620 CAPSCREW---2 |
| 1 BUSHING---C-100 | E-5251 PLUG----- |
| 1 CUP-----C-8 | C-9 CAP----- |
| 1 CONE-----C-7 | C-327 SHAFT----- |
| 1 GEAR-----R-3322 | R-3533 GUARD----- |
| 1 SEAL---L-3725 | R-3534 SUPPORT----- |
| 1 GEAR---R-3328 | C-1615 CAPSCREW---2 |
| 1 GASKET---R-3528 | C-1540 LOCKWASHER---2 |
| 4 CAPSCREW---C-1601 | C-5801 CAPSCREW---10 |
| 1 PIN-----R-3335 | C-312 LOCKWASHER---10 |
| 1 BUSHING---R-3327 | C-1667 BOLT----- |
| 1 PLUG---R-3529 | C-1531 NUT----- |
| 1 BUSHING---R-3324 | C-1544 LOCKWASHER---1 |
| 1 PLATE---R-3337 | R-4873 GASKET----- |
| 1 PIN-----R-3336 | C-1601 CAPSCREW---1 |
| 1 GEAR---R-3325 | C-312 LOCKWASHER---1 |

CASE CROSS SECTION

491-G

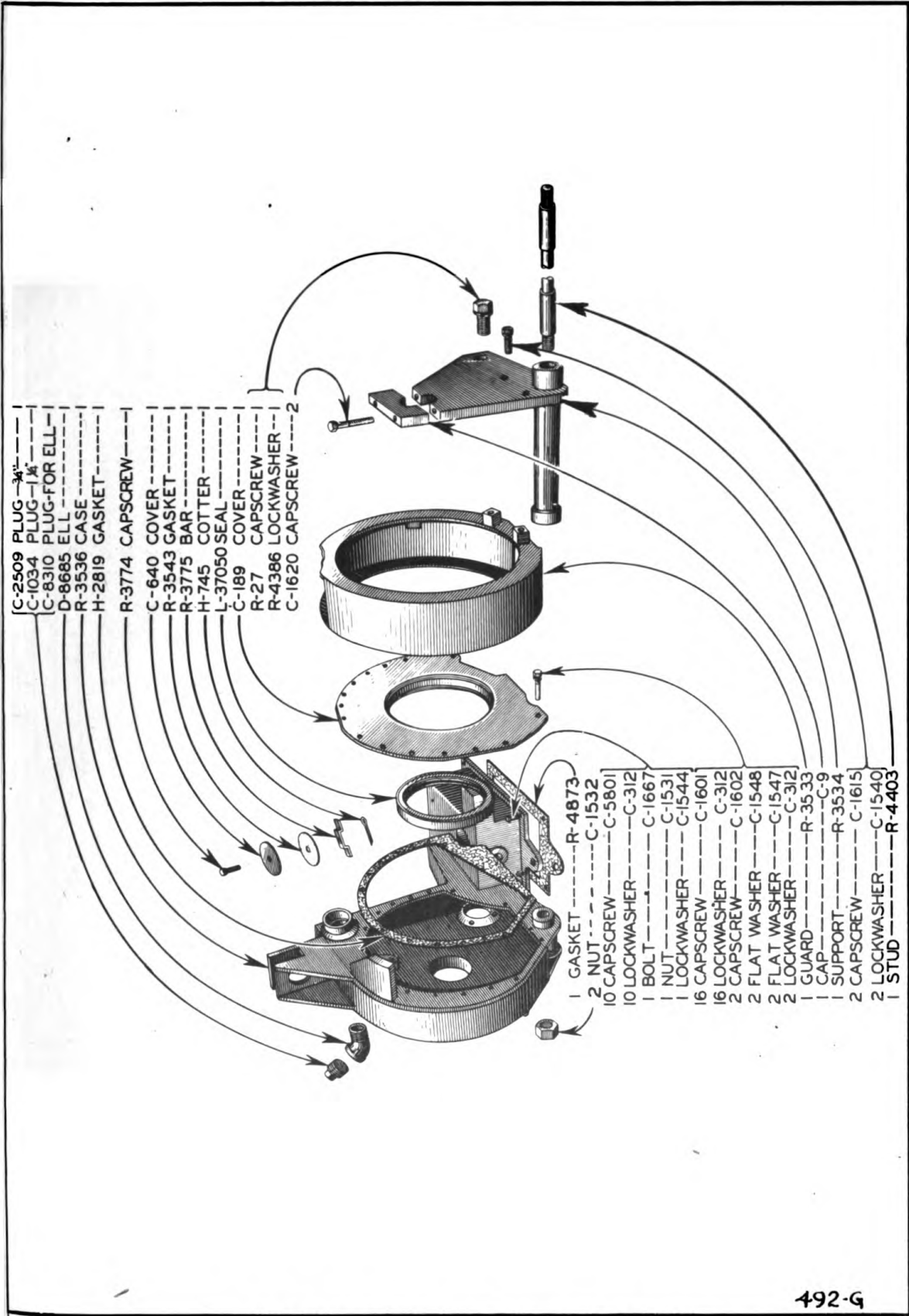

- C-2509 PLUG - 3/4"
- C-1034 PLUG - 1/2"
- C-8310 PLUG-FOR ELL
- D-8685 ELL
- R-3536 CASE
- H-2819 GASKET
- R-3774 CAPSCREW
- C-640 COVER
- R-3543 GASKET
- R-3775 BAR
- H-745 COTTER
- L-37050 SEAL
- C-189 COVER
- R-27 CAPSCREW
- R-4386 LOCKWASHER
- C-1620 CAPSCREW - 2

- 1 GASKET - R-4873
- 2 NUT - C-1532
- 10 CAPSCREW - C-5801
- 10 LOCKWASHER - C-312
- 1 BOLT - C-1667
- 1 NUT - C-1531
- 1 LOCKWASHER - C-1544
- 16 CAPSCREW - C-1601
- 16 LOCKWASHER - C-312
- 2 CAPSCREW - C-1602
- 2 FLAT WASHER - C-1548
- 2 FLAT WASHER - C-1547
- 2 LOCKWASHER - C-312
- 1 GUARD - R-3533
- 1 CAP - C-9
- 1 SUPPORT - R-3534
- 2 CAPSCREW - C-1615
- 2 LOCKWASHER - C-1540
- 1 STUD - R-4403

CEFFECTIVE WITH SERIAL NO. P31267 HN AND UP)

492-G

CASE GROUP-EXPLODED

Generated on 2017-03-09 11:41 GMT / http://hdl.handle.net/2027/uc1.b3241428
 Public Domain, Google-digitized / http://www.hathitrust.org/access_use#pd-google

MODEL HN POWER UNIT

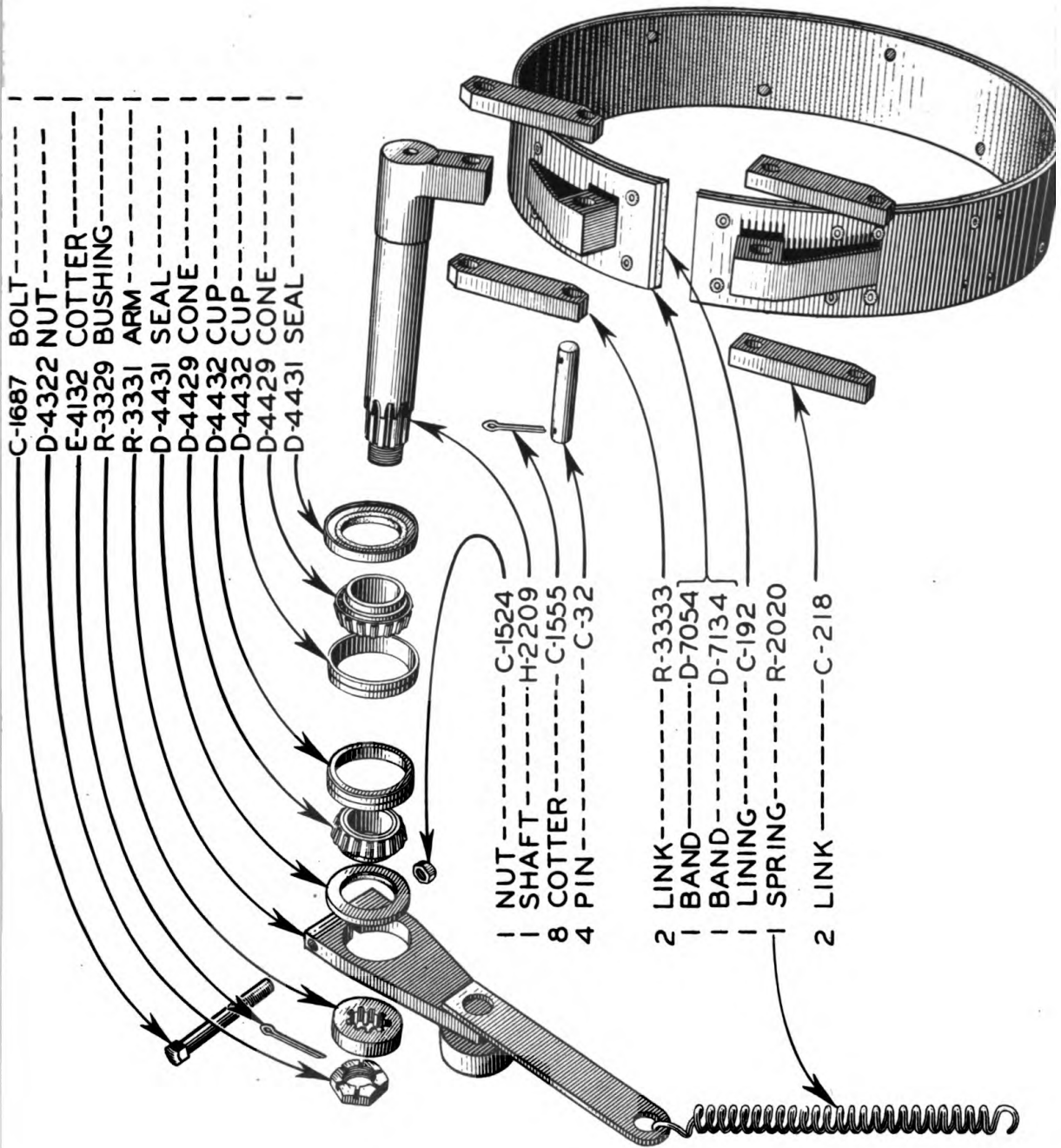

443-G

BRAKE GROUP-EXPLODED

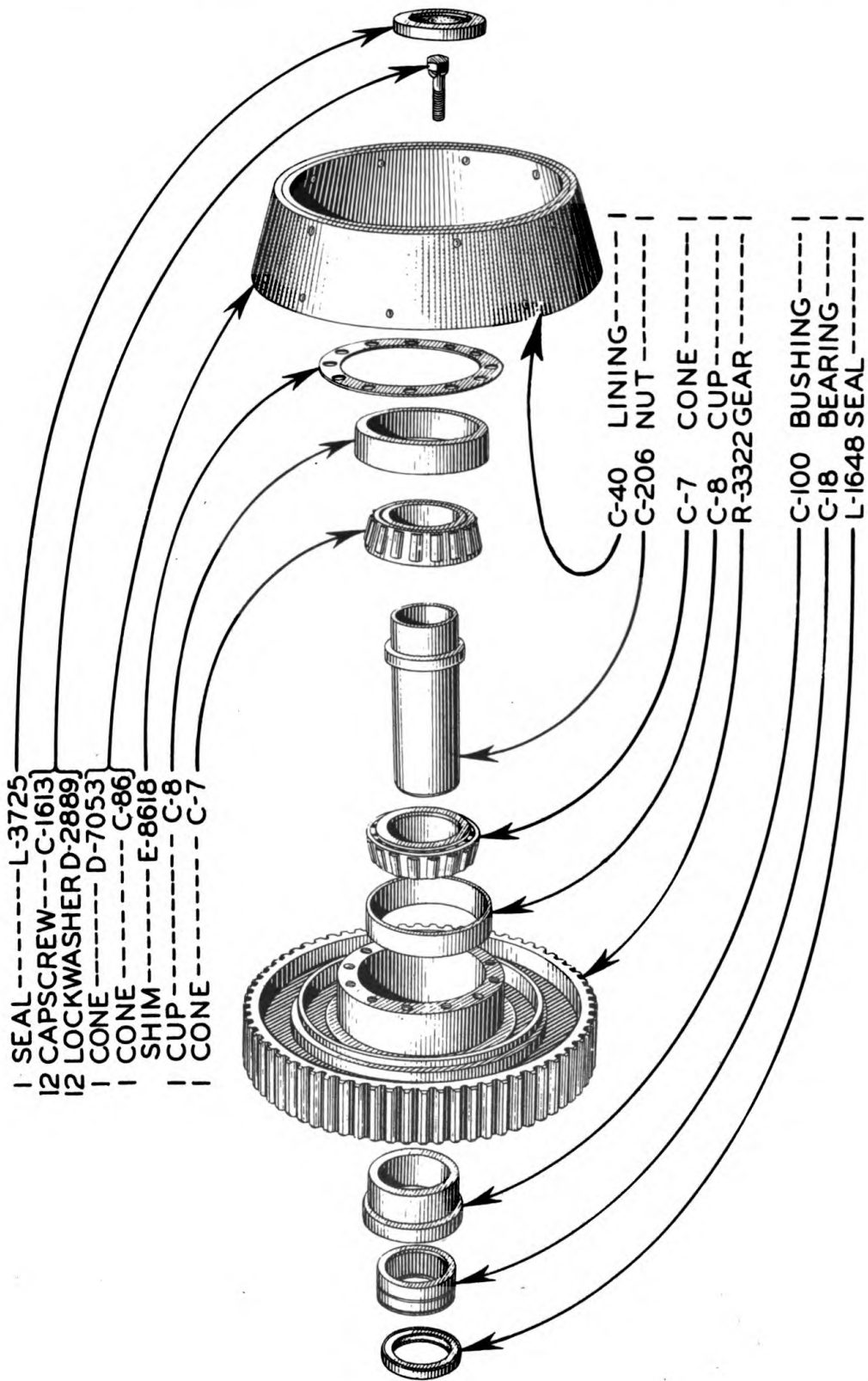

MAIN GEAR & DRIVING CONE EXPLODED

444-G

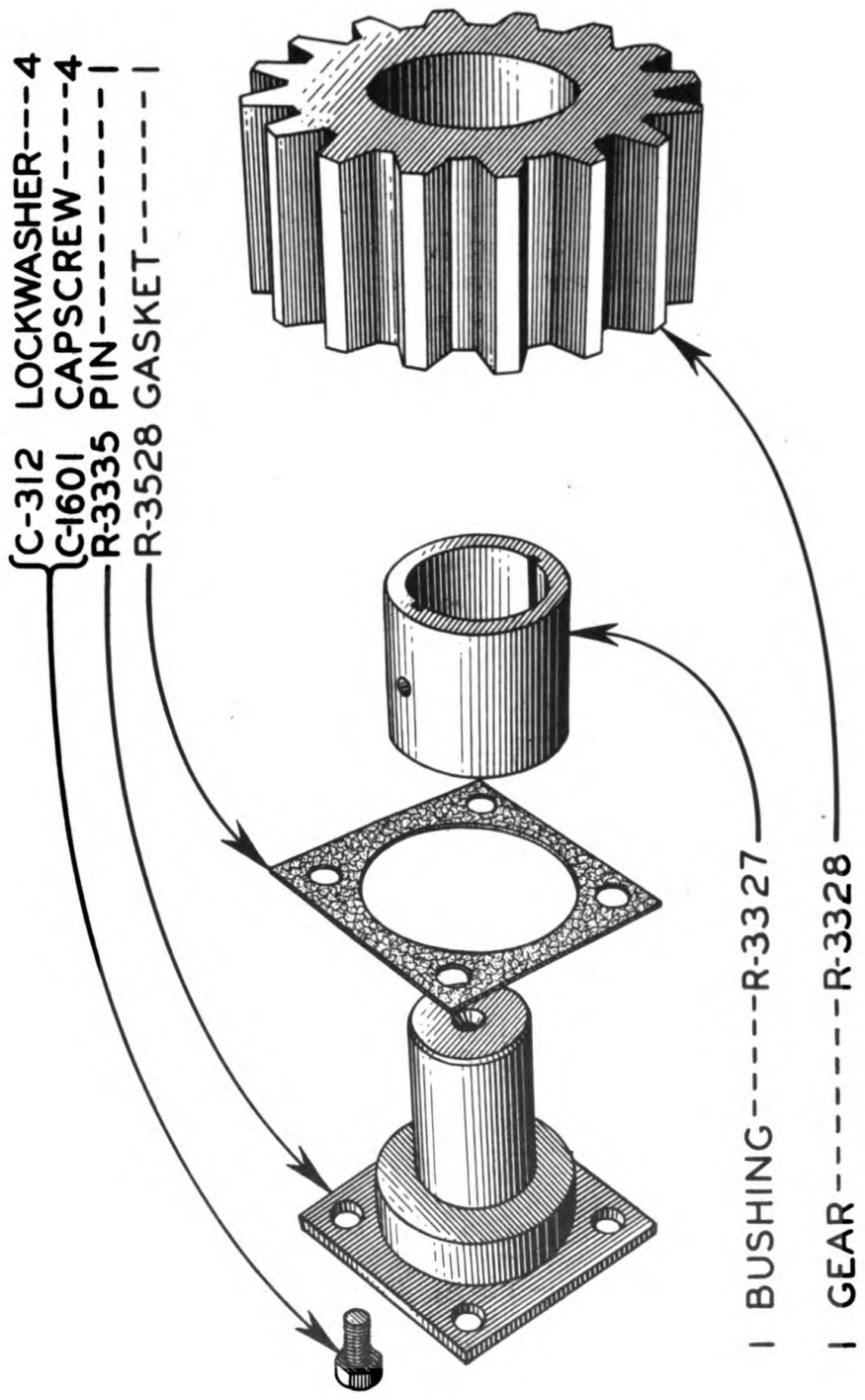

445-G

SECONDARY IDLER GROUP

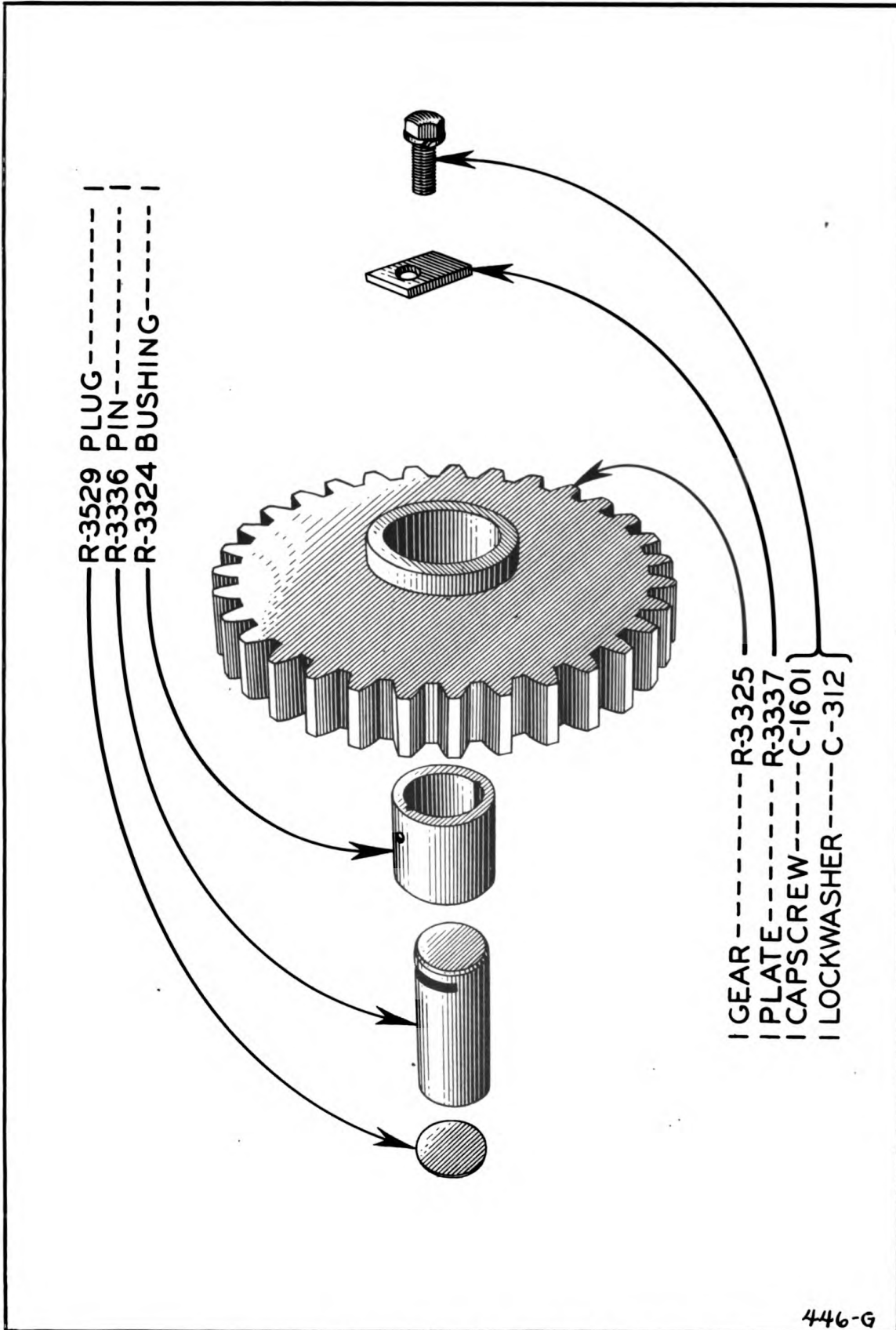

446-G

PRIMARY IDLER GROUP

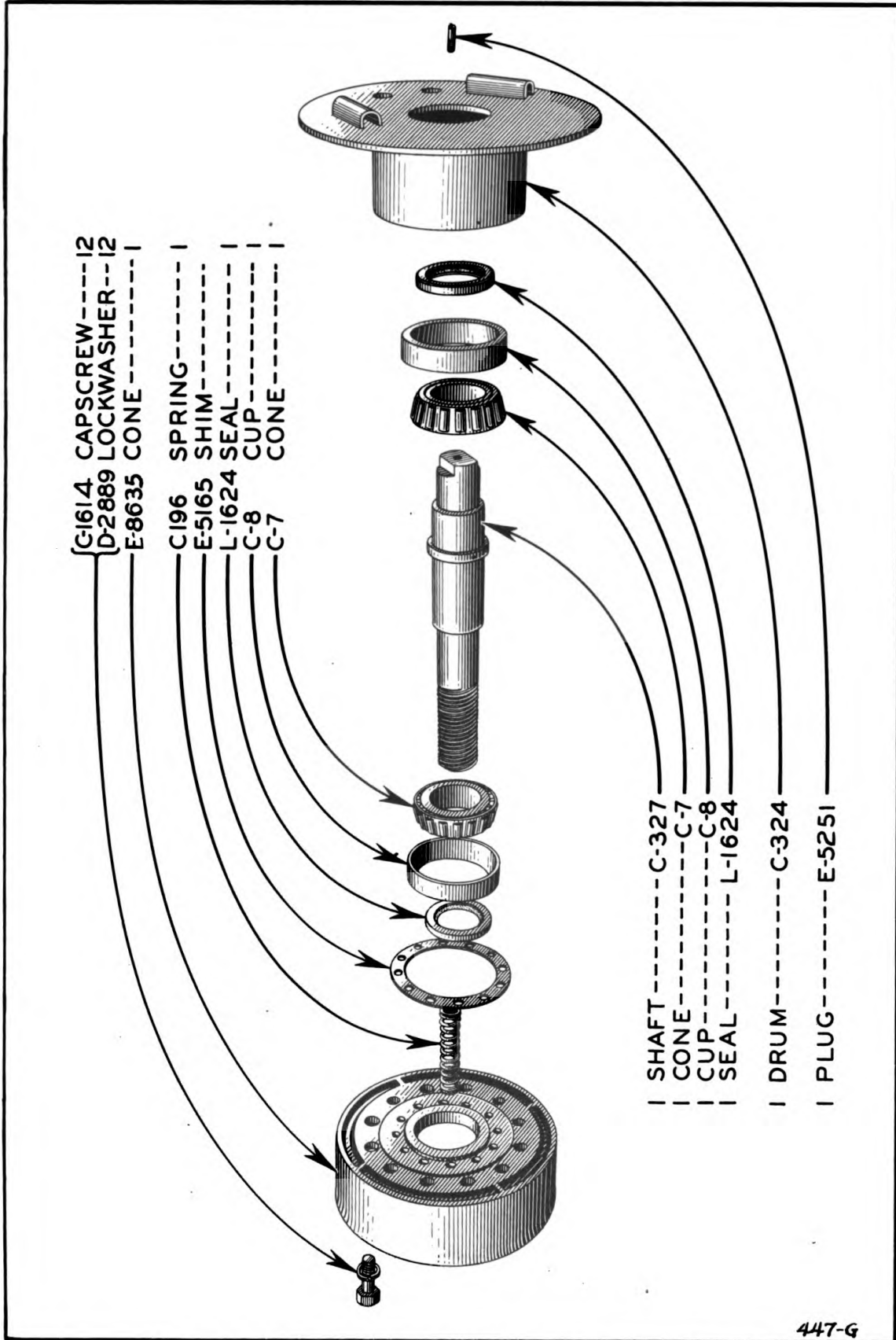

- | C1614 CAPSCREW --- I2
- | D2889 LOCKWASHER --- I2
- | E8635 CONE ----- |
- | C196 SPRING ----- |
- | E5165 SHIM ----- |
- | L1624 SEAL ----- |
- | C-8 CUP ----- |
- | C-7 CONE ----- |

- | SHAFT ----- C-327
- | CONE ----- C-7
- | CUP ----- C-8
- | SEAL ----- L-1624
- | DRUM ----- C-324
- | PLUG ----- E-5251

447-G

CABLE DRUM GROUP

Generated on 2017-03-09 11:50 GMT / http://hdl.handle.net/2027/uc1.b3241428
 Public Domain, Google-digitized / http://www.hathitrust.org/access_use#pd-google

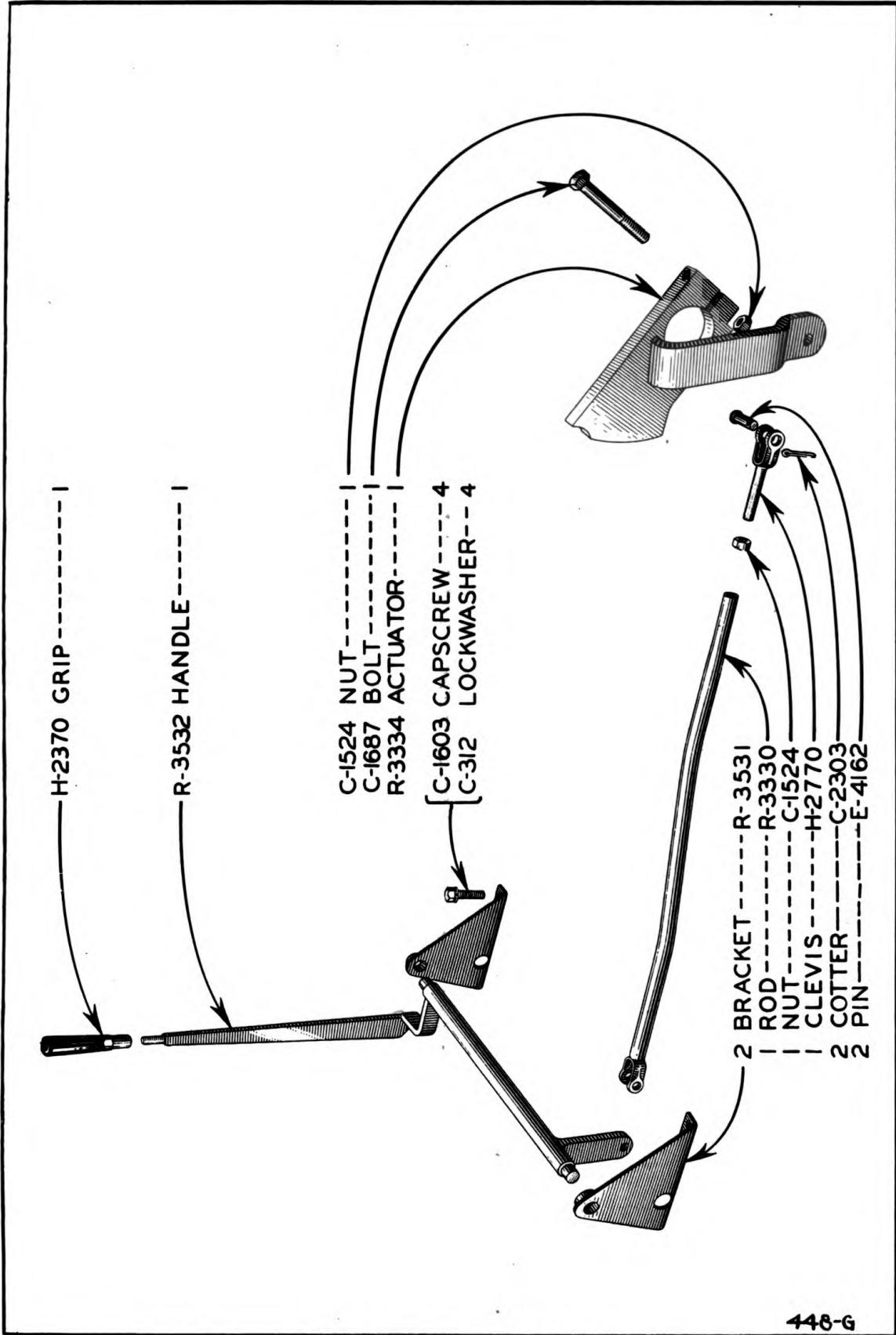

HANDLE GROUP

448-G

MODEL HN POWER UNIT

9

MODEL HN POWER UNIT

PART No.	DESCRIPTION	PAGE	QTY.	WEIGHT		Price Each
				Lbs.	Oz.	
C-7	CONE—TIMKEN # 559.....	1, 1A, 4, 7	4	2	10	4.56
C-8	CUP—TIMKEN # 552-A.....	1, 1A, 4, 7	4	1	10	3.39
C-9	CAP—FOR REAR PLATE.....	1, 1A, 2, 2A	1	2	..	1.30
C-18	BEARING—HYATT #RA-210.....	1, 1A, 4	1	..	12	1.71
C-32	PIN.....	3	425
C-40	LINING—FOR CLUTCH CONE.....	4	1	2	4	5.56
*C-86	CONE—DRIVING—(LINED WITH MANVILLE).....	1, 1A, 4	1	22	..	26.55
C-100	BUSHING.....	1, 4	1	2	..	2.80
C-189	COVER PLATE.....	1, 1A, 2, 2A	1	12	..	9.63
C-192	LINING—FOR BRAKE.....	3	1	1	8	2.29
C-196	SPRING.....	1, 1A, 7	151
C-206	NUT.....	1, 1A, 4	1	3	8	13.95
C-218	LINK.....	3	2	..	6	.26
		1, 1A, 2, 2A,				
C-312	LOCKWASHER— $\frac{3}{8}$ ".....	5, 6, 8	3701
C-324	DRUM.....	1, 1A, 7	1	25	8	19.89
C-327	SHAFT.....	1, 1A, 7	1	17	12	18.69
C-640	PLATE.....	2, 2A	1	1	..	.78
C-1034	PLUG— $\frac{1}{4}$ " PIPE.....	2, 2A	2	..	12	.17
C-1524	NUT— $\frac{1}{2}$ " NF HEX.....	1, 1A, 3, 8	503
C-1531	NUT—1" NC HEX.....	1, 1A, 2, 2A	111
C-1532	NUT—1" NF HEX.....	2, 2A	211
C-1539	LOCKWASHER— $\frac{3}{8}$ ".....	1, 1A	2301
C-1540	LOCKWASHER— $\frac{1}{2}$ ".....	1, 1A, 2, 2A	201
C-1544	LOCKWASHER—1".....	1, 1A, 2, 2A	107
C-1547	WASHER— $\frac{3}{8}$ " CUT.....	2, 2A	275C
C-1548	WASHER— $\frac{7}{16}$ " CUT.....	2, 2A	275C
C-1555	COTTER— $\frac{5}{32}$ " x 1".....	3	801
		1, 1A, 2, 2A,				
C-1601	CAPSCREW— $\frac{3}{8}$ " x $\frac{3}{4}$ " NC.....	5, 6	2803
C-1602	CAPSCREW— $\frac{3}{8}$ " x 1" NC.....	2, 2A, 8	1403
C-1603	CAPSCREW— $\frac{3}{8}$ " x $1\frac{1}{4}$ " NC.....	8	403
C-1613	CAPSCREW— $\frac{1}{2}$ " x $1\frac{1}{4}$ " NC.....	1, 1A, 4, 7	1206
C-1614	CAPSCREW— $\frac{1}{2}$ " x $1\frac{1}{2}$ " NC.....	1, 1A	1406
C-1615	CAPSCREW— $\frac{1}{2}$ " x $1\frac{3}{4}$ " NC.....	1, 1A, 2, 2A	206
C-1620	CAPSCREW— $\frac{1}{2}$ " x 3" NC.....	1, 1A, 2, 2A	211
C-1667	CAPSCREW—1" x $2\frac{1}{2}$ " NC.....	1, 1A, 2, 2A	1	..	12	.43
C-1687	CAPSCREW— $\frac{1}{2}$ " x $3\frac{1}{2}$ " NF.....	1, 1A, 3, 8	2	..	4	.12
C-2303	COTTER— $\frac{3}{8}$ " x 1".....	8	201
C-2509	PLUG— $\frac{3}{4}$ ".....	2, 2A	110
C-5801	CAPSCREW.....	1, 1A, 2, 2A	1003
C-8310	$\frac{3}{8}$ " x $1\frac{1}{4}$ " NF.....	2, 2A	1	..	8	.23
D-2889	LOCKWASHER— $\frac{1}{2}$ " SHAKEPROOF.....	1, 1A, 4, 7	2401
D-4322	NUT.....	1, 1A, 3	1	..	8	.37
D-4429	CONE—TIMKEN # 14136.....	1, 1A, 3	2	..	8	1.32
D-4431	CLOSURE—FELT.....	1, 1A, 3	2	..	4	.26
D-4432	CUP—TIMKEN # 14274.....	1, 1A, 3	2	..	2	.47
*D-7053	CONE—DRIVING (LINED WITH VELVETOUCH).....	4	1	28	..	37.58
*D-7054	BAND—BRAKE (LINED WITH VELVETOUCH).....	3	1	6	..	15.75
*D-7134	BAND—BRAKE (LINED WITH MANVILLE).....	1, 3	1	5	8	9.89
D-8685	$1\frac{1}{4}$ " ELL—45°.....	2, 2A	1	1	..	.43
E-4132	COTTER— $\frac{1}{2}$ " x 2".....	1, 1A, 3	101
E-4162	PIN.....	8	1	..	2	.26
E-5165	SHIM—34 GAUGE.....	710
E-5251	PLUG— $\frac{1}{8}$ ".....	1, 7	105
E-8618	SHIM—.007.....	410
E-8635	CONE—DRIVEN.....	1, 1A, 7	1	38	..	42.20

474-G

SPARE PARTS & PRICE LIST

MODEL HN POWER UNIT

10

F-267	ROLLER	1, 1A	1	1	4	.73
H-745	COTTER—3/32" x 3/4"	2, 2A	101
H-2209	SHAFT	1, 1A, 3	1	4	10	3.87
H-2370	GRIP—FOR HANDLE.....	8	1	..	6	1.07
H-2770	CLEVIS	8	1	8	..	.82
H-2819	GASKET	1, 1A	155
L-1624	SEAL	1, 1A, 7	266
L-1648	SEAL—#335212	1, 1A, 4	160
L-3725	SEAL—SPECIAL	1, 1A, 4	1	..	3	.60
L-37050	SEAL—SPECIAL	1, 1A, 2, 2A	1	2	..	7.35
R-27	CAPSCREW	2, 2A	1	..	4	.50
R-2020	SPRING	3	1	..	4	.81
R-2294	PIN	1, 1A	1	..	4	.40
R-3322	GEAR—MAIN	1, 1A	1	52	..	54.05
R-3324	BUSHING	1, 1A, 6	1	1	..	3.22
R-3325	GEAR—PRIMARY IDLER	1, 1A, 6	1	16	..	20.43
R-3327	BUSHING	1, 1A	1	1	..	3.22
R-3328	GEAR—SECONDARY IDLER.....	1, 1A	1	5	..	12.13
R-3329	BUSHING	1, 1A, 3	1	10	..	1.82
R-3330	ROD—CONTROL	8	1	2	..	2.45
R-3331	ROLLER ARM ASSEMBLY (INCLUDES R-2294, F-267, AND R-3332).....	3	1	4	..	4.20
R-3332	ARM	1, 1A, 4	1	3	..	3.07
R-3333	LINK	3	1	..	10	.62
R-3334	ACTUATOR	8	1	7	..	4.97
R-3335	PIN	1, 1A	1	3	..	8.68
R-3336	PIN	1, 1A, 6	1	2	..	1.85
R-3337	LOCK PLATE	1, 1A, 6	120
R-3528	GASKET	1, 1A	110
R-3529	PLUG	1, 1A, 6	109
R-3531	BRACKET	8	2	3	4	3.25
R-3532	CONTROL SHAFT	8	1	8	..	5.80
R-3533	GUARD	1, 1A, 2, 2A	1	18	..	7.45
R-3534	SUPPORT—FOR DRUM.....	2, 2A	1	20	..	16.50
R-3536	CASE STRUCTURE.....	1, 1A, 2, 2A	1	124	..	95.05
R-3543	GASKET	2, 2A	109
R-3544	GASKET	1, 2	1	..	1	.40
R-3774	CAPSCREW—DRILLED	2, 2A	111
R-3775	LOCK BAR.....	2, 2A	1	1	..	.63
R-4386	LOCKWASHER	2, 2A	104
R-4403	STUD	2, 2A	1	5	4	2.80
R-4873	GASKET	1A, 2A	140
*C-86	DRIVING CONE—INCLUDES FOLLOWING:					
E-5282	CONE		1	20	..	20.50
C-40	DRIVING CONE LINING—MANVILLE.....		1	2	4	5.56
K-2260	RIVETS		2380C
*D-7053	DRIVING CONE—INCLUDES FOLLOWING:					
F-7143	CONE		1	20	..	20.50
D-2614	LINING—VELVETOUCH		1	5	8	16.52
H-7071	RIVETS		42	2.50C
*D-7054	BRAKE BAND—INCLUDES FOLLOWING:					
D-7166	BAND		1	4	..	7.00
D-2613	BRAKE LINING—VELVETOUCH.....		1	3	8	8.19
H-3495	RIVETS		48	1.80C
*D-7134	BRAKE BAND—INCLUDES FOLLOWING:					
D-7166	BAND		1	4	..	7.00
C-192	LINING—MANVILLE		1	1	8	2.29
D-3679	RIVETS		21	1.80C

475-G

SPARE PARTS & PRICE LIST

