

TECHNICAL REPORT
NATICK/TR-84/022

AD _____

AD-A149 244

DRAFT TECHNICAL MANUAL FOR TENT, EXTENDABLE, MODULAR, PERSONNEL (TEMPER)

BY
ARTHUR G. CARR
DONALD M. STEWARDSON
DONALD B. SHAW
THOMAS D. LARKHAM
JOSEPH A. R. O'BRIEN

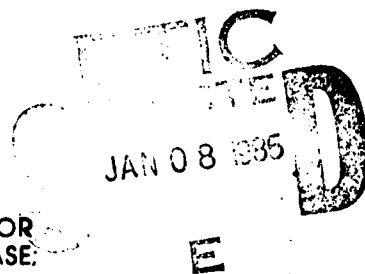

APPROVED FOR
PUBLIC RELEASE;
DISTRIBUTION
UNLIMITED.

MAY 1984

UNITED STATES ARMY NATICK
RESEARCH & DEVELOPMENT CENTER
NATICK, MASSACHUSETTS 01760



OTIC FILE COPY

AERO-MECHANICAL ENGINEERING LABORATORY

APPROVED FOR PUBLIC RELEASE; DISTRIBUTION UNLIMITED.

CITATION OF TRADE NAMES IN THIS REPORT DOES NOT
CONSTITUTE AN OFFICIAL ENDORSEMENT OR APPROVAL OF THE
USE OF SUCH ITEMS.

DESTROY THIS REPORT WHEN NO LONGER NEEDED. DO NOT
RETURN IT TO THE ORIGINATOR.

PREFACE

This manual is for the use of personnel responsible for the operation and maintenance of the Tent, Extendable, Modular, Personnel (TEMPER). The manual provides the user and maintenance personnel with the necessary instructions to use the shelter and to perform required maintenance services. The manual was initiated for use by the Surgeon General (Project Number 1E464713DL40) but is applicable to all users of the TEMPER. The final draft was completed in June 1983 and revisions have been made since that date. I would like to thank everyone involved with the TEMPER for help in determining the easiest procedures and simplest instructions for all future users. I would especially like to thank Pam Churchill for her patience and determination in typing the numerous revisions.

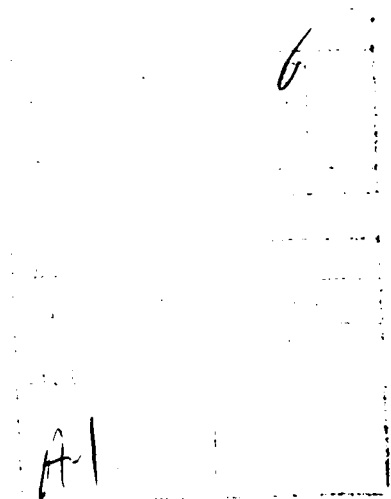

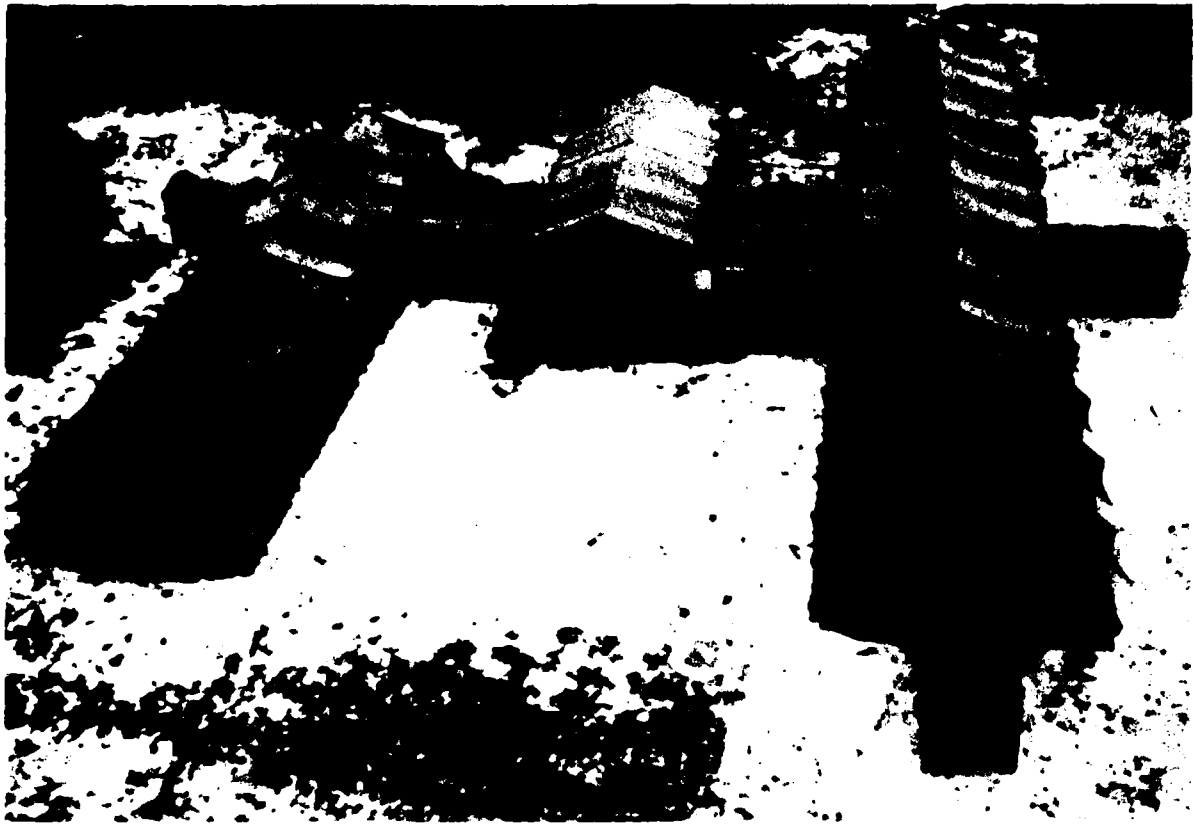

TABLE OF CONTENTS

	Page
INTRODUCTION	1
Purpose	1
Forms, Records, and Reports	1
Reporting of Improvements	1
Description	1
COMPONENTS	1
Frame Assembly	4
Arch	4
Header	4
Purlins	4
Covers and Extenders	4
Roof Section	4
Endwall	4
Fly	4
Extenders	5
Liners	5
Locking Pins	5
Tie Tapes	5
Hook and Pile Fastener	6
Anchoring Pins	6
Hitch Clip Pins	6
Vestibule	7
Plenums	8
INSTALLATION AND OPERATING INSTRUCTIONS	8
Inspection on Receipt	8
Personnel Requirements	8
Site Selection	8
Ground Plan	8
Step Procedure to Lay Out Tent	11
Frame Assembly	13
Step Procedure to Assemble Frame	13
Purlins	13
Step Procedure to Connect Ridge Purlin	14
Step Procedure to Connect Additional Sections with Purlins	14
Roof Sections	18
Step Procedure to Position Roof Section	18
Step Procedure for Becket Lacing	19

TABLE OF CONTENTS (Cont'd)

	Page
Ridge Extender	21
Step Procedure to Position Ridge Extender	21
Fly	21
Step Procedure to Position and Lace Flies	22
Step Procedure to Attach Fly Guide Line, Cover Roof, and Position Fly on Eave Extender Spindle	23
Raising the Frame	25
Step Procedure to Raise the Frame (Side One)	26
Step Procedure to Raise the Frame (Side Two)	28
Final Procedures	29
List of Final Procedures	29
 STRIKING PROCEDURES	 29
Vestibule	29
Step Procedure to Strike Vestibule	29
Tent Disassembly	30
Step Procedure to Strike Tent	30
Frame Disassembly	32
Step Procedure to Strike Frame	32
 ACCESSORIES	 32
Single-Ply Floor	32
Distribution Box	33
Step Procedure to Install Distribution Box	33
Light Cables	33
Step Procedure to Route Light Cables	33
Light Bars	37
Step Procedure to Install Light Bars	37
Outlet Cables	37
Step Procedure to Install Outlet Cables	37
Liner	38
Step Procedure to Install Liner	39
Plenums	40
Step Procedure to Install Plenums	40
Lights	41
Step Procedure to Install Fluorescent or Bruce Lights	41
Incandescent lights	42
Vestibule	42
Step Procedure to Erect a Vestibule	42
Step Procedure to Install Vestibule Door for Entryway	46
Step Procedure to Install Blackout Curtain	47
Step Procedure to Install Bump-Through Door in End Section	48
Step Procedure to Install Bump-Thorough Doors in Door Section or Vestibule	49

TABLE OF CONTENTS (Cont'd)

	Page
Modesty Curtain	51
Step Procedure to Install Modesty Curtain	51
MOVEMENT TO A NEW WORKSITE	52
OPERATION OF FIXTURES	53
Door Rollup	53
Vestibule Adapter Rollup	53
Window Rollup	53
Ventilation	53
Step Procedure to Roll up Endwall	53
Roof Vents	54
Endsection Vents	54
OPERATION UNDER WEATHER/CLIMATE EXTREMES	55
Wet Climate	55
Operating in Snow	55
Operation in High Wind	56
OPERATOR'S MAINTENANCE INSTRUCTIONS	56
Manual, Tools and Equipment	56
Lubrication	56
Preventive Maintenance Checks and Services	56
Maintenance Allocation Chart	58
TEMPER TENT ERECTION CHECKLIST	59

LIST OF FIGURES

Figure	Page
1. TEMPER coverings	2
2. TEMPER frame	3
3. Ridge joint	5
4. Securing pin in frame arch	5
5. Wooden stake and steel pin anchors	6
6. Hitch clip pin	6
7. Hitch clip pin secured	6
8. Vestibule used as entryway	7
9. Vestibule used as connector	7
9a. Shelters module plan	10
10. Frame in cover	12
11. Frame components	12
12. Frame arch and header eave joints, ridge joint, base plate header	12
13. Worker securing locking pin in ridge joint	12
14. Header flange and locking pin	13
15. Securing header with locking pin	13
16. Purlin and door purlin	14
17. Aligning tab of ridge purlin with boss	15
18. Aligning tab of diagonal brace	15
19. Insert tab with slot in arch	16
20. Rotate tab handle	16
21. Bend tab handle towards arch	16
22. Tab handle locked in place	16
23. Frames laid parallel	17

LIST OF FIGURES (Con't)

Figure	Page
24. One section with all five purlins	17
25. Two sections with purlins	17
26. Three sections with purlins	17
27. Door section (underneath)	18
28. Window section (underneath)	18
29. Place grommets of section on ridge spindles	18
30. Becket lacing	19
31. Endwall fabric	19
32. Lacing procedure	19
33. Pull the lace back towards the ridge	20
34. Half hitch knot	20
35. Tie off procedure	20
36. Ridge extender guy line	21
37. Sixteen foot fly (top)	22
38. Guy line through webbing loops	23
39. Flies rolled toward their centerline	23
40. Eave extender with guy line and slip	25
41. Correct kneeling position	26
42. Push up frame, pull in leg	27
43. 120 Volt distribution box "A"	34
44. Three phase distribution box "B"	35
45. Insert the bolts of the box through the slots of the plate	36
46. Distribution box and stand is located between the liner and the endwall on the left	36

LIST OF FIGURES (Con't)

Figure	Page
47. Connect the strap of the outlet to the arch frame above the diagonal brace	36
48. Distribution box fits through hole in liner	36
49. Slide light hanging straps over end clip	37
50. Attach light bar to header	37
51. Connect black liner clips	38
52. Liner with center ties attached	38
53. Light strap inserted through liner	39
54. Section through tent showing liner and plenums	40
55. Fluorescent (bruce lights) stringer	41
56. Secure velcro around end of fixture	41
57. Incandescent light stringer	42
58. Vestibule used as entrance way	43
59. Vestibule as connector	43
60. Becketing the vestibule to the extender	44
61. Inserting the hitch pin in the frame spindle	45
62. Pulling the vestibule tension strap tight	46
63. Bump through doors with extenders	48
64. Bump through doors with vestibule arch installed	48
65. Bump through doors installed	50
66. Modesty curtain installed	50
67. Squared-off hooks placed over header	51
68. Peak vent tied open	54
69. Roof vents of desert/tropical TEMPER with fly removed	54
70. Vestibule adapter rolled up and ties at top of door	54
71. Windows are rolled up towards the inside and ties at the top	54

LIST OF TABLES

Table		Page
1	Components	1
2	Operator/Crew preventive maintenance checks and services	57
3	Maintenance Allocation	58

TENT, EXTENDABLE, MODULAR, PERSONNEL

INTRODUCTION

Purpose

This manual is for the use of personnel responsible for the operation and maintenance of the tent, extendable, modular, personnel (TEMPER). It provides the user and maintenance personnel with the necessary instructions to use the shelter and to perform required maintenance services in accordance with the Maintenance Allocation Chart on page 59.

Forms, Records, and Reports

The maintenance forms, records and reports will be maintained in accordance with the procedure outlined in TM-38-750.

Reporting of Improvements

The direct reporting of errors, omissions, and recommendations for improving this manual is authorized and encouraged. DA Form 2028 (Recommended Changes to DA Publications) will be used for reporting these improvements. This form will be completed in triplicate using pen, pencil or typewriter and will be forwarded direct to Commander, US Army Natick Research and Development Center, ATTN: STRNC-USO, Kansas Street, Natick, MA 01760.

Description

The TEMPER (Tent, Extendable, Modular, Personnel) is a frame-supported modular tentage system which can be quickly assembled and disassembled without tools and while using gloves. This tent is 20 feet wide, extendable in 8 feet lengths and provides an unobstructed floor area of indefinite length.

Vestibules may be used to connect sides or ends of the tent together or make breaks in the tentage complex. The tent is available with lights, liners, insulated floors, adjustable screens, a fly and environmental control units for maximum flexibility and comfort. Two sections of a TEMPER with a floor area of 320 square feet can be transported in a 3/4 ton truck and erected by four men in 20 minutes.

This manual provides instructions on the erection of any number of sections of the TEMPER. This procedure will be explained by giving instructions on one eight foot section. When any instruction is given, the reader should assume it applies to every section.

COMPONENTS

The main components of the TEMPER are frame, fabric covers and accessories. To identify the following components refer to Figure 1 (TEMPER Coverings) and Figure 2 (TEMPER Frame).

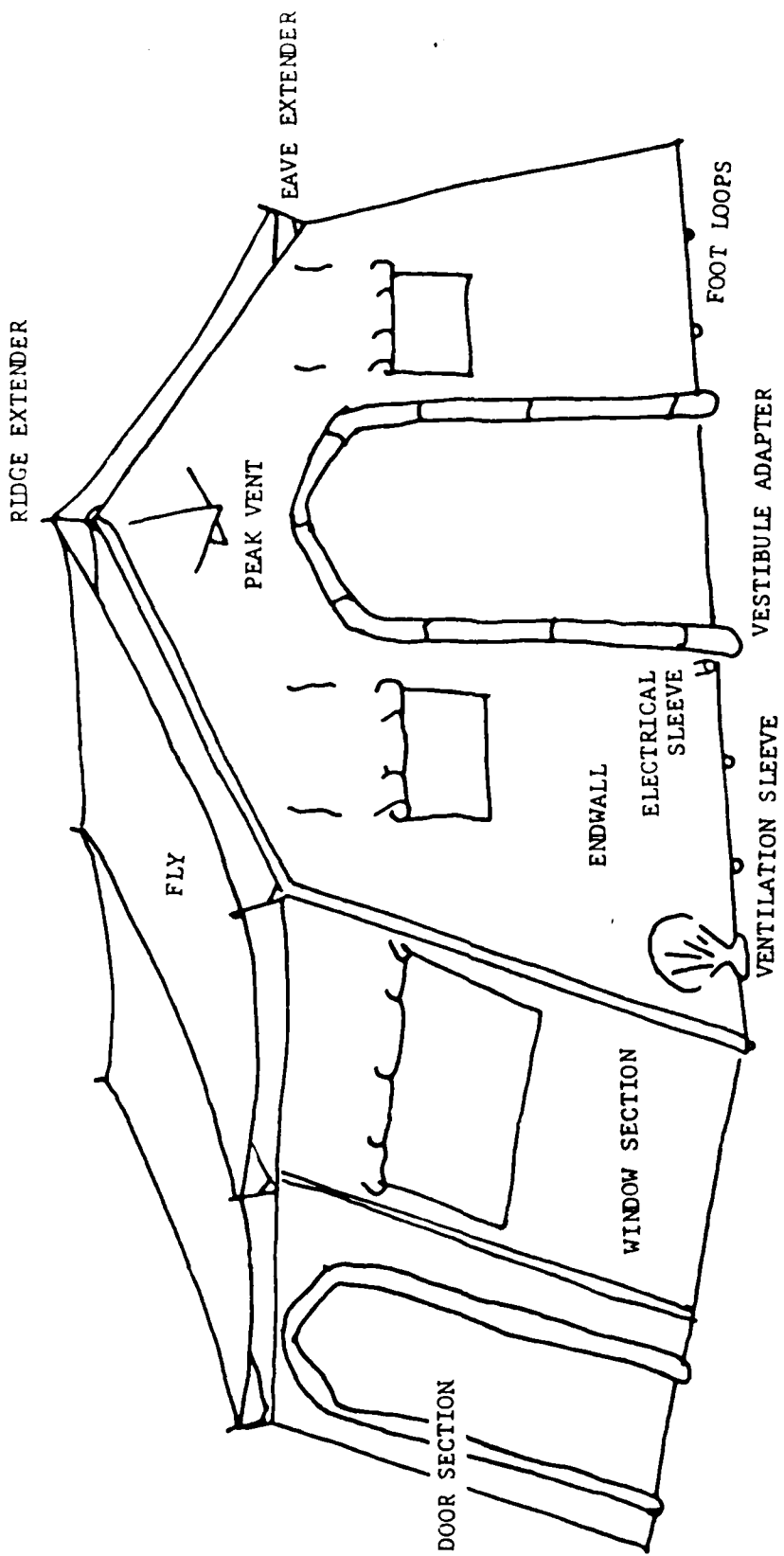

Figure 1. TEMPER coverings

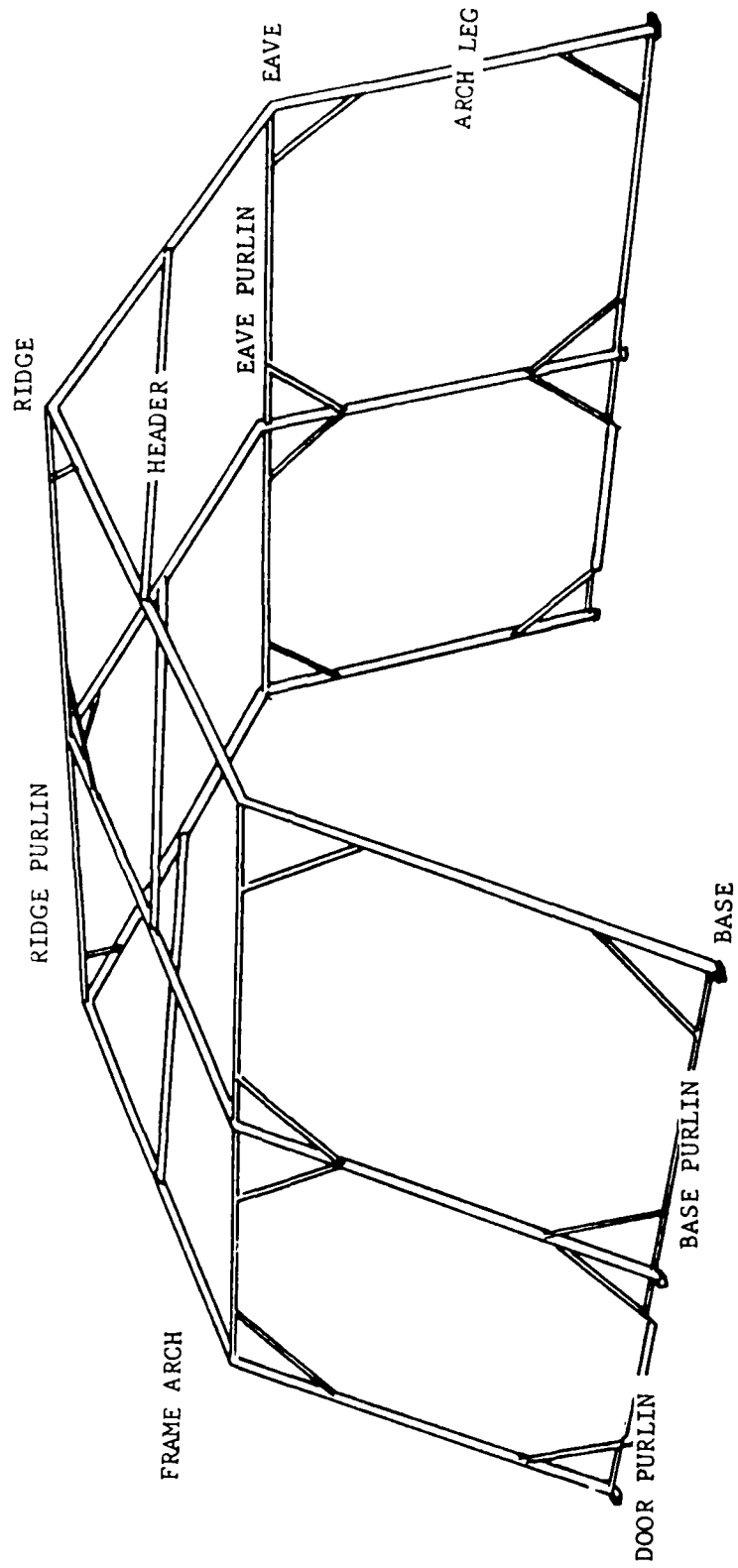

Figure 2. TEMPER frame

Frame Assembly

The frame assembly of the TEMPER is made of three different parts: the arch, the header, and the purlin. (Figure 2)

Arch. The arch is made of four pieces of rectangular tubing connected with hinge joints. There is a central or ridge joint and two side or eave joints. The joints allow the frame to be locked in place with pins. At either end of the arch are base plates. The base plates have a spike underneath and a hole on the outside to pin the frame to the ground.

Header. The header spans across the frame above the eave joints. The header gives additional stiffness to the frame and also locks in place with pins.

Purlins. The purlins are used to connect each of the arches to one another. There are five purlins in each eight foot section; one purlin at the ridge joint, one at each eave joint, and one at each base plate. Door purlins are placed at the base plate of a section where a door will be located. A door purlin has a flat center to act as a sill. Both the standard purlins and the door purlins have diagonal braces that lock into the arch.

Covers and Extenders

The fabric covers for the frame of the TEMPER are roof sections, endwalls flies and liners. The roof sections and liners are made in two versions: temperate and the desert/tropical. The fly is suspended over the roof by extenders.

Roof Sections. The roof sections cover the top and sides of the TEMPER frame and are made in eight foot sections which lace together. There are window roof sections and door roof sections each in a desert/tropical or temperate version. The temperate window sections have windows on either side, stove pipe openings on one side of the roof and duct openings on the other side under the window. Temperate door sections have doors on either side and no other openings. The desert/tropical window and door sections have windows or doors on either side and controllable vents in the roof.

Endwall. The endwall of the TEMPER has a door in the center and windows on either side. There is a large sleeve on the left side for a heating or air conditioning vent and a small sleeve to the left of the door for electrical wiring. These sleeves can be tied off to make a tight seal. There is a vent at the peak which may be tied open or closed by the lines on either side.

Fly. The fly on the TEMPER is a layer of fabric which is suspended one foot above the roof section. In cold weather the fly will keep rain and snow off of the roof section to prevent condensation and to keep the interior of the tent warm. In a desert or tropical climate the fly will keep the sun off the roof and allow air to circulate through the vents in the top of the roof sections.

Extenders. Extenders hold the fly above the roof section. Each TEMPER frame has three extenders. Each of these are locked in place with a hitch clip pin; one on each eave joint spindle and one at the ridge joint spindle. A grommet on the fly is slipped over the extender and held in place with a hitch clip pin.

Liners

The liners of the TEMPER are made of light-colored, machine washable fabric. The liners act as insulation to make the tent cooler in summer and warmer in winter. The liners reflect light better than the roof blanket and because they are washable makes it possible to keep a clean environment at all times. The liners are made in eight foot sections which are tied to the frame and attached to each other with hook and pile fasteners.



Figure 3. Ridge joint



Figure 4. Securing pin in frame arch

Locking Pins

The frame of the TEMPER has three joints each with locking pin to hold it position. The pins are attached to the joint with a wire cable. To use: simply align the holes in the frame joint and insert the pin.

Tie Tapes

Tie tapes are used in the TEMPER to tie the fabric to the frame and many other places. When using tie tapes, always tie with a bow to allow the knot to be untied easily.

Hook and Pile Fastener

A hook and pile fastener is a fastener system used frequently in the TEMPER. The fastener uses two different parts; one strip of webbing with small plastic hooks and another with loops. When the two strips are pressed together, the hooks and loops engage. The fastener may be disconnected simply by pulling it apart.

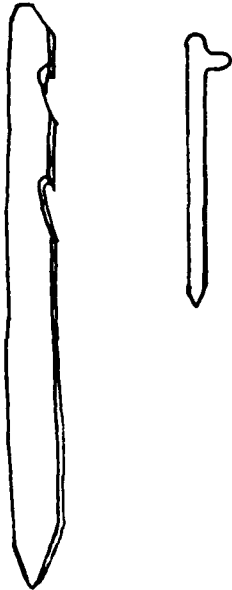

Figure 5. Wooden stake and steel pin achors

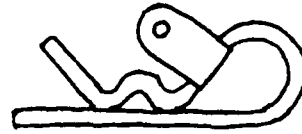

Figure 6. Hitch clip pin

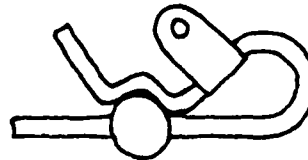

Figure 7. Hitch clip pin secured

Anchoring Pins

There are two types of pins used to anchor the TEMPER: 24 inch wooden stakes to anchor the guy lines and 12 inch steel pins to anchor the frame and foot loops. The wooden stakes are used for the guy lines and are always slanted towards the tent.

Hitch Clip Pins

Hitch clip pins are used in the TEMPER to hold grommets on spindles and to connect lightweight frames. The hitch clip pins are attached with cables to either the fabric sections or the framework where they will be used. To insert a pin, place the straight part of the pin in the hole. Press in with the heel of the hand until it locks in place at the bend.

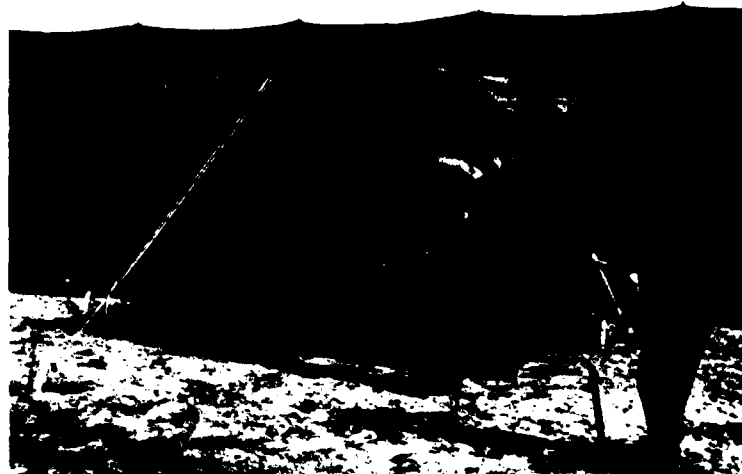

Figure 8. Vestibule used as entryway

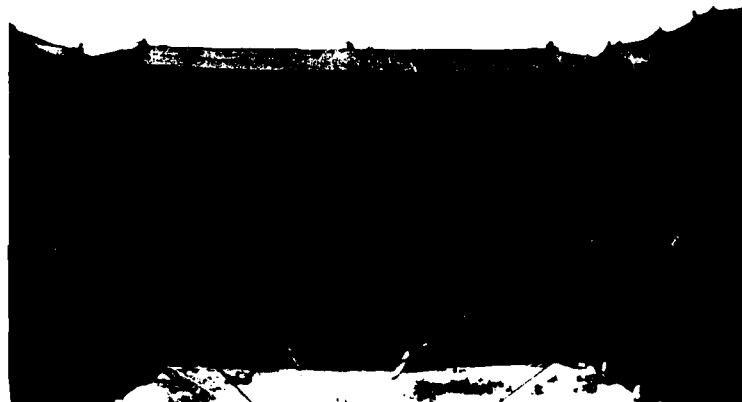

Figure 9. Vestibule used as connector

Vestibule

The vestibule is used to connect different sections of the TEMPER tent together or to connect a TEMPER tent to a hard shelter. A standard zip-up door, a bump-through door or a sliding black-out curtain may be installed in the vestibule. The one-piece vestibule fabric is becket laced to an adapter, which is sewed around the doorways of the TEMPER. The frame is made of three pieces, an arch and two legs, which are connected with hitch pins. The fabric covering is tied to the frame and staked to the ground.

Plenums

The plenums of the TEMPER are tubes used for directing conditioned air throughout the tent. They are made in 16 foot sections and are suspended in the center of the tent directly below the liner.

INSTALLATION AND OPERATING INSTRUCTIONS

Inspection on Receipt

Upon receipt, carefully inspect the shipping container for any damage that might have occurred during transport. Damage to the shipping container indicates damage may have occurred to the enclosed tent.

Inspect the unpacked tent to be sure all components are present. Use the tabulated data in Table 1 on page 9 to make a list of necessary items. To make your complex draw a layout diagram to help you in your siting requirements. Figure 9a is an example of a layout diagram.

NOTE: DURING INSTALLATION CAREFULLY INSPECT ALL COMPONENTS FOR BREAKAGE, HOLES AND TEARS, BROKEN OR MISSING STITCHING, MILDEW, OR EVIDENCE OF CORROSION. REPORT ANY DAMAGE TO THE PROPER AUTHORITY.

Personnel Requirements

Under average field conditions a 16 by 20 ft, two-section TEMPER may be set up in 20 minutes using a crew of four. For longer sections the minimum number of soldiers necessary is one more than the number of sections, for example, eight soldiers for a seven-section tent.

Site Selection

The site for the installation of the TEMPER tent should have appropriate access to the rest of the installation. The qualities of a good site are:

- Level
- Good drainage
- Free of rocks and underbrush
- Shelter from high winds

If drainage is questionable, the perimeter must be properly trenched. Clear all rocks and other debris, fill all holes and level all mounds in the area.

Ground Plan

Using your layout diagram as a guide, mark the placement of the frame arch bases along the side of the site. Sight along the markers to be sure that they are in line. Remember that there will be one frame every eight feet. If you are going to connect this tent to another using a vestibule, you must have the frames of the two tents in line.

COMPONENTS

A list of components is given in Table 1 below.

TABLE 1. Components

COMPONENT	WEIGHT (lb)	CUBE (ft)
End Section Frame	157	13.3
Extendable Section Frame	91	12.0
Extendable Door Section Frame	101	13.0
Vestibule Frame Assembly	30	3.0
End Section	44	3.0
Window Section Temperate	58	3.5
Window Section Desert/Tropical	60	3.6
Door Section Temperate	68	3.5
Door Section D/T	70	3.5
Fly 8'	25	1.5
Fly 16'	40	3.0
Single Ply Floor 8'	24	1.2
Insulated Floor 8'	48	10.0
Frame Cover	20	0.4
Tent Cover	11	1.0
Plenum Side Wall 16'	10	0.6
Plenum End Wall 16'	10	0.6
Plenum Extendable 16'	8	0.5
End Section Liner D/T	28	2.6
End Section Liner T	27	2.6
Intermediate Liner T	17	1.8
Intermediate Liner D/T	19	1.8
Liner Partition	8	0.75
Modesty Curtain	9	0.75
Vestibule w/Door	41	2.0
Vestibule Single Ply Floor	11	0.6
Vestibule Insulated Floor	15	2.0
Vestibule Container	5	0.3
Tent Pin Container	2	0.05
Distribution Box, Electrical	35	4.0
Distribution Box Stand	10	1.4
Electrical Outlets 8'	10	2.0
Extension Cord 25'	10	0.3
Bruce Lights	72	4.5
Light Support Bar Assembly	5	0.2
Pin, Tent, Steel 12"	1	0.01
Pin, Tent, Wood 24"	1	0.02
Tent Slips, Magnesium	0.2	

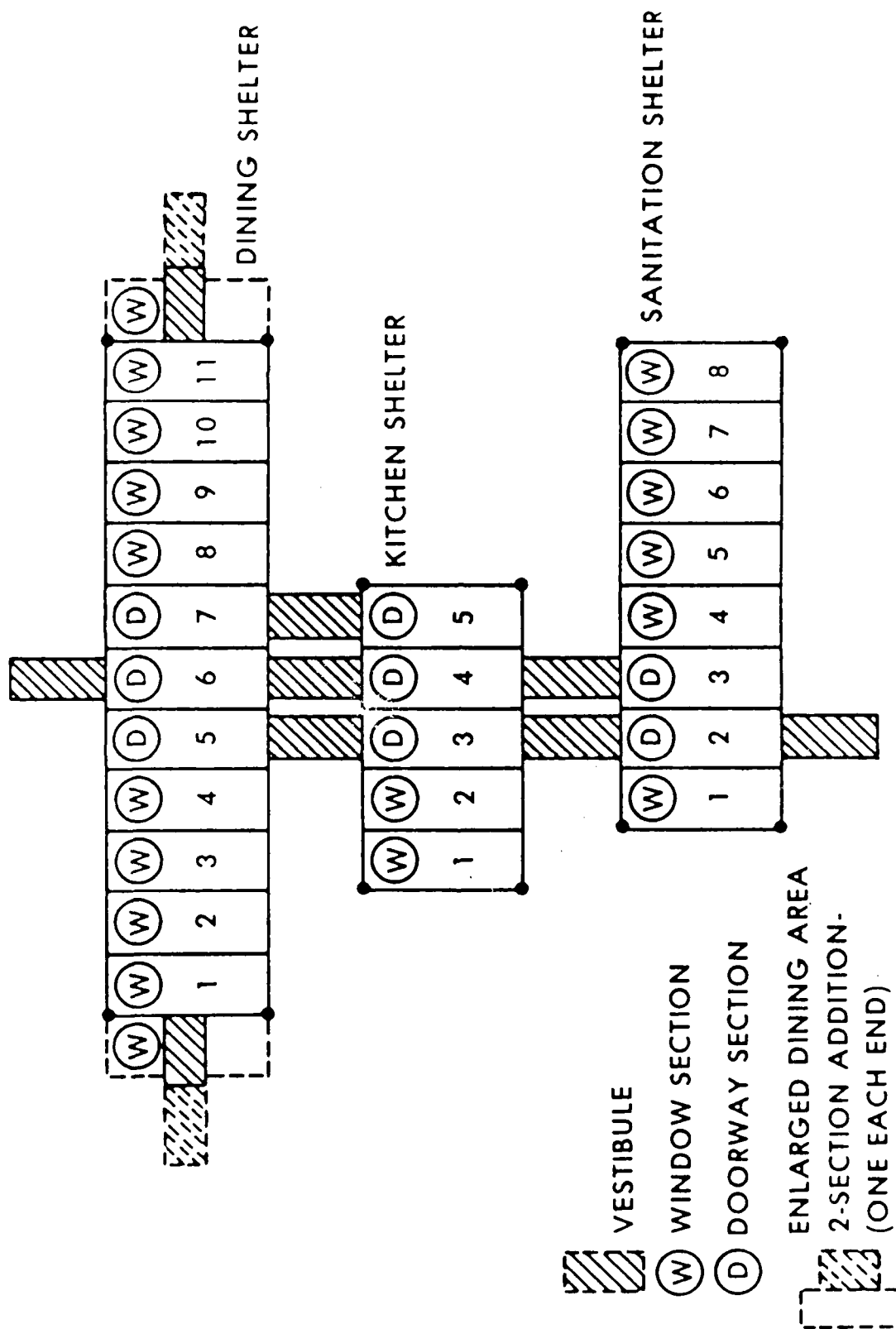

Figure 9a. Shelters module plan

Using the tabulated data (Table 1) and your plan, place the packaged sections on the site. The following step procedure is suggested.

Step Procedure To Lay Out Tent

1. Lay each frame bundle along the side of the site and in line with the pins and markers you have placed.
2. Place the roof sections in between the frame sections.
3. Place the endwalls at either end.
4. Place the flies at every other roof section.

NOTE: IF YOU HAVE AN ODD NUMBER OF SECTIONS, ONE FLY MUST BE EIGHT FT WIDE.

5. Place the liners next to the roof sections.
6. Place the end section liners next to the last roof section.

NOTE: THE ENDWALL LINERS WILL BE ATTACHED TO AN EIGHT FOOT INTERMEDIATE LINER.

To erect a two-section, 16 by 20 ft tent you would need the following parts.

FRAME:	3 Arches
	3 Headers
	10 Purlins
	6 Eave Extenders
	3 Ridge Extenders
COVERINGS:	2 Roof Sections
	1 16' Fly
	2 End Sections
	2 End Section Liners
	1 Endwall Plenum
COMPONENTS:	26 Steel Pins
	10 Wooden Stakes

To add one section to a two-section tent, you need the following parts.

FRAME:	1 Arch
	1 Header
	5 Purlins
	2 Eave Extenders
	1 Ridge Extender

COVERINGS:

- 1 Roof Section
- 1 8' Fly
- 1 Liner Section
- 1 16' Plenum

COMPONENTS:

- 6 Steel Pins
- 2 Wooden Guy Line Stakes

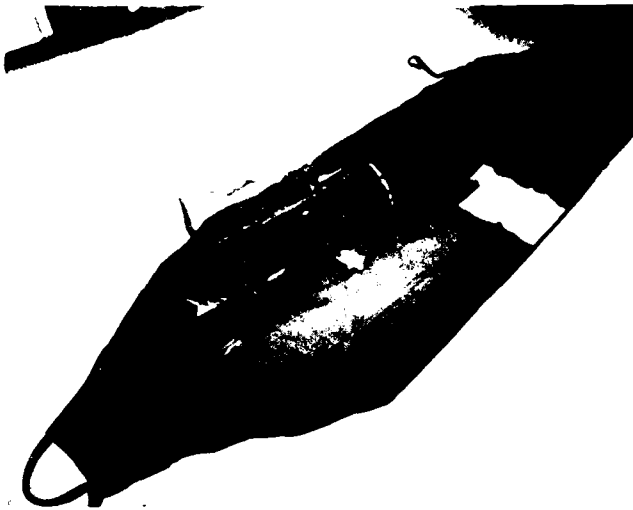

Figure 10. Frame in cover



Figure 11. Frame components



Figure 12. Frame arch and header



Figure 13. Worker securing locking pin in ridge joint

Frame Assembly

Step Procedure to Assembly Frame

1. Open the frame bundles.
Carry the arch to the center of site.
2. Remove all locking pins.
3. Loosen the strap and spread out the center of the frame.
4. Align the holes in the arch with the holes in the ridge joint and insert the locking pin.
5. Swing out the two legs of the arch.



Figure 14. Header flange and locking pin



Figure 15. Securing header with locking pin

6. Locate the header. The header will be pinned to the arch between the ridge and the eave joint.

7. Place the flanges on either end of the header around the arch and align the holes. The slanted end of the header faces up.
8. Place the locking pin through the holes in both sides to lock in place.

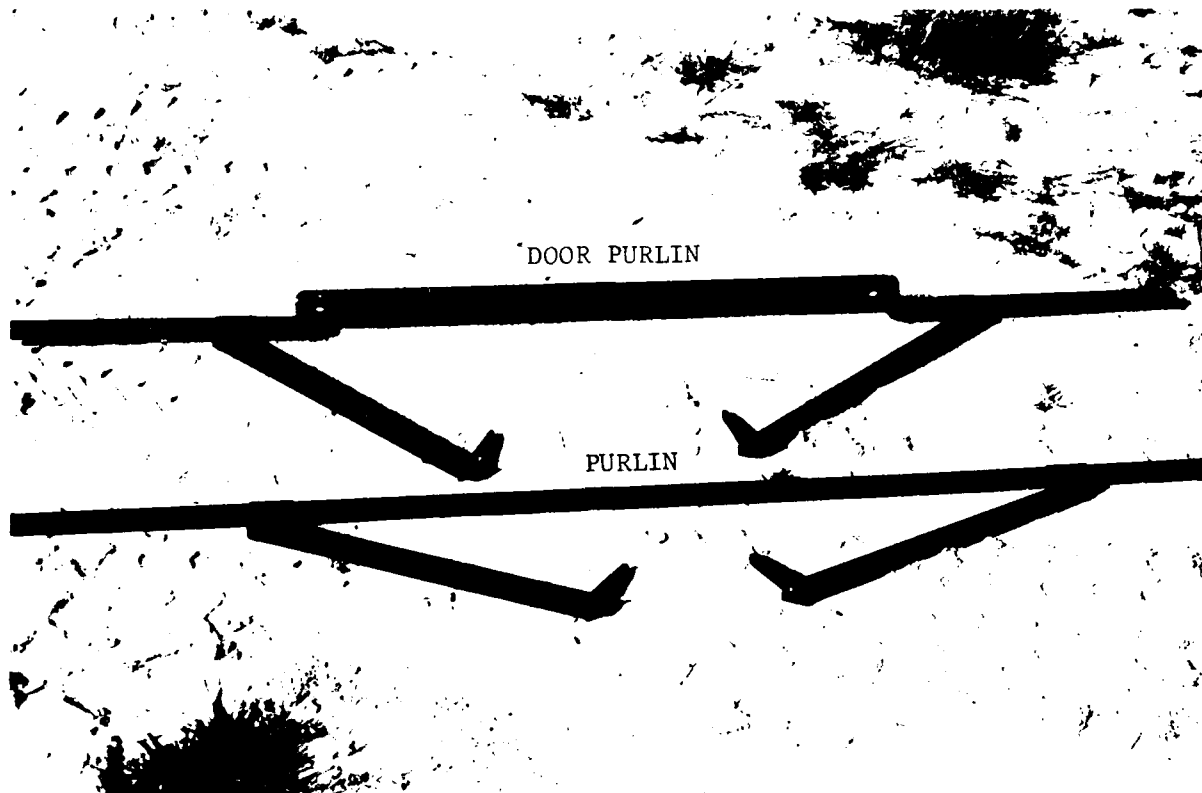

Figure 16. Purlin and door purlin

Purlins. After the headers are installed on all the arches, the next step is the installation of the purlins. There are two types of cross braces in the TEMPER: the purlin and the door purlin. As the name suggests, a door purlin is only necessary where a door will be placed. (A door purlin has a flat area to make it easier to step over).

The procedure for the connection of a purlin is always the same, except for the orientation of the diagonal braces.

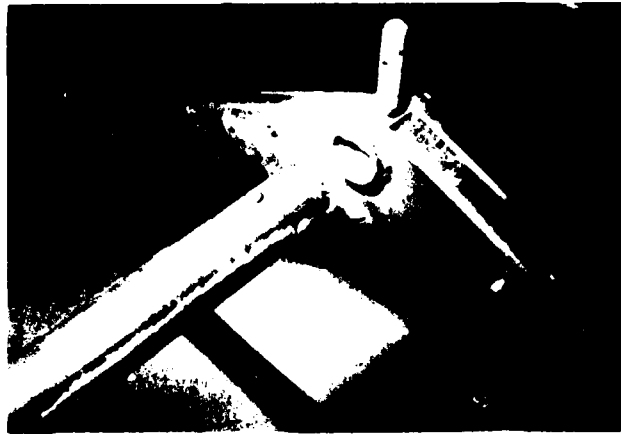

Figure 17. Aligning tab of ridge purlin with boss

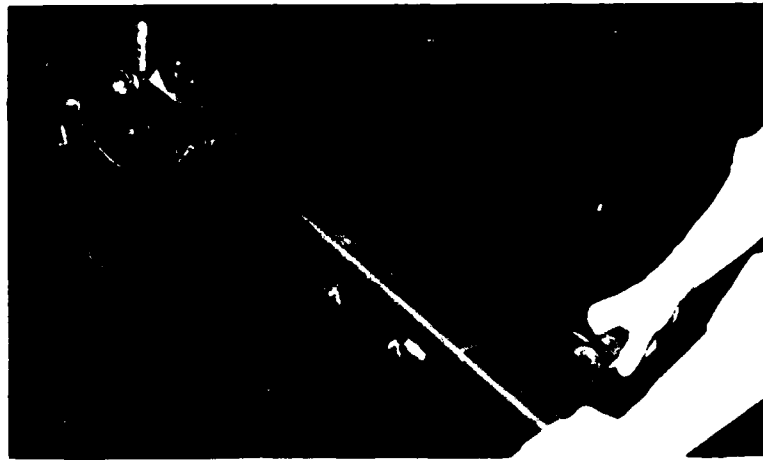

Figure 18. Aligning tab of diagonal brace

Step Procedure for Connecting Ridge Purlin

1. Two soldiers hold two arches upright at the ridge and hold a purlin in one hand between them.

NOTE: THE TWO ARCHES SHOULD BE PARALLEL.

2. Hold one end of a regular purlin and locate the tabs on either end.
3. Rotate the purlin so that the tab fits in the slot on the ridge joint.
4. Fit the tab in the boss, hold the diagonal brace, rotate it towards the arch.
5. On the end of the diagonal brace there is a tab and a tab handle. There is a slot on the arch about two feet from the ridge joint.



Figure 19. Insert tab with slot in arch

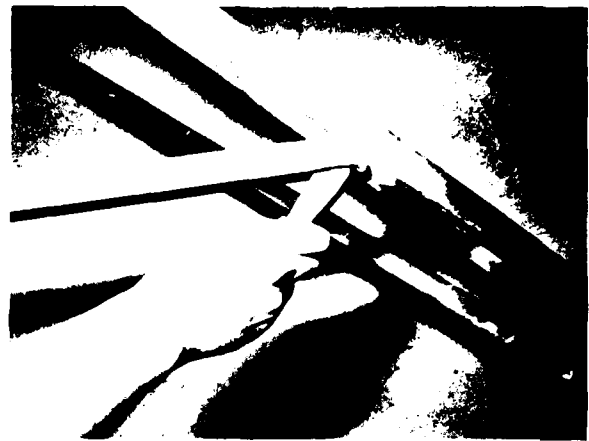

Figure 20. Rotate tab handle

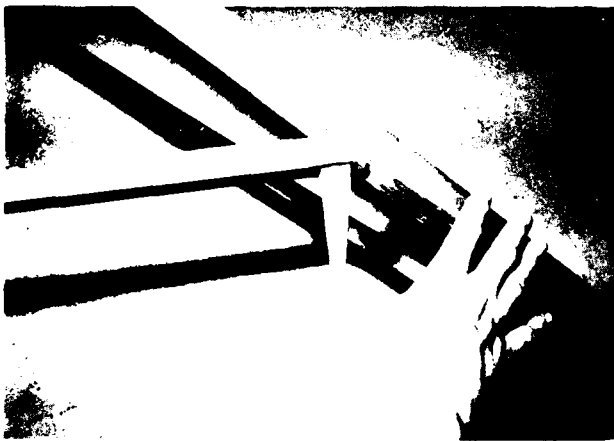

Figure 21. Bend tab handle towards arch



Figure 22. Tab handle locked in place

6. While holding the tab handle, align and place the tab in the slot of the arch.
7. Rotate the handle 90° to lock the tab in place.
8. Take the handle and bend it down towards the arch.

NOTE: IF THE HANDLE DOES NOT BEND EASILY, ROTATE 180° AND BEND TOWARDS ARCH.

NOTE: DO NOT BEND THE HANDLE TOWARDS THE DIAGONAL BRACE.

9. Using the same procedures, place purlins at each eave joint. Attach the diagonal brace to the legs of the arch.
10. The next step is the placement of the base purlins.

NOTE: LOOK AT YOUR FLOOR PLAN AND BE SURE THAT A DOOR PURLIN IS USED WHERE A DOOR WILL BE PLACED.

The installation for the base purlin is the same as the other purlins. The diagonal brace will be locked in slots about two feet up on the leg of the arch.

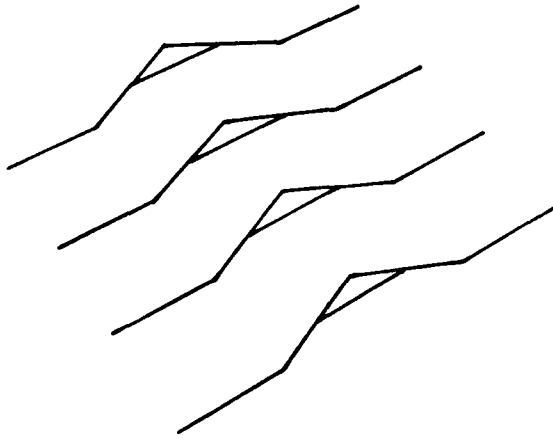

Figure 23. Frames laid parallel

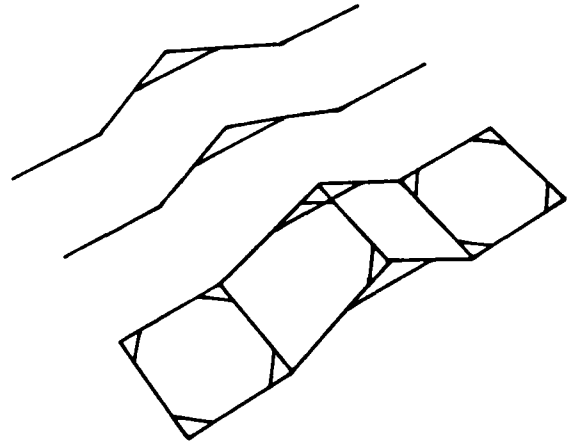

Figure 24. One section with all five purlins

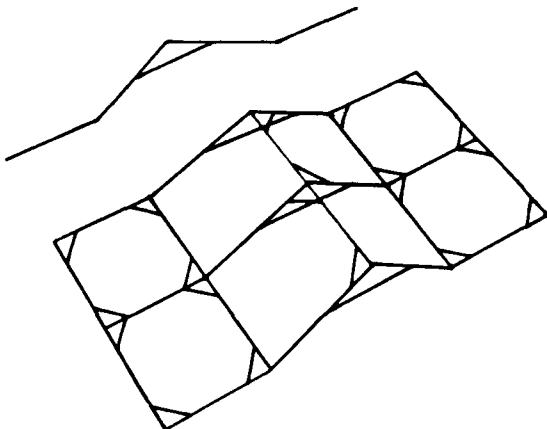

Figure 25. Two sections with purlins

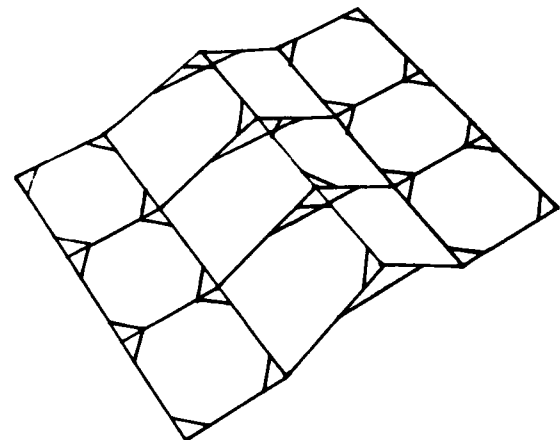

Figure 26. Three sections with purlins

NOTE: YOU NOW HAVE ONE EIGHT FOOT SECTION OF THE FRAME CONNECTED WITH FIVE PURLINS. PROP UP THE NEXT FRAME (THE HEADER WILL ALREADY BE ATTACHED). MAKE PARALLEL.

Step Procedure to Connect Additional Sections with Purlins

1. Place one soldier behind each frame holding a purlin in one hand and steadying the arch with the other.

2. Again place the tab from the ridge purlin in the slot at the ridge joint.
3. Rotate the diagonal brace towards the opposite side of the one before it.
4. Align the diagonal brace tab and place it in the slot.
5. Rotate the tab handle and bend towards the frame.
6. Continue connecting the other four purlins on each section until the proper number of frames are connected.

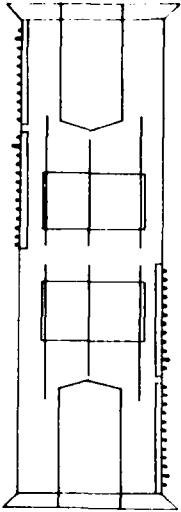

Figure 27.
Door section
(underneath)

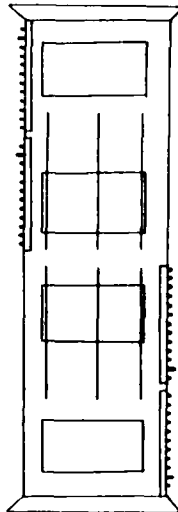

Figure 28.
Window section
(underneath)

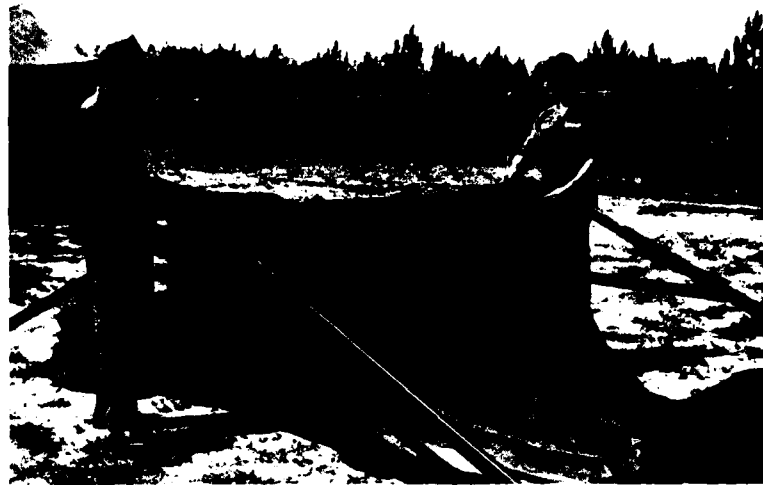

Figure 29. Place grommets of section
on ridge spindles

Roof Sections

Unwrap the roof section and be sure the door sections are next to the frames with door purlins installed. To prepare for ventilation or environmental control, turn to section VI, operation of fixtures page 53.

NOTE: THE STOVE PIPE OPENINGS ALL SHOULD BE ON ONE SIDE OR PLACED SO THAT THE STOVE PIPE OPENINGS OF THE ROOF SECTION, THE LINER AND THE FLY ARE ALIGNED.

Step Procedure to Position Roof Section

1. Locate the larger grommets at the center of either side of the roof sections.

2. With one man on either side of the section next to the grommets, carry the section to the center of the frame and place the grommets over the spindle at the ridge joint.

NOTE: FOR EASIER LACING, PLACE THE EAVE GROMMET WITH THE LACES OVER THE EAVE SPINDLE.

3. After all of the center grommets of the sections are laying over the ridge pins and the door sections are properly placed, it is now time to lace together one side of the adjoining roof sections.



Figure 30. Becket lacing

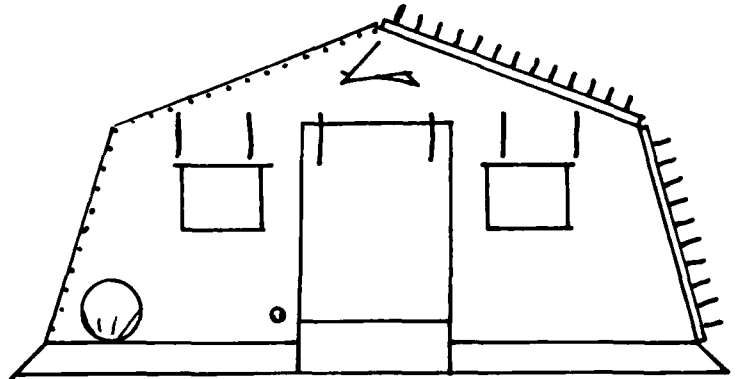

Figure 31. Endwall fabric

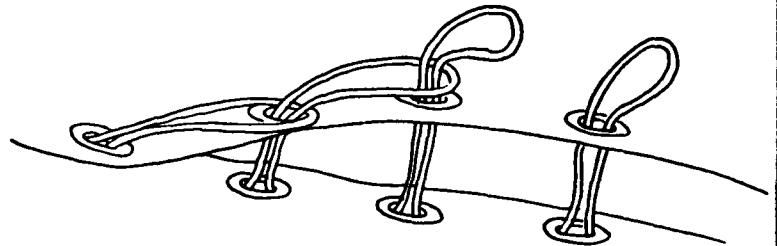

Figure 32. Lacing procedure

Step Procedure for Becket Lacing

You will now connect the endwalls to the roof. The method used to connect the fabric sections together in the TEMPER is called becket lacing. Follow these instructions:

NOTE: ALL SOLDIERS SHOULD BE ON ONE SIDE OF THE RIDGE PURLIN.

1. Locate the first lace and grommet next to the ridge joint.
2. Insert the first and second laces through the first and second grommets.
3. Insert the second lace up through the loop in the first lace.
4. Pull the second lace tight.
5. Insert the third lace through the grommet and through the loop in the second lace.
6. Pull tight.

This is the becketing procedure.

NOTE: BE SURE TO CLOSE THE HOOK AND PILE CLOSURE OF THE WEATHER FLAP AS YOU LACE.



Figure 33. Pull the lace back towards the ridge



Figure 34. Half hitch knot

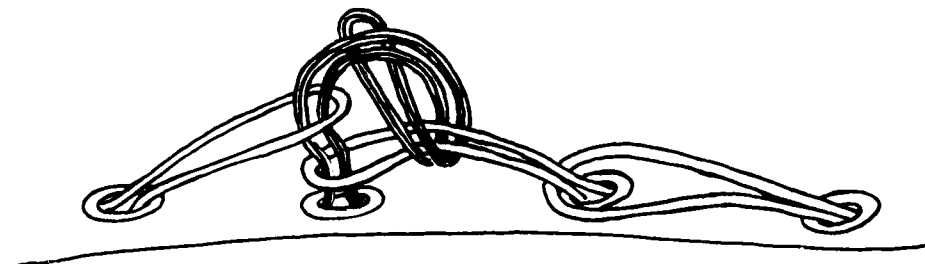

Figure 35. Tie off procedure

7. Continue becketing until there is a larger grommet. This is where the eave spindle is attached and is a tie off point.
8. Upon reaching the last lace at the eave, insert the next to last lace through the loop in the last lace.
9. Pull the next to last lace back towards the ridge.
10. Push it under the previous lace and pull it through itself to create a half hitch knot. This is called a tie-off.
11. Locate the endwall. Place the grommet at the peak over the ridge spindle. Lace the two sides of the endwall from the ridge to the eave. Do this on both sides.

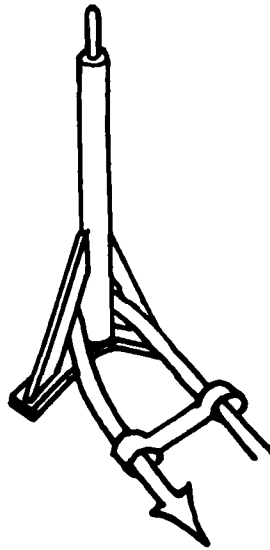

Figure 36. Ridge extender with guy line

Ridge Extender

Step Procedure to Position Ridge Extenders

1. Locate the ridge extender.
2. Place the ridge extender over the ridge spindle. Align the holes and insert the attached hitch clip pin. There will be a guy line on the endwall ridge extenders.
3. Locate a 19 foot guy line. Be sure it is free of frays and knots and has a loop on one end.

4. Place the other end of the guy line through the tent slip.
5. Thread the line through one side of the brace, around the shaft, and through the other brace of the ridge extender.
6. Thread the line back through the other side of the slip.
7. Tie an overhand knot on the end of the rope.
8. Place the end wall ridge extender on the end frame ridge spindle. Align the holes and insert the attached hitch clip pin.

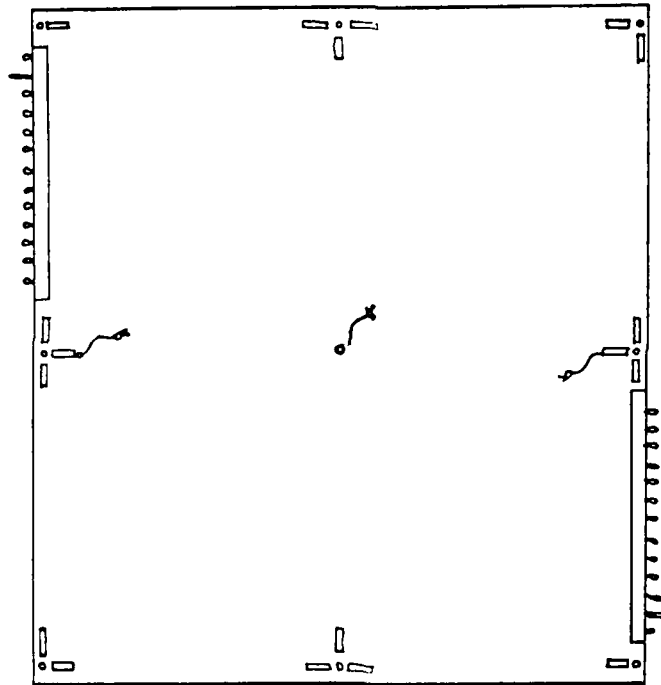

Figure 37. Sixteen foot fly (top)

Fly

Step Procedure to Position and Lace Flies

1. Unwrap the flies and spread them out on the ground next to the tent site.

NOTE: IF THE TENT HAS AN ODD NUMBER OF SECTIONS, AN EIGHT FOOT FLY MUST BE USED.

NOTE: THE STOVE PIPE OPENINGS SHOULD ALL BE ON ONE SIDE. 2. The becket laces of the one fly should be in line with the becket grommets of the one next to it.

3. Locate the large central ridge grommet.
4. Start the becket lacing procedure at the ridge grommet and work towards the end of the fly and the eave grommet.
5. As you lace, close the weather flap by mating the hook and pile closure.
6. Lace both sides fo the fly together.

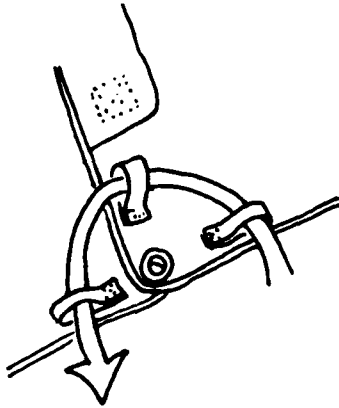

Figure 38. Guy line through webbing loops

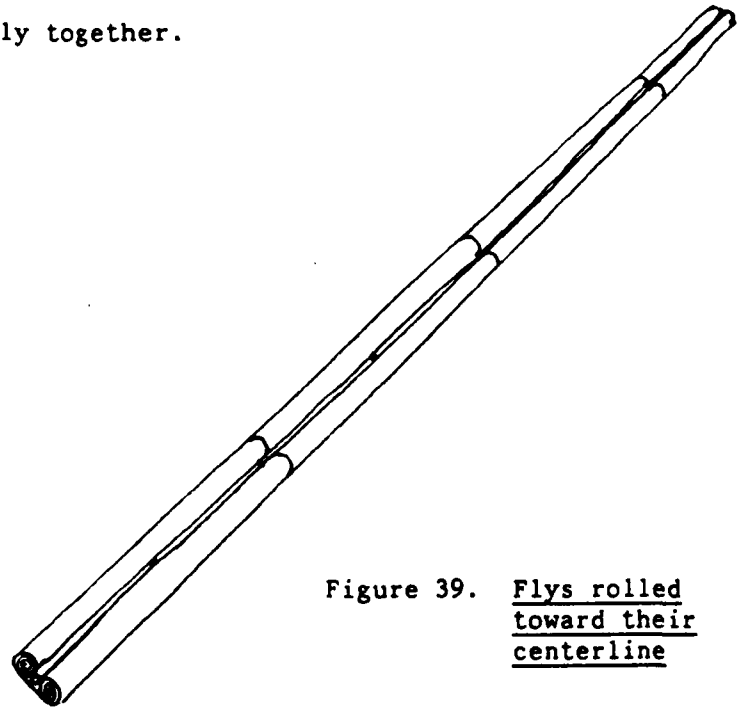

Figure 39. Flys rolled toward their centerline

There will be one guy line at each eave grommet along the side of the fly and one at each end ridge grommet. The guy lines will be threaded through the three webbing loops on the fly.

Step Procedure to Attach Guide Line, Cover Roof and Position Fly on Eave Extender Spindle

1. Locate one guy line and one slip for each eave and end ridge grommet.

NOTE: THE GUY LINE SHOULD BE 19 FEET LONG, FREE OF FRAYS AND KNOTS AND HAVE A LOOP ON ONE END.

2. Thread the line through one side of a tent slip.
3. Thread the line through all three of the webbing loops around each of the eave extender or end ridge grommets.

NOTE: THE SECTION ON THE RIGHT (AS YOU LOOK AT THE RIDGE) SHOULD OVERLAP THE FLY OF THE LEFT. THIS POSITIONING EXPOSES THREE WEBBING LOOPS. THERE WILL ONLY BE TWO WEBBING LOOPS AT EACH CORNER.

4. Thread the line back through the other side of the tent slip and tie an overhand knot.
5. Clear a path on the right side of each arch. Clear the lines and the fabric so you do not trip.
6. After all of the fly sections are laced together and the guy lines are attached, place the guy lines on the fly material and fold up both sides of the fly to the large central grommet (Figure 39).
7. One soldier should lift the fly at each central grommet (there is one every eight feet).
8. Walk the entire fly to the side of the tent which is not yet laced.
9. Align the soldiers at each grommet with the frame arches.
10. While in line, the group should walk in between the roof blankets next to the frame.

NOTE: DO NOT STEP ON ROOF BLANKETS.

11. Place the large central grommets of the fly on the ridge extender spindles.
12. Place the hitch clip pins on the fly through the hole in the spindle.
13. Place the rolled fly over the ridge extender to hold it in place and expose the becket laces at the ridge of the roof blanket.
14. Place the first and second lace through the first and second grommet and begin the becketing procedures.
15. At the end of the fly, tie off lace with a half hitch knot.
16. Bring the fly down to cover the roof blanket.

NOTE: IF THE FLY DOES NOT COME DOWN EASILY, PUSH UP ON THE ROOF BLANKET, WALK NEXT TO THE FRAME TO PULL DOWN THE FLY.

17. Place the grommets of the roof blankets over the eave spindles.

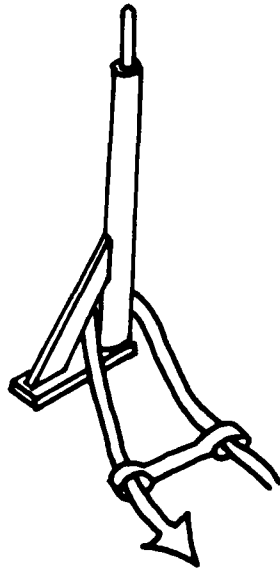

Figure 40. Eave extender with
guy line and slip

18. Locate the eave extenders.

Each eave extender should have a 19 foot guy line with a slip attached to it and a loop on one end. If the guy line is frayed, too short or the slip is missing, replace with the following procedures:

Cut off the damaged line:

- a) Thread a new line through one side of the tent slip.
- b) Thread the line through the brace of the extender and around the extender pole.
- c) Go back through the other side of the slip.
- d) Tie an overhand knot at the end of the line.

19. Place the eave extenders on the eave spindle with the brace towards the ridge.

20. Align the holes and insert the hitch clip pin.

21. Place the grommet of the fly on the eave extender spindle.

22. Insert the hitch clip pin to lock it in place.

Raising the Frame

We will now partially put up one side of the tent. If a ladder is available it is easier to raise both sides of the tent and place the liner, the lights, and the ventilation ducts on the ceiling of the tent later.



Figure 41. Correct kneeling position

To raise the frame:

- Raise one side of the tent at a time;
- Locate the locking pin at the joint and be sure it is hanging free;
- Locate the locking pin hole in the frame joint.

NOTE: IT IS ESSENTIAL THAT THE ENTIRE SIDE OF THE SHELTER BE RAISED AT ONCE.

Step Procedure to Raise the Frame (Side One)

1. A minimum of one soldier should be positioned at each eave joint. If additional soldiers are available they should help lift to raise the frame smoothly and easily.

NOTE: EXTRA SOLDIERS SHOULD BE AVAILABLE TO ASSIST ANYONE WHO HAS TROUBLE

CAUTION: BE CAREFUL NOT TO LET YOUR FINGERS GET CAUGHT IN THE JOINT. BE CAREFUL TO LIFT THE FRAME STRAIGHT UP. DO NOT PUSH OR LEAN ON THE FRAME.



Figure 42. Push up frame, pull in leg

CAUTION - YOU MUST CROUCH DOWN AND LIFT WITH YOUR LEGS, NOT WITH YOUR BACK.

CAUTION - THE LIFTING SHOULD BE DONE ON COMMAND.

CAUTION - BE SURE YOU ARE NOT STANDING ON FABRIC OR LINES.

2. Step in between the fabric and next to the eave joint. Place the fabric underneath the fly.
3. Place one hand on either side of the eave joint on the arch and the other one the eave joint.
4. Get in a stable crouching position.
5. On command, lift straight up to shoulder height.
6. Hold frame at shoulder height with one hand and pull leg of frame in with the other.
7. Place weight of frame on base plate of leg.
8. Align holes of both the eave joint and arch leg.

9. Place locking pin in joint.

NOTE: IF A LADDER IS NOT AVAILABLE, YOU WILL NOW HAVE ACCESS TO THE CEILING OF THE TENT FOR INSTALLATION OF ACCESSORIES SUCH AS LIGHTS AND PLENUMS AND ELECTRICAL WIRING. TURN TO PAGE 32 (ACCESSORIES) AND DO EACH PROCEDURE IN ORDER.

Step Procedure to Raise the Frame (Side Two)

The other side of the tent will now be raised.

1. Locate the locking pin at the joint and be sure it is hanging free.

NOTE: IT IS ESSENTIAL THAT THE ENTIRE SIDE OF THE SHELTER BE RAISED AT ONCE.

2. A minimum of one soldier should be positioned at each eave joint.

NOTE: IF ADDITIONAL SOLDIERS ARE AVAILABLE THEY SHOULD HELP TO MAKE THE FRAME RAISING SMOOTH AND EVEN.

3. Be careful to lift the frame straight up, do not push or lean on the frame.

CAUTION - BE CAREFUL NOT TO LET YOUR FINGERS GET CAUGHT IN THE JOINT.

- YOU MUST CROUCH DOWN AND LIFT WITH YOUR LEGS, NOT YOUR BACK.

- THE LIFTING SHOULD BE DONE ON COMMAND.

- BE SURE YOU ARE NOT STANDING ON FABRIC OR LINES.

4. Step in between the fabric and next to the eave joint.
5. Place one hand on either side of the eave joint.
6. Get in a stable crouching position.
7. On command, lift to shoulder height with one hand and pull leg frame in with the other.
8. Place weight of frame on base plate of leg.
9. Align holes of both the eave joint and arch leg.
10. Place locking pin in joint.

NOTE: IF A LADDER IS AVAILABLE ACCESSORIES MAY NOW BE INSTALLED.
TURN TO PAGE 32.

Final Procedures

List of Final Procedures

1. Mate the hook and pile fastener at the eave purlin flaps.
2. Becket lace the sides of the tent sections from the eave to the base plate.
3. Tie off at the base plate.
4. Close the weather barrier.
5. Go inside the tent, pull the sod cloth in under the base purlin.
6. Wrap the base purlin flap around the base purlin.
7. Zipper shut all doors.
8. Place a 24 in wooden stake approximately 10 ft from the side of the tent.
 - Slant the stakes towards the tent.
 - Place the stakes in line with the frame.
9. Connect the ends of the eave extender guy line to the bottom notch of the wooden stake.
10. Place the loop of the fly guy line over the top notch of the stake.
11. Using a 12 in steel pin, stake the holes in each of the base plates of the frame to the ground.
12. Stake each of the foot loops at the base of each side of the tent to the ground.
13. Tighten up the guy lines.

STRIKING PROCEDURE

Vestibules

Step Procedure to Strike Vestibule

1. Open vestibule door, remove insulated and single ply floor.
2. Release tension on guy lines and remove.
3. Unlace the door from the vestibule.

4. Untie the tie tapes.
5. Remove the hitch pins from spindles.
6. Loosen laces and remove door.
7. Collapse vestibule, position frames against endwall.
8. Untie tapes and remove the frame.
9. Pull the frame pins and disassemble.
10. Unlace the vestibule, remove and fold.

Tent Disassembly

Step Procedure to Strike Tent

1. Close up all windows and doors of all sections, endwall and liners.
2. Release tension on all guy ropes.
3. Disconnect ropes from the stake.
4. Remove the stake and tent pins.
5. Clean floor.
6. Fold insulated floor and remove.
7. Remove hanging lights.
8. From the inside of the tent, untie the five liner and five floor tie tapes at the base purlin.
9. Disconnect the four purlin flaps at the base of each section.
10. Remove the distribution box pole, modesty curtain and plenum.
11. From the outside of the tent pull back the weather flap covering the becket lacing.
12. Untie the tie off.
13. Disconnect the becket laces.
14. Untie the liner from the sides of the frame.
15. Lift up the fabric of the side of the tent and place underneath the fly, untie the liner from the base to the eave of the arch.

16. Disconnect electrical outlets and remove.
17. Remove the tent liner one section at a time.
18. Fold and place in original container.
19. Remove and repack the single-ply floor.
20. Unclip and remove the light bar and straps.
21. Remove the electrical distribution box.
22. Disconnect the purlin flaps.

CAUTION: THERE SHOULD BE AT LEAST ONE SOLDIER FOR EACH ARCH FOR THE FOLLOWING PROCEDURES.

23. It is essential that the entire side of the shelter be lowered smoothly and evenly.
24. Place one soldier at each arch on one side of the tent.
25. If additional soldiers are available they should assist to keep the frame from flexing.
26. On command, remove the lock pin.

NOTE: IF PIN CANNOT BE REMOVED EASILY, LIFT THE FRAME AND THEN REMOVE.

27. Swing out the side frame. Extra soldiers should assist in swinging out the side frame and lowering one side of the frame.
28. Lower straight and even, do not push or pull to one side.
29. Again, using a minimum of one soldier at each frame on the side of the tent that is still erect:
 - Remove the lock pin;
 - If the frame is not easily removed, lift the arch;
 - Swing the side frame out.
30. Remove the fly from the eave extender spindle.
31. Remove the eave extenders.
32. Untie the tie-off point and disconnect the lacing of the roof section.
33. Remove the ridge extender.

34. Remove the roof section.
35. Remove the endwalls.
36. Carry the flies to the side. Be sure they are clean and dry and inspect for rips and tears. Carry the endwalls to the side. Fold both the flies and the roof sections and pack back in original packing.

Frame Disassembly

Step Procedure to Strike Frame

1. Disconnect each purlin diagonal brace and fold.
2. Rotate the purlins and remove.
3. Lay the frames on their side.
4. Remove the ridge lock pins and headers.
5. Fold the sides of the frame towards the ridge.
6. Move the eave joint together.
7. Wrap the straps around the frame.
8. Replace the frame in the cover.

ACCESSORIES

Single Ply Floor

The single ply floor is laid down to keep the liner clean while it is being put up.

1. Unwrap and spread out the floor so it is flat and smooth.
 - If there are any sharp objects or holes on the ground, level out the place before continuing.
2. Put on section in place at a time and cover all exposed ground.
 - The hook and pile fastener has two different parts which must be mated properly.
3. Spread out the floor and connect the hook and pile fastener as much as possible.

Distribution Box

The electrical system of the TEMPER will supply lighting and outlets for a seven-section tent. Each section of the TEMPER may have lights and outlets on either side of each section. Installation of the lights is covered on page 41. Both the Bruce (fluorescent) and the incandescent lights for the TEMPER are made in eight foot lengths which may be used in up to seven sections of the tent. If more than seven sections are to be erected, place another distribution box at the opposite end to feed the extra lengths. The distribution box provides control and wiring for the electrical system of the TEMPER. The outlets for each side of the tent are divided into two circuits; one for the first three sections of the tent and another for the last four sections. The lights and outlets are controlled with on/off switches, which also serve as circuit breakers.

There are two types of distribution boxes for the TEMPER; "A" and "B". "A" has single-phase outlets and "B" has three-phase outlets. The "B" distribution box is only necessary when three-phase equipment, such as a sterilizer, is used.

The distribution box stand is an extendable aluminum pole with a plate to mount the distribution box which is placed in position only after the tent has been fully erected. The distribution box should be placed on the left of the endwall door, in between the outer fabric and the liner of the tent using the following procedures.

Step Procedure to Install Distribution Box

1. Place the distribution box stand in between the liner and the tent fabric on the left (as you are coming in the tent).
2. Disconnect the hitch pin at the bottom of the stand.
3. Extend the flange around the header, step on the base plate to make it flush with the ground and insert the hitch pin to lock the stand in place.
4. Insert the bolts in the rear of the distribution box through the keyhole slots in the distribution box stand plate.

Light Cables

Step Procedure to Route Light Cables

1. Route the lights cables from the distribution box between the liner and the endwall and through the slot in the liner next to the light bar.
2. Wrap the left side light cable once around the header to relieve some of the strain on the cable.

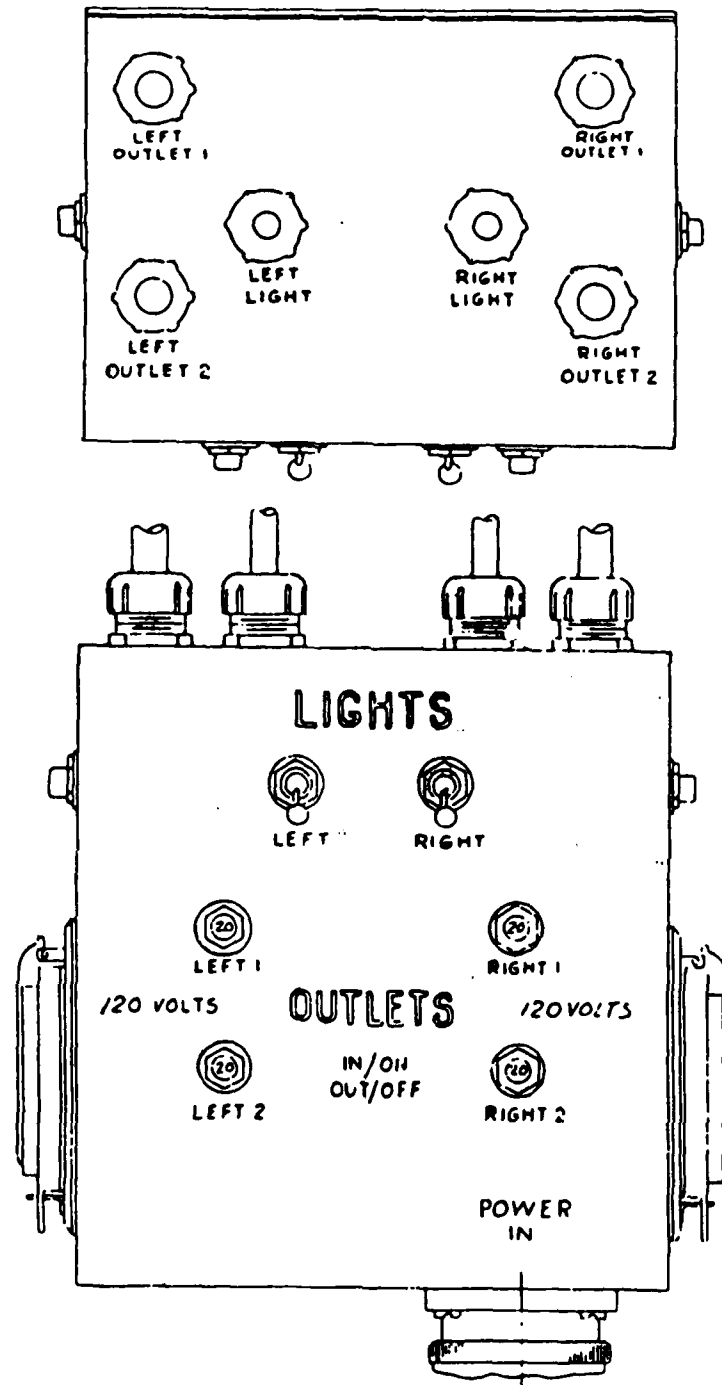

Figure 43. 120 volt distribution box "A"

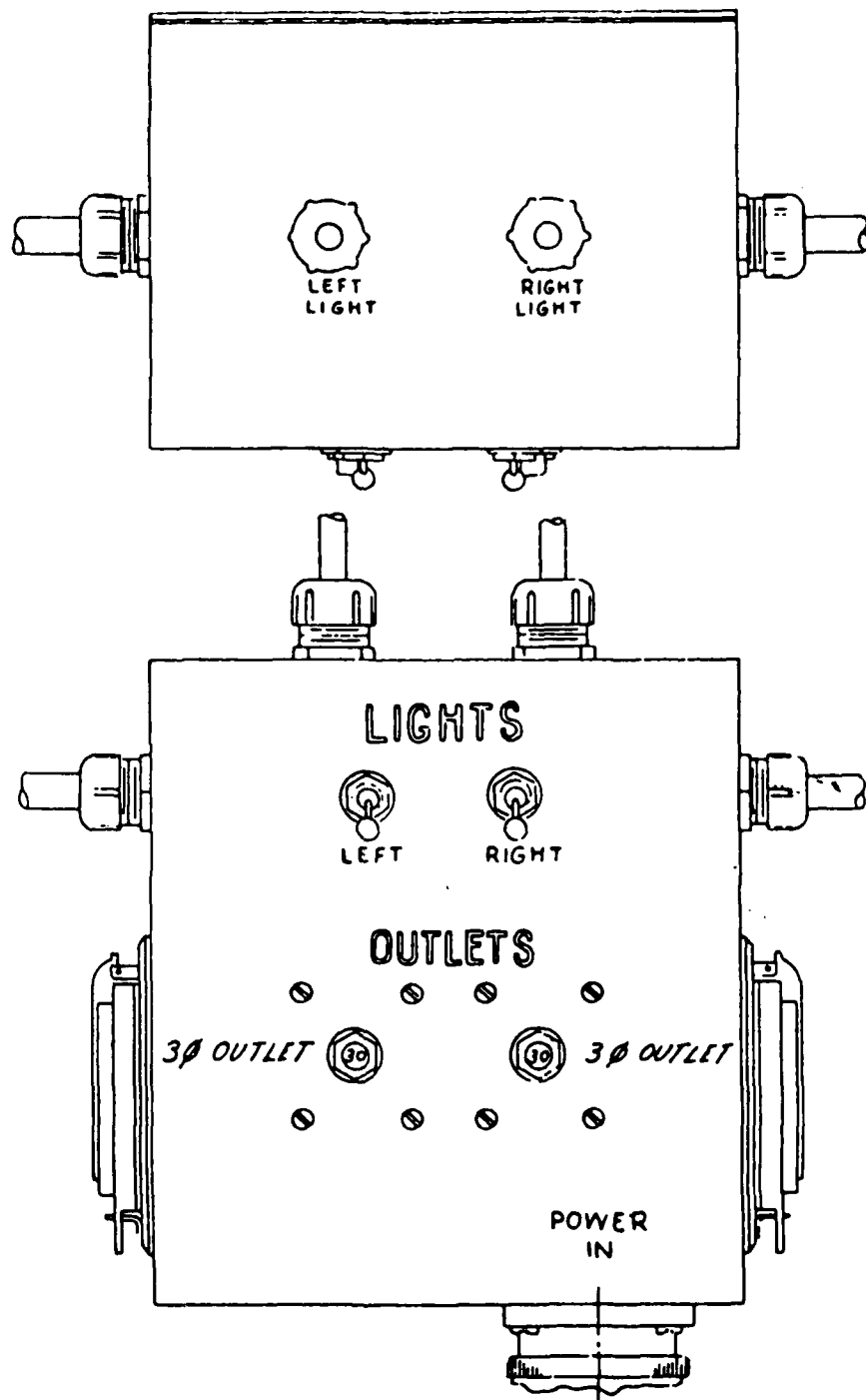

Figure 44. Three-phase distribution box "B"



Figure 45. Insert the bolts of the box through the slots of the plate

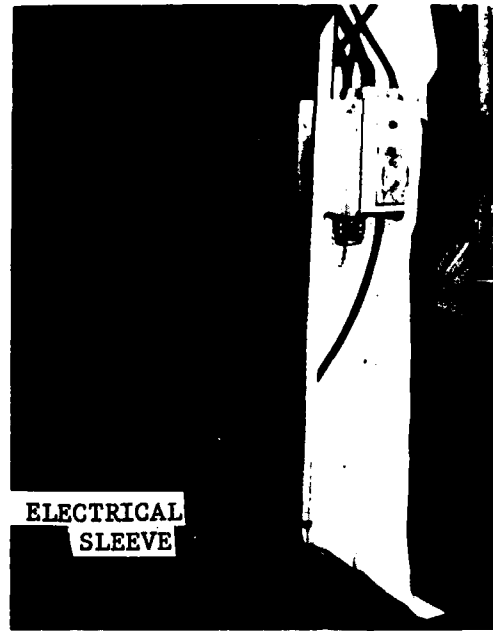

Figure 46. Distribution box and stand is located between the liner and the endwall on the left



Figure 47. Connect the strap of the outlet to the arch frame above the diagonal brace

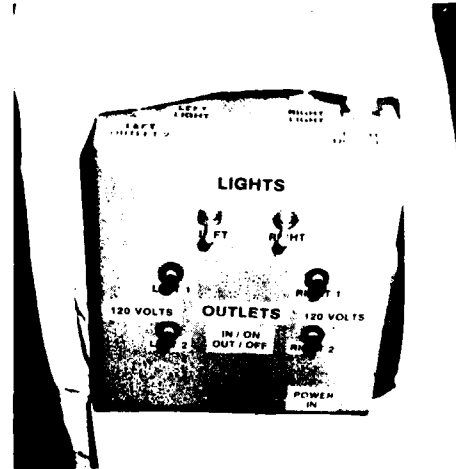

Figure 48. Distribution box fits through hole in liner

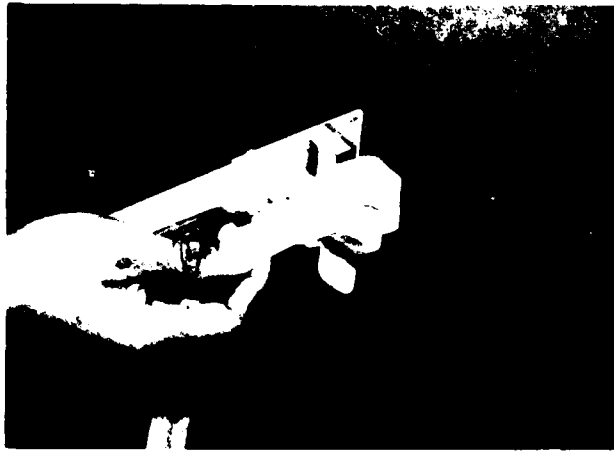

Figure 49. Slide light hanging straps over end clips



Figure 50. Attach light bar to header

Light Bars

The light bars will support the lights for the TEMPER. The light bars are square metal tubes which clip on to each header next to the frame and span from header to header. There will be two light bars for each eight ft section.

Step Procedure to Install Light Bars

1. Take two of the straps included with the light bars and slide them over the endclip.
2. Clip the light bar on the header next to the arch.
3. Clip the other side of the light bar to the following header.
4. Slide the light bar evenly to the header flange.

The straps on the light bar will go through slots in the liner to hold the lights.

Outlet Cables

Step Procedure to Install Outlet Cables

1. Lay each outlet cable assembly over the eave purlin to suspend the assembly on the frame.
2. Attach the outlet itself to the arch with a velcro strap. There is a fabric flap in the liner, which may be opened to expose the outlet.

3. The first three outlets of the tent are wired through the #1 circuit. The last four outlets are wired through the #2 circuit.

NOTE: THE DISTRIBUTION BOX IS DESIGNED FOR A SEVEN-SECTION TENT. FOR A LARGER TENT, TWO DISTRIBUTION BOXES (ONE ON EITHER END) MUST BE USED.



Figure 51. Connect black liner clips

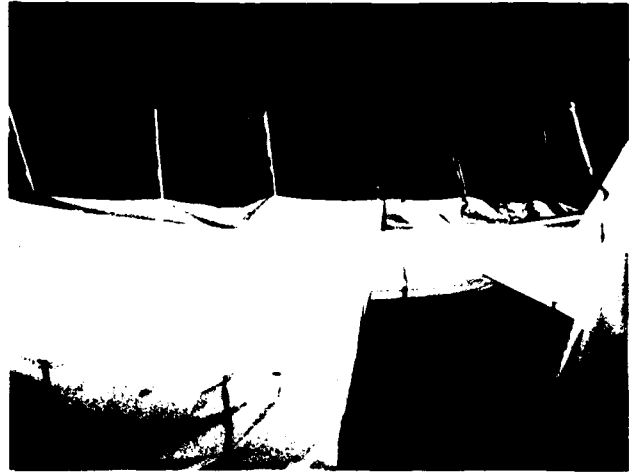

Figure 52. Liner with center ties attached

Liner

The liner for the TEMPER is made in eight ft sections. The sections are tied with straps to the frame and light bars and are attached to each other with hook and pile fastener. The liners should be hung from one end working backwards or using two teams working from the center. On each end there will be an endwall liner which is placed with same procedure.

NOTE: IF HEATERS ARE GOING TO BE USED IN THE TENT, THE STOVE PIPE FLAPS MUST NOW BE TIED OPEN.

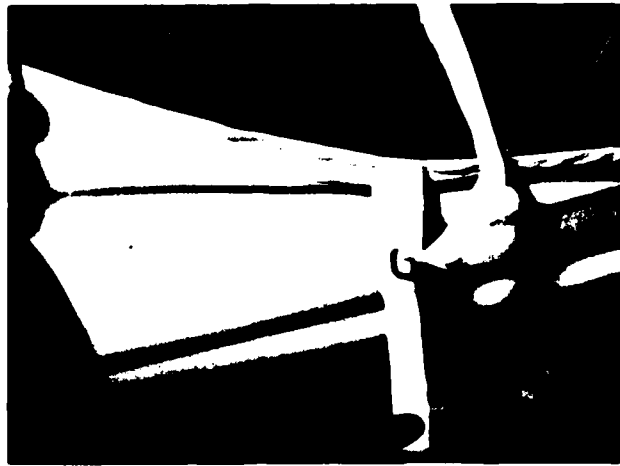

Figure 53. Light strap inserted through liner

Step Procedure to Install Liner

1. Roll up the roof sections of the tent from the base to the eave and tuck it under the fly.
2. Unwrap the liner and locate the strap at the center of one side.
3. Tie this strap to the center of the header.
4. Locate the strap with the black clip two feet in at the center of the liner.
5. Push the black clip around the ridge purlin and clip it to the "D" ring on the other end.
 - This will suspend the liner at the header height.
6. Clip the next two straps around the ridge purlin in the same way.
7. Tie the last strap to the header.
 - The center of the liner will now be suspended.
 - On either side of the center are ties for the light bars.
8. The tie at the header should be tied around the clip of the light bar.
9. Tie the next three straps to the light bar.

NOTE: BETWEEN THE STRAPS THREE ARE SLITS FOR THE LIGHT HANGER STRAPS.

10. Place the light hanger straps through the slits in the liner.
11. Tie the next strap around the light bar.
12. Tie the last strap around the clip on the header.
13. Press the hook and pile fastener together between each section of the liner.

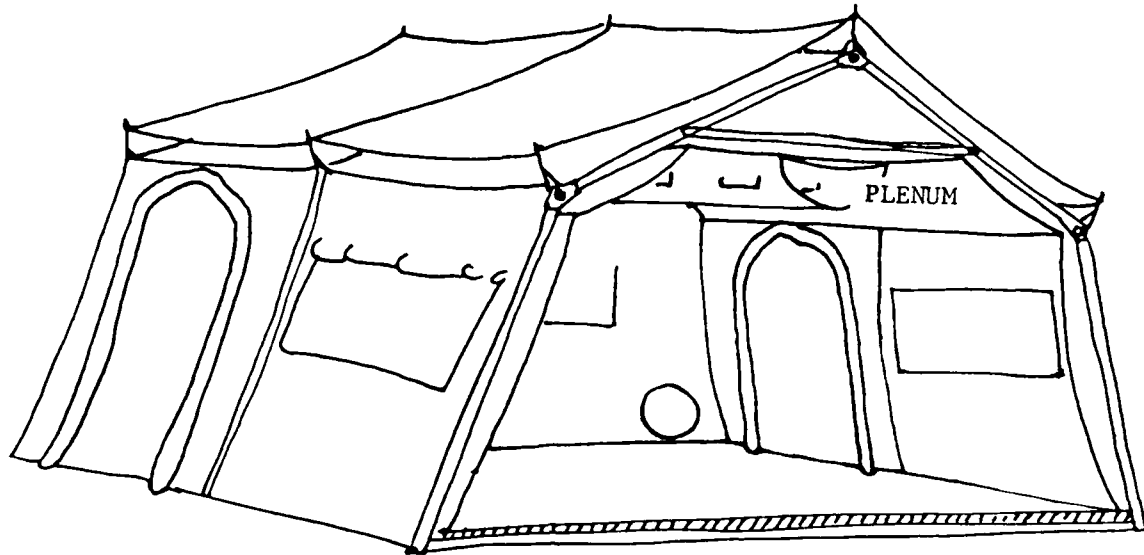

Figure 54. Section through tent showing liner and plenums

Plenums

Step Procedure to Install the Plenums

1. Tie each end of the plenums through slots in the liner to the header with the tie tapes.
2. Press the hook and pile fastener together to connect the sections together.
3. To adjust airflow, open or close the flaps on the sides of the plenum. The endwalls have a plenum which transfers air from the corner at the ventilation sleeve to the central plenum.
4. If a plenum is needed for an eight ft section, use a 16 ft section, tie it off and tuck it above itself. The plenums should be installed with the tent half erected.

The endwall plenum is where the plenum is connected to the air source through the ventilation sleeve. This plenum is installed by tying to the eave and twice to the header through the slits in the liner.

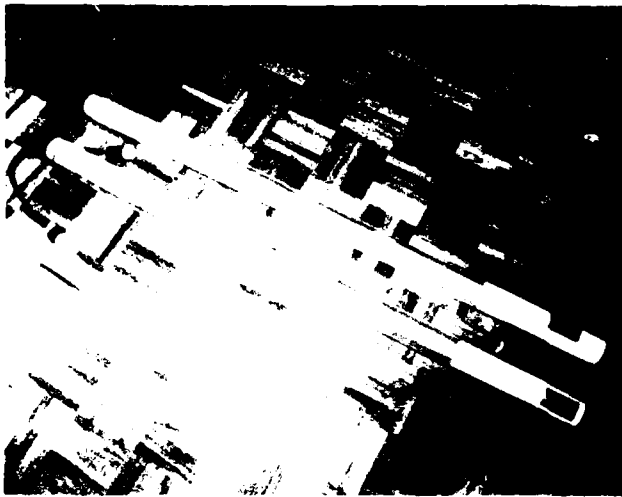

Figure 55. Flourescent (bruce lights) stringer



Figure 56. Secure velcro around end of fixture

Lights

There are two types of lights available for the TEMPER: fluorescent (Bruce lights) or incandescent stringers. The Bruce lights have one light on either side of an eight foot section. The incandescent lights have two lights on either side of an eight ft section. Both sets of lights are intalled in the same way.

Both light systems have a distribution box mounted on a pole which sits underneath an endwall header. The distribution box controls both the right and left lights independently and also includes the wiring for the auxillary outlets. The distribution box also includes the fuses for the electrical system.

Fluorescent or Bruce Lights. Bruce lights are used whenever lighting is critical. The incandenscent fixtures can be used at other times.

Step Procedure to Install Fluorescent or Bruce Lights

1. Open the fiberglass case and remove the lights one at a time. You will notice the lights have male and female plugs. The lights must be hung initially so that the plugs mate properly.

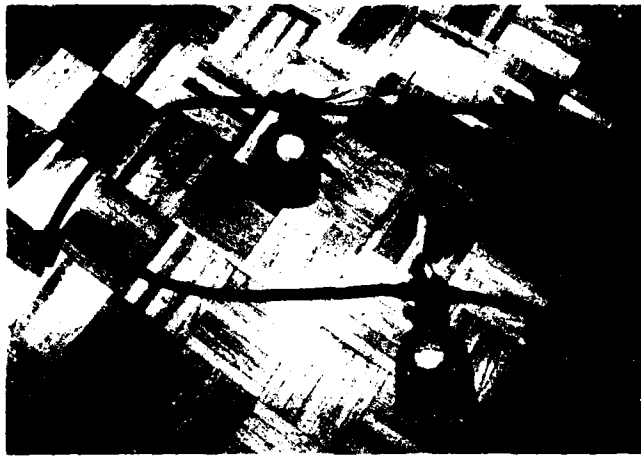

Figure 57. Incandescent light stringer

2. Wrap the light hanger strap around either end of the light on the inside of the rubber end caps.
3. Pull the strap up through the "D" ring and press down on itself to engage the hook and pile fastener.

Incandescent Light. The incandescent lights are made in stringers for each eight ft section. The stringers are strung with the same procedures as the Bruce lights. The light hanger straps are tied through the hole molded in the stringer.

NOTE: IF ONLY ONE SIDE OF THE TENT IS UP RETURN TO PAGE 28 TO STEP PROCEDURE TO RAISE THE FRAME (SIDE TWO).

Vestibule

The vestibule for the TEMPER is a twelve foot passageway, which may serve as an entryway or as a connector between shelters. The vestibule may be connected to the endwall or roof section doorway. In the vestibule blackout curtains, bump-through doors or zippered doors may be mounted.

NOTE: IF THE VESTIBULE IS BEING USED TO CONNECT TWO SHELTERS, THERE SHOULD BE 12 FT OR LESS BETWEEN THE TWO SHELTERS AND THEY SHOULD BE ROUGHLY IN LINE.

Step Procedure To Erect A Vestibule

1. Unroll the vestibule adapter which is tied around the door.
2. Unwrap the vestibule section and frame from the vestibule package.
3. Spread out the vestibule section.



Figure 58. Vestibule used as entrance way

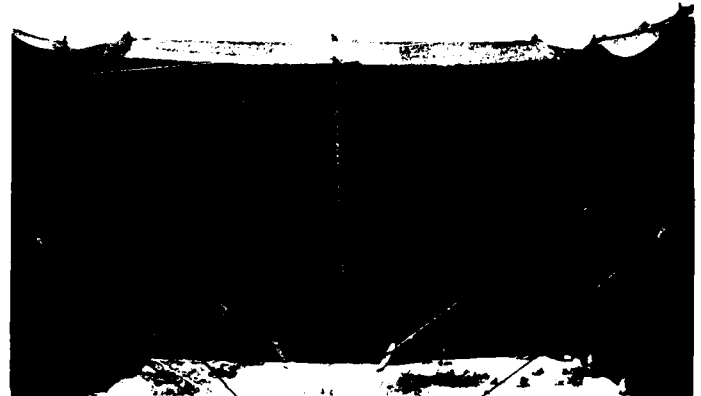

Figure 59. Vestibule as connector

4. Locate the central grommet at one end.
5. Align the central grommet at one end of the vestibule section with the central grommet of the vestibule adapter.
6. Becket lace the vestibule section to the adapter starting at the ridge and working towards each eave where it will be tied off.
7. Insert the post of the frame legs into the holes in the arch frame of all three frames.
8. Place hitch clip pins in each side to lock in place.
9. Carefully bring the completed vestibule frame underneath the vestibule section.
10. Place the three spindles on the arch through three grommets in the cover and the adapter.

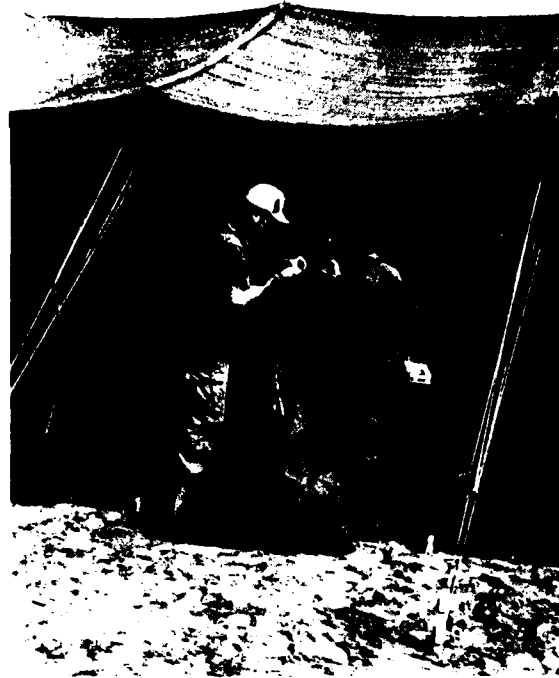

Figure 60. Becketing the vestibule to the extender

11. Place the hitch clip pins through the holes in the spindles on top of the cover.
12. Cover the lacing with the weather flaps by securing the hook and pile closure.
13. Carefully bring another of the completed vestibule frames underneath the cover.
14. Place the three spindles on the arch frame through the three grommets in the cover.
15. Place the hitch clip pins through the holes in the spindles.

NOTE: IF THE VESTIBULE IS TO BE USED AS AN ENTRANCE TURN TO "ENTRYWAY"
PAGE 16.

16. Bring the last completed vestibule frame under the cover.
17. Place the ridge spindle through the ridge grommets of the cover and the ridge grommet of the second vestibule adapter.
18. Starting at the ridge becket lace the adapter and the cover together, tie off at the eave with a half hitch knot.



Figure 61. Inserting the hitch pin in the frame spindle

19. Insert the eave spindles through the eave grommets of the cover and adapter.
20. Secure with hitch clip pins.
21. Starting at the eaves, lace the vestibule sides to the adapter at the doorway.
22. Tie off with a half hitch knot and press the weather barrier closed.
23. While inside the vestibule straighten all of the frames.
24. Tie the tapes inside the cover around the vestibule frames.
25. Find the two vestibule tension straps at the top of the doorways on either side of the vestibule.
26. Pass the strap over the eave purlin on the doorway.
27. Pull the strap until tight.
28. Secure the strap to itself with the hook and pile fastener.
29. Again align the frames of the vestibule upright from the inside of the vestibule.



Figure 62. Pulling the vestibule tension strap tight

30. Install one pin in each of the base plates in the vestibule frame. Install the pin until it is about two in from the ground.
31. Wrap the foot loop around the pin.
32. Finish installing the pin to hold the frame base plate and the foot loop firmly. When the vestibule is used as a passageway, guy lines will be installed on the spindles of the central frame under the hitch clip pins. Stakes should be placed about six ft out facing towards the vestibule door. Place the single ply and insulated floor in this vestibule.

If the vestibule is to be used as an entryway, a zippered door, bump-through doors, or blackout curtains may be placed at the end.

Step Procedure to Install Vestibule Door for Entryway

1. Find the vestibule door.
2. Bring the last vestibule frame under the blanket.
3. Place the three spindles of the frame through the grommets of the endwall.
4. Place the ridge grommets of the doorway over the ridge spindle of the frame and lock in place with a hitch clip pin.

5. Becket lace from the ridge to each eave and tie off with a half hitch knot.
6. Place the grommets of the blanket and the door over each of the eave spindles and lock in place with a hitch clip pin.
7. Place a guy line over each eave spindle under the hitch clip pin.
8. Place two ground pegs about six ft out at a 45° angle to the entrance.
9. Pull out the frame until the top of the vestibule is tight.
10. Tie the guy lines to each of the ground stakes.
11. Tie the tapes of the roof blanket to the frames of the vestibule.
12. Tighten the guy lines using the slip.
13. Straighten all of the vestibule frames.
14. From the inside of the vestibule install one steel pin through the base plate of the vestibule frame.
15. Finish installing pin to hold the frame base plate and the foot loop firmly.

If the vestibule is to be used as an entryway, a blackout curtain can be placed at any frame in the vestibule. The blackout curtain is a fabric that slides on a cable which spans between the two eave spindles of a vestibule frame.

Step Procedure to Install Blackout Curtain

1. Disconnect the hitch clip pin if necessary.
2. Lift the vestibule blanket off of the spindle.
3. Place the blackout curtain ring over the spindle.
4. Replace the blanket.
5. Insert the hitch clip pin. Do this on both eave spindles of the frame where the blackout curtain will span.
6. Place the single ply and insulated floor in the vestibule.

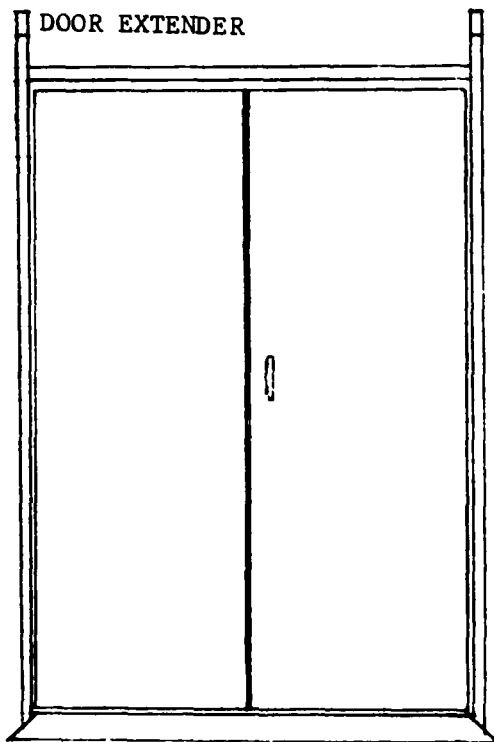

Figure 63. Bump through doors with door extenders

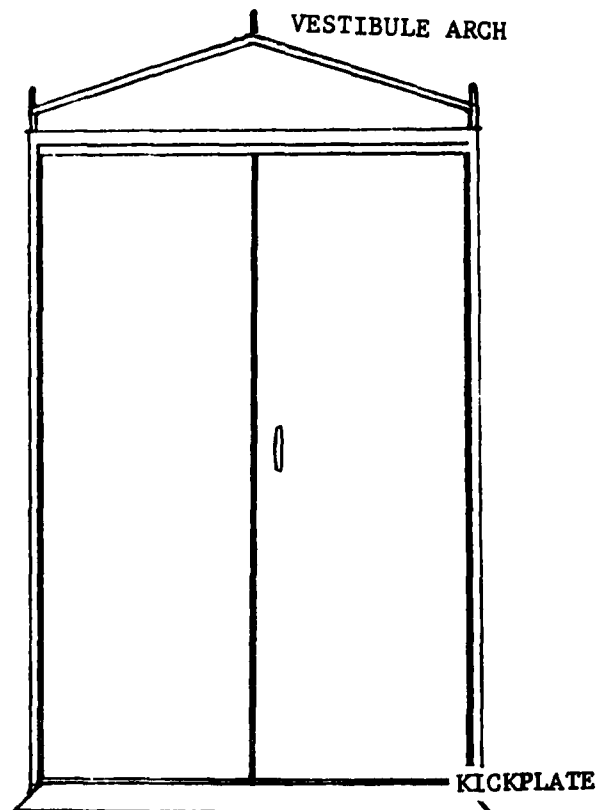

Figure 64. Bump through doors with vestibule arch installed

The double access or bump-through doors are self closing and may be placed in any of the doorways of the TEMPER. The bump-through doors are needed when personnel are carrying objects or need quick access in or out of a tent. The bump-through doors may be placed in the end section using the following steps.

Step Procedure to Install Bump-Through Doors in End Section

1. Unzip the fabric door and roll it up towards the inside. Disconnect the hook and pile fastener holding the screening in position, roll up the screen and tie it in place.
2. Stand the door up and lock the doors in the closed position.
3. Using the attached Allen wrench, loosen the set screw and place the door extender in its lowest position.
4. Raise both kick plates.

5. With one person on either side, place the door frame between the endwall frame and the endwall.

NOTE: PLACE THE DOOR FRAME VERTICAL AND IN LINE WITH THE DOOR OPENING WITH THE O.D. SIDE OUT AND THE LIGHT GREEN SIDE IN.

6. Raise the extender flange to wrap around the header and lock in place with the set screw.
7. Lower the kick plates.
8. Fasten the pile fastener of the screen door and the hook fastener of the bump-through door frame to seal the fabric around the door.

Step Procedure to Install Bump-Through Doors in Door Section or Vestibule

1. Lock the bump-through doors shut.
2. Using the attached Allen wrench, loosen the set screws and remove the door extenders.

NOTE: PLACE THE DOOR EXTENDERS ON EITHER SIDE OF THE DOORWAY IN BETWEEN THE LINER AND THE ENDWALL, IN A FOOT LOCKER OR IN A PLACE WHERE IT CAN BE FOUND.

3. Remove the arch from the vestibule frame and insert the post of the arch in holes on either side of the top of the bump-through door frame.
4. Tighten the set screw with the Allen wrench.
5. Lift the kick plates up to lean against the door.
6. Carry the frame in position.
7. Locate the triangular vestibule arch cap. Place the three grommets of the cap on the three spindles of the arch and press the hook of the cap to the pile of the door frame.
8. Place the grommets of the vestibule adapter or vestibule over the three spindles of the bump-through door arch.
9. Tie the tie tapes to the frame of the door.

NOTE: PLACE THE KNOT ON ONE SIDE OR THE OTHER OF THE FRAME SO IT DOES NOT INTERFERE WITH THE MOVEMENT OF THE DOORS.

10. Move the door so it is vertical.
11. Lower the kick plates.

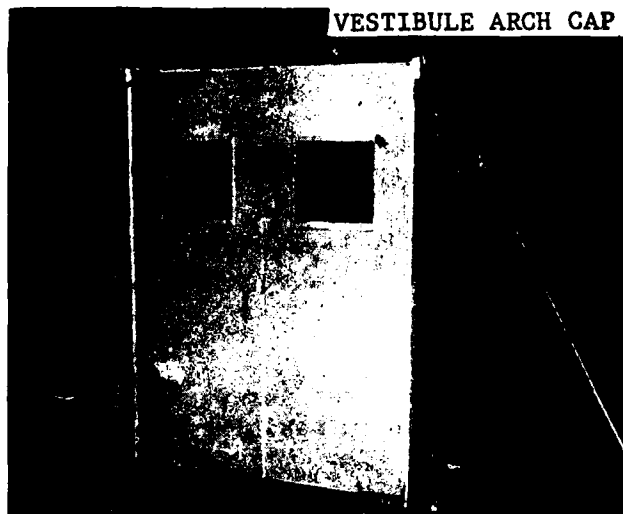

Figure 65. Bump through doors installed

12. Guy the two vestibule eave spindles using the wooden stakes.
13. Close the weather flaps by sealing them around the bump-through door frame.
14. Tighten the vestibule tension straps.

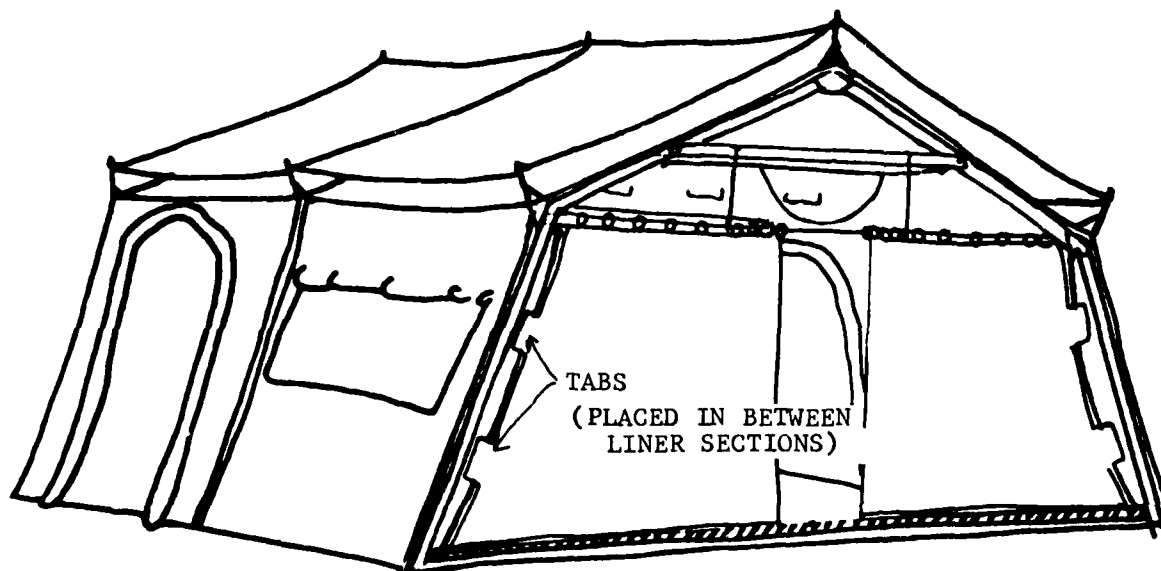

Figure 66. Modesty curtain installed

Modesty Curtain

The modesty curtain is used when partial separation between sections in the TEMPER is desired. The curtain is suspended from a wire attached to the eave purlins on either side of the tent. The center of the curtain is suspended from the header and allows a curtained doorway as passage through the center of the TEMPER.

The curtain is hung in line with the frame arch and the center is suspended from the header.

Step Procedure to Install Modesty Curtain

1. Lay the modesty curtain out flat inside the tent. Straighten out all of the wires.
2. Separate the hook and pile fastener of the liner at the eave purlin height on both sides.
3. Place the curved hook through the liner and around the eave purlin next to the frame. Do this on both sides. The modesty curtain will now be suspended across the tent.
4. Locate each of the short cables with squared off hooks near the center of the cable.
5. Separate the hook and pile fastener above the cable.
6. Insert the cable through the liner and hang it on the header.
7. Close the liner around the wires.
8. Locate the two tabs on either side of the curtain.
9. Separate the liner next to the tabs.
10. Insert the tabs and close the liner around the tabs.



Figure 67. Squared-off hooks placed over header

MOVEMENT TO A NEW WORKSITE

Prior to movement, the TEMPER must be cleared and all electrical equipment disconnected (See striking procedures).

Each package of TEMPER parts may be carried by four people and may be transported by army ground and air transport vehicles. Refer to Table 1, Components for the weight of each item to ensure the capacity of the vehicle is not exceeded.

OPERATION OF FIXTURES

Door Rollup

The doors of TEMPER are located in the center of the endwalls and on either side of a door section roof blanket. A door may also be laced to the end of a vestibule. A door is opened up by unzipping either side, rolling up, and tying with tie tapes. Inside the fabric outer door is a screened door which is fastened with hook and pile fastener on either side. It also may be rolled up and tied out of the way.

Vestibule Adapter Rollup

Around the outside of the door is a vestibule adapter which is used to connect a passageway or vestibule to the TEMPER. The vestibule is necessary for blackout protection. The erection procedures for the vestibule are described under Installation and Operating Instructions. The vestibule adapter, like the door and window flaps, should be rolled up towards the inside to prevent rain from entering the folds.

Window Rollup

Windows of the TEMPER tent are made in three layers; a rain flap on the outside, a clear plastic window in the middle and screening on the inside. The rain flaps and plastic windows close by using hook and pile closure. The rain flap and the plastic window can each be held open with tie tapes. Each layer must be rolled up towards the inside to prevent rain from being trapped within the folds. To close fully the rain flap, the clear window must first be unrolled and secured.

Ventilation

The endwall sections may be rolled up and tied for maximum ventilation. There are tie tapes fastened above the window on both sides of the fabric. The door of a door section may be opened and tied while leaving the purlin flaps attached.

Step Procedure to Roll Up Endwall

1. Open weather flaps on both sides of section to be opened.
2. Untie tie off and disconnect becket lacing.
3. From inside the shelter, disconnect the base purlin flap.
4. With one soldier on either side of the endwall, fold and roll up the fabric towards the top and tie with tie tapes.

NOTE: REMEMBER TO ROLL THE FABRIC TOWARDS THE INSIDE TO PREVENT TRAPPING RAIN IN THE FOLDS.

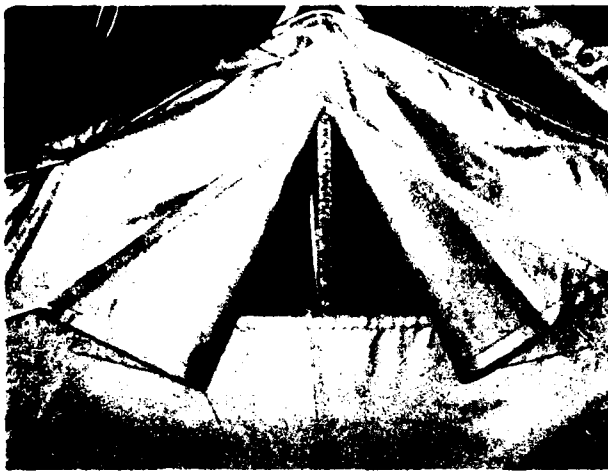

Figure 68. Peak vent tied open



Figure 69. Roof vents of desert/
tropical TEMPER with fly
removed



Figure 70. Vestibule adapter
rolled up and tied
at top of door



Figure 71. Windows are rolled up
towards the inside and
tied at the top

Roof Vents

The desert/tropical version of the TEMPER has vents on the roof of each section which may be controlled with lines from the inside of the tent. There are three lines for each vent; one in the middle and one at either end. When operating the vents, try to control them evenly. When the vents are operated from within a lined tent, disconnect the velcro holding the liner door closed, reach up and pull the adjustment line from the top or bottom to adjust the vents up or down.

End Section Vents

The endwalls of the TEMPER have a triangular vent at the peak. The vent may be tied open or closed by the lines which may be tied to the eave extenders on either side.

OPERATION UNDER WEATHER/CLIMATE EXTREMES

If it is hot or cold and air conditioning or heating units are being used, the ducts must be routed so as not to interfere with the entrances to the shelter. For step procedure to install plenums, see page 40.

If it is cold and heaters are being used, the stove pipe flaps must be opened and tied back in advance on both the fly and the roof blankets. The placement of the fuel supply must also be planned to pose the least hazard. For information, study the manual for the heating unit used.

Before the tent is erected the type and configuration of the environmental control must be known. If it is hot in a lined tent with natural ventilation, the liner vents must be opened before the exterior ones.

Wet Climate

1. Keep tent lines loose enough to prevent the tent pins from being pulled out of the ground when the lines shrink from dampness.
2. If heavy rain is expected or the tentage complex will be set up for a long period of time, dig a trench around the outside.
3. Dry all tent parts before repacking.

Operating in Snow

1. Sweep snow from roof of shelter with a broom. Gently push the roof from the inside to keep it clear.
2. When selecting a tent site on snow covered ground, poke the surface with a sharp pointed pole to locate any holes or crevices. If the

tent site must be located where there are crevices, mark their locations to avoid accidents.

3. Tamp the snow down to provide a firm surface.

Operation in High Wind

1. Close and secure all windows and doors.
2. Frequently check all anchors and guy lines.

OPERATOR'S MAINTENANCE INSTRUCTIONS

Manual, Tools and Equipment

The repair kit (NSN 8340-00-262-5767) and field manual 10-16 are included with the TEMPER tent. The repair kit is equipped to perform minor repair to the shelter fabric and hardware.

Lubrication

The slide fasteners are the only items on the tent requiring lubrication. When the sliding member of the fastener is difficult to move, apply stick form lubricant (FSN 9150-99907548) to the metal slides of the fasteners.

Preventative Maintenance Checks and Services

To ensure that the shelter is ready for use at all times, it must be inspected systematically so that defects may be discovered and corrected before they result in serious damage or failure. The necessary preventive maintenance services to be performed are listed and described in Table 2. The item numbers indicate the sequence of minimum inspection requirements. Defects discovered during use of the shelter will be noted for future correction, to be made as soon as use is discontinued. Stop use immediately if a deficiency is noted that would damage the shelter if use were continued. All deficiencies and shortcomings will be recorded together with the corrective action taken, on DA Form 2402 at the earliest possible opportunity.

The column of Table 2 contains tabulated listings of preventive maintenance services, which must be performed by the operator/crew. The daily and weekly item numbers are listed consecutively and indicate the sequence of minimum inspection requirements.

Table 2

Operator/Crew Preventive Maintenance Checks and Services

ITEM NO.	INTERVAL			ITEM TO BE INSPECTED	PROCEDURES
	B	D	A		
	X	1	X	Guy Lines	Check for even tension and for fraying or breaks. Tighten or replace guy lines as required.
	X	1	X	Tent Slips	Check for cracks, breaks or excessive wear and replace if necessary.
	X	1	X	Tent Stakes or Pins	Check for secure installation. Reinstall pins or stakes or replace as required.
	X	1	X	Extenders	Check for bends, missing hitch pins or broken spindles. Replace if necessary.
	X	2	X	Shelter Fabric	Check fabric inside and outside of shelter for wear at seams, for broken stitches, for holes and or weak spots or other damage to fabric. Report to organizational maintenance.
	X	2	X	Frame	Check frame for chipped paint, dents, bends, breaks and broken or missing parts. Report damage to organizational maintenance.
	X	2	X	Hardware	Check grommets, ties, patches, the weather flap and becket lacing for secure installation and damage. Report damage to organizational maintenance.
	X	2	X	Hook and Pile Fastener	Check for sure installation and debris. Clean or report damage to organizational maintenance.
	X	2	X	Zippers	Check zippers for smooth operation, complete closure, missing teeth, unstitched seams or other damage. Report damage to organizational maintenance.
	X	2	X	Electrical System	Check all electrical connection cable, receptacles, circuit breakers and light assemblies for damage, burned contacts or insulation and for secure attachment. Check light assemblies for burned out or weak tubes. Report damage to organizational maintenance.
				NOTE:	PERFORM DAILY MAINTENANCE SERVICES AT FREQUENT INTERVALS DURING HIGH WIND OR SEVERE STORM CONDITIONS.

Table 3 Maintenance Allocation Chart

(1) GROUP NUMBER	(2) COMPONENT/ASSEMBLY	(3) MAINTENANCE LEVEL					(4) REMARKS
		C	O	F	H	D	
	FRAME:						
	ARCH						
	Beam	1	P	R			
	Joint	1	P	R			
	Base Plate	1	P	R			
	Spindle	1/P					
	HEADER	1	P	R			
	PURLIN	1	P	R			
	VESTIBULE	1	P	R			
	LIGHT BAR	1	P				
	DISTRIBUTION BOX STAND:	1	P	R			
	FABRIC:						
	Window Section	1/R	R/P				A
	Door Section	1/R	R/P				A
	Endwall	1/R	R/P				A
	Fly	1/R	R/P				A
	Liner	1/R	R/P				A
	Plenum	1/R	R/P				A
	Floor	1/R	R/P				A
	Insulated Floor	1/R	R/P				A
	Section and Frame Covers	1/R	R/P				A
	ACCESSORIES:						
	Distribution Box	P	1	R			
	Electrical Outlets	P	1	R			
	Fluorescent (Bruce) Lights	R	1/R/P				B
	Incandescent Lights	R	1/R/P				B
	Guy Lines	1/R/P					
	Tent Slips	1/P					
	Tent Stakes	1/P					
	Tent Pins	1/P					

TEMPER TENT-ERECTION CHECKLIST

1. Mark the placement of the frame arch bases.
2. Place the frame packages.
3. Place the roof sections and liners in between the frames.
4. Lay the flies at every other roof section.
5. Open the arches.
6. Place the locking pin in the ridge joint.
7. Lock the header to the arch.
8. Open, the ridge joint and place the header in a second arch.
9. Prop up both arches, place the ridge purlin tab in the ridge joint slot and lock in the tabs of the diagonal braces.
10. Install the remaining four purlins.
11. Align the next arch (with the header installed) and continue installing the purlins. Remember to work from the ridge to the base and do one section at a time.
12. Place the ridge grommets of the roof section over the ridge spindle. Working from one end to the other.
13. Becket lace from the ridge to the eave on one side.
14. Place the ridge extender on the ridge spindle with lines on each endwall ridge extender.
15. Unwrap and lay out the flies.
16. Lace flies together and close weather flaps.
17. Connect the guy lines and slips.
18. Roll the flies towards the center.
19. Place the fly on the ridge extender and lock in place with a hitch pin.
20. Lace the roof blanket from ridge to eave on the other side.
21. Pull down the fly.
22. Place grommets of the sections over the eave spindles.

23. Place the eave extender on the eave spindle.
24. Place the section fabric under the fly and connect the eave purlin flaps.
25. With at least one man at every arch raise one side of the frame and place the locking pin in the eave joint.
26. Raise the other side of the tent and insert the locking pin.
27. Place the distribution box stand.
28. Place the distribution box and lay the cables over the header.
29. Place the light bars (make sure the light bar straps are in place).
30. Lay the single ply floor inside the tent and mate the hook and pile fastener.
31. Install the liners starting at the ridge and working down the sides.
32. Pull down the sides of the tent.
33. Becket lace from the eave to the base.
34. Tie off.
35. Inside the tent, connect the base purlin flaps.
36. Tie in the single ply floors.
37. Tie in the base of the liner.
38. Place the insulated floor in the tent and mate the hook and pile fastener.
39. Close all doors.
40. Place the wooden stakes for the guy lines.
41. Loop both guy liner over the pin.
42. Stake the base plates with the steel pin.
43. Stake the foot loops.
44. Tighten up the guy lines.
45. Install lights.