

113
468
12
TM
1944

U.S. Dept of Army

TM 11-1081

WAR DEPARTMENT TECHNICAL MANUAL

CLASS. CANCELLED

AUTH. WD CIR 387 1945

[REDACTED]

TEST SET AN/MPM-1

[REDACTED]

CONFIDENTIAL

RESTRICTED

WAR DEPARTMENT 7 NOVEMBER 1944

WAR DEPARTMENT TECHNICAL MANUAL

TM 11-1081 

TEST SET AN/MPM-1



WAR DEPARTMENT 7 NOVEMBER 1944

WAR DEPARTMENT,
WASHINGTON 25, D. C., 7 NOVEMBER 1944.

TM 11-1081, Test Set AN/MPM-1, is published for the information and guidance of all concerned.

[A: G. 300.7 (30 May 44).]

BY ORDER OF THE SECRETARY OF WAR:

G. C. MARSHALL,
Chief of Staff.

OFFICIAL:

J. A. ULIO,
Major General,
The Adjutant General.

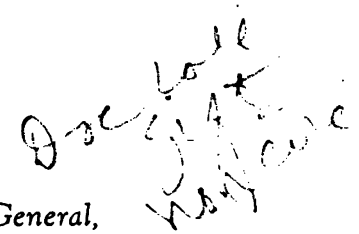

DISTRIBUTION:

AAF (Sig) (5); AGF (Sig) (5); ASF (Sig) (5); Arm & Sv Bd (2); Def Comd (2); T of Opn (5); Depts (5); Base Comd (5); SvC (Sig) (5); PE (Sig Sec) (2); ASF Dep (Sig Sec) (2); Overseas Dep 11(10); Gen Overseas SOS Deps (Sig Sec) (10); Pro Dists 11(2); Inspection Z 11(2); USMA (2); Rep Shops 11(2); A (Sig) (5); CHQ (Sig) (5); T/O & E 4-232(3); 4-240(3); 4-260-1(10); 4 copies to the following: T/O & E 11-107, 11-237, 11-357, 11-500, Sig Sv Orgn, Radar Teams (CC), (EC), (EG), (GQ); 11-587; 11-592; 11-597; 11-617; 44-16; 44-17; 44-116; 44-117; 44-138.

(For explanation of symbols see FM 21-6.)

U113
12

TM 11:1081
1944
★ ★

TABLE OF CONTENTS

SECTION	I. Description.	Par.	Page
	General	1	1
	Power	2	1
	List of components	3	1
	Calibrator I-178-A	4	2
	Test Set I-114	5	2
	Test Set I-115	6	3
	Remote Control Box BC-670-B	7	3
	Test Unit BC-708-A	8	4
	Test Unit I-235	9	4
	Radio Modulator BC-423-B (tweeter) ...	10	6
	Screen M-352	11	6
	Signal Generator I-126	12	6
	Field-strength meter	13	9
	Sight M-351	14	10
	Punch and Anvil Set TL-195	15	10
	Punch and Anvil Set TL-196	16	11
	Plug PL-217	17	12
	Plug PL-218	18	13
	Cords	19	13
	Chest CH-148	20	17
	Chest CH-273	21	17
	II. Installation and operation.		
	General	22	18
	Test Set I-114	23	18
	Test Set I-115	24	22
	Remote Control Box BC-670-B	25	23
	Test Unit BC-708-A	26	24
	Field-strength meter	27	24
	Sight M-351	28	25
	Punch and Anvil Set TL-195	29	27
	Punch and Anvil Set TL-196	30	28

TABLE OF CONTENTS

SECTION		Par.	Page
III.	Functioning of parts.		
	General	31	31
	Test Set I-114	32	31
	Test Set I-115	33	31
	Remote Control Box BC-670-B	34	35
	Test Unit BC-708-A	35	35
	Field-strength meter	36	35
IV.	Maintenance.		
	General	37	39
	Test Set I-114	38	39
	Test Set I-115	39	39
	Cords	40	41
	Tools	41	42
	Moistureproofing and fungiproofing	42	42
V.	Supplementary data.		
	Resistors and capacitors	43	49
	Maintenance parts list for Test Set AN/MPM-1	44	50

LIST OF ILLUSTRATIONS

<i>Fig. No.</i>	<i>Title</i>	<i>Page</i>
1	Test Set AN/MPM-1, general view	X
2	Calibrator I-178-A, front view	3
3	Test Set I-114, front view	4
4	Test Set I-115, front view	5
5	Remote Control Box BC-670-B, front view	5
6	Test Unit BC-708-A, front view	6
7	Test Unit I-235, front view	7
8	Radio Modulator BC-423-B, front view	7
9	Screen M-352, front view	8
10	Signal Generator I-126, front view	8
11	Field-strength meter assembly, front view	9
12	Sight M-351, in mounted position	10
13	Punch and Anvil Set TL-195, front view	11
14	Punch and Anvil Set TL-196, front view	11
15	Plug PL-217, showing internal connections	12
16	Plug PL-218, sketch	13
17	Test cords, sketch	15
18	Test cords, sketch	16
19	Chest CH-273, front view	17
20	Test Set I-114, in use	19
21	Test Set I-115, connections	23
22	Punch and Anvil Set TL-195, in use	28
23	Punch and Anvil Set TL-196, in use	29
24	Test Set I-114, schematic diagram	32
25	Test Set I-115, schematic diagram	33
26	Remote Control Box BC-670-B, schematic diagram	34
27	Test Unit BC-708-A, schematic diagram	36
28	Field-strength meter, theory of operation	37
29	Test Set I-115, sketch of test connections	41
30	Test Set I-115, masking details	45
31	Remote Control Box BC-670-B, masking details	46
32	Test Unit BC-708-A, masking details	47
33	Resistor color code chart showing use	49
34	Capacitor color chart showing use	50

DESTRUCTION NOTICE

WHY — To prevent the enemy from using or salvaging this equipment for his benefit.

WHEN — When ordered by your commander.

HOW — 1. Smash—Use sledges, axes, handaxes, pickaxes, hammers, crowbars, heavy tools.
2. Cut —Use axes, handaxes, machetes.
3. Burn —Use gasoline, kerosene, oil, flame throwers, incendiary grenades.
4. Explosives—Use firearms, grenades, TNT.
5. Disposal —Bury in slit trenches, fox holes, other holes. Throw in streams. Scatter.

USE ANYTHING IMMEDIATELY AVAILABLE FOR DESTRUCTION OF THIS EQUIPMENT.

WHAT — 1. Smash—Knobs, dials, switches, tubes.
2. Cut —Wires, cables.
3. Burn—Wires, cables, transformers, technical manuals.
4. Bend —Panels.
5. Bury or scatter—Any or all of the above pieces after destroying their usefulness.

DESTROY EVERYTHING

WARNING

HIGH VOLTAGE

**is used in the operation
of this equipment.**

DEATH ON CONTACT

**may result if personnel fail
to observe safety precautions.**

The major components of the radar equipment are contained within shielded cases with access doors which, when opened, automatically remove dangerous voltages from within the units. Remember that in several of the tests for which this equipment is used, safety interlocks must be short-circuited in order to make the necessary tests. Consequently, extreme caution must be exercised during these tests, since these safety devices have been placed in the units specifically to protect operating personnel.

FIRST AID TREATMENT FOR ELECTRIC SHOCK

I. FREE THE VICTIM FROM THE CIRCUIT IMMEDIATELY.

Shut off the current. If this is not immediately possible, use a dry nonconductor (rubber gloves, rope, board) to move either the victim or the wire. Avoid contact with the victim. If necessary to cut a live wire, use an axe with a dry wooden handle. Beware of the resulting flash.

II. ATTEND INSTANTLY TO THE VICTIM'S BREATHING.

Begin resuscitation at once on the spot. Do not stop to loosen the victim's clothing. Every moment counts. Keep the patient warm. Wrap him in any covering available. Send for a doctor. Remove false teeth or other obstructions from the victim's mouth.

RESUSCITATION

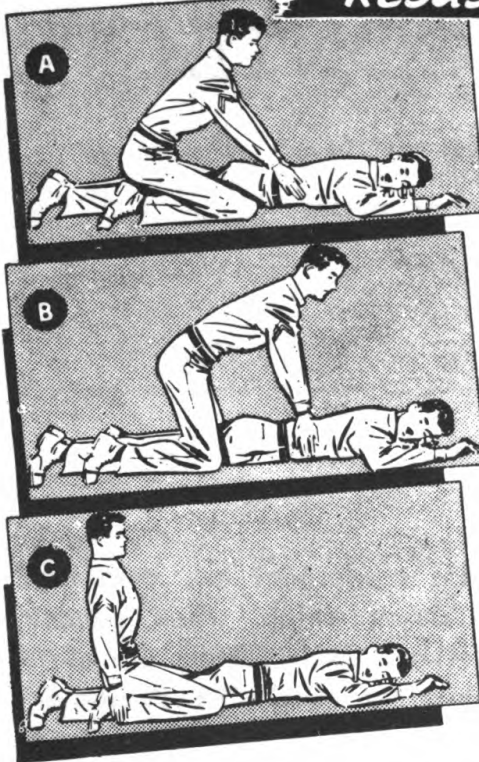

POSITION

1. Lay the victim on his belly, one arm extended directly overhead, the other arm bent at the elbow, the face turned outward and resting on hand or forearm, so that the nose and mouth are free for breathing (fig. A).
2. Straddle the patient's thighs, or one leg, with your knees placed far enough from his hip bones to allow you to assume the position shown in figure A.
3. Place your hands, with thumbs and fingers in a natural position, so that your palms are on the small of his back, and your little fingers just touch his lowest ribs (fig. A).

FIRST MOVEMENT

4. With arms held straight, swing forward slowly, so that the weight of your body is gradually brought to bear upon the victim. Your shoulders should be directly over the heels of your hands at the end of the forward swing (fig. B). Do not bend your elbows. The first movement should take about 2 seconds.

SECOND MOVEMENT

5. Now immediately swing backward, to remove the pressure completely (fig. C).
6. After 2 seconds, swing forward again. Repeat this pressure-and-release cycle 12 to 15 times a minute. A complete cycle should require 4 or 5 seconds.

CONTINUED TREATMENT

7. Continue treatment until breathing is restored or until there is no hope of the victim's recovery. Do not give up easily. Remember that at times the process must be kept up for hours.
8. During artificial respiration, have someone loosen the victim's clothing. Wrap the victim warmly; apply hot bricks, stones, etc. Do not give the victim liquids until he is fully conscious. If the victim must be moved, keep up treatment while he is being moved.
9. At the first sign of breathing, withhold artificial respiration. If natural breathing does not continue, immediately resume artificial respiration.
10. If operators must be changed, the relief operator kneels behind the person giving artificial respiration. The relief takes the operator's place as the original operator releases the pressure.
11. Do not allow the revived patient to sit or stand. Keep him quiet. Give hot coffee or tea, or other internal stimulants.

HOLD RESUSCITATION DRILLS REGULARLY

TL 37451

VIII

Digitized by Google

Original from
UNIVERSITY OF CALIFORNIA

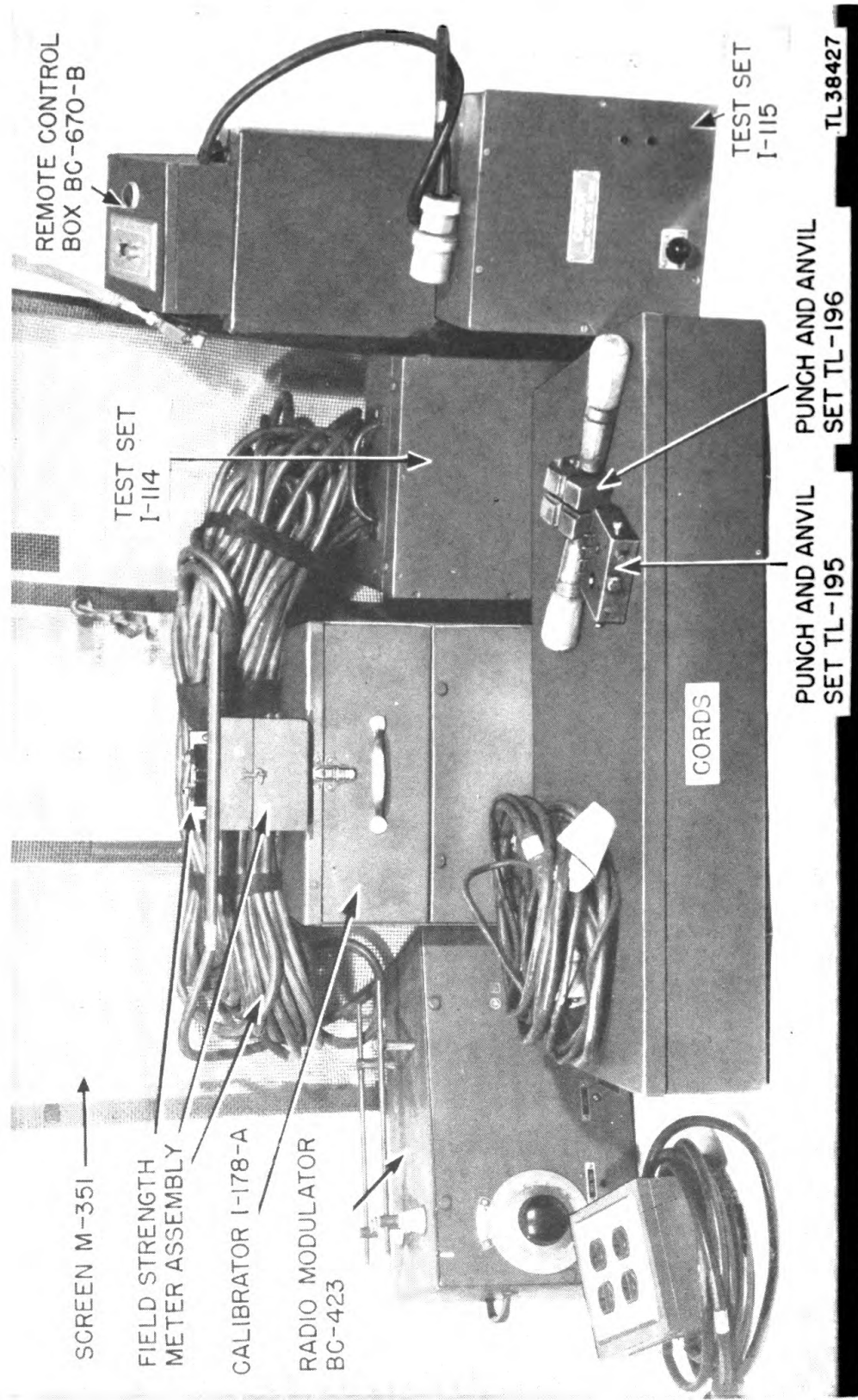

TL38427

Figure 1. Test Set AN/MPM-1, general view.



SECTION I

DESCRIPTION

1. GENERAL.

Test Set AN/MPM-1 consists of the special test equipment for Radio Sets SCR-268-A, SCR-268-B, and SCR-268-C, and for Radio Equipment RC-148. When the equipment included in this test set is used in conjunction with Test Set AN/GPM-1, all equipment necessary for third echelon maintenance will be available. Instructions covering the use of the test equipment with a specific radio set may be obtained from the technical manuals applicable to that set. The test set is carried in a wooden chest mounted on a shock-mounted base in the center of the van. The equipment included in Test Set AN/MPM-1 is shown in figure 1.

2. POWER.

The power for operating the test equipment can be obtained either from Power Unit PE-95 or from a commercial source. Outlet boxes for 110 volts are arranged on both sides of the van for convenience. There is also available 6-volt, 12-volt, and 24-volt d-c power supplied by batteries located in the front of the van. These batteries are charged by Rectifier Power Unit PP-34()/MSM. The details of the wiring inside the van and the location of the various items of equipment included with the van are covered in TM 11-1080 on Test Set AN/GPM-1.

3. LIST OF COMPONENTS.

The components of Test Set AN/MPM-1 are:

Quantity	Article	Signal Corps Stock No.
1	Calibrator I-178-A	3F2440-178A
1	Test Set I-114	3F4114
1	Test Set I-115	3F4115
1	Remote Control Box BC-670-B	2C7598B
1	Test Unit BC-708-A	3F4452-708
1	Test Unit I-235	3F4470-235
1	Radio Modulator BC-423-B	2C2453

Quantity	Article	Signal Corps Stock No.
1	Screen M-352	2Z8270
1	Signal Generator I-126	3F3900-126A
2	Field-strength meter assembly:	
	Ammeter IS-184	3F384
	Thermocouple M-322	3F4518-322
	Antenna tube assembly	1F4W1-90.31.5
1	Sight M-351	2Z9167-351
1	Punch and Anvil Set TL-195	6R7750
1	Punch and Anvil Set TL-196	6R7750-1
1	Plug PL-217	2Z7226-217
4	Plug PL-218	2Z7226-218
1	Cord CD-487	3E1487
1	Cord CD-488	3E1488
1	Cord CD-489	3E1489
1	Cord CD-490	3E1490
1	Cord CD-491	3E1491
1	Cord CD-518	3E1518
1	Cord CD-520	3E1520
1	Cord CD-728	3E1728
1	Cord CD-819	3E1819
2	Chest CH-148	3F2620-148
2	Chest CH-273	3Z2599-273

4. CALIBRATOR I-178-A.

This calibrator provides a method of calibrating Range Unit BC-436-A or BC-436-B by the comparison of two different range indications. The range shown on the indicator mechanically coupled to the range unit is compared to a range standard defined by electrical relationships on the screen of an oscilloscope. Figure 2 is a front view of the calibrator showing the controls. A detailed discussion of Calibrator I-178-A is contained in TM 11-1051, 20 January 1944.

5. TEST SET I-114.

This test set is provided mainly for testing the five synchronous repeaters of Radio Set SCR-268-(). An exterior view of this test set is shown in figure 3. The test set has two five-position switches, one of which selects the repeater to be tested; the other selects the pair of repeater windings to be tested. In addition to testing synchronous repeaters, Test Set I-114 can also be used to test for crossed, grounded, and open cable leads, or as an a-c voltmeter for voltages of 150 volts or less.



Figure 2. Calibrator I-178-A, front view.

6. TEST SET I-115.

The function of this test set is to provide an artificial load for the keying unit and to simulate the load presented by the modulator in normal operation. It also provides a connecting point for connecting the test oscilloscope across a fraction of the keyer output potential. The oscilloscope is then used to determine the characteristics of the keyer pulse. A front view of Test Set I-115 is given in figure 4.

7. REMOTE CONTROL BOX BC-670-B.

This test box is provided for remote control operation of the high-voltage circuit of Rectifier RA-38 at its panel. The unit is a small box with a start and stop switch, a red pilot light, and a 3-foot cable terminated in a four-pole plug, which connects into the rectifier in place of cable 22 coming from the keying unit. Figure 5 shows an exterior view of the test box, including the main controls on the front panel.

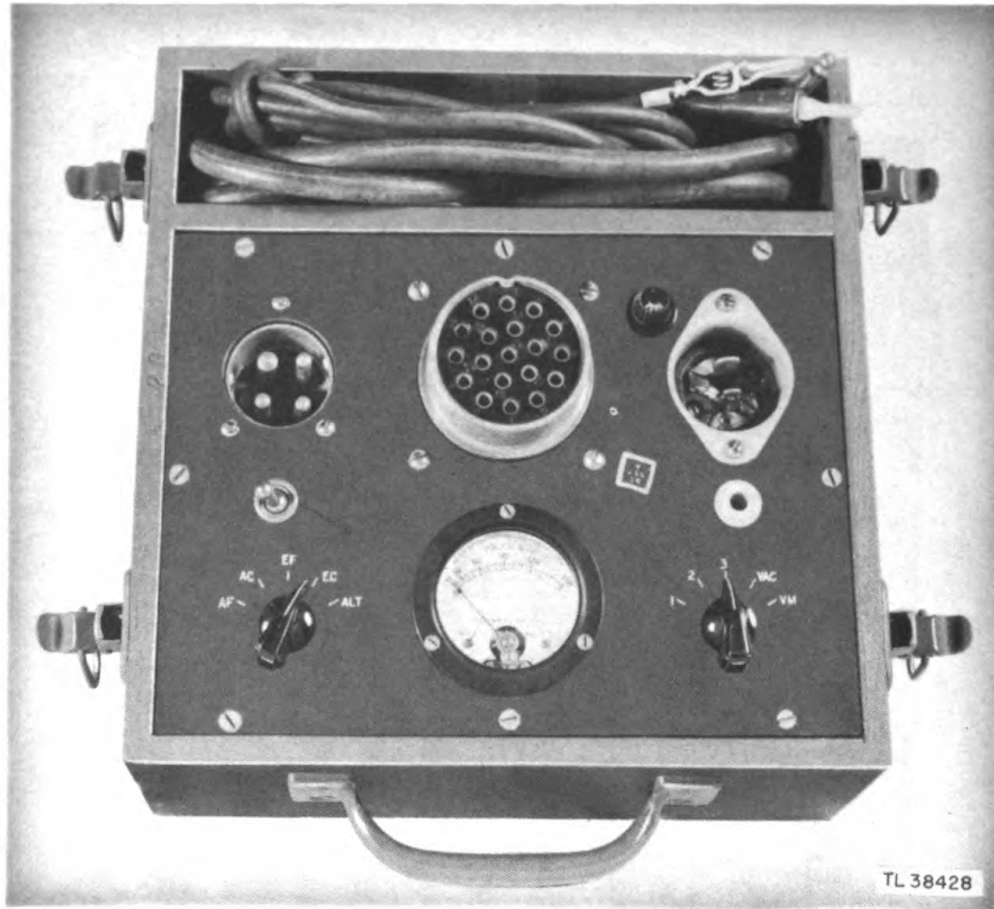

Figure 3. Test Set I-114, front view.

8. TEST UNIT BC-708-A.

The function of this receiver output box is to provide a means for connecting the output of Receiver BC-406 or BC-406-A to a test oscilloscope for testing and alignment purposes. An exterior view of Test Unit BC-708-A is given in figure 6. It is equipped with a variable resistor, a fixed resistor, and a toggle switch. The variable resistor simulates the sensitivity control normally located in the oscilloscope, and the fixed resistor takes the place of a similar resistor in the oscilloscope and completes the plate circuit of the switching amplifier in the receiver. The toggle switch controls the switching of the *hot* lead which is connected to the high terminal of the vertical deflection plates of the test oscilloscope.

9. TEST UNIT I-235.

This instrument is provided for the purpose of tuning the local oscillator in the receiver while it is being tested or repaired. It is a small unit consisting of a reversing switch and cord which replaces a similar control that is mounted on the side of the azimuth oscilloscope in normal operation.

The cord is connected through a plug on the base of the receiver to a small motor which is mounted on the receiver chassis. This motor is directly connected to the local oscillator tuning capacitor.

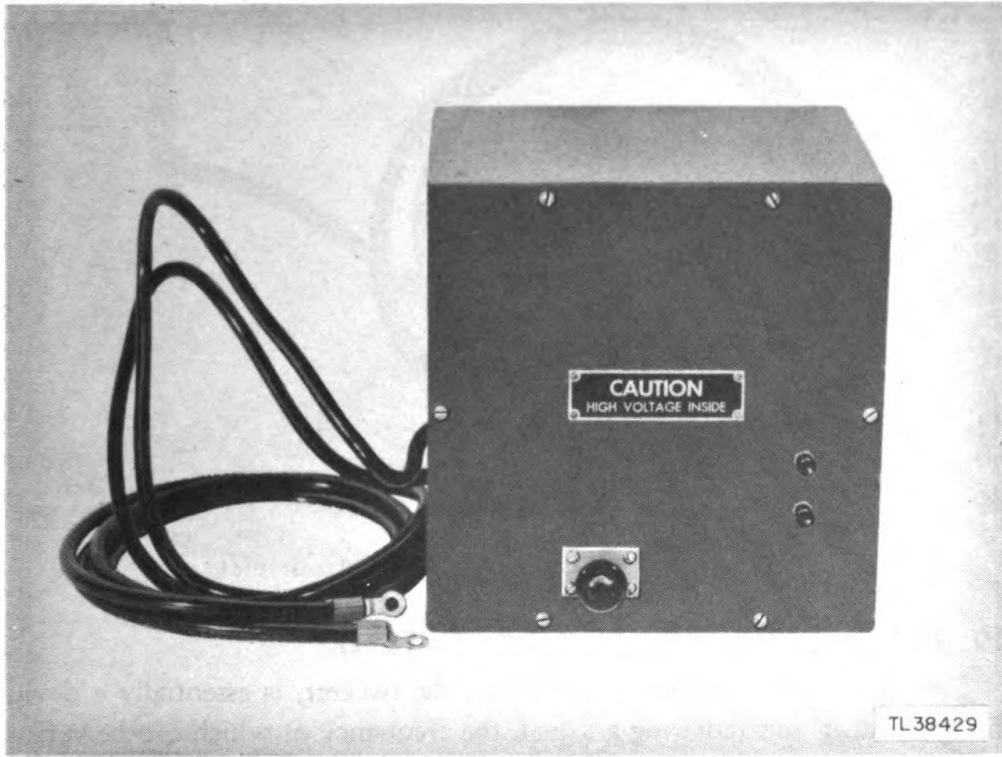

Figure 4. Test Set I-115, front view.

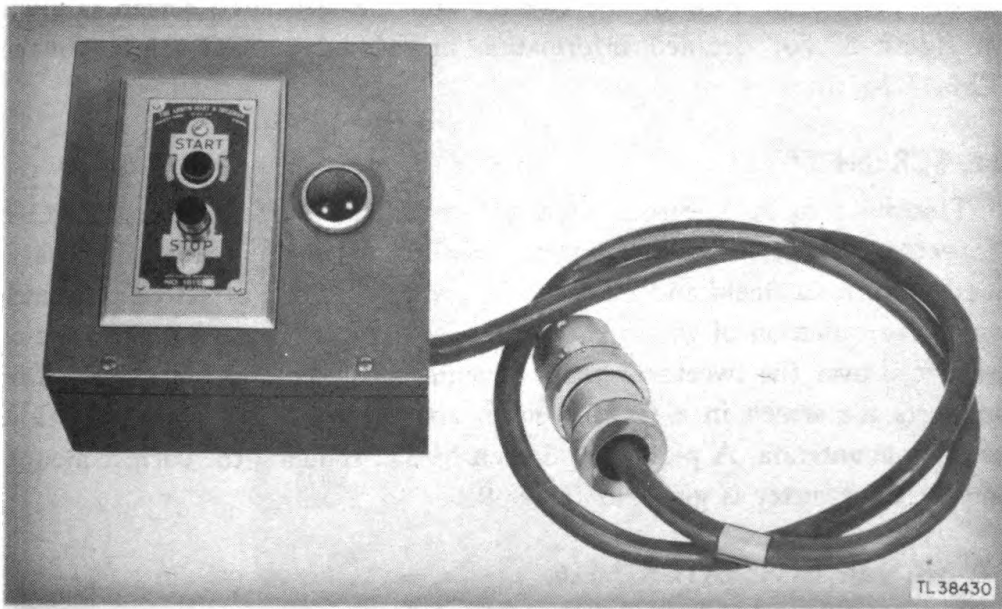

Figure 5. Remote Control Box BC-670-B, front view.

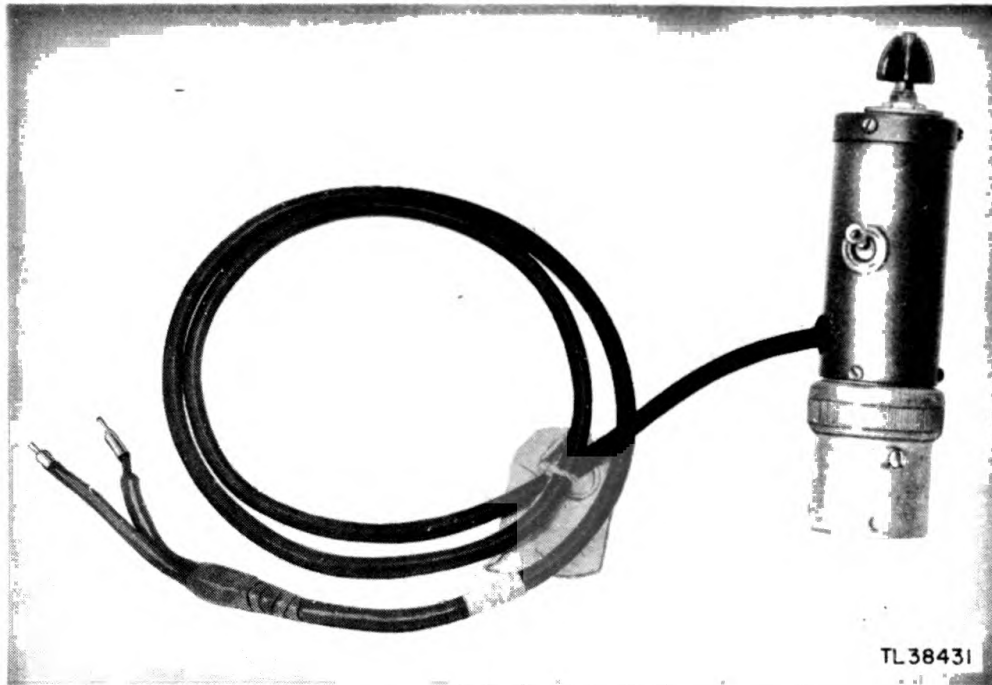

Figure 6. Test Unit BC-708-A, front view.

10. RADIO MODULATOR BC-423-B (TWEETER).

This instrument, commonly known as the tweeter, is essentially a device for generating and radiating a signal, the frequency of which can be varied. This signal is useful in adjusting and testing the receiving antennas and receivers of the radio set. Modulator BC-423-B simulates the functions of Transmitter BC-407-A; the transmitter is turned off when the tweeter is used. An exterior view of the tweeter and the associated screen is given in figure 8. For detailed information on Modulator BC-423-B, consult TM 11-2636.

11. SCREEN M-352.

This wire mesh screen is used to cover Radio Modulator BC-423-B (tweeter) when the buried tweeter method of aligning the antennas is used. It forms a shield and reflector for the tweeter and effectively grounds any stray radiation of the signal. Small openings in the screen permit it to be placed over the tweeter without touching the dipole and wooden frame supports the screen in a fixed position above the tweeter case and below the dipole antenna. A picture of Screen M-352 showing the correct mounting on the tweeter is given in figure 9.

12. SIGNAL GENERATOR I-126.

The function of this instrument is to furnish a signal of desired radio frequency, which is used for the alignment of radio receivers and other

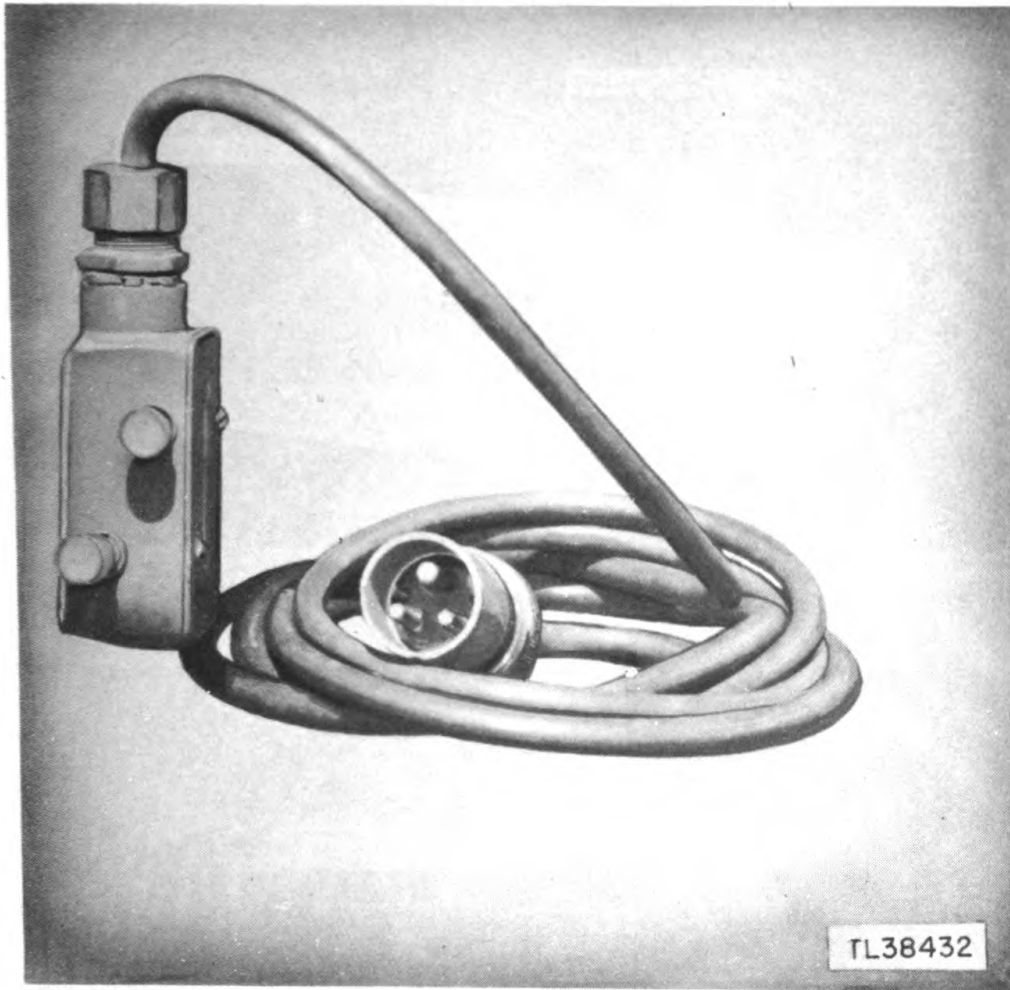

Figure 7. Test Unit I-235, front view.

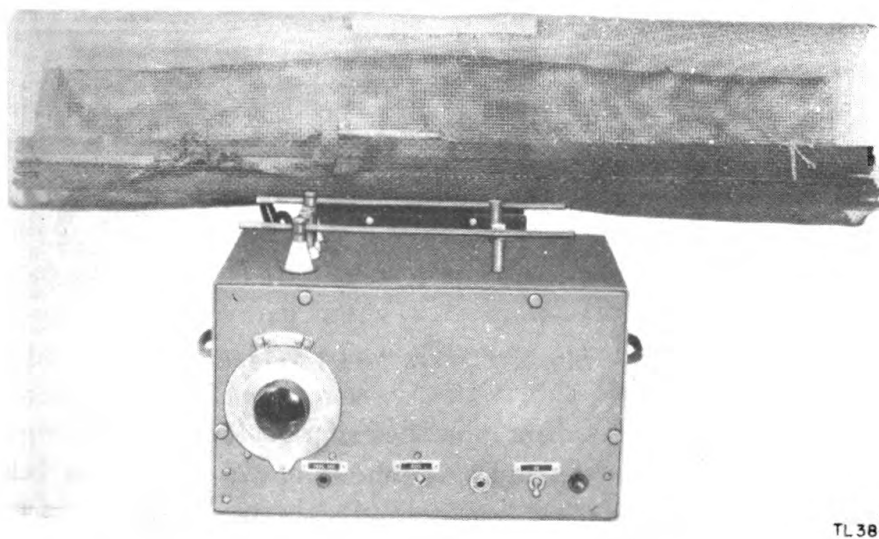

Figure 8. Radio Modulator BC-423-B, front view.

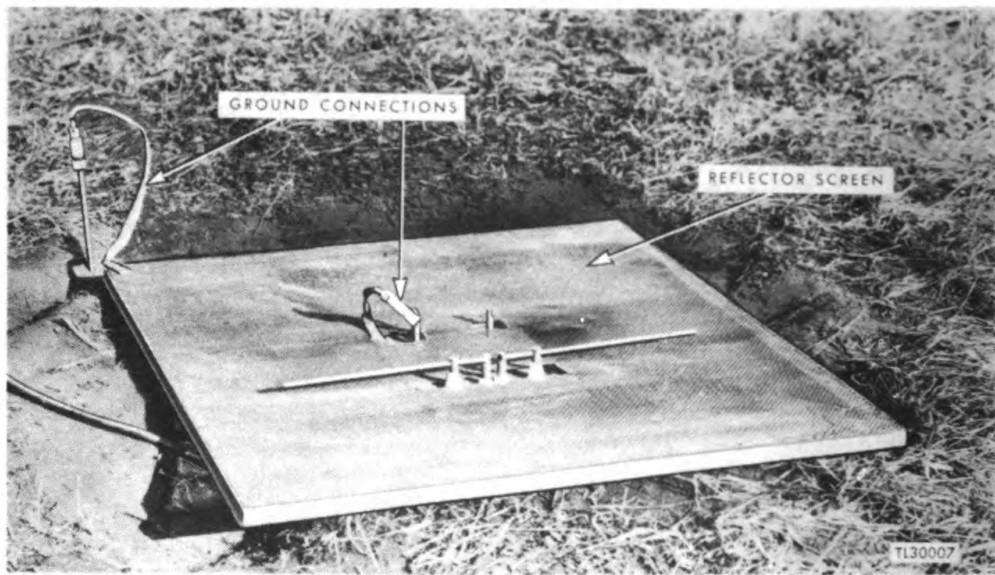

Figure 9. Screen M-352, front view.



Figure 10. Signal Generator I-126, front view.

test operations. This instrument generates r-f signal voltage in two bands; band A, 15 to 25 megacycles and band B, 195 to 225 megacycles. Selection of the desired frequency band is accomplished by means of a plunger type **RANGE** switch operated from the front of the panel. The signal may be unmodulated or it may be modulated, at approximately 30 percent, by an

audio frequency of 400 or 8,200 cycles, depending on the setting of the **MODULATION** switch. The desired frequency is then selected by turning the **FREQUENCY** knob to the correct setting of the dial. A calibration chart covering both frequency bands is mounted on the front panel. A signal output up to 100,000 microvolts can be obtained by proper setting of the **ATTENUATOR** dial. The output meter, located on the front panel of the signal generator, indicates the oscillator grid current. The meter needle should be adjusted by means of the **R.F. OUTPUT** knob so that it rests directly on the single division in the center of the scale. It is necessary to make this adjustment each time the output frequency of the signal generator is changed. A detailed discussion of Signal Generator I-126 is contained in TM 11-1063. An external view of Signal Generator I-126 is given in figure 10.

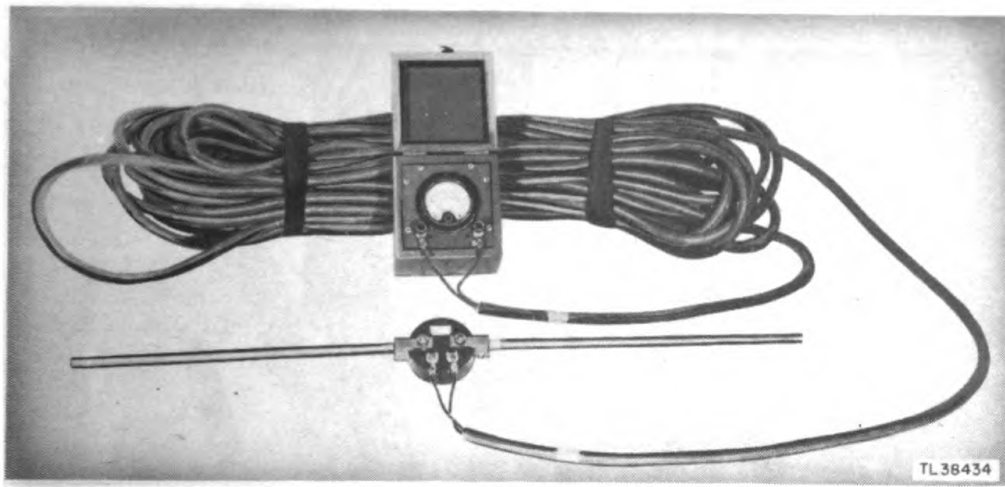

Figure 11. Field-strength meter assembly, front view.

13. FIELD-STRENGTH METER.

The primary function of the field-strength meter is to measure the relative r-f signal output from the antenna of the radio set. It may also be used to determine approximately the radiation pattern of the antenna. This unit consists of a meter, a thermocouple, and a dipole. In order to measure r-f currents of high frequencies, a thermocouple-type meter must be used. The thermocouple consists of two dissimilar metal wires fastened together at a junction point. The amount of heat at this point, determined by the r-f energy, provides a relative deflection of the meter needle. The dipole consists of two pieces of copper tubing that are connected to separate terminals on the back of the thermocouple. When the two sections of the antenna are in place on the thermocouple, the over-all length of the antenna is approximately one-half wavelength. The meter is a sensitive milliammeter.

Figure 11 is an external view of the field-strength meter showing the component parts.

14. SIGHT M-351.

This sight is mounted on the antenna beam for the purpose of aligning the mechanical axis of the radio set with the electrical axis. Sight M-351 consists of an eyepiece and cross hairs set in a bar which is fastened to a mounting that includes an elevation and azimuth adjustment mechanism. The mounting is fastened by means of a pivot screw to a support which is used to mount the complete sight assembly. When the sight is properly adjusted, a fixed object or an aerial target being tracked by the radio set, should center exactly between the horizontal and vertical bars of the sight. Figure 12 shows the sight mounted on the antenna beam in the proper location.

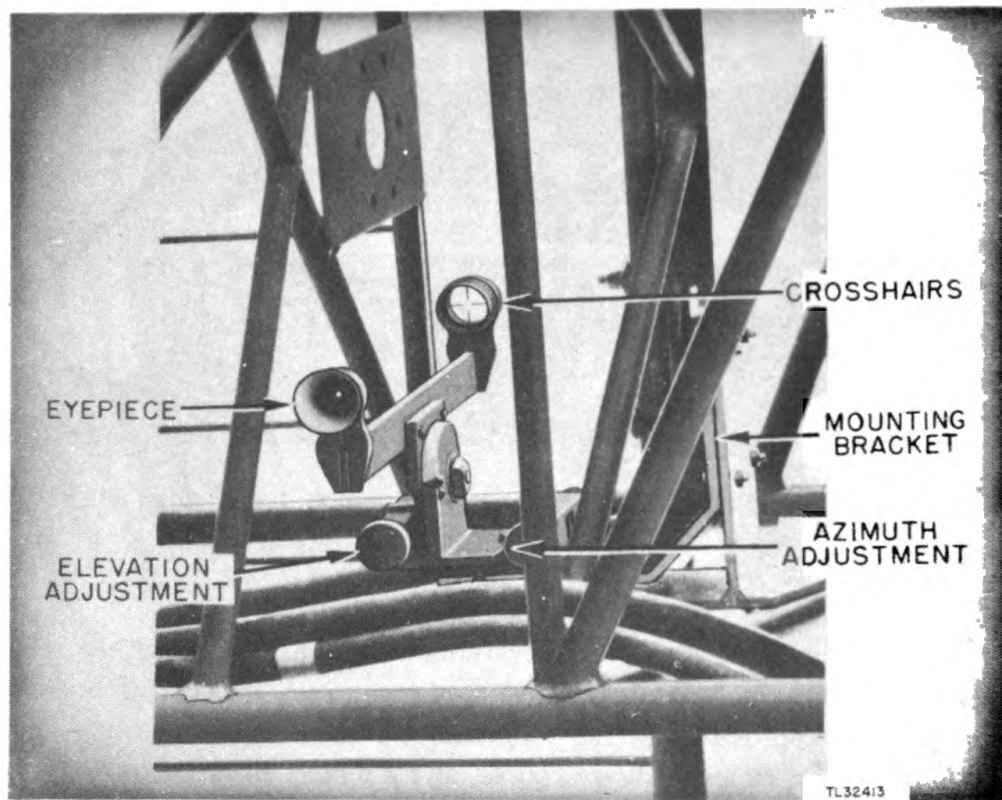

Figure 12. Sight M-351 in mounted position.

15. PUNCH AND ANVIL SET TL-195.

This set is a special tool furnished for making repairs on the antenna or transmission lines. It consists of a metal block containing slots which will fit the various different sizes of tubing on the antenna. A punch is also

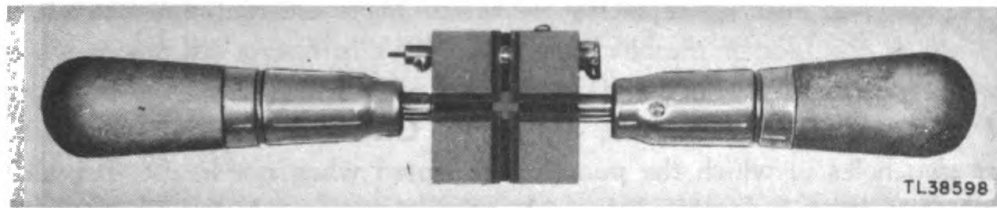

Figure 13. *Punch and Anvil Set TL-195, front view.*

furnished with this set for removing escutcheon pins from the fittings on the antenna tubing. Figure 13 shows Punch and Anvil Set TL-195 with its component parts.

16. PUNCH AND ANVIL SET TL-196.

Punch and Anvil Set TL-196 is furnished for the purpose of maintenance on the grid and plate ball assemblies in Transmitter BC-407-A. It is a metal anvil having two countersunk holes of different sizes in which the balls may be placed. These holes are ground so that the balls fit snugly when placed in the proper holes. The larger hole is for the plate balls and the smaller hole is for the grid balls. From each of the countersunk holes there is a groove extending to another hole in the anvil. These grooves

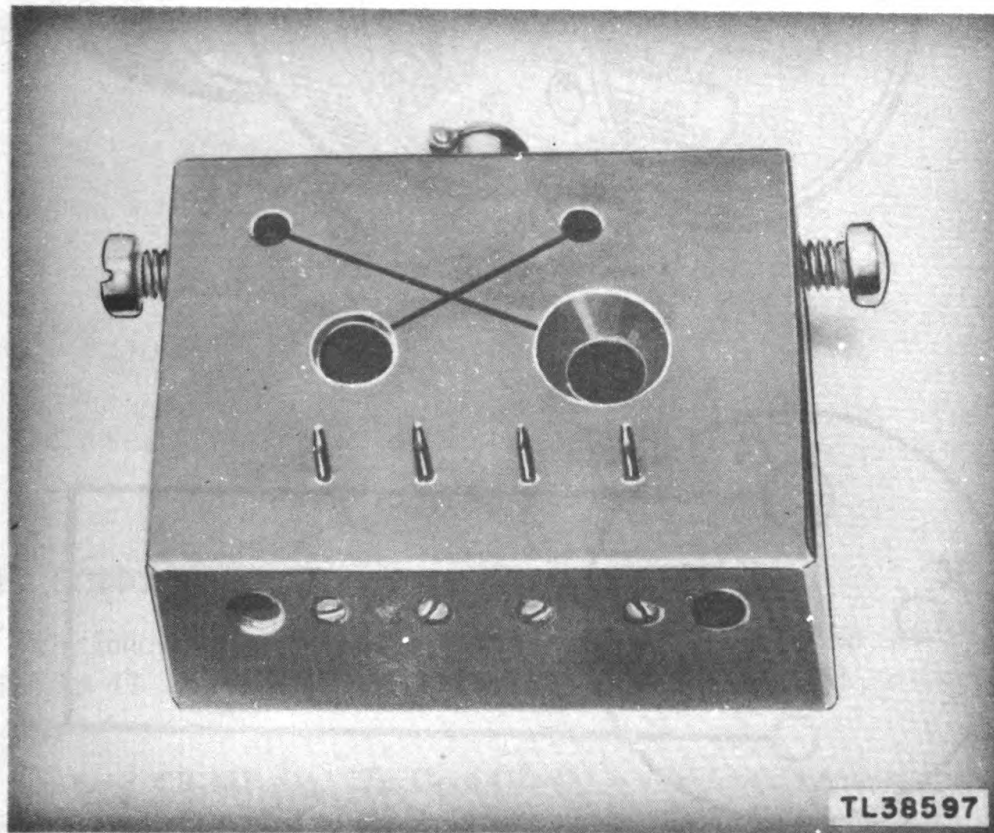
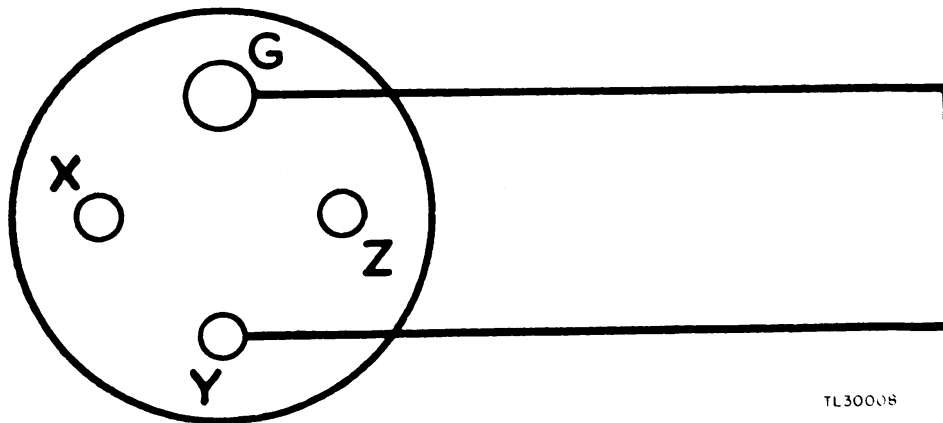
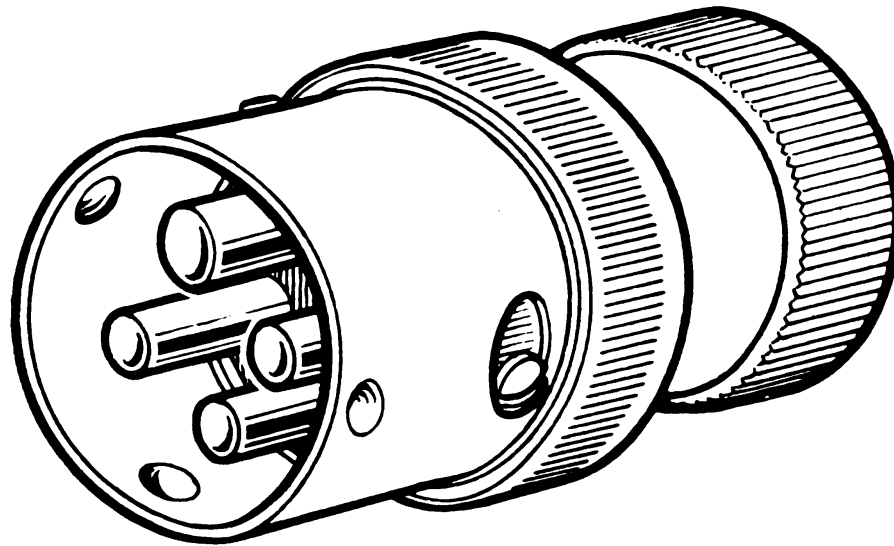

Figure 14. *Punch and Anvil Set TL-196, front view.*

serve as guide lines for replacing the braid. There are four pins extending up out of the face of the block on which the clip inserts are placed when sweating them to the braid. Two punches are furnished for the purposes of removing and replacing the clip inserts. On the side of the anvil there are two holes in which the punches are stored when not in use. Between these two holes is another hole with a spring cap in which extra pins are stored. Figure 14 is an external view of Punch and Anvil Set TL-196 and the associated tools.

17. PLUG PL-217.

This plug is inserted into the TO MODULATOR socket on the keying unit when it is being tested on a work bench. The plug connects the Y



TL30008

Figure 15. Plug PL-217, showing internal connections.

terminal to the ground terminal and takes the place of the interlock circuit in the modulator. An outline sketch and the internal connections of Plug PL-217 is shown in figure 15.

18. PLUG PL-218.

The function of Plug PL-218 is to provide an impedance matching device when the receiver is being aligned or tested by means of the r-f signal generators provided with the test equipment. Two of these plugs are used, one in series with each leg of the signal generator output terminals and the receiver-antenna terminals. The plug has a banana-type plug on one end which is inserted into the receiver-antenna input jacks. On the other end of each one is an open spade-type lug to which the signal generator output terminals are connected. A view of Plug PL-218 is shown in figure 16.

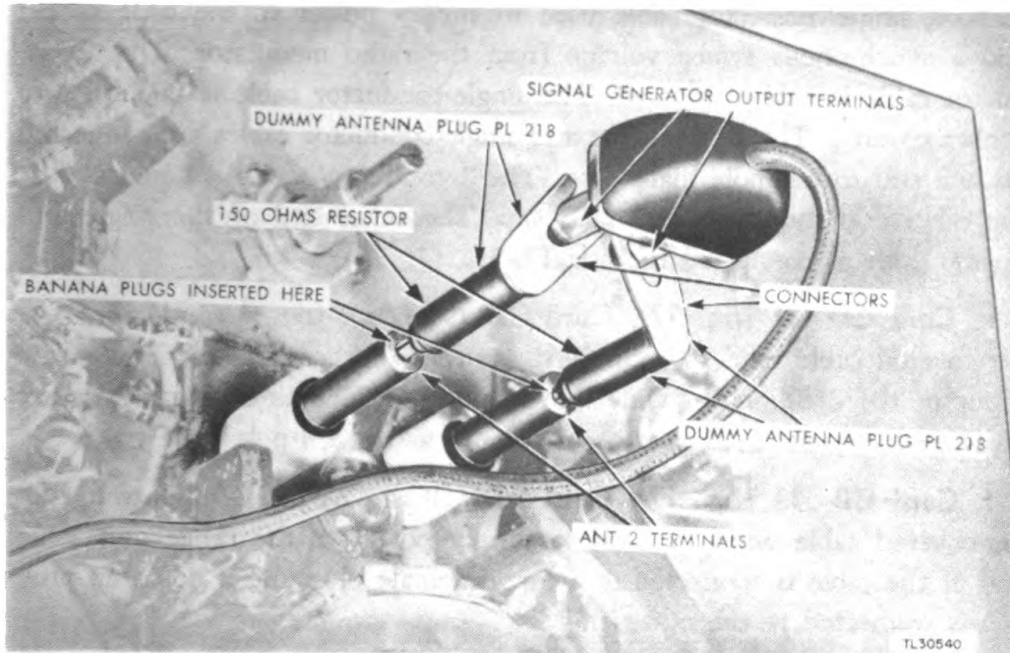

Figure 16. Plug PL-218, sketch.

19. CORDS.

The following is a list of the cords contained in Test Set AN/MPM-1. Figures 17 and 18 show the complete set of cords and their connecting plugs.

a. Cord CD-487 (fig. 17). Cord CD-487 is a 16-foot, 2-conductor, rubber-covered cable used to supply power to the radio receiver. It has a 3-pole male plug on one end and a polarized plug cap on the other end.

b. Cord CD-488 (fig. 18). Cord CD-488 is a 12-foot, 3-conductor, rubber-covered cable used to connect the output of the radio receiver to the input of the oscilloscope while mounted on the trailer. It is a shielded cable with a 4-pole male plug on each end. One of the conductors is opened 5 feet from one end, and the two ends are each connected to a crocodile clip which is covered with a black rubber insulator.

c. Cord CD-489 (fig. 18). Cord CD-489 is a 6-foot, 2-conductor, and a 6-foot, single-conductor cable used to supply power to the keying unit and to obtain a synchronous voltage. The 6-foot, 2-conductor cable is rubber-covered. The 6-foot, single-conductor cable is shielded and rubber-covered. Both are connected on one end to a 4-pole female plug. The free end of the single conductor is connected to an insulated crocodile clip and the shield is also connected to an insulated crocodile clip. The 2-conductor cable is connected at its free end to a polarized plug cap.

d. Cord CD-490 (fig. 18). Cord CD-490 is a 12-foot, 2-conductor, and 16-foot, single-conductor cable used to supply power to the oscilloscope, and a synchronous sweep voltage from the radio modulator. The 2-conductor cable is rubber covered. The single-conductor cable is shielded and rubber covered. The 2-conductor and single-conductor cables are connected on one end to a 4-pole male plug. The 2-conductor cable is connected at the other end to a polarized plug cap. The other end of the single-conductor cable is connected to Plug PL-55.

e. Cord CD-491 (fig. 17). Cord CD-491 is a 6-foot, 3-conductor, rubber-covered cable used to connect the output of the radio receiver to the input of the oscilloscope while in test position. The three conductors are individually shielded. Both ends are connected to a 4-pole male plug.

f. Cord CD-518 (fig. 17). Cord CD-518 is a 6-foot, 2-conductor, rubber-covered cable which is used to supply power to the range unit. One end of the cable is connected to a 3-pole female plug and a polarized plug cap is connected to the other end.

g. Cord CD-520 (fig. 17). Cord CD-520 is a 250-foot, 4-conductor, rubber-covered cable with one of the conductors shielded. It is used to supply power to the radio modulator and to transfer the synchronous voltage from the radio modulator to the units on the trailer while adjusting the antennas. A 4-pole male plug is connected on one end, and a 4-pole female plug is connected on the other end.

h. Cord CD-728-A (fig. 17). Cord CD-728-A is a 150-foot, 2-conductor, rubber-covered cable which connects the thermocouple to the milliammeter on the field-strength meter assembly. Both ends of each conductor are connected to an open end spade-type lug.

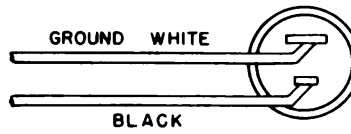
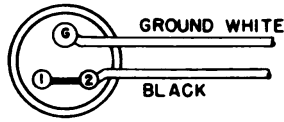
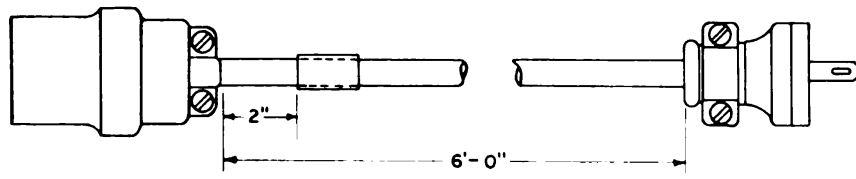

CD-487

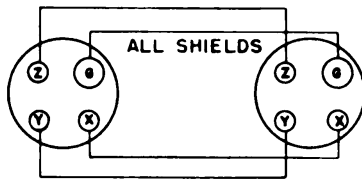
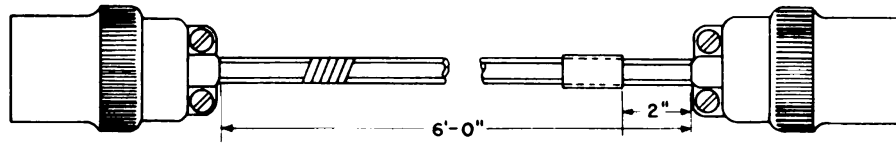

CD-491

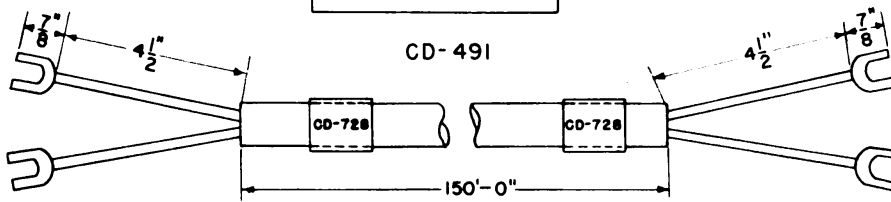

CD-728

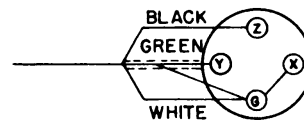
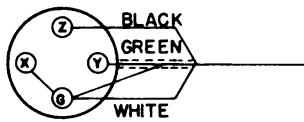
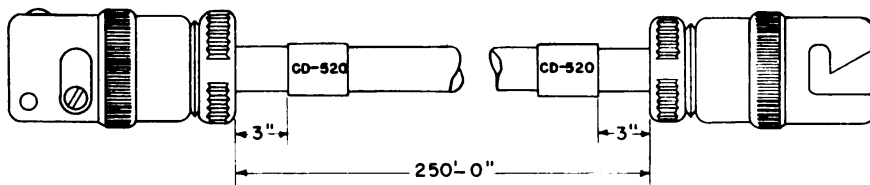

CD-520

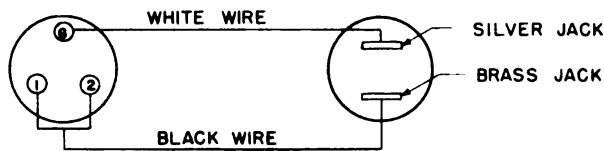
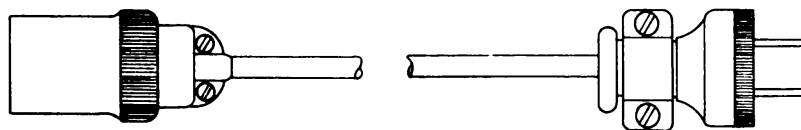

CD-518

1L38762

Figure 17. Test Cords, sketch.

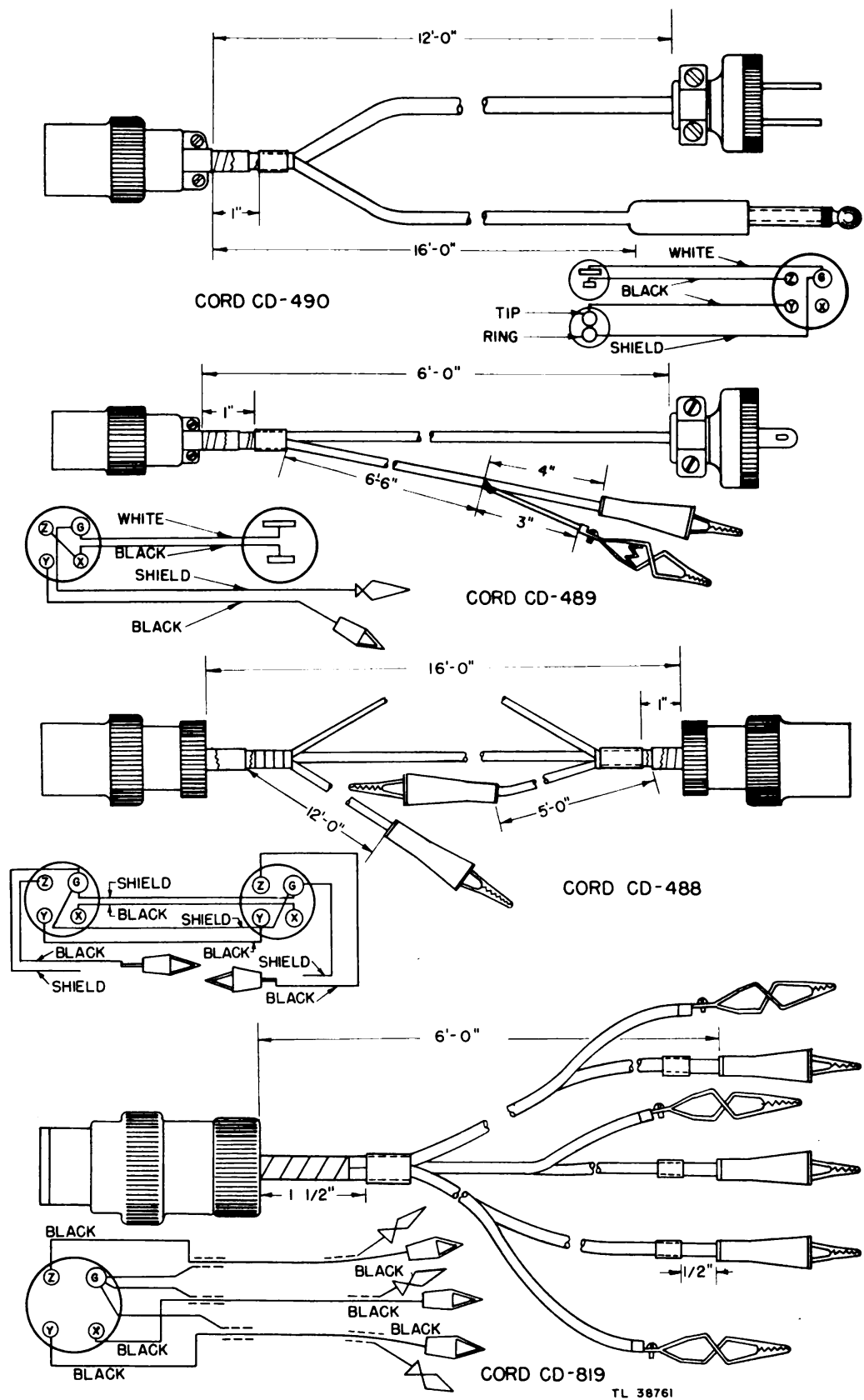

Figure 18. Test Cords, sketch.

i. **Cord CD-819 (fig. 18).** Cord CD-819 is a 6-foot cable composed of three 6-foot lengths of single conductor, individually shielded, and rubber-covered. It is used to connect the audio-frequency signal generator to the oscilloscope when testing the vertical line and spread on the oscilloscope. One end of each conductor is connected to a 4-pole female plug. The other ends, shields and conductors, are connected to six crocodile clips. Rubber insulators are placed over the clips connected to the conductors.

20. CHEST CH-148.

This chest is furnished for storing the field-strength meter when not in use. It is a small wooden chest $4\frac{1}{2}$ inches long, $4\frac{1}{2}$ inches wide, and $3\frac{3}{8}$ inches high.

21. CHEST CH-273.

Two of these chests are furnished for storing the test equipment of Test Set AN/MPM-1 when it is not in use. They are large wooden chests $42\frac{1}{2}$ inches long, $22\frac{1}{4}$ inches wide, and $20\frac{3}{4}$ inches high, and are carried on Chest Mount FT-502 in the center of the van.

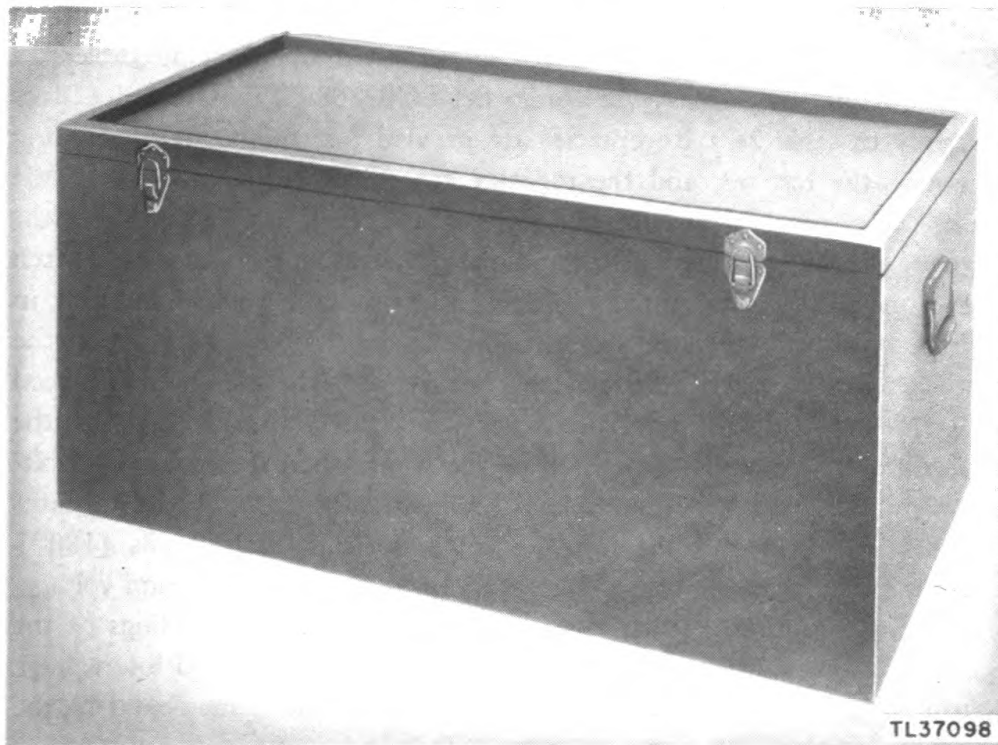

Figure 19. Chest CH-273, front view.

SECTION II

INSTALLATION AND OPERATION

22. GENERAL.

A detailed description of the use of the test equipment contained in Test Set AN/MPM-1 is contained in this section. Throughout this section refer to the functional diagrams, pictures, and sketches contained herein. If any information on a particular test instrument is desired, and is not covered in this section, refer to the technical manual written for that specific test instrument.

23. TEST SET I-114.

a. Operation. When testing repeaters, cable 27, which is normally connected to the gun director, is usually plugged into the 19-terminal receptacle of the test set. The repeaters may also be tested by plugging cables 15 or 24 into this receptacle. (For Radio Set SCR-268-C, the foregoing does not apply to cable 24.) Receptacles are provided for connecting alternating current to the test set, and the repeater switch located on the lower left side of the test set is used to connect this alternating current to the rotor of one of the five repeaters in the radio set. By setting the voltmeter switch in any one of the first three positions, the resultant voltage induced in any two of the three stator windings of the repeater can be read on the voltmeter. The repeater rotor is then turned and the maximum induced voltage determined. By reference to the associated altitude dial, or the angular-height counter, the position of the rotor when the maximum voltage was induced may be determined. A satisfactory test of the repeater windings is indicated if the repeater rotor is turned 3,200 mils (180°) from one point of maximum voltage to the next point of maximum voltage. Repeat this test for the other two combinations of stator windings of the repeater. A continuity test is also made of the cable leads and low-voltage slip ring contacts between the test set and the repeater, incidental to the test of the repeater windings.

b. Locating and Connecting. Figure 20 is a functional diagram showing the location of the test set in the test circuit. Locate the test set near an appliance outlet, such as the outlet on the keyer, and close enough to the trailer mount to permit easy communication between the man making

the test and the man operating the controls on the trailer. Connect the test set as shown in figure 20. Alternating current may be connected to the test set either by cable 9, Test Cord CD-520, or test cord H. When the test set is connected, one of its a-c receptacles will not be used. Avoid short-circuiting the live terminals in the unused male receptacle. The setting of the switches on the test set select the repeater, and stator windings of the repeater under test, as shown in the table below.

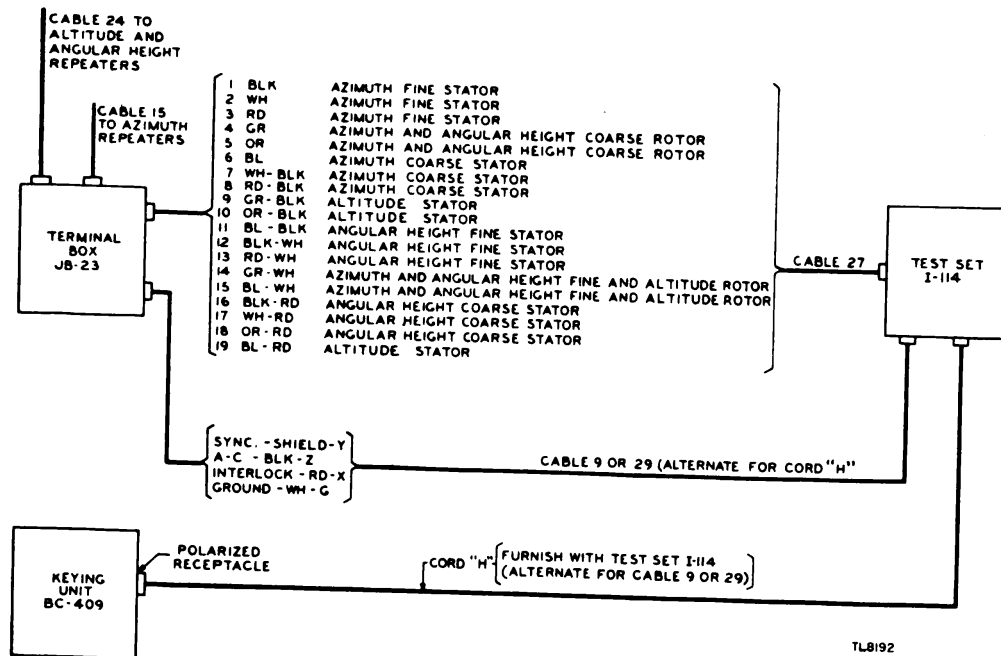

Figure 20. Test Set I-114, connections.

TABLE I
 TEST SWITCH SETTINGS FOR TESTING STATOR WINDINGS OF SYNCHRONOUS REPEATERS

Test set switch settings		A-c across cable leads (rotor)	Voltmeter across cable leads (stator)	Provides test of repeater stator windings
Repeater switch	Voltmeter switch			
AF	1	14 and 15	1 and 2	Azimuth, fine
AF	2	14 and 15	1 and 3	Azimuth, fine
AF	3	14 and 15	2 and 3	Azimuth, fine
AC	1	4 and 5	6 and 7	Azimuth, coarse
AC	2	4 and 5	6 and 8	Azimuth, coarse
AC	3	4 and 5	7 and 8	Azimuth, coarse
EF	1	14 and 15	11 and 12	Angular height, fine

Test set switch settings		A-c across cable leads (rotor)	Voltmeter across cable leads (stator)	Provides test of repeater stator windings
Repeater switch	Voltmeter switch			
EF	2	14 and 15	11 and 13	Angular height, fine
EF	3	14 and 15	12 and 13	Angular height, fine
EC	1	4 and 5	16 and 17	Angular height, coarse
EC	2	4 and 5	16 and 18	Angular height, coarse
EC	3	4 and 5	17 and 18	Angular height, coarse
ALT	1	14 and 15	9 and 10	Altitude
ALT	2	14 and 15	9 and 19	Altitude
ALT	3	14 and 15	10 and 19	Altitude

c. Test of Repeater Windings. (1) Position the antennas at an angular height of about 750 mils, as indicated by the counter on the converter. Operate the toggle switch on the test set, and note the reading of the test set voltmeter.

(2) If the voltmeter does not deflect, there may be a poor connection between the prongs of the cable connector on cable 27 and the test set receptacle. Press the cable connector firmly into the test receptacle to eliminate this possibility. Other causes of failure of the voltmeter to deflect are: open cable leads, faulty slip ring, open repeater winding or connection, and rotor of repeater in such a position that no voltage is being induced in the particular stator winding under test. Move the voltmeter switch to a different one of its first three positions. If the voltmeter still does not deflect, an open circuit is indicated. Cable 27 may be eliminated as a possible source of trouble by disconnecting cable 15 (for azimuth repeaters) from the terminal box, and plugging this cable into the test set instead of cable 27.

(3) If the voltmeter deflects when the toggle switch on the test set is operated, have an assistant rotate the proper handwheel on the trailer mount to change the position of the repeater under test until the voltage indicated on the meter is a maximum. (Use the range handwheel for positioning the altitude repeater.) With the a-c voltage at 120 volts, this maximum voltage should be 108 to 112 volts. In the case of the coarse angular-height repeater, it will not be possible to obtain this voltage on one and sometimes two of the stator windings, because it is normally rotated only about 87° when the elevation handwheel is rotated from one stop position to the other. On these windings, all that can be done is to note that the voltage changes as the elevation handwheel is rotated.

(4) With the voltage at a maximum, note the following readings:

<i>Repeater under test</i>	<i>Reading</i>
Coarse or fine azimuth	Azimuth (mils) on azimuth ring on trailer mount
Coarse angular height	No reading.
Fine angular height	Elevation (mils) on converter angular-height counter.
Altitude	Altitude (yards) on converter altitude dial.

(5) Again rotate the proper handwheel so as to rotate the repeater rotor 180°. The voltage read on the test set meter should decrease to zero and then increase to the maximum value as previously read. The change in the previous scale or counter reading will be as follows, to move to rotor 180°.

<i>Repeater under test</i>	<i>Change in reading</i>
Coarse azimuth	3,200 mils
Fine azimuth	200 mils
Fine angular height	200 mils
Altitude	5,000 yards

(6) To measure the a-c voltage at the test set on boxes having serial number 244 or higher, set the voltmeter switch in the VM position. On test sets having serial number 243 or lower, plug cord J into the jack on the instrument panel, set the voltmeter in the VAC position, and touch the insulated clip of this cord to some part connected to the ground system, such as the grounded terminal of the unused a-c receptacle of the test set.

d. Other Uses of Test Set I-114. Test set I-114 is intended primarily for testing repeaters, but it has several other uses. Plug cord J into the jack on the test set instrument panel for all of the following applications of the test set.

(1) **TO MEASURE VOLTAGES OF 150 VOLTS OR LESS (TEST SETS HAVING SERIAL NUMBER 243 OR LOWER).** Connect the alligator clips of cord J across the voltage to be measured, and set the voltmeter switch in the VM position.

(2) **TO CHECK FOR GROUNDED CABLE LEADS.** Connect alternating current to the test set (fig. 20). Cable 27 need not be connected. Set the voltmeter switch in the VAC position, and operate the toggle switch on the test set. Touch the insulated clip of cord J to the lead in question. If the voltmeter does not deflect, the lead is not grounded. If the voltmeter deflects, note the reading. Move the voltmeter to the VM position and note the voltmeter reading. If the two readings are the same, the lead is grounded through little or no resistance. If the first reading is less than the second, the lead is grounded through a resistance path.

(3) TO CHECK FOR CROSSED CABLE LEADS.

(a) Connect alternating current to the test set (fig. 20). Cable 27 need not be connected. Set the voltmeter switch in the VAC position, and operate the toggle switch. Disconnect both ends of the lead under test.

(b) On test sets having serial number 244 or higher, connect the noninsulated alligator clip of cord J to one of the cable leads. Then touch the insulated alligator clip to each of the other leads of the cable, observing whether the test set voltmeter deflects as any of the leads are touched. If the voltmeter does not deflect, none of the leads in the cable are crossed with the lead to which the noninsulated clip of cord J is connected. A deflection indicates crossed leads. Continue in this manner until tests have been made with the noninsulated clip of cord J connected to each of the other leads in the cable.

(c) On test sets having serial number 243 or lower, connect ground to one of the cable leads by Test Cord CD-503. Then touch the insulated alligator clip of cord J to each of the other leads of the cable, observing whether the test set voltmeter deflects as any of the leads are touched. If the voltmeter does not deflect, none of the leads in the cable are crossed with the grounded lead. A deflection indicates crossed leads. Continue in this manner with ground connected to each of the other leads in the cable.

(4) TO CHECK FOR CONTINUITY OF A LEAD.

(a) Connect alternating current to the test set (fig. 20). Cable 27 need not be connected. Set the voltmeter switch in the VAC position, and operate the toggle switch. Disconnect both ends of the lead under test.

(b) On test sets having serial number 244 or higher, connect one of the alligator clips of cord J to one end of the lead and the other alligator clip to the other end of the lead. If the voltmeter does not deflect, the lead is open. If the voltmeter deflects, note the reading. Then move the voltmeter to the VM position and again note the voltmeter reading. If the two readings are the same, or practically the same, the lead is continuous and of low resistance.

(c) On test sets having serial number 243 or lower, connect ground to one end of the leads under test by Test Cord CD-503. Then connect the insulated clip of cord J to the other end of the lead. If the voltmeter does not deflect, the lead is open. If the voltmeter deflects, note the reading. Then touch the insulated clip of cord J to the ground and again note the voltmeter reading. If the two readings are the same, the lead is continuous and of low resistance.

24. TEST SET I-115.

a. Operation. Although Test Set I-115 does not actually perform a

test on the keying unit, it performs a very important function when tests on the keying unit are being made. Test Set I-115 creates an artificial load for the keying unit and simulates the action of the modulator unit under normal conditions of operation.

CAUTION: High voltages sufficient to cause death on contact are brought into this test set and may remain in the blocking capacitor. Always operate the shorting switch before making any connections or adjustments.

b. Locating and Connecting. The test connections for using Test Set I-115 are shown in figure 21. The test set cable is connected to the output and ground terminals of the keying unit. Cord CD-502 then connects the output terminals of the test set to terminals D3 and D4 of the test oscilloscope. For additional personal protection, locate Test Set I-115 as far away from the keying unit and the test oscilloscope as possible. If the shorting-switch should be operated while the high voltage is on, there would be approximately 3,000 volts on the test set output terminals. If capacitor 1 should become shorted the same condition would occur.

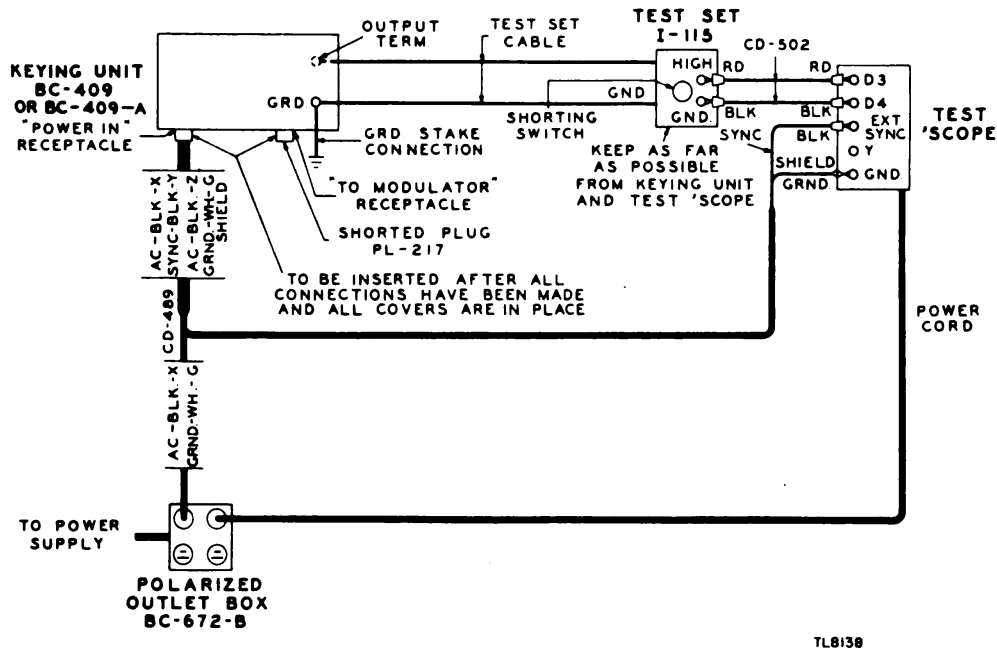

Figure 21. Test Set I-115, connections.

25. REMOTE CONTROL BOX BC-670-B.

In order to operate the rectifier, the interlock circuits in the radio set must be closed and the RECTIFIER START button at the keyer must be operated. It is sometimes more practical, however, to use Remote Control

Box BC-670-B, which provides those functions of the keyer necessary to turn on the rectifier high-voltage circuit. For example, when maintenance work is being performed on the rectifier, it may be necessary to turn the rectifier on and off repeatedly. Since the keyer is located approximately 150 feet from the rectifier, a 300-foot trip would have to be made every time the rectifier was turned on. By removing cable 22 from the REMOTE CONTROL CABLE receptacle at the rectifier-control panel, and inserting the plug of the test box, the rectifier high voltage can be controlled by the test box.

a. Remote Control Box BC-670-B can also be used as a trouble-shooting device. Trouble in the interlock circuit can be localized to the rectifier or keyer interlocks.

b. When the test box is used, do not apply the high voltage unless the filaments of the transmitter tubes are lit and the radio set is prepared for the application of high voltage. If the PLATE CONTROL handwheel at the rectifier is turned to its maximum counterclockwise position (minimum setting), high voltage cannot be applied to the modulator or transmitter.

26. TEST UNIT BC-708-A.

a. **Operation.** This test instrument is used when testing or aligning the receiver. The variable resistor is used as a sensitivity control, simulating the control which is located in the oscilloscope in normal operation. The toggle switch, located on the side of the test unit, is operated to switch the *hot* lead to the vertical deflecting plates of the test oscilloscope. With the switch in the SW position, the high terminal of the test oscilloscope is connected to the output of the switching amplifier, which is normally connected to the spread amplifier of the oscilloscope. When the toggle switch is in the VID position, the vertical terminals of the test oscilloscope are connected across the output of the receiver.

b. **Locating and Connecting.** The test unit is inserted directly on the output plug of the receiver. The two leads are then connected to the vertical terminals of the test oscilloscope; the shield lead is connected to the ground terminal.

27. FIELD-STRENGTH METER.

a. **Purpose.** The purpose of this instrument is to provide a means of testing the radiation output and field pattern of the antenna.

b. **Locating and Connecting.** (1) When the field-strength meter is not being used, it is disassembled in four pieces and kept in its transport

chest. These four pieces are the thermocouple, the two rods comprising the dipole, the meter, and the cord. The two antenna rods are inserted in the thermocouple which is then connected to the meter by use of the cord (fig. 11). The meter should be located away from the dipole because of the body effect of the person reading the meter. For this reason the cord provided is 150 feet long. The meter can be located at the unit, although the dipole is 150 feet in front of the antenna. This also allows the repairman to observe the effects of his adjustments.

(2) The dipole should be located at the proper distance to make the meter needle deflect approximately to the center of the scale because the meter is most sensitive at its midscale. If the meter deflection is too great or too small, the dipole may be moved toward or away from the antenna, whichever is necessary.

(3) Care should be taken to hold the dipole at right angles to the antenna when the radio set is in operation. The field strength close to the antenna is strong enough to cause the meter to be damaged.

28. SIGHT M-351.

The sight consists of an eyepiece and cross hairs set in a bar, which is fastened to a mounting that includes elevation and azimuth adjustment mechanisms. The mounting is fastened by means of a pivot screw to a support which is used to mount the complete sight assembly. Figure 12 shows the sight in its mounted position.

a. Normal Adjustment. Normal adjustment consists of setting the elevation and azimuth thumbscrews of the sight so that, when the radio set is focused on or tracking a known target, the peepsight lines up with the target. This adjustment is normally used when the adjustments of the antennas, receivers, etc., of the radio set are satisfactory and it is desired to make the line of sight (optical axis) agree with the electrical axis of the radio set. That is, normal adjustment is made after the receiving antennas are aligned.

b. Adjustment to Coincide with Mechanical Axis. When normal adjustment cannot be applied, the peepsight may be adjusted so that the optical axis coincides with the mechanical axis of the antennas. This is not an accurate method, because the electrical axis of the radio set is seldom the same as the mechanical axis. For this reason, normal adjustment must always be made if possible.

(1) ADJUSTMENT IN AZIMUTH WITH MECHANICAL AXIS.

(a) Select an object at a distance, such as a house or another subject on the horizon. Set the antennas at this minimum angular-height position, and

rotate the mount in azimuth until the object can be seen by sighting through the transposed feed lines of the antennas from one end of the system to the other. In this way, the antennas will be positioned so that the end-to-end axis of the dipoles point directly to the object; that is, the end of the antenna-mounting beam is pointing toward the target. If, because of variations in the antennas, a definite line of sight cannot be obtained, suspend two plumb bobs from the top receiving dipoles of the azimuth antenna, one from each dipole. Then use the cords attached to the plumb bobs as a guide in aiming the antennas at the object selected. This latter method assumes that the top dipoles are perfectly aligned with the rest of the azimuth-antenna system. If the top dipoles are out of alignment, use some other pair of dipoles, such as the second row from the top. In sighting the antennas in this manner, it must be assumed that some dipoles will not be exactly parallel to others in the system, but an effort must be made to point the average dipole of the azimuth system at the object selected.

(b) When the antenna system is pointing at the object, make a note of the reading on the azimuth ring of the mount. Then turn the azimuth handwheel so that the antennas are rotated 1,600 mils (90°). Adjust the peepsight with the azimuth thumbscrew so that the object selected is sighted exactly between the vertical bars of the sight. To permit sighting on the object, it may also be necessary to position the sight in angular height temporarily, with either the elevation handwheel or the elevation thumbscrew. Note whether the azimuth pointer on the sight lines up with the reference mark. If not, loosen the pointer mounting screws and reposition the pointer as required.

(2) PEEPSIGHT ADJUSTMENT IN ANGULAR HEIGHT WITH MECHANICAL AXIS.

(a) This adjustment presupposes that the trailer mount has been previously leveled.

(b) Place the reflector frame in a perpendicular position. If temporary changes in the elevation-stop mechanism are necessary to permit placing the antennas in this position, place the antennas at the lowest angular height permitted by the elevation-handwheel stop mechanism. Unbolt the housing over the elevation-stop mechanism and permit it to rest on the elevation handwheel. Observe the angular-height counter reading as the antennas are brought to a perpendicular position.

CAUTION: Do not allow the counter read less than zero.

(c) If the reading reaches zero before the antennas are perpendicular, reset the angular-height counter for a greater reading by means of the

angular-height vernier adjustment on the counter (it will be necessary to loosen the adjacent setscrew to do this). Use a carpenter's level to determine when the crossarms are in the required position. All crossarms may not be exactly parallel to each other, but an effort must be made to strike an average between the four crossarm members. Also place an average part of the reflector frame in the perpendicular position.

(d) The easiest way to adjust the sight for angular height is to select an object known to be at the same elevation above sea level as the sight and then to adjust the sight to permit sighting on the object by turning the elevation thumbscrew. Sometimes an object at the desired level may be selected by reference to a contour map of the locality. This reference point may also be obtained by means of a gun director or a surveyor's level or transit.

(e) Lacking a reference point known to be at the required level, select a light-colored distant object which seems to be at the same elevation as the radio set. Rotate the mount in azimuth, and adjust the sight in angular height so that the sight is lined up with the object selected. Then rotate the column exactly 3,200 mils (180°) in azimuth and see whether the object selected is in the line of sight when looking through the sight in the opposite-to-normal direction. A more accurate job of sighting backwards through the sight may be done if a piece of nontransparent adhesive tape, with a peephole $\frac{1}{16}$ inch in diameter through it, is mounted over the sight with the hole centered between the bars. If the object used as a reference does not line up, adjust the elevation thumbscrew so as to sight on the object again, noting particularly the number of turns, or parts of a turn, of the thumbscrew. Then turn the thumbscrew back exactly half this number of turns. The sight is now adjusted so that the line of sight is parallel with the mechanical axis of the elevation antenna.

(f) If the elevation-stop-mechanism has been disturbed, rebolt the stop-mechanism housing in place. Readjust the elevation-stop mechanism after the equipment is oriented.

c. Aligning Electrical Axis with Peepsight. To align the peepsight with the electrical axis, follow the procedure outlined in TM 11-1306.

29. PUNCH AND ANVIL SET TL-195.

This set is a special tool furnished with the repair equipment for making repairs on the antennas or transmission lines. It is a metal block containing slots which will accommodate the various sizes of tubing on the antenna and transmission lines. The slots cross at right angles in the center of the anvil and will, therefore, fit T connections and right or left hand L connections. A punch is also provided for removing escutcheon pins from the

fittings on the antenna and transmission line tubing. Figure 22 shows Punch and Anvil Set TL-195 in use.

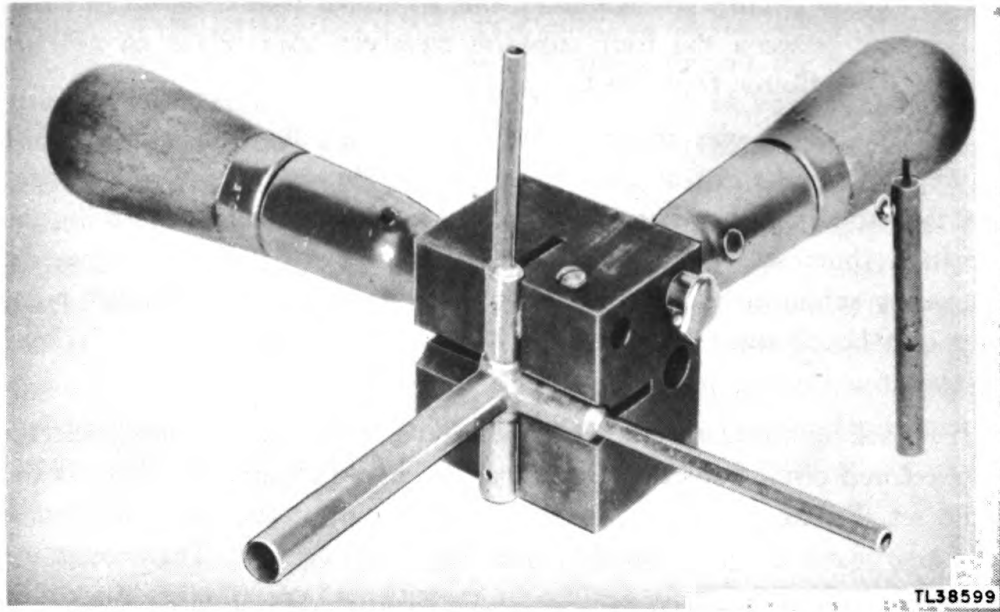

Figure 22. Punch and Anvil Set TL-195 in use.

30. PUNCH AND ANVIL SET TL-196.

a. Purpose. Punch and Anvil Set TL-196 is provided for the purpose of maintenance on the grid and plate-ball assemblies in Transmitter BC-407-A.

b. Replacement of Braid Connectors and Clip Inserts on Ball Assemblies. In order to make necessary repairs on the grid and plate-ball assemblies, some additional tools are required. These tools are furnished with the repair equipment but are not considered as part of Punch and Anvil Set TL-196. The complete list of tools necessary are listed below:

- 1 Awl
- 1 Eyelet pliers for No. 469 eyelets
- 1 Punch and Anvil Set TL-196

Figure 23 shows the various steps required to remove and replace a connector braid and clip insert on a ball assembly.

(1) Run the eyelet and braid of the damaged ball assembly through the countersunk hole used for the plate or grid ball (fig. 23①). Permit the ball to rest on the leveled surface and at the same time allow the braid to run down the bottom channel of the anvil.

(2) Using the insert remover punch, drive out the insert (fig. 23②).

(3) Place (prongs down) a new clip insert of the proper size for the particular ball being repaired on one of the four pins projecting from the anvil (fig. 23②). The grid and plate balls use clip inserts of different

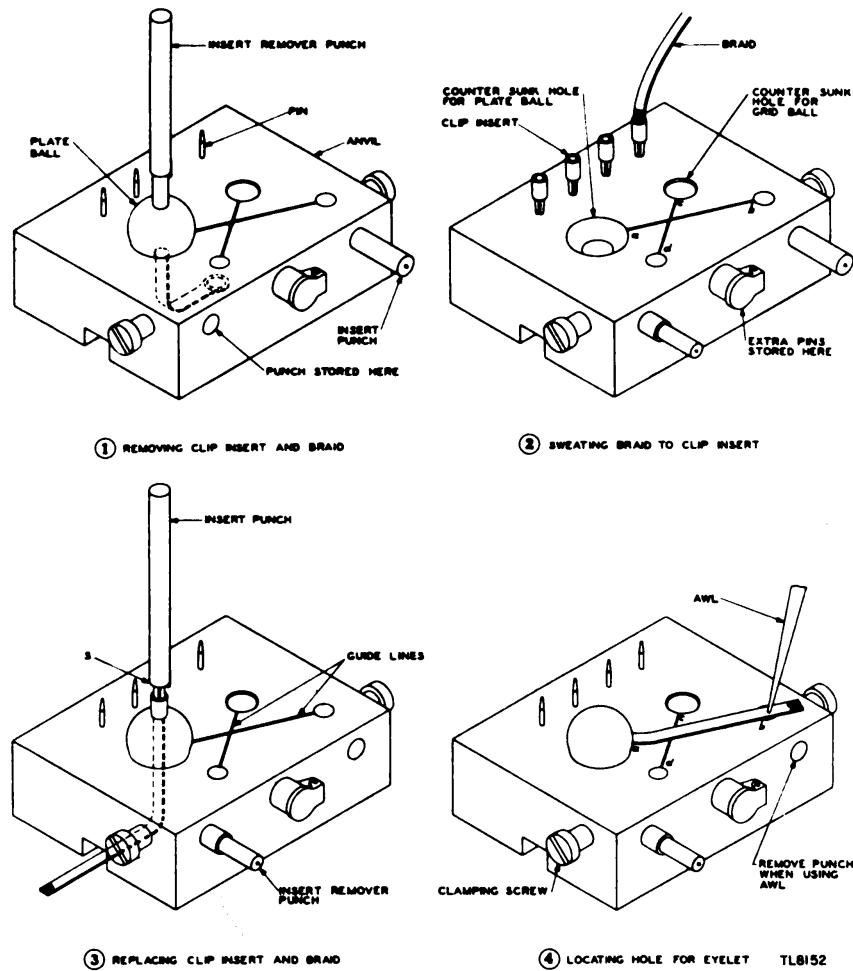

Figure 23. Punch and Anvil Set TL-196 in use.

sizes. The pin serves as a support and as a core to prevent clogging the insert prongs with solder when sweating the braid onto the insert. Four pins are supplied so that four inserts may be worked on at the same time.

(4) Sweat the braid to the clip insert. It is important that no solder be on any portion of the braid other than at the connection.

(5) Remove the clip insert from the pin and pass the loose end of the braid through the hole in the ball.

(6) Now pass the loose end of the braid through the proper countersunk hole so that it enters the bottom channel of the anvil. Rest the ball on the beveled surface of the hole.

(7) Draw the braid so that the insert rests in the position indicated in figure 23③, and drive the clip insert into place with the insert punch. The insert is in the correct position when the surface S of the punch is in contact with the ball.

(8) Remove the ball from the countersunk hole and place it in the same hole so that the braid extends along the guide line a-b (if it is a plate ball) or c-d (if it is a grid ball) as shown in figure 23. This does not apply to all models of radio sets, however, as some are designed so that the grid- and plate-ball braids are of the same length. In this case, both balls should be placed in the hole for the grid ball and the braid extended along guide line c-d. Guide line a-b is not used.

(9) Stretch the braid along the line a-b (if it is a plate ball) or c-d (if it is a grid ball). With the awl make a hole in the braid at the point b or d as indicated in figure 23④, so that a No. 469 eyelet can be inserted. Crimp and solder the eyelet to the braid.

(10) File the soldered end so that a smooth surface is produced. Be sure no frayed ends or points are left on the braid or soldered ends.

SECTION III

FUNCTIONING OF PARTS

31. GENERAL.

A detailed description of the test equipment furnished with Test Set AN/MPM-1 is contained in this section. The information described herein is given for the purpose of familiarizing the repairman with the functioning of the various circuits of the component parts. Throughout this section refer particularly to the schematic diagrams, with the functional diagrams, photographs, and sketches serving as additional material. If any information on a particular test instrument is desired and is not covered in this section, refer to the technical manual written for that specific test instrument.

32. TEST SET I-114.

In order to measure the voltage across the desired repeater winding and perform the various tests on the repeaters, a switching arrangement must be used. Test Set I-114 incorporates two 5-position switches for the purpose of connecting the voltmeter in the proper circuit. These switches are connected to various terminals on the 19-terminal receptacle also contained in the test set. A cable which connects the test set to the repeater circuits is inserted into the 19-terminal receptacle. Figure 24 is a schematic diagram of Test Set I-114.

33. TEST SET I-115.

The function of Test Set I-115 is to provide an artificial load for use in testing the keying unit.

CAUTION: High voltages sufficient to cause death on contact enter this test set. A shorting switch is provided to discharge the dangerously high voltage which may remain stored in the blocking capacitor. Always operate the shorting switch after cutting off the power to the keyer and before making any connections or adjustments on the test set.

Figure 25 is a schematic diagram of Test Set I-115. The constants of the RC series network (capacitor 1 and resistors 2-1 to 2-5) in the test set simulate the action of the load presented by the modulator to the keying

APP. PART NO.	DESCRIPTION	NAME	MADE BY OR EQUIVALENT
1	ESO-681739-2	RECEPTACLE	WESTERN ELECTRIC CO.
2	POLARIZED # 4898	FLUSH MOTOR PLUG	HARVEY HUBBELL INC.
3	# F-6854	RECEPTACLE	RUSSELL & STOLL CO.
4	PER ESO-614549-3 (S.P.S.T.)	TOGGLE SW.	ARROW HART & HEGEMAN MFG.CO.
5A TO 5D	2 SECT. 4 POLE 5 POS. # 2515 1/2" LG.	SELECTOR SW.	CENTRALAB INC.
6A, 6B	1 SECT. 2 POLE 5 POS. # 2505 SHAFT	SELECTOR SW.	
7	A-C 0-150V. MODEL 517 FLUSH TYPE 2 1/2" METAL CASE	VOLTMETER	WESTON ELECTRIC INSTRUMENT CO.
8	OPEN CIRCUIT # 701	JACK	MALLORY - YAXLEY CO.
9	5 AMP 250V. 3AG # 1358	FUSE	LITTELFUSE LABORATORIES

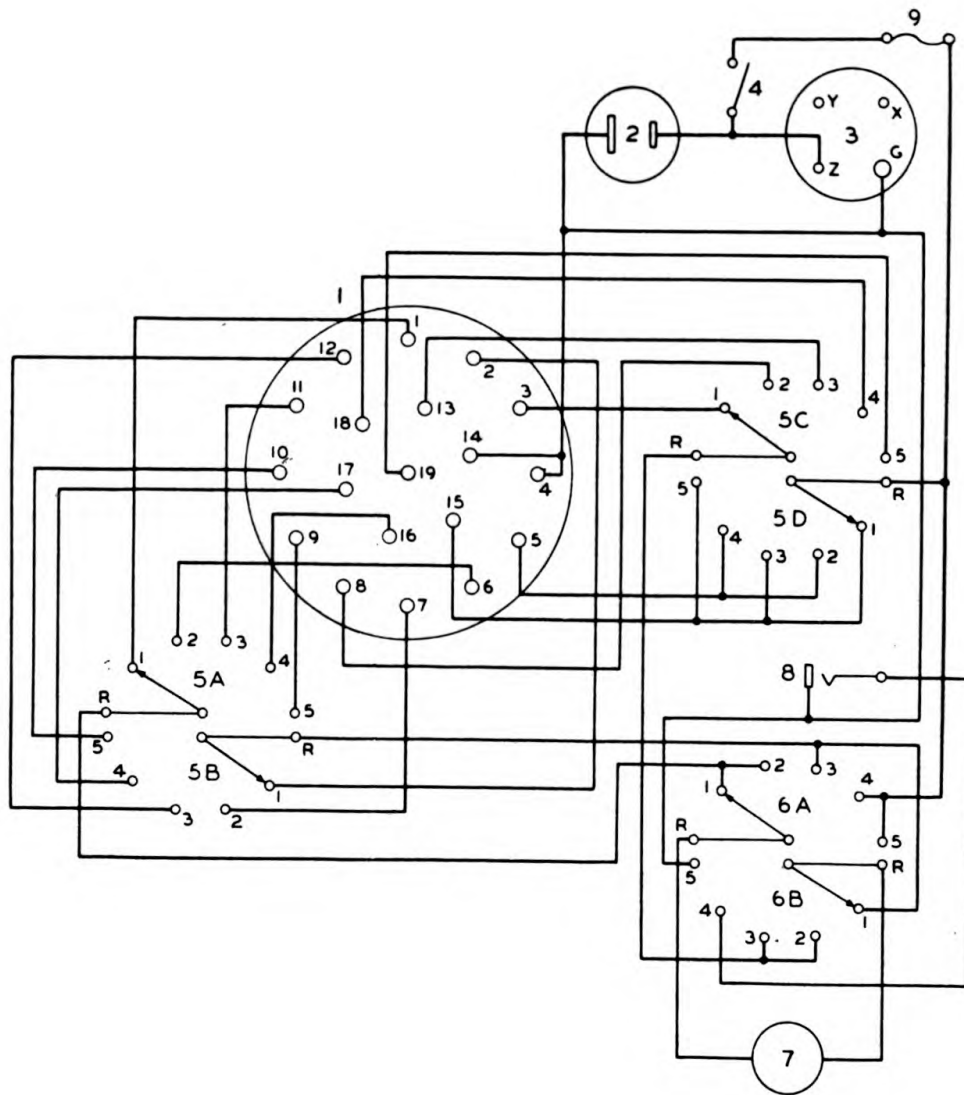

TL-32718

Figure 24. Test Set I-114, schematic diagram.

unit. The time constant of this network determines the characteristics of the keyer-pulse waveshape under the test condition. This time constant is not necessarily the same as that obtained in actual service, especially where changes have been made in the keyer output circuit. Signals of high voltages cause a large deflection on the oscilloscope screen and may even cause the image to pass off the screen. In order to provide a signal which may be observed on the screen, the keyer output pulse is applied across the input terminals of the test set and reduced to one twenty-sixth of its value by means of the voltage divider (formed by resistors 3-1 to 3-3) before it is applied to the test oscilloscope. The test oscilloscope is then used to determine the waveshape and peak voltage of the keyer pulse. Switch 4 is used to discharge the high voltage which may remain stored in capacitor 1 after the high voltage has been removed from the circuit.

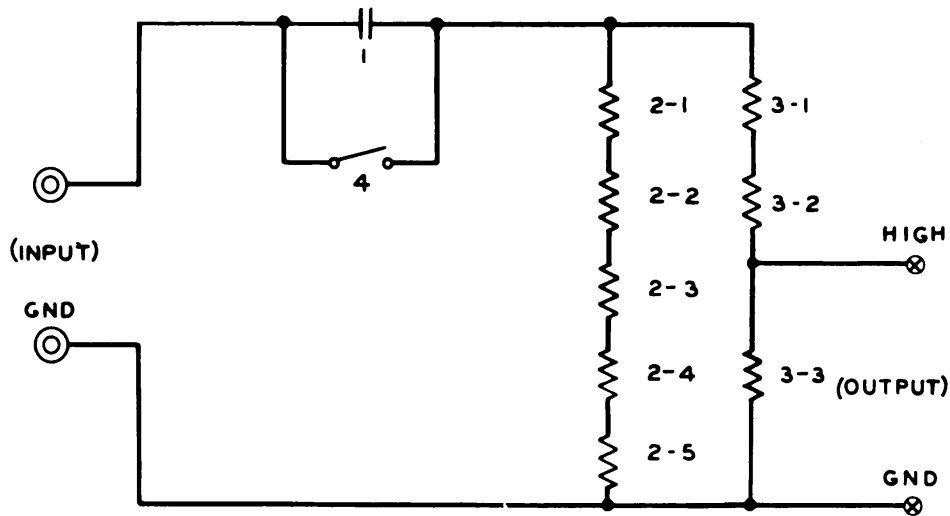

APP. PART NO.	DESCRIPTION	NAME	MADE BY OR EQUIVALENT
1	1 M.F. 5000V. D.C. TYPE NO. 5009	CAPACITOR	AEROVOX CORP.
2-1 TO 2-5	CARBON TYPE D5 500 ^w 5 WATT	RESISTOR	CONTINENTAL CARBON, CO.
3-1	10,000 ^w BT2		INTERNATIONAL RES. CO.
3-2	15,000 ^w BT2		
3-3	1000 ^w BT2		
4	PER FIGURE "D"	SHORTING SWITCH	WESTERN ELECTRIC CO.

TL8123

Figure 25. Test Set I-115, schematic diagram.

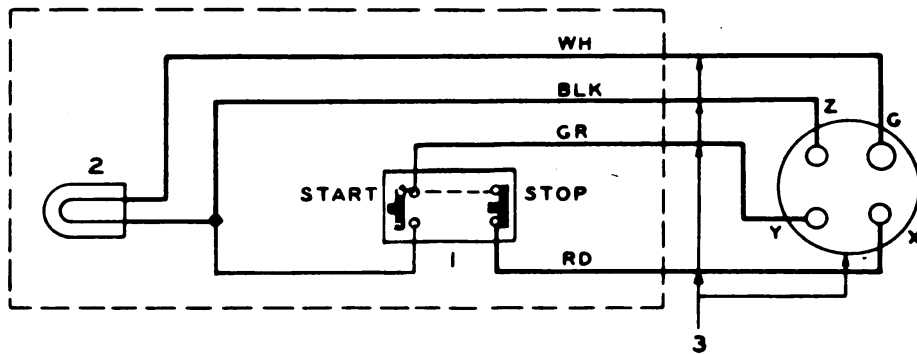
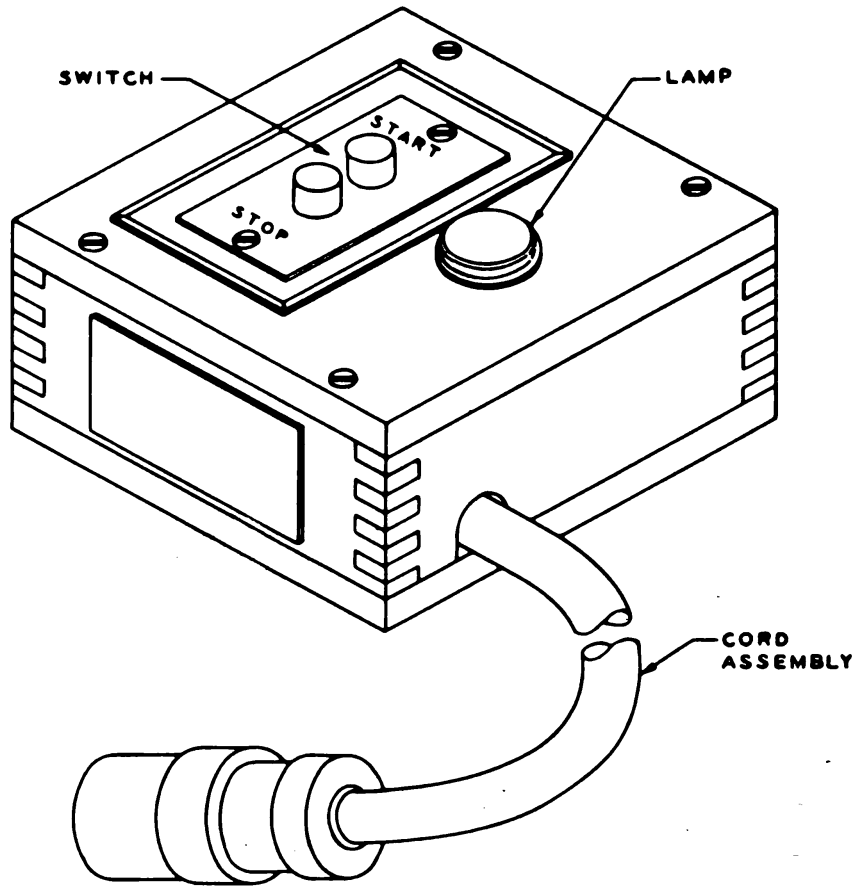

APP. PART NO	DESCRIPTION	NAME	MADE BY OR EQUIVALENT
1	NO. 1615 F	SWITCH	ARROW HART & HEGEMANN CO.
2	S6 MAZDA LAMP 6 WATTS	LAMP	GENERAL ELECTRIC CO.
3	ESO-681743-1	CORD ASSEMBLY	WESTERN ELECTRIC CO.

TL33833

Figure 26. Remote Control Box BC-670-B, schematic diagram.

34. REMOTE CONTROL BOX BC-670-B.

This test box is provided for remote control operation of the high-voltage circuit of Rectifier RA-38 at its panel. Figure 26 shows an outline sketch of the test box and also a schematic diagram of its internal connections. The START and STOP switch replaces the one located in the keying unit. When the switch is closed, a red pilot light on the test box is lit indicating that the high voltage is on in the rectifier. Care should be taken to avoid turning on the high voltage before the filaments of the transmitter tubes are lit and the radio set is prepared for high voltage.

35. TEST UNIT BC-708-A.

The function of Test Unit BC-708-A is to provide a means for connecting the output of the receiver to a test oscilloscope for testing and alignment purposes. An outline sketch and schematic diagram of this instrument are shown in figure 27. The variable resistor 3 simulates the receiver-sensitivity control which is normally contained in the oscilloscope, making it possible to vary the receiver gain without the presence of the oscilloscope. Resistor 4 in the test box completes the plate circuit of the switching-amplifier tube in the receiver and replaces resistor 13 in the oscilloscope. Switch 3 is a SPDT switch that controls the switching of the *hot* lead which is connected to the high terminal of the vertical deflecting plates of the test oscilloscope. When the switch is in the SW position, the high terminal of the test oscilloscope is connected to the output of the switching amplifier, which is normally connected to the spread amplifier of the oscilloscope. By throwing the switch to the VID position, the vertical terminals of the test oscilloscope are connected across the output of the receiver.

36. FIELD-STRENGTH METER.

This instrument consists of four parts; a thermocouple, a sensitive milliammeter, two pieces of tubing which form the dipole assembly, and Cord CD-728-A.

a. For proper adjustment of the transmitting system, it is necessary to use some sort of field-strength meter capable of abstracting and measuring the radio-frequency energy emitted from the transmitting antenna. The instruments that are used for measuring alternating currents of low frequencies are based on the d'Arsonval moving coil principle. While these instruments are accurate at low frequencies, they are inaccurate at radio frequencies because of distributed capacity and other effects. At high frequencies, a suitable means of measuring currents is the thermocouple milliammeter. In this type of meter the direct or alternating current to be measured is sent through a heater, which heats the junction of two dissimilar

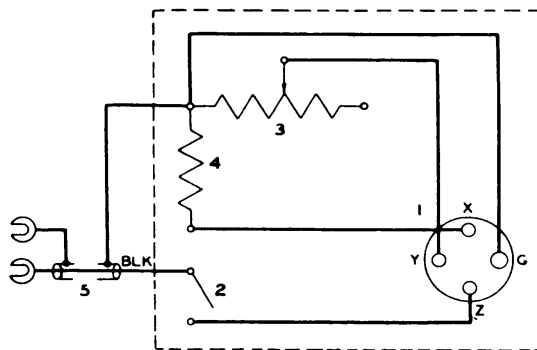
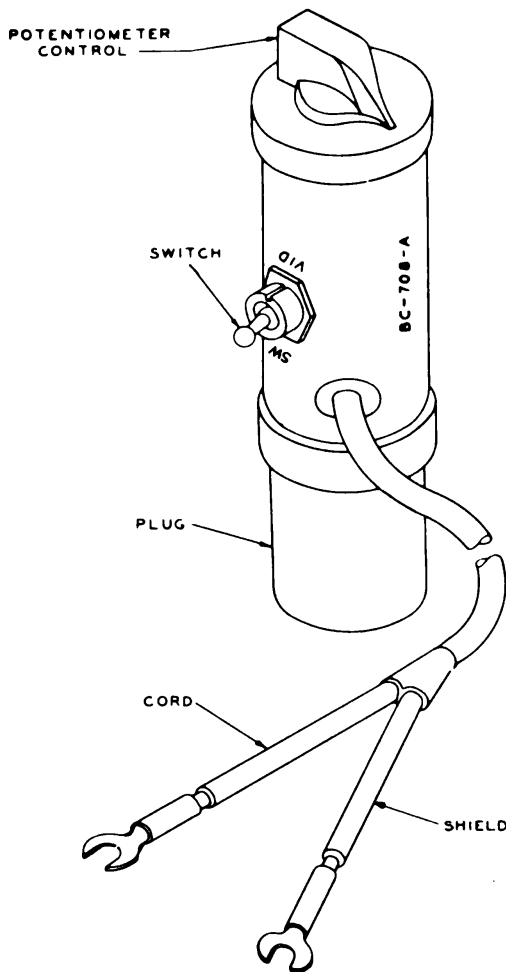

APP. PART NO.	DESCRIPTION	NAME	MADE BY OR EQUIVALENT
1	F 8755	PLUG	RUSSELL & STOLL CO.
2	ESO-613128-1	SWITCH S P D T	WESTERN ELECTRIC CO.
3	TYPE J 75,000" STRAIGHT TAPER	POTENTIOMETER	ALLEN-BRADLEY CO.
4	75" BT 1/2	RESISTOR	INTERNATIONAL RES. CO.
5	ESO-6&1922-4	CORD ASSEM.	WESTERN ELECTRIC CO.

TL 32723

Figure 27. Test Unit BC-708-A, schematic diagram.

metals. When two dissimilar metals are joined together and their junction heated, a voltage is generated which is proportional to the temperature difference between the heated junction and the open end of the thermocouple. A sensitive milliammeter is connected to the open ends and is usually calibrated to indicate the current through the heater. Figure 28 is a simplified diagram of this type of thermocouple instrument. In this diagram the heavy line represents one type of metal and the thin line another. The radio-frequency current to be measured passes through and heats a resistance indicated as HEATER STRIP in figure 28. The junction of the thermocouple is thereby heated, resulting in the generation of a d-c voltage which is proportional to the heat applied. This d-c voltage causes a flow of direct current through the movable coil of the milliammeter as

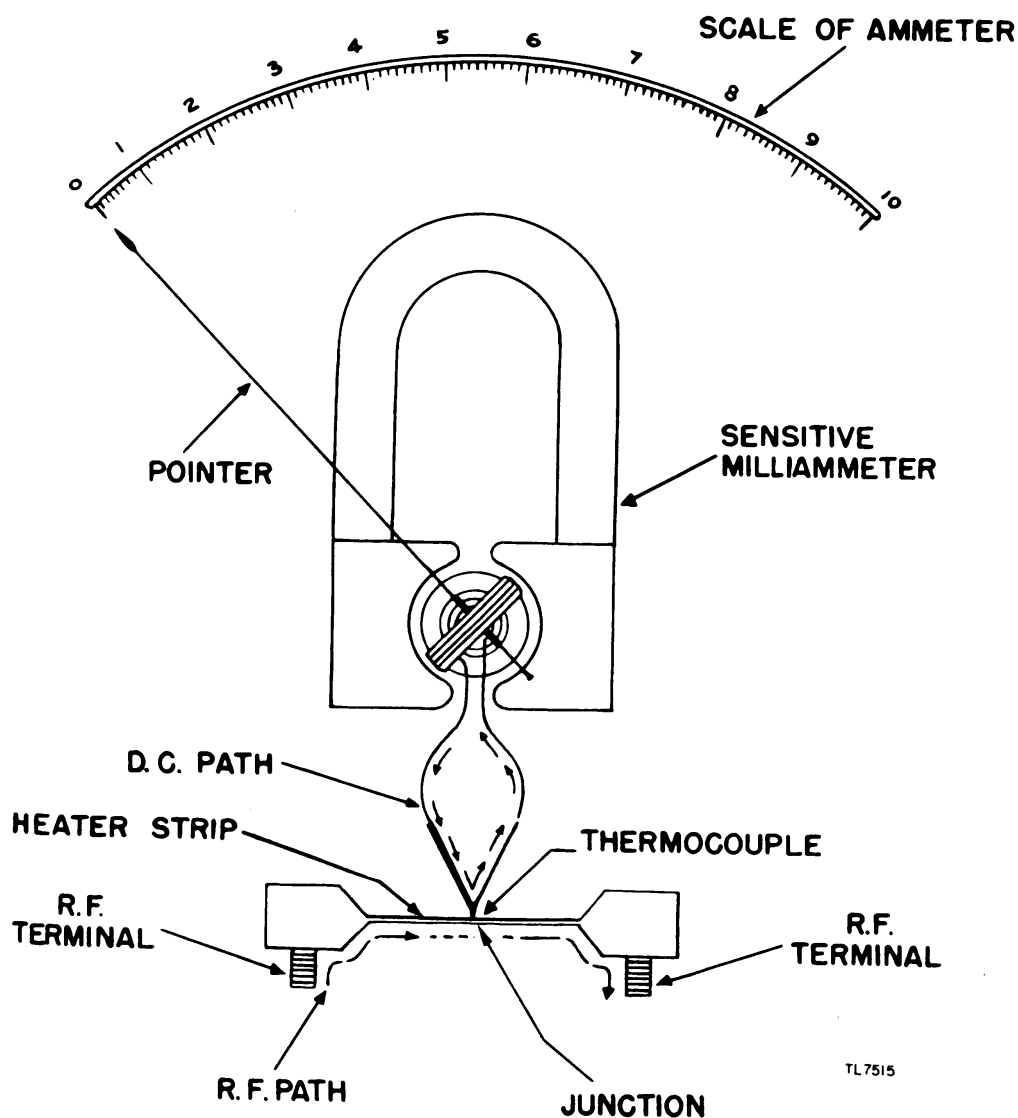

Figure 28. Field-strength meter, theory of operation.

indicated in the diagram. The heating effect is proportional to the square of the radio-frequency current being measured, whereas the voltage generated across the junction of the thermocouple is proportional to the heating effect. Therefore the motion of the pointer over the scale increases approximately proportionally to the square of the radio-frequency current passed through the heating strip. Because of these factors, the scale of the milliammeter used with the thermocouple is crowded at the lower end and more open at the upper end.

b. Care should be taken to keep the thermocouple instrument out of strong electromagnetic or electrostatic fields. When it is necessary to have the instrument near the transmitting antenna of the radio set, keep the dipole of the field-strength meter at right angles to it until the radio set is at least 40 yards distant.

SECTION IV

MAINTENANCE

NOTE: Failure or unsatisfactory performance of equipment used by Army Ground Forces and Army Service Forces will be reported on W.D., A.G.O. Form No. 468 (Unsatisfactory Equipment Report). If Form No. 468 is not available, see TM 38-250. Failure or unsatisfactory performance of equipment used by Army Air Forces will be reported on Army Air Forces Form No. 54 (unsatisfactory report).

37. GENERAL.

The information contained in this section is for the purpose of aiding the repairman in trouble shooting and maintaining the test equipment furnished with Test Set AN/MPM-1. Take care in using the test equipment and tools in order to keep them in good operating condition. Make routine checks and inspections periodically to prevent serious damage to the equipment.

38. TEST SET I-114.

a. Before using this test set, make sure that the voltmeter reads zero when no connections are made to the test set. The voltmeter needle may readily be positioned at zero, if necessary, by a screwdriver adjustment at the pivot of the needle. Usually no other maintenance on this test set will be required.

b. Check the accuracy of the voltmeter occasionally, by connecting the voltmeter to a known voltage of 110 or 120 volts alternating current and noting whether the meter indicates the correct voltage. When voltage measurements are made with the test set, any error may be added to or subtracted from the value indicated, to get the correct voltage.

c. Refer to figure 24 for the schematic diagram of the test set.

39. TEST SET I-115.

a. **General.** The following tests are for use in locating trouble in this test set and for determining the input-to-output voltage ratio of the voltage divider. The voltage ratio must be determined from time to time, as the resistance making up the voltage divider will vary considerably with age and use.

CAUTION: High voltages sufficient to cause death on contact are brought into this test set and may remain in the blocking capacitor. Always operate the shorting switch before making any connections or adjustments.

b. List of Testing Equipment.

- (1) 1 analyzer and associated cord equipment with plugs and test picks.
- (2) 1 Polarized Outlet Box J-45-()/MPN-1.
- (3) 1 Cord CD-487.
- (4) 1 Cord CD-502, red.
- (5) 1 Cord CD-502, black.

c. Over-all Performance Tests. Make these tests before the test set panel is removed to determine the location of the trouble. Repeat them after the trouble has been corrected and the panel has been replaced.

- (1) Operate the shorting switch on Test Set I-115.
- (2) Set up the connections to the test equipment as shown in figure 29, first connecting Cords CD-502 to Test Set I-115 and to the plug of Cord CD-487. Be careful not to short-circuit the clips against the shell of the plug. Then connect Cord CD-487 to the polarized outlet box.
- (3) Adjust the output of the power unit to 120 volts.
- (4) With the shorting switch held in the operated position and the analyzer set to read a-c volts on the 10-volt scale, read and record the voltage across the output terminals of Test Set I-115.
- (5) Allow the shorting switch to assume its normal unoperated position.
- (6) Determine the input-to-output voltage ratio by dividing 120 by the numerical value of the voltage read in step (4). (The ratio is usually about 26 to 1.) Record this value with that of step (4). This value may be referred to for future use and need not be recalculated, unless there is a material change in the voltage read in step (4).
- (7) With the analyzer set to read a-c volts on the 10-volt scale, make sure that the voltage read across the output terminals is lower than was observed in step (4). If the voltage reading does not change, it is an indication that the shorting switch is inoperative or the capacitor is short-circuited. If no voltage reading is obtained on either test, an open circuit is indicated.

d. Visual Inspection. If the over-all performance tests indicate trouble in the test set, remove the top panel. Examine carefully all wiring and apparatus. Look for foreign material, such as pieces of loose wire or solder chips, and for defective apparatus and parts. Check the alignment of the

switch shorting bar and its associated leaf spring terminals, and make sure that the capacitor is firmly held in place.

e. Trouble-shooting Data. The following table lists resistance values across various terminals as measured with the analyzer used as an ohmmeter. See figure 25 for a schematic diagram of the test set.

Terminals	Meter control position	Meter scale	Resistance (ohms)	Probable cause of incorrect reading
Input	R x 1,000	0-3 megohm	2280*	Shorting switch inoperative, wrong values of resistance, short-circuited or open resistance.
	R x 10,000	0-infinity	infinite**	Capacitor or switch short-circuited.
Output	R x 10	0-30,000	965	Resistance changed because of age or usage. Short-circuited or open resistances.

* Shorting switch operated.

** Shorting switch normal (unoperated).

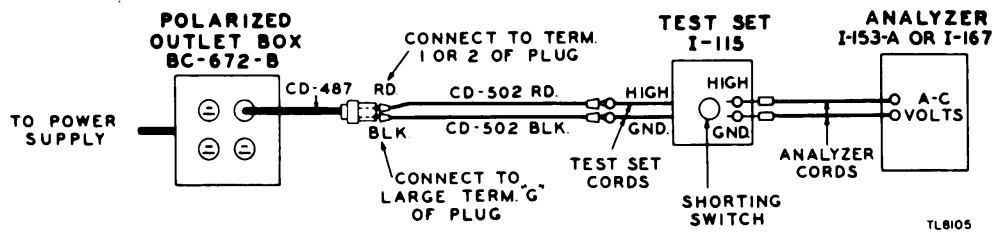

Figure 29. Test Set I-115, sketch of test connections.

40. CORDS.

The cords furnished with the test equipment are rubber-covered and are subject to damage, weather, and deterioration. If proper measures are taken, the useful life of these cords will be greatly extended.

a. Inspect the cords regularly for worn and damaged places in the insulation. If any are found, repair or replace the damaged cord immediately. Since some of the cords carry very high voltages, severe physical injury may result unless this is done.

b. When using the test equipment, arrange it so that the cords are not resting on any sharp objects or stretched tightly over the edges of the bench or any other test equipment. Avoid making any sharp bends in the cord

as these may result in kinks in the cords, causing damage to the wire, insulation, or shielding.

c. Regularly inspect the plugs and fittings on the ends of the cords for corrosion, loose connections, and damaged plug pins. Always be certain that the pins are clean and making good contact, otherwise an open circuit will result.

41. TOOLS.

a. Proper care and use of the tools should be maintained at all times. All tools should be kept clean and free from rust. They should be oiled occasionally to keep the joints free; the excess oil should be removed with a cloth.

b. Do not attempt to use a tool for some other purpose than that for which it is intended. Damage to the tool or the equipment on which it is being used will result.

42. MOISTUREPROOFING AND FUNGIPROOFING.

a. **General.** The operation of Signal Corps equipment in tropical areas where temperature and relative humidity are extremely high requires special attention. The following items represent problems which may be encountered in operation:

- (1) Resistors, capacitors, coils, chokes, transformer windings, etc., fail.
- (2) Electrolytic action takes place in resistors, coils, chokes, transformer windings, etc., causing eventual break-down.
- (3) Hook-up and cable insulation break down. Fungus growth accelerates deterioration.
- (4) Moisture forms electrical leakage paths on terminal boards and insulating strips causing flash-overs.

b. **Treatment.** A moistureproofing and fungiproofing treatment has been devised which, if properly applied, provides a reasonable degree of protection against fungus growth, insects, corrosion, salt spray, and moisture. The treatment involves the use of a moisture- and fungi-resistant varnish applied with a spray gun or brush. Refer to TB SIG 13, Moistureproofing and Fungiproofing Signal Corps Equipment, for a detailed description of the varnish-spray method of moistureproofing and fungiproofing.

CAUTION: Varnish spray may have toxic effects if inhaled. To avoid inhaling spray, use respirator if available, otherwise, fasten cheesecloth or other cloth material over the nose and mouth.

c. Step-by-Step Instructions for Treating Test Set I-114.

(1) PREPARATION. Make all repairs and adjustments necessary for proper operation of the equipment.

(2) DISASSEMBLY.

(a) Loosen the four snap locks and remove the cover.

(b) Remove the test cords from the case.

(c) Remove the eight screws from the edges of the meter panel and remove the panel.

(d) Remove the three screws from the A-C Voltmeter flange and pull the meter gently through the front of the panel.

(e) Clean all dirt, dust, rust, fungus, oil, grease, etc., from the equipment to be processed.

(3) MASKING. No masking is necessary.

(4) DRYING. Dry the unit for six hours at 140°F.

(5) VARNISHING.

(a) Apply three coats of Lacquer; Fungus resistant; Spec. No. 71-2202 (Stock No. 6G1005.3), or equal.

(b) Brush-coat the meter housing and flange; flow the varnish around the edges of the flange and dial glass for a complete seal.

(c) Brush-coat the two-pole female connector at the top right part of the panel.

CAUTION: Do not apply varnish to contacts.

(d) Brush-coat the four-pole female connector at the top right of the panel.

CAUTION: Do not apply varnish to contacts.

(e) Brush-coat the insulation between socket contacts of the 19-pole connector on the front of the panel.

CAUTION: Do not allow varnish to run into the socket contacts or on the outside housing of the connector.

(f) Brush-coat the balance of visible items and surfaces on the front of the panel.

CAUTION: Do not apply varnish to the toggle switch or plug jack.

(g) Brush-coat all wires, connectors, and panel surface on the rear of the meter panel.

CAUTION: Do not apply varnish to switches or the plug-jack contact.

(h) Spray the inside and outside of the carrying case and cover.

CAUTION: Do not spray the snap-type locks.

(6) REASSEMBLY. Reassemble the set and test its operation.

(7) MARKING. Mark the set with "MFP" and the date of treatment.
Example: MFP — 20 July 1944.

d. Step-by-Step Instructions for Treating Test Set I-115.

(1) PREPARATION. Make all repairs and adjustments necessary for proper operation of the equipment.

(2) DISASSEMBLY.

(a) Remove the six screws from the edges of the top panel.

(b) Remove the six screws from the edges of the front panel and remove the panel.

(c) Remove the two terminal nuts from the capacitor terminals and remove the wire leads and the two copper contacts.

(d) On the outside of the right-hand panel of the case, remove the four screws retaining the resistor-mounting-board stand-off insulators.

(e) Remove the four stand-off insulators and the asbestos shield from the mounting board.

(f) Remove the four screws retaining the capacitor-mounting-board stand-off insulators from the bottom panel of the case.

(g) Remove the capacitor and mounting board from the case.

(h) Remove the screws holding the capacitor hold-down brackets and remove the brackets and the mounting board from the capacitor.

(i) Remove the four stand-off insulators for the capacitor mounting board.

(j) Clean all dirt, dust, rust, fungus, oil, grease, etc., from the equipment to be processed.

(3) MASKING (fig. 30).

(a) Mask the contact bar of the capacitor shorting switch.

(b) Mask the spring plunger housing of the capacitor shorting switch.

(c) Mask the capacitor lead terminals.

(d) Mask the capacitor terminals and the insulating bushings.

(e) Mask the asbestos sheet on the inside of the right-hand panel.

(f) Mask the front ends of the side panel of the case.

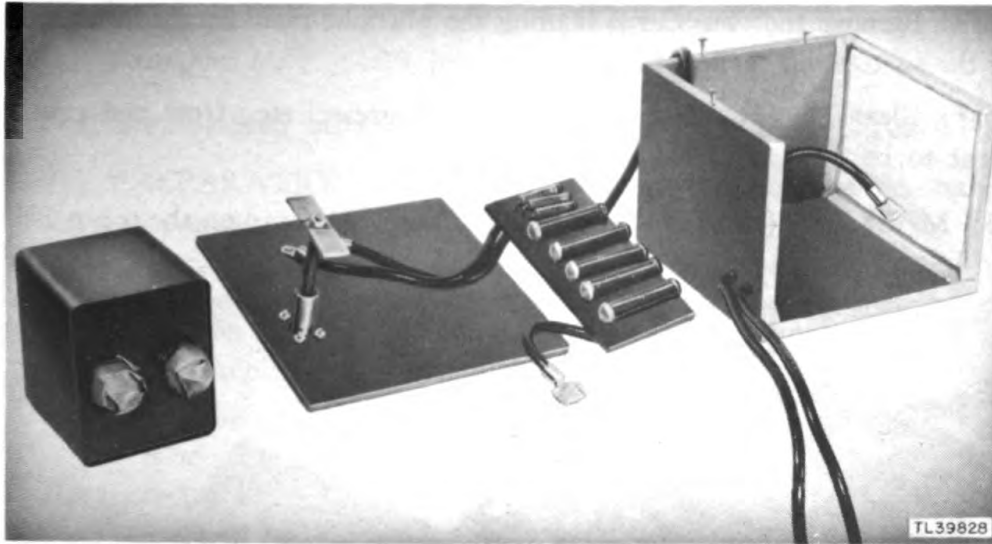

Figure 30. Test Set I-115, masking details.

- (4) **DRYING.** Dry the unit for six hours at 140°F.
- (5) **VARNISHING.**
 - (a) Apply three coats of Lacquer; Fungus resistant; Spec. No. 71-2202 (Stock No. 6G1005.3), or equal.
 - (b) Brush-coat the resistor side and edges of the resistor mounting board.
 - (c) Spray all other surfaces of the unit, inside and outside of the case, both sides and edges of the top cover and front panel, the body of the capacitor, the capacitor holding brackets, the capacitor mounting board, the lead wires and the back of the resistor mounting board.
 - (d) Remove the masking tape and brush-coat the exposed surfaces.
- (6) **REASSEMBLY.** Reassemble the set and test its operation.
- (7) **MARKING.** Mark the set with "MFP" and the date of treatment.
Example: MFP — 20 July 1944.

e. Step-by-Step Instructions for Treating Remote Control Box BC-670-B.

- (1) **PREPARATION.** Make all repairs and adjustments necessary for proper operation of the equipment.
- (2) **DISASSEMBLY.**
 - (a) Remove the two screws in the switch face plate and remove the plate.
 - (b) Remove the four screws from the edges of the top panel and lift out the case.
 - (c) Remove the four screws from the switch box on the underside of the top panel.
 - (d) Remove the two screws from the switch holding bracket and remove the switch from the box.

(e) Remove the two screws holding the phenolic plate on the underside of the switch and remove the plate.

(f) Clean all dirt, dust, rust, fungus, oil, grease, etc., from the equipment to be processed.

(3) MASKING (fig. 31). Mask the pilot lamp jewel cap on the top panel.

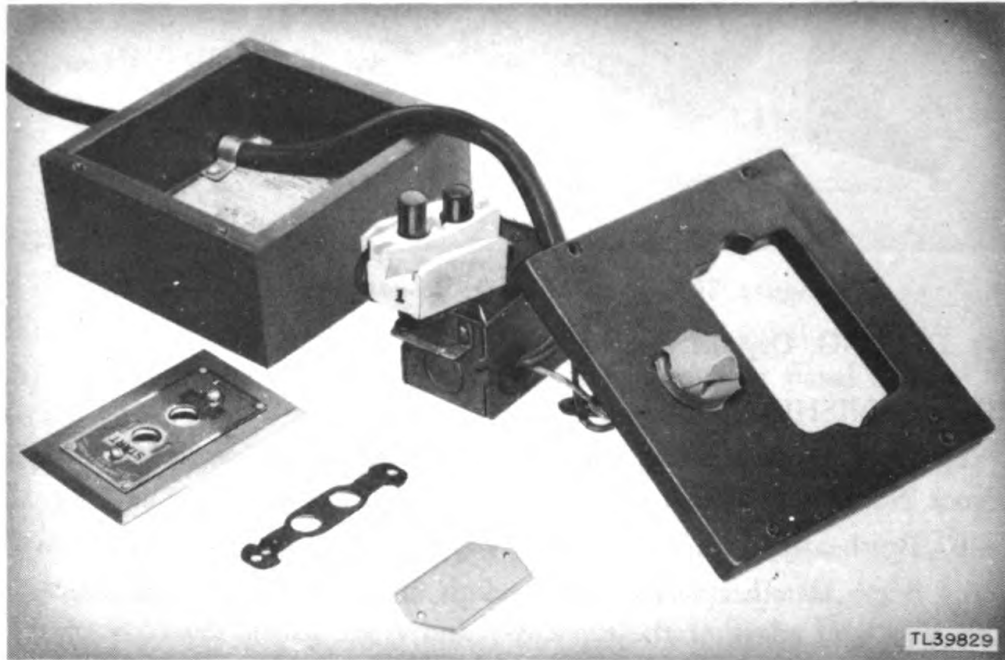

Figure 31. Remote Control Box BC-670-B, masking details.

(4) DRYING. Dry the unit for six hours at 140°F.

(5) VARNISHING.

(a) Apply three coats of Lacquer; Fungus resistant; Spec. No. 71-2202 (Stock No. 6G1005.3), or equal.

(b) Brush-coat all surfaces of the switch box, the phenolic plate, and the switch mounting bracket.

(c) Brush-coat the textile covered pilot light wire.

(d) Spray all surfaces of the top panel and the pilot light socket on the underside of the top panel.

CAUTION: Do not apply varnish to the rubber-covered wires or rubber parts.

(e) Spray the outside and inside surfaces of the case.

(6) REASSEMBLY. Reassemble the set and test its operation.

(7) **MARKING.** Mark the set with "MFP" and the date of treatment.
Example: MFP — 20 July 1944.

f. Step-by-Step Instructions for Treating Test Unit BC-708-A.

(1) **PREPARATION.** Make all repairs and adjustments necessary for proper operation of the equipment.

(2) **DISASSEMBLY.**

(a) Remove the three screws holding the plug connector to the metal tube, pull the plug out of the tube end to the full length of the attached wires.

(b) Remove the three screws on the opposite end of the tube and pull the control out of the tube to the full length of the attached wires.

(c) Remove the insulating paper from the inside of the tube, at the control end.

(d) Slide the paper insulating collar on the plug along the wires to expose the resistor and wire connections.

(e) Clean all dirt, dust, rust, fungus, oil, grease, etc., from the equipment to be processed.

(3) **MASKING** (fig. 32). Mask the socket half of the plug connector.

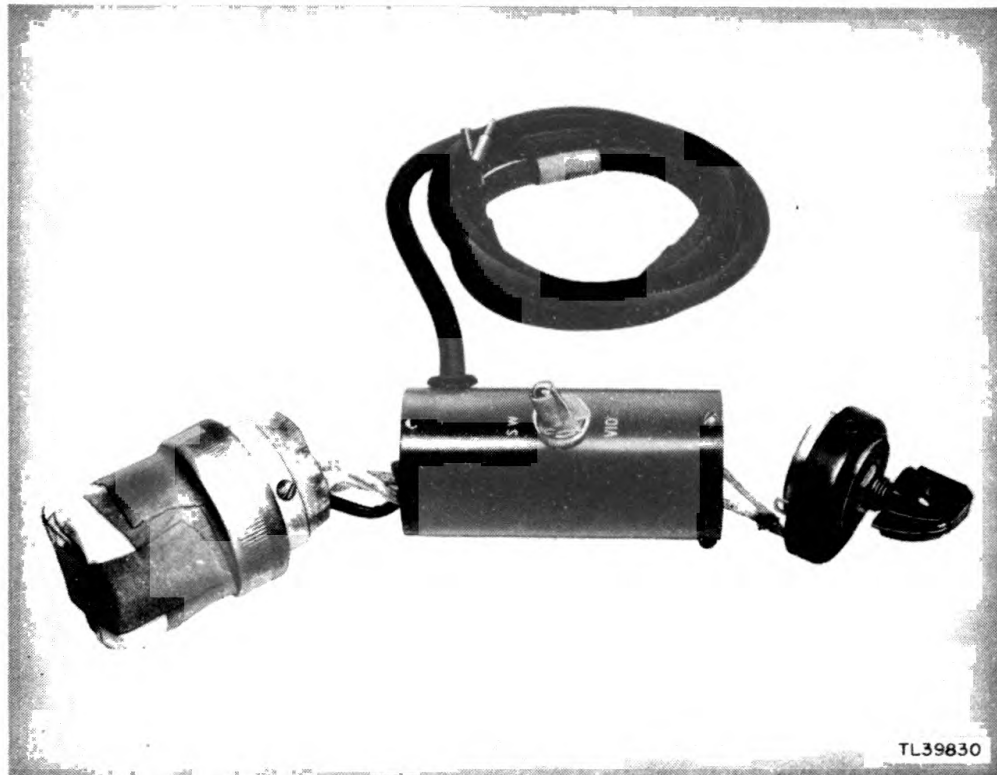

Figure 32. Test Unit BC-708-A, masking details.

(4) **DRYING.** Dry the unit for six hours at 140°F.

(5) **VARNISHING.**

(a) Apply three coats of Lacquer; Fungus resistant; Spec. No. 71-2202 (Stock No. 6G1005.3), or equal.

(b) Spray the entire inside of the metal tube, the paper collar, wires and resistor on the plug, and the wires and control at the other end of the tube.

(c) Reassemble the unit and spray thoroughly the outside of the tube.

CAUTION: Do not direct the spray on the control shaft.

(6) **REASSEMBLY.** With the unit reassembled, test its operation.

(7) **MARKING.** Mark the set with "MFP" and the date of treatment.

Example: MFP — 20 July 1944.

SECTION V

SUPPLEMENTARY DATA

43. RESISTORS AND CAPACITORS.

The following figures, 33 and 34, indicate the proper method of determining the correct values of resistors and capacitors when marked with the RMA (Rado Manufacturers Association) color code.

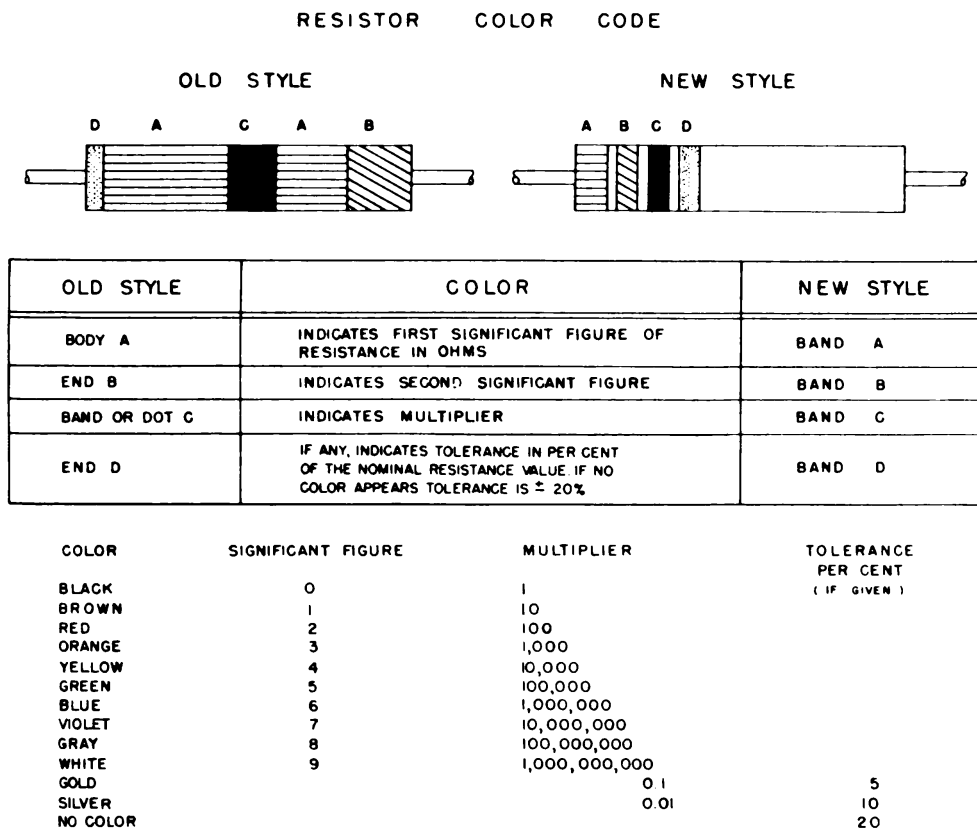

TL 35620

Figure 33. Resistor color code chart showing use.

44. MAINTENANCE PARTS LIST FOR TEST SET AN/MPM-1.

NOTE: Maintenance parts lists for several of the individual components of Test Set AN/MPM-1 may be found in the technical manuals for the various equipments as indicated below:

Calibrator I-178-A	TM 11-1051
Radio Modulator BC-423-B	TM 11-2636
Signal Generator I-126	TM 11-1063

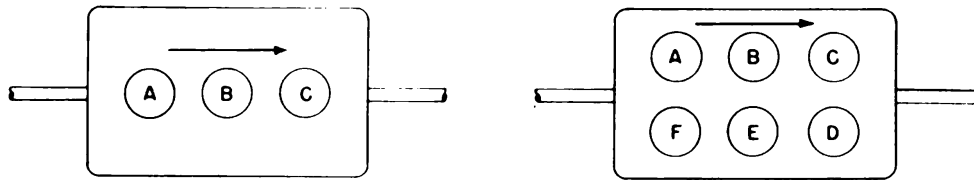

ONE ROW DOTS	COLOR	TWO ROWS OF DOTS
DOT A	INDICATES FIRST SIGNIFICANT FIGURE OF CAPACITANCE VALUE IN MICROMICROFARADS	DOT A
DOT B	INDICATES SECOND SIGNIFICANT FIGURE	DOT B
	INDICATES THIRD SIGNIFICANT FIGURE	DOT C
DOT C	INDICATES MULTIPLIER	DOT D
USUAL TOLERANCE ± 20 %	INDICATES TOLERANCE IN PER CENT OF THE NOMINAL CAPACITANCE VALUE. IF NO COLOR APPEARS TOLERANCE IS 20%	DOT E
RATED VOLTAGE USUALLY 500 VOLTS	INDICATES THE RATED VOLTAGE	DOT F

COLOR	SIGNIFICANT FIGURE	MULTIPLIER	TOLERANCE PER CENT (IF GIVEN)	RATED VOLTAGE (IF GIVEN)
BLACK	0	1		
BROWN	1	10	1	100
RED	2	100	2	200
ORANGE	3	1000	3	300
YELLOW	4	10,000	4	400
GREEN	5	100,000	5	500
BLUE	6	1,000,000	6	600
VIOLET	7	10,000,000	7	700
GRAY	8	100,000,000	8	800
WHITE	9	1,000,000,000	9	900
GOLD		0.1	5	1,000
SILVER		0.01	10	2,000
NO COLOR			20	500

TL 35619

Figure 34. Capacitor color code chart showing use.

44. MAINTENANCE PARTS LIST FOR TEST SET AN/MPM-1 (contd).

Ref symbol	Signal Corps stock No.	Major comp	Name of part and description	Quan per unit	Orgn stock		3d ech	4th ech	Depot stock
					1st ech	2d ech			
1	2Z3080-1	Test Set I-114	RECEPTACLE: 19 hole; 3" x 3"; Bell Lab dwg ESR-681733, item 4, ESO-681739-2; Breeze Corp No. AF-63 or equal	1					*
3	6Z7810-5		RECEPTACLE: 4 pole; male; Everlok; Bell Lab dwg ESR-681733, item 5; Russell & Stoll Co No. F-6854 or equal.	1					*
2	6Z7816.1		PLUG: flush motor; parallel blades; Bell Lab dwg ESR-681733, item 6; Harvey Hubbell No. 4898 or equal.	1					*
4	3Z9692-3		SWITCH: toggle; SPST; Bell Lab dwg ESR-681733, item 7; Arrow, Hart & Hagemann Co or equal.	1					*
5A to 5D	3Z9825-58.32		SWITCH: position selector; 2 sections; 4 pole; 5 position; shaft 1/2" long; Bell Lab dwg ESR 681733, item 8; Centralab Inc No. 2515 or equal.	1					*
6A 6B	3Z9825-58.16		SWITCH: position selector: 1 section; 2 pole; 5 position; shaft 1/2" long; Bell Lab dwg ESR-681733, item 9; Centralab Inc No. 2505 or equal.	1					*
7	3F8150-32		METER, voltmeter: a-c; 0-150; model 517; flush 2 1/2" metal case; Bell Lab dwg ESR-681733, item 11; Weston or equal.	1					*
8	2Z5680A/7		JACK: open circuit junior; Bell Lab dwg ESR-681733, item 12; P. R. Mallory & Co No. 701 or equal.	1					*
	3C1411B/B3		BUMPER, rubber: Bell Lab dwg ESR-681733, item 19; Atlantic India Rubber Works Co No. 366 or equal.	8					*

* Stock available.

44. MAINTENANCE PARTS LIST FOR TEST SET AN/MPM-1 (contd).

Ref symbol	Signal Corps stock No.	Major comp	Name of part and description	Quan per unit	Orgn stock			4th ech	Dept stock
					1st ech	2d ech	3d ech		
9	3Z3275-1	Test Set I-114 (contd)	POST, fuse: Bell Lab dwg ESR-681733, item 35; Littlefuse Lab Inc No. 1075A or equal.	1				*	
	3Z2605.2		FUSE: 5 amp; 250v; Bell Lab dwg ESR-681733, item 36; Littlefuse Lab Inc No. 3AG#1358 or equal.	1				*	
	1B816.103		WIRE: #16AWG; solid cond; Rockbestos fireproof radio hook-up; 1,000v; Bell Lab dwg ESO-681738, item 1.					*	
	1A818.1		WIRE: 18 T; Bell Lab dwg ESO-681738, item 2.					*	
	3Z12056/2		TERMINAL: Bell Lab dwg ESR-681733, item 40; Shakeproof No. 2108-8.	2				*	
	3Z12056/3		TERMINAL: Bell Lab dwg ESR-681733, item 41; Shakeproof No. 2108-10.	2				*	
	2Z5822-13		KNOB: bar; black; Bell Lab dwg ESR-681733, item 10; Kurz Kasch Inc No. S-292-3L or equal.	2				*	
	1B3018-2.13		CORD: #18 AWG; two conductor; copper wire; 8'-4 1/2" long; 41/.0063; 3/64" insulation; nom OD 0.390" max OD 0.420"; per spec SCL-338, item 2; Bell Lab dwg ESO-681735-6, item 1, ES-690553-3.					*	
	6Z3150-5		CONNECTOR: body; composition; with cord grip; Bell Lab dwg ESR-681733, item 14, ESO-681735-6, item 2; Harvey Hubbell Co No. 7084 or equal.	1				*	
	6Z3150-5		CAP: plug; rubber; with cord grip; Bell Lab dwg ESR-681733, item 14, ESO-681735-6, item 3; Harvey Hubbell Co No. 7084 or equal.	1				*	
	1B3018-1.7		CORD: #18 AWG; one conductor; 41/.0063 shielded copper wire; 3/64" insulation; nom OD 0.240", max OD 0.260"; per spec SL-338, item 1; Bell Lab dwg ES-690556-3, item 1, ES-690556-2.	1				*	

44. MAINTENANCE PARTS LIST FOR TEST SET AN/MPM-1 (contd).

Ref symbol	Signal Corps stock No.	Major comp	Name of part and description	Quan per unit	Orgn stock			4th ech	Depot stock
					1st ech	2d ech	3d ech		
	3G1838-108.3	Test Set I-115 (contd)	RESISTOR PANEL: phenolic, natural, grade LE; $\frac{1}{4}$ " x $3\frac{3}{4}$ " x $6\frac{3}{4}$ "; Bell Lab dwg ESO-681729-10, item 1; ESO-681728-1.	1					*
	6Z3774		EYELET: brass; Bell Lab dwg ESO-681729-10, item 2; American Radio Hardware Co No. 3013-E or equal.	16					*
	3Z1180-3.2		LUG: soldering; No. 8 hole; Bell Lab dwg ESO-681729-10, item 3; American Radio Hardware Co No. 9 or equal.	16					*
	2Z1250.118		BRACKET: brass; $\frac{1}{16}$ " thick, $4\frac{5}{8}$ " legs, $3\frac{3}{4}$ " center, $\frac{1}{2}$ " spurs; Bell Lab dwg ES-681726-1, item 9, ESO-681728-6.	2					*
	3G1640-124		INSULATOR: asbestos; $\frac{1}{16}$ " x 6" x $7\frac{3}{4}$ "; Bell Lab dwg ES-681726-1, item 26, ESO-681729-8; West- inghouse Supply Co No. 1176 or equal.	1					*
	3G1640-112		INSULATOR: asbestos; $\frac{1}{16}$ " x $3\frac{3}{4}$ " x 7"; Bell Lab dwg ES-681726-1; item 52, ESO-681729-9; West- inghouse Supply Co No. 1176 or equal.	1					*
	3G1838-84.4		PLATE, mounting: phenolic, natural, grade LE; $\frac{1}{4}$ " x $5\frac{1}{4}$ " x 5"; Bell Lab dwg ES-681726-1; item 3, ESO-681727-6.	1					*
	3F4115/S2		SHAFT: phenolic, natural, grade LE; $\frac{1}{4}$ " diam, $4\frac{1}{4}$ " long; one end threaded for $\frac{1}{2}$ " with $\frac{1}{4}$ "—28 SAE thread; Bell Lab dwg ES-681726-1; item 5, ESO-681728-2.	1					*
	2Z8526-20		BAR, shorting; brass; $\frac{1}{8}$ " x $7\frac{3}{8}$ " x 3"; $\frac{1}{4}$ "—28 SAE tap; Bell Lab dwg ES-681726-1; item 7, ESO-681728-4.	1					*

3G1837-66				1				*
3F4115/S1				1				*
3F4115/A1				2				*
3Z635-14				2				*
1B3341				1				*
3DB1.5009	1			1				*
3G1250-16				4				*
3G1250-8				4				*
3Z6050-69	2-1 to 2-5			5				*
3RC41BE 153K	3-2			1				*
3RC41BE 103K	3-1			1				*

SLEEVE: phenolic, natural, grade LE; ID $1\frac{1}{64}$ " OD $\frac{1}{2}$ " ; thread diam $\frac{7}{16}$ " ; $2\frac{1}{16}$ " long, $\frac{7}{8}$ " of $\frac{7}{16}$ "—20 SAE thread slot $\frac{3}{32}$ " x 1" ; Bell Lab dwg ES-681726-1; item 8, ESO-681728-5.

SPRING: steel; $\frac{7}{16}$ " ID, $1\frac{3}{8}$ " length; #20 B&S Gauge $14\frac{1}{2}$ turns; Bell Lab dwg ES-681726-1, item 10, ESO-681729-1.

TERMINAL: beryllium copper; #16 B&S Gauge: $\frac{3}{4}$ " wide; one arm $\frac{3}{4}$ " long, the other $1\frac{1}{16}$ " long, at angle of 20°; Bell Lab dwg ES-681726-1; item 6, ESO-681728-3.

POST, binding: Bell Lab dwg ES-681726-1, item 21; American Radio Hardware Co No. 147 or equal.

CABLE: 7" long; Bell Lab dwg ES-681726-1, item 49; Packard Electrical Division General Motor Corp No. 341 or equal.

CAPACITOR: 1mf; 5,000v DC; Bell Lab dwg ES-681726-1, item 20; Aerovox Corp No. 5009 or equal.

INSULATOR: ceramic; Bell Lab dwg ES-681726-1, item 13; Isolantite Corp No. 323 L-1 or equal.

INSULATOR: ceramic; Bell Lab dwg ES-681726-1, item 14; Isolantite Corp No. 323 L- $\frac{1}{2}$ or equal.

RESISTOR: carbon; 500-ohm; 5w; Bell Lab dwg ES-681726-1, item 16; Continental Carbon Inc No. D5 or equal.

RESISTOR: 15,000-ohm; Bell Lab dwg ES-681726-1, item 17; International Resistance Corp No. BT-2 or equal.

RESISTOR: 10,000-ohm; Bell Lab dwg ES-681726-1, item 18; International Resistance Corp No. BT-2 or equal.

* Stock available.

44. MAINTENANCE PARTS LIST FOR TEST SET AN/MPM-1 (contd).

Ref symbol	Signal Corps stock No.	Major comp	Name of part and description	Quan per unit	Orgn stock			4th ech	Depot stock
					1st ech	2d ech	3d ech		
3-3	3RC41BE 102K	Test Set I-115 (contd)	RESISTOR: 1,000-ohm; Bell Lab dwg ES-681726-1, item 19; International Resistance Corp No. BT-2 or equal.	1					*
	1B816.11		WIRE: #16 AWG; Bell Lab dwg ES-681726-1, item 51.	4					*
	2Z2636-34		CLAMP, cable; Bell Lab dwg ES-681726-1, item 25.	3					*
	2Z5786.19		KNOB: for 1/4" shaft; Bell Lab dwg ES-681726-1, item 22; Insuline Corp of America No. 1116 or equal.	1					*
	6L3969-6		PIN: brass; 1/16" x 3/8" long; Bell Lab dwg ES-681726-1, item 27.	1					*
	2Z3024-9	Test Unit BC-708-()		PLUG: Bell Lab dwg ESO-681921, item 1; Russell & Stoll No. F-8755.					
3F4452- 708A/HI			TUBE: Bell Lab dwg ES-681992-2 ESO-681921, item 2.						*
3F4452- 708A/PV			COVER: Bell Lab dwg ES-681992-3 ESO-681921, item 3.						*
3E4035-58			CORD ASSEMBLY: Bell Lab dwg ES-681922-4, ESO-681921, item 4B.						*
3Z9846.2			SWITCH: SPDT, Bell Lab dwg ES-613128-1 ESO-681921, item 5.						*
2ZK7262- 75M			POTENTIOMETER: 75,000-ohm; straight taper; 1/4" diam shaft extending 3/4" beyond mtg surface and 1/4" lg bushing; 1 hex nut, zinc plated; Bell Lab dwg ESO-681921, item 6; Allen-Bradley type J.						*
6Z4877-15			GROMMET: Bell Lab dwg ESO-681921, item 7; Boodall Rubber Co G1002.						*

44. MAINTENANCE PARTS LIST FOR TEST SET AN/MPM-1 (contd).

Ref symbol	Signal Corps stock No.	Major comp	Name of part and description	Quan per unit	Orgn stock			4th ech	Depot stock
					1st ech	2d ech	3d ech		
	3E1728	Test Set AN/MPM-1 (contd)	CORD CD-728: 150' lg; two #18 AWG cond; SBRG; twisted cable; Espey type #SJ; dwg #ES-D-14025.	1					*
	3E1819		CORD CD-819: 6' lg; one #18 AWG cond; shielded wire X, Y, and Z; type #SJ; dwg #ES-D-14486.	1					*
	2Z7226-217		CONNECTOR: Sig C Plug PL-217; 4 poles; Sig C dwg #SC-D-11916; (Group 4).	1					*
	2Z7226-216		CONNECTOR: Sig C Plug PL-218; contains 150 ohms; carbon resistor; used as dummy antenna; dwg #ES-D-8265.	4					*
	3F384		METER: ammeter; Sig C Ammeter IS-184; RF; 0 to 120ma; round, bakelite panel mtg case; Weston #507.	2					*
	2Z9167-351		SIGHT, telescope: Sig C M-351; dwg #ES-D-5608.	1					*
	3F4818-322		THERMOCOUPLE: Sig C M-322; external type; with terminals for $\frac{3}{8}$ " diam dipole rod; weather-proof; Weston type #D.	2					*
	3F3944-1/A1	TUBE ASSEMBLY: dipoles for field-strength meter unit assem; brass tubing; $\frac{3}{8}$ " OD x 12 $\frac{1}{2}$ " lg; Bell Lab dwg #ESO-681670, part #ES-88167C-4, or equal.	2					*	
2	2Z5941	Test Set BC-670-B	LAMP LM-41: 110v; 6w; Mazda #656; (same as item No. SCR268/7-5).	1	*				*
	2Z5988-5		LAMP MOUNTING ASSEMBLY: dial light 100-S; red jewel; (same as item No. SCR268/7-7).	1					*
1	3Z9824-252		SWITCH: push button; Arrow, Hart & Hagemann type 1615F.	1					*

2	3E4036-36-5	<p>CABLE ASSEM: general purpose; rubber jacketed; 0.405" nom OD; 0.440" max OD; round; 36" lg; 3 cond; #18 AWG stranded; 41 strands of 0.0063" diam wires per cond; Gen Cable type S; Espey; Sig C dwg #ES-D-28088; Sig C Spec SCL-338, item 3; (1/32" thk rubber insulation on each cond; color coded conductors red on green, white and black; .600v working).</p>	1				*
4	2Z7113.33	<p>CONNECTOR, male contact: 3 round polarized contacts; straight type; 3/4" x 1 3/16" diam overall; R & S type #E8886; Espey (10 amp, 250vdcw, 440v AC; 20 amp, 125vdcw; cylindrical steel cadmium plated body; molded black bakelite insert; G/ 7 7/16" rubber grommet cable opening grip).</p>	1				*
6	3Z9692-3392	<p>SWITCH, push: SP 2 circuit; single sect; paper bakelite laminated; 1 3/4" lg x 3/4" w x 5/8" h body with 3/4" lg push button; AH & H type #3392 spcl; Espey (1 amp; 125v; single hole mtg by means of 5/32" x 7/16" bushings; solder lug terminals).</p>	1				*
5	6Z3147-7	<p>FITTING CONDUIT: straight rubber bushed connections; galv steel; 3/4" conduit size; 1 7/8" lg x 1 3/8" overall; 3/4" conduit threaded bushing connection; Appleton type #CCB-6100g; Espey; Sig C dwg ES-D-28215 (tapered rubber bushing for cable gripping 3/8" to 1/2" diam).</p>	1				*

* Stock available.

**GAYLAMOUNT
PAMPHLET BINDER**
Manufactured by
GAYLORD BROS. Inc.
Syracuse, N. Y.
Stockton, Calif.

NON-CIRCULATING BOOK