

116 u 3  
12  
7M 2

TM 9-1752

**WAR DEPARTMENT**  
*U.S. Army*  
**TECHNICAL MANUAL**  
**ORDNANCE MAINTENANCE**  
**AUXILIARY GENERATOR**  
**(HOMELITE MODEL HRH-28)**  
**FOR MEDIUM TANKS M3**  
**March 20, 1942**



Generated on 2016-07-10 20:01 GMT / http://hdl.handle.net/2027/uc1.b3243967  
Public Domain, Google-digitized / http://www.hathitrust.org/access\_use#pd-google

TECHNICAL MANUAL }  
No. 9-1752

26113  
12  
TM 9-1752  
1942

WAR DEPARTMENT,  
WASHINGTON, March 20, 1942.

ORDNANCE MAINTENANCE

AUXILIARY GENERATOR (HOMELITE MODEL HRH-28)  
FOR MEDIUM TANK M3

SECTION I. General.	Paragraph
Scope -----	1
Description -----	2
II. Operation.	
Starting and stopping -----	3
Control -----	4
III. Inspection and adjustment.	
General -----	5
Engine -----	6
Generator -----	7
IV. Trouble shooting.	
General -----	8
Generator check list -----	9
Engine check list -----	10
V. Service and repair.	
General -----	11
Lubrication -----	12
Removing unit from tank -----	13
Procedure in case of heater-generator failure -----	14
Dismantling -----	15
Assembly -----	16
Re-installation of unit in tank -----	17
VI. Parts list.	
Generator parts -----	18
Control box parts and connections -----	19
Engine parts -----	20
Duct parts -----	21
Special tools -----	22
Standard screws, bolts, nuts (cadmium plated unless otherwise noted), and washers -----	23
APPENDIX. List of references -----	Page 50

\*This manual supersedes TM 9-1752, August 4, 1941.

M558443

SECTION I  
GENERAL

	Paragraph
Scope-----	1
Description-----	2

**1. Scope.**—This manual is published for the information and guidance of ordnance maintenance personnel. It contains detailed instructions for inspection, disassembly, assembly, maintenance, and repair of the auxiliary generator for medium tank M3, supplementary to those in Field Manuals and Technical Manuals prepared for the using arm. Additional descriptive matter and illustrations are included to aid in providing a complete working knowledge of the matériel.

**2. Description.**—*a. General.*—The heater-generator model HRH-28 is a self-contained machine designed for supplying 1,500 watts, 30 volts, d-c power for charging the tank batteries, and also for preheating the tank engine in cold weather by means of heat from an electric heater element and heat from the generator engine (figs 1 and 2). In addition, the unit can be utilized for heating the crew compartment. It consists essentially of an electrical generator with controls, directly coupled to, and driven by, a gasoline engine. The unit is mounted in the crew compartment on four shock-absorbing feet, and with a metal heater duct extending from the unit to the tank engine compartment (fig. 3).

*b. Components.*—(1) *Gasoline engine.*—The gasoline engine supplied is a Homelite model HR, 3,400-3,600 rpm, 2-cycle, single-cylinder, air-cooled, inverted type (fig. 1). The engine is started by means of a button on the control box. A starting rope approximately 45 inches long with grip is supplied for emergency manual starting.

(2) *Generator.*—The generator is a Homelite model HR-28, 30-volt, d-c type of 1,500 watts rating, with a control box attached (fig. 1).

(3) *Heater duct.*—The heater duct runs from the generator unit to the engine compartment and contains the generator engine exhaust system and electric heater element (figs. 1 and 2).

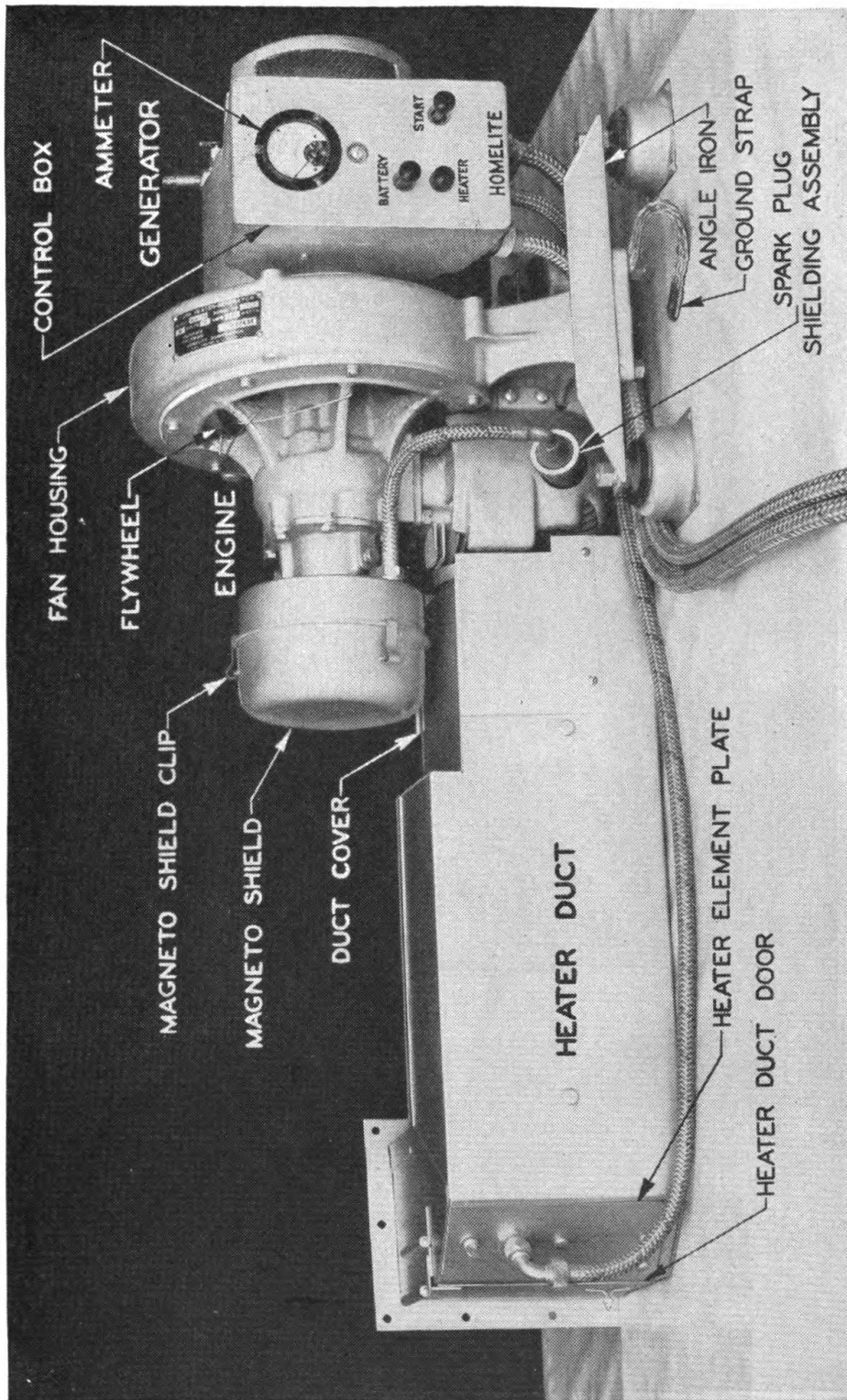

FIGURE 1.—Auxiliary generator model HRH-28—right side.

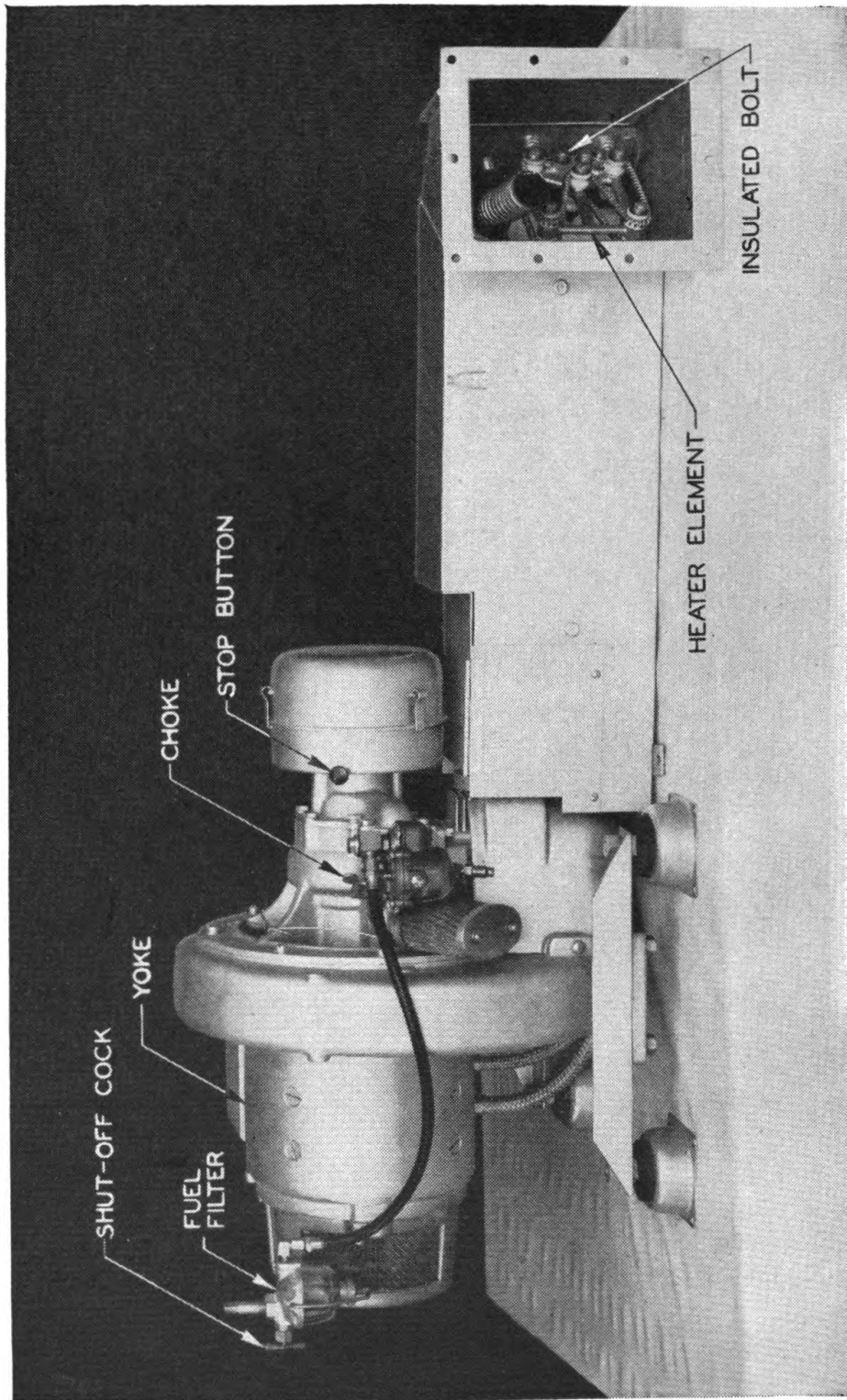

FIGURE 2.—Auxiliary generator model HRH-28—left side.

## SECTION II

### OPERATION

	Paragraph
Starting and stopping-----	3
Control-----	4

**3. Starting and stopping.**—*a. Fuel mixture.*—(1) Thoroughly mix  $\frac{3}{8}$  pint of oil, engine, SAE 50 or SAE 60, with each gallon of gasoline and pour into the fuel tank mounted above the unit. The fuel tank capacity is approximately 3 gallons. For location of the filler cap see figure 5. Lubrication for the entire engine is obtained by mixing oil with the gasoline, and it is extremely important that

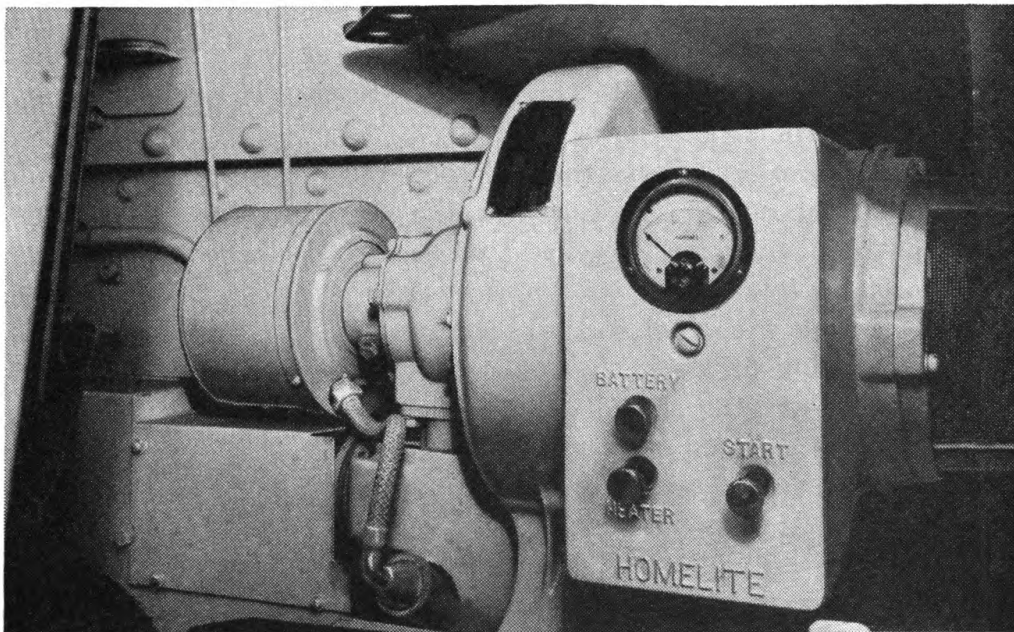

FIGURE 3.—Auxiliary generator installed in medium tank M3.

the oil be thoroughly mixed with the gasoline before pouring into the tank.

(2) Open shut-off cock on fuel filter beneath the fuel tank (fig 2). Full counterclockwise direction is open.

*b. Cold weather starting—cold engine* (below 50° F.).—(1) Close the carburetor choke (fig. 2). (The choke is open when the lever is against the stop pin.)

(2) Depress the starting button on the control box (fig. 1). Release the button as soon as the engine starts and immediately open the choke partially, easing to full open position as the engine warms up.

*c. Warm weather starting—or warm engine (above 50° F.).—*(1) Depress the starting button on the control box (fig. 1). Release the button as soon as the engine starts.

(2) Do not use the choke unless the engine does not start within 5 seconds. If the engine does not start, use the choke as in instructions in *b* above.

NOTE.—Do not use the choke for a throttle. The automatic governor keeps the engine operating at proper speed at all loads.

*d. Emergency manual starting.—*If batteries are dead or generator is to be started for testing, it may be started manually. To accomplish this, pry open the three clips holding the shield over the magneto, with a screw driver, and remove the front half (fig. 1). Wind the starting rope counterclockwise on the starting plate which is then exposed. Use the choke as in *b* or *c* above. Pull the rope hard, giving a quick spin to the engine. Repeat if necessary until the engine starts.

*e. To stop engine.—*Press the red stop button (fig. 2), and hold firmly until the engine stops. Close the fuel line shut-off cock beneath the fuel tank (fig. 2) (closed when in full clockwise position).

*f. Summary of starting and stopping procedure.*

- (1) Fill tank with fuel and oil mixture.
- (2) Open shut-off cock.
- (3) Choke—if required.
- (4) Depress starting button or start manually.
- (5) Press red stop button for stopping.
- (6) Close fuel shut-off cock.

**4. Control.—***a. Battery charging.—*Depress the battery button on the control box (fig. 1) if it is not already in as far as it will go. The output of the generator is then utilized to charge the batteries. The charging rate is indicated by the ammeter on the control box. Full rate on discharge batteries is approximately 50 amperes. As the batteries become more fully charged, the charging rate tapers off. With almost fully charged batteries, it is approximately 5 amperes. These figures are general, and assume no load on the batteries.

*b. Cold weather starting of main engine.—*To raise the temperature in the main engine compartment to facilitate cold weather starting, depress the heater button on the control box as far as it will go (fig. 1). This permits the heater element in the forward end of the duct to utilize the full electrical output of the generator. The heat from the generator engine is also directed into the main engine compartment.

*c. Heating crew compartment.*—Follow instructions as in *b* above. Then open the door in the end of the heater duct (fig. 1) by lifting up. Fold this door back along the top of the duct so that the handle fastens in the catch. To reclose the door, unfasten the handle and slide the door down into its normal position.

### SECTION III INSPECTION AND ADJUSTMENT

	Paragraph
General .....	5
Engine .....	6
Generator .....	7

**5. General.**—This section deals only with minor points of inspection and adjustment that can readily be performed without removing the heater-generator from the tank.

**6. Engine.**—*a. Spark plug and baffle* (fig. 4).—(1) Replace the spark plug every 25 hours of operation. To replace, remove the cap from the spark plug shield and take out the plug with a socket wrench. In removing the plug, the baffle may come out on the plug. Use a 14-mm high-temperature spark plug; gap adjustment 0.025 inch. Note that in replacing the plug, the copper gasket goes outside of the metal shield surrounding the plug.

(2) Each time the plug is removed, the baffle is to be taken out for cleaning. It is extremely important to scrape out thoroughly all carbon, brownish lead deposits, and loose particles on both sides of the baffle. The baffle will operate satisfactorily with up to 50 percent of the holes plugged. However, it is to be replaced every 75 hours of operation. Always use a new gasket when replacing the baffle.

*b. Magneto.*—The only adjustment is at the contact point assembly (fig. 6) which is to be inspected every 75 hours of operation to see that the gap is exactly 0.020 inch. To adjust, proceed as follows:

(1) Pry open the three clips on the shield over the magneto with a screw driver (fig. 1) and take off the front half.

(2) Remove the magneto rotor by loosening the rotor nut which is then exposed. Do not remove the three screws holding the starting plate to rotor.

(3) Remove the spark plug as in preceding instructions (*a* above) to relieve compression, and permit turning the flywheel which is located in the fan housing (fig. 1).

(4) Turn the flywheel slowly in a counterclockwise direction until the breaker lever fiber on the contact assembly rests on the highest



point of cam (fig. 6), approximately  $\frac{1}{8}$  inch past the breaking edge of the cam. Check the gap with a feeler gage.

**NOTE.**—Although the contact points remain open during the entire travel of the cam from the breaking edge, being closed only while the flat section of the cam is passing the breaker lever fiber, the cam must be positioned as directed when gaging the contact point gap. The heavy section of the cam is slightly eccentric, and contact points are not fully separated when the closing edge of the cam approaches the breaker lever fiber.

(5) If it is necessary to adjust the gap, *loosen slightly* the screw which fastens the contact point assembly to the stator plate.



FIGURE 4.—Spark plug and baffle.

(6) Move the entire breaker mechanism toward the cam to increase gap, or away from cam to decrease the gap.

(7) Tighten the contact point assembly fastening screw securely.

(8) Recheck the gap with the feeler gage. Readjust if necessary. Tightening of the setscrew sometimes changes the adjustment.

(9) The entire contact point assembly pivots on the breaker lever bearing pin, which permits adjustment of the gap without altering

the relationship between the contact point surfaces. If the breaker cam is removed from the intake valve shaft, replace with the arrow (indicating rotation) on the outside.

(10) Uneven or pitted contact points may be restored to a true, even condition by using a smooth carborundum stone; after which all dust particles should be removed with a dry cloth. However, if points are in this condition, a new set is recommended. *Do not use a steel file on contact point surfaces.* Stiff paper or cardboard will



FIGURE 4.—Spark plug and baffle—Continued.

remove the oxide formation on contact points which results from idleness.

*c. Carburetor (fig. 7).*—Adjustment of the carburetor will be made by ordnance personnel only.

(1) Keep the strainer in the fuel inlet connection on top of the carburetor bowl free from sediment. When this strainer is being inspected, open the fuel line shut-off cock beneath the fuel tank to make certain there is a free flow of fuel to the carburetor.

(2) If fuel does not flow freely, remove the fuel filter sediment bowl beneath the fuel tank and clean the strainer in the top of the bowl.

(3) The carburetor is furnished with a concealed adjusting screw which is properly set at the factory and seldom if ever requires adjustment. In case of carburetor trouble, before changing this adjusting screw setting, make sure that fuel flows freely to the carburetor by inspecting both strainers as explained in (1) and (2) above.

(4) Where adjustment of the carburetor is found necessary the

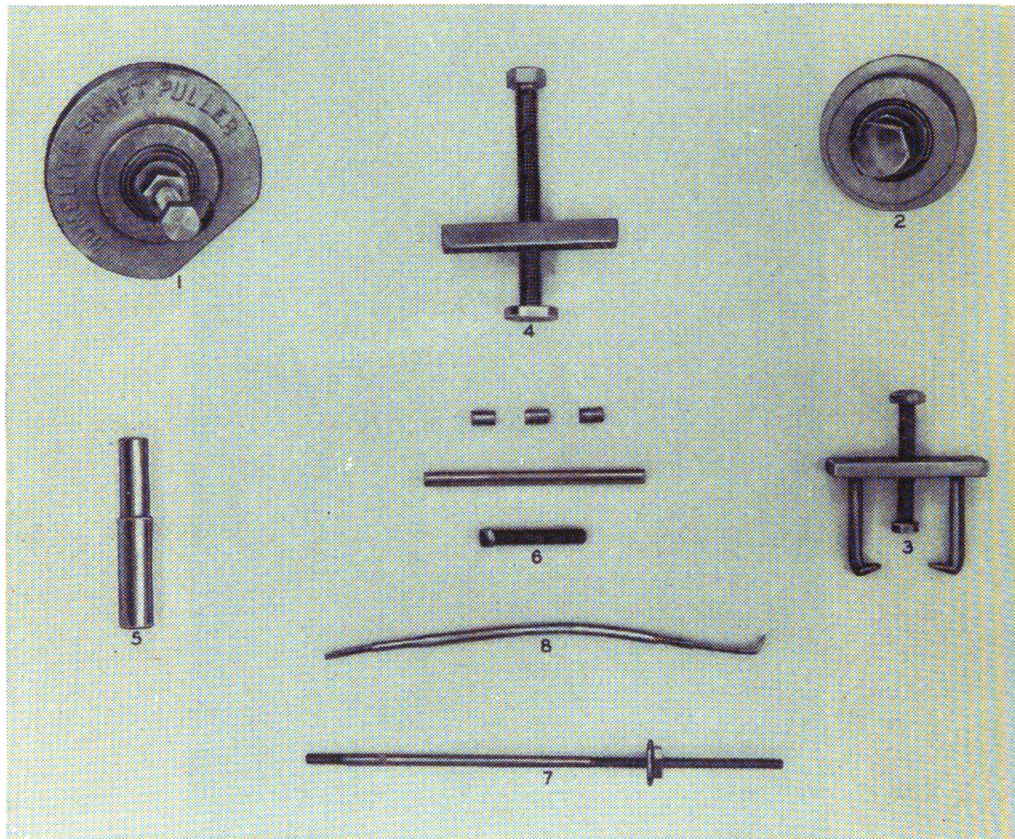

FIGURE 5.—Special tools.

plug screw at the bottom of the adjusting screw assembly should be removed and the packing nut loosened slightly (hold the gland nut with a wrench when loosening the packing nut).

(5) The adjusting screw which is concealed in the packing nut can now be adjusted by inserting a screw driver in its slotted head. Turn clockwise for a leaner mixture or counterclockwise for a richer mixture.

NOTE.—Do not screw the adjusting screw hard against the seat as this will damage both the screw and the seat. Do not file the point of the adjusting screw.

(6) If the adjusting screw is completely out of adjustment, an approximate setting of  $1\frac{3}{4}$  turns from the closed position can be used. The engine can be started with this setting.

(7) The proper setting of the carburetor can be obtained only when the engine is warm and operating under full load which means the full electrical output of the generator (operate the heater element for full output). Under these conditions the adjusting screw should be turned clockwise to secure a lean mixture, until engine speed begins to fall off. (This can be noted by the sound of the exhaust.)

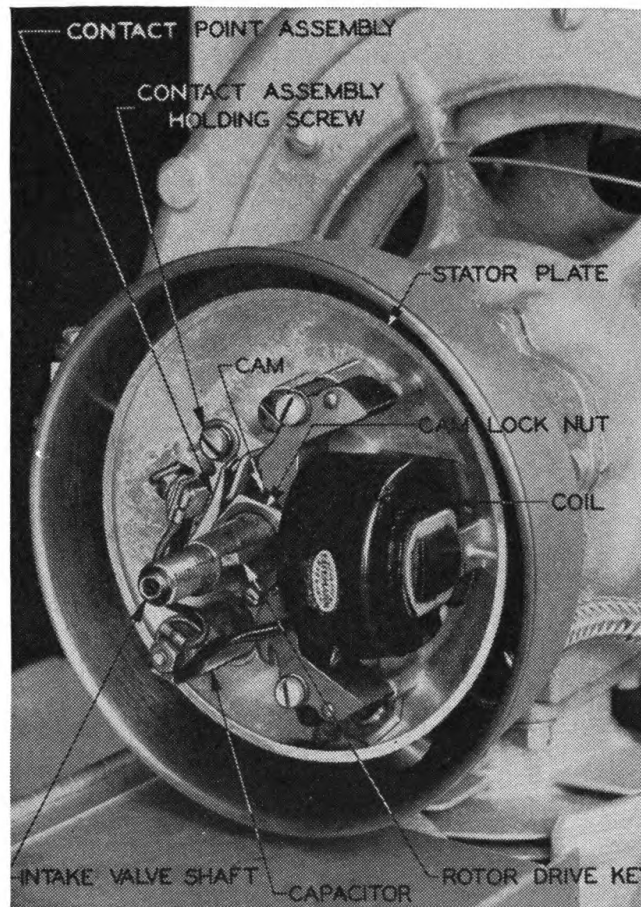

FIGURE 6.—Contact point adjustment.

Then turn the adjusting screw back, counterclockwise, *very gradually*, until the engine reaches full speed. The proper setting is approximately  $\frac{1}{8}$  turn richer than the leanest point at which the maximum speed is obtained. A slightly richer setting of  $\frac{1}{8}$  to  $\frac{1}{4}$  turn is advisable in extremely cold weather.

(8) The engine will operate at full speed even when the carburetor is set for a mixture considerably too rich, but this is wasteful of

fuel and excessive carbon is formed. For this reason the carburetor is to be set lean.

(9) After the adjusting screw is properly set, be sure that it does not turn when the packing nut is tightened. Hold the adjusting screw from turning with a screw driver as the packing nut is tightened.

(10) The adjusting screw and possibly the nozzle against which it seats may require replacement after considerable use. If the adjusting screw appears worn and difficulty is experienced in adjust-

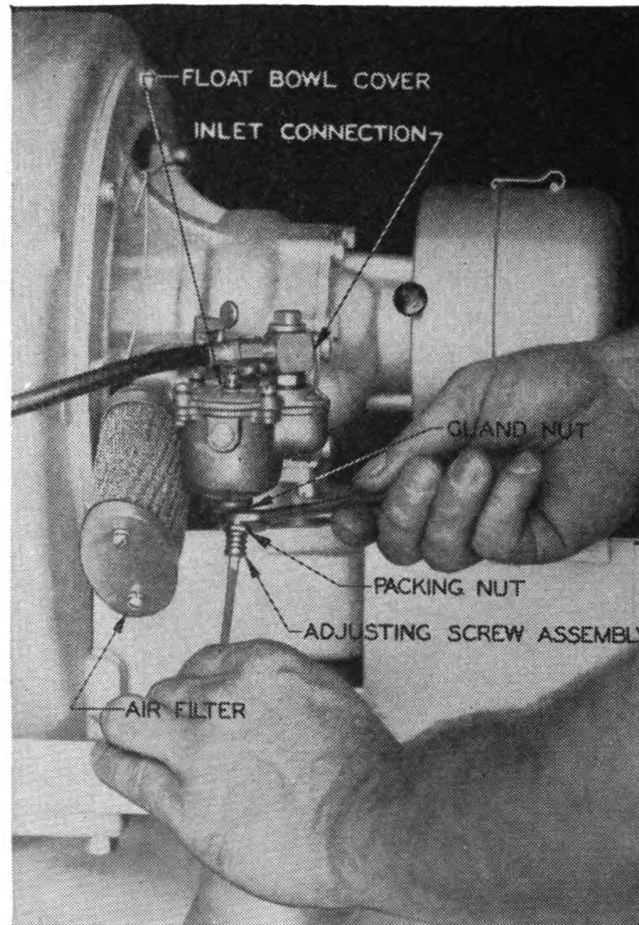

FIGURE 7.—Carburetor adjustment.

ing, it should be replaced. If the carburetor leaks, remove the float bowl cover and inspect the float lever pin, inlet needle, and seat. Replace if worn.

*d. Air filter.*—Clean the air filter on the carburetor intake monthly. Take apart and rinse in solvent, dry-cleaning. Then dip the upper end of the screen in oil, engine SAE 30 or SAE 40, and reassemble.

*e. Carbon and lead deposits.*—(1) The necessity for cleaning off carbon and lead deposits from the cylinder head depends upon the

average temperature in which the unit operates. In cool or cold weather, deposits do not build up rapidly, and the need for cleaning is unlikely in less than 200 hours of operation. In hot weather it may be necessary to clean the deposits every 75 to 100 hours of operation. The necessity for cleaning off the lead deposit in the cylinder head will be indicated by a sharp knock or pre-ignition ping in the engine especially under heavy loads or if the engine spits back through the carburetor and runs unevenly. This condition sometimes occurs before clogging of the exhaust ports which materially reduces the engine power.

(2) Before cleaning the carbon and lead deposits and inspecting

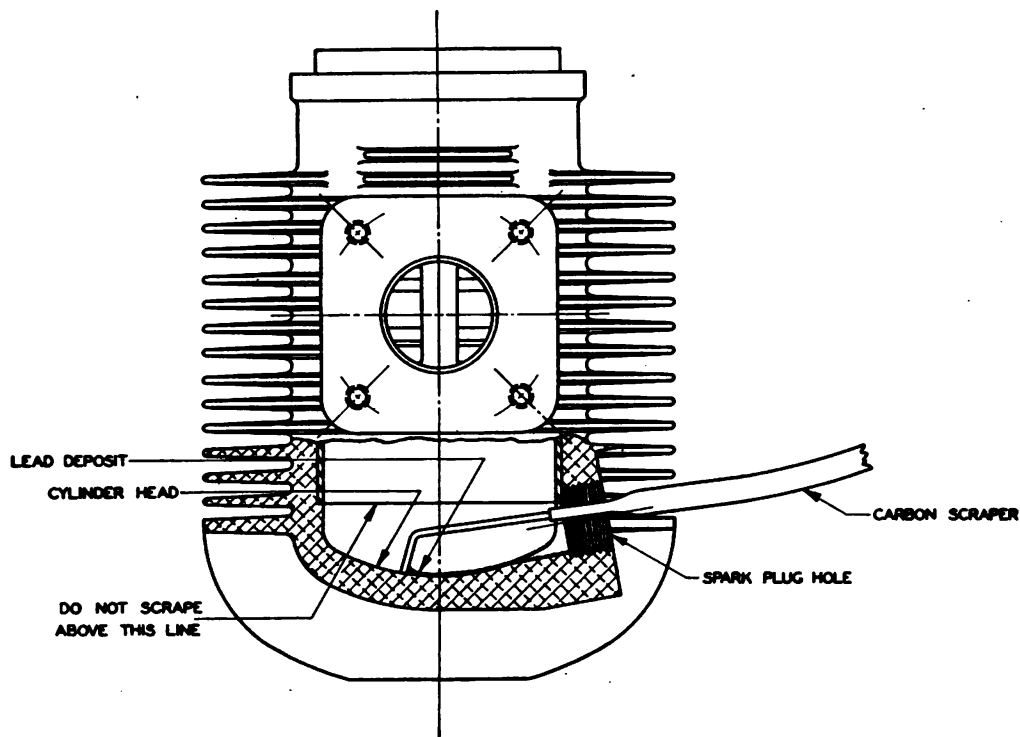

FIGURE 8.—Scraping carbon.

the cylinder exhaust ports for carbon and lead deposit, first check the spark plug and baffle, ignition, carburetor, and air cleaner as outlined in preceding instructions in this paragraph.

(3) *Cleaning carbon and lead deposits in cylinder heads.*—(a) Remove the spark plug and baffle as in instructions in *a*(1) above.

(b) Pry open the 3 clips on the shield over the magneto with a screw driver (fig. 1) and take off front half.

(c) Turn the starting plate on the magneto rotor, which is then exposed, so that the notch on the plate is at the top.

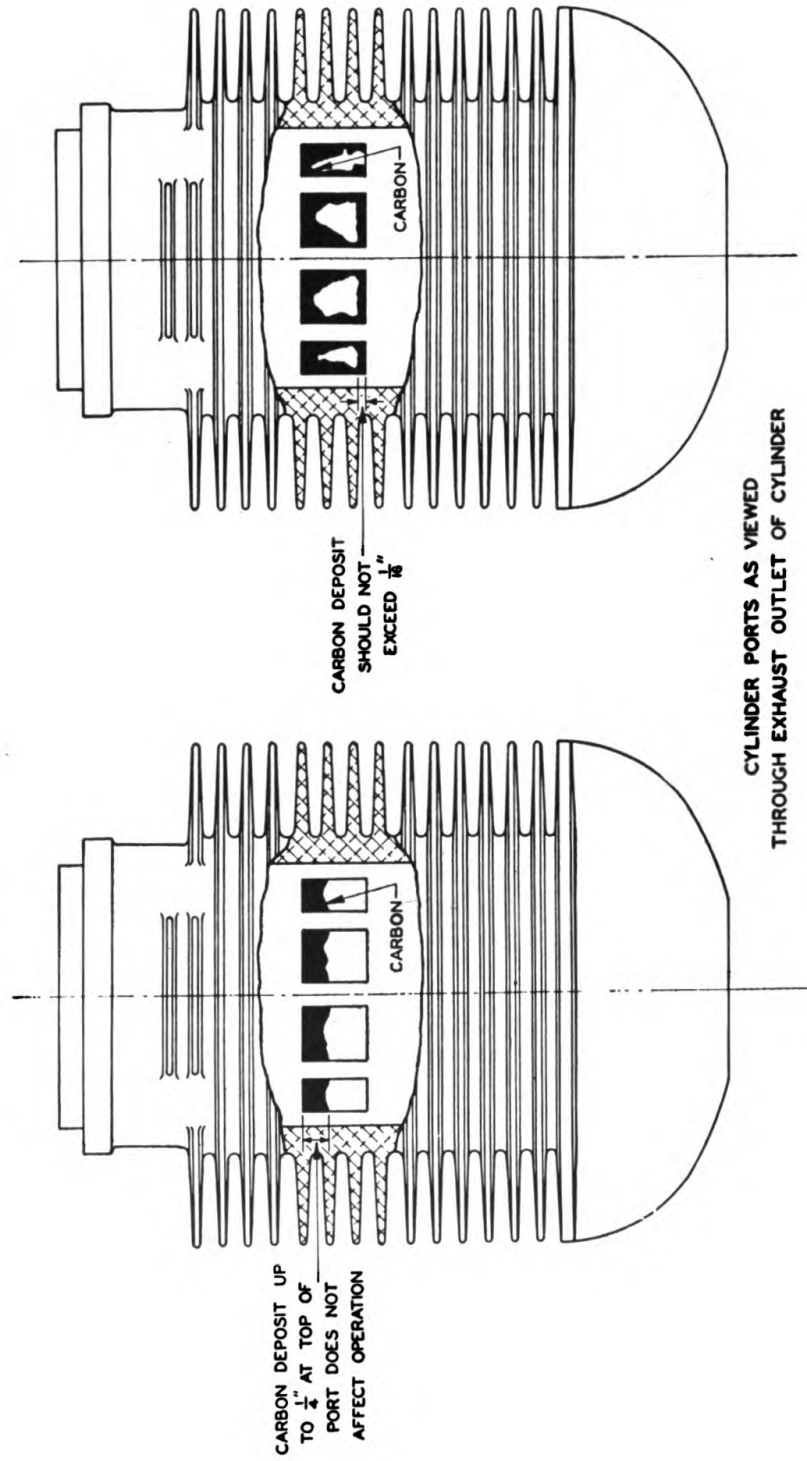

FIGURE 9.—Exhaust ports.

(d) Insert carbon scraper (8, fig. 5) through the spark plug hole and thoroughly scrape the cylinder head to loosen all deposits (see fig. 8). Remove the scraper.

(e) Depress the starting button and crank the engine for ten seconds to blow out loose particles through the spark plug hole. (If for any reason manual cranking is necessary, wind the starting rope counterclockwise on the starting plate and pull the rope hard, giving a quick spin to the engine. Repeat 8 to 10 times.) Since large pieces will not be blown out by this method, it is then necessary

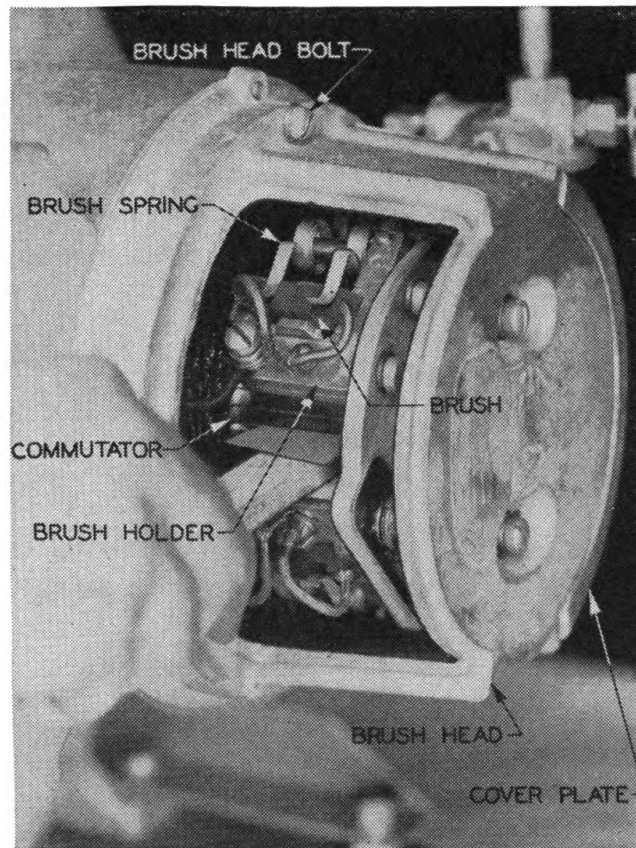

FIGURE 10.—Commutator cleaning.

to draw them out with the carbon scraper. Be sure to remove *all* loose pieces.

(4) *Inspecting cylinder ports.*—(a) Remove the duct assembly following instructions in paragraph 13b(2), (3), and (8) to (11), inclusive.

(b) The ports can then be inspected by using a flashlight. For location of ports see figure 9.

(c) Carbon formation on the *top* edge of the ports does not materially affect the power of the engine until such deposits project



down over  $\frac{1}{4}$  inch (fig. 9). If ports are carbonized over  $\frac{1}{16}$  inch above the *bottom* edge, the unit should be removed from the tank for carbon and lead cleaning, following instructions in section V.

**7. Generator.**—*a. General.*—If the engine is operating properly and the generator does not charge the batteries or operate the heater element, check all connections, both in the control box and at the heater element in the end of the duct. The control box can be inspected simply by removing the bakelite switch buttons and the screw holding the cover to the box. If all the circuits appear to be tight, the trouble must lie in the generator or in the controls.

*b. Commutator* (fig. 10).—(1) To inspect the commutator, remove the accessible brush head cover plate with an offset screw driver. The commutator should require no cleaning for several hundred hours of operation. It needs cleaning only when excessively carbonized.

(2) To clean the commutator, first start the engine and then place a strip of very fine sandpaper (00 to 8/0) (not emery) on the commutator and hold down with a stick of wood until commutator is clean.

SECTION IV

TROUBLE SHOOTING

General.....	Paragraph
Generator check list.....	8
Engine check list.....	9
	10

**8. General.**—As an aid in locating and repairing troubles which are likely to develop in the unit, check lists as in paragraphs 9 and 10 have been compiled.

**9. Generator check list.**

Trouble	Possible cause	Remedy
<i>a. Arcing at brushes.</i>	(1) Dirty commutator.	(1) Clean. See paragraph 7b.
	(2) Worn out brushes.	(2) Replace. See paragraph 14b(2).
	(3) Brushes stuck in holders.	(3) Loosen.
	(4) Brushes not properly seated.	(4) See paragraph 14b(2).
	(5) Short circuit in system.	(5) Check connections.
<i>b. Fails to generate current.</i>	(1) Brushes stuck in holders.	(1) Loosen.
	(2) Worn out brushes.	(2) Replace. See paragraph 14b(2).
	(3) Brushes not properly seated (especially new brushes).	(3) See paragraph 14b(2).

AUXILIARY GENERATOR FOR MEDIUM TANK M3 9

Trouble	Possible cause	Remedy
	(4) Dirty commutator.	(4) Clean. See paragraph 7b.
	(5) Broken connections.	(5) Rewire.
	(6) Defective armature.	(6) Replace. See paragraph 15a and 15b.
	(7) Defective coils.	(7) Replace. See paragraph 15a(1).
	(8) Defective capacitors in control box.	(8) Replace.
	(9) Defective switches in control box.	(9) Replace.
c. Fails to deliver rated output (approximately 50 amp.). See paragraph 4a and b.	(1) Engine not up to speed.	(1) See paragraph 10b.
	(2) Dirty commutator.	(2) Clean. See paragraph 7b.
	(3) Worn out brushes.	(3) Replace. See paragraph 14b(2).
	(4) Brushes not properly seated.	(4) See paragraph 14b(2).
	(5) Short circuit in system.	(5) Check connections.
d. Noisy radio reception.	(1) Defective capacitors in control box.	(1) Replace.
	(2) Loose connections in control box.	(2) Tighten connections.
	(3) Loose spark plug shielding assembly.	(3) Tighten.
	(4) Loose shielding conduit connections.	(4) Tighten.
	(5) Excessively dirty commutator.	(5) Clean. See paragraph 7b.
e. Batteries fail to take charge.	(1) Switch off in control box.	(1) Depress switch button.
	(2) Dead cell.	(2) Replace.
	(3) Defective wiring.	(3) Replace wiring.
	(4) Defective switch in control box.	(4) Replace.
	(5) Defective capacitor in control box.	(5) Replace.
f. Fails to operate heater element in duct.	(1) Switch off in control box.	(1) Depress switch button.
	(2) Defective switch in control box.	(2) Replace.
	(3) Loose connections between control box and element.	(3) Tighten.
	(4) Defective heater element.	(4) Replace. Entire assembly can be removed by taking off wing nut on outside of duct.

10. Engine check list.

Trouble*	Possible cause	Remedy
Fails to start.	<i>a. Defective spark plug.</i>	Replace every 25 hours of operation.
Hard to start.	(1) Carbon or lead deposit across points.	(1) Remove and clean.
Runs and stops.	(2) Points badly worn.	(2) Replace.
Not up to speed (3400 to 3600 rpm)	(3) Wrong type.	(3) Use a 14-mm high-temperature spark plug. See paragraph 13a.
Overheats.	(4) Cracked or dirty porcelain.	(4) Replace.
Loss of power.	(5) Points too wide or too close.	(5) Adjust to .025".
	(6) Wet from flooded engine.	(6) Wipe dry.
	<i>b. Fuel supply.</i>	
	(1) No fuel in tank.	(1) Fill.
	(2) Shut-off cock on fuel filter closed or clogged.	(2) Open or clean.
	(3) Strainer in fuel filter clogged.	(3) Remove bowl and clean.
	(4) Fuel line clogged.	(4) Clean out.
	(5) Water or dirt in fuel.	(5) Drain and clean.
	<i>c. Carburetor.</i>	
	(1) Improper adjustment.	(1) See paragraph 6c.
	(2) Strainer clogged.	(2) Remove and clean.
	(3) Nozzle clogged.	(3) Remove and clean.
	(4) Float stuck—flooded.	(4) Remove bowl cover and clean.
	(5) Float needle worn.	(5) Replace.
	(6) Water in float needle chamber.	(6) Drain.
	<i>d. Ignition.</i>	
	(1) Contact points out of adjustment.	(1) Adjust to .020". See paragraph 6b.
	(2) Contact points pitted.	(2) Hone or replace. See paragraph 6b(10).
	(3) Broken high voltage cable.	(3) Replace.
	(4) Loose connections.	(4) Tighten.
	(5) Coil defective.	(5) Replace. See paragraph 14a(2)(c).
	(6) Magnet weak.	(6) Replace.

\*In locating engine trouble it is always advisable to install a new spark plug first to see if this corrects difficulty. If it does not, leave the new plug in while checking further.

AUXILIARY GENERATOR FOR MEDIUM TANK M3 10-11

Trouble	Possible cause	Remedy
	(7) Capacitor defective. <i>e. Carbon.</i>	(7) Replace. See paragraph 14a(2)(c).
	(1) Cylinder ports clogged.	(1) Remove cylinder and scrape. See paragraph 14a(4)(a).
	(2) Piston and cylinder heads leaded or carbonized.	(2) Remove cylinder and scrape. See paragraph 14a(4)(a).
	(3) Muffler clogged.	(3) Replace. See paragraph 14a(4)(b).
	(4) Spark plug baffle clogged (replace every 75 hours of operation).	(4) Clean or replace.
	<i>f. Controls.</i>	
	(1) Loose connections in control box.	(1) Tighten.
	(2) Defective switch in control box.	(2) Replace.
	(3) Defective capacitor in control box.	(3) Replace.
	(4) Loose connections at main control box of tank.	(4) Tighten.
	(5) Loose or corroded connections at battery (or dead battery).	(5) Tighten or replace.

SECTION V

SERVICE AND REPAIR

	Paragraph
General .....	11
Lubrication.....	12
Removing unit from tank.....	13
Procedure in case of heater-generator failure.....	14
Dismantling.....	15
Assembly.....	16
Re-installation of unit in tank.....	17

11. **General.**—The heater-generator should be inspected once a month for general condition, cleanliness, and proper operation. The simplest method of checking output is by operating the heater element. If the unit does not deliver 50 amperes, consult section IV and then paragraphs 14 to 17, inclusive. All service work can be performed by one man, however assistance is required in re-installing in the tank units which have been taken out for repairs.

12. **Lubrication.**—The unit requires no lubrication other than the oil mixed with the gasoline as in paragraph 3*a* and occasional oiling of the magneto cam. (See par. 14*a*(2)(*e*).)

13. **Removing unit from tank.**—*a.* To service the unit completely, it is necessary to remove it from the tank. For checking the spark plug, ignition, carburetor (par. 6), and cleaning the commutator (par. 7*b*), the unit does not need to be removed.

*b.* To remove the unit proceed as follows:

(1) Open the main battery switch of the tank.

(2) Take out the two front and two back screws holding the duct cover to the duct (fig. 1) with a screw driver and take off the cover.

(3) Remove the four socket head cap screws at the cylinder end of the flexible exhaust coupling, which are then exposed (fig. 11).

(4) Close the shut-off cock on the fuel filter (fig. 2) and disconnect the fuel line at the carburetor.

(5) Remove the control box from the generator as follows:

(*a*) Take off the three black knurled buttons and lockwashers; remove the screw below the ammeter and take off the cover. Allow the cover to hang by the inside connecting wires.

(*b*) Disconnect, at the terminals in the control box, the three wires that come through the back of the box from the generator yoke. These are coded red, red and green, and black. The grommets on the wires can be removed from terminals with a pair of pliers.

(*c*) Remove the two screws holding the box to the generator yoke (just above the fiber panel in box).

**Caution:** Use care not to drop these screws and washers in back of the panel board. If accidentally dropped, be certain to remove them before assembling, as they may cause a short circuit.

(*d*) Push the three wires disconnected in preceding instructions ((*b*) above) through the hole in the box and take off the control box. Any repair work on the control box can be accomplished in the tank so that further removal is unnecessary.

(6) Remove the four bolts which fasten the fan housing to the angle iron supports (fig. 1).

(7) Take off the nut on the front end of the right angle iron and swing the angle away from the unit to facilitate removal.

(8) Lift unit out of tank.

(9) If necessary to take out the duct assembly, unscrew the wing nut on the heater mounting plate (fig. 1) and take out the heater assembly.

(10) Disconnect the flange at the end of the muffler by taking out the three screws, accessible through the duct door and element plate opening.

(11) Take out the screws holding the duct to the engine bulk-head. Also remove two screws fastening the duct to the sponson near the engine end. The duct can then be removed.

**14. Procedure in case of heater-generator failure.—a. Engine.**—When the engine fails to operate and there is fuel in the tank, the ignition, carburetor and compression should be checked in the order named.

(1) *Spark plug.*

**NOTE.**—In locating engine trouble, replace the spark plug. (See par. 6a.) If this does not correct the trouble, leave in place while checking further.

(a) Failure of the plug may be due to improper adjustment of the points or a cracked or dirty porcelain. Correct adjustment of points is .025 inch. Carbon or lead deposits across the points will also cause failure.

(b) Spark plugs are made in a wide range of types to suit the temperature requirements of different engines. It is extremely important that a spark plug of the proper heat range be used with this engine. A 14-mm high-temperature spark plug, such as the Champion J-10 commercial, should always be used.

(c) *Fouling.*—If the spark plug is very wet it indicates excess fuel in the cylinder. In such cases, turn over the engine with the choke off (wide open) with the plug and baffle removed. Then insert a rag on the end of a stick through the spark plug hole, and wipe the cylinder head dry. Clean and dry the spark plug. Fouling may be caused by an excessive amount of oil. Too rich a setting of the carburetor tends to foul the plug and causes excess carbon. For proper setting of the carburetor see paragraph 6c.

(2) *Ignition* (fig. 6).—(a) The ignition of this engine is supplied by a high voltage flywheel type magneto mounted as a complete assembly at the end of the intake valve shaft. This consists of a magnet mounted in the rotor, a high voltage coil mounted on the stator plate, and the contact point assembly and capacitor. The entire assembly is inclosed in a divided shield to eliminate radio interference. For adjustment see paragraph 6b.

(b) *Replacing cables.*—Chafed or broken cables which are a cause of continuous or intermittent misfiring should be replaced. On the high voltage cable, strip the magneto end  $\frac{1}{2}$  inch, twist the strands together, and attach to the coil. It is essential that the bare end

be kept short and folded down close to the coil surface after the cable is in place. *It is unnecessary to solder the cable to the coil.* On the spark plug end, strip the cable  $\frac{1}{4}$  inch and insert in the molded tube so that the bare end of the wire protrudes through the brass insert at the base of the spring. Fan out the strands of bare wire to hold it in place. Do not solder the wire.

(c) *Coil and capacitor.*—If no spark, or a weak spark, is obtained after adjusting the contact points, the trouble is likely to be in the capacitor or coil, although failure of these parts is not a common cause of trouble. Replace either one or both to obtain a strong spark only after checking the spark plug, cables, connections and contact points. (The coil is not furnished separately but only as an assembly with laminated core.) In replacing the coil and core assembly, the three machined faces of the laminations must line up exactly with the three machined bosses on the stator plate. The screws must be tightened securely.

(d) *Magnet.*—In normal use the magnet will retain its magnetism indefinitely, and therefore no trouble should be expected from this source.

(e) *Lubrication.*—The magneto should require no lubrication for a long period of service. For cam lubrication add a *drop or two* of oil, engine, SAE 30, on the oil wick approximately every 20 hours of operation.

(3) *Carburetor.*—See paragraph 6c.

(4) *Cleaning carbon and lead deposits* (see par. 6e).—(a) Remove the cylinder for a thorough cleaning of the exhaust ports, cylinder, and piston heads. It is important that all deposits be scraped off the cylinder, piston head and exhaust ports. In cleaning exhaust ports use care not to break or bur edges of the ports, since these are chamfered to a fine edge. To remove the cylinder, disconnect the shielding conduit at the spark plug, take off the cylinder shields, remove the spark plug, and take out the four cylinder screws. Cylinder can then be lowered and removed.

(b) Checking muffler for carbonization can best be done by installing a new one. If the power is increased with the new assembly, discard the old assembly.

(5) *Piston rings.*—(a) The piston rings should make contact with the cylinder wall around the entire circumference. If the end clearances, when in the cylinder, exceed .020 inch, or if the rings are stuck in grooves, the rings should be replaced.

(b) Before replacing the rings, clean carbon from the grooves

carefully. (The side clearances in grooves for replacement rings should be between .002 and .0035 inch.)

(c) The ring tension should not be below 3 pounds on worn rings nor above 5 pounds on new replacement rings. The tension may be determined by the pressure required to close the end gap when one side of the ring is placed on the platform of a spring scale with the gap 90° from the point of contact on the scale. Apply pressure at 180° from contact point on the scale.

(d) In reassembling the piston assembly in the cylinder make sure that the intake ports of the piston are on the same side as the intake ports in the cylinder. To break in new piston rings, see instructions in (6) (c) below.

(6) *Piston and pin.*—(a) These parts are furnished only as an assembly, since the pins are selectively fitted to the pistons to give a very light press fit.

(b) Piston wear is negligible. Replacement will be made only if scored, if the ring grooves are damaged, or if the piston pin is loose in bosses.

(c) After replacing a piston, cylinder, or rings, the engine is to be run for a period of at least 1 hour at idling speed before applying load to the generator. If there is excessive arcing at the brushes while idling, remove the brushes from their sockets.

(7) *Governor.*—(a) No adjustments are to be made on the governor. Each governor is set exactly for the requirements of the individual unit and should not require any attention during the life of the engine. Although to all appearances governors may look the same, there is, nevertheless, a difference in the weights and springs used which control the engine speed. The springs are not common springs which may be purchased readily, but are special heat-treated springs individually tested. Do not tamper with the governor spring. Use extreme care that the governor assembly is not damaged in any manner.

(b) Governors must be replaced as complete assemblies. It is necessary to give the serial number of the unit for which the governor is required, when ordering replacements.

*b. Generator.*—See the check lists (pars. 9 and 10) and then check the following items (see figs. 12, 13, and 14) :

(1) *Commutator.*—See paragraph 7b.

(2) *Brushes* (fig. 10).—(a) Brushes should be inspected every 300 hours of operation, and require replacement only if the brush spring rides on the brush holder.



(b) To inspect, remove the brush head cover plates.

(c) New brushes are formed to the shape of the commutator to eliminate arcing and to insure perfect electrical contact. In replacing the brushes, no special care in "wearing in" is required.

(d) The two screws in the end of the brush head should be located in approximately the center of the slot and should be tight.

(3) *Brush springs* (fig. 10).—The tension of the brush springs should be 12 to 14 ounces.

(4) *Control box*.—If the switches are defective, remove by dis-

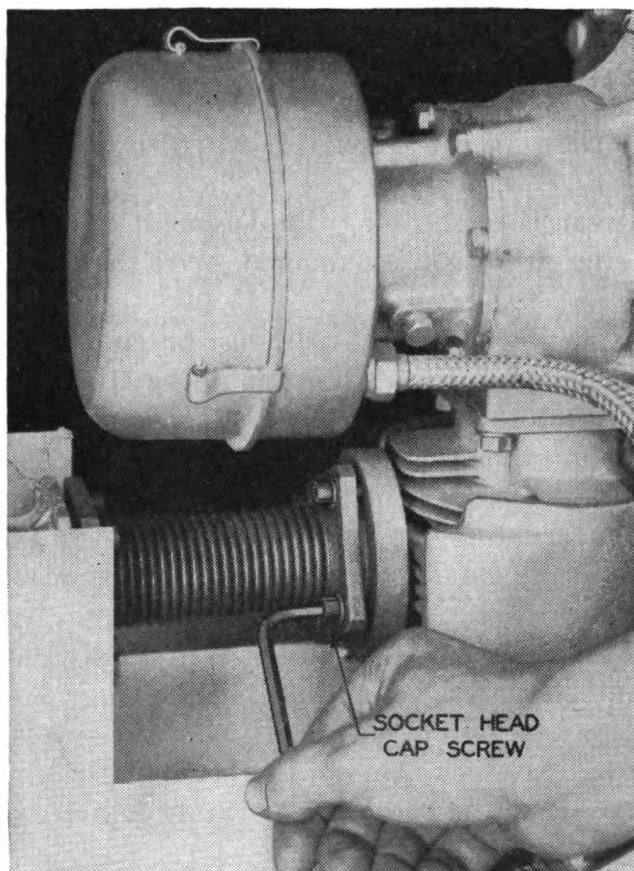

FIGURE 11.—Disconnecting exhaust coupling.

connecting all leads and taking out holding screws (cadmium plated screws nearest side walls of box).

**15. Dismantling.**—The special tools illustrated in figure 5 will be needed for complete dismantling and assembling operations. Parts will be inspected as they are removed to determine if they are worn, loose fitting, or defective, and if necessary they will be replaced. All open ball bearings will be cleaned with Solvent, dry-cleaning, and carefully wrapped to keep them clean and dry.

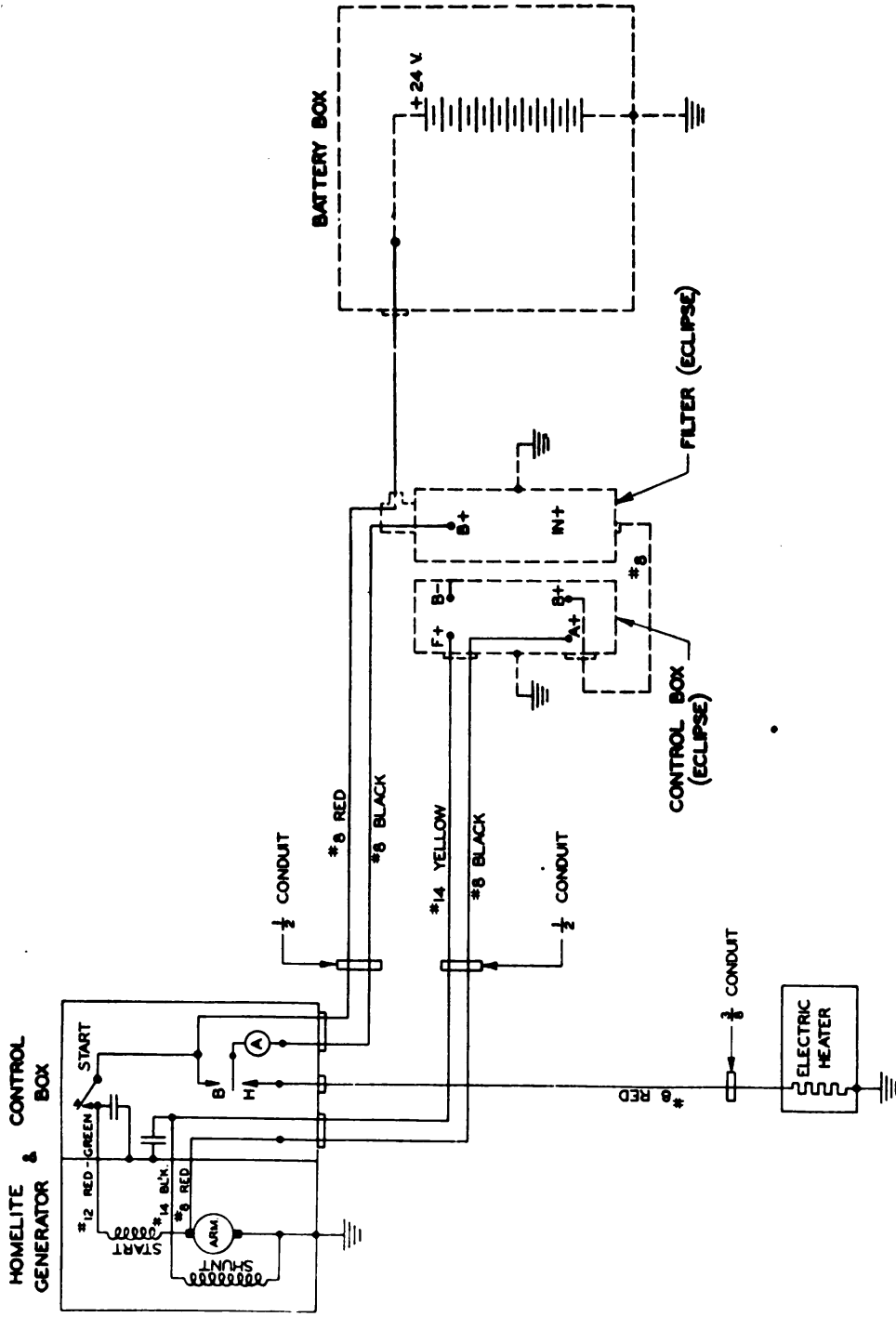
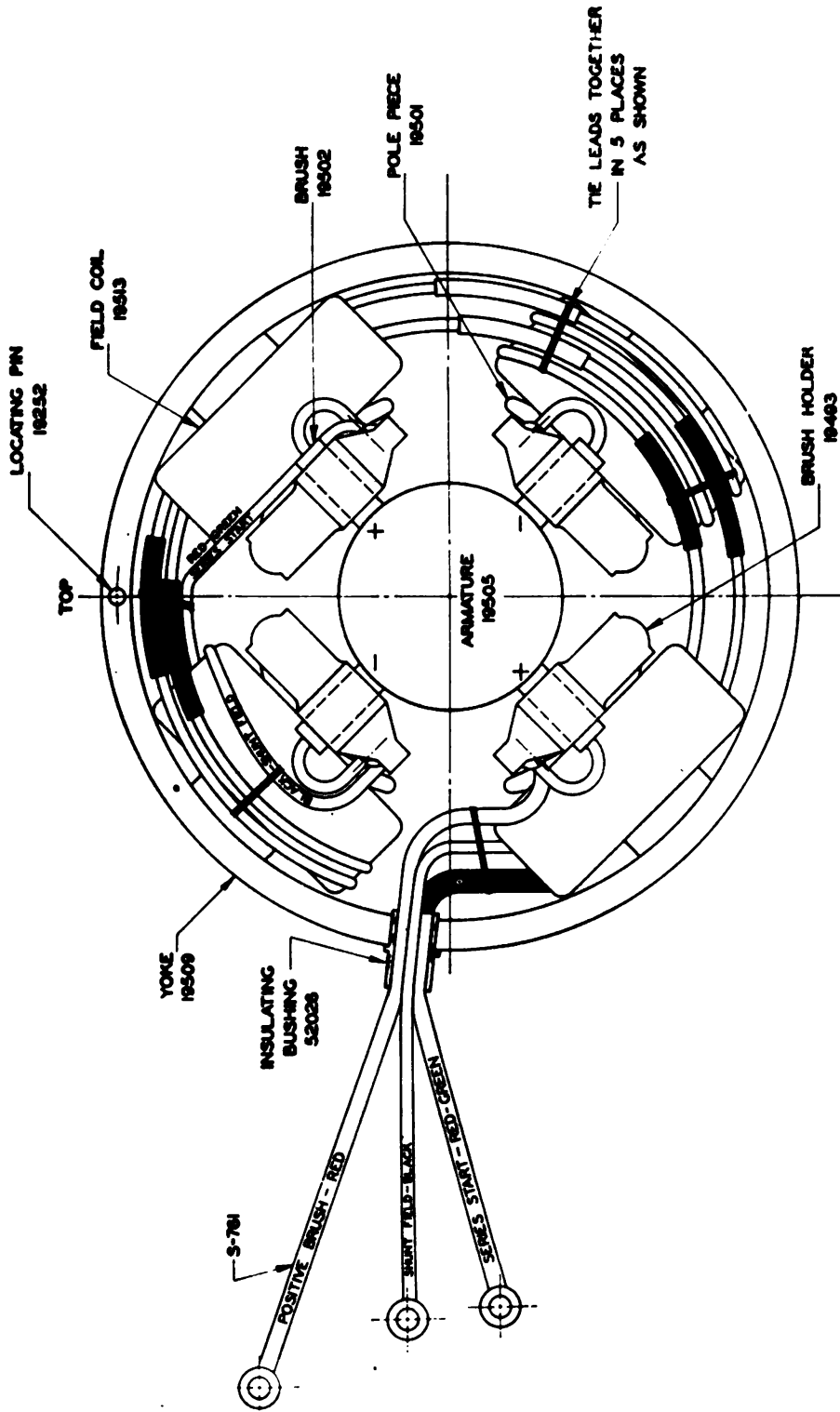

FIGURE 12.—Generator and controls, schematic wiring diagram.

Generated on 2016-07-11 13:45 GMT / http://hdl.handle.net/2027/uc1.b3243967  
Public Domain, Google-digitized / http://www.hathitrust.org/access\_use#pd-google



BRUSH HEAD END OF COILS  
BRUSH HEAD 18468-A REMOVED

FIGURE 13.—Generator, practical wiring diagram.

*a. Generator end.*—(1) To remove yoke and coil assembly (fig. 2).—  
(a) Take off the two brush head cover plates and lift the eight brushes out of their sockets (fig. 10).

(b) Remove the four bolts on the brush head (fig. 10), insert screw drivers in the two notches on the fan housing and gently pry the yoke away. Do not remove the two screws in the end of the brush head.

(2) To remove armature, take out the bolt at the end of the armature shaft which holds the armature to the engine crankshaft. Then if the armature does not come free from the shaft readily, in place of the armature bolt insert the long armature pin (6, fig. 5) and its jack screw. Turn up the screw as far as the threads permit. Remove the jack screw and insert one short pin; repeat operation. Again repeat operation with the remaining two pins successively. Armature will then come free.

(3) To remove the brush head from yoke, disconnect the red, green and red, and black leads from the brush holders. The brush holder assembly can be removed from the brush head by taking out the two screws in the slots in the face of the brush head.

*b. Engine end.*—(1) *Removing cylinder, piston and connecting rod assembly.*—(a) Disconnect shielding assembly at spark plug and take out the spark plug.

(b) Remove both halves of the cylinder shield.

(c) Remove the timer bracket screws. The magneto and carburetor can be removed as an assembly (fig. 15). (For work on the magneto and magneto assembly see instructions in (2) below.

(d) Remove the crankpin screw from the crankpin (fig. 16). To prevent the shaft from turning, insert a screw driver between the vanes of the flywheel. Be careful that the screw driver does not damage the generator field coils.

(e) Remove the four screws holding the cylinder and lower and remove the cylinder. Between the piston and cylinder, a minimum clearance of .002 inch and a maximum clearance of .005 inch is allowed. If the clearance is greater than allowable the cylinder should be replaced.

(f) Place the crankthrow at bottom dead center.

(g) Insert the crankpin bearing puller (3, fig. 5) so that prongs extend around the ball bearing and the jack screw comes in contact with the crankthrow pin (fig. 17). Screw down on the jack screw, pulling the connecting rod and bearing from the crankpin.

(h) Remove the puller, hold the bearing forward and turn the crankpin to top dead center.

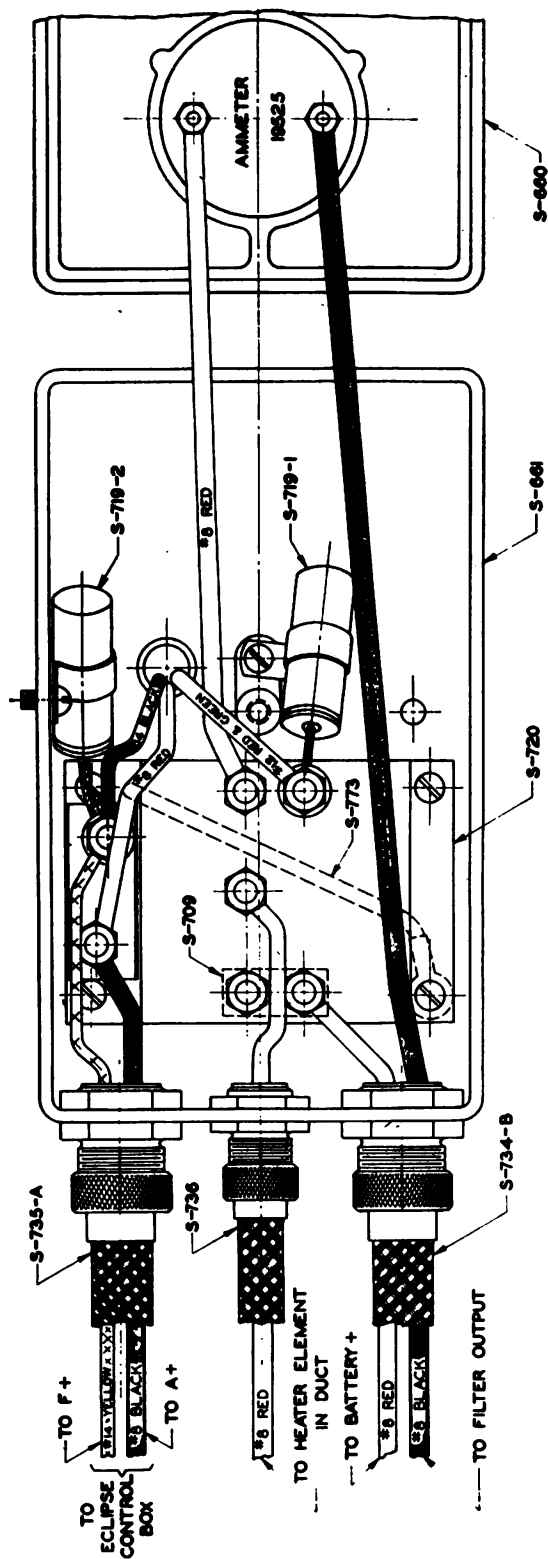

FIGURE 14.—Control box, practical wiring diagram.

- (i) Remove the piston and connecting rod assembly together.
- (j) Carbon and lead deposits can then be cleaned from exhaust ports, piston and cylinder heads. (See par. 14a(4).) If rings are stuck or not seating properly, replace according to instructions in paragraph 14a(5). If the piston is badly worn, or the pin is loose in the piston, replace with a new piston and pin. (See instructions, par. 14a(6).)
- (k) Further dismantling of the engine is seldom necessary and is required only in case of replacing main ball bearings, crankshaft, flywheel, or crankcase.
- (2) *Dismantling magneto and timer bracket assembly.*—(a) With a screw driver, pry open the three clips holding the divided shield over the magneto and remove the front half of the shield (fig. 1).

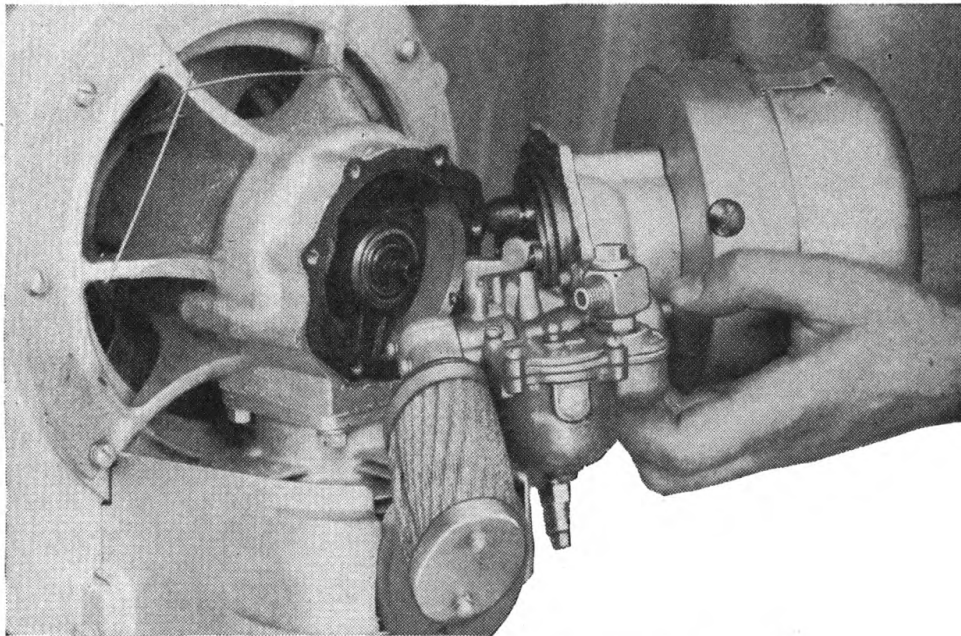

FIGURE 15.—Removing magneto and carburetor assembly.

- (b) Remove the magneto rotor by loosening the rotor nut. Do not remove the three screws holding the starting plate to the rotor.
- (c) Remove the rotor drive key and then the cam lock nut.
- (d) Take off the cam, cam spacer, and the cam key.
- (e) Remove the magneto stator plate (back plate) by taking out the two holding screws.
- (f) Drive out the intake valve shaft by striking on the threaded end with a wood or lead mallet. Use extreme care that the governor assembly is not damaged in this operation. The governor assembly can be removed from the shaft by releasing the snap ring.

(g) Remove both bearings by inserting the bearing remover (5, fig. 5) through the rear bearing and driving out. Do not disturb the bearings unless they are worn.

(3) *Removing crankshaft.*—Before dismantling the crankshaft, dismantle the generator end as in preceding instructions.

(a) Remove the large hexagonal nut and washer from the rear of the flywheel. This has a left-hand thread.

(b) The front main bearing is held in the crankcase by two special

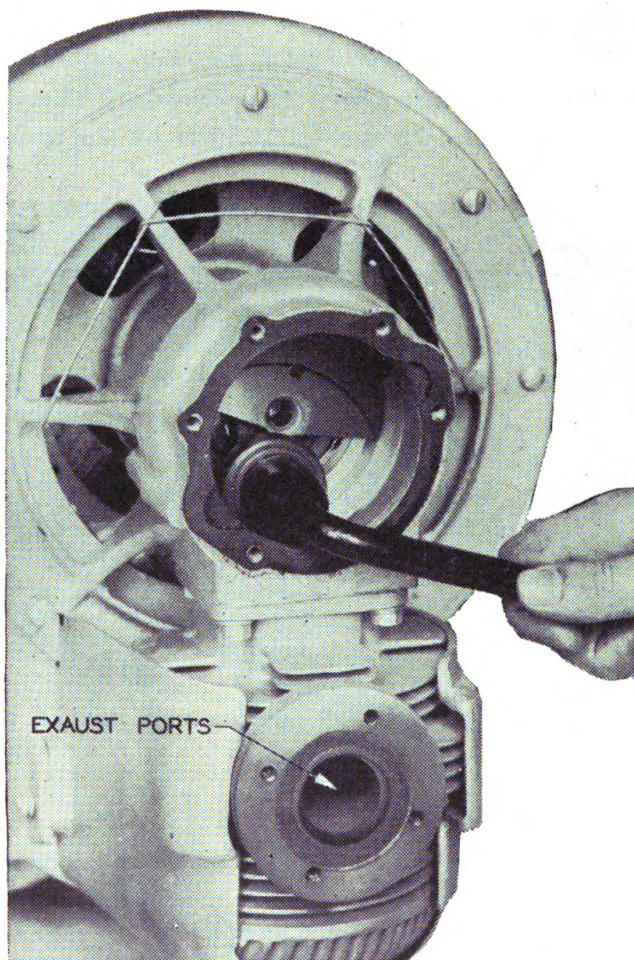

FIGURE 16.—Removing crankpin screw.

$\frac{1}{4}$ -inch screws and washers. These must be removed before the shaft puller is applied. Place the shaft puller (1, fig. 5) on the end of crankcase so that it fits over the crankthrow (fig. 18). Insert the jack screw and screw it into the center of the shaft. Then by turning down the nut, the crankshaft will be drawn free of the crankcase, leaving the flywheel still securely in place in the crankcase. The front main bearing will usually come out on the shaft. Should this

bearing remain in the crankcase, it may be removed as in (c) below.

(c) Remove the flywheel as in (4) below. After the flywheel has been removed leave the bearing spacer in the crankcase. Place a block of wood on this spacer on the flywheel side. By tapping this block with a hammer, the bearing will be driven out.

(4) *Removing flywheel from crankcase.*—**Caution:** The three holes in the face of the flywheel are *not* to be used in removing the

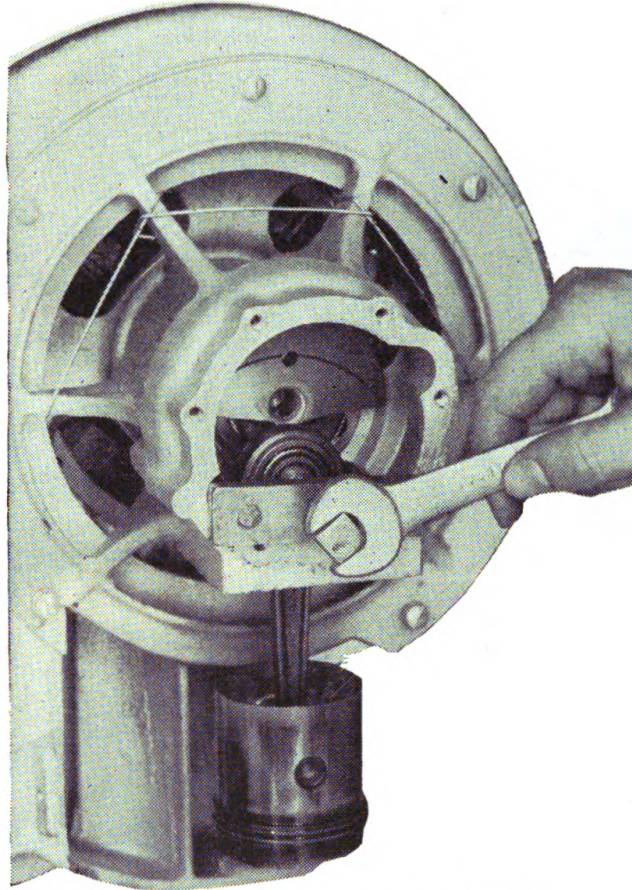

FIGURE 17.—Removing connecting rod and bearing.

flywheel, but are for the removal of the flywheel bearing after the flywheel has been removed from the crankcase. (See (5) below.)

(a) Remove the crankcase from the fan housing if not previously done.

(b) Place the flywheel remover (4, fig. 5) so that the crossbar fits into the recess inside the crankcase and the bronze collar passes through the openings in the crankcase and comes in contact with the crankshaft spacer (fig. 19).



(c) By screwing down on the jack screw, the flywheel and bearing will be pressed from the crankcase.

(5) *Removing bearing from flywheel* (after removing flywheel from crankcase).

NOTE.—This is only necessary in case of bearing failure when new bearing has to be installed.

Use three  $\frac{1}{4}$ -inch screws in the holes in the flywheel (after removing cork fillers) and screw down, being careful to have equal pressure

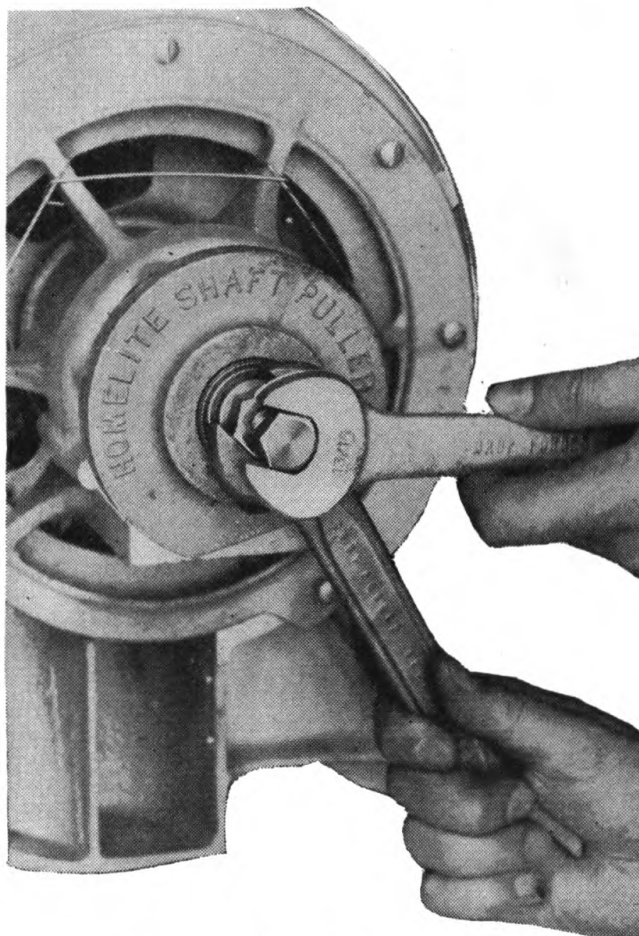

FIGURE 18.—Removing the crankshaft.

on each screw to avoid cramping the bearing on the hub of the flywheel.

**16. Assembly.**—*a. Engine end.*—(1) *Assembling crankshaft in crankcase.*—(a) The main bearing at the cylinder end of the crankcase should first be assembled on the crankshaft with the crankcase sealing gasket behind it. The shielded side of the bearing should be next to the crankcase sealing gasket.

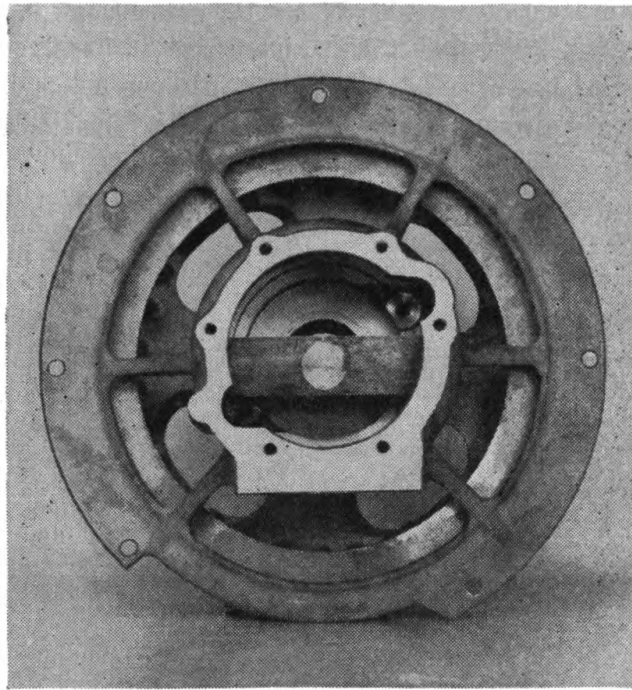

FIGURE 19.—Removing flywheel.

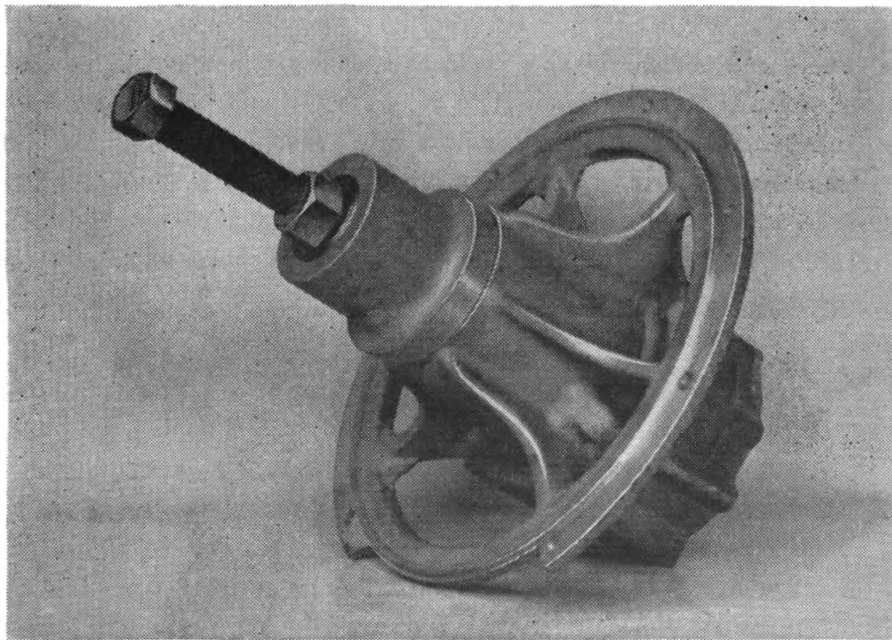

FIGURE 20.—Assembling crankshaft.

(b) Place the crankshaft through the crankcase as far as possible by hand.

(c) Place the assembling fixture (2, fig. 5) on the flywheel end of the crankcase (fig. 20); insert the jack screw and screw it onto the stud in the end of the crankshaft. (Note this is a left-hand thread.) Then by screwing down on nut, the crankshaft will be drawn into

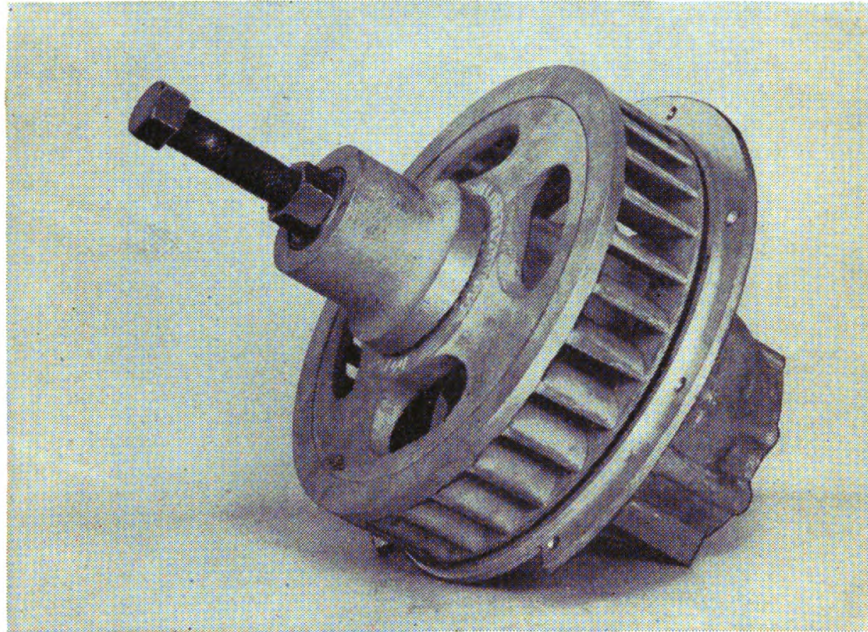

FIGURE 21.—Assembling flywheel.

place. Hold the head of the jack screw with a wrench to keep it from unscrewing from the shaft.

(d) Remove the fixture and jack screw.

(e) Fasten the main front bearing in place with two screws and washers.

(2) *Assembling flywheel on crankshaft and crankcase.*

NOTE.—Flywheel bearing is to be pressed onto flywheel hub if previously removed.

(a) Place the crankshaft space collar on the crankshaft with the shoulder to the flywheel end.

(b) Place the flywheel on the shaft, being very careful that *both keyways* are in proper alinement with the keys in the shaft.

(c) Place the assembling fixture (2, fig. 5) over the end of the crankshaft and against the flywheel (fig. 21). Insert the jack screw, and screw it onto the stud in the end of the crankshaft (left-hand thread). Then, by screwing down on the nut, the flywheel will be

pressed solidly into place. Hold the jack screw head with a wrench to keep it from unscrewing from the shaft.

(*d*) Remove the fixture and jack screw, and put the flywheel washer and nut on the crankshaft (left-hand thread).

(3) *Replacing engine assembly in fan housing.*—Place in position and fasten the crankcase to the fan housing with  $\frac{1}{4}$ -inch screws.

(4) *Replacing magneto and timer bracket assembly.*—(*a*) If the bearings have been removed from the timer bracket, insert the small spacer, then place the rear bearing in position, and drive into place with the bearing remover (5, fig. 5). Then insert the bearing spacer and drive the front bearing into place.

(*b*) Replace the magneto stator plate assembly with the rear half of the shield, and fasten the holding screws.

(*c*) If bearings were replaced as in (*a*) above, drive the rear bearing until spacer between bearings is tight.

(*d*) Assembly of other parts is made by reversing the procedure of dismantling instructions (par. 15*b*, (2) (*a*), (*b*), (*c*), (*d*), and (*f*)), being sure that the breaker cam is replaced with the arrow (indicating rotation) on the outside.

(5) *Replacing piston, connecting rod assembly, and cylinder.*—These parts may now be assembled in place by reversing engine dismantling operations (par. 15*b*(1)).

(*a*) In reassembling the piston in the cylinder, make sure the intake ports of the piston are on the same side as the intake ports in the cylinder.

(*b*) In tightening the crankpin screw, set it tight by hand. Do not strike wrench with a hammer.

(*c*) Use care in assembling the governor and intake valve shaft so as not to damage the governor. The intake valve spring (long spring) goes through a hole in the shaft head and the short spring into the recessed hole.

(*d*) When replacing the magneto and carburetor assembly, see that the intake valve spring fits in the center of the crankpin screw with the hole in the head of the shaft over the screw.

(*e*) When installing the spark plug, place it through the metal shield and place the gasket on the plug outside of the shield.

*b. Generator end.*—(1) Reverse dismantling instructions (par. 15*a*), making sure the key is in place in the crankshaft keyway before replacing the armature on the shaft.

(2) If the armature does not go on the shaft readily, push on as far as possible; then screw assembly tool (7, fig. 5) into the center of the shaft. Screw down on the nut on the assembly tool until

the armature is in place. Remove the tool and replace the armature bolt and washers.

(3) For wiring diagram see figure 13.

17. Reinstallation of unit in tank.—*a.* If the duct assembly has

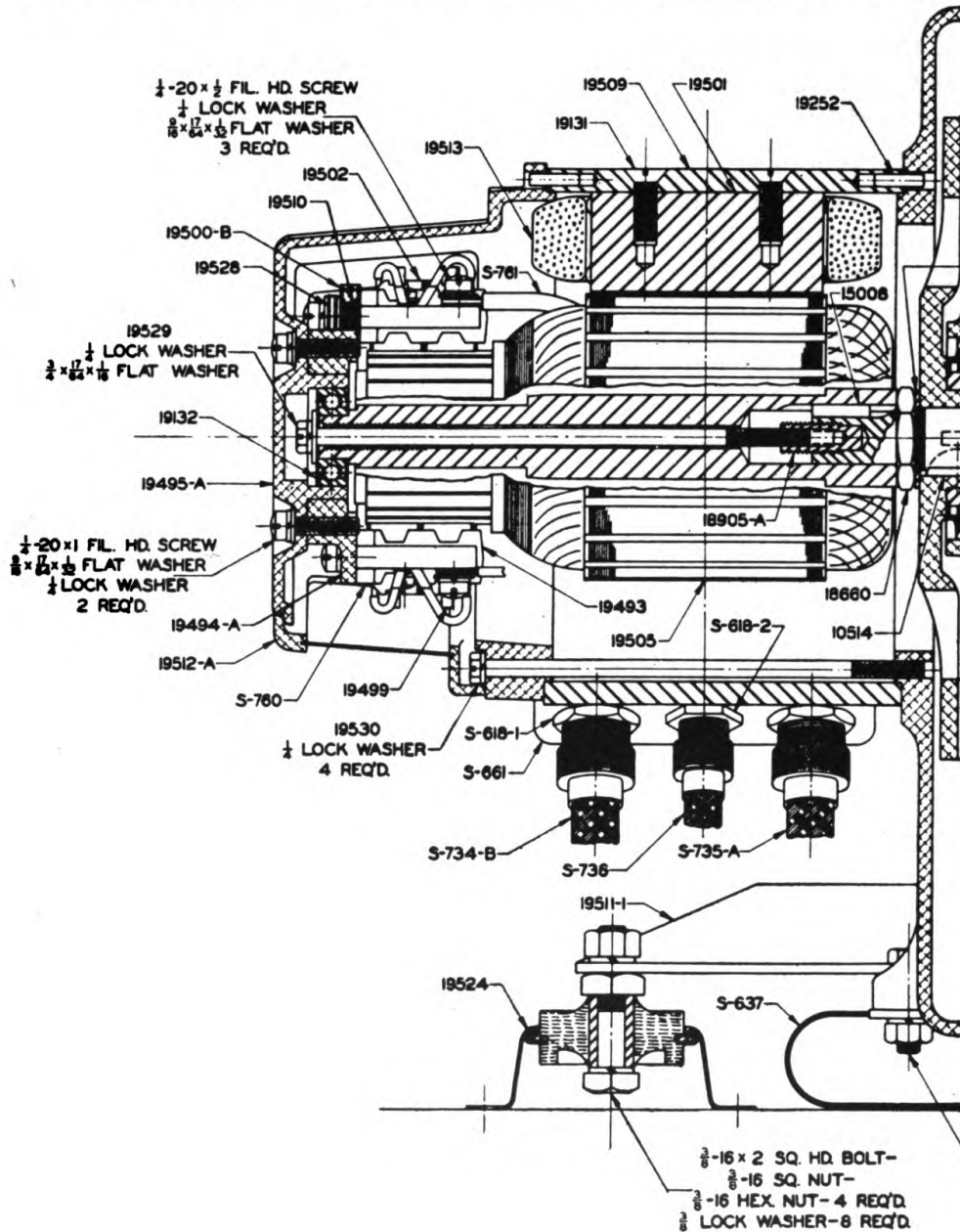

FIGURE 22.—Cross-sectional diagram of auxiliary generator.

been removed, install by reversing instructions (par. 13*b*(8) to (10), incl.). Do not omit the gasket between the duct and the engine bulkhead.

*b.* Place the unit in position and install by reversing removal instructions (par. 13*b*(1) to (6), incl.). To line up the bolt holes

in the left angle (carburetor side) and fan housing, assistance will be required. The assistant should use a pry bar beneath the unit to facilitate this alinement.

(1) The fan housing base goes beneath the angle irons (fig. 1).

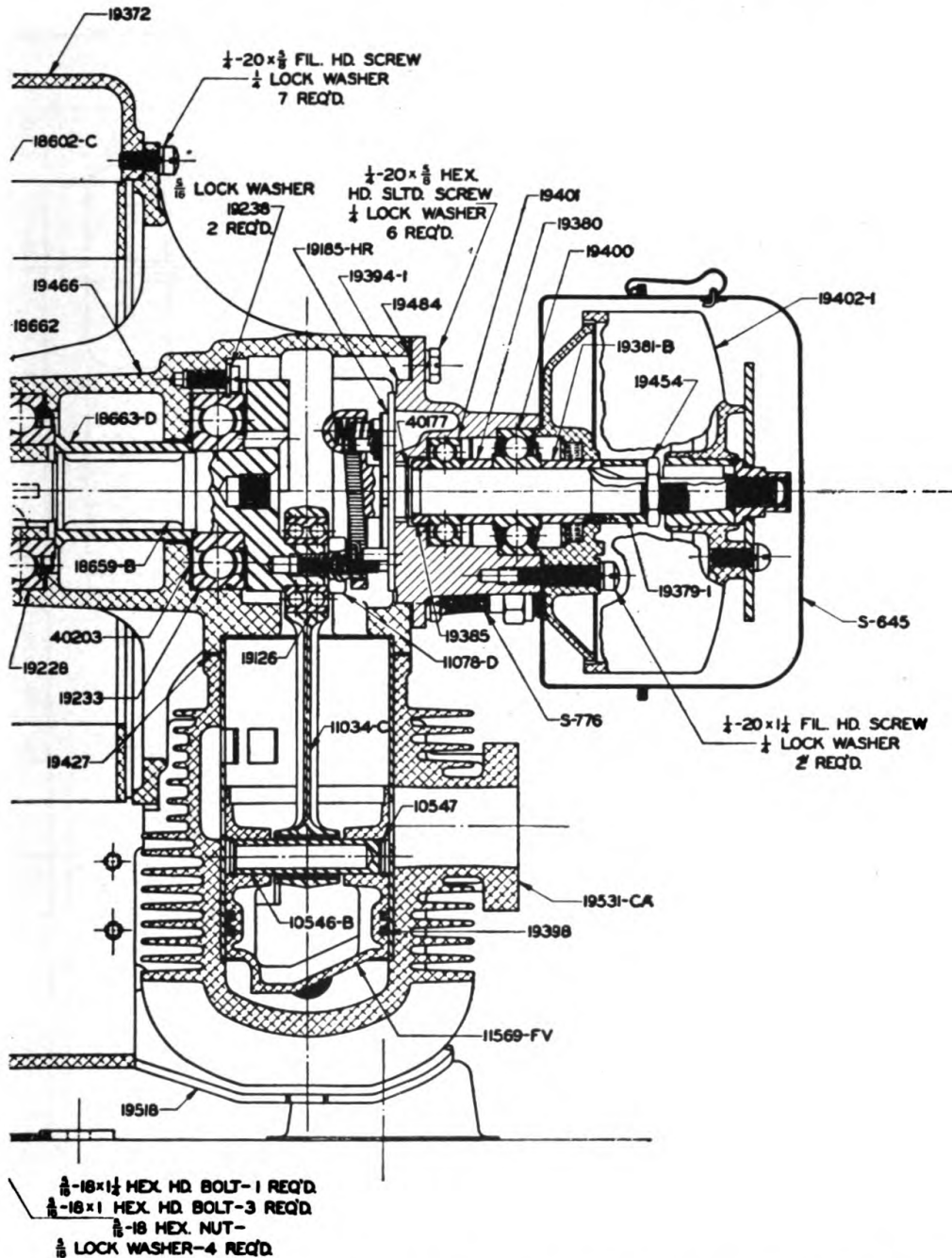

(2) The shielded conduits from the control box go beneath the fan housing base and in back of the front foot mounting (fig. 1).

(3) Do not omit connecting the ground strap beneath the rear

bolt on the right angle (fig. 1). This bolt is  $\frac{1}{4}$ -inch longer than the others.

(4) See wiring diagram (fig. 14) for connections in control box.

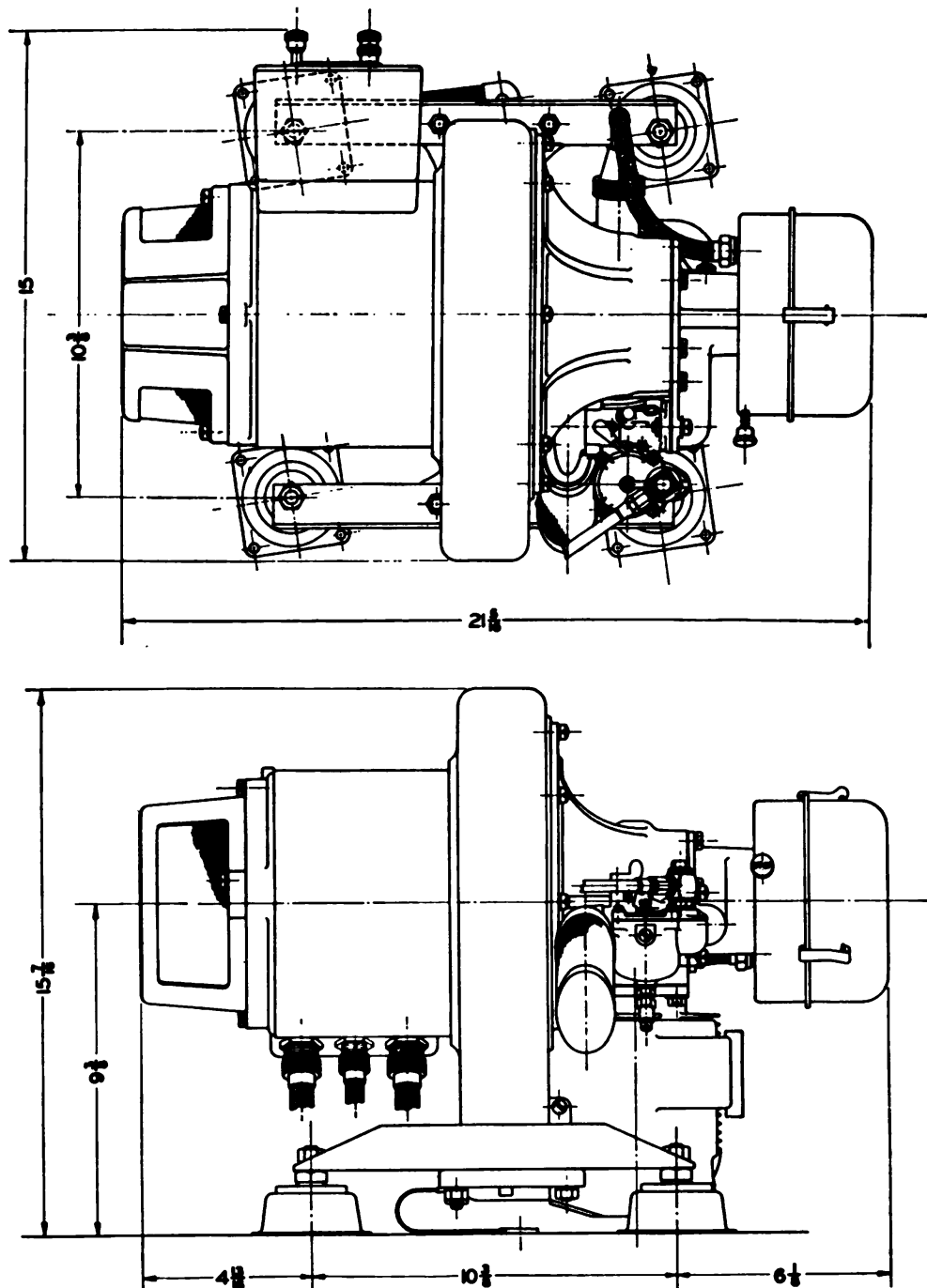

FIGURE 23.—Dimensional sketch of auxiliary generator.

(5) Do not omit the gasket between the cylinder and the flexible exhaust coupling.

NOTE.—If proper operation is not obtained, consult the check lists (pars. 9 and 10).

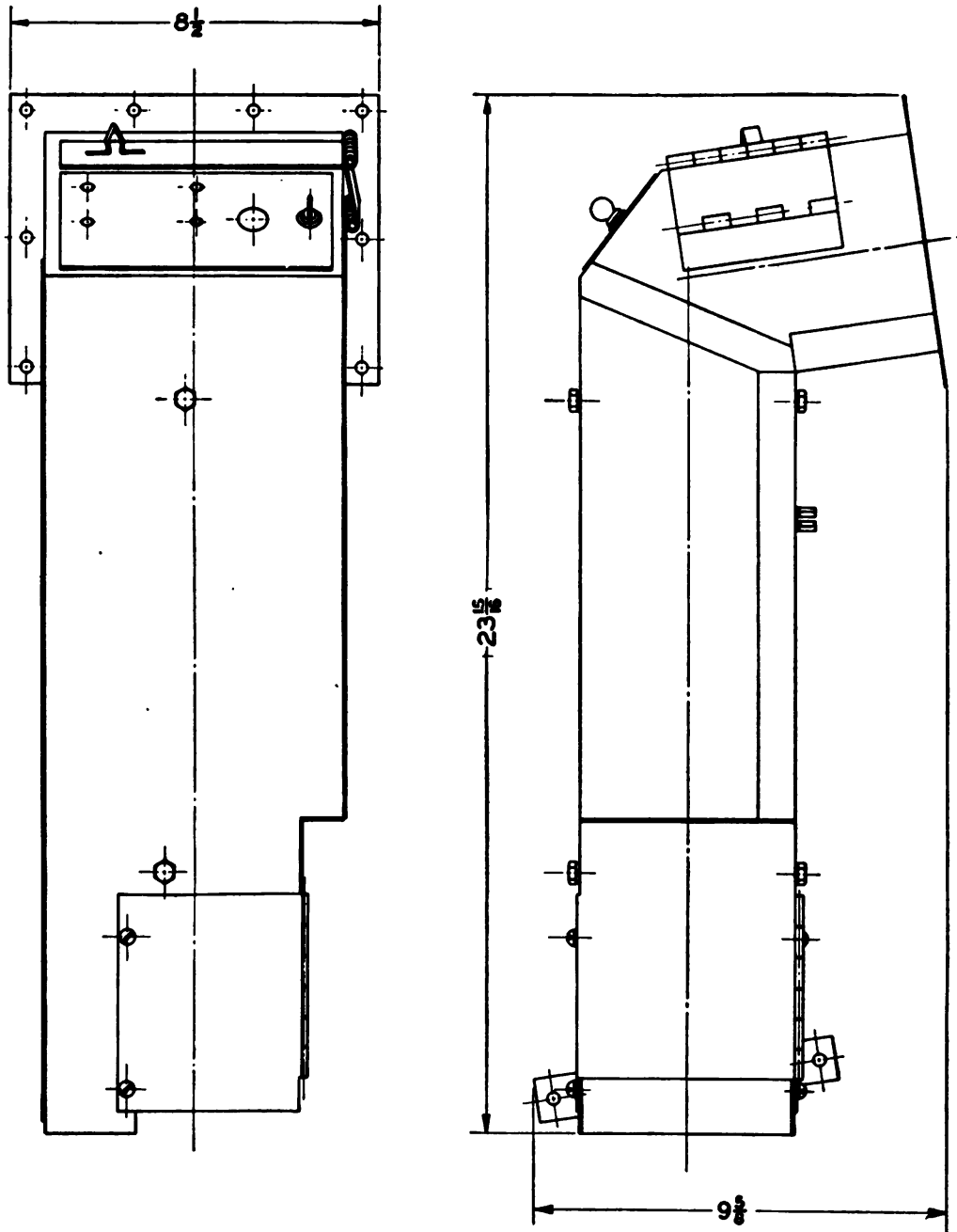

FIGURE 24.—Dimensional sketch of auxiliary generator duct.



SECTION VI  
PARTS LIST

Generator parts.....	<i>Paragraph</i> 18
Control box parts and connections.....	19
Engine parts.....	20
Duct parts.....	21
Special tools.....	22
Standard screws, bolts, nuts (cadmium plated unless otherwise noted), and washers.....	23

18. Generator parts (fig. 25).

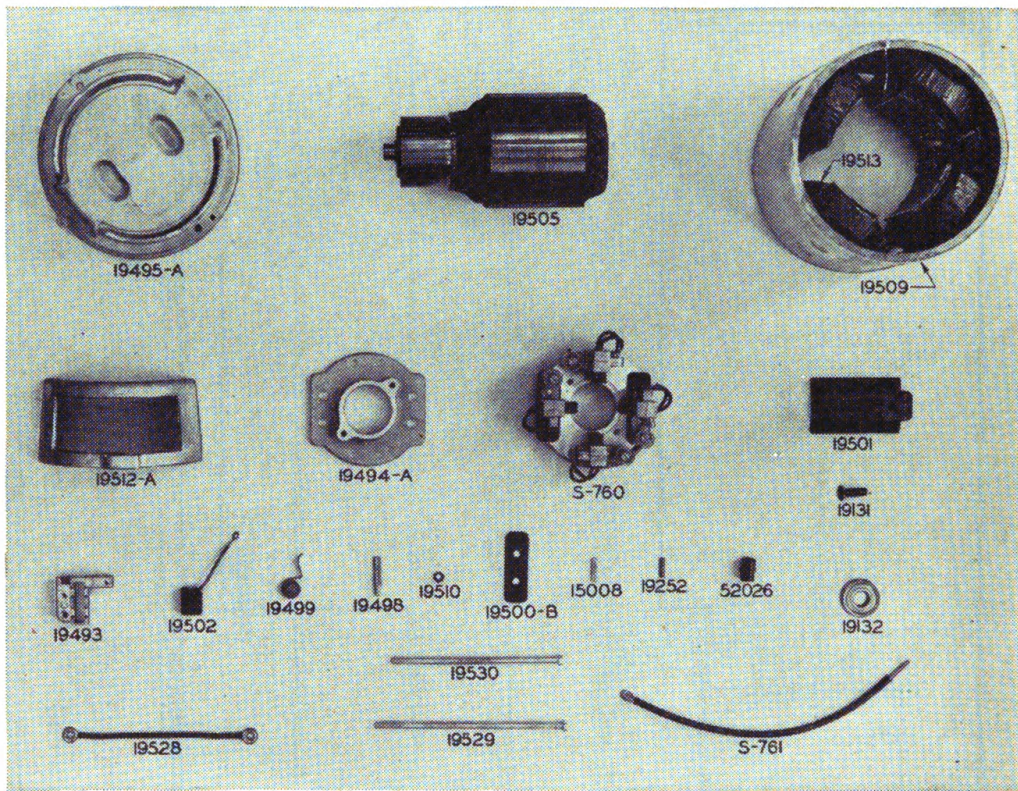

FIGURE 25.—Generator parts.

<i>Part No.</i>	<i>Name</i>	<i>No. per unit</i>	<i>List price each</i>
S-760.....	Holder, brush assembly, with brushes.....	1	\$8. 00
S-761.....	Lead, positive brush.....	1	. 20
15008.....	Key, armature.....	1	. 10
19131.....	Screw, pole shoe.....	8	. 10
19132.....	Bearing, generator.....	1	2. 10
19252.....	Pin, locating.....	2	. 05
19493.....	Holder, brush.....	4	. 60
19494-A.....	Ring, brush holder.....	1	. 90
19495-A.....	Head, brush.....	1	6. 00

AUXILIARY GENERATOR FOR MEDIUM TANK M3 18-19

Part No.	Name	No. per unit	List price each
19498	Post, brush spring	4	\$0. 15
19499	Spring, brush	8	. 20
19500-B	Insulator, brush holder	4	. 15
19501	Shoe, pole	4	4. 50
19502	Brush	8	. 75
19505	Armature, with shaft	1	46. 00
19509	Yoke	1	8. 00
19510	Tube, brush head insulating	4	. 05
19512-A	Plate, cover, brush head	2	1. 00
19513	Coil, field	4	5. 50
19528	Jumper, positive brush	1	. 20
19529	Bolt, armature	1	. 10
19530	Bolt, brush head	4	. 10
52026	Bushing, insulating	1	. 15

19. Control box parts and connections (fig. 26).

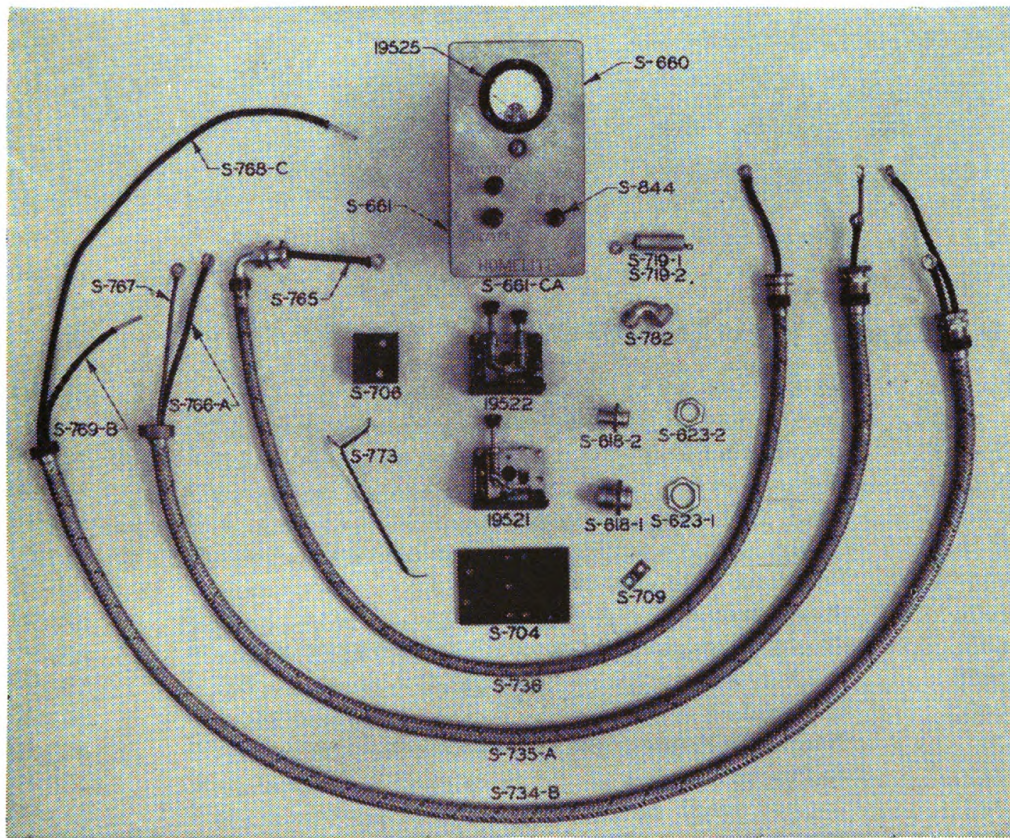

FIGURE 26.—Control box parts and connections.

Part No.	Name	No. per unit	List price each
S-618-1	Connection, 1/2", bulkhead	2	\$0. 60
S-618-2	Connection, 3/8", bulkhead	2	. 55
S-623-1	Locknut, 1/2"	2	. 20

Part No.	Name	No. per unit	List price each
S-623-2	Locknut, 3/8"	2	\$0. 15
S-660	Cover, control box	1	1. 50
S-661	Box, control	1	4. 25
S-661-CA	Box, control, assembly	1	25. 00
S-704	Panel, control box	1	. 65
S-706	Insulation, control box	1	. 10
S-709	Strip, connecting	1	. 20
S-719-1	Capacitor, .1 mfd	1	. 50
S-719-2	Capacitor, .1 mfd	1	. 50
S-734-B	Conduit assembly, filter, with wires and connections.	1	11. 50
S-735-A	Conduit assembly, control box, with wires and connections.	1	10. 00
S-736	Conduit assembly, heater, with wire and connections.	1	9. 25
S-765	Wire, heater conduit, red, with grommets	1	. 80
S-766-A	Lead, control box, black, with grommets	1	. 80
S-767	Lead, control box, yellow, with grommets	1	. 30
S-768-C	Lead, battery box, red, with grommet	1	. 95
S-769-B	Lead, filter box, black, with grommet	1	. 90
S-773	Jumper, control switch, ground	1	. 30
S-782	Elbow, 3/8" heater element, with nut	1	1. 75
S-844	Button, knurled	3	. 10
19521	Switch, starting	1	4. 00
19522	Switch, heater-battery	1	5. 50
19525	Ammeter	1	7. 50

20. Engine parts (figs. 27 and 28).

OW-222	Gasket, fuel filter	1	. 05
0337	Gasket, carburetor inlet seat	2	. 05
OW-352	Screen, fuel filter	1	. 15
OW-355	Cover, fuel filter	1	. 35
OW-363	Bowl, fuel filter	1	. 15
OW-447	Clamp wire, fuel filter, and thumb wheel	1	. 30
S-611-A	Fuel line, with connections	1	1. 25
S-637	Strap, ground	1	. 35
S-645	Shield, magneto (2 piece) with cable connection	1	6. 00
0676	Gasket, gland	1	. 05
S-740	Elbow, fuel filter	1	. 20
S-741	Nipple, fuel filter inlet	1	. 15
S-742	Baffle, spark plug	1	. 30
S-743	Gasket, spark plug baffle	1	. 02
S-776	Conduit, spark plug shielding, assembly	1	7. 50
0802	Screen, carburetor inlet connection	1	. 10
S-833	Cable, high voltage	1	. 25
01434	Screw, carburetor float cover vent	1	. 35
01794	Cover, carburetor float bowl	1	1. 00

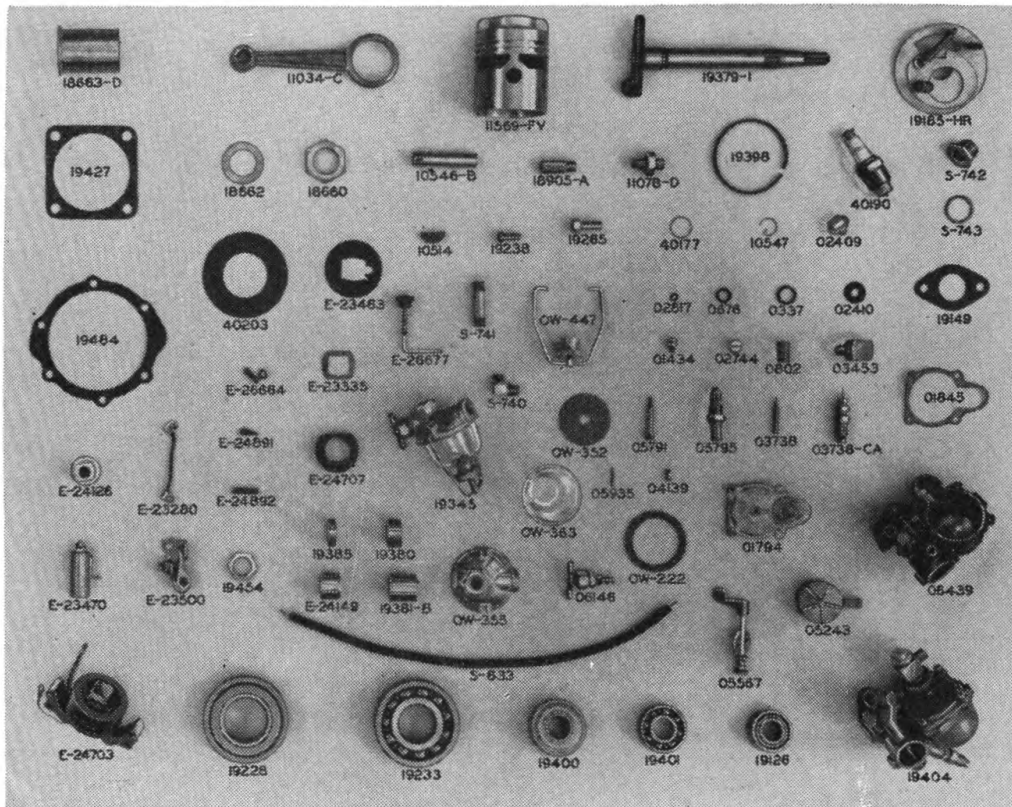

FIGURE 27.—Engine parts.

Part No.	Name	No. per unit	List price each
01845-----	Gasket, carburetor float bowl cover-----	1	\$0. 15
02409-----	Screw, carburetor inlet connection-----	1	. 15
02410-----	Gasket, carburetor inlet connection-----	1	. 05
02744-----	Plug, carburetor pipe, headless-----	1	. 10
02817-----	Gasket, carburetor nozzle-----	1	. 05
03453-----	Connection, carburetor inlet-----	1	. 25
03738-----	Screw, carburetor needle valve adjusting-----	1	. 40
03738-CA--	Screw, carburetor needle valve adjusting, assembly.	1	1. 30
04139-----	Screw, carburetor air bleed restriction-----	1	. 10
05243-----	Float, carburetor-----	1	. 75
05567-----	Shaft, carburetor choke lever, assembly-----	1	1. 25
05791-----	Nozzle, carburetor-----	1	. 35
05795-----	Needle and seat, carburetor inlet, assembly-----	1	1. 40
05935-----	Pin, carburetor float lever-----	1	. 10
06146-----	Cock, fuel filter, shut-off-----	1	. 40
06439-----	Body, carburetor-----	1	4. 75
10514-----	Key, crankshaft-----	2	. 05
10546-B--	Pin, piston-----	1 See 11569-FV	
10547-----	Ring, piston pin retaining-----	2	. 05
11034-C-----	Rod, connecting, with piston pin bearing-----	1	4. 00
11078-D-----	Screw, crankpin-----	1	. 50

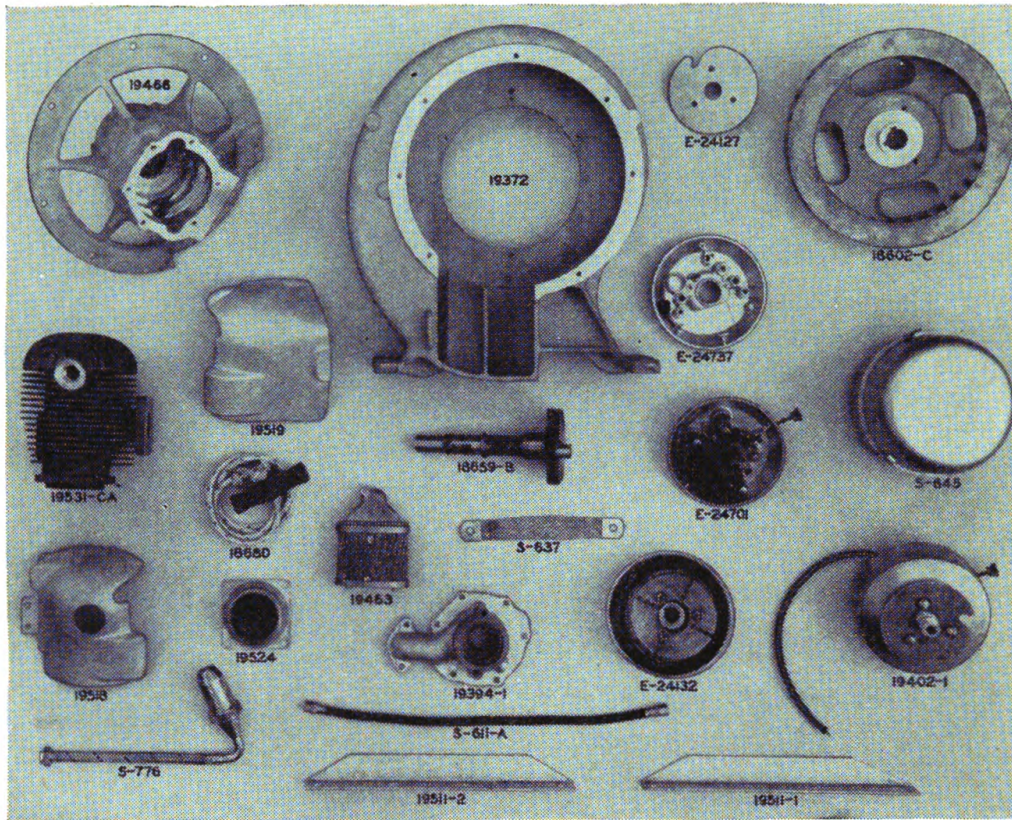

FIGURE 28.—Engine parts.

Part No.	Name	No. per unit	List price each
11569-FV	Piston (assembly with pin 10546-B)	1	\$8. 00
18602-C	Flywheel	1	6. 75
18659-B	Crankshaft	1	15. 00
18660	Locknut, crankshaft	1	. 25
18662	Washer, flywheel	1	. 10
18663-D	Spacer, crankshaft	1	1. 25
18680	Rope, starting, with grip	1	. 25
18905-A	Stud, crankshaft	1	. 20
19126	Bearing, connecting rod ball	1	2. 80
19149	Gasket, carburetor flange	1	. 05
19185-HR	Valve, governor and intake, assembly—handled only as assembly and consists of:	1	12. 50
S-529	Weight clip	1	
15080-C	Intake valve spring	1	
19110-A	Intake valve	1	
19111-A	Weight	1	
19112-B	Pin	1	
19112-C	Pin	2	
19231	Valve driver spring	1	
19232	Spacer	1	
19234	Weight post	1	
19235	Weight bushing	1	

AUXILIARY GENERATOR FOR MEDIUM TANK M3 20

Part No.	Name	No. per unit	List price each
19185-HR	Valve, etc.—Continued.		
19279	Spring	1	
19425	Weight	2	
84000	Washer	3	
19228	Bearing, flywheel	1	\$6. 00
19233	Bearing, main	1	5. 70
19238	Screw, main bearing retaining	2	. 05
19265	Screw, cylinder	4	. 05
19345	Filter, fuel	1	1. 25
19372	Housing, fan	1	31. 50
19379-1	Shaft, intake valve	1	5. 25
19380	Spacer, bearing	1	. 25
19381-B	Spacer, cam	1	. 25
19385	Spacer, timer bracket	1	. 25
19394-1	Bracket, timer	1	12. 75
19398	Ring, piston	2	. 75
19400	Bearing, intake valve shaft, front	1	3. 50
19401	Bearing, intake valve shaft, rear	1	2. 20
19402-1	Magneto	1	16. 00
19404	Carburetor	1	13. 50
19427	Gasket, cylinder	1	. 05
19454	Locknut, cam	1	. 15
19463	Filter, air, with elbow	1	1. 00
19466	Crankcase	1	26. 50
19484	Gasket, timer bracket	1	. 05
19511-1	Support, angle iron—right	1	1. 75
19511-2	Support, angle iron—left	1	1. 75
19518	Shield, cylinder—right	1	1. 25
19519	Shield, cylinder—left	1	1. 00
19524	Mounting, foot	4	1. 25
19531-CA	Cylinder, with liner	1	24. 50
E-23280	Lead, capacitor	1	. 15
E-23335	Washer, coil insulation—top	1	. 10
E-23463	Washer, coil insulation—bottom	1	. 20
E-23470	Capacitor, with mounting bracket	1	1. 00
E-23500	Contact, assembly with points	1	2. 00
E-24126	Nut, rotor puller	1	. 15
E-24127	Plate, starting	1	. 25
E-24129	Cam, breaker	1	1. 00
E-24132	Rotor, with magnet and pole shoes	1	7. 00
E-24701	Stator, assembly	1	8. 50
E-24703	Coil, with laminated core	1	4. 00
E-24707	Washer, stator felt dust	1	. 10
E-24737	Plate stator, with breaker bearing pin	1	1. 50
E-24891	Key, cam	1	. 10
E-24892	Key, rotor drive	1	. 10
E-26664	Wick, oil	1	. 25
E-26677	Switch, ground	1	. 25
40177	Ring, snap, intake valve shaft	1	. 05

Part No.	Name	No. per unit	List price each
40190	Plug, spark, 14 mm, J-10 commercial	1	\$0. 65
40203	Gasket, crankcase sealing	1	. 10

**21. Duct parts (fig. 29).**

S-553-F	Duct assembly	1	14. 50
S-553-1	Duct assembly (Canadian units only)	1	15. 50
S-638	Gasket, duct outlet	1	. 35
S-733-A	Gasket, flexible coupling	2	. 10
S-749	Coupling, flexible	1	6. 00
S-752	Bracket, muffler suspension	2	. 75
S-764	Elbow, muffler outlet, with flange and flexible tubing.	1	2. 25
S-764-1	Elbow, muffler outlet, with flange and flexible tubing.	1	2. 50
S-775	Cover, duct	1	2. 75
S-798	Gasket, muffler outlet	1	. 15
S-836	Plate, heater mounting	1	1. 25
S-845	Frame assembly, electric heater	1	3. 75
19144-2	Muffler	1	10. 00

**22. Special tools (fig. 5).**

1. Puller, shaft	3. 10
2. Fixture, assembling (for crankshaft and flywheel)	2. 90
3. Puller, crankpin bearing	3. 25
4. Remover, flywheel	1. 25
5. Remover, timer bracket bearing	. 65
6. Remover, armature (pins and jack screw)	. 40
7. Tool, armature assembly	. 30
8. Scraper, carbon	. 50

**23. Standard screws, bolts, nuts (cadmium plated unless otherwise noted) and washers.**

(Special items are listed in pars. 18 and 20.)

*a. Screws and bolts.*

Part No.	Description	Where used	Quantity	List price each
Tk-1	6-32 x 3/8" round head	19402-1 Magneto	1	\$0. 05
Tk-2	8-32 x 1/16" round head	{ S-760 Brush holder assembly S-661-CA Control box assembly.	9	. 05
Tk-3	4-36 x 1/2" round head	19525 Ammeter	3	. 05
Tk-4	1/4"-20 x 1/2" round head	{ 19402-1 Magneto S-845 Heater frame	7	. 05
Tk-5	1/4"-20 x 1 1/2" round head	S-661-CA Control box assembly.	7	. 05
Tk-6	6-32 x 3/16" filister head	19404 Carburetor	1	. 05
Tk-7	8-32 x 1/2" filister head	19404 Carburetor	4	. 05
Tk-8	8-32 x 1 1/4" filister head	19463 Air filter with elbow	2	. 05
Tk-9	8-32 x 2 3/4" filister head	19463 Air filter with elbow	2	. 05

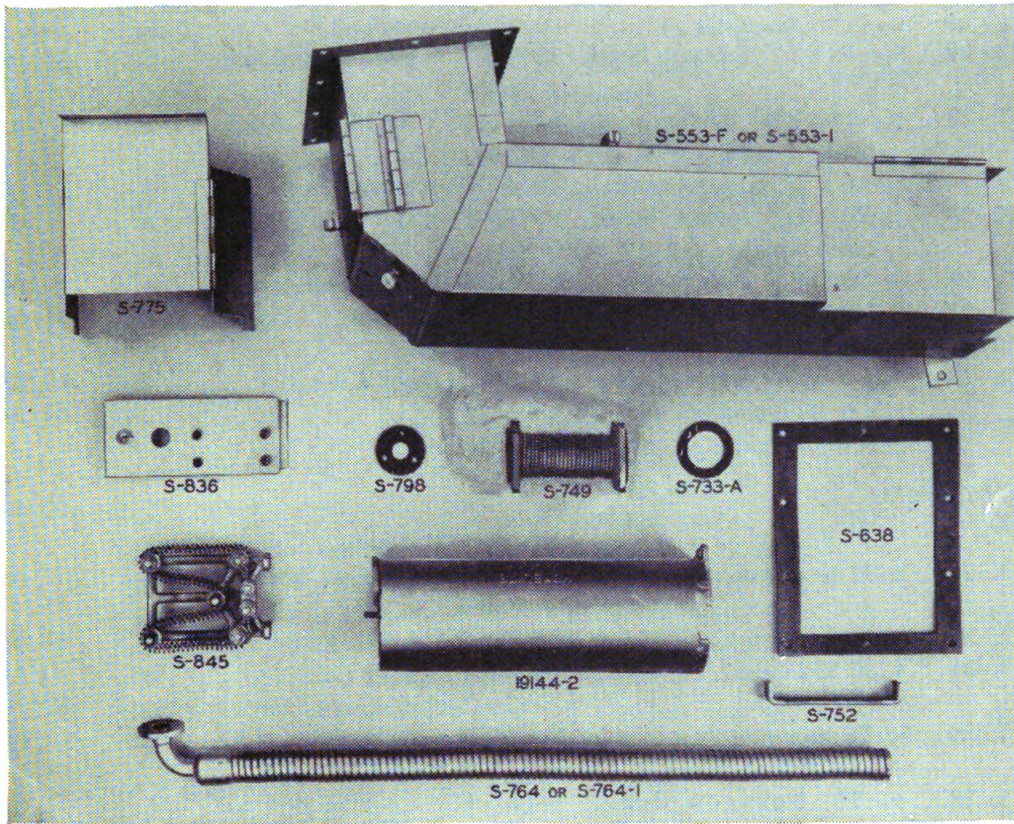

FIGURE 29.—Duct parts.

Part No.	Description	Where used	Quantity	List price each
Tk-10..	10-32 x 1/2" filister head..	{ 19402-1 Magneto..... S-764 Muffler flange..... }	4	\$0. 05
Tk-11..	10-32 x 1" filister head..	19402-1 Magneto.....	2	. 05
Tk-12..	1/4-20 x 1/2" filister head..	{ S-661-CA Control box as- sembly. S-760 Brush holder assembly S-752 Muffler bracket..... }	7	. 05
Tk-13..	1/4-20 x 5/8" filister head..	{ 19518 Cylinder shield..... 19466 Crankcase..... S-845 Heater frame..... }	9	. 05
Tk-14..	1/4-20 x 3/4" filister head..	{ 19519 Cylinder shield..... S-760 Brush holder assembly }	3	. 05
Tk-15..	1/4-20 x 7/8" filister head..	{ S-760 Brush holder assembly 19404 Carburetor..... }	4	. 05
Tk-16..	1/4-20 x 1" filister head....	19495-A Brush head.....	4	. 05
Tk-17..	1/4-20 x 1 1/4" filister head..	19402-1 Magneto.....	2	. 05
Tk-18..	1/4-20 x 1 1/2" filister head..	S-845 Heater frame.....	2	. 05
Tk-19..	1/4-20 x 2" filister head...	S-660 Control box cover....	1	. 05
Tk-20..	1/4-20 x 1/2" hexagon head..	S-752 Muffler bracket.....	4	. 05
Tk-21..	1/4-20 x 5/8" hexagon head slotted.	19394 Timer bracket.....	6	. 05



Part No.	Description	Where used	Quantity	List price each
Tk-22	$\frac{5}{16}$ -18 x 1" hexagon head	19511-1, 19511-2 irons.	3	\$0.05
Tk-23	$\frac{5}{16}$ -18 x 1 $\frac{1}{4}$ " hexagon head.	19511-1, 19511-2 irons.	1	.05
Tk-24	$\frac{3}{8}$ -16 x 2" square head	19524 Foot mounting	4	.05
Tk-25	$\frac{1}{4}$ -20 x $\frac{3}{4}$ " socket head, plain finish.	S-749 Flexible coupling	8	.05
Tk-26	$\frac{1}{4}$ -20 x $\frac{3}{4}$ " wing screw	S-553-F Duct assembly	1	.05
Tk-27	8-32 x $\frac{5}{16}$ " set screw, plain finish.	S-760 Brush holder assembly.	4	.05
Tk-28	No. 8 x $\frac{1}{2}$ " type A Parker-Kalon sheet metal round head.	S-553-F Duct assembly	4	.05

b. Nuts.

Tk-29	8-32 hexagon	{ 19402-1 Magneto S-661-CA Control box assembly	3	.05
Tk-30	$\frac{1}{4}$ -32 hexagon	19402-1 Magneto	2	.05
Tk-31	4-36 hexagon	19525 Ammeter	3	.05
Tk-32	$\frac{1}{4}$ -20 hexagon	{ 19404 Carburetor S-845 Heater frame 19144-2 Muffler	13	.05
Tk-33	$\frac{1}{4}$ -20 hexagon nickel plate.	S-661-CA Control box assembly.	15	.05
Tk-34	$\frac{5}{16}$ -18 hexagon	19511-2, 19511-2 irons.	4	.05
Tk-35	$\frac{3}{8}$ -16 square	19524 Foot mounting	4	.05
Tk-36	$\frac{3}{8}$ -16 hexagon	19524 Foot mounting	4	.05
Tk-37	Tinnerman speed No. 636.	S-553-F Duct assembly	4	.05

c. Plain washers.

Tk-38	No. 8	19402-1 Magneto	2	.05
Tk-39	No. 10	19402-1 Magneto	1	.05
Tk-40	$\frac{1}{4}$ "	{ S-845 Heater frame S-760 Brush holder assembly 19495-A Brush head S-661-CA Control box assembly 19529 Armature bolt	42	.05

*d. Lock washers.*

Part No.	Description	Where used	Quantity	List price each
Tk-41	No. 4	19525 Ammeter	3	\$0. 05
Tk-42	No. 8	19404 Carburetor	15	. 05
		19463 Air filter with elbow		
		S-760 Brush holder assembly.		
Tk-43	No. 10	S-661-CA Control box assembly.	6	. 05
		19402-1 Magneto		
Tk-44	3/16"	S-764 Muffler assembly	1	. 05
Tk-45	1/4"	19404 Carburetor	85	. 05
Tk-46	5/16"	On 1/4" screws	10	. 05
		S-752 Muffler bracket		
		19238 Retaining screw		
		19265 Cylinder screw		
Tk-47	3/8"	19511-2, 19511-2 Angle irons.	8	. 05
Tk-48	1/4" external serrated	19524 Foot mounting	9	. 05
Tk-49	No. 8 internal serrated	S-661-CA Control box assembly.	4	. 05

*e. Fiber washers.*

Tk-50	1/4"	S-553-F Duct assembly	2	. 05
		S-660 Control box cover		

APPENDIX

LIST OF REFERENCES

1. **Standard Nomenclature Lists.**

Tank, medium, M3, parts and equipment----- SNL G-104  
Cleaning and preserving materials----- SNL K-1

Current Standard Nomenclature Lists are as tabulated here.

An up-to-date list of SNY's is maintained as the "Ordnance Publications for Supply Index" (OPSI).

2. **Technical Manuals.**

Medium tank M3----- TM 9-750  
Cleaning and preserving materials----- TM 9-850

[A. G. 062.11 (8-4-41).]

BY ORDER OF THE SECRETARY OF WAR:

G. C. MARSHALL,  
*Chief of Staff.*

OFFICIAL:

J. A. ULIO,  
*Major General,*  
*The Adjutant General.*

DISTRIBUTION:

D 7 (2), 17 (5); I Bn 9 (2); IC 9 (4)  
(For explanation of symbols see FM 21-6.)

