

TECHNICAL MANUAL

OPERATOR'S AND ORGANIZATIONAL MAINTENANCE MANUAL

**INTERCOMMUNICATION SET
AN/VI C-1(V)
(NSN 5830-00-856-3273)
CONTROL, INTERCOMMUNICATION
SETS C-10456/VRC
(NSN 5830-01-082-0804)
AND C-10680/VRC
AND AMPLIFIER, AUDIO
FREQUENCY AM-7046/VRC**

This publication is required for official use or for administrative or operational purposes only. Distribution is limited to US Government Agencies. Other requests for this document must be referred to Commander, US Army Communications-Electronics Command and Fort Monmouth, ATTN: AMSEL-ME-P, Fort Monmouth, NJ 07703-5007.

Change

HEADQUARTERS
DEPARTMENT OF THE ARMY
Washington, DC, 1 July 1995

No 4

**OPERATOR'S AND UNIT MAINTENANCE MANUAL
INTERCOMMUNICATION SET AN/VIC-1(V)
(NSN 5830-00-856-3273), (EIC: GCW),
AND
CONTROL, INTERCOMMUNICATION SET C-10456/VRC
(NSN 5830-01-082-0804), (EIC: N/A)**

TM 11-5830-340-12, dated 15 January 1986 is changed as follows:

1. Remove old pages and insert new pages as indicated below. New or changed material is indicated by a vertical bar in the margin of the page. Added or revised illustrations are indicated by a vertical bar adjacent to the identification number.

Remove pages

1-1 and 1-2
3-5/(3-6 blank)
4-13 and 4-14
5-5 and 5-6
A-1 and A-2
B-1 through B-5/(B-6 blank)

Insert pages

1-1 and 1-2
3-5/(3-6 blank)
4-13 and 4-14
5-5 and 5-6
A-1 and A-2
B-1 through B-11/(B-12 blank)

2. File this change sheet in the front of the publication for reference purposes.

Distribution authorized to the Department of Defense and DOD contractors only for official use or for administration or operational purposes. This determination was made on 15 April 1989. Other requests for this document will be referred to Commander, US Army Communications-Electronics Command and Fort Monmouth, ATTN: AMSEL-LC-LM-LT, Fort Monmouth, New Jersey 07703-5007.

DESTRUCTION NOTICE - Destroy by any method that will prevent disclosure of contents or reconstruction of the document.

By Order of the Secretary of the Army:

DENNIS J. REINER
General, United States Army
Chief of Staff

Official:



JOEL B. HUDSON

Acting Administrative Assistant to the
Secretary of the Army

00994

DISTRIBUTION:

To be distributed in accordance with DA Form 12-51-E, block 2985 requirements for TM 11-5830-340-12.

Change

No. 3

HEADQUARTERS
DEPARTMENTS OF THE ARMY
Washington, DC, 15 June 1990

OPERATOR'S AND UNIT MAINTENANCE MANUAL
INTERCOMMUNICATION SET AN/VIC-1 (V)
(NSN 5830-00-856-3273),
AND
CONTROL, INTERCOMMUNICATION SET C-10456/VRC
(NSN 5830-01-082-0804)

TM 11-5830-346-12, 15 January 1986, is changed as follows:

1. Title of manual is changed as shown above.
2. Remove old pages and insert new pages as indicated below. New or changed material is indicated by a vertical bar in the margin of the page. Added or revised illustrations are indicated by a vertical bar adjacent to the identification number.

Remove pages

i through iii/(iv blank)
1-1 through 1-6
2-1 and 2-2
2-5 and 2-6
2-9 through 2-12
3-1 through 3-4
4-3 through 4-12
5-3 through 5-6
A-1 and A-2
B-3 through B-5/(B-6 blank)

Insert pages

i through iii/(iv blank)
1-1 through 1-6
2-1 and 2-2
2-5 and 2-6
2-9 through 2-12
3-1 through 3-4
4-3 through 4-11/(4-12 blank)
5-3 through 5-6
A-1 and A-2
B-3 through B-5/(B-6 blank)

2. File this change sheet in front of the publication for reference purposes.

Distribution authorized to the Department of Defense and DOD contractors only for official use or for administration or operational purposes. This determination was made on 15 April 1989. Other requests for this document will be referred to Commander, US Army Communications-Electronics Command and Fort Monmouth, ATTN: AMSEL-LC-ME-P, Fort Monmouth, NJ 07703-5000.

DISTRIBUTION NOTICE --Destroy by any method that will prevent disclosure of contents or reconstruction of the document.

By Order of the Secretary of the Army:

CARL E. VUONO
General, United States Army
Chief of Staff

Official:

WILLIAM J. MEEHAN II
Brigadier General, United States Army
The Adjutant General

DISTRIBUTION:

To be distributed in accordance with DA Form 12-51 operator and unit requirements for AN/VIC-1(V).

Change
No. 2

HEADQUARTERS
DEPARTMENT OF THE ARMY
Washington, DC, 15 December 1988

OPERATOR'S AND ORGANIZATIONAL MAINTENANCE MANUAL
INTERCOMMUNICATION SET AN/VIC-1(V) (NSN 5830-00-856-3273),
CONTROL, INTERCOMMUNICATION SETS C-10456/VRC (NSN 5830-01-082-0804)
AND C-10680/VRC AND AMPLIFIER, AUDIO FREQUENCY AM-7046/VRC

TM 11-5830-340-12, 15 January 1986, is changed as follows:

1. Remove old pages and insert new pages as indicated below. New or changed material is indicated by a vertical bar in the margin of the page. Added or revised illustrations are indicated by a vertical bar adjacent to the identification number.

<i>Remove pages</i>	<i>Insert pages</i>
1-1 and 1-2	1-1 and 1-2
1-5 and 14.	1-5 and 1-6
B-3 and B-4	B-3 and B-4

2. File this change sheet in the front of the publication for reference purposes.

Distribution authorized to the Department of Defense and DOD contractors only for official use or for administration or operational purposes. This determination was made on 31 August 1988. Other requests for this document will be referred to Commander, US Army Communications-Electronics Command and Fort Monmouth, ATTN: AMSEL-LC-ME-P, Fort Monmouth, NJ 07703-5000.

DESTRUCTION NOTICE -- Destroy by any method that will prevent disclosure of contents or reconstruction of the document.

By Order of the Secretary of the Army:

Official:

CARL E. VUONO
General, United States Army
Chief of Staff

R.L. DILWORTH
Brigadier General, United States Army
The Adjutant General

DISTRIBUTION :

To be distributed in accordance with DA Form 12-51 Operator and Unit requirements for AN/VIC-1(V).

Change

HEADQUARTERS
DEPARTMENT OF THE ARMY
Washington, DC, 1 December 1987

No. 1

OPERATOR'S AND ORGANIZATIONAL MAINTENANCE MANUAL
INTERCOMMUNICATION SET AN/VIC-1(V) (NSN 5830-00-856-3273),
CONTROL, INTERCOMMUNICATION SETS C-10456/VRC (NSN 5830-01-082-0804)
AND C-10680/VRC AND AMPLIFIER, AUDIO FREQUENCY AM-7046/VRC

TM 11-5830-340-12, 15 January 1986, is changed as follows:

1. Remove old pages and insert new pages as indicated below. New or changed material is indicated by a vertical bar in the margin of the page. Added or revised illustrations are indicated by a vertical bar adjacent to the identification number.

Remove pages

Insert pages

1-1 through 1-6.	1-1 through 1-6
2-13 and 2-14	2-13 and 2-14
5-5 and 5-6.	5-5 and 5-6
B-3 through B-5/(B-6 blank)	B-3 through B-5/(B-6 blank)

2. File this change sheet in the front of the publication for reference purposes.

Distribution authorized to the Department of Defense and DOD contractors only for official use or for administration or operational purposes. This determination was made on 31 August 1987. Other requests for this document will be referred to Commander, US Army Communications-Electronics Command and Fort Monmouth, ATTN: AMSEL-ME-P, Fort Monmouth, NJ 07703-5000.

DESTRUCTION NOTICE – Destroy by any method that will prevent disclosure of contents or reconstruction of the document.

By Order of the Secretary of the Army:

Official:

CARL E. VUONO
General, United States Army
Chief of Staff

R.L. DILWORTH
Brigadier General, United States Army
The Adjutant General

DISTRIBUTION:

To be distributed in accordance with DA Form 12-51 literature requirements for AN/VIC-I(V).

SAFETY PRECAUTION

REVIEW THE SAFETY IDEAS IN TB 385-4 (SAFETY PRECAUTIONS FOR MAINTENANCE OF ELECTRICAL/ELECTRONIC EQUIPMENT).

When the equipment is operated with covers removed, DO NOT TOUCH exposed connections or components. MAKE CERTAIN you are not grounded when making connections or adjusting components inside the equipment.

If someone is a victim of ELECTRICAL SHOCK, follow the FIVE SAFETY STEPS given in the SAFETY INSTRUCTIONS in the front of this manual.

DO NOT SERVICE OR ADJUST EQUIPMENT ALONE!!!

Do not attempt internal service or adjustment unless another person, capable of giving FIRST AID and RESUSCITATION, is PRESENT.



5

SAFETY STEPS TO FOLLOW IF SOMEONE IS THE VICTIM OF ELECTRICAL SHOCK

1

DO NOT TRY TO PULL OR GRAB THE INDIVIDUAL

2

IF POSSIBLE, TURN OFF THE ELECTRICAL POWER

3

IF YOU CANNOT TURN OFF THE ELECTRICAL POWER, PULL, PUSH OR LIFT THE PERSON TO SAFETY USING A WOODEN POLE OR A ROPE OR SOME OTHER INSULATING MATERIAL

4

SEND FOR HELP AS SOON AS POSSIBLE

5

AFTER THE INJURED PERSON IS FREE OF CONTACT WITH THE SOURCE OF ELECTRICAL SHOCK, MOVE THE PERSON A SHORT DISTANCE AWAY AND IMMEDIATELY START ARTIFICIAL RESUSCITATION

WARNING

Do not be misled by the term “low voltage”. Potentials as low as 50 volts can cause death under adverse conditions. Remove or tape all exposed personal metal objects such as watches, rings or medallions before working on equipment.

WARNING

Adequate ventilation should be provided while using TRICHLOROTRIFLUOROETHANE. Prolonged breathing of vapor should be avoided. The solvent should not be used near heat or open flame; the products of decomposition are toxic and irritating. Since TRICHLOROTRIFLUOROETHANE dissolves natural oils, prolonged contact with skin should be avoided. When necessary, use gloves which the solvent cannot penetrate. If the solvent is taken internally, consult a physician immediately.

WARNING

The vehicle battery can give off explosive gas. Don't smoke and be careful to avoid sparks when working near the battery; otherwise, you may cause an explosion injuring yourself and others.

CAUTION

Throughout this manual, there are cautions that must be observed when doing specific tasks to avoid possible damage to the equipment. Read each caution carefully and adhere to the appropriate safety procedures when doing the work,

CHAPTER 1 INTRODUCTION

Section I. GENERAL

1-1. Scope

a. General. This manual provides operator and organizational maintenance instructions for Intercommunication Set AN/VC-1(V). It also provides instructions for Control, Intercommunication Set C-10456/VRC (used in M1 Tank (Abrams).

b. Official Nomenclature. Official nomenclature followed by (*) indicates all models of the equipment.

c. Common Names. Throughout this manual, the following common names are used to indicate equipment. (See listing below.)

d. Control and Audio Frequency Amplifiers.

(1) AU references to AN/VIC-1(V) and components of AN/WC-1(V) (fig. 1 - 1) apply to the C- 10456/VRC (which is similar in appearance and performance to the C-2298/VRC.

(2) All references to the AM-1780/VRC also apply to the AM-1780A/VRC and AM - 1780B/VRC unless otherwise indicated.

e. Crewmembers are provided with Combat Vehicle Crewmember (CVC) Helmet (fig. 2-8) or Armored Vehicle Crewmember (AVC) Helmet (fig. 2-8) for

use in combat vehicles. In APG, command posts, etc., crewmembers are provided with headset -microphone sets, microphones, and headsets.

f. The AM-1780/VRC can be connected through field wires to a telephone to enable the telephone users to communicate with the crewmembers.

g. Control, Intercommunication Set C-10456/VRC is used in M1 Tank (Abrams) (TM 9-2350-355-10). It is similar to the C-2298/VRC except that it is provided with a remote keying connector, J805/P805 (fig 2-5) to enable certain crewmembers to use the remote keying controls/switches provided in the M1 Tank. Thus, the crewmember can key the radio or intercom using the foot or thumb switch instead of the switch on the crewmember's helmet.

h. Deleted

i. Filter, Dc Power, F-1416/VRC is provided in Howitzer M109, A1, A2 to filter the dc power applied to the driver's control box through vehicle wiring (fig. 4-5 and 4-6).

Item	Common name	Reference
Radio Sets AN/VRC-12 and AN/VRC-43 through AN/VRC-49	AN/VRC- 12 series radios	TM 11-5820-401-10-L TM 11-5820-401-20-2
Receiver - Transmitters, Radio RT-246(*)/VRC and RT-524(*)/VRC (Part of AN/VRC-12 and AN/VRC-43 through AN/VRC-49)	Receiver - transmitters	TM 11-5820-401-10-2, TM 11-5820-401-20-2
Receiver - Transmitters, Radio RT-841/PRC-77 (Part of Radio Sets AN/VRC-64 and AN/GRC-160)	Receiver- transmitter	TM 11-5820-498-12, TM 11-5820-667-12
Intercommunication Set AN/VIC-1(V), with radio	Radio- intercom system	Paragraph 1-8c.
Intercommunication Set AN/VIC-1(V), without radio	Intercom set	Paragraph 1-12
Amplifier, Audio Frequency AM-1780(*)/VRC	AM-1780/VRC	Paragraph 1-11a.
Suppressor, Electrical Transient MX-7778(*)/GRC	Suppressor	Paragraph 1-12
Controls, Intercommunication Set C-2296/VRC, C-2297/VRC, C-2298/VRC	Control box(es)	Paragraph 1-11b.
Microphone, Dynamic M-80/U; Headsets H-140/U and H-251/U; Headset-Microphone H-161/U; Loudspeaker LS-454/U; and CVC Helmet	Audio accessories	Paragraph 6-3
Helmet, Combat Vehicle Crewmember (CVC) DH-132 with Headset-Microphone Kit MK-1039/G installed or Helmet, Armored Vehicle Crewmember (AVC) DH-132A with Headset-Microphone Kit MK-1697/G installed	CVC helmet/AVC helmet	Paragraph 6-3e.
Mountings MT-1029/VRC and MT-1898/VRC	Radio mounts	TM 11-5820-401-10-2, TM 11-5820-401-20-2.

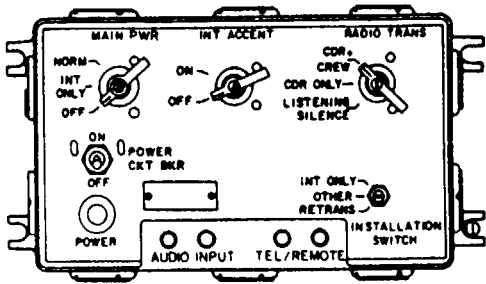

A. AMPLIFIER, AUDIO FREQUENCY, AM-1780(*)/VRC

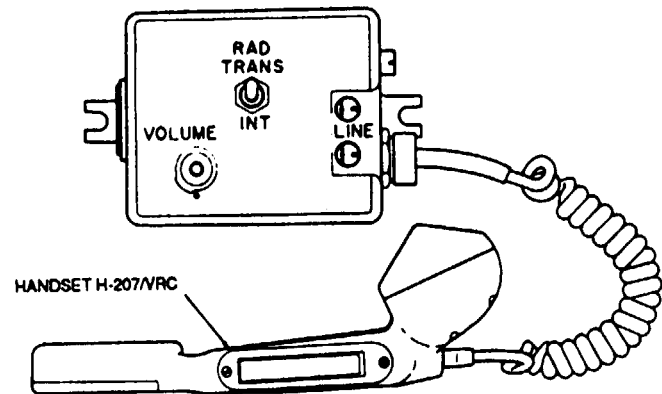

B. CONTROL, INTERCOMMUNICATION SET, C-2296/VRC



F. DUST CAP

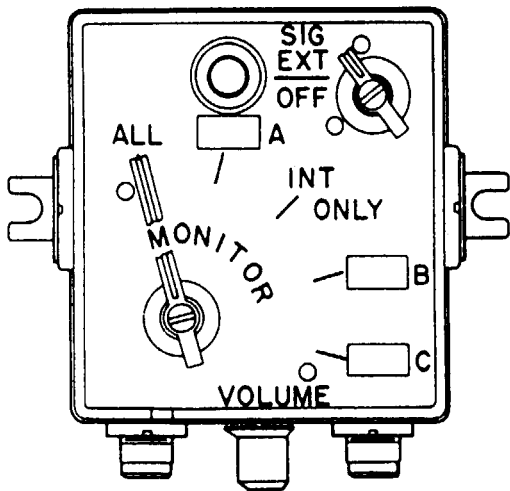

C. CONTROL, INTERCOMMUNICATION SET, C-2297/VRC

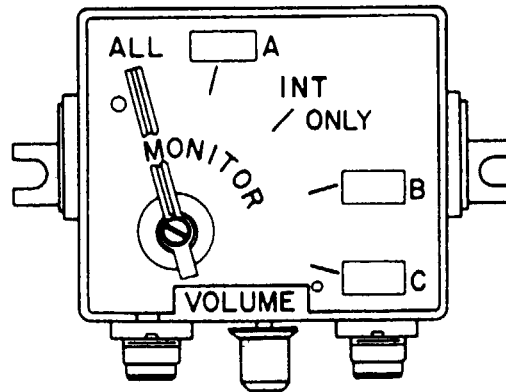

D. CONTROL, INTERCOMMUNICATION SET, C-2298/VRC

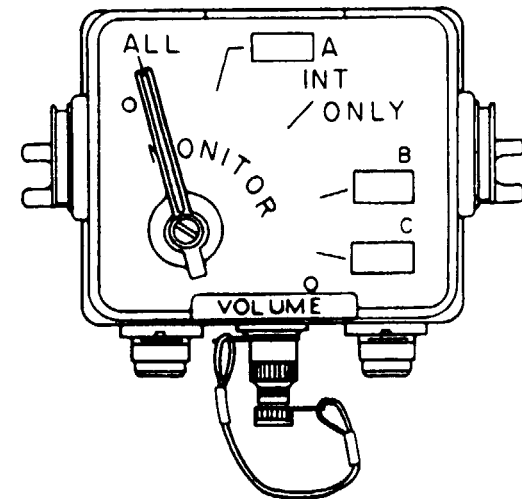

E. CONTROL, INTERCOMMUNICATION SET, C-10456/VRC EL2DT001

Figure 1-1. Intercommunication Set AN/VIC-1(V).

1-2. Maintenance Forms, Records, and Reports

a. Reports of Maintenance and Unsatisfactory Equipment. Department of the Army forms and procedures used for equipment maintenance will be those prescribed by DA Pam 738-750 as contained in Maintenance Management Update.

b. Reporting of Item and Packaging Discrepancies. Fill out and forward SF 364 (Report of Discrepancy (ROD)) as prescribed in AR 735-11-2/DLAR 4140.55/SECNAVINST 4355.18/AFR 400-54/MCO 4430.3J.

c. Transportation Discrepancy Report (TDR) (SF 361). Fill out and forward Transportation Discrepancy Report (TDR) (SF 361) as prescribed in AR 55-38/NAVSUPINST 4610.33 C/AFR 75-18/MCO P4610.19D/DLAR 4500.15.

1-3. Reporting Equipment Improvement Recommendations (EIR)

If your AN/VIC-1(V) Intercommunication Set needs improvement, let us know. Send us an EIR. You, the user, are the only one who can tell us what you don't like about the design. Put it on an SF 368 (Product Quality Deficiency Report. Mail it to Commander, US Army Communications-Electronics Command and Fort Monmouth, ATTN: AMSEL-PA-MA-D, Fort Monmouth, New Jersey 07703-5000. We'll send you a reply.

1-4. Administrative Storage

Administrative storage of equipment issued to and used by Army activities will have preventive main-

tenance performed in accordance with the PMCS charts before storing. When removing the equipment from administrative storage the PMCS should be performed to assure operational readiness. Disassembly and repacking of equipment for shipment or limited storage are covered in the procedures prescribed for the vehicle.

1-5. Destruction of Army Electronics Materiel

Destruction of Army electronics materiel to prevent enemy use shall be in accordance with TM 750-244-2.

1-6. Hand Receipt Manuals

Hand receipt manuals are available covering the radio equipment in tracked vehicles into which the AN/VIC-1(V) is installed. The manuals do not cover the AN/VIC-1(V) without radios. The hand receipt manuals contain preprinted DA Forms 2062 (Hand Receipt/Annex No.) listing the vehicle and the radio-intercom system (AM-1780/VRC and Control Boxes C-2296/VRC, C-2297/VRC, and C-2298/VRC), the radio, cabling, audio equipment installed in the vehicle. Following are hand receipt publications:

a. TM 11-5820-401-10-2-HR - AN/VRC-12 series radios used with intercom.

b. TM 11-5820-498-12-HR - AN/VRC-53, -64, AN/GRC-125, -160 radios used with and without intercom.

1-7. Consolidated Index of Army Publications and Blank Forms

Refer to the latest issue of DA Pam 25-30 to determine whether there are new editions, changes or additional publications pertaining to the equipment.

Section II. DESCRIPTION AND DATA

1-8. Purpose and Use

Intercommunication Set AN/VIC-1(V) provides voice communication between members of crew-served weapon and between crewmembers of a vehicle. The AN/VIC-1(V) also provides crewmembers of the facility to communicate on the radios that may be associated with the AN/VIC-1(V) in the vehicle.

a. The AN/VIC-1(V) is installed without radios in the following vehicles:

(1) Gun, 175 MM, Self-Propelled, M107 and in Howitzer, Heavy, 8-inch, Self-Propelled, M110 (TM 9-2350-216-10).

(2) Howitzer, M105MM, Self-Propelled, M108 and in Howitzer, Medium, 155 MM, Self-Propelled, M109 (TM 9-2350-217-10 (fig. 4-5)).

b. The AN/VIC-1(V) is used with vehicular radios (para 1-11e) in such crewmember combat vehicles as tanks, armored personnel carriers (APC), and armored

command posts (ACP) (fig. 4-9 and 4-10).

(1) In such vehicles as armored personnel carriers, and armored command posts, the AN/VIC-1(V) consists of Amplifier, Audio Frequency AM-1780/VRC and Control, Intercommunication Set C-2298/VRC (fig. 4-4) for each crewmember.

(2) In tanks, except Abrams, the AN/VIC-1(V) also includes Control, Intercommunication Set C-2297/VRC for the driver, and Control, Intercommunication Set C-2296/VRC mounted outside the vehicle (fig. 4-8 and 4-9).

c. The AN/VIC-1(V) is part of the electronic installation harness of howitzers (*a* above) and combat vehicles (*b* above). The harness includes the mounts for the radios, interconnecting cables for the radios and the AN/VIC-1(V) and power cables. Refer to paragraph 1-11 for information on equipment required to make the AN/VIC-1(V) operational.

1-9. Technical Characteristics

a. C-2296/VRC, C-2297/VRC, C-2298/VRC, C-10456/VRC	
Frequency range	500 to 3,000 Hz.
Intercom function	Provides communication between crewmembers.
Radio function	Provides communication on all radios connected to AM-1780/VRC.
Audio accessories:	
Microphone impedance	150 ohms ± 15 percent.
Headset and loudspeaker impedance	150 ohms ± 20 percent.
LINE binding posts of C-2296/VRC	600 ohms ± 20 percent.
Power requirements	22 to 30 volts dc.
b. AM-1780/VRC	
Frequency range	500 to 3,000Hz.
Radio function	Provides control of radios selected by control boxes.
Intercom function	Provides communication (intercom) between control boxes,
Circuit impedances:	
Microphone circuits	150 ohms ± 15 percent.
Headset and loudspeaker circuits	150 ohms ± 20 percent.
LINE binding posts	600 ohms ± 20 percent.
AUDIO INPUT binding posts	5,000 ohms.
Radio transmitter microphone input circuit	150 ohms ± 20 percent.
Radio receiver audio output circuits	150 ohms ± 20 percent.
Power requirements	22 to 30 volts dc.

1-10. Components

The AN/VIC-1(V) includes the AM-1780/VRC and as many control boxes as necessary for the particular vehicle. A maximum of six control boxes may be connected.

NOTE

The C-10456/VRC is not a component of the A.N/VIC-1(V). However, when it is installed in a particular combat vehicle in conjunction with the AM-1780/VRC, the configuration may be considered as an "AN/VIC-1(V)".

Item	NSN	Dimensions (in.)			Qty
		Height	Depth	Width	
Amplifier, Audio Frequency AM-1780/VRC ^a	5820-00-892-3342	3¾	5¾	9/23	1
Control, Intercommunication Set C-2298/VRC ^b	5820-00-892-3339	4½	5¾	3¾	See note b below,
Control, Intercommunication Set C-2297/VRC ^c	5820-00-892-3337	See note c below.
Control, Intercommunication Set C-2296/VRC ^c	5820-00-892-3338	See note c below.
Control, Intercommunication Set C-10456/VRC ^c	5830-00-01-0824	5	3¾	3¾	See note b below.

- a. The components are installed with the required hardware.
- b. One control box is provided each crewmember.
- c. In some vehicles, one C-2297/VRC is provided for the driver's position and one C-2296/VRC is mounted on the outside of the vehicle.

1-11. Description

(fig 1-1)

a. Amplifier, Audio Frequency AM-1780/VRC

(1) The audio frequency amplifiers are the main junction box for the AN/VIC-1(V). They provide control of the dc power to the associated crewmember control boxes (b, c, and d below) and to the radio system that may be connected to the amplifiers. The amplifiers also amplify and control the audio signals in the intercommunication (intercom) and radio circuits,

(2) All operating controls are provided on the front panel. Ten jacks are provided on the top, bottom,

and sides for connections to the control boxes and the radio(s). Two pairs of binding posts are provided on the front panel for connection to a telephone and the audio output of an auxiliary radio. Mounting lugs are provided on the sides. Captive screws hold the gasket-sealed back cover. All controls and jacks are waterproof.

b. Control, Intercommunication Set C-2298/VRC, C-10456/VRC

(1) When an audio accessory is connected to the control box, the crewmember can select, by means of the MONITOR switch and the audio accessory controls, to communicate on the intercom circuit with

other crewmembers, and on the radio(s) connected to the AM-1780/VRC

(2) The MONITOR switch is located on the front panel; the VOLUME control is located on the bottom of the box. A jack on each side of the box provides connection to the AM-1780/VRC (or another C-2298/VRC). Jacks on the bottom provide connection to the audio accessories. Mounting lugs are provided on the sides. Captive screws hold the gasket-sealed back cover.

(3) The C-10456/VRC is installed in combat vehicle, M1 Abrams and in Fighting Vehicle System (FVS) M2 and M3.

c. Control, Intercommunication Set C-2296/VRC.

(1) The C-2296/VRC is provided with Handset H-207/VRC to enable the user to communicate on the intercom circuit with other crewmembers, or on the radio(s) connected to the AM-1780/VRC.

(2) The radio and intercom control switch and VOLUME control are located on the front panel. A jack on the left side provides connection through the vehicle wiring to the C-2297/VRC located inside the vehicle. A jack on the right side provides connection of the cable assembly to an external call light mounted in the cover of the box containing the C-2296/VRC. A pair of binding posts provides connection to a telephone. Mounting lugs are provided on the sides. Captive screws hold the gasket-sealed back cover,

(3) The H-207/VRC has a push-to-talk switch, a dynamic microphone and an earphone, and a retractile cord connected to the C-2296/VRC.

d. Control, Intercommunication Set C-2297/VRC,

(1) When an audio accessory is connected to the C-2297/VRC, the crewmember can elect, by means of the MONITOR switch and the audio accessory controls, to communicate on the intercom circuit with other crewmembers, or on the radios connected to the AM-1780/VRC.

(2) The MONITOR and SIG-EXT-OFF switches are located on the front panel; the VOLUME control is located on the bottom of the box. When the SIG-EXT-OFF switch is in EXT position, the C-2296/VRC (c above) is enabled to become part of the radio and intercom circuits. A jack on the left side provides connection to the AM-1780/VRC; the jack on the right side provides connection through the vehicle wiring to the C-2296/VRC. Jacks on the bottom provide connection to audio accessories. Mounting lugs are provided on the sides. Captive screws hold the gasket-sealed back cover.

1-12. Equipment Required to Make AN/VIC-1 (V) Operational

a. General. Items required to make the AN/VIC-1(V) operational are supplied by various means, depending on the particular vehicle in which it is installed. Dc power (22 to 30 volts dc) is provided by the vehicular electrical system.

(1) Supply Bulletin SB 11-131 lists the parts and National stock numbers of the vehicular electronic installation harnesses and installation kits which contain the AN/VIC-1(V), and the accessory kits required to install the harness.

(2) The electronic installation harness is *part of* tracked vehicles (c below). It includes the AN/VIC-1(V), radio mounts, interconnecting and power cables, mounting brackets for the various components, and the MX-7778(*)/GRC. The MX-7778(*)/GRC includes the Suppressor, MX-7777(*)/GRC and Cable, CX-10613/VRC. The basic radio set components are provided by the using organization.

(3) Accessory kits complement the electronic installation harnesses. They include audio accessories, some interconnecting cables, the whip antenna parts for use with Receiver, Radio R-442(*)/VRC (used in some AN/VRC-12 series radio configurations), and instructions for installing the harness and accessory kit. The accessory kits are a combination of items required for use with a specific type of radio in a specific type of combat (tracked) vehicle. Items are readily installed and do not become a part of the vehicle.

(4) Installation kits contain appropriate audio accessories, radio mounts, interconnecting cables and hardware necessary to mount the AN/VIC-1(V) in the vehicle. The kits are not part of the vehicle; thus, they are removed and used on another vehicle when the vehicle is turned in. Installation instructions for the kits are provided as part of the installation kits per SB 11-131.

(5) A general purpose installation kit is provided for nonvehicular installation. It includes audio accessories, radio mounts, interconnecting cables, power cable, and general purpose mounting hardware. A power supply such as Power Supply PP-2953(*)/U is required to operate the equipment.

b. Wheeled Vehicles. A representative wheeled vehicle in which the AN/VIC-1(V) is used is Truck, Cargo, 1¼-Ton, 6X6, M561. The items required to install the equipment are provided in the installation kit (a(4) above).

c. Tracked Vehicles.

(1) Representative tracked vehicles include: Tank Full Tracked, M60A1; Carriers, Personnel, Armored, M113 and M114; Carrier, Command Post M577; and howitzers (para 1-8a).

(2) The items required for installation and operation of the AN/VIC-1(V) are provided in the electronic installation harness and the accessory kit (a(2) and (3) above) for the particular vehicle.

(3) The audio accessory for some tracked vehicles is contained in the CVC helmets provided for each of the crewmembers.

d. Marine Craft. Generally, installation harnesses in marine craft are considered in the same category as those for tracked vehicles (c above); and once installed, are considered as part of the marine craft.

e. *Compatible Radio Sets.* Following are various vehicular radio sets which may be connected to the AN/VIC-1(V).

(1) AN/VRC-12 series radios (TM 11-5820-401-10-2).

(2) Radio Sets AN/VRC-53, AN/VRC-64, AN/GRC-125, and AN/GRC-160 (TM 11-5820-498-12).

(3) Radio Teletypewriter Set AN/VSC-3 (TM 11-5815-332-15).

f. Typical Configurations. See listing below for typical configurations of the AN/VIC-1 (V).

1-13. Differences in Models

The AM-1780/VRC and the AM-1780A/VRC are provided with rubber-covered binding posts and the designation of TEL/REMOTE is used instead of LINE (fig. 2-1). The AM-1780B/VRC is similar in appearance and performance to the AM-1780AVRC, except for internal configuration.

Type of installation	Typical Equipment Configurations					Remarks	Notes
	AM-1780/VRC	C-2296/VRC	C-2297/VRC	C-2298/VRC	C-10456/VRC		
Gun, Self-propelled, M107 and Howitzer, M110	1			1 per crewman			1
Howitzer, M108 and M109, A1, A2	1			1 per crewman		Filter, Dc Power, F-1461/VRC required for driver's control	1
Armored personnel carriers or armored command posts	1			1 per crewman		C-10456/VRC is similar to C-2298/VRC except remote keying is provided	1
Tanks or marine craft	1	1, outside vehicle	1, driver	1 per crewman			
M1 Abrams and M2 or M3 Fighting Vehicle System	1				1 per crewman	Components are functionally the same as AM-1780/VRC and C-2298/VRC	1
Nonvehicular	1			4		Power supply, such as PP-2953(*)/U required	3
Vehicular, without radio	1			As required		Cargo Truck M561 is a representative vehicle (6 X 6)	2

NOTES:

1. AN/VIC-1(V) is part of harness.
2. Installation kit required.
3. General purpose installation kit.

CHAPTER 2 OPERATING INSTRUCTIONS

Section 1. JACKS, CONTROLS AND INDICATORS

2-1. Amplifier, Audio Frequency AM-1780/VRC Jacks, Controls and Indicator (fig. 2-1)

a. Jacks.

(1) J501 provides power to the AM-1780/VRC when used with radio sets. It also provides for audio and control interface signals of "A" receiver-transmitter. When radios are not used in conjunction with the intercom set, J501 is left vacant and the INSTALLATION SWITCH must be set to INT ONLY.

(2) J503 provides audio signals and control interface signals of "C" receiver-transmitter.

(3) J504 should always be connected to the commander's control box. It provides intercom and radio interface that is independent of all other control boxes.

(4) J505, J506 and J507 are wired in parallel. They are used by other crewmembers, as required, to the intercom and radio interface functions.

(5) J508 provides power to the AM-1780/VRC when radios are not used. It may also provide audio signals from "C" receiver.

(6) J509 and J511 provide for connection of a

C-2299/VRC automatic retransmission (relay) control box used with some radio installations.

(7) J510 provides for connection of audio signals of "B" receiver.

(8) Two pairs of binding posts are provided. One set, labeled AUDIO, allows for connection of an additional receiver. The other is labeled either LINE or TEL/REMOTE and allows connection of a field telephone or switchboard.

b. Controls.

(1) INSTALLATION SWITCH. This is a screwdriver adjustment. In the RETRANS position, radio relay operation is accomplished using the C-2297/VRC provided in some radio installations. The OTHER position is used to provide power and control signals when the intercom set is used with radios. The INT ONLY position allows for dc power application through J508 when radios are not used with the intercom set.

(2) MAIN PWR switch. The OFF position removes dc power. The INT ONLY position applies dc power to the intercom circuits. The NORM position applies dc power to the intercom circuits and radio sets.

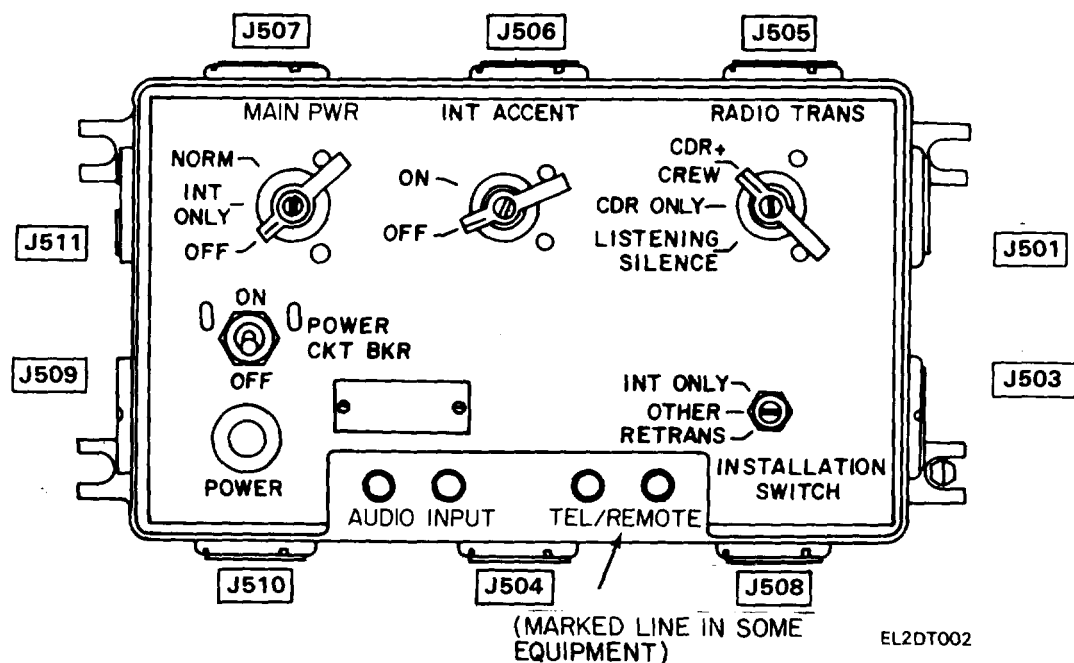

Figure 2-1. AM 1780/VRC jacks, controls, and indicator.

(3) POWER CKT BKR. The circuit breaker provides overload protection for the intercom set and controls the dc power for the intercom and radio sets.

(4) INT ACCENT switch. When set to ON, the audio signals from the radios are reduced, making the intercom sound louder (accented).

(5) RADIO TRANS switch. In the LISTENING SILENCE position, no one can key (transmit on) radios through the intercom set. When CDR ONLY is selected, only the crew commander can key the radios, and in CDR + CREW all crewmembers can key the radios connected to the intercom set.

c. *POWER indicator.* The lamp lights to show that power is applied when the POWER CKT BKR is ON.

2-2. Deleted.

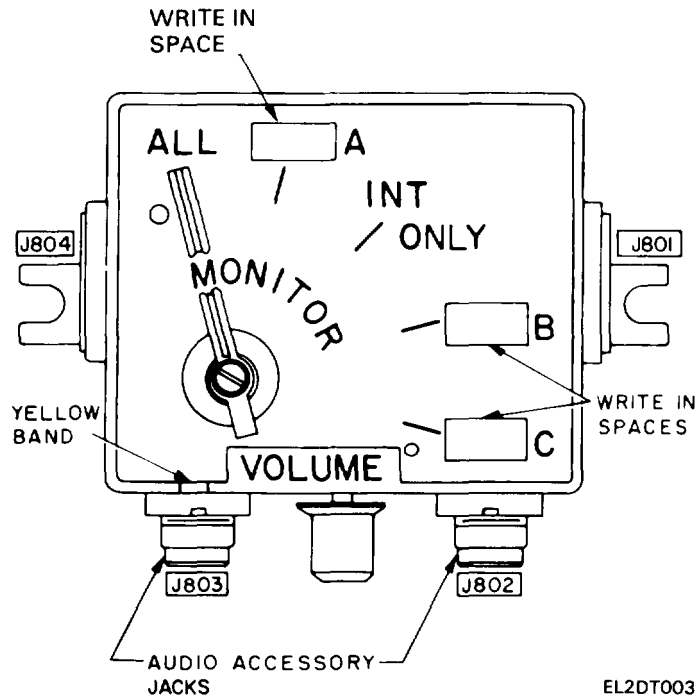

Figure 2-2. C-2298/VRC jacks and control.

2-3. C-2298/VRC Jacks and Controls (fig. 2-2)

a. *Jacks.*

(1) J801 and J804 provide all power and control

signals for the C-2298/VRC. They are wired in parallel so that one may be connected to the AM-1780/VRC and the other connected to another control box (tandem). When connected in tandem the control boxes operate independently.

(2) J802 provides for connection of an audio accessory. This jack is used to talk and listen on either intercom or radios as selected by the MONITOR switch.

(3) J803 provides for connection of audio accessories. When this jack is used, talk and listen on the intercom is available, but the user can only listen to the radios. The MONITOR switch provides selection of the audio signals.

b. Controls.

(1) MONITOR switch. The MONITOR switch selects how the control box is used. In the ALL position, the user can talk and listen on the intercom, talk on the "A" receiver-transmitter, and listen to all items connected to the AM-1780/VRC. In the A position the user can talk and listen on the intercom and "A" receiver-transmitter. In the B position, the user can

talk and listen on the intercom and "A" receiver-transmitter plus listen to the "B" receiver. In the C position, the user can talk and listen on the intercom and "C" receiver-transmitter plus listen to the "C" receiver. In tank type vehicles, the C position may not function due to limited circuits in the vehicle slip ring assembly.

NOTE

Crewmembers (other than commander) cannot talk on radios when the intercom is keyed.

(2) VOLUME control. The VOLUME control adjusts the level of the audio signals applied to the audio accessory jacks.

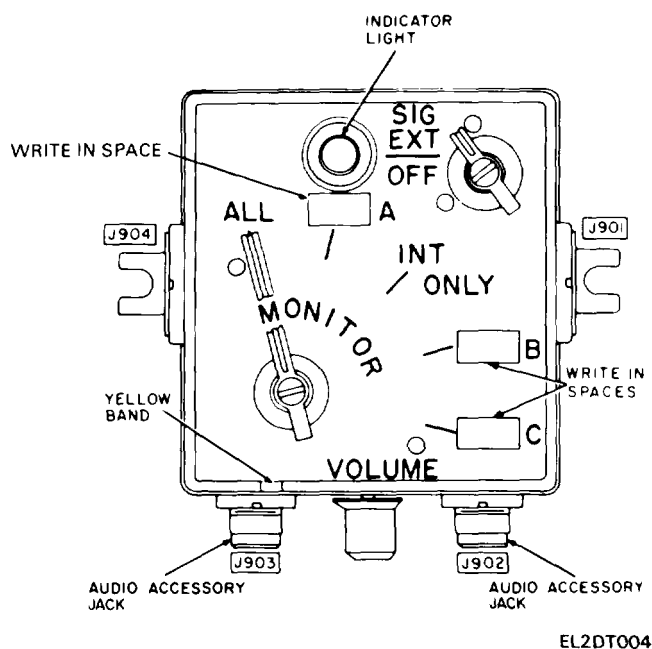

Figure 2-3. C-2297/VRC jacks, controls, and indicator.

2-4. C-2297/VRC Jacks, Controls and indicator (fig. 2-3)

a. Jacks.

(1) J901 provides connection, through vehicle wiring, to a C-2296/VRC outside the vehicle.

(2) J904 provides connection of the C-2297/VRC to the AM-17801VRC for the passage of power and control voltages. This connection is sometimes made through vehicle wiring.

(3) J902 provides for the connection of an audio accessory. This jack is used to talk and listen on either

intercom or radios as selected by the MONITOR switch.

(4) J903 provides for connection of an audio accessory. When this jack is used, talk and listen on the intercom is available, but the user can only listen to the radios. The MONITOR switch provides selection of the audio signals,

b. Controls.

(1) MONITOR switch. The MONITOR switch selects the use of the C-2297/VRC and the C-2296/VRC. In the ALL position, the user can talk

and listen on the intercom, talk on the "A" receiver-transmitter, and listen to all items connected to the AM-1780/VRC. In the A position the user can talk and listen on the intercom and "A" receiver-transmitter. In the B position, the user can talk and listen on the intercom and "A" receiver-transmitter plus listen to the "B" receiver. In the C position, the user can talk and listen on the intercom and "C" receiver-transmitter plus listen to the "C" receiver. In tank type vehicles the C position may not function due to limited circuits in the vehicle slip ring assembly.

NOTE

Crewmembers (other than commander) cannot talk on radios when the intercom is keyed.

(2) **VOLUME** control. The **VOLUME** control adjusts the level of the audio signals applied to the audio accessory jacks.

(3) **SIG-EXT-OFF** switch. The **SIG** position is spring loaded and causes an indicator lamp to light on both the C-2297/VRC and the C-2296/VRC. The **EXT** position connects the C-2296/VRC to the intercom through the C-2297/VRC. The **OFF** position disconnects the C-2296/VRC from the intercom.

c. **Indicator**. The lamp on the C-2297/VRC lights when the **SIG-EXT-OFF** switch is in the **SIG** or **EXT** position, or when C-2296/VRC user presses the push-

to-talk switch and the C-2297/VRC **SIG-EXT-OFF** switch is **OFF**.

2-5. C-2296/VRC, Jacks, Controls, Indicator, and H-207/VRC

(fig. 2-4)

a. **General**. The C-2296/VRC is installed in a waterproof box, outside the vehicle (usually tanks). It comes with an H-207/VRC attached. The C-2296/VRC must be connected to a C-2297/VRC (through vehicle wiring).

b. **Jacks**.

(1) J61 provides connection, in parallel, to the driver's C-2297/VRC through vehicle wiring.

(2) J62 provides connection to the external signal lamp, attached to the waterproof box.

c. **Controls**,

(1) **RAD TRANS-INT** switch. Functions only if C-2297/VRC has **EXT** selected. In the **INT** position the operator will monitor the audio selected by the driver's C-2297/VRC, and may key the intercom. In the spring loaded **RAD TRANS** position, the operator may key the radio (selected by the driver).

(2) **VOLUME** control. Adjusts the loudness of the audio signal heard at the H-207/VRC.

(3) **Key switch**. The key switch on the H-207/VRC is used to key the radio or intercom set. It is also used to flash the light on the driver's C-2297/VRC, if he has selected **OFF** on the **SIG-EXT-OFF** switch, by pressing and releasing the switch.

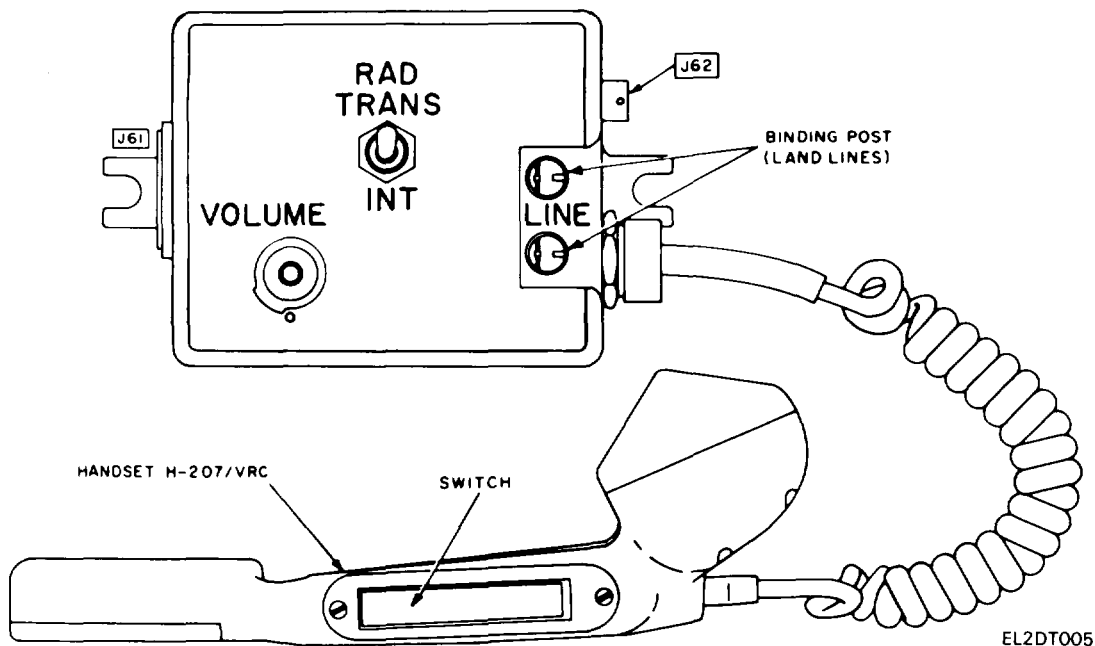

Figure 2-4. C-2296/VRC jacks, controls, and H-207/VRC.

2-6. C-10456VRC Jacks and Controls

(fig. 2-5)

a. *General.* The C-10456/VRC is a modified C-2298/VRC designed for use in the Abrams M1 Tank. It functions the same as the C-2298/VRC except it allows remote keying of the intercom or radio through a remote keying jack, J805. The remote keying jack, J805, is normally connected to the special keying cables in the Abrams M1 Tank. This disconnects the push-to-talk/release-to-listen function on the crewmembers audio accessory and enables special keying controls in the tank. When the dummy plug, P805, is connected to J805, the C-10456/VRC functions the same as, and is interchangeable with, the C-2298/VRC.

b. The C-10456/VRC is used only with an AM-1780/VRC.

2-7. Deleted.

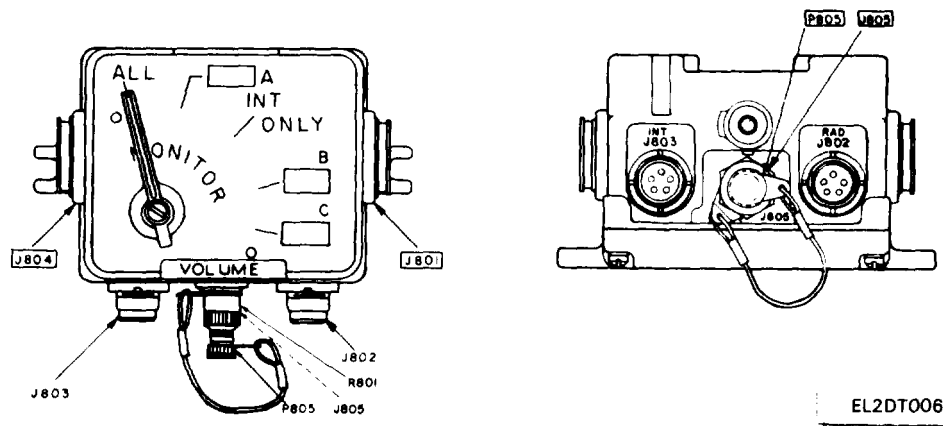

Figure 2-5. C-10456/VRC jacks and controls,

Section II. OPERATING PROCEDURES

2-8. Connections and Use of Audio Accessories

a. *General.* Typical audio accessories used with the AN/VIC-1(V) and associated radios include a microphone (such as Microphone, Dynamic M-80/U; (fig. 2-6)), handsets (such as Handset H-189/GR or H-250/U), headsets (such as Headsets H-140A/U and H-250/U), headset-microphone (such as Headset-Microphone H-161/U), DH-132A helmet (fig. 2-9) in which an audio accessory similar to the H-161/U is installed, and a loudspeaker (such as Loudspeaker LS-454/U), with which Cable Assembly, Special Purpose, Electrical CX-7867/VRC of various lengths may be used as an extension cord (fig. 2-7). In some AN/VIC-1(V) installations, Cord Assembly, Electrical, Branched CX-8650(*)/GR (fig. 2-6 and 2-8) maybe replaced by a longer retractile cord assembly such as Cord Assembly, Electrical, Branched CX-10766/GR (25-foot extension) or CX-10767/GR (35-foot extension).

The branched cable assembly is provided in some vehicular installations (SB 11-131).

b. *Operating Terms.* The following expressions which are used throughout the operating procedures are defined as follows:

(1) The expression "set the audio accessory switch to RADIO" or "key the radio" means to operate the nonlocking push-to-talk switch of the microphone or handset, or to operate the CVC helmet or headset-microphone switch to the nonlocking RADIO position. While the switch is operated, the user talks with his lips close to the microphone; sidetone of the transmission is usually available. Received radio signals cannot be heard until the switch is released.

(2) The expression "set the audio accessory switch to off" means to release the push-to-talk switch of the microphone or handset, or to operate the DH-132A helmet or headset-microphone switch to center (lock-

ing) position to hear received radio and intercom signals; or to await the reception of radio and intercom signals (standby operation) which can be heard in the center position without any action on the part of the user.

(3) The expression “set the audio accessory switch to INTERCOM” or “key the intercom” means to operate the microphone or handset push-to-talk switch, or to operate the CVC helmet or headset-microphone switch to the locking INTERCOM position. While in this position, the user talks with his lips close to the microphone; the received signals can be heard; sidetone of the transmission usually is available.

c. Audio Accessory Connections (fig. 2-10 and 2-11).

(1) Insert the connector of the audio accessory into the audio accessory of the equipment with the flat surface in line with the jack key; push and twist the connector until it locks onto the jack.

(2) To facilitate connection and removal of the connector, put a light coating of insulating compound (para 5-3a(2)) on the O-ring of the connector or dampen the O-ring before inserting it on the equipment jack.

d. Using Microphones and Handsets (fig. 2-10 and 2-11). Typical handset is provided with a dynamic microphone, earphone, and push-to-talk switch. Micro-

phone M-80/U (fig. 2-6) is provided with a microphone and push-to-talk switch. Operation is accomplished by operating the push-to-talk switch and talking into the microphone with the lips close to the transmit element and releasing the switch to hear the reply. To use the microphone or handset, use the following connections as applicable.

(1) To use the receiver-transmitter or R-442 (*)/VRC in the radio system, connect the microphone or handset to the right jack of the control box (RAD).

(2) To use the intercom circuit, connect the microphone or handset to the left jack, identified with a yellow band (INT),

e. Using Loudspeaker and Headsets. The received audio signals are controlled to the desired listening level by adjustment of the equipment VOLUME control.

(1) Attach the LS-454/U and headsets to the equipment jacks as shown in figures 2-10 and 2-11.

(2) Do not connect the LS-454/U or headsets to a C-2299/VRC that is connected to the AM-1780/VRC (fig. 4-8); the received radio signals are not available at the C-2299/VRC connected to the AM-1780/VRC. This restriction does not apply when the C-2299/VRC is connected directly to the radios.

NOTE:

IN SOME INSTALLATIONS, CX-8650/GR MAY BE REPLACED BY RETRACTILE CORD ASSEMBLY CX-10766/GR (25-FT EXTENSION) OR CX-10767/GR (35-FT EXTENSION).

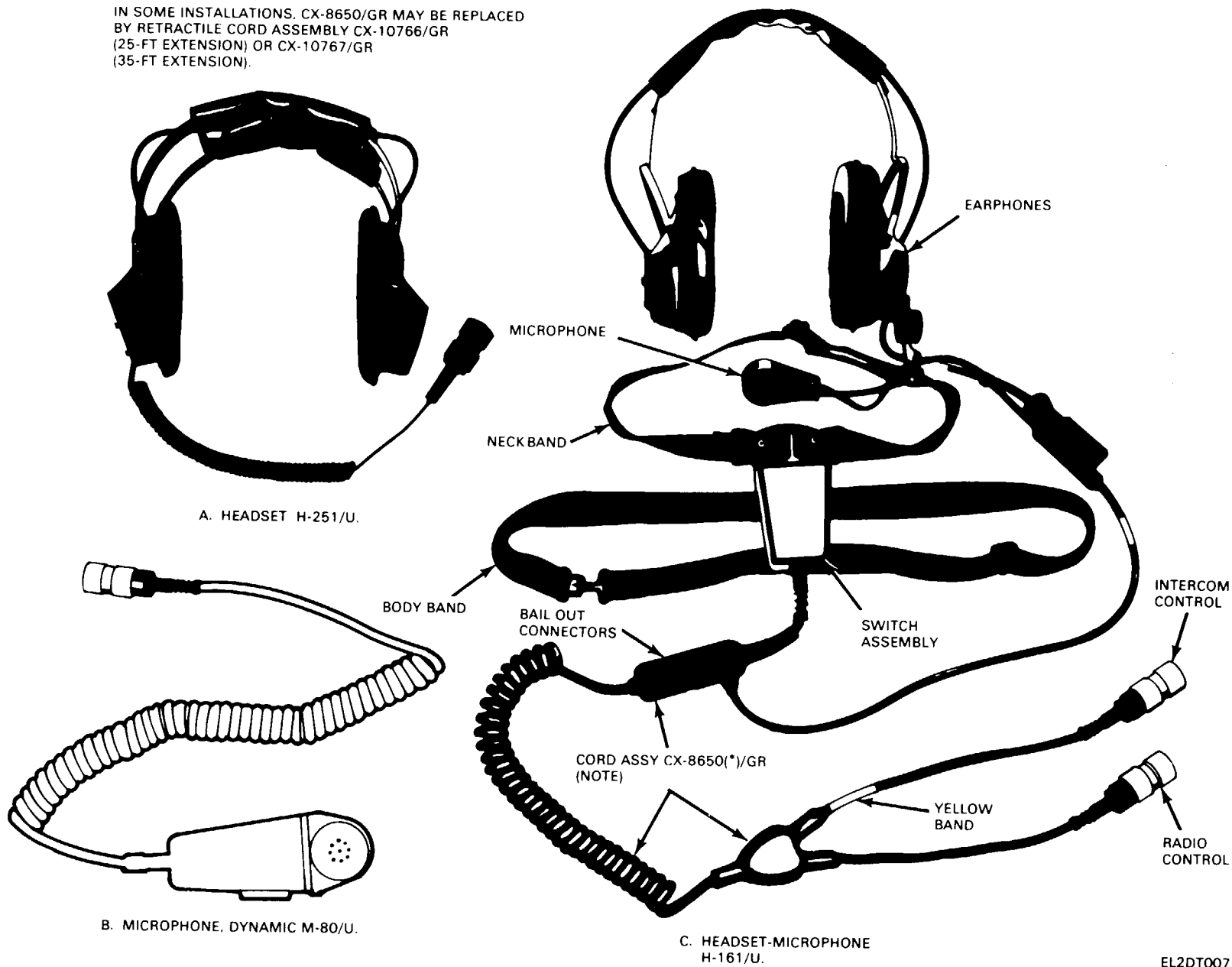

Figure 2-b. Typical microphone, headset, and headset-microphone used with AN/VIC-1(V) control boxes.

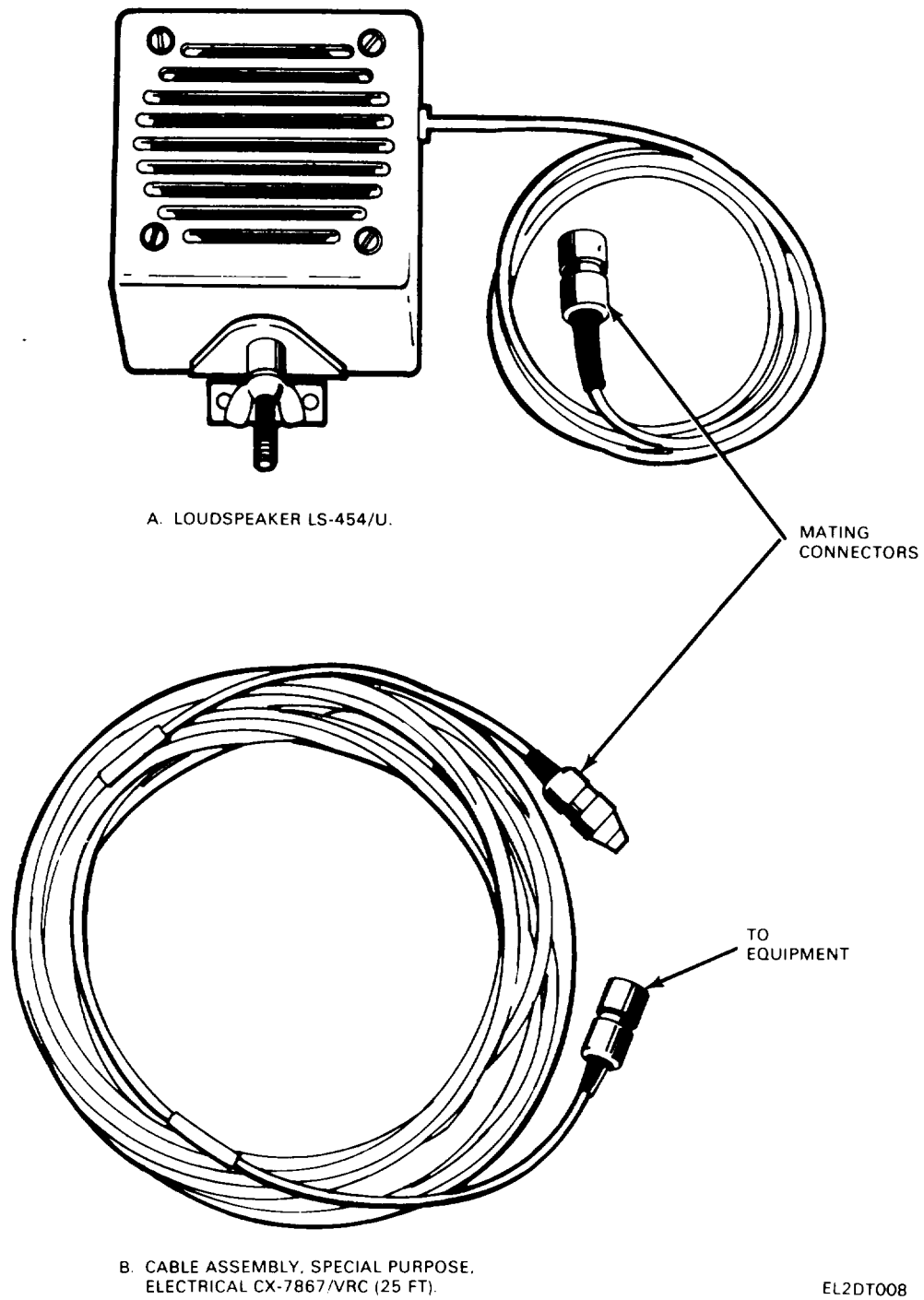
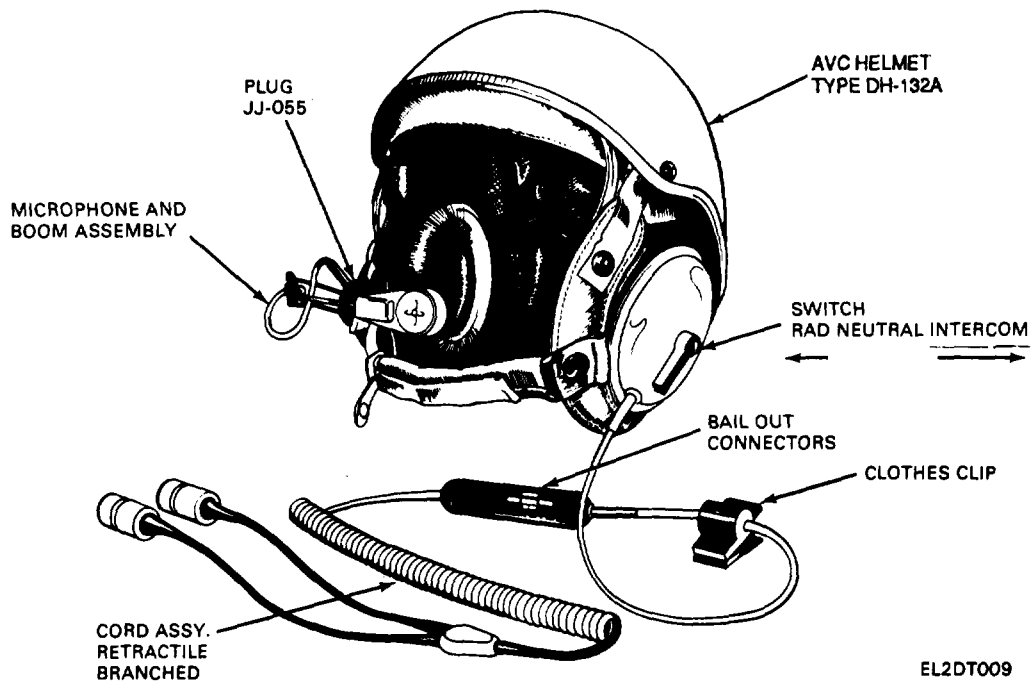

Figure 2-7. Loudspeaker LS-454/U and extension cable CX-7867/VRC.



EL2DT009

Figure 2-8. DH-132A helmet with typical audio accessory installed.

f. Using AVC Helmet and Headset-Microphone.

(1) The switch on these audio accessories has three position, as follows:

(a) The forward, nonlocking position (marked RAD on H-161/U) identified as the "RADIO" position in these operating instructions. The position is used for radio transmission; the transmitter is keyed and sidetone of the transmission is heard.

(b) The rearward, locking position (marked ICS

(intercom system) on the H-161/U) is identified as the "INTERCOM" position in these operating instructions. The position is used for intercom transmission; the intercom is keyed, sidetone of the transmission is heard, and intercom and radio signal can be heard.

(c) The locking, midposition disconnects the keying and microphone functions of the RADIO and INTERCOM position of the switch, and permits radio and intercom signals to be heard,

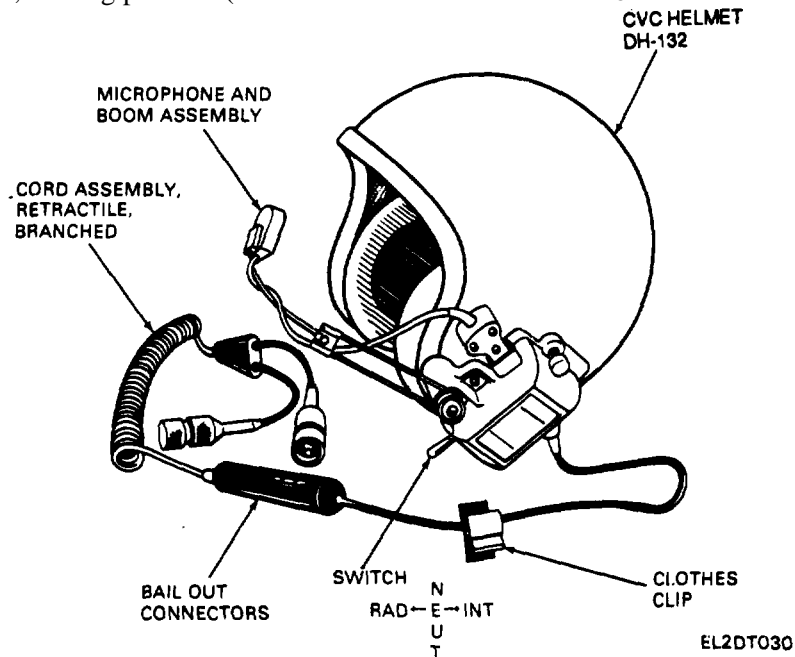

EL2DT030

Figure 2-9. DH-132 helmet with typical audio accessory installed.

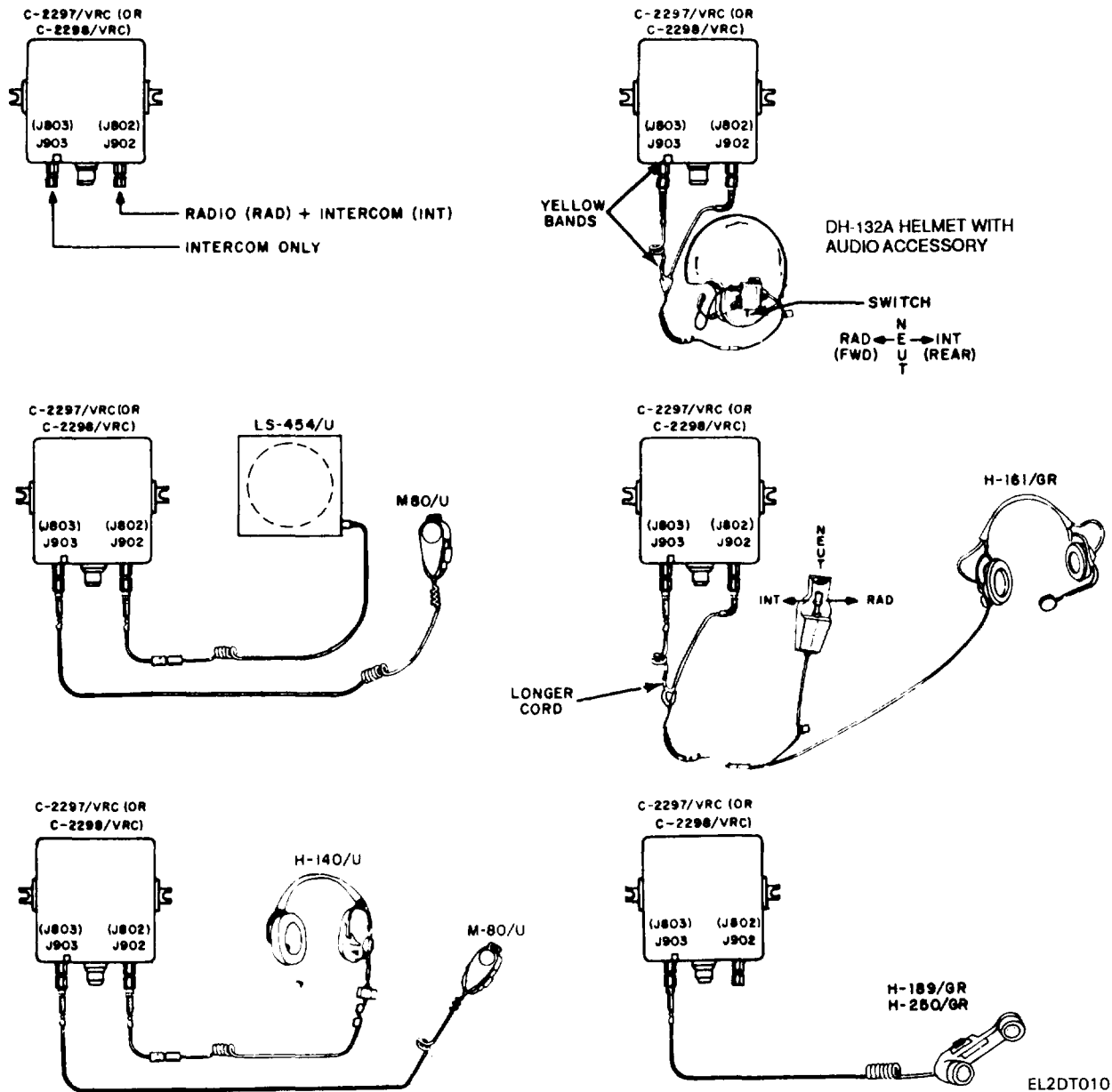

Figure 2-10. Typical connections of audio accessories to control boxes, radios not used.

(2) Of the two audio plugs on the CVC helmet and headset-microphone, one is attached to a longer cord identified with a yellow band. This plug contains the keying control for the intercom circuit. The shorter cord and plug contain the keying control for the radio circuit, and the microphone and earphone circuits for both radio and intercom operation.

(3) On the C-2297/VRC, C-2298/VRC, and C-2299/VRC, attach the audio accessory as shown in figures 2-10 and 2-11. Set the switch as required as explained in (1) above.

CAUTION

Observe the precaution on warning label DA Label 132: WARNING: DO NOT START VEHICLE WHILE RADIO IS ON. This precaution also applies when the AN/VIC-1 (V) is used in the vehicle. The label, attached in an "attention-arresting" location near the vehicle engine ignition switch, is issued in accordance with SB 11-624 (Warning Notice for Vehicles in Which Radios Are Mounted). Spraying or painting the label with clear lacquer or varnish will preserve the label.

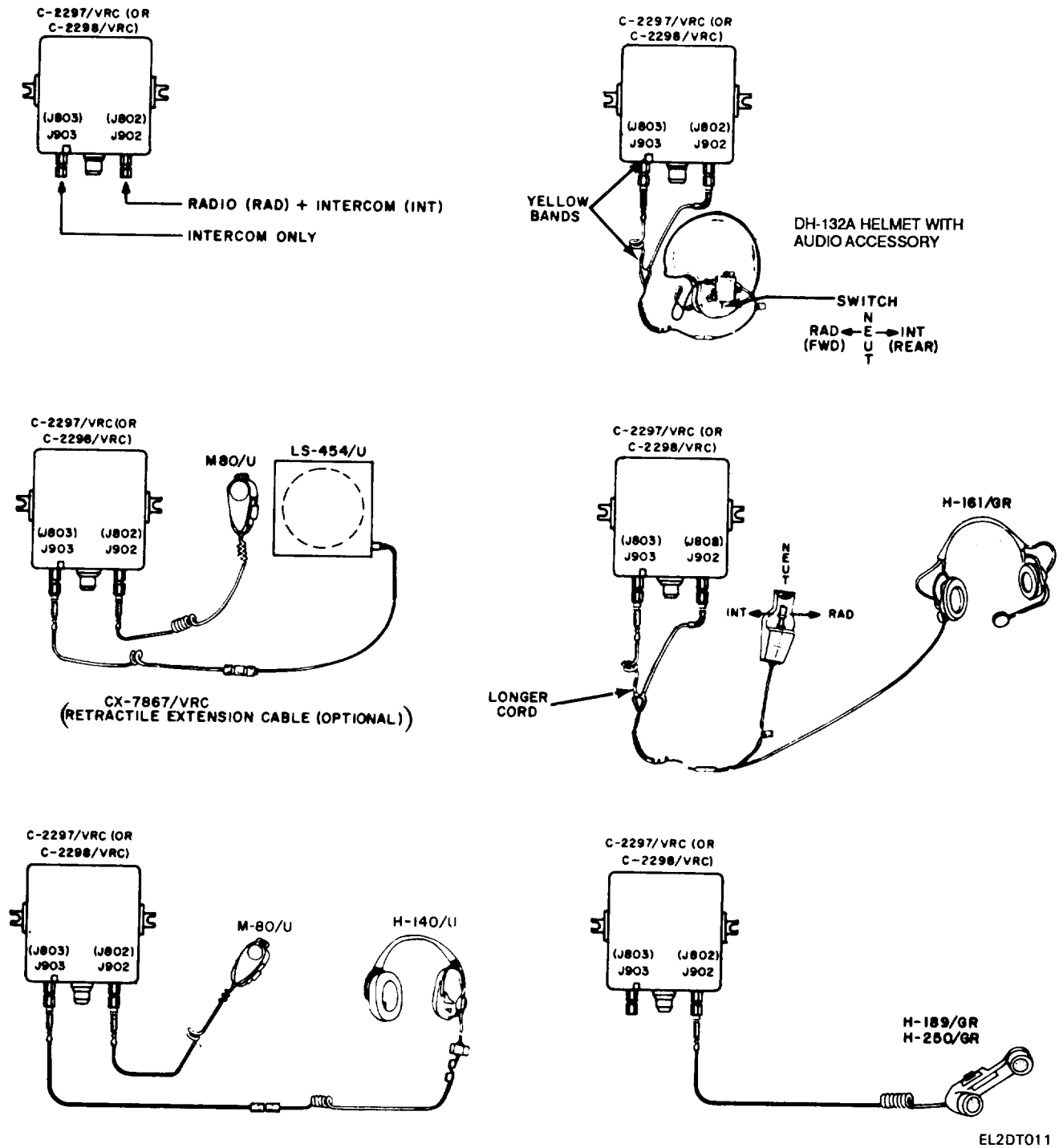

EL2DT011

Figure 2-11. Typical connections of audio accessories to control boxes, with radio set.

g. *Using DH-132A Helmets Connected to C-10456/VRC.*

(1) If the dummy plug, P805, is installed on the remote keying jack of the C-10456/VRC, operation is as described in **f** above for the C-2298/VRC.

(2) If the remote switch in the vehicle is connected to the remote keying jack of the C-10456/VRC, put the switch on the DH-132A helmet in the rearward, locking position (marked ICS). The intercom or radio transmitter can not be keyed with the remote switch which is labeled RADIO/INT or is part of the driver's steering control.

2-9. Operation of AN/VIC-1 (V) for Radio and Intercom Functions

a. *AN/VZC-1(V) Used With Radio Systems.* When radios are used with the AN/VIC-1(V) (fig. 4-7 through 4-10), detailed instructions for radio and intercom operation are provided in the following publications covering the indicated radio sets:

(1) When the AN/VIC-1(V) is used with Radio Sets AN/VRC-12 and AN/VRC-43 through AN/VRC-49, refer to TM 11-5820-401-10-2.

(2) When the AN/VIC-1(V) is used with Radio Sets AN/VRC-53, AN/VRC-64, AN/GRC-125, and AN/GRC-160, refer to TM 11-5820-498-12.

(3) When the AN/VIC-1(V) is used with the AN/VSC-3, refer to TM 11-5815-332-15.

b. *AN/VZC-1(V) Used Alone (Without Radio System)* (fig. 4-4).

(1) General. When one crewmember is keyed for talking on the intercom, all crewmembers hear the transmission, and sidetone is heard by the speaker. When the MONITOR switch of any control box is set to INT ONLY, the intercom circuit will be keyed for communication with other crewmember control boxes. When the user is not talking, vehicle noises are transmitted through the system to other crewmembers if the DH-132A helmet or H-161/HR headset-microphone is connected and in the INTERCOM position. To prevent this, operate the audio accessory switch to INTERCOM only when desiring to communicate with the crewmembers. The noise-cancelling circuit in the audio accessory microphone effectively cancels or reduces the outside noise provided the user speaks with lips close to *the microphone*.

(2) *Starting procedure.* Turn on AM-1780/VRC (fig. 2-1) as follows:

(a) Set INSTALLATION switch to INT ONLY. (The power cable must be connected to J508.)

(b) Set MAIN PWR switch to INT ONLY.

(c) Set POWER CKT BKR switch to ON. The POWER indicator lamp should light. For blackout conditions, rotate the lamp cover one-eighth turn to the left.

(d) If the POWER CKT BKR switch springs back to OFF, an overload is present in the system. To reset the switch when it trips, reset it to ON. If the circuit breaker trips again, do not reset it; troubleshooting is required (para 5-6).

(e) The INT ACCENT and RAD TRANS switches may be set to any position; they do not function in intercom operation.

(3) *Operating the C-2297/VRC and C-2298/VRC* (fig. 2-2 and 2-3). The following operational procedures apply to each C-22971VRC and C-22981VRC in the system.

(a) Set the MONITOR switch to INT ONLY.

(b) To stand by or to listen to calls from other crewmembers, set the audio accessory switch to OFF.

(c) To talk to other crewmembers, set the audio accessory switch to INTERCOM, talk into microphone, sidetone should be heard.

(4) *Operating the C-2296/VRC* (fig. 2-4). When the C-22961VRC is provided, a C-22971VRC is required. The C-22961VRC is mounted in a box on the outside of the vehicle. An external call light, used to attract the attention of personnel outside, is mounted to the box.

(a) Use the following procedures to attract the attention of C-2297/VRC and C-2296/VRC users:

1. To attract the attention of the C-2296/VRC user, operate the C-2297/VRC SIG-E XT-OFF switch to the spring-loaded SIG position a number of times. The external call light at the C-2296/VRC should light each time the switch is operated.

2. To attract the attention of the C-2297/VRC user, operate the push-to-talk switch on the H-207/VRC. The C-2297/VRC indicator light should light.

(b) To establish communication between C-2297/VRC and C-2296/VRC users, proceed as follows:

2. Set C-2297/VRC SIG-EXT-OFF switch to EXT and the MONITOR switch to INT ONLY.

2. Set the audio accessory switch to INTERCOM and talk to the H-207/VRC user.

3. At the C-2296/VRC, press the push-to-talk switch of the H-207/VRC and talk on the intercom to the crewmembers.

4. Under the conditions in **1** and **2** above, other crewmembers can talk on the intercom with the C-2296/VRC user.

(c) When intercom operation from the C-2296/VRC is no longer required, set the C-22971VRC SIG-E XT-OFF switch to OFF. The C-2297/VRC indicator lamp should go out indicating the C-2296/VRC is disconnected.

(d) When the LINE binding posts of the

C-2296/VRC are connected to a field telephone (or the AM-1780/VRC or C-2296/VRC of another vehicle), refer to c below for operating procedures.

(5) C10456/VRC *Operation* (fig. ,2-5). Controls on the C-10456/VRC are identical to those on the C-2298/VRC (fig. 2-2). If no remote switch is connected and the dummy plug is connected, operation is identical to the C-2298/VRC (para (3) above). If a remote switch is connected to the C- 10456/VRC, the following operational procedures apply:

(a.) Set the MONITOR switch to INT ONLY (or, if radio operation, to ALL, A, or B),

(b) Set the switch on the CVC helmet to INTERCOM.

(c) To stand by or listen to calls from other crewmembers, leave the remote switch in the OFF position.

(d) To talk to other crewmembers, push the remote switch to INTER (com) and talk into the microphone, sidetone should be heard. For radio operation, set the remote switch to RAD.

c. *Field Telephone and Intervehicle Operation*, To communicate with a user of field telephone connected to the AM-1780/VRC or C-2296/VRC, or to communicate with crewmembers of another vehicle when the AM-1780/VRC or C-2296/VRC of both vehicles are interconnected, use the following operating procedures. Radio communication cannot be established with this arrangement, except by crew commander.

CAUTION

The ringing signal from a field telephone can damage the circuits in the AM-1780/VRC. Thus, the telephone users must be advised that they cannot use the telephone ringer to attract the attention of vehicle crewmembers. To attract attention, whistle or talk into the telephone.

(1) When the lines are connected to the C-2296/VRC, the C-2297/VRC SIG-EXT-OFF switch must be set to Ext.

(2) Set the MONITOR switch of the control boxes to ALL. Only the crew commander's C-2298/VRC MONITOR switch can be set to position C to communicate on this circuit.

(3) To talk to the other party, set the audio accessory switch to INTERCOM and talk; release the switch to hear the reply. The communication must be conducted on a push-to-talk, release-to-receive basis.

NOTE

If any other crewmember in the vehicle is keyed on intercom, the reply cannot be heard.

d. Stopping Procedures.

(1) To turn off the equipment when radios are associated with the AN/VIC-1 (V), proceed as follows:

(a) On the AM-1780/VRC, set the POWER CKT BKR to OFF.

(b) On the radios, set the POWER switch to OFF.

(c) On the AM-1780/VRC, set the MAIN PWR switch to OFF.

(d) On the MS-7777 (*)/GRC, set the ON-OFF switch to OFF.

(2) To turn off the AN/VIC-1(V) when no radio is associated with it, set the AM-1780/VRC POWER CKT BKR to OFF, the MAIN PWR switch to OFF, then the MS-7777(*) OFF.

2-10. Operational Check Procedures.

a. *Before Mission.* An operational check of the Intercommunications Set AN/VICV-1(V) should be done before starting any mission. These checks are to ensure proper operation of the intercom and should be performed with all assigned crewmembers at their stations.

b. *After Maintenance.* After any operator performed maintenance procedure (para 3-5), the operational check should be performed to ensure the problem was corrected and that no other malfunctions exist.

c. *Procedures.* The procedures below are for the AN/VIC-1(V) installed without radios, such as the M-109 Howitzer (SP). The procedure should be modified to fit the particular installation.

d. *Sidetone.* Each crewmember should hear sidetone of the transmission.

Commander's check	Crewman's response
1. Driver this is commander, intercom check.	1. Commander this is driver, loud and clear.
2. Gunner this is commander, intercom check.	2. Commander this is gunner, loud and clear.
3. (Outside telephone if attached) Outside operator this is tank commander, intercom check.	3. Tank commander this is outside operator, loud and clear.

e. AM-1780/VRC Initial Settings.

- (1) Set the INSTALLATION switch to INT ONLY.
- (2) Set the MAIN PWR switch to INT ONLY.
- (3) Set the PWR CKT BKR switch to ON.
- (4) The INT ACCENT and RAD TRANS switches may be in any position.

f. Audio Accessories. Connect the audio accessories to the crewmember control boxes as shown in figures 2-9 and 2-10.

g. Operational Check. Perform the intercommunications checks in the table below.

h. Installation With Radios. For AN/VIC-1 (V) installations with radios, refer to the appropriate radio TM for the operational check.

NOTE

If intercommunications cannot be established with any crewmember, refer to the operator troubleshooting procedures, paragraph 3-4.

CHAPTER 3 OPERATOR MAINTENANCE INSTRUCTIONS

Section 1. PREVENTIVE MAINTENANCE

3-1. Scope of Operator Maintenance

No special tools or test equipment are required for operator's maintenance. Operator's maintenance of the AN/VIC- 1(V) includes the following:

- a. Preventive maintenance (para 3-2 and 3-3).
- b. Troubleshooting (para 3-4 and 3-5).

3-2. Preventive Maintenance, General

Preventive maintenance is the systematic care, servicing, and inspection of equipment to prevent occurrence of trouble, to reduce downtime, and to assure that the equipment is serviceable. Preventive maintenance checks and services (PMCS) defines the procedures to be performed at specific intervals and under certain conditions (table 3-1).

a. Before you operate, perform your before (B) operation PMCS.

b. While you operate, perform your during (D) operation PMCS, The recording and reporting of your during (D) operation PMCS is done while performing the after (A) PMCS.

c. After you operate, perform you after (A) operation PMCS.

d. If the equipment was not used during the week, perform the (B), (D), and (A) PMCS together with the weekly (W) PMCS.

e. If the equipment fails to operate, try troubleshooting (para 3-4 and 3-5). If the equipment is damaged, report it using the proper forms; see DA Pam 738-7,50 for instructions.

f. The *Item No.* column in table 3- I shall be used as a source of item numbers for the TM number column on DA Form 2404 (Equipment Inspection and Maintenance Worksheet) in recording the results of the PMCS.

g. If the equipment must he kept in constant operation, select those items that can be checked and serviced without disturbing operation. Make the complete checks and services when the equipment can be shut down.

h. Select those items to he inspected and serviced that are authorized for the vehicle installation, For

example, items 1 and 2 are only provided in some vehicle installations.

NOTE

The PMCS procedures in table 3-1 are for AN/VIC-1(V) installed in a vehicle in which no radio is connected to the AN/VIC-1(V) (fig. 4-4). For AN/VIC-1(V) connected to radios, refer to the following publications for operator PMCS for indicated radio configurations.

<i>Radio configuration</i>	<i>Publication</i>
Radio Sets AN/VRC-12, AN/VRC-43 through AN/VRC-49	TM 11-5820 -401-10-2 (tracked vehicles)
Radio Sets AN/VRC-53, -64, AN/GRC-125, -160	TM 11-5820-498-12

i. Routine checks such as the following are not listed in the PMCS (table 3-1):

NOTE

When indicated by visual inspection, perform the following:

- Cleaning (para 3-3).
- Checking for frayed or damaged cables.
- Checking and tightening loose nuts and bolts.

Table 3-1, Operators preventive Maintenance Checks and Services (PMCS)

NOTE

Within designated intervals, these checks are to be performed in the order listed.

B-Before D-During A-After

Item no.	Interval			Item to be inspected	PROCEDURES Check and have repaired or adjusted as necessary	FOR READINESS Reporting Equipment is not ready/available if.
	B	D	A			
1	•			Shell: crewmember helmet	Shell cracked; head assembly torn or separated from shell.	
2	•			Earpieces and internal wiring: audio accessory	Earpieces not secured to shell; ear insulation padding damaged; internal wiring damaged.	
3	•			Switch assembly: audio accessory	Three positions are working (center, locking, and nonlocking.)	
4	•			Dust covers	Install dust covers (fig. 1-1 on unused jack of AM-1780/VRC, and crewmembers control boxes.	
5	•			Equipment operation	Check operation among crewmembers (para 2-9).	Intercom is not able to be conducted among all crewmembers.
6	•			Telephone operation	If installed, check telephone operation (para 2-8c).	

3-3. Cleaning Equipment

The exterior surfaces of the equipment should be clean: that is, there should be no dust, dirt, grease, oil, or fungus on the surfaces.

- a. Remove dust and loose dirt with a clean cloth.

WARNING

Adequate ventilation should be provided while using TRICHLOROTRIFLUOROETHANE. Prolonged breathing of vapor should be avoided. The solvent should not be used near heat or open flame; the products of decomposition are toxic and irritating. Since

TRICHLOROTRIFLUOROETHANE dissolves natural oils, prolonged contact with skin should be avoided. When necessary, use gloves which the solvent cannot penetrate. If the solvent is taken internally, consult a physician immediately.

- b. Remove grease, oil, fungus, and ground-in dirt from equipment with a clean cloth dampened (not wet) with trichlorotrifluoroethane.

- c. If the equipment is washed down using a water hose, do not direct the water directly at the front panels and cable connectors. Wipe the equipment dry after using the water hose.

Section II. OPERATOR TROUBLESHOOTING PROCEDURES

3-4. Troubleshooting by Visual Inspection

a. *Power Failure.* If, during operation of the radio-intercom equipment, the system seems to lose power, make the following checks:

- (1) If the vehicle has a master switch, check to see that it is turned on.
- (2) Check to see that the radio is pushed back fully

on its mount and that the mounting clamps are tightened fully,

- (3) When the CX-4720/VRC power cable is connected to the MX-7778/GRC, check to see that the MX-7778(*)/GRC ON-OFF switch is set to ON, and that the cables connected to the MX-7778(*)/GRC and the radio mount are fully tightened to their jacks.

(4) Check to see that the POWER switch on the radio is turned on. Check to see that the AM-1780/VRC MAIN PWR switch is set to NORM. Also check to see that the AM-1780/VRC INSTALLATION SWITCH is set to OTHER. When the AM-1780/VRC POWER CKT BKR is set to ON, the POWER indicator should light.

b. Radio Communication Failures. For radio equipment failures, refer to TM 11-5820 -401-10-2 for AN/VRC-12 series radios; to TM 11-5820-498-12 for AN/VRC-53, AN/VRC-64, AN/GRC-125, and AN/GRC-160 radios; and to TM 11-5815-332-15 for the radio set in the AN/VSC-3.

c. Failures While Using Radio-Intercom System. When radio or intercom communication failures occur while using audio accessories connected to the control boxes of the radio-intercom system, make the following checks:

(1) Check to see that the audio accessory cable plugs are locked on the control box jacks.

(2) Note that radio communication from all control boxes will be broken if another crewmember keys on the intercom circuit. However, radio communication from the crew commander's control box (always connected to J504 of the AM-1780/VRC) is not interrupted when another crewmember keys on the intercom.

(3) Check to see that the POWER indicator on the AM-1780/VRC is lighted. If not, set POWER CKT BKR switch to ON.

(4) If the C-2297/VRC or C-2298/VRC fails while the turret is being turned, the turret slip rings may be

at fault. To restore communication on a temporary basis until the vehicle slip rings are repaired:

(a) Connect a CX-4723/VRC, of suitable length, between the driver's control box and one of the unused jacks on the AM-1780/VRC. If there is no available jack, connect the cable to the unused jack of a C-2298/VRC in the vehicle. Operation of both control boxes are independent of each other. Run the cable in a convenient manner and tie it at appropriate points to the vehicle.

(b) Or an extension cable, replacing the retractile cable of the CVC helmet or H-161/U may be used. Such extension cables include Cord Assembly, Electrical, Branched CX-10766/GR and Cord, Assembly, Electrical, Branched CX-10767/GR. Connect the extension cable between the driver's audio accessory and a C-2298/VRC in the vehicle.

(5) If the C-2296/VRC is inoperative, check the cabling between the C-2296/VRC and the C-2297/VRC for damage.

(6) For radio failures, see *b* above.

(7) Refer to paragraph 3-5 to troubleshoot the radio-intercom system.

3-5. procedures for Operator to Troubleshoot Radio-Intercom System

a. General. The troubleshooting procedures in *b* below cover the AN/VIC-I(V), the audio accessories, and cabling in the radio-intercom system. Also included are procedures for troubleshooting the C-2299/VRC that may be connected to the AM-1780/VRC (items 7 and 8, *b*, below). When the corrective measures indicated do not clear the trouble, higher maintenance level troubleshooting is required.

b. Troubleshooting Radio-Intercom System

Item no.	Symptom	Probable causes	Corrective measures
1	<p>Unable to communicate on intercom or radio.</p> <p style="text-align: center;">NOTE</p> <p>All references to C-2298/VRC apply also to C-10456/VRC (see para <i>c</i> below for C-10456/VRC troubleshooting.)</p>	<p><i>a.</i> Power is turned off.</p>	<p><i>a.</i> On AM-178/VRC, the POWER indicator should be lighted. If not check the following:</p> <p>(1) On the AM-1780/VRC, open POWER indicator lens; set POWER CKT BKR switch to ON, MAIN PWR switch to NORM, and INSTALLATION SWITCH to OTHER.</p> <p>(2) If POWER indicator is still not lighted, set POWER switch on receiver-transmitter connected to J501 of AM-1780/VRC to LOW or HIGH. The dial lamp in receiver-transmitter should be able to be keyed, and sound should be heard from its receiver. These signs indicate power is available to</p>

Item no.	Symptom	Probable causes	Corrective measures
2	Unable to communicate on intercom or radio from one of the control boxes (other than C-2296/VRC).	<ul style="list-style-type: none"> b. Loose cable connections c. Defective AM-1780/VRC a. Audio accessory defective or connected incorrectly. 	<p>operate the radio and radio-intercom systems.</p> <ul style="list-style-type: none"> (3) If the receiver-transmitter does not exhibit above signs, refer to paragraph 3-4b. b. Tighten cable connections at J501 of AM-1780/VRC and at MT-1029/VRC. c. Higher maintenance level troubleshooting is required. a. Perform the following: <ul style="list-style-type: none"> (1) Substitute the original audio accessory with one known to be good. (2) Connect the original audio accessory to another control box and check it for operation. (3) Refer to paragraph 2-8 instructions on the use of audio accessories.
3	Unable to communicate on any radio from any control box; intercom operation is satisfactory.	<ul style="list-style-type: none"> b. Loose cable connections c. Defective control box or cable a. Some crewmember's audio accessory is keyed on intercom or is defective. b. Audio accessory defective or connected incorrectly. c. MONITOR switch is not set correctly. d. RAD TRANS switch AM-1780/VRC is set to LISTENING SILENCE. 	<ul style="list-style-type: none"> b. Tighten cable connections at the control box cable jack, the vehicle outlets, and the AM-1780/VRC. c. Higher maintenance level troubleshooting is required. a. Perform the following: <ul style="list-style-type: none"> (1) Check other crewmembers' audio accessories to see that one is not set to INTERCOM. (2) Disconnect plugs of the audio accessory of each crewmember, in turn, from the control box. b. Perform corrective measures in item 2a above. c. Set MONITOR switch to ALL or A to communicate on one receiver-transmitter; to C to communicate on second receiver-transmitter; to B to hear signals from one R-442(*)/VRC; and to C to hear signals from second R-442(*)/VRC. d. Set switch to CDR+CREW or CDR ONLY, if authorized, to enable crewmembers or crew commander, respectively, to use receiver-transmitter.
4	Unable to communicate from driver's C2297/VRC or C-2298/VRC; other control boxes operate satisfactorily.	<ul style="list-style-type: none"> e. Defective radio a. Loose cable connections b. Defective vehicle wiring 	<ul style="list-style-type: none"> e. Refer to paragraph 3-4b. a. Perform the following: <ul style="list-style-type: none"> (1) Tighten cable connection at left jack of the control box and at vehicle jack. (2) Tighten cable connection at AM-1780/VRC and at vehicle jack. b. Higher maintenance level troubleshooting required.
5	Unable to communicate from C-2296/VRC (C-2297/VRC is satisfactory).	<ul style="list-style-type: none"> a. Switches are not set properly on C-2297/VRC. b. Loose cable connections 	<ul style="list-style-type: none"> a. Set C-2297/VRC MONITOR switch to some position other than C, and set SIG-E XT-OFF switch to EXT; C-2297/VRC indicator lamp should light. b. Perform the following: <ul style="list-style-type: none"> (1) Tighten at right jack of

Item no	Symptom	Probable causes	Corrective measures
			C-2297/VRC and at vehicle jack. (2) Tighten plug at left jack of C-2296/VRC c. Higher maintenance level troubleshooting required. d. Higher maintenance level troubleshooting required.
6	Receiver-transmitter cannot be keyed by audio accessory.	c. Defective Vehicle wiring. d. Defective C-2296/VRC, H-207/VRC. AM-1780/VRC is set up for retransmission operation.	If authorized, set AM-1780/VRC INSTALLATION switch from RETRANS to OTHER position.
7	Radio signals cannot be heard on audio accessory connected to C-2299/VRC.	Radio reception is not available at C-2299/VRC when it is connected to AM-1780/VRC.	Connect audio accessory to some other control box to hear radio signals (MONITOR switch on position ALL).
8	Communication between individual receiver-transmitter and distant radios can be accomplished, but retransmission through relay site radios and C-2299/VRC cannot be accomplished.	a. Control switch on C-2299/VRC is not set correctly. b. Receiver-transmitter are not set up for squelch operation. c. Loose cable connections. d. Defective C-2299/VRC.	a. Set C-2299/VRC RETRANS switch to ON. The AM-1780/VRC INSTALLATION should also be set to RETRANS to remove control or relay site radios from the crewmembers. b. On each receiver-transmitter, set the SQUELCH switch to ON (OLD ON or NEW ON, as appropriate). c. Tighten cable connections at C-2299/VRC jacks, and at jacks J511 and J509 on the AM-1780/VRC. d. Higher maintenance level troubleshooting is required. (Refer to TM 11-5820-401-20-2).
9	Loud whistling noise is heard.	Water in cable connectors, or in connectors of AM-1780/VRC or crewmember's control boxes	Dry out, clean all cable and equipment connectors.
10	AM-1780B/VRC produces audio squeal in output.	Modification required to replace capacitor A1C3.	General support level maintenance required.
11	AM-1780B/VRC produces cross talk when operated in Multi Radio Installation.	Modification required to add Diodes D24 - D27.	General support level maintenance required.

c. *Troubleshooting C-10456/VRC in Combat Vehicle.* Troubleshooting procedures for C-10456/VRC are the same as those for the AN/VIC-1(V) (b above). To use the procedures in b above, perform the following operations, in turn, at each C-10456/VRC:

- (1) Remove remote keying cable connected to the remote keying jack (fig. 2-5).
- (2) Secure the remote keying dummy plug, P805, to the remote keying jack, J805.
- (3) Operated the system. If the malfunction still

exists, use the procedures outlined in b above.

- (4) If the system operates normally, connect each remote keying cable to the associated control box. Test the system after each remote cable connection is made to the control box. When malfunction reoccurs, remove the last remote keying cable connected, and replace the remote keying dummy plug, P805. If the system operates normally now, the trouble is caused by a defective remote cable or switch. Refer to higher maintenance level for repair or replacement of the cable or the remote switch.

CHAPTER 4 INSTALLATION

Section 1. GENERAL

4-1. Service Upon Receipt of Equipment

When packed for shipment, the components of the AN/VIC-1(V) are packed in a single package (para 1-8a) or are part of the installation kit package (para 1-8c). When required, the cartons are packed in wooden boxes.

a. Unpacking. If provided, open the wooden boxes; remove the contents from the cartons.

b. Checking Equipment,

(1) Inspect the equipment for possible damage. Report damaged equipment on SF 364 (Report of Discrepancy) (para 1-2 b),

(2) Use the packing list to check the contents of the carton.

(3) Report shortages on SF 361 (Discrepancy in Shipment Report) (para 1-2c).

c. Shelter Requirements, The components of the AN/VIC-1(V) are rugged and weatherproof units that can withstand extremes of cold and heat. Accordingly, no particular protective requirements are applicable,

4-2. Nonvehicular Installations

a. When the AN/VIC-1(V) is not used in a vehicle, a general purpose installation kit is available (SB 11-131). It is Installation Kit, Electronic Equipment MK-1453/VIC-1(V). It includes the AM-1780/VRC, four C-2298/VRCs, H-161A/U, interconnecting and power cables, and instructions for installing the equipment.

b. A dc power supply, such as Power Supply PP-2953(*)/U, capable of supplying 22 to 30 volts dc at approximately 1 ampere is required.

Section II. INSTALLATION PROCEDURES

4-3. Installing AN/VI C-1 (V)

a. General.

(1) For wheeled Vehicles (para 1-12a), installation instructions for mounting the AN/VIC-1(V) and the parts of the installation kit are provided in the installation kits.

(2) For tracked vehicles (para 1-12c), the AN/VIC-1(V), and the mounts for the radios, if applicable, are part of the vehicle installation equipment harness (para 1-12a(2)). The prescribed layout and cabling details are provided in the publication covering the vehicle in which the harness is installed. Instructions for installing the accessory kit components (para 1-12a(3)) are provided in the accessory kit.

b. Cabling, Refer to paragraph 4-5 for general cabling instructions.

c. Determining Position of Power Control Link in Radio Mounts, When the AN/VIC-1(V) is used with radio sets in the vehicle (fig. 4-7, 4-8, and 4-9), the position of the power control link in the radio mounts is usually set so that the AM-1780/VRC MAIN PWR switch becomes the main power control for the radio and radio-intercom systems,

(1) When the AN/VIC-1(V) is used with one of the radio sets of the AN/VRC-12 series (para 1-6a; fig. 4-7 and 4-8), the procedures for setting the power control link in the radio mounts is provided in TM 11-5820-401-20-2.

(2) When the AN/VIC-1(V) is used with Radio Sets AN/VRC-53, AN/VRC-64, AN/GRC-125, or AN/GRC-160 (fig. 4-9), the procedures are provided in TM 11-5820-498-12.

4-4. AN/VIC-1(V), General Removal and Replacement procedures

a. Removal. As a general rule, when an item is removed, replace the mounting screws with its lock washers and nut in place in the mounting bracket or screw hole. Retain the cable straps and screws that hold the cables in the same way.

(1) To remove a cable connector, refer to the general instructions in paragraph 4-5.

(2) To remove equipment, loosen the equipment mounting screws and remove the unit from its mounting,

b. Replacement.

(1) Attach the equipment to its assigned mounting bracket. Use the prescribed mounting screws, lock washers, and nuts. Make sure one lock washer is under the head of the screw and another under the nut.

(2) Attach the cable plug to the equipment jack (para 4-5 b).

c. Dust Covers. Install dust covers (fig. 1-1) on unused equipment jacks. This will prevent dirt and moisture from impairing the circuits connected to the jacks.

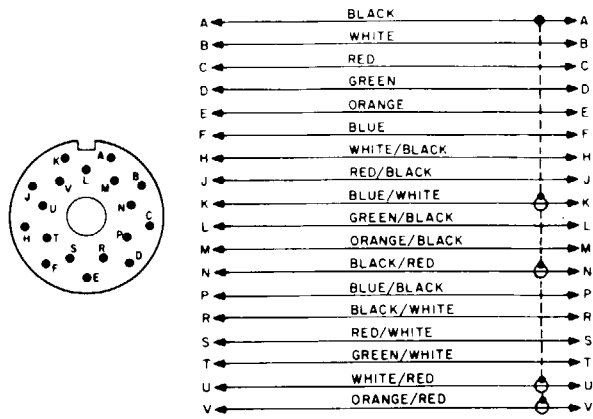

CX-4723/VRC

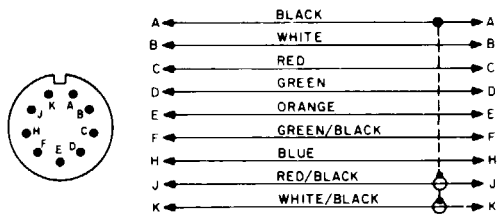

CX-7058/VRC

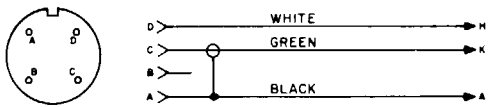

CX-7616/VRC

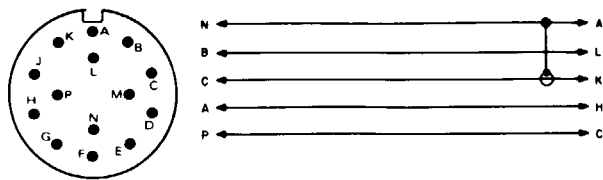

CX-9640/VRC

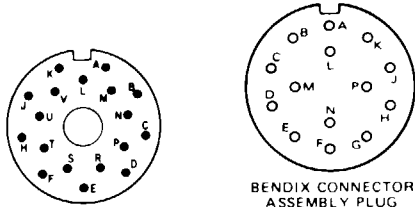

BENDIX CONNECTOR ASSEMBLY PLUG

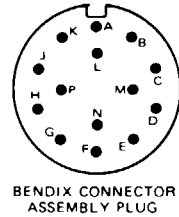

BENDIX CONNECTOR ASSEMBLY PLUG

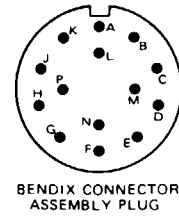

BENDIX CONNECTOR ASSEMBLY PLUG

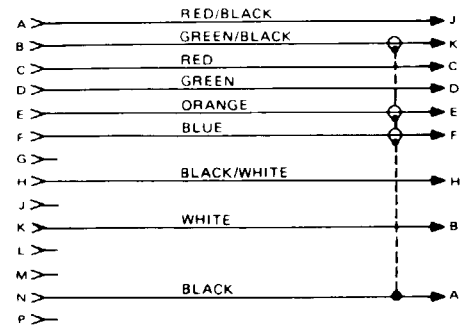

CABLE CX-7057/VRC

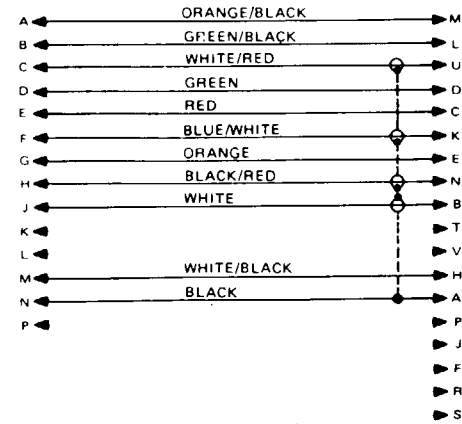

CABLE CX-7060/VRC

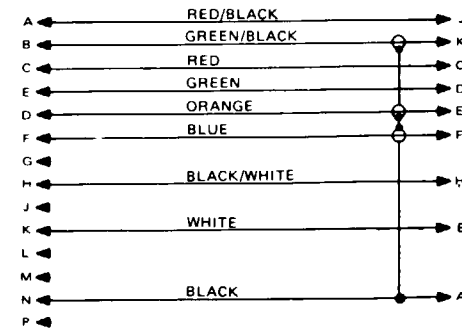

CABLE CX-7056/VRC

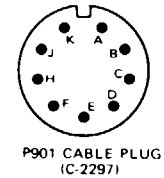

P901 CABLE PLUG (C-2297)

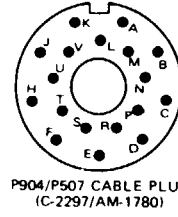

P904/P507 CABLE PLUG (C-2297/AM-1780)

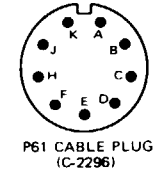

P61 CABLE PLUG (C-2296)

EL2DT012

Figure 4-1. Typical cable assemblies

4-5. General Cabling Instructions

Refer to paragraph 1-12 for general discussion concerning equipment required to make the AN/VIC-I(V) operational.

a. Identifying Cable Connectors. To identify the cable plugs with the equipment jack to which they are attached, inscribe the equipment jack reference designation on a tag, label, or decal and attach it to the plug. A set of decals containing equipment jack designations (J501, J509, J71, etc.) is available. The set is identified as a marking set in SB 11-131. Attach the proper label to the neck of each cable plug while it is attached to the equipment jack.

b. Connecting Cables.

(1) Before connecting a cable to the equipment jack, observe the following:

(a) Check to see that the connector pins are straight; straighten them if necessary.

(b) Check to see that the locknuts of both sides of the plug are tight; tighten them if necessary (fig. 5-1).

(c) Check to see that the wing nuts on the plug are tight; tighten them if necessary (fig. 4-2).

(d) Replace the cable when the insulation is damaged or the insulation has come loose from the gland nut in the connector (fig. 5-1).

(2) To attach the cable plug to the equipment jack, raise the wing nut, position the plug at the angle that permits the keyway in the plug to slip into the key in the jack, then press the cable connector into the jack. Rotate the wing nut to lock the plug to the jack, and lower the wing nut.

(3) Route the cable to the assigned equipment jack,

(a) Follow the route prescribed in the installation instructions.

(b) Make sure there is no slack in the cable between the cable clamp points. Check to see that the cable clamps grip the cable securely and that the screws and lock washers holding the clamps are tight.

(4) The following information applies to the AM-1780/VRC and the equipment associated with it (fig. 4-4 through 4-10).

NOTE

When the C-10456/VRC is installed in the combat vehicle, all references to C-2298/VRC in the following procedures apply to the C-10456/VRC.

Connect the cable from the remote hand or foot switch in the vehicle to the keying control jack in the vehicle to the keying control jack located behind the VOLUME control (fig. 2-5) of C-10456/VRC.

(a) The cable from the commander's control box must be attached to jack J504 on the AM-1780/VRC. This arrangement is required to

ensure that the commander can assume control of the radio circuits thus overriding control of the system by other crewmembers using the intercom system.

CAUTION

The cable connection from the MT-1029/VRC of radio "A" must be attached to J501 of the AM-1780/VRC if radios are used. If attached to other jacks, the AM-1780/VRC circuit components may be damaged. If radios are not used, power should be connected to J508 and the AM-1780/VRC INSTALLATION SWITCH set to INT ONLY.

(b) The cables to the AM-1780/VRC from the crewmember control boxes (C-2298/VRC and C-2297/VRC) can be connected indiscriminately to the jacks (J505, J506, and J507) on the top of the AM-1780/VRC,

(c) In some vehicles, the connection from the driver's C-2297/VRC or C-2298/VRC is provided by direct cable connection using cable assembly CX-4723/VRC. In other vehicles, the connection is made by other cable types to the vehicle wiring system. When connection is made through vehicle wiring, the cables on both sides of the vehicle wiring must be the same (CX-7060/VRC on each side or CX-9640 on each side).

NOTE

The CX-9640 MUST be used in the M-109 S.P. Howitzer installation.

(d) The cable connections to the C-2298/VRCs can be made to either the left or right jack.

(e) One or more C-2298/VRCs can be connected to a C-2298/VRC that is connected to the AM-1780/VRC, using CX-4732/VRCs for the purpose. All C-2298/VRCs operate independently of each other when so connected.

(f) If the C-2299/VRC is used, the left jack, J701, must be connected to J511 of the AM-1780/VRC; J702 must be connected to J509 on the AM-1780/VRC.

(g) In some tank installations, a branched cable, connected on one end to the commander's C-2298/VRC, is terminated in two jacks in the cupola to which the commander's audio accessory is connected.

(h) Control box C-10456/VRC can be recognized from the C-2298/VRC control box, by the additional jack located behind the VOLUME control.

(i) To use control box C-10456/VRC in a non-remote keying situation, secure the remote keying dummy plug on the remote keying jack, J805. System operation is now identical to that of the AN/VIC-I(V)

using control box C-2298/VRC.

(j) To secure remote keying cables and dummy plug on remote keying jack of the C-10456/VRC perform the following.

1. Aline key of dummy plug or remote keying cable connector with keyway of jack.
2. Insert dummy plug or cable connector into jack.
3. Turn outer ring to the right (clockwise), while applying light pressure to the cable connector or dummy plug, until it locks into place.

(k) To remove the dummy plug or cable connector from remote keying jack perform the following.

1. Turn outer ring to the left (counterclockwise).
2. Pull connector out of keyway.

c. *Field Telephones and Intervehicle Connections.* Operation under the arrangements in (1) and (2) below is covered in paragraph 2-5c.

(1) *Field telephone connections.* A field telephone can be connected to the intercom circuits of the AN/VIC-1(V) to enable the telephone user to communicate with the crewmembers. Connect the wires from the field telephone to the LINE (or TEL/

REMOTE) binding posts of the AM-1780/VRC or the LINE binding posts of the C-2296/VRC (fig. 4-4 through 4-10).

(2) *Intervehicle connections.* The intercom circuits of different vehicles can be interconnected to enable the crewmembers to communicate with each other. This is accomplished by connecting the field wires between the LINE (or TEL/REMOTE) binding posts of the AM-1780/VRC or C-2296/VRC of one vehicle with the AM-1780/VRC or C-2296/VRC of another vehicle.

d. *Cabling Diagrams,*

(1) Figures 4-4 and 4-5 show typical cabling of AN/VIC-1(V) when it is not used in conjunction with radio equipment (para 1-8a).

(2) Figure 4-7 through 4-10 show cabling of ANWIC-1(V) when it is used in conjunction with radio equipment (para 1-8b).

e. *Cabling Details.*

(1) Figure 4-2 shows cabling details for the AM-1780/VRC pointing out proper cable angles.

(2) Figure 4-3 shows cabling details for control boxes, pointing out proper cable angles.

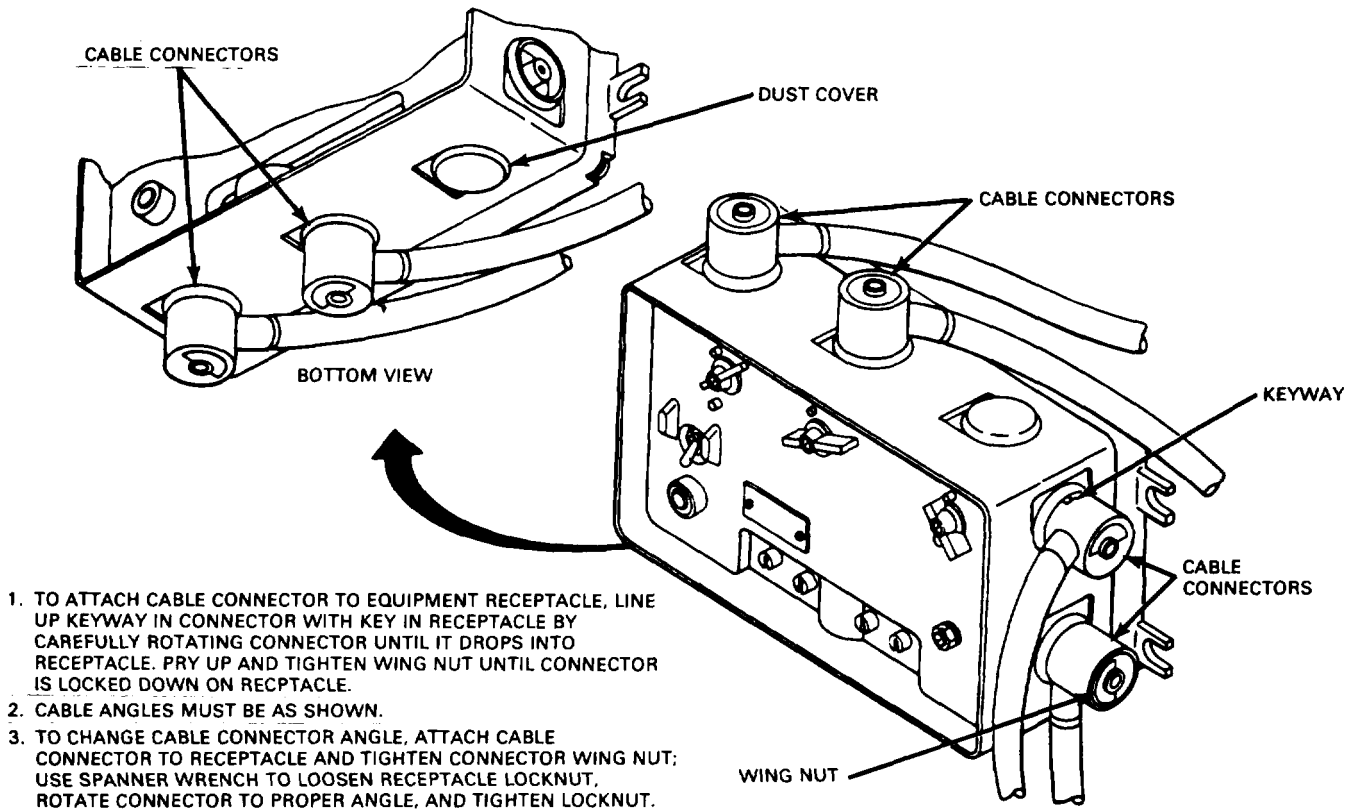

EL2DT013

Figure 4-2. AM-1780/VRC cabling details, shown in "with radio" configuration.

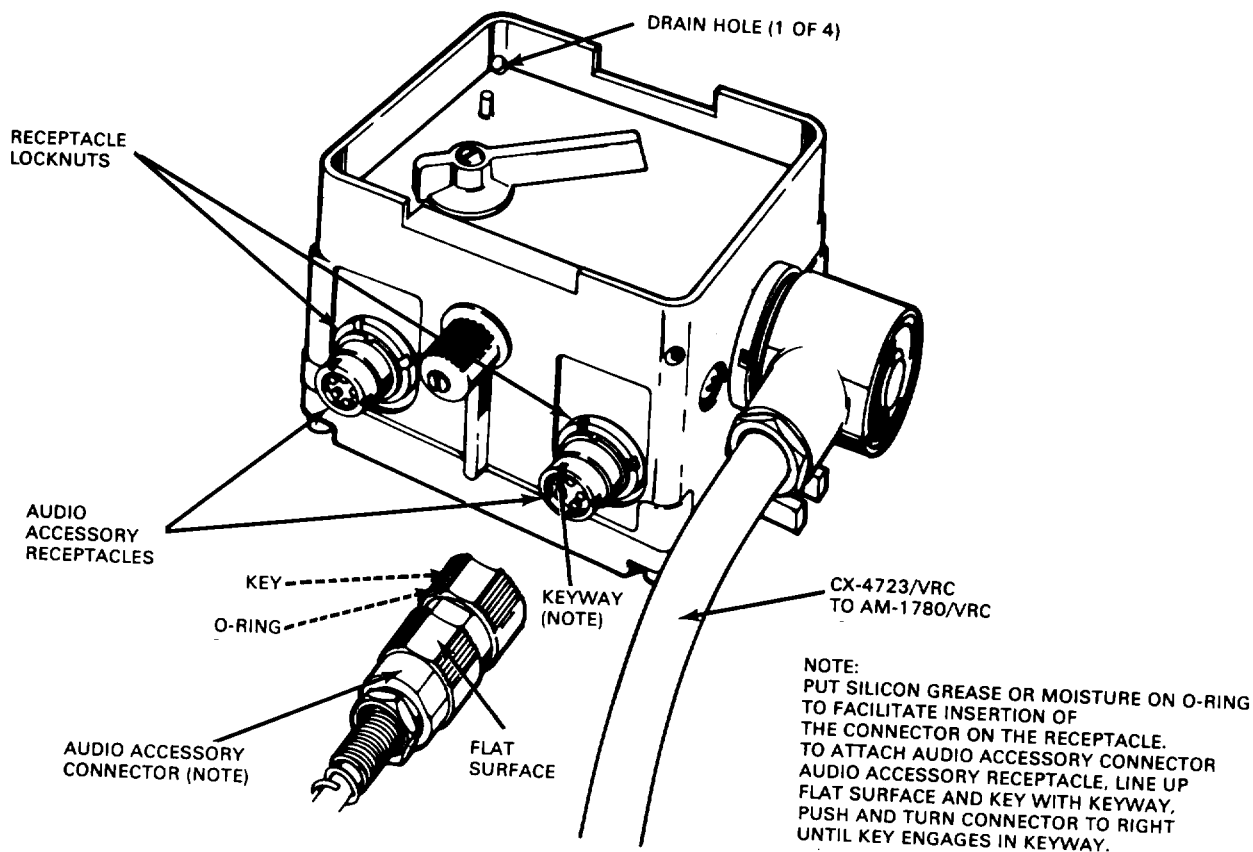

EL2DT014

Figure 4-3. Control box cabling details

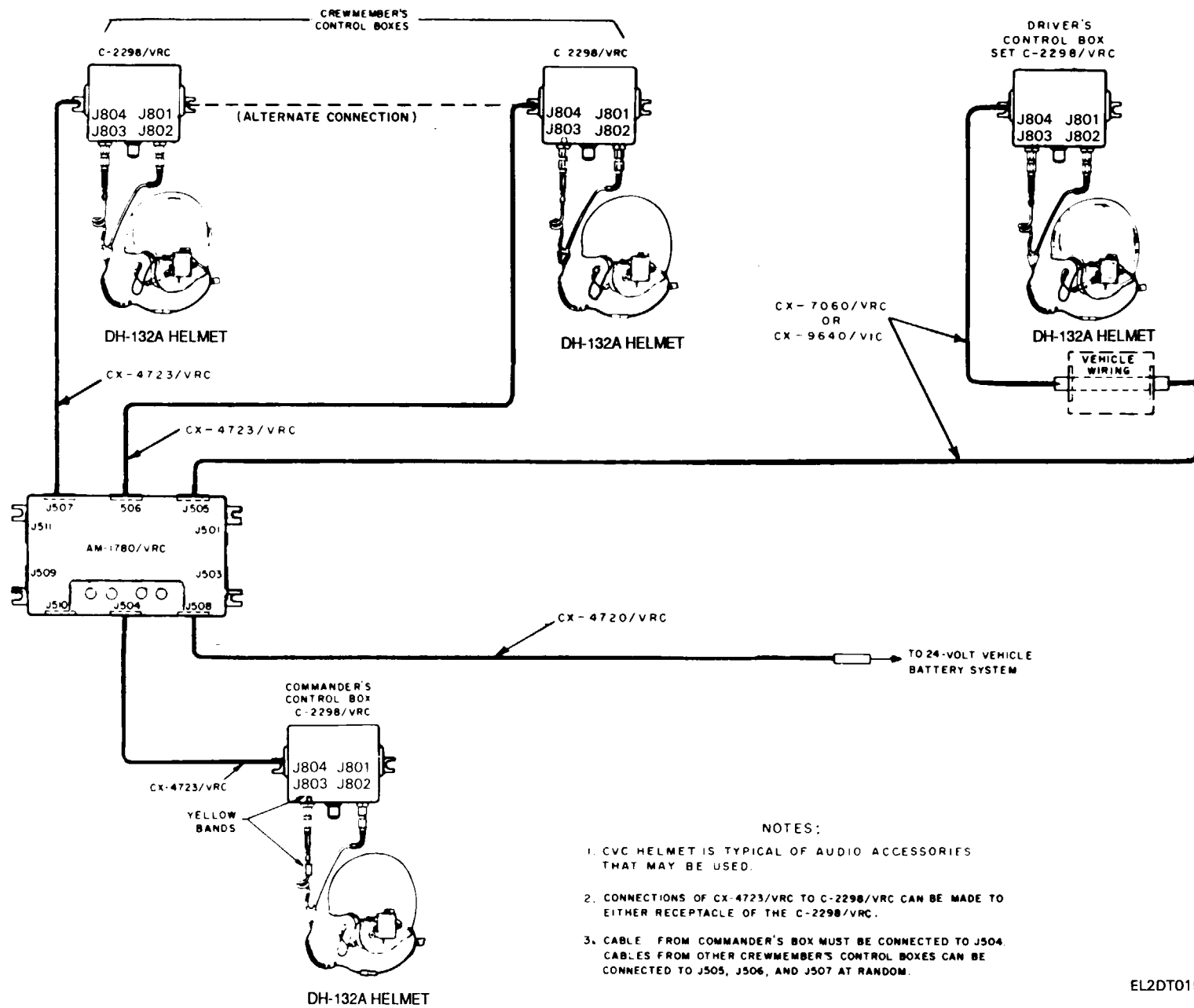

Figure 4-4. Typical cabling of AN/VIC-1(V) when radio equipment is not provided.

EL2DT015

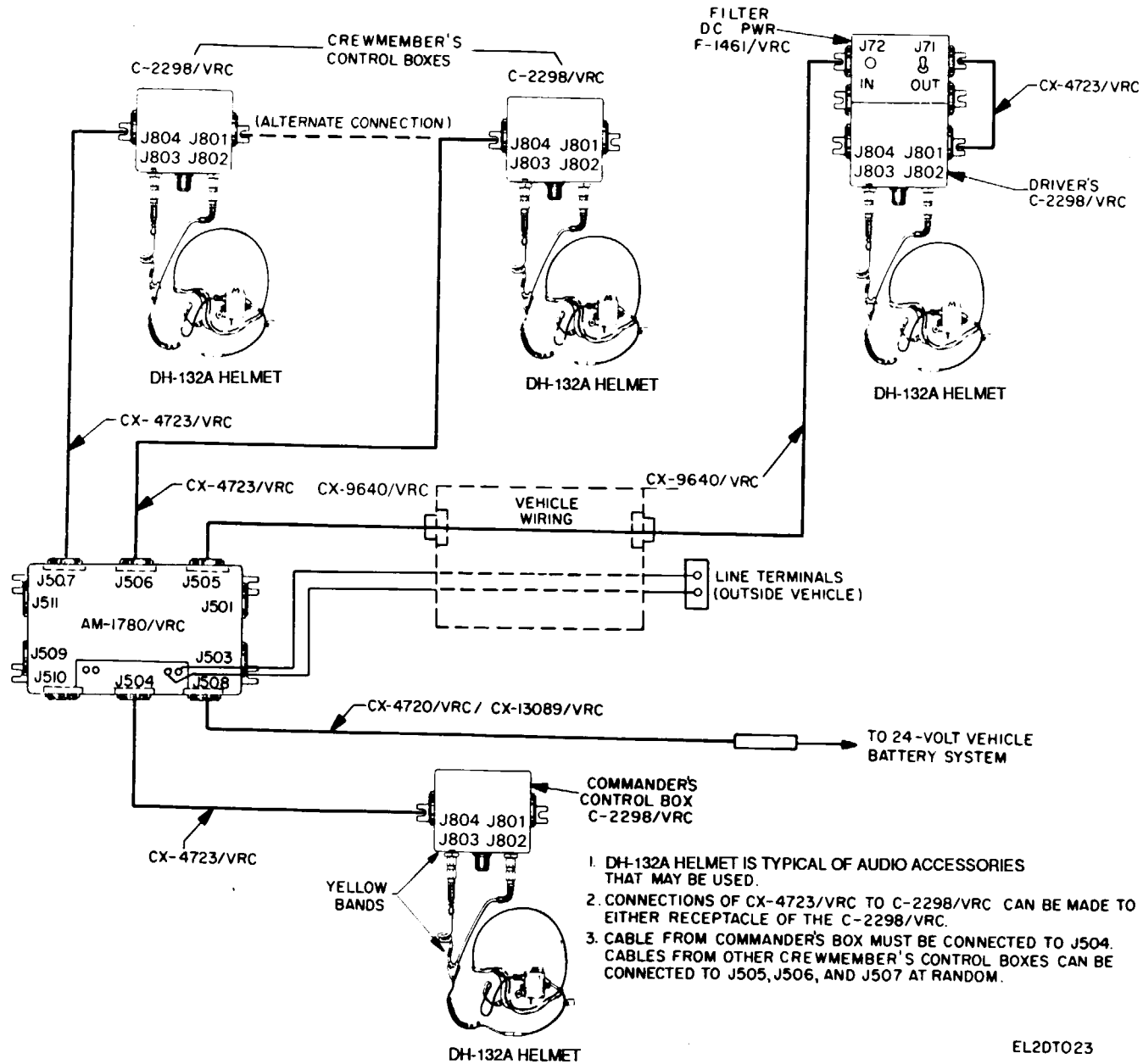
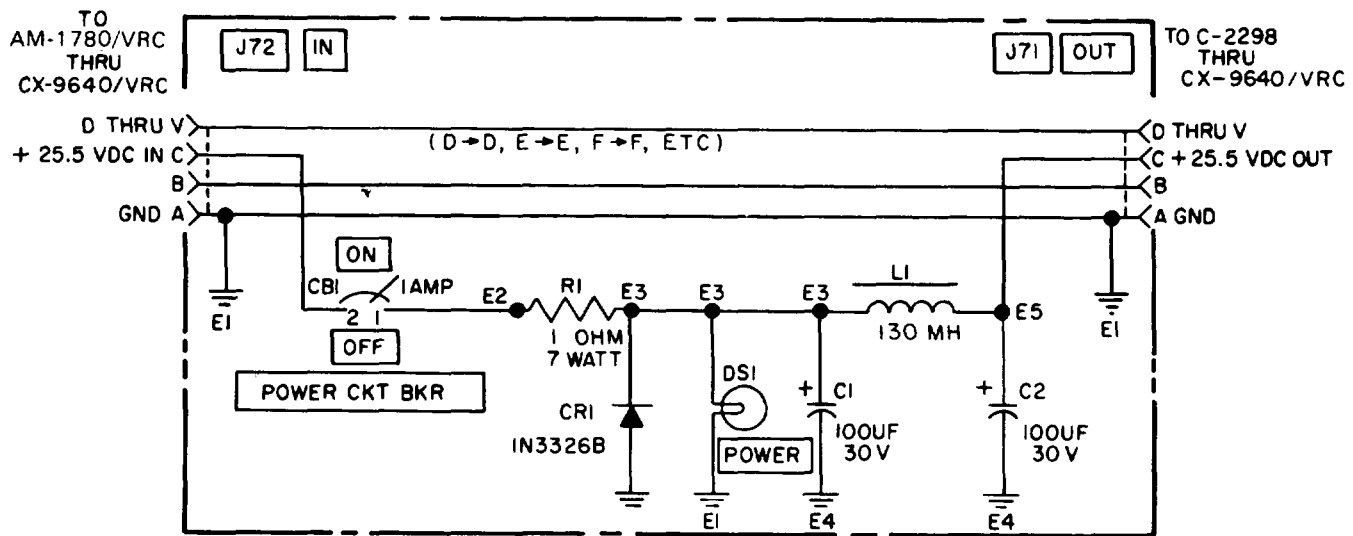
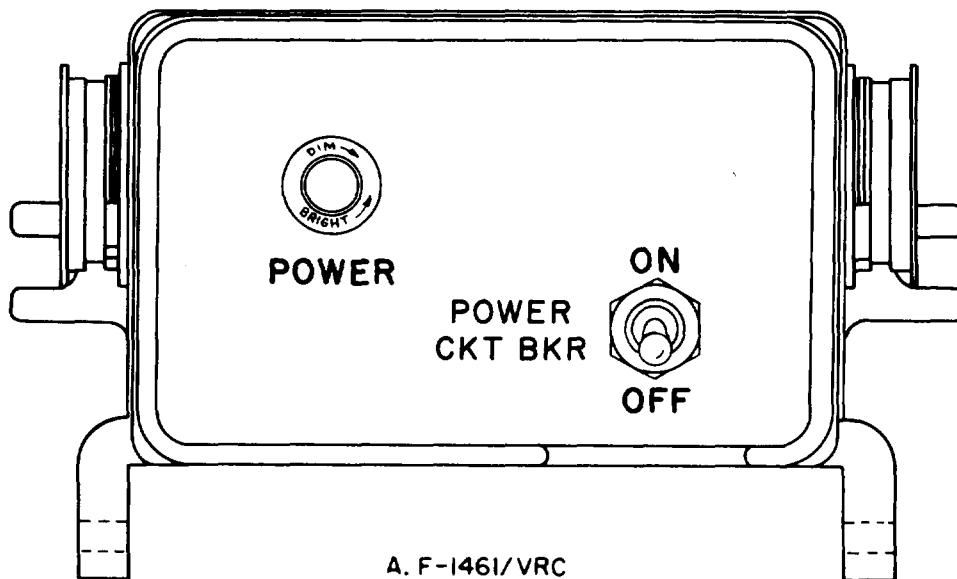

Figure 4-5. Typical cabling of AN/VIC-1(V) in Howitzer M109, A1, A2.



B. F-1461/VRC SCHEMATIC DIAGRAM

EL2DT025

Figure 4-6, Filter, Dc Power F-146/VRC and schematic diagram.

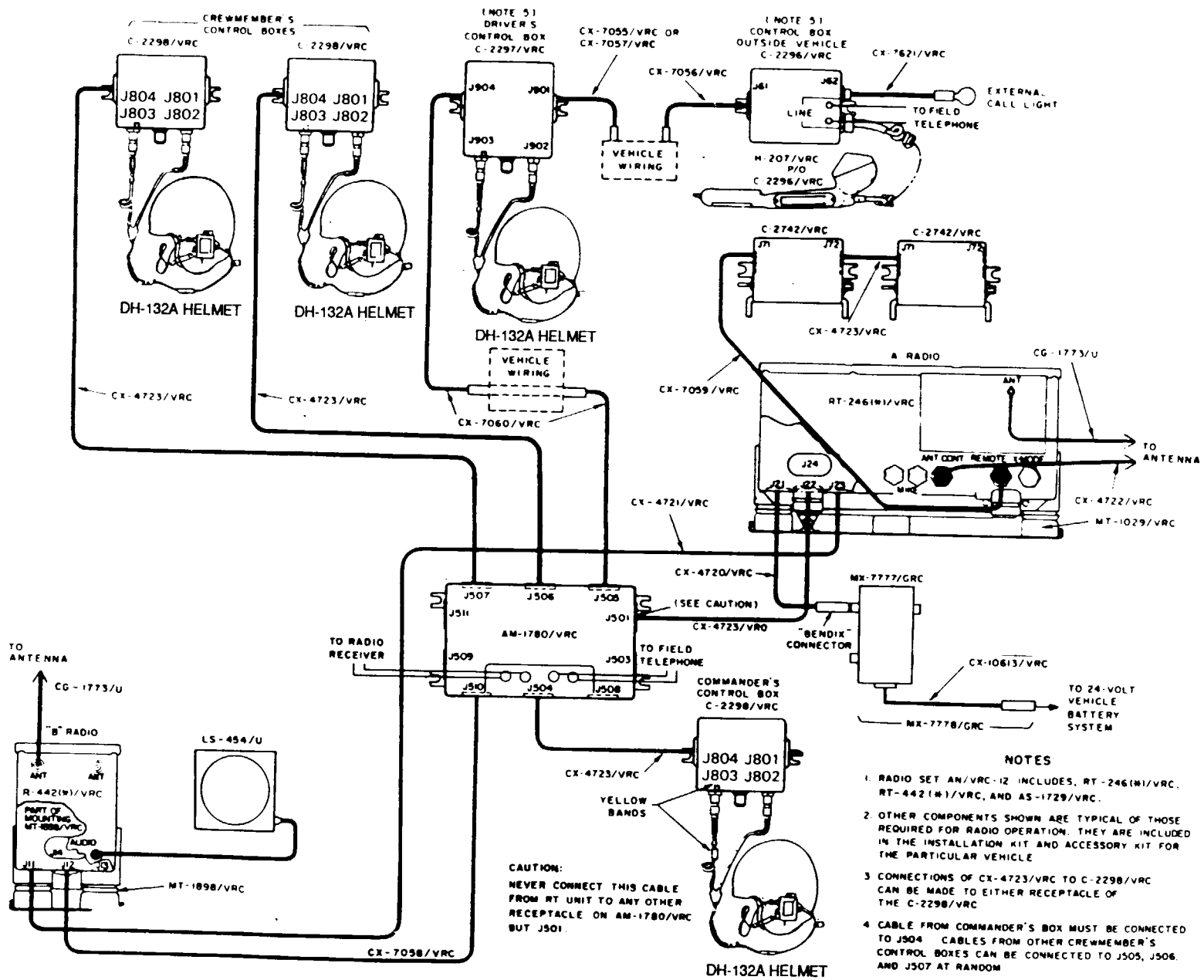

- NOTES**
1. RADIO SET AN/VRC-12 INCLUDES, RT-246(11)/VRC, RT-442(11)/VRC, AND AS-1729/VRC.
 2. OTHER COMPONENTS SHOWN ARE TYPICAL OF THOSE REQUIRED FOR RADIO OPERATION. THEY ARE INCLUDED IN THE INSTALLATION KIT AND ACCESSORY KIT FOR THE PARTICULAR VEHICLE.
 3. CONNECTIONS OF CX-4723/VRC TO C-2298/VRC CAN BE MADE TO EITHER RECEPTACLE OF THE C-2298/VRC.
 4. CABLE FROM COMMANDER'S BOX MUST BE CONNECTED TO J904. CABLES FROM OTHER CREWMEMBER'S CONTROL BOXES CAN BE CONNECTED TO J905, J906, AND J907 AT RANDOM.
 5. NOT PROVIDED IN SOME INSTALLATIONS.

Figure 4-7. Typical Cabling of AN/VIC-1(V) with Radio Set AN/VRC-12.

Change 3
4-9

EL2DT016

TM 11-5830-340-12

**4-6. Installing and Removing Power Cables
CX-4720/VRC and CX-13089/VRC**

Cable Assemblies CX-4720/VRC and CX-13089/VRC (fig. 4-11) provide connection between the dc power source and the AM-1780/VRC (fig. 4-4 and 4-5), or between the dc power source and the MT-1029/VRC when the radio equipment is used with the AN/VC-1(V) (fig. 4-7 through 4-10). The power cables are available in various lengths depending on the distance between the power outlet and the equipment.

a. *Attaching Terminal Lugs and Bendix Connector to CX-4720/VRC.* Depending on the vehicle in which the equipment is used, either terminal lugs ((1) below) or a Bendix connector ((2) below) is attached to the CX-4720/VRC.

(1) *Terminal lugs.* In installations in which the power cable is connected directly to the vehicle battery, terminal lugs are soldered to cable conductors. The lugs are issued with the installation kit for

the vehicle and are sometimes supplied with MT-1029/VRC.

NOTE

In order to identify the CX-4720/VRC wire conductors, attach a label permanently to each conductor (fig. 4-12). Use either battery cable lead labels made for this purpose or TY-RAP cable ties marked with the letters POS and NEG. The black-green pair is the negative and the red-white pair is positive. The positive lug is larger than the negative lug.

(2) *Bendix connector.* In vehicles in which dc power is available from a 3-pin receptacle, or from Suppressor, Electrical Transient MX-7778/VRC, the CX-4720/VRC or CX-13089/VRC is attached to the vehicle Bendix receptacle.

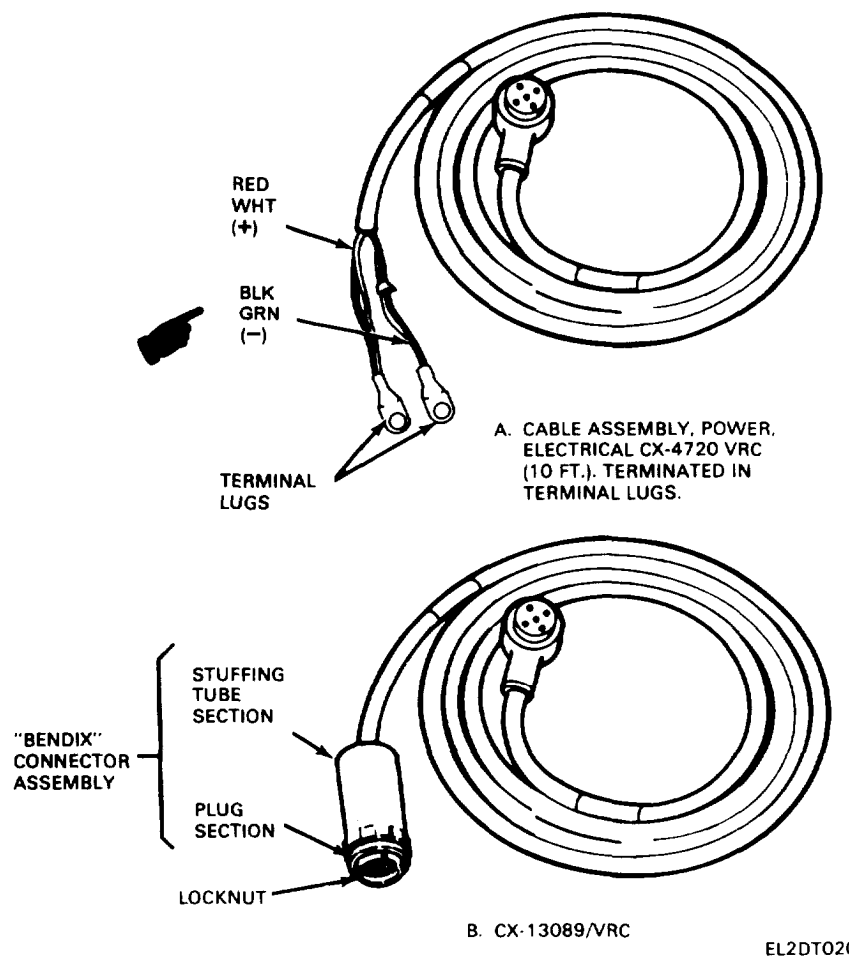

Figure 4-11. Cable Assembly, Power, Electrical CX-4720/VRC, terminated in terminal lugs and Bendix connector assembly. When issued with Bendix connector assembly, cable is type CX-13089/VRC.

b. Installing and Removing CX-4720/VRC or CX-13089/VRC.

WARNING

Before installing or removing dc power cables, CX-4720/VRC and CX-13089/VRC, turn off the vehicle engine and the AM-1780/VRC MAIN PWR switch to OFF (fig. 2-1). Also, turn off the radio equipment, if provided.

(1) Installation.

(a) When the AN/VIC-1(V) is used alone (fig. 4-4), attach the CX-4720/VRC (or CX-13089/VRC) to J508 on the AM-1780/VRC.

(b) When the AN/WC-1(V) is used with the radio system (fig. 4-7 through 4-10), the CX-4720/VRC (or CX-13089/VRC) is connected to J21 of the MT-1029/VRC. The dc power is applied through the MT-1029/VRC jack J22 and the CX-4723/VRC to J501 on the AM-1780/VRC for use both by the AN/VIC-1(V) intercom set and the radio set(s). To install the dc power cable (CX-4720/VRC or CX-13089/VRC) use the procedures in 1 through 5 below.

NOTE

All references to “dc power cable” apply to CX-4720/VRC and CX-13089/VRC in the following procedures.

1. Separate the top tray of the MT-1029/VRC left jack J21 (fig. 4-7). If applicable, connect the CX-4723/VRC to J22 and the other dc power cable, CX-4721/VRC, to J23. Route each cable between the top tray and the base assembly in such a way that it follows the cable route to the next equipment.

2. Reinstall the top tray on the base assembly.

3. Route the cable to the equipment use the prescribed route, insulators, and cable clamps that are provided.

WARNING

Vehicle battery can give off explosive gas, Don't smoke and be careful to avoid sparks

when working near battery. Otherwise, you may cause an explosion injuring yourself and others.

4. When the cable is provided with terminal lugs (A, fig. 4-11), attach the cable lugs to the battery terminals as shown in figure 4-12.

CAUTION

Reversing the polarity of the cable lugs will damage the AM-1780/VRC.

5. When the cable is provided with the Bendix connector (B, fig. 4-11), connect the plug section to the vehicle dc power outlet or the MX-7778(*)/GRC, and tighten the locknut.

(2) Removal.

(a) When the AN/VIC-1(V) is used alone (without radio system), disconnect the dc power cable from J508 on the AM-1780/VRC (fig. 4-4).

(b) When the AN/VIC-1(V) is used with radio system, use the procedures in 1 or 2 below.

1. Separate the top tray of the MT-1029/VRC from its base assembly and disconnect the dc power cable from the jack (J21). If required, disconnect other cables from the radio mount receptacles. Replace the top tray on the base assembly.

WARNING

Vehicle battery can give off explosive gas. Don't smoke and be careful to avoid sparks when working near battery. Otherwise, you may cause an explosion injuring yourself and others.

2. Disconnect the other end of the dc power cable from the battery terminals (fig. 4-12); be sure to tighten the nuts on the battery clamps after removal of the dc power cable. If the cable is connected to the vehicle dc power outlet or the MX-7778(*)/GRC, loosen the locknut on the Bendix connector and remove the connector from the outlet.

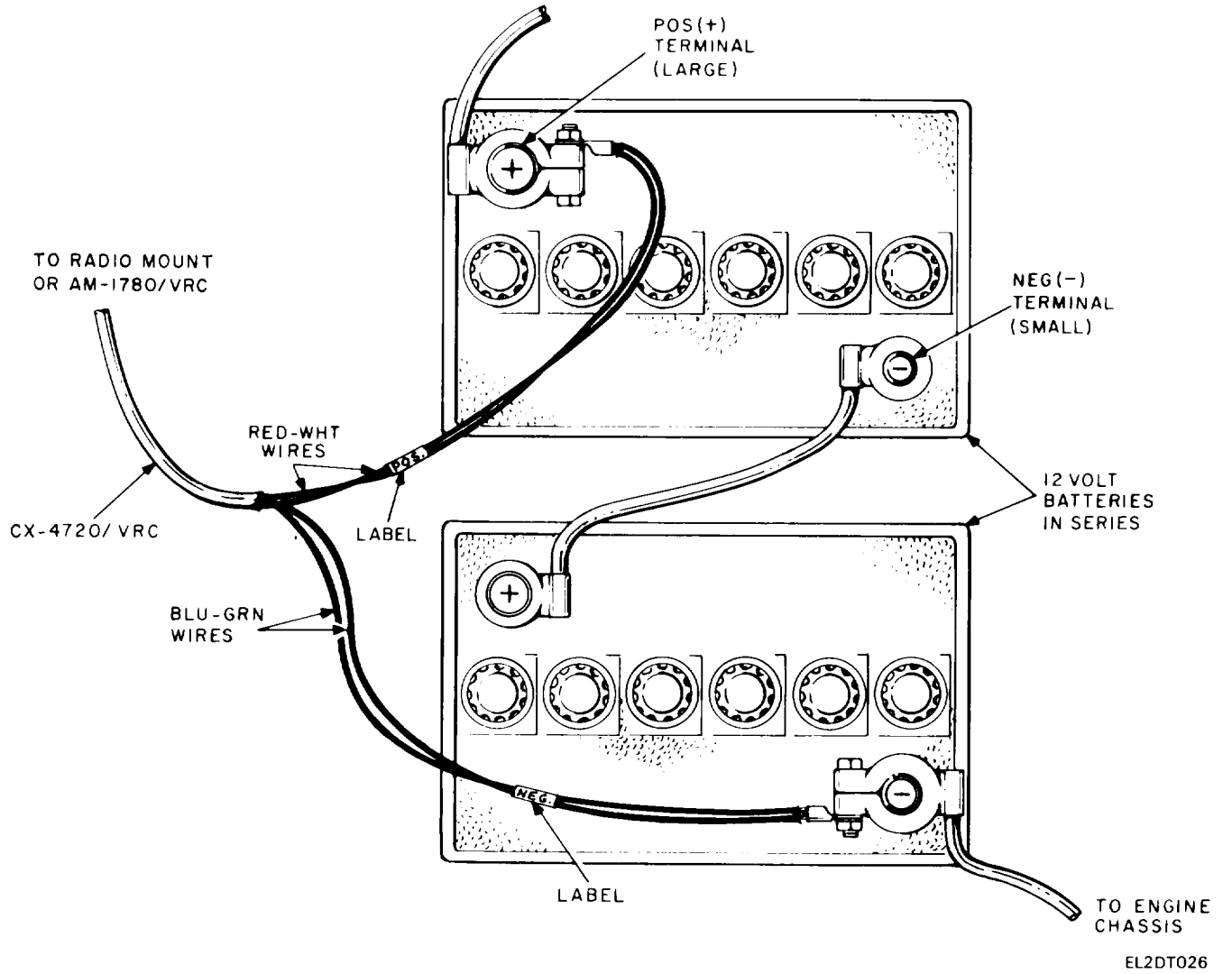

Figure 4-12 Connecting CX-4720/VCR to vehicle battery.

CHAPTER 5 ORGANIZATIONAL MAINTENANCE INSTRUCTIONS

Section CI PREVENTIVE MAINTENANCE

5-1. Scope of Organizational Maintenance

a. Organizational maintenance of the AN/VIC-1(V) includes the following:

- (1) Preventive maintenance checks and services (PMCS) (para 5-2, table 5-1).
- (2) Lubricating parts (para 5-3) and touchup painting (para 5-4).
- (3) Troubleshooting (para 5-9) and maintenance (para 5-1 1).

b. Tool Kit, Electronic Equipment TK-101/G is required for tools to install and replace equipment.

5-2. Preventive Maintenance, General

Preventive maintenance is the systematic care, servicing, and inspection of equipment to prevent occurrence of trouble, to reduce downtime, and to assure that the equipment is serviceable. Preventive maintenance checks and services (PMCS) defines the procedures to be performed at specific intervals and under certain conditions. Organizational PMCS is performed on a monthly and quarterly schedule (table 5-1).

a. If the equipment fails to operate, try troubleshooting (para 5-9). Refer to DA Pam 738-750 for forms and records to be used for troubleshooting and for recording, scheduling, and reporting PMCS.

b. If the equipment must be kept in constant operation, select those items that can be checked and serviced without disturbing operation. Make the complete checks and services when the equipment can be shut down.

c. Select those items to be inspected that are authorized for the vehicle installation.

d. The *Item no.* in table 5-1 shall be used as a source of item numbers for the *TM number* column on DA Form 2404 (Equipment Inspection and Maintenance Worksheet) in recording the results of the PMCS.

NOTE

The PMCS procedures in table 5-1 are for the AN/VIC-1 (V) installed in a vehicle in which no radio is connected to the AN/VIC-1(V). For AN/VIC-1(V) connected to radio, refer to the following publications for organizational PMCS for indicated radio configurations:

<i>Radio configuration</i>	<i>Publication</i>
Radio Sets AN/VRC-12, AN/VRC-43 through AN/VRC-49	TM 11 -5820-401-20-2
Radio Sets AN/VRC-53, AN/VRC-64 AN/GRC - 1 25, and AN/GRC - 160	TM 11-5820 -498-1 2

e. Routine checks, such as cleaning (para 3-3), checking for frayed or damaged cables, stowing items not in use, checking for loose nuts and bolts etc., are not listed in the PMCS chart. These are things you should do anytime you see they must be done.

5-3. Using Lubricants on Connecting Surfaces

There are two kinds of lubricants that can be used on the mating surfaces of the equipment. One is used on the radio whip antenna sections to prevent them from seizing; the other is used on surfaces of preformed packing in the covers of equipment and the O-rings on connectors (*b* below).

a. *Lubricants.* Following are typical lubricants that can be used.

(1) Grease, Graphite. This is used on radio whip antenna sections.

(2) Insulating Silicone Compound, used on O-rings, preformed packing, and gaskets (*b* below).

b. *Lubricating O-rings, Preformed Packing and Gaskets.*

(1) Typical example of O-ring is found in audio accessory cable connectors (fig. 5-1).

(2) Typical examples of preformed packing are found embedded in the covers of the control boxes and radios. Gaskets used in the installation may also be coated with the insulating silicone compound.

CAUTION

Do not let the insulating silicone compound touch electrical contacts or surfaces.

(3) Clean the surface and apply a thin film of insulating silicone compound, item *a*(2) above.

5-4. Painting

Remove rust and corrosion from metal surfaces by lightly sanding them with fine sandpaper. Brush two thin coats of paint on the bare metal to protect it from further corrosion. Refer to applicable painting and refinishing instructions given in SB 11-573 and TB 43-0118.

Table 5-1. Organizational Preventive Maintenance Checks and Services

Item no.	Interval		Item to be inspected	Procedure
	M	Q		
1	●		OUTSIDE CONTROL BOX C-2296	Check to see that outside signal lamp is in place. Replace if missing or broken. Check for damage.
2	●		Signal lamp H-207 and cord	
3	●		SUPPRESSOR, ELECTRICAL TRANSIENT (MX-7777/GRC) Controls a. Circuit breaker b. BATTLE OVER- RIDE switch	a. Check for smooth operation. b. With radio-intercom system turned off, check for smooth operation.
4	●		Ground strap	Check that ground strap is properly connected. Tighten if loose; replace if frayed or damaged.
5		●	Cable connections	Check that cable plug and component jack locking rings are tight to prevent twisting of cables and possible damage to internal wiring. Tighten lock rings with spanner wrench. Tighten loose cable restraint (gland) nut using adjustable wrench.
6	●		AM-1780 POWER CKT BKR	Check for smooth operation.
7		●	Equipment modifications	Check to see whether modification work orders (MWOs) are required to be performed on the equipment (fig. 1-1). Refer to DA Pam 310-1 for listing of MWOs.
8	●			Do the operational check for the intercom set (para 5-6c).

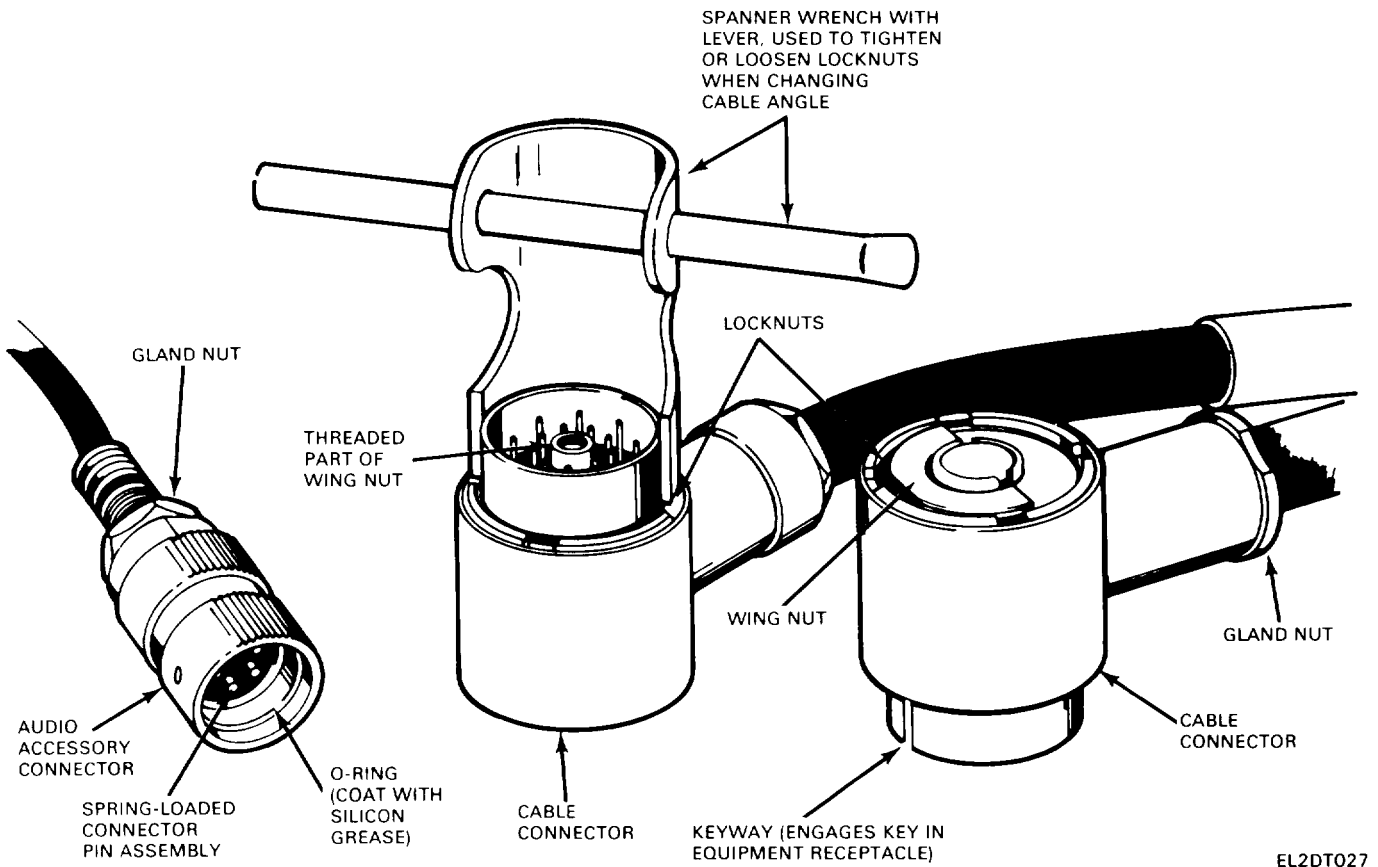

Figure 5-1. Details of cable connectors.

EL2DT027

Section II. TROUBLESHOOTING AND MAINTENANCE

5-5. General

a. When troubleshooting procedures identify a piece of equipment as defective, it is either replaced at the organizational maintenance facilities or referred to higher maintenance level for repair.

b. The following equipment is required to troubleshoot and repair the equipment.

- (1) Tool Kit, Electronic Equipment TK-101/G.
- (2) Multimeter AN/URM-105 (TM 11-6625-203-12).

5-6. Troubleshooting the Intercom kt

a. **General.** The procedures used in this chapter are used to check the operation and troubleshoot the intercom set without radios. For radio-intercom systems (radios installed) refer to 'TM 11-5820-401 -20-2 for radio-intercom system using AN/VRC-12 series radios or TM 11-5820-498-12 for radio-intercom system using AN/VRC-64 or AN/GRC-160 series radios.

(1) Before proceeding, perform the checks and corrective measures in the operator's troubleshooting procedures (para 3-4 and 3-5),

(2) Refer, to figure 4-1 when troubleshooting cable assemblies.

(3) Refer to figures FO-1 and FO-2 for power and signal distribution circuits of the radio-intercom system.

(4) Simplified block diagrams are provided throughout the troubleshooting flow charts.

(5) Repair information is contained in paragraph 5-11.

b. **Troubleshooting the Intercom Set.** The troubleshooting procedures listed herein cannot be all-inclusive. The methods used below may be altered to fit the configuration concerned. The troubleshooting procedure contains two parts, an operational check (c below) and troubleshooting flow charts, paragraph 5-9. The operational check is normally done with the equipment installed in the vehicle. As a minimum, it is performed as part of the scheduled preventive maintenance checks and services (PMCS). After repairs, the operational check, or the appropriate portion of it, should be performed to ensure that the malfunction has been corrected and that no other malfunction exists.

(1) The operational check first lists preparatory actions that, when done, establish a starting condition for the equipment performance checklist (EPC) that follows.

(2) The equipment performance checklist contains detailed steps consisting of a procedure to follow,

normal (expected) results, and a remarks column.

(3) When normal indications are observed, proceed to the next step or follow the how to proceed instructions.

(4) When abnormal indications are observed, the step will either state a faulty item of equipment or refer you to a troubleshooting flow chart, by number. These charts are contained in paragraph 5-9.

(5) Observe all **WARNINGS** and **CAUTIONS** as they appear throughout the procedures.

c. **Operational Check.** Follow the procedures below in the sequence given.

- (1) **Initial Adjustments.** (Perform as applicable.)

WARNING

To safeguard against electrical shock and possible damage to equipment, remove or tape all personal exposed metal objects such as watches, rings, and medallions.

(a) Set vehicle MASTER POWER switches OFF (hull and turret).

(b) Set MX-7777(*) circuit breaker and BATTLE OVERRIDE switches OFF.

(c) Set AM-1780/VRC MAIN PWR and POWER CKT BKR switches to OFF.

CAUTION

Do not start vehicle engine with any communication equipment turned on. Make certain that all communications components that have POWER switches are turned OFF. Starting a vehicle with communication equipment on can cause serious damage to its components.

(2) Refer to the appropriate TM and ensure that all items of equipment for the intercom set are properly installed, and that the cables are properly routed and connected.

(3) Start vehicle and set MASTER POWER switches ON.

(4) Set AM-1780/VRC **INSTALLATION SWITCH to INT ONLY.**

(5) Set RADIO TRANS switch to LISTENING SILENCE.

(6) Set INTACCENT switch to OFF.

(7) Open POWER lamp lens cover by turning lens cover counterclockwise to stop, then 1/8 turn clockwise.

CAUTION

The POWER lamp socket may become loose and rotate in the AM-1780/VRC housing, causing an adverse short. Do not operate the equipment when this receptacle is loose.

CAUTION

The lamp socket may become loose and rotate in the C-2297/VRC housing causing an adverse short. Do not operate the equipment if this receptacle is loose.

(8) Set the C-2297/VRC (if included, at the driver's position) as follows:

- (a) SIG-EXT-OFF switch to OFF
- (b) Open lamp lens cover by turning lens collar counterclockwise to stop, then clockwise 1/8 turn.

(9) Check the operation of the H-189/U as shown. To circuit disturb, set the multimeter up as an ohmmeter, RX10, and connect the negative lead to chassis ground. Touch the positive lead to the test point several times. A clicking sound should be heard each time the test point is touched.

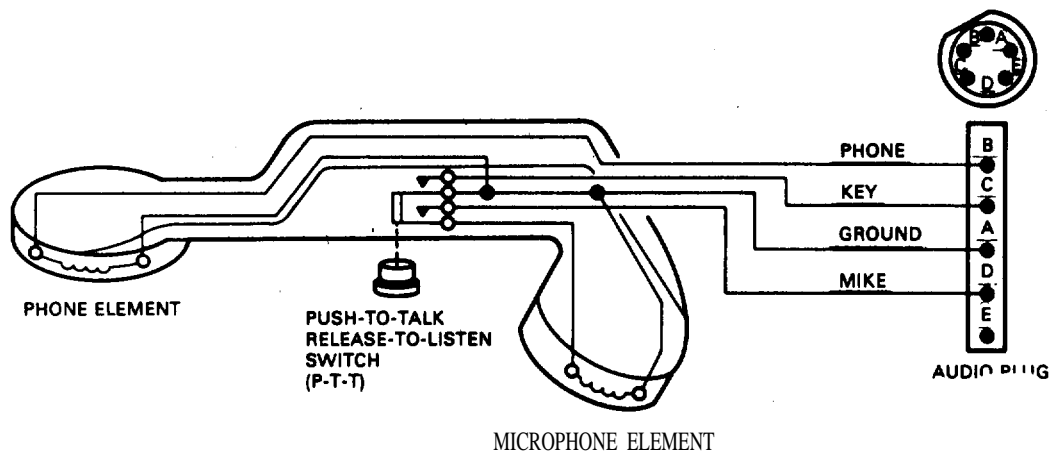

EL2DT028

Figure 5-2. H-189/U Handset,

(a) *Phone Element Check* Circuit disturb (para 5-6c(9) above) between pin A and B of handset's audio plug. A clicking sound should be heard from phone element.

(b) *Keying Check*. Connect meter leads between pin A and C of handset's audio plug. With handset's push-to-talk switch held in, meter should show zero ohms. With handset's push-to-talk switch released, meter should show infinity (00) ohms.

(c) *Microphone Element Check*. Connect meter leads between pin A and pin D of handset's audio plug. While listening to microphone element, press and release handset's push-to-talk switch several times. A

clicking sound should be heard from microphone element,

NOTE

Before connecting cables and audio accessories to components of the intercom set, make sure that all plug and jack contacts or pins are clean and undamaged. After connection, ensure that the connection is tight.

(10) Perform the Equipment Performance Checklist below.

5-7. Equipment Performance Checklist

NOTE

If the MX-7777A is installed, the BATTLE OVERRIDE switch should remain in the OFF (closed hood) position.

Step	Procedure	Normal indication	Remarks
1.	Set vehicle MASTER power switches to ON.	Vehicle MASTER power lamps should light.	If lamps do not light, report condition to supervisor.
2.	If installed, set MX-7777 circuit breaker to ON.	Circuit breaker should stay ON.	If circuit breaker trips, refer to troubleshooting chart, figure 5-3.
3.	Turn AM-1780/VRC MAIN PWR switch to INT ONLY.	AM-1780/VRC POWER lamp should not light.	If POWER lamp lights, replace AM-1780/VRC.
4.	Set AM-1780/VRC POWER CKT BKR to ON.	AM-1780/VRC POWER lamp should light.	a. If POWER lamp does not light, refer to troubleshooting chart, figure 5-4. b. If POWER CKT BKR trips OFF, refer to troubleshooting chart, figure 5-5.
5.	Connect handset to commander's control box, J803 (yellow band).		
6.	Turn VOLUME control fully clockwise.		
7.	One at a time, for each position of the MONITOR switch listed, key the handset and speak into the microphone, then unkey handset: A ALL B C	For each position of the MONITOR switch, relays in the AM-1780/VRC should click and sidetone should be heard. NOTE Sidetone will not be heard at the DRIVERS STATION on positions A and B in M1 and M1A1 tanks.	a. If in any switch position the relays do not click and no sidetone is heard, refer to troubleshooting chart, figure 5-7. b. If in any switch position relays do not click, but sidetone is heard, refer to troubleshooting chart, figure 5-8. c. If in all switch positions relays click but no sidetone is heard, refer to troubleshooting chart, figure 5-10. d. If in a particular switch position relays click but no sidetone is heard, refer to troubleshooting chart, figure 5-11.
8.	Move handset from J803 to J802 on commander's control box.		
9.	Turn MONITOR SWITCH to INT ONLY.		
10.	Key handset and talk into microphone.	AM-1780/VRC relays should click and sidetone should be heard. NOTE	If normal indications are not obtained, replace commander's control box.
If there is only a driver's control box left in the installation go to step 18 at this time.			
11.	Move handset to J803 (yellow band) of crewmember's control box (not driver's).		
12.	Turn VOLUME control fully clockwise.		
13.	One at a time, for each position of the MONITOR switch listed, key handset and talk into microphone, then unkey handset: ALL A INT ONLY B	For each position of the MONITOR switch, relays in the AM-1780/VRC should click and sidetone should be heard.	a. If in any position relays do not click and no sidetone is heard, refer to troubleshooting chart, figure 5-7. b. If in any position relays do not click but sidetone is heard, refer to troubleshooting chart, figure 5-12. c. If in all positions relays click but no sidetone is heard, refer to troubleshooting chart, figure 5-10. d. If in a particular position relays click but no sidetone is heard, refer to troubleshooting chart, figure 5-11.

5-7. Equipment Performance Checklist- Continued

Step	Procedure	Normal indication	Remarks
14.	Move handset from J803 to J802 of the same control box.	AM-1780/VRC relays should click and sidetone should be heard.	If normal indications are not obtained, replace the control box.
15.	Set MONITOR switch to INT ONLY,		
16.	Key handset and talk into microphone, then unkey handset.		
17.	Repeat steps 11 through 16 for each crew-member's (not driver's) control box. Then go to step 18,	NOTE	Steps 18 through 31 are for the driver's control box only.
18.	Connect the handset to J803 or J903 (yellow band) of the driver's control box.	In the M-109 S.P. Howitzer, the circuit for driver's earphone is only complete when driver's C-2298 is in the ALL position, due to vehicle wiring.	
19.	Turn VOLUME control fully clockwise.		
20.	If driver's control box is C-2297/VRC, set the SIG-EXT-OFF switch to OFF.		
21.	One at a time, for each position of the MONITOR switch listed, key handset and talk into the microphone, then unkey the handset:	For each position of the MONITOR switch, relays in the AM-1780/VRC should click and sidetone should be heard.	<p>a. If in any position relays do not click and no sidetone is heard, refer to troubleshooting chart, figure 5-7.</p> <p>b. If in any position relays do not click but sidetone is heard, refer to troubleshooting chart, figure 5-12.</p> <p>c. If in all positions relays click but no sidetone is heard, refer to troubleshooting chart, figure 5-10,</p> <p>d. If in a particular position relays click but no sidetone is heard, refer to troubleshooting chart, figure 5-11.</p>
ALL	NOTE		
A	Sidetone will not be heard on positions A and B in M1 and M1A1 tanks.		
INT ONLY			
B			
22.	Move handset to J802 or J902.	AM-1780/VRC relays should click and sidetone should be heard,	If normal indications are not obtained, replace driver's control box,
23.	Set MONITOR switch to INT ONLY.		
24.	Key handset and talk into microphone, then unkey handset.		
25.	If driver's control box is a C-2298/VRC, the EPC is completed; if it is a C-2297/VRC, continue with step 26.	Lamp should not light.	If lamp lights, refer to troubleshooting chart, figure 5-13.
26.	Turn lens cover fully counterclockwise then 1/8 turn clockwise.		
27.	Set SIG-EXT-OFF switch to OFF.	Lamp should light, AM-1780/VRC relay should not click.	<p>a. If lamp does not light and AM-1780/VRC circuit breaker does not trip, lamp or lamp circuit is bad.</p> <p>b. If lamp does not light and AM-1780/VRC circuit breaker trips, refer to troubleshooting chart, figure 5-14,</p> <p>c. If lamp lights but AM-1780/VRC relays click, refer to troubleshooting chart, figure 5-13.</p>
28.	Set SIG-EXT-OFF switch to EXT,		
29.	Set SIG-EXT-OFF switch to SIG.	Lamp should light.	If lamp does not light, refer to troubleshooting chart, figure 5-15.
30.	Return SIG-EXT-OFF switch to EXT.		
31.	Set MONITOR switch to ALL.		
32.	Turn C-2296/VRC volume control fully clockwise.		
33.	C-2296/VRC RAD TRANS-INT switch should be in INT (spring held).	AM-1780/VRC relays should click and sidetone should be heard.	<p>If switch is in RAD TRANS, the switch should be replaced at higher maintenance.</p> <p>a. If relays do not click, refer to troubleshooting chart, figure 5-16.</p> <p>b. If relays click but no sidetone is heard, refer to troubleshooting chart, figure 5-17.</p>
34.	Key handset, H-207, and talk into its microphone,		

5-8. Using the Troubleshooting Flow Charts

a. Entry. The troubleshooting flow charts are entered from the equipment performance checklist (EPC). Based on the abnormal indication observed, use the appropriate chart.

b. Special Symbols. The special symbols listed below are used throughout the troubleshooting flow charts.

- (1) W for Ohms (resistance).
- (2) > for greater than.
- (3) < for less than.
- (4) ∞ for infinity (a number too large to write).
- (5) C/B control box.

c. Instructions. The instructions listed below apply to the use of the troubleshooting flow charts.

(1) Unless otherwise stated, all voltage measurements, resistance measurements, and circuit disturbance checks are made with respect to chassis ground (bare metal).

(2) To circuit disturb, set the multimeter up as an ohmmeter, RX 10, connect the negative lead to chassis ground (bare metal), and touch the point with the positive lead. A click should be heard.

(3) To measure the ac talk signal, set the multimeter up as an ac multimeter (lowest range), connect the negative lead to chassis ground, connect the positive lead to the test point, key the mike and note the reading. Next, sharply whistle into the mike and look to see if the meter reading changes. An increase in the ac voltage reading indicates the presence of the talk signal.

(4) Observe all WARNINGS and CAUTIONS as they appear throughout the flow charts.

WARNING

To guard against electrical shock, remove or tape all exposed personal objects.

CAUTION

To guard against equipment damage when making measurements or circuit disturbing with power applied, make sure the proper pin is selected and the meter leads do not touch.

d. How to Use a Flow Chart. After selecting a flow chart, as indicated in the equipment performance check, proceed as follows:

- (1) Do the actions described in the first rectangle.
- (2) Answer the YES or NO question asked in the diamond that follows the first rectangle.
- (3) Go to the next step as directed by the answer to the YES/NO question.
- (4) Do additional steps as required and directed until the bad item of equipment is found and then follow the repair instructions presented in that box.
- (5) Repeat the operational check, or portion of it, after each repair is completed.

NOTE

Troubleshooting flow charts pertain to the AN/VIC-1 only, per the MAC. For application with radios refer to the appropriate TM.

5-9. Troubleshooting Flow Charts

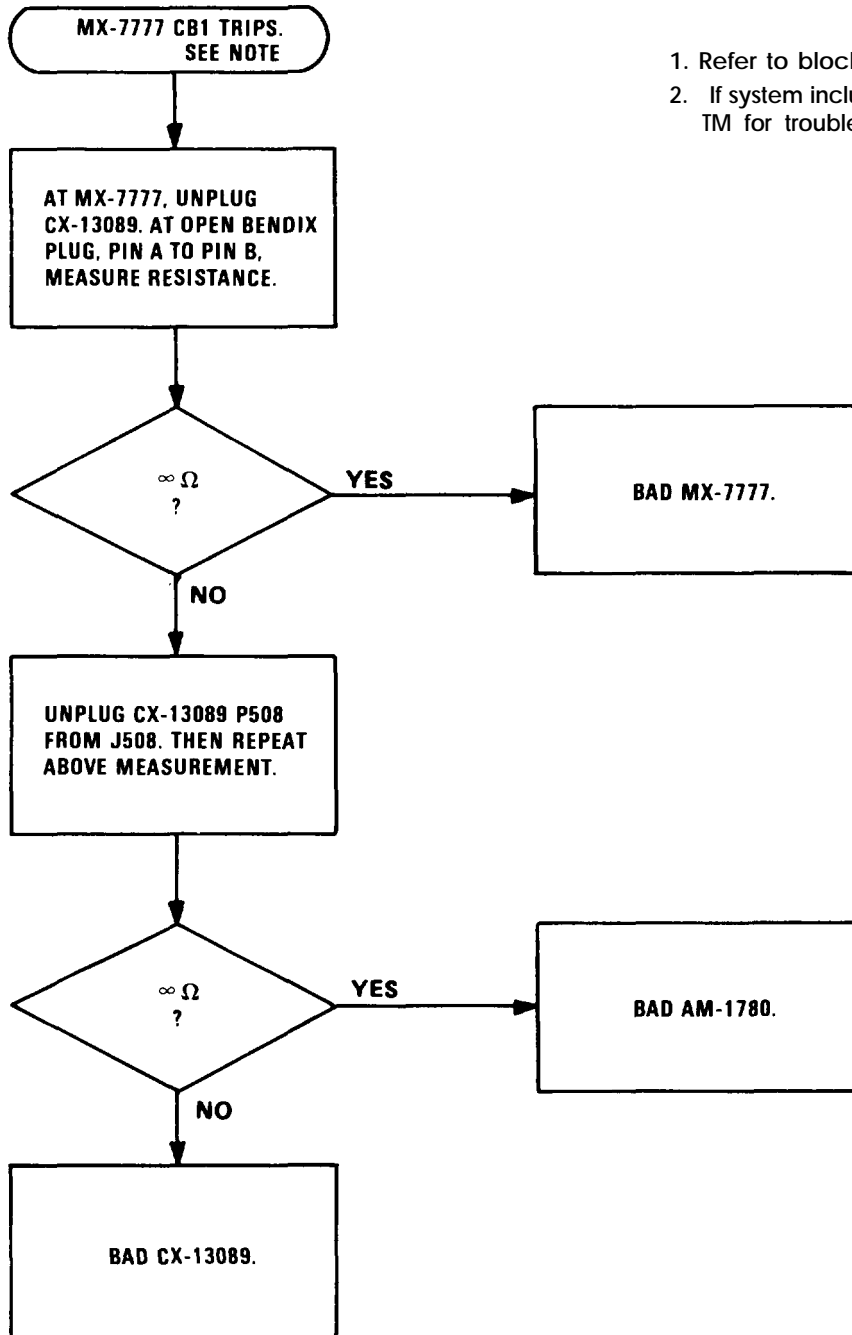

NOTE:

1. Refer to block diagram ①, page 5-9.
2. If system includes radios, refer to the radio TM for troubleshooting procedures.

EL2DT031

Figure 5-3. Troubleshooting intercom input power, adverse short.

5-9. Troubleshooting Flow Charts - continued

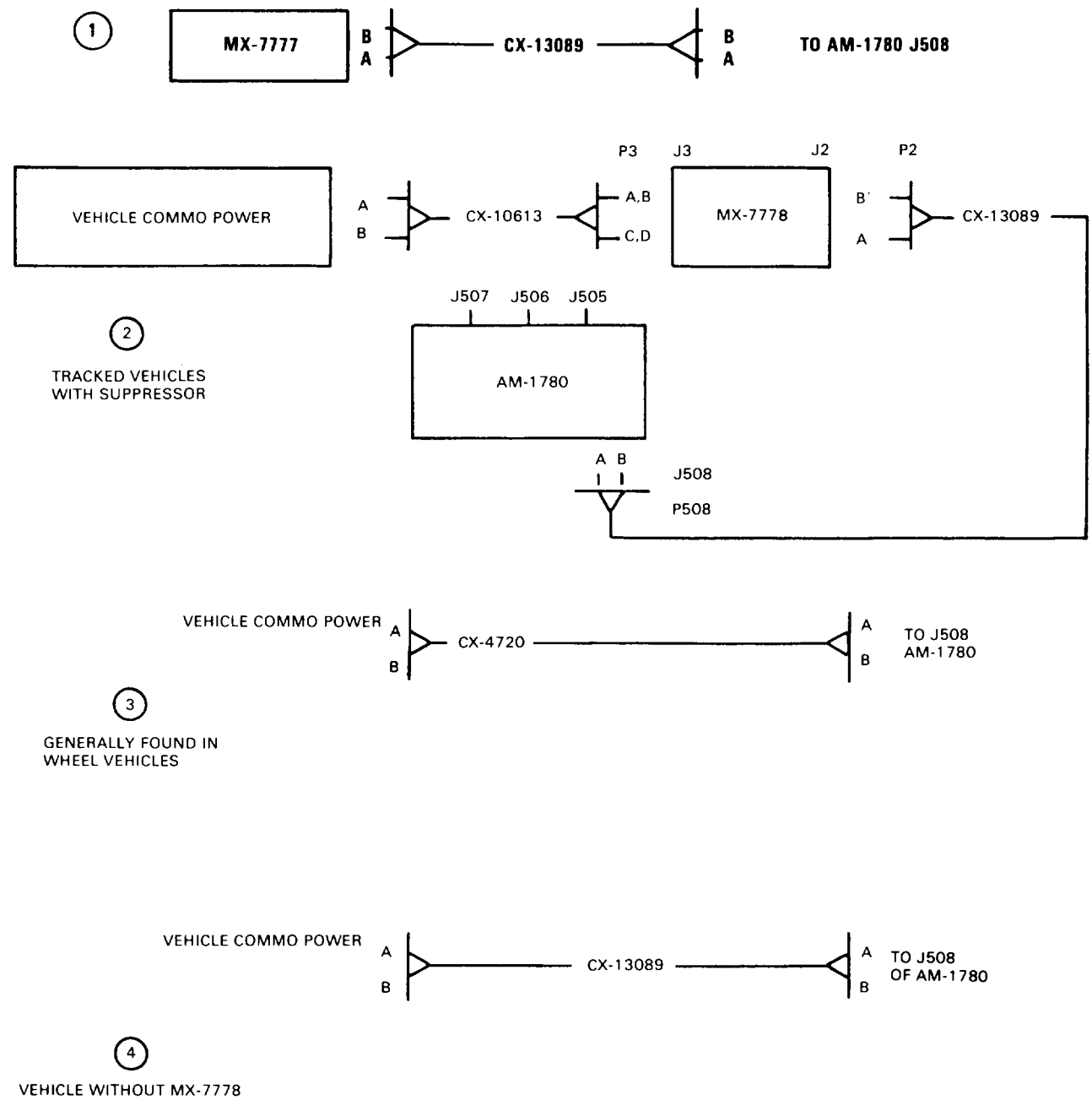
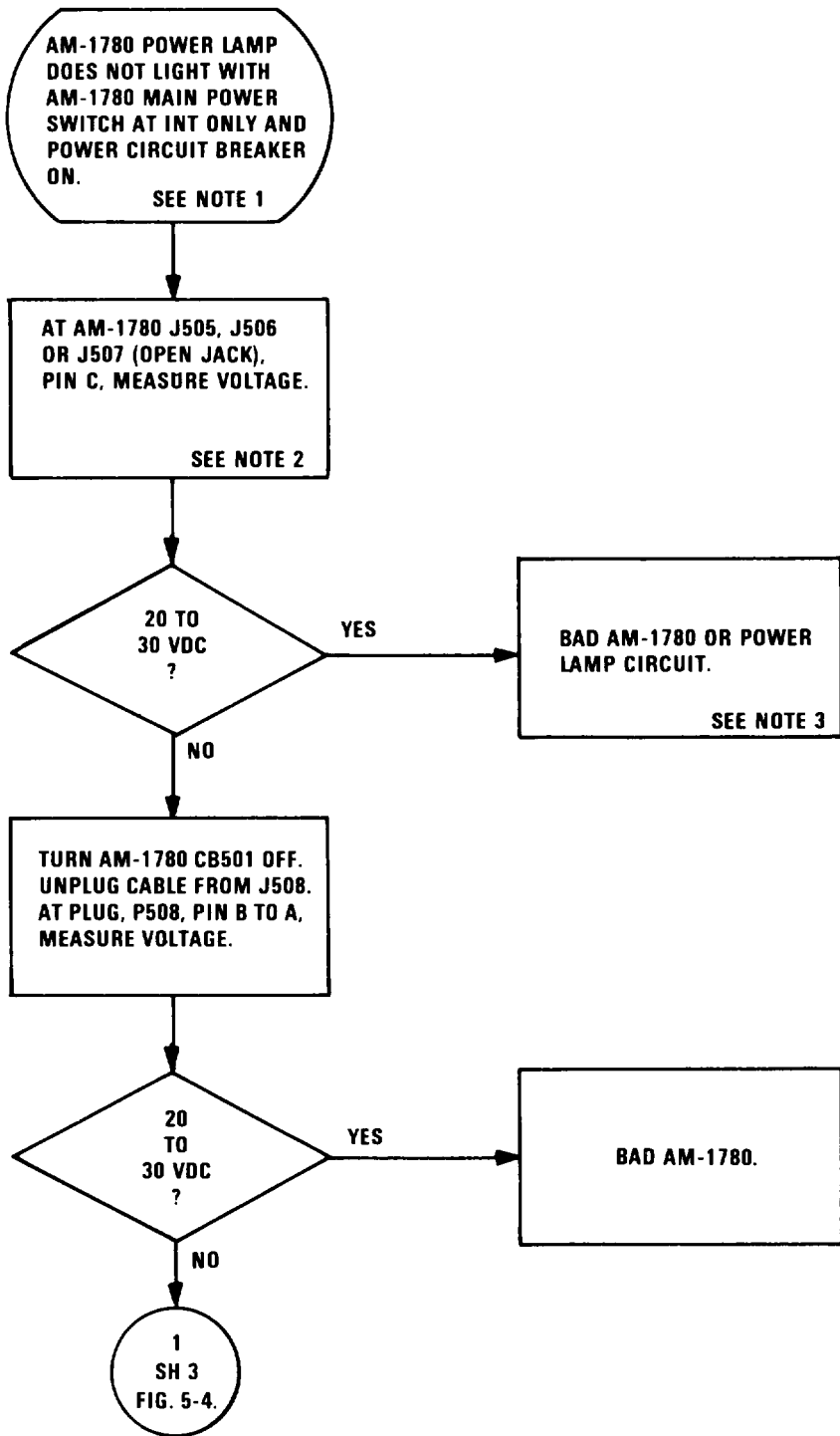

Figure 5-4. Troubleshooting intercom block diagram (Sheet 1 of 3).

5-9. Troubleshooting Flow Charts- Continued



NOTES:

1. Refer to block diagrams ②③④.
2. If jacks are filled, remove one plug to make test then replace it.
3. Fix or replace and return to operational check at this time.

EL2DT033

Figure 5-4. Troubleshooting intercom input power, adverse open (Sheet 2 of 3)

5-9. Troubleshooting Flow Charts - Continued

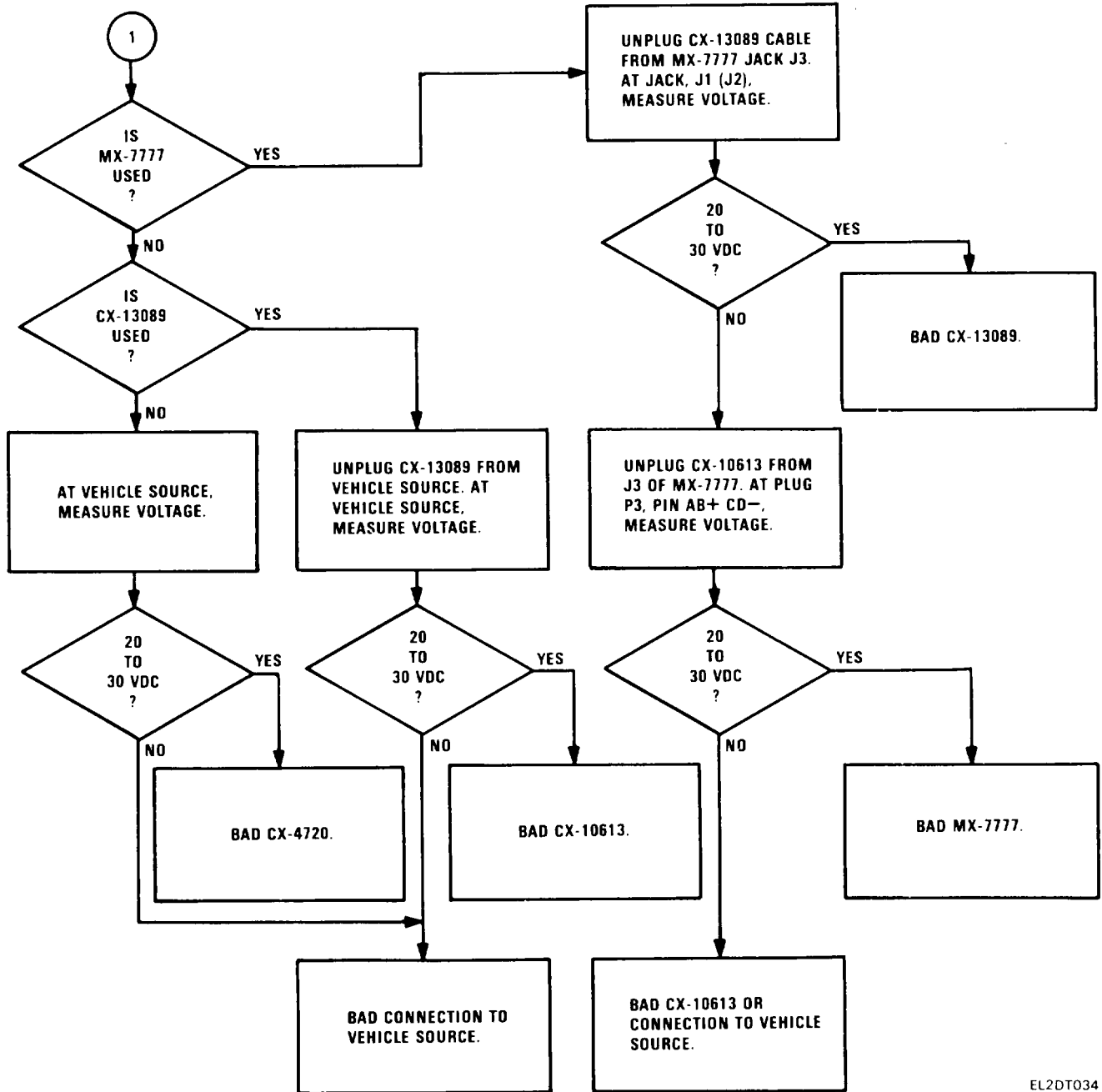

EL2DT034

Figure 5-4. Troubleshooting intercom input power, adverse open (Sheet 3 of 3).

5-9. Troubleshooting Flow Charts - continued

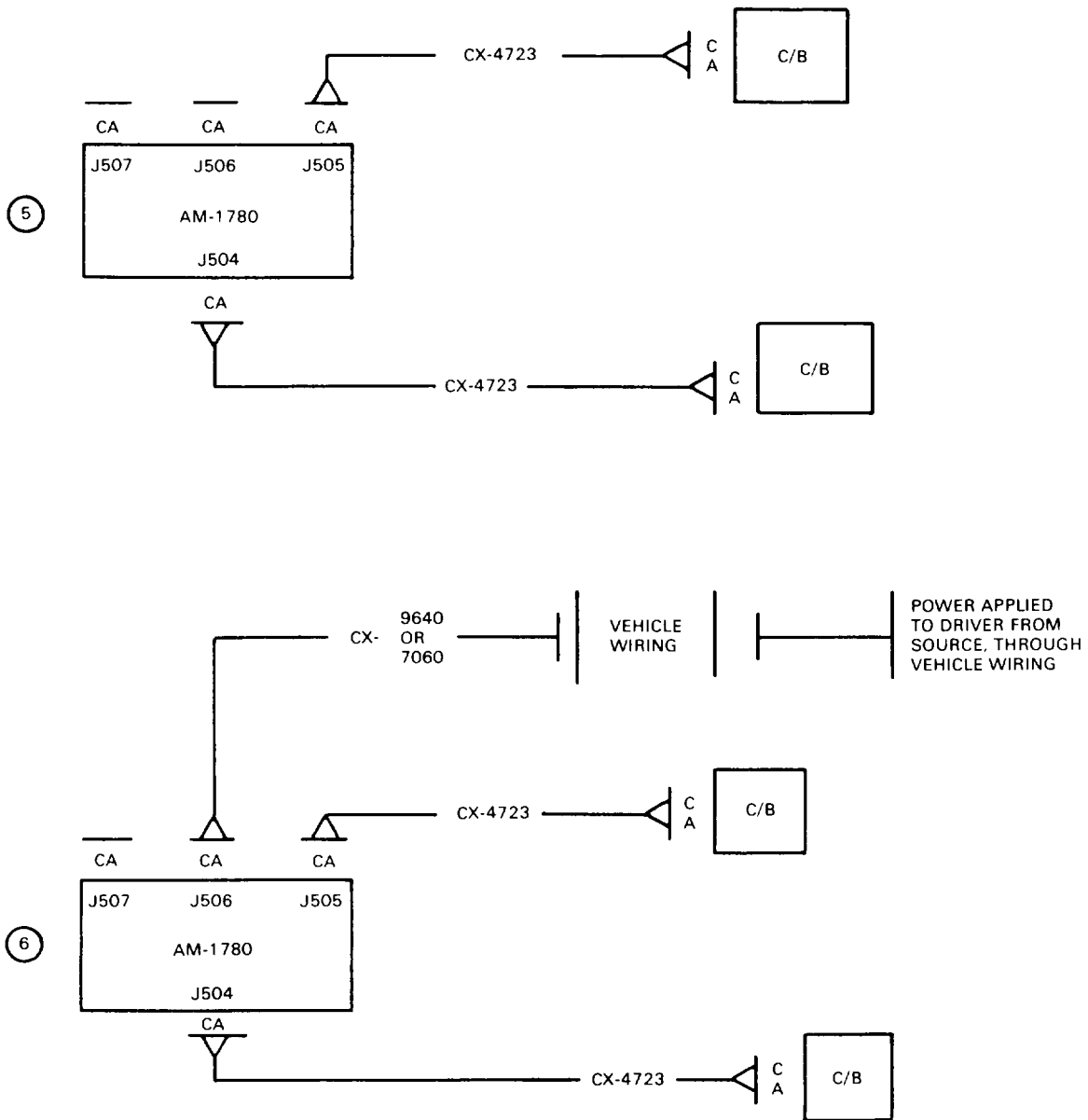

EL2DT035

Figure 5-5. Troubleshooting intercom power distribution, block diagram (Sheet 1 of 2).

5-9. Troubleshooting Flow Charts - Continued

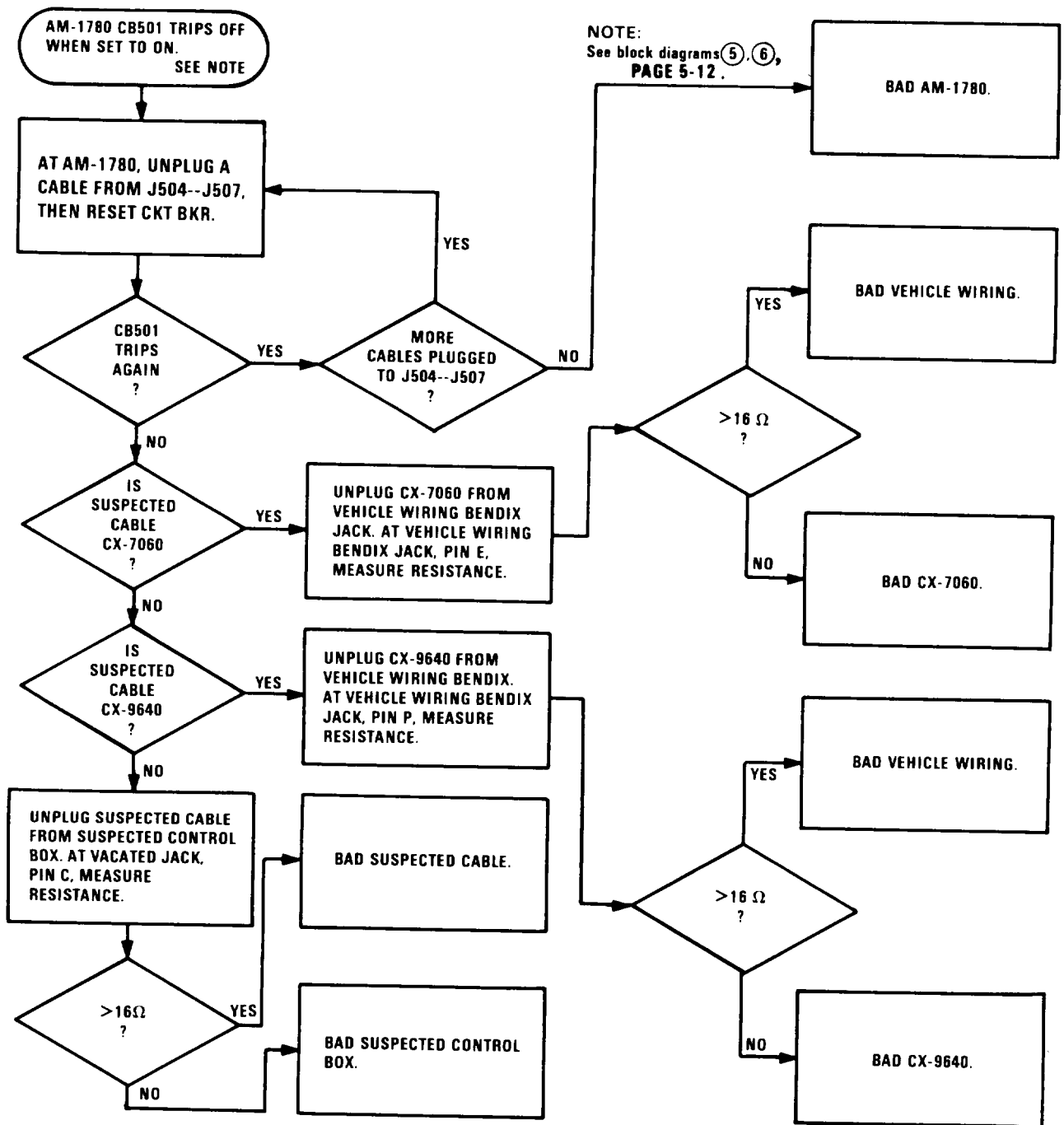

EL2DT036

Figure 5-5, Troubleshooting intercom power distribution (Sheet 2 of 2).

5-9. Troubleshooting Flow Charts - continued

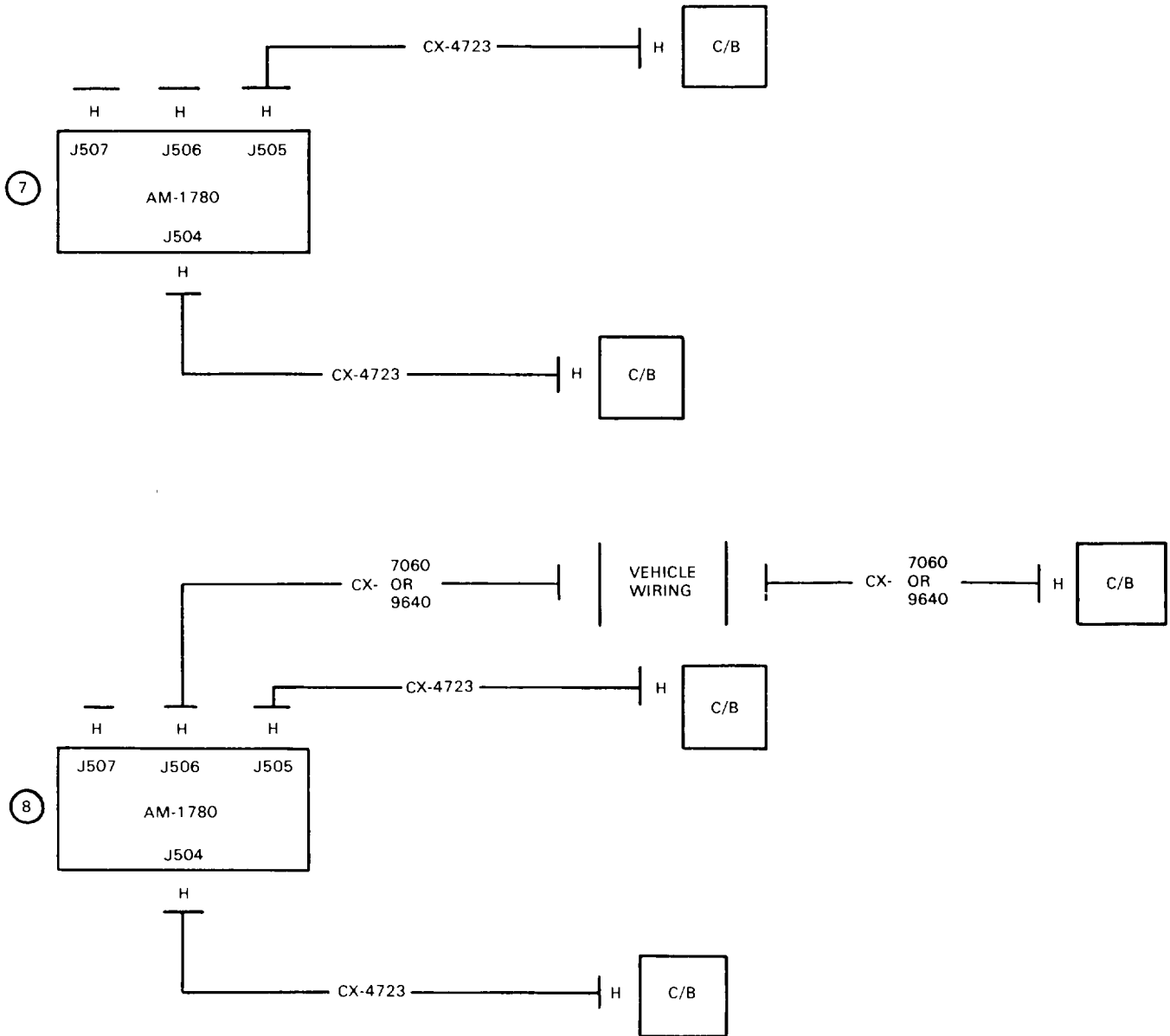

Figure 5-6. Troubleshooting intercom keying circuits, block diagram.

EL2DT037

5-9. Troubleshooting Flow Charts - Continued

NOTE:

Refer to block diagrams ⑦, ⑧

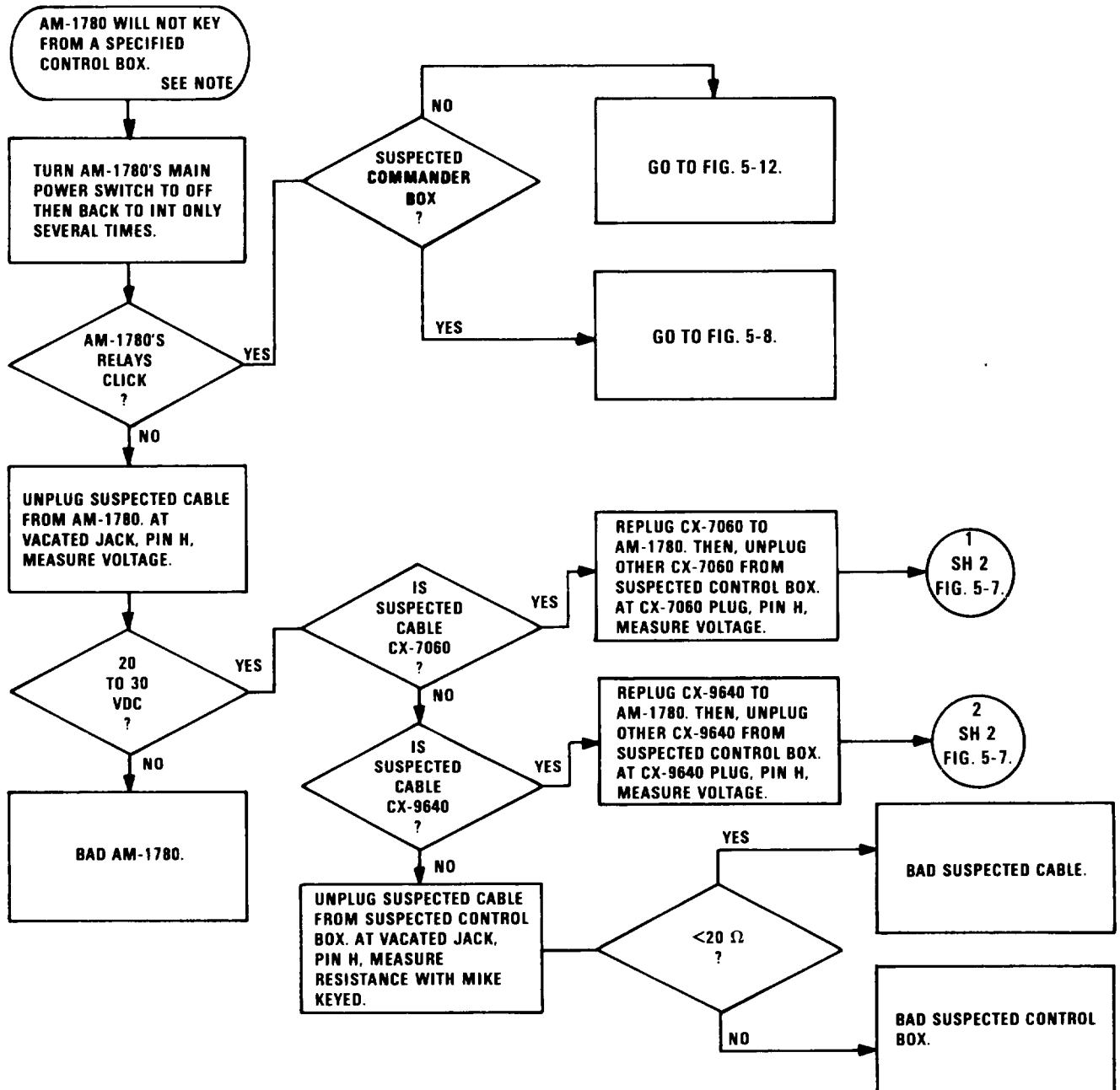

EL2DT038

Figure 5-7. Troubleshooting intercom keying circuits, adverse open (Sheet 1 of 2)

5-9. Troubleshooting Flow Charts - Continued

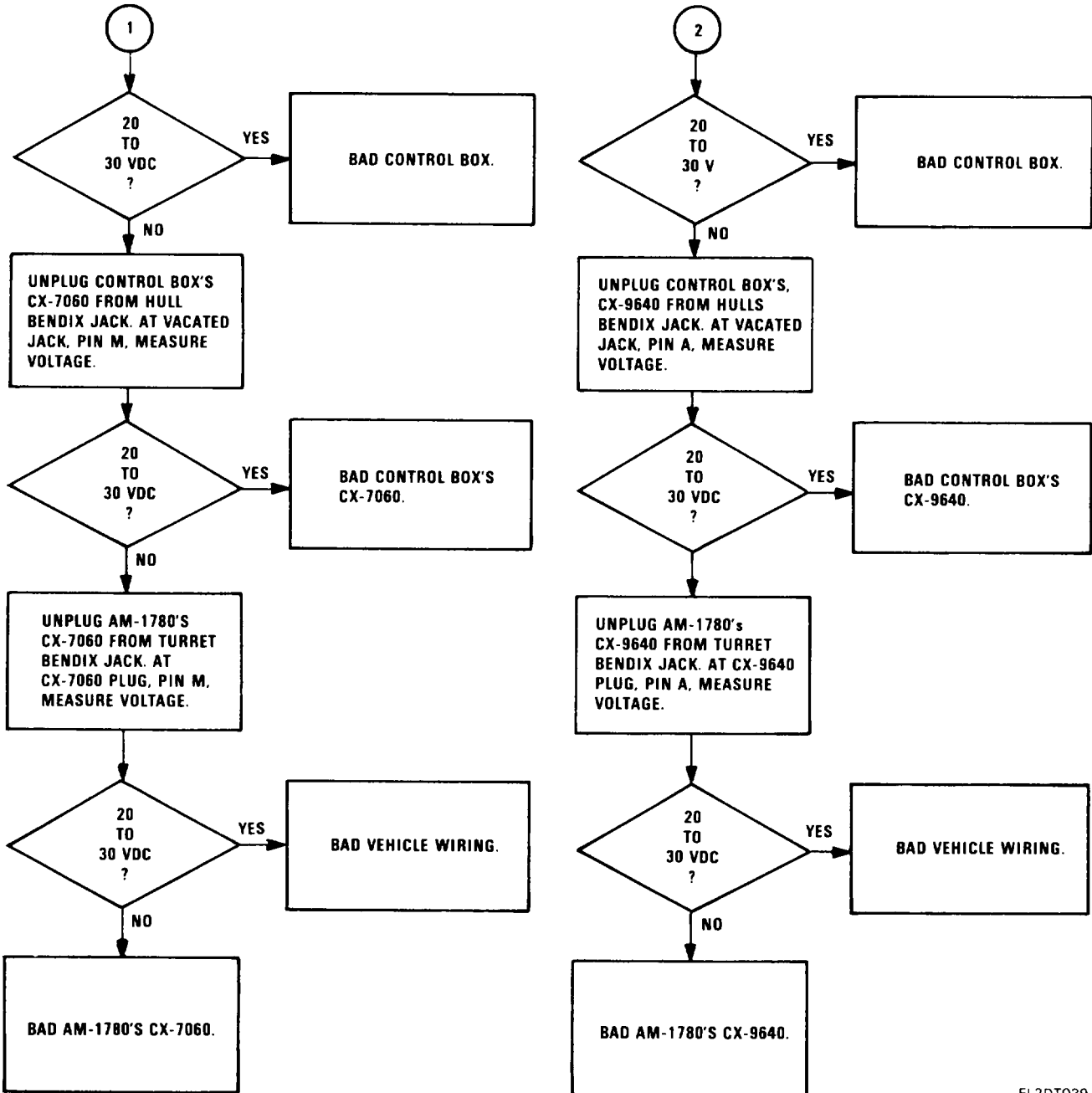

EL2DT039

Figure 5-7 Troubleshooting intercom keying circuits, adverse open (Sheet 2 of 2).

5-9. Troubleshooting Flow Charts- continued

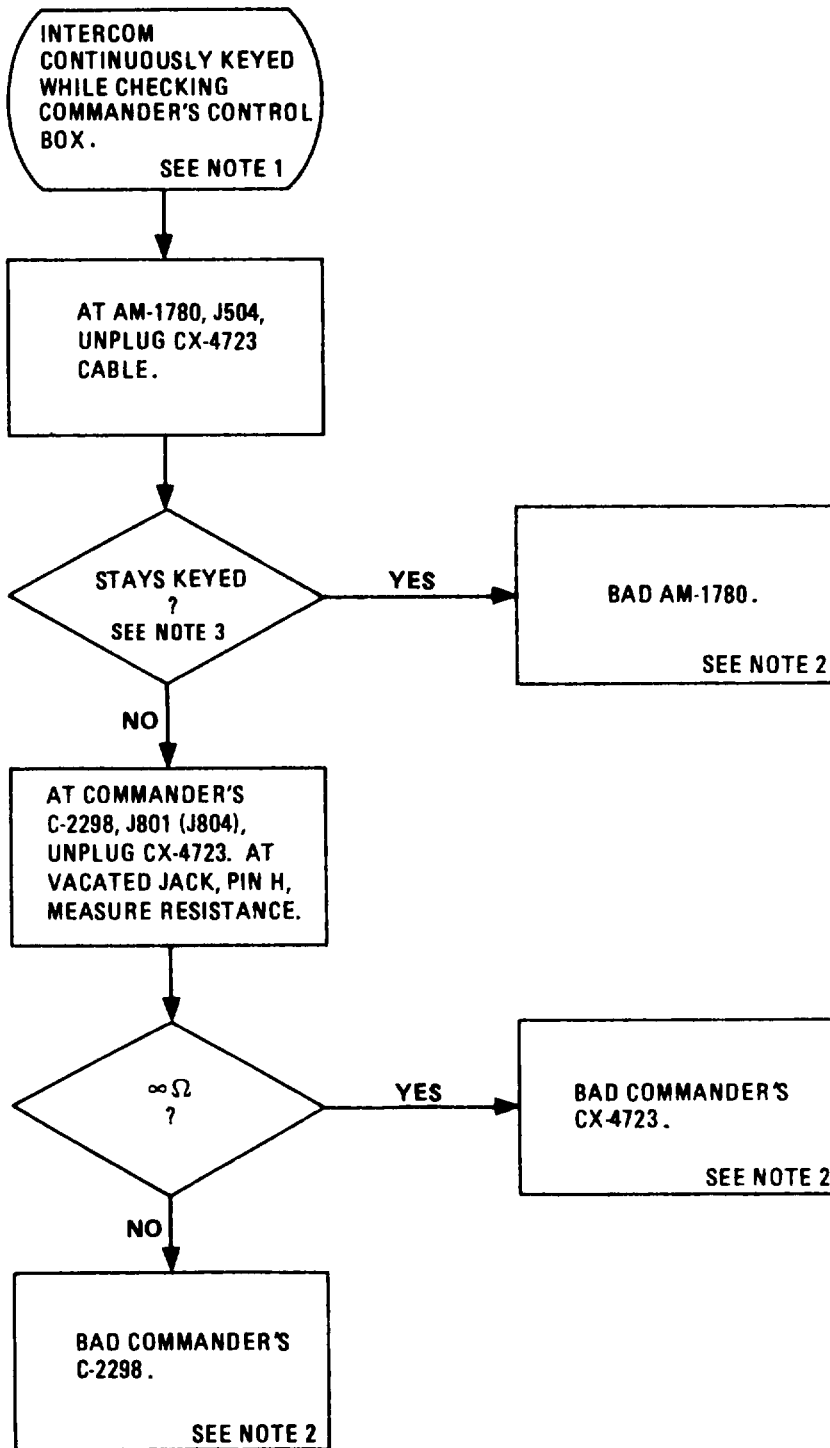

NOTES :

1. Refer to block diagrams ⑦ ⑧ , page 5-14.
2. Fix or replace and return to operational check at this time.
3. Turn AM-1780 Main Power Switch to OFF if relay clicks. AM-1780 continuous key if relay does not click AM-1780 not keyed.

EL2DT040

Figure 5-8. Troubleshooting intercom keying circuits, adverse short.

5-9. Troubleshooting Flow Charts- Continued

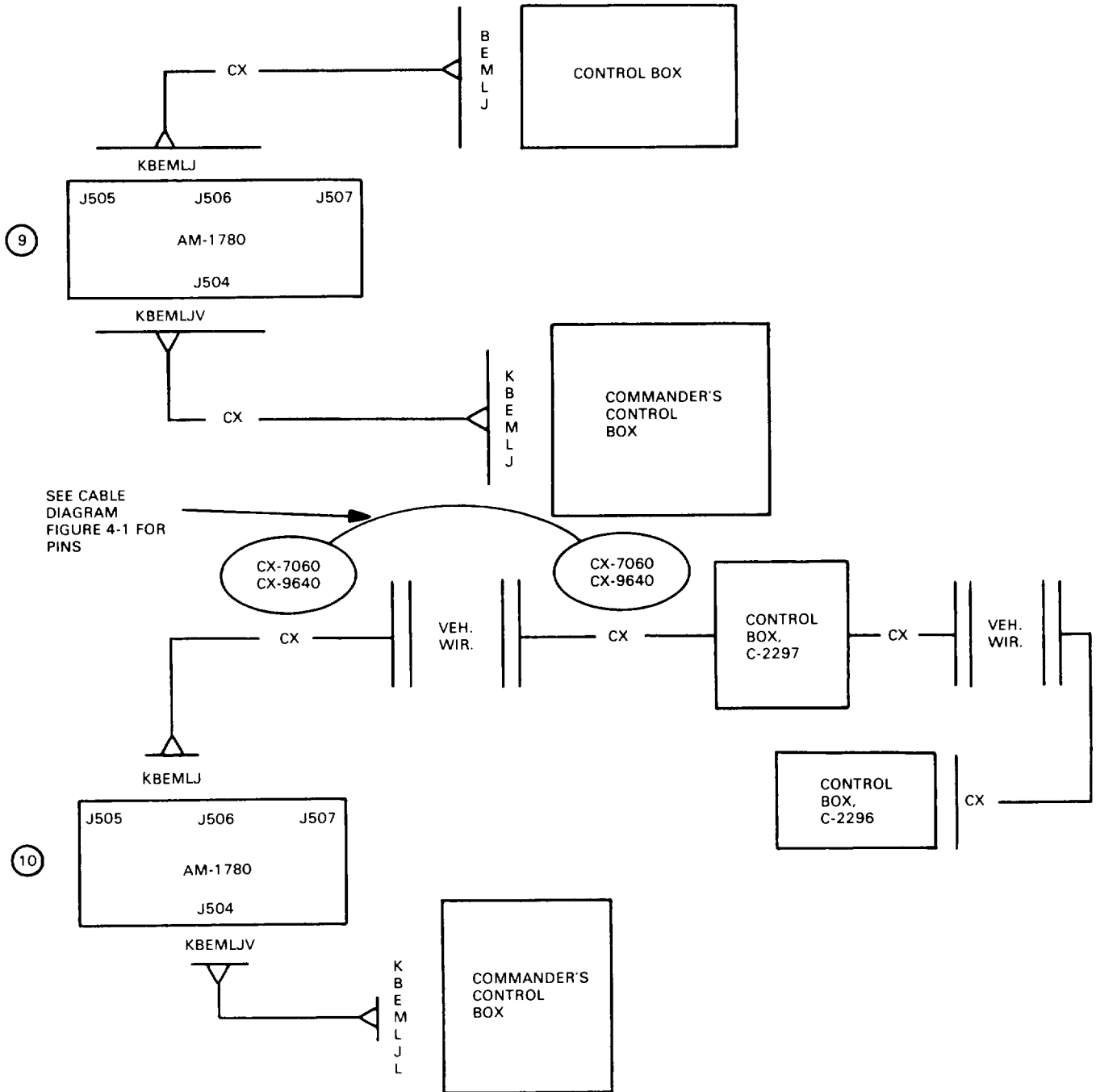

EL2DT041

Figure 5-9. Troubleshooting intercom talk/listen circuits, block diagram.

5-9. Troubleshooting Flow Charts - Continued

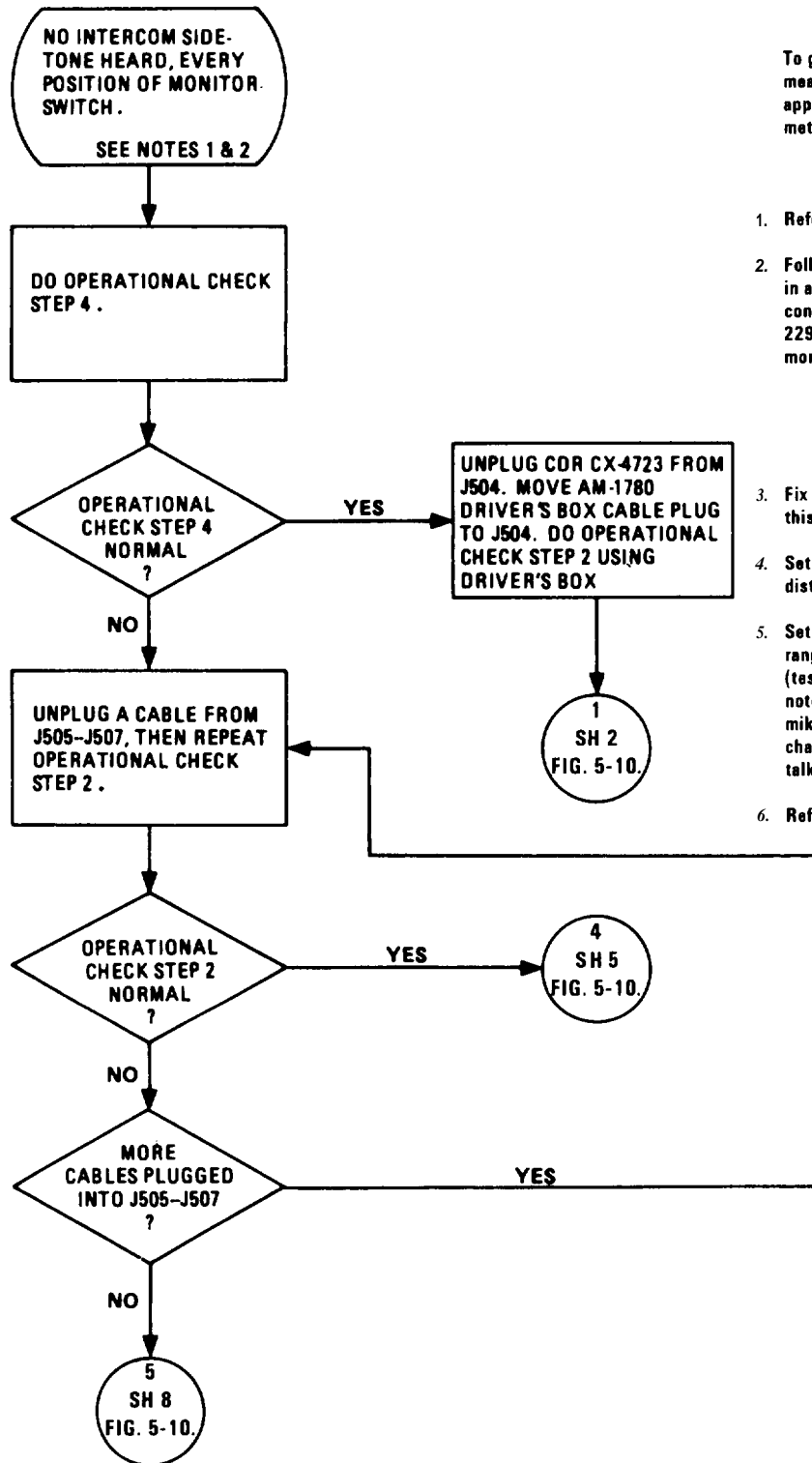

CAUTION

To guard against equipment damage when making measurements or circuit disturb with power applied, make sure proper pin is selected and meter probes do not touch together.

NOTES:

1. Refer to block diagrams ⑨ ⑩
2. Follow this flow chart in sequence for no sidetone in any position of monitor switch on commander's control box. For other control boxes (except C-2296) with no sidetones in any position of the monitor switch, enter flow chart at point 5 SH 8 FIG. 5-10.
3. Fix or replace and return to operational check at this time.
4. Set up multimeter as an ohmmeter to do circuit disturb, RX10.
5. Set up multimeter as an AC voltmeter (lowest range). Connect meter probes between signal line (test point) and chassis ground, then key mike and note reading. Next, sharply whistle into keyed mike and see if the meter reading changes. Any change in AC voltage indicates the presence of the talk signal. (Reading is < 1 volt.)
6. Refer to higher maintenance level.

EL2DT042

Figure 5-10. Troubleshooting intercom talk/listen circuits, adverse for all positions of MONITOR switch (Sheet 1 of 26).

5-9. Troubleshooting Flow Charts - Continued

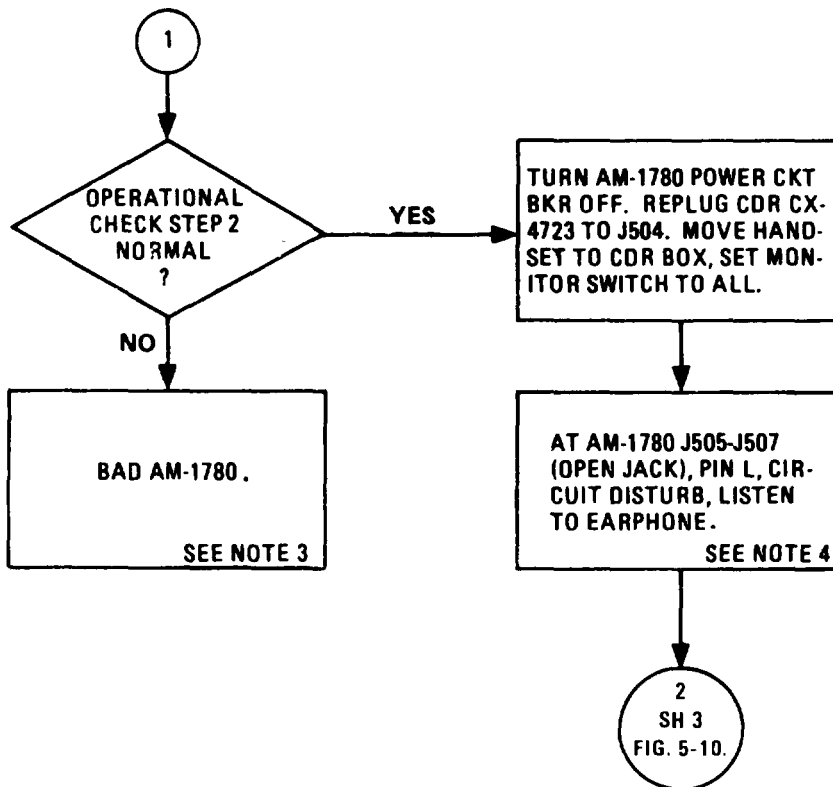

EL2DT043

Figure 5-10. Troubleshooting intercom talk/listen circuits, adverse for all positions of MONITOR switch (sheet 2 of 26).

5-9. Troubleshooting Flow Charts - Continued

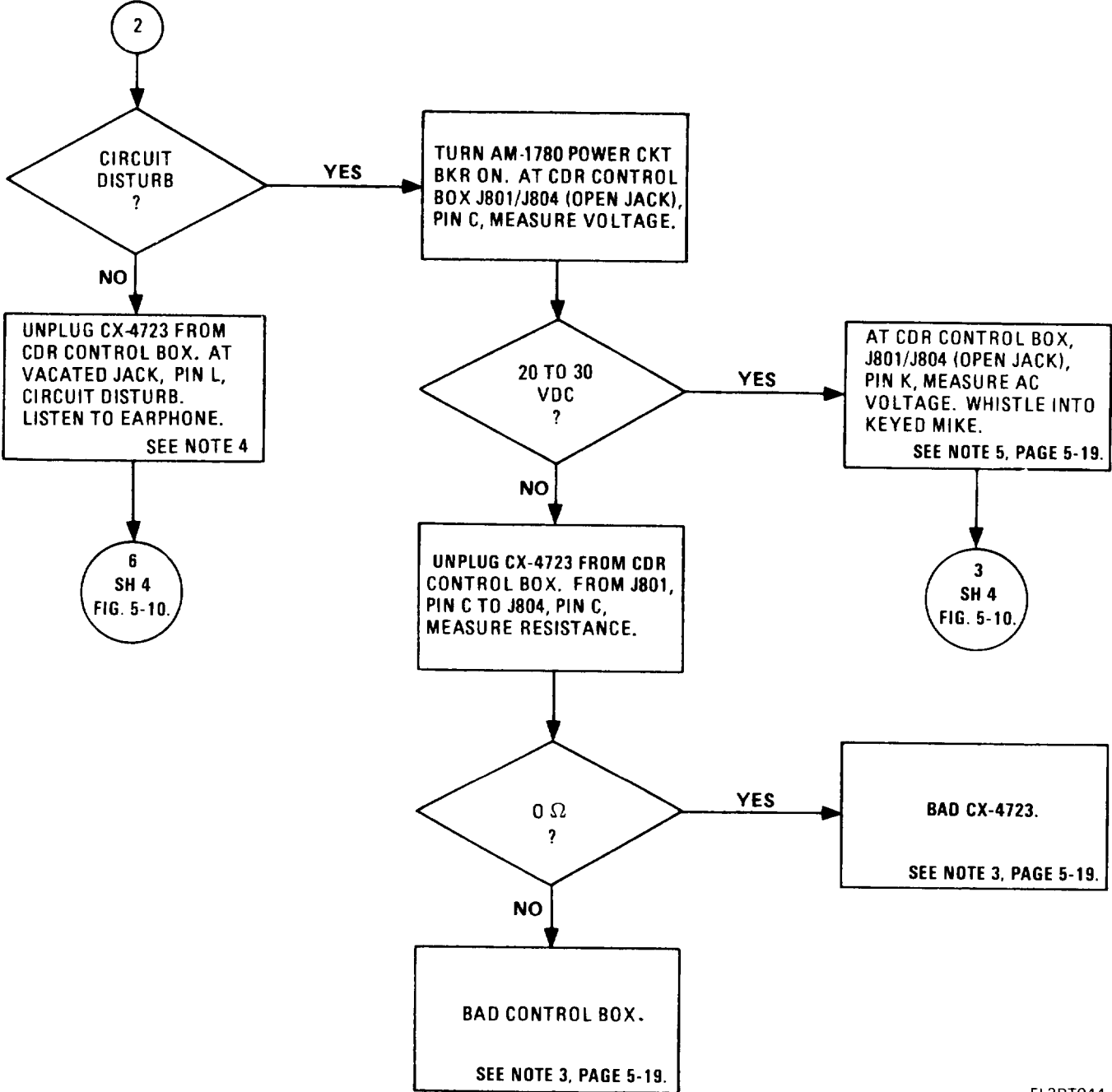

EL2DT044

Figure 5-10. Troubleshooting intercom talk/listen circuits, adverse for all positions of MONITOR switch (Sheet 3 of 26).

5-9. Troubleshooting Flow Charts- continued

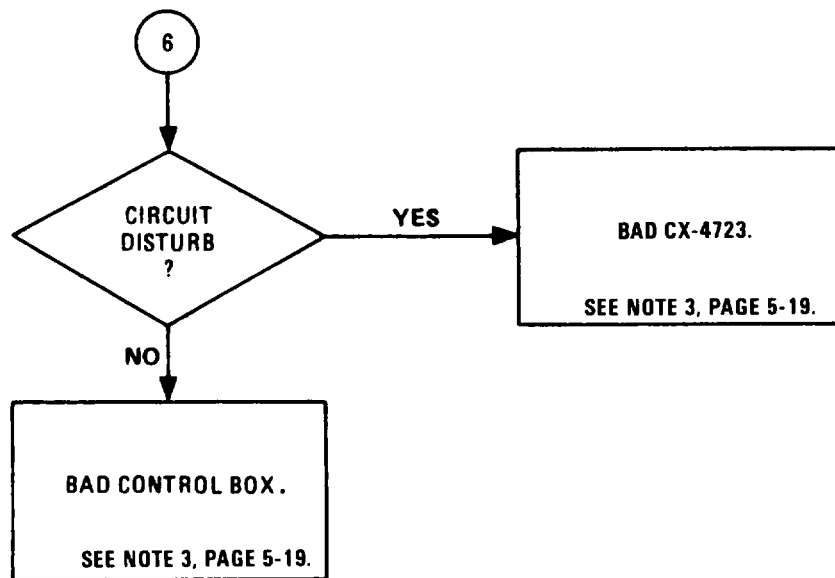
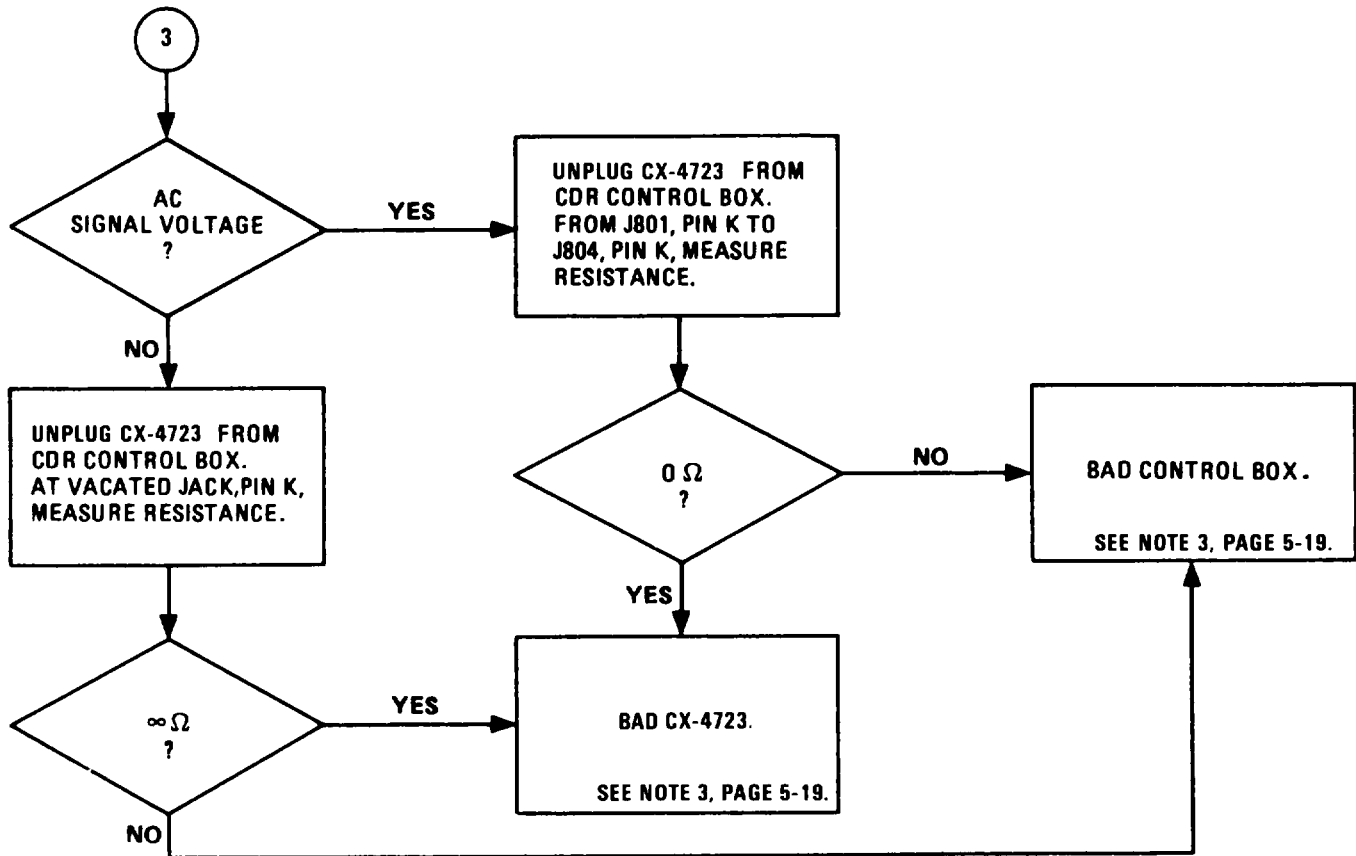

EL2DT045

Figure 5-10. Troubleshooting intercom talk/listen circuits, adverse for all positions of MONITOR switch (Sheet 4 of 26).

5-9. Troubleshooting Flow Charts - continued

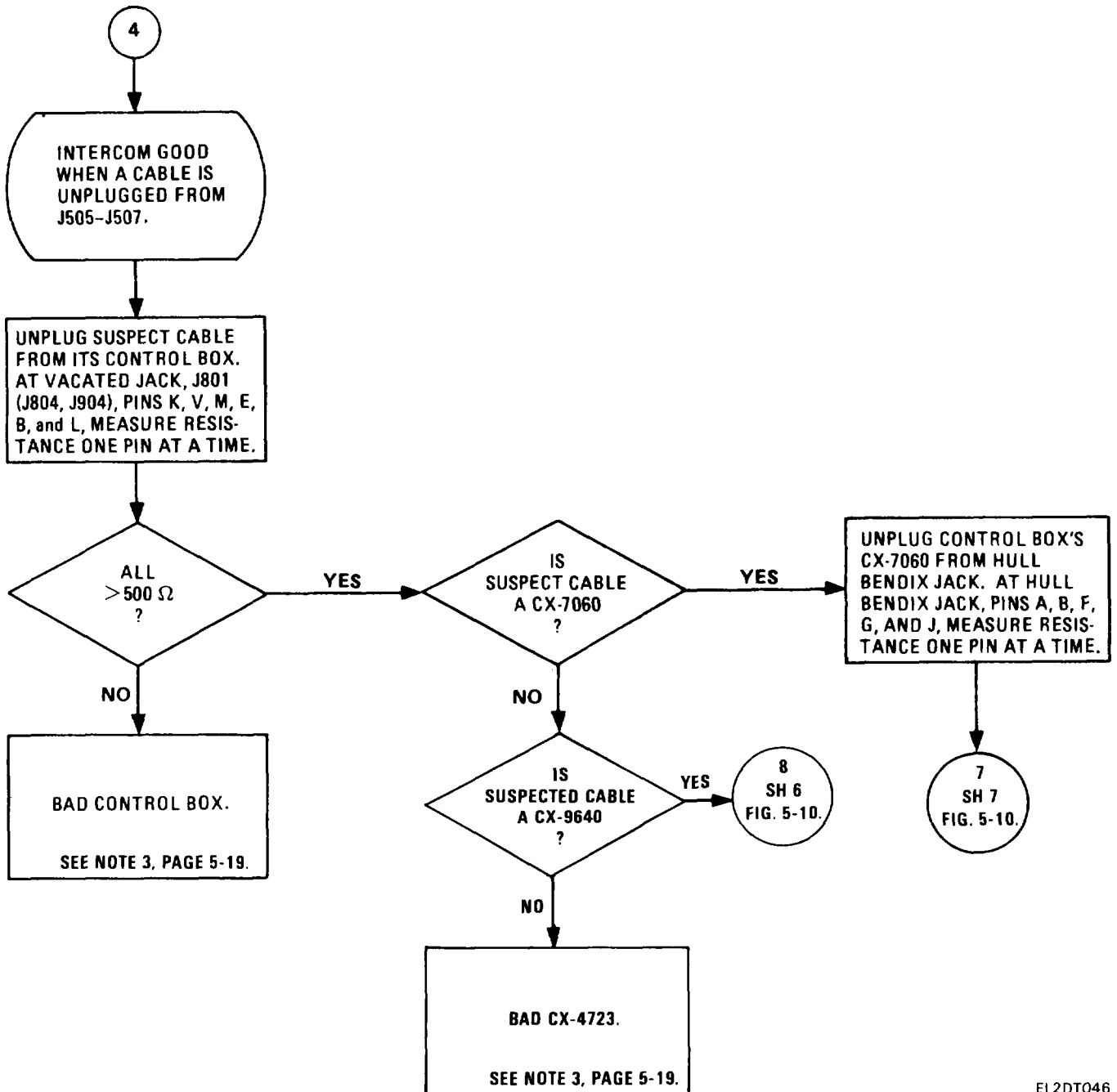

EL2DT046

Figure 5-10. Troubleshooting intercom talk/isten circuits, adverse for all positions of MONITOR switch (Sheet 5 of 26).

5-9. Troubleshooting Flow charts - Continued

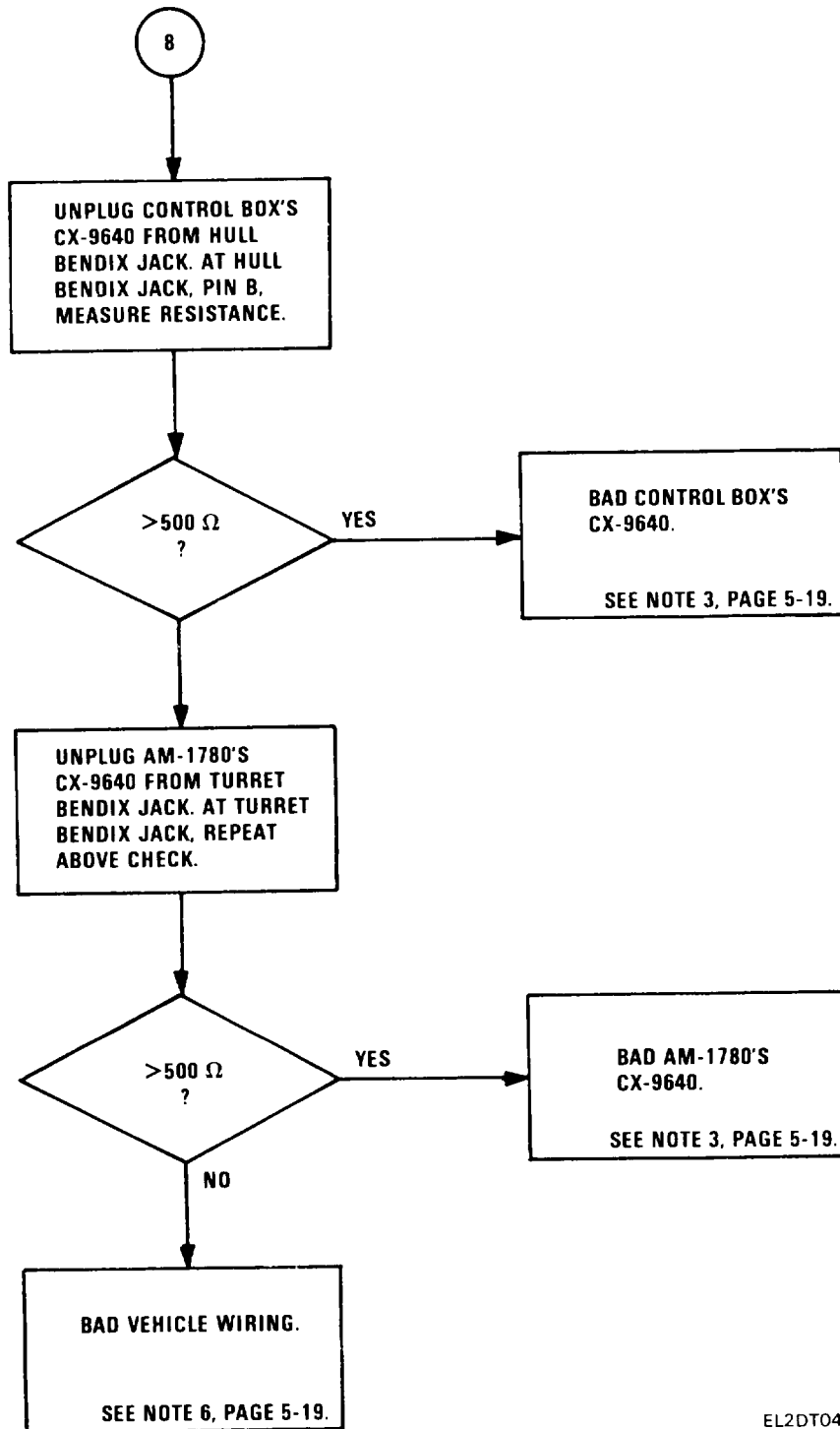

EL2DT047

Figure 5-10. Troubleshooting intercom talk/listen circuits, adverse for all positions of MONITOR switch (Sheet 6 of 26).

5-9. Troubleshooting Flow Charts - Continued

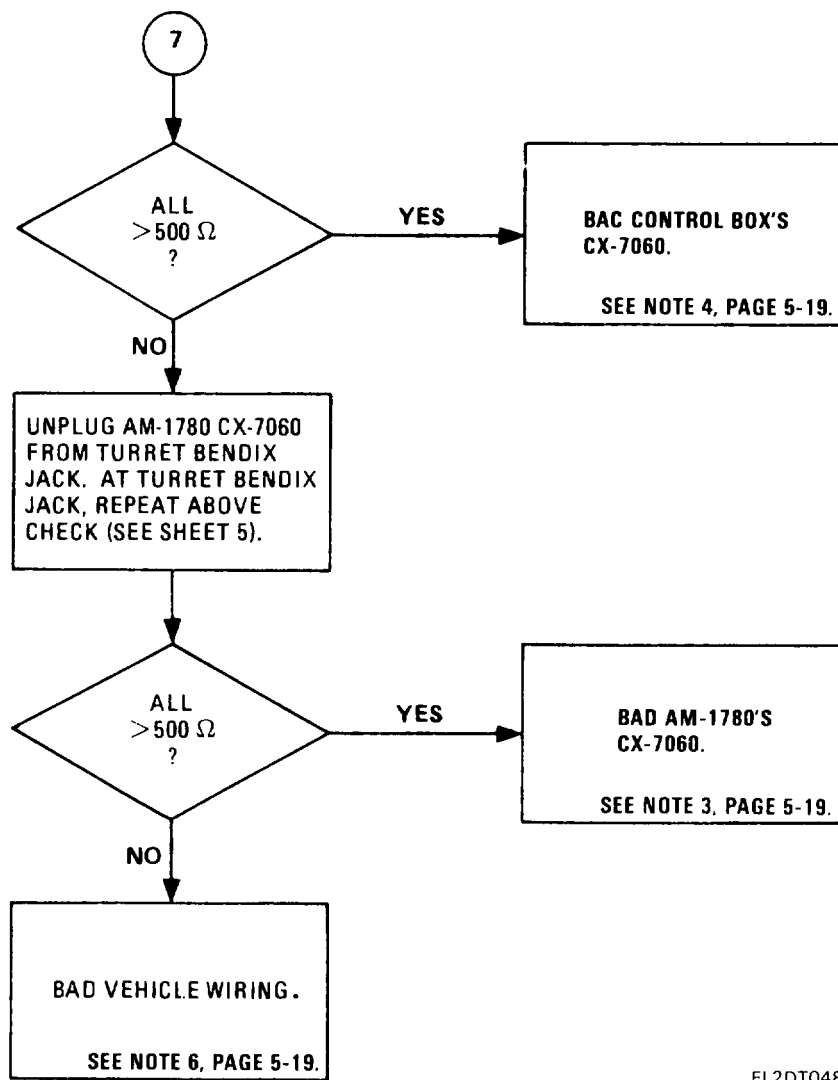

EL2DT048

Figure 5-10. Troubleshooting intercom talk/listen circuits, adverse for all positions of MONITOR switch (Sheet 7 of 26).

5-9. Troubleshooting Flow Charts- Continued

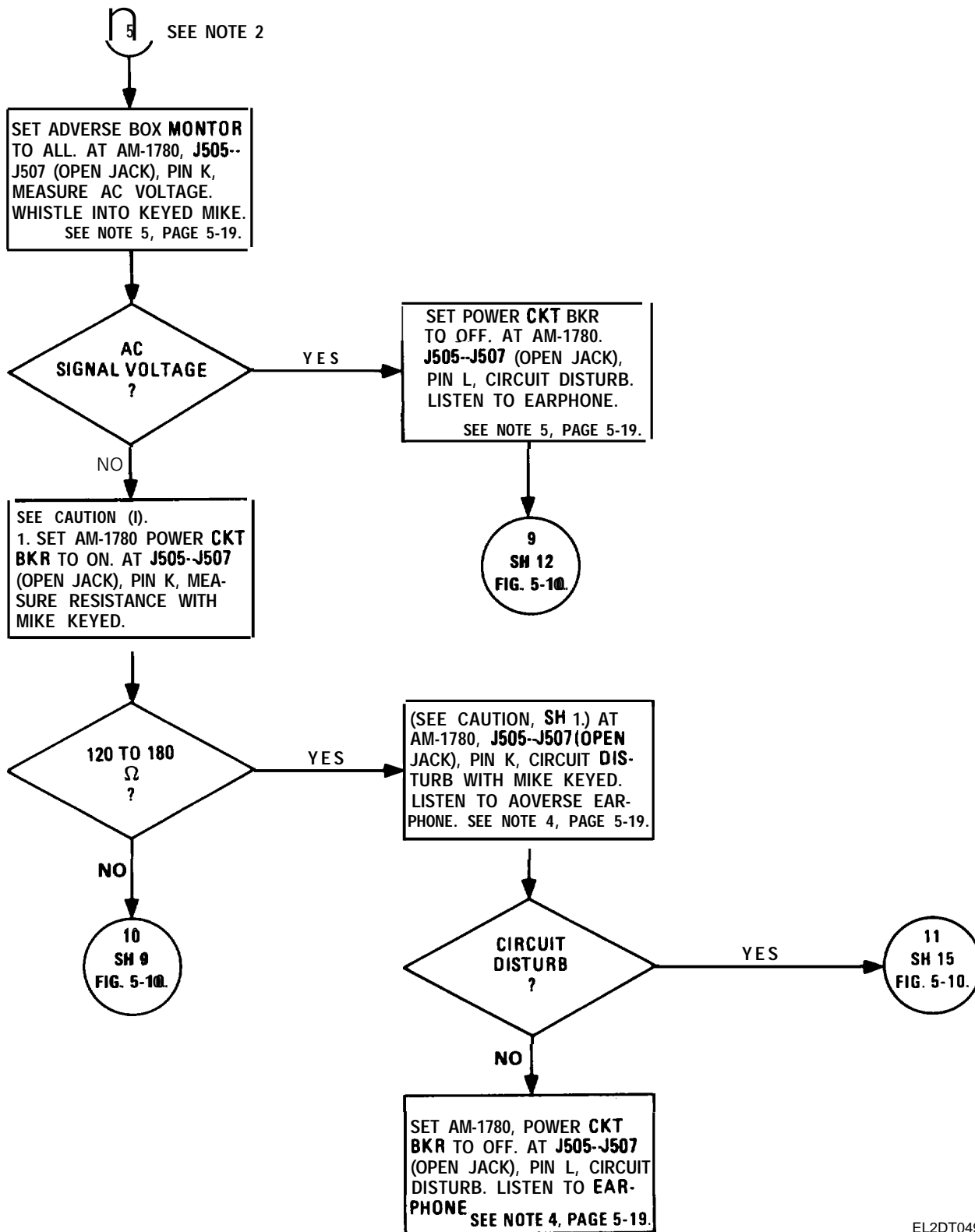

EL2DT049

Figure 5-10. Troubleshooting intercom talk/listen circuits, adverse for all positions of MONITOR switch (Sheet 8 of 26).

5-9. Troubleshooting Flow Charts - Continued

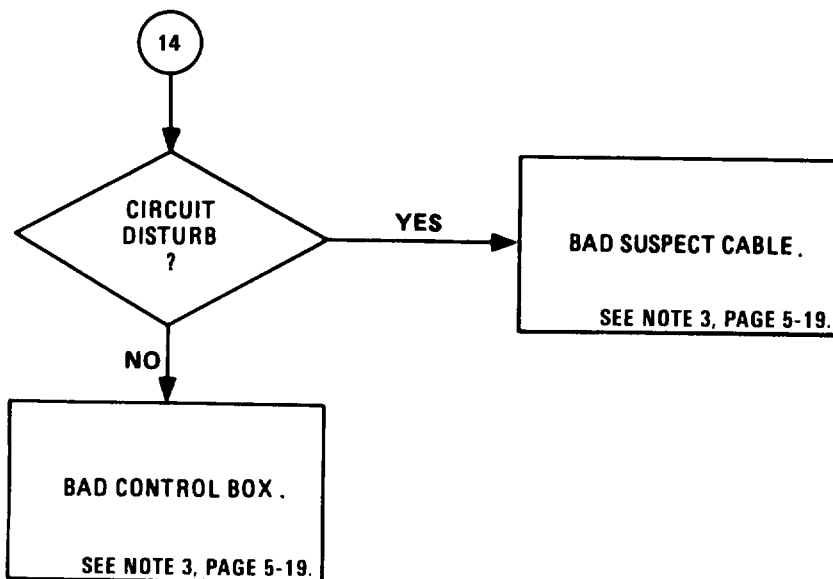
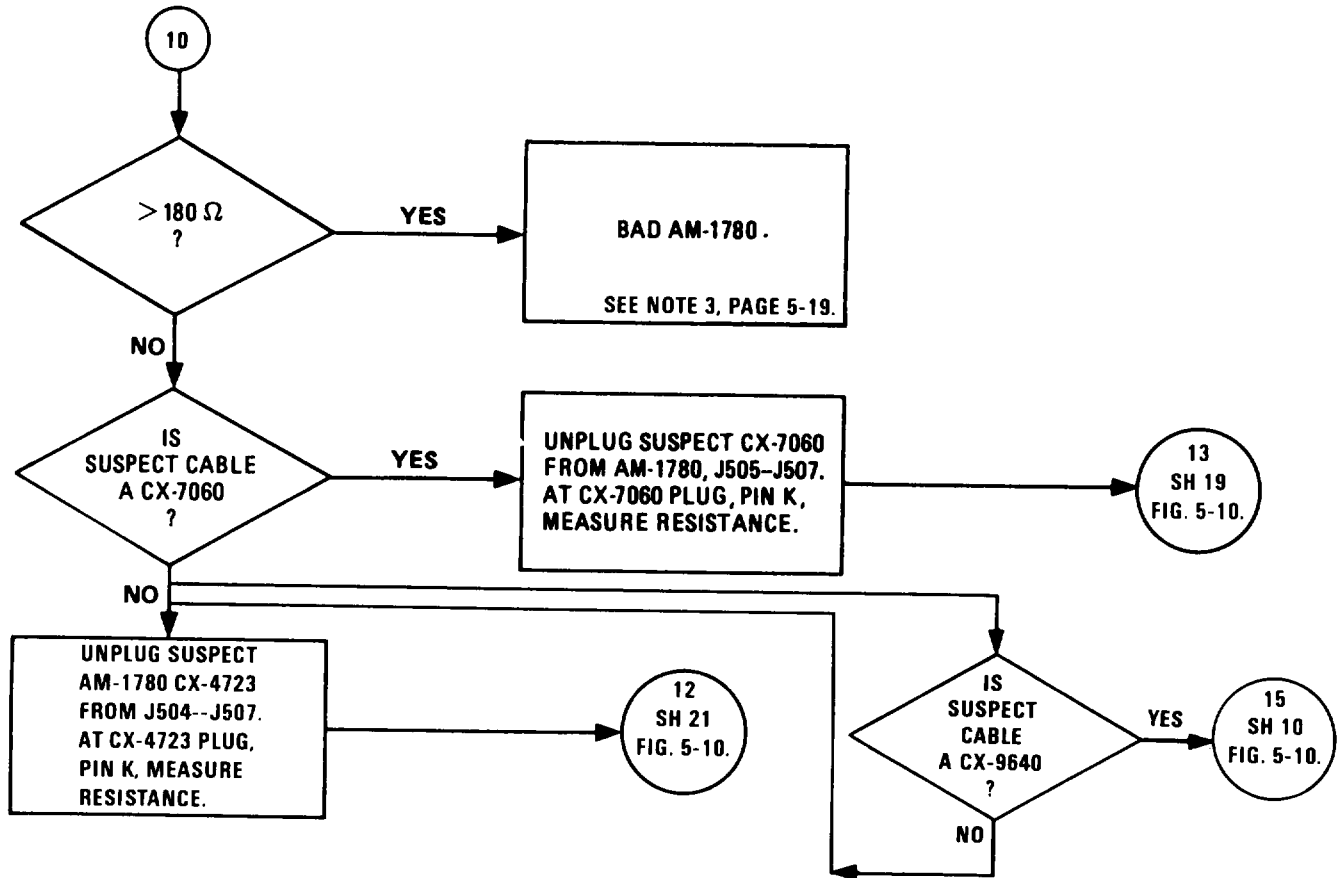

EL2DT050

Figure 5-10. Troubleshooting intercom talk/listen circuits, adverse for all positions of MONITOR switch (Sheet 9 of 26).

5-9. Troubleshooting Flow Charts - Continued

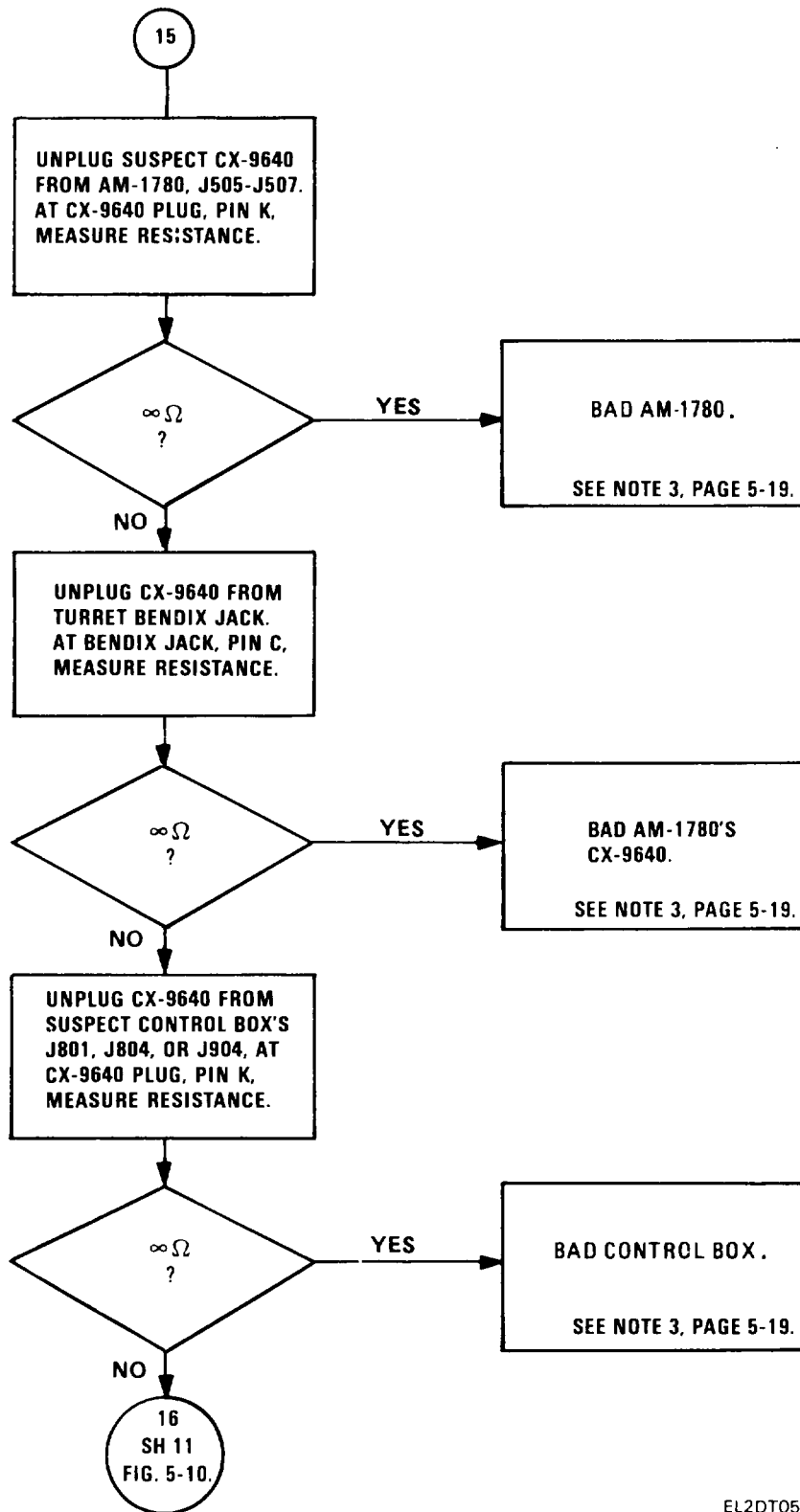

EL2DT051

Figure 5-10. Troubleshooting intercom talk/listen circuits, adverse for all positions of MONITOR switchh (Sheet 10 of 26).

5-9. Troubleshooting Flow Charts - Continued

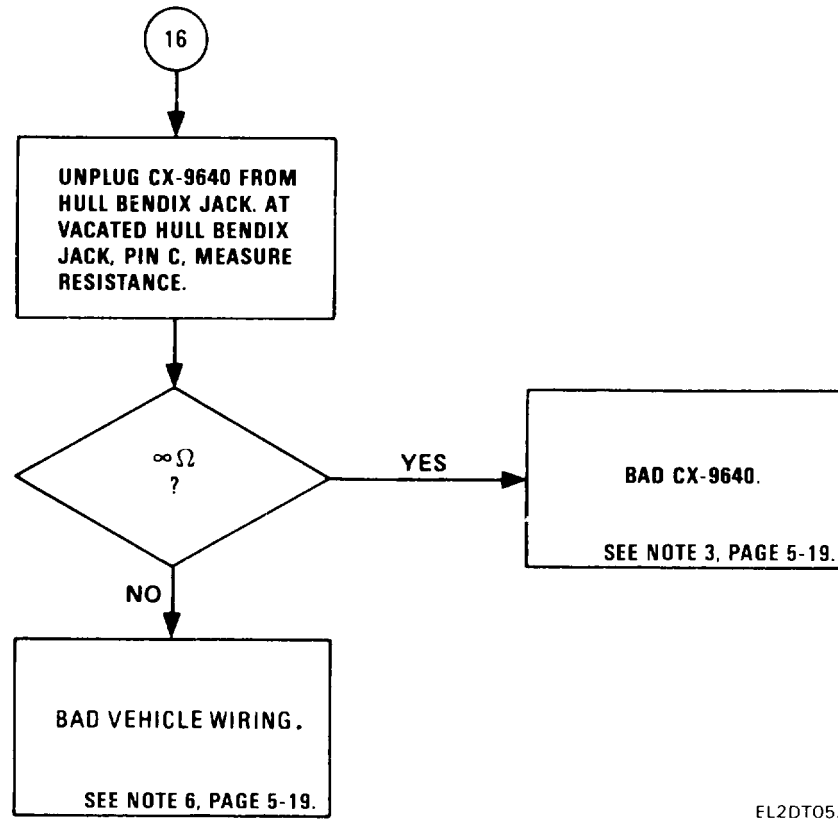

EL2DT052

Figure 5-10. Troubleshooting intercom talk/listen circuits, adverse for all positions of MONITOR switch (Sheet 11 of 26).

5-9. Troubleshooting Flow Charts - Continued

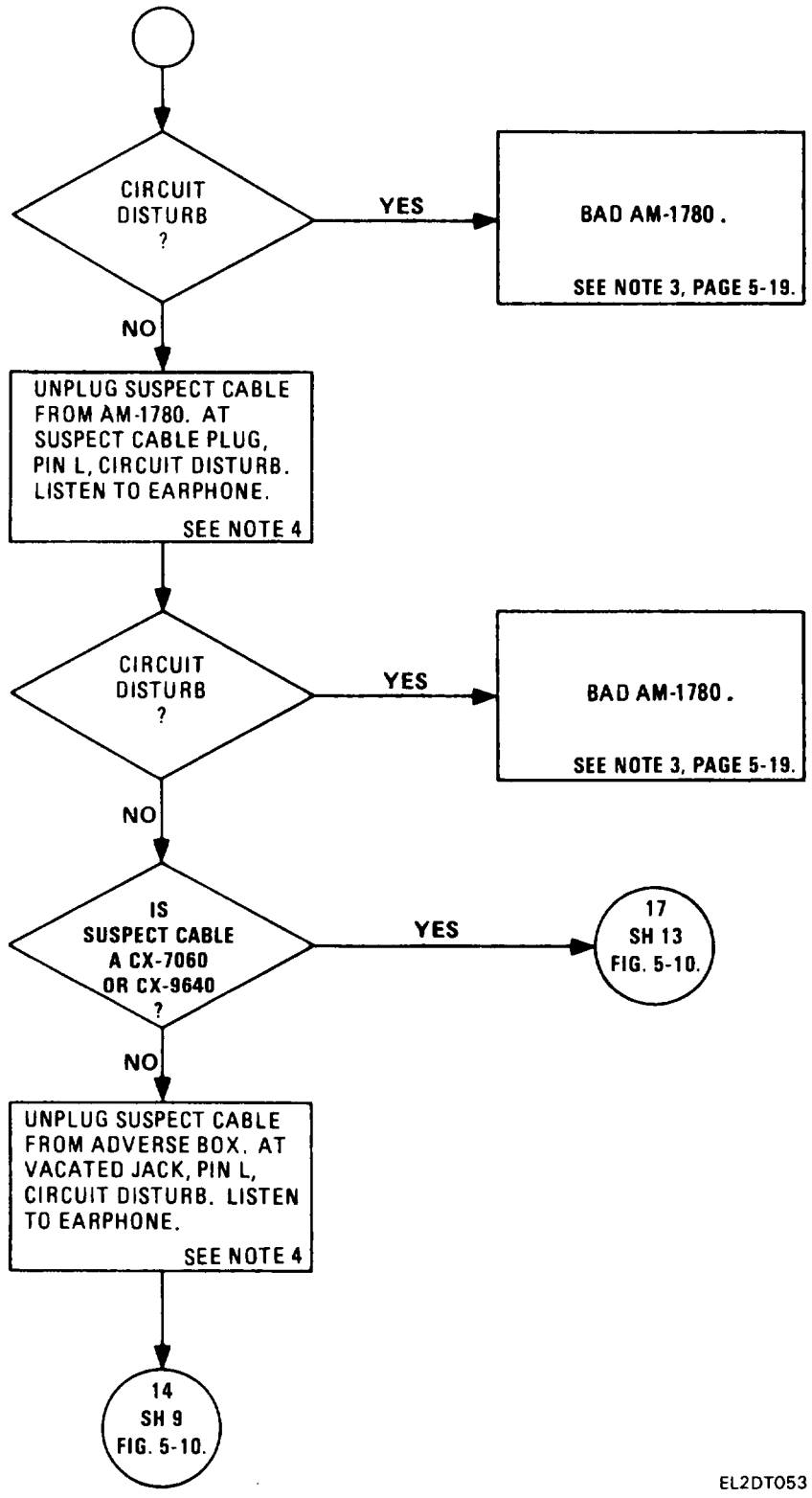

EL2DT053

Figure 5-10 Troubleshooting intercom talk/listen circuits, adverse all positions of MONITOR switch (Sheet 12 of 26).

5-9. Troubleshooting Flow Charts - Continued

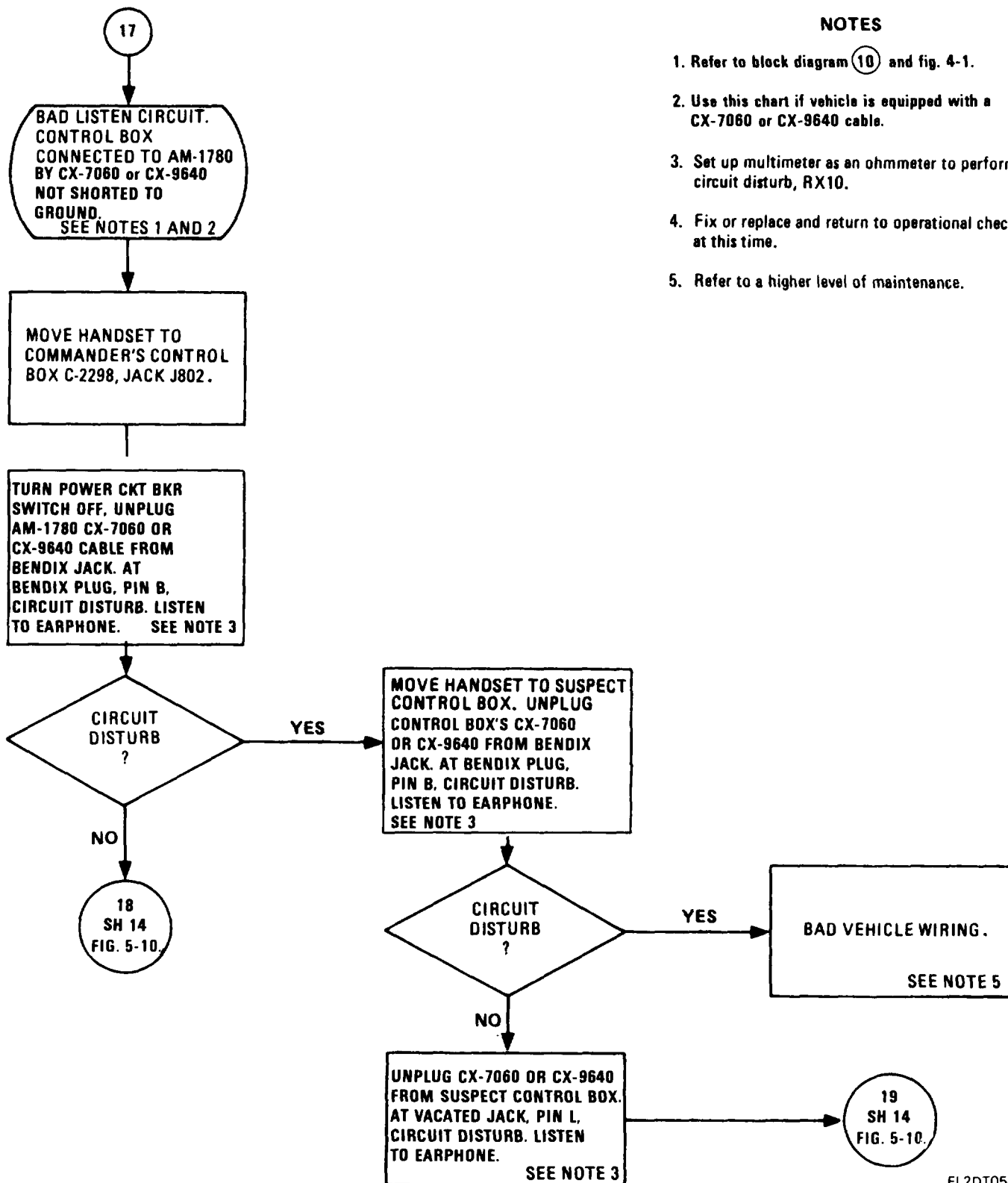

NOTES

1. Refer to block diagram (10) and fig. 4-1.
2. Use this chart if vehicle is equipped with a CX-7060 or CX-9640 cable.
3. Set up multimeter as an ohmmeter to perform circuit disturb, RX10.
4. Fix or replace and return to operational check at this time.
5. Refer to a higher level of maintenance.

Figure 5-10 Troubleshooting intercom talk/listen circuits, adverse/or all positions of MONITOR switch (Sheet 13 of 26).

EL2DT054

5-9. Troubleshooting Flow Charts - Continued

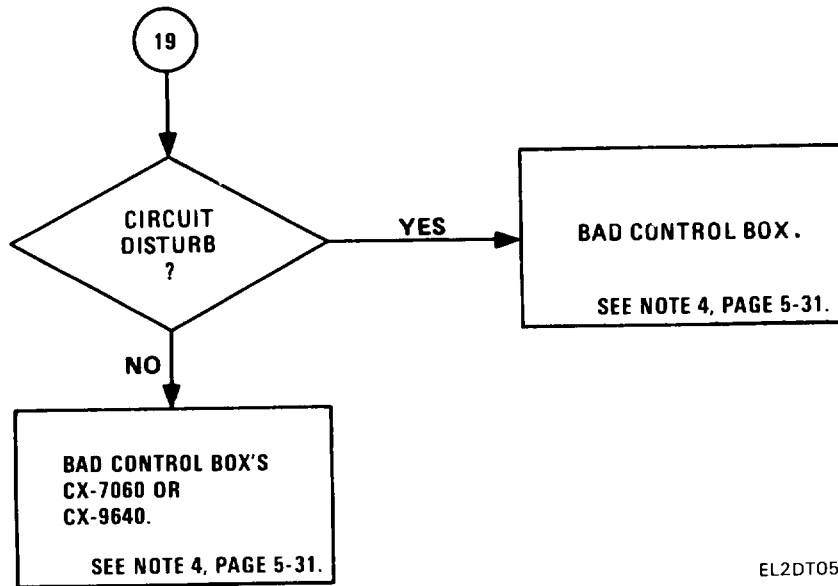
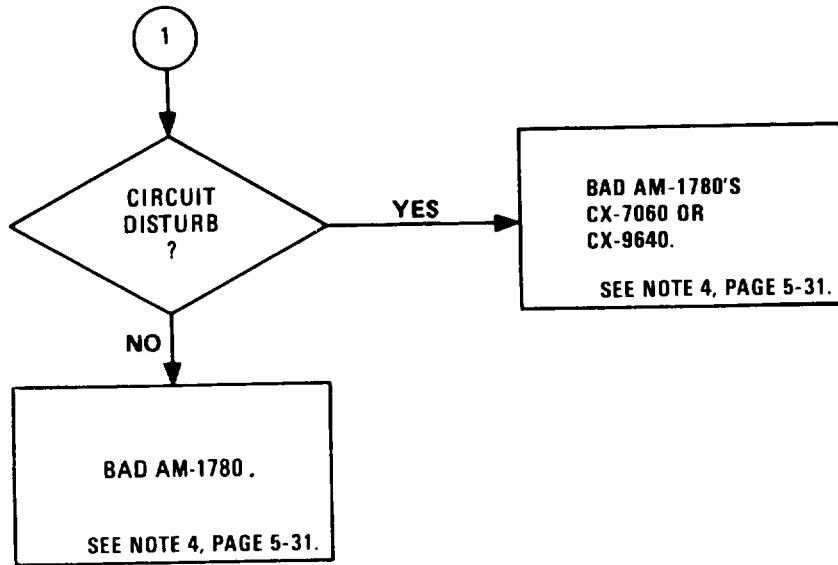

EL2DT055

Figure 5-10. Troubleshooting intercom talk/listen circuits, adverse for all positions of MONITOR switch (Sheet 14 of 26).

5-9. Troubleshooting Flow Charts - Continued

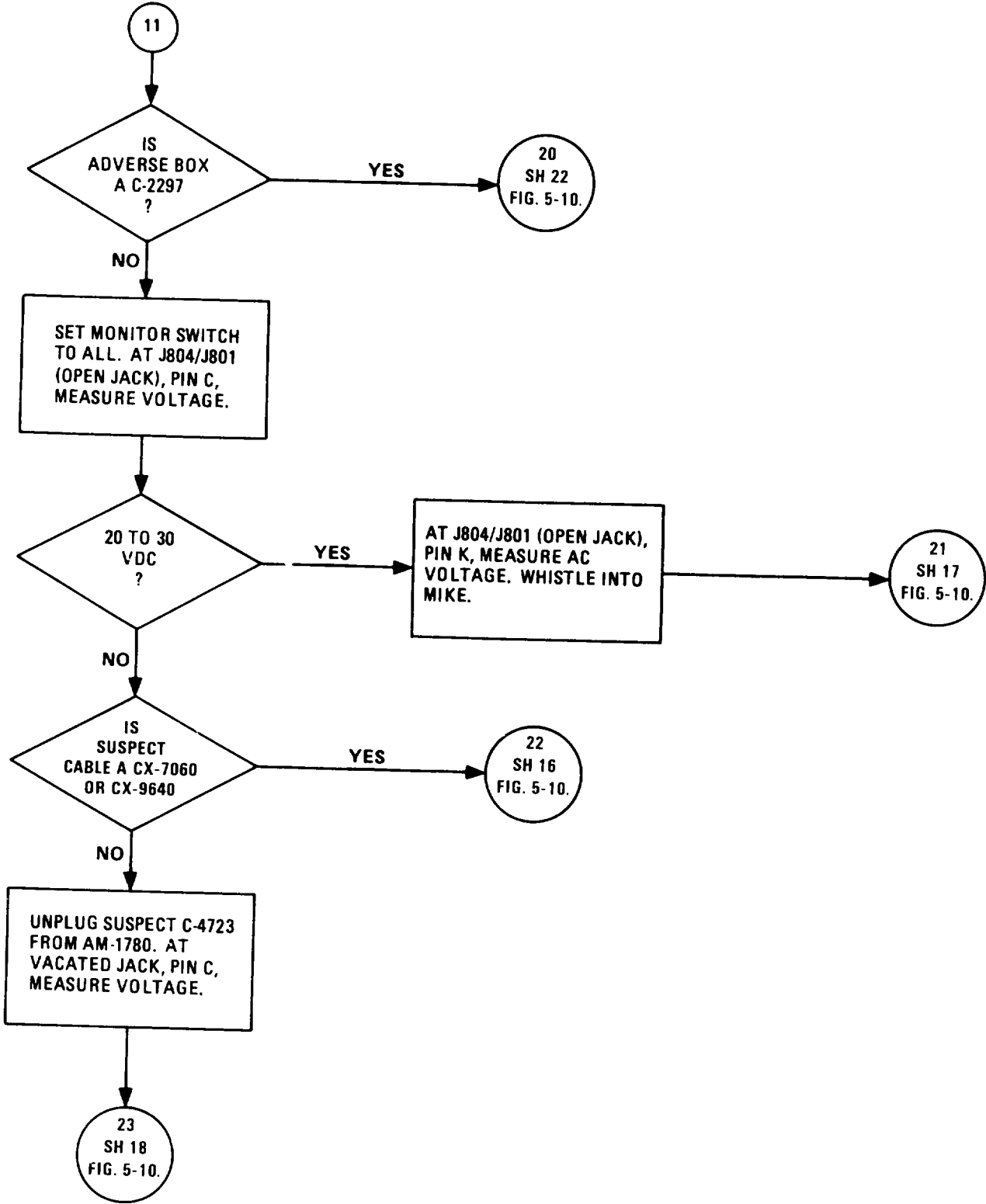

EL2DT056

Figure 5-10. Troubleshooting intercom talk/listen circuits, adverse for all positions of MONITOR switch (sheet 15 of 26).

5-9. Troubleshooting Flow Charts - continued

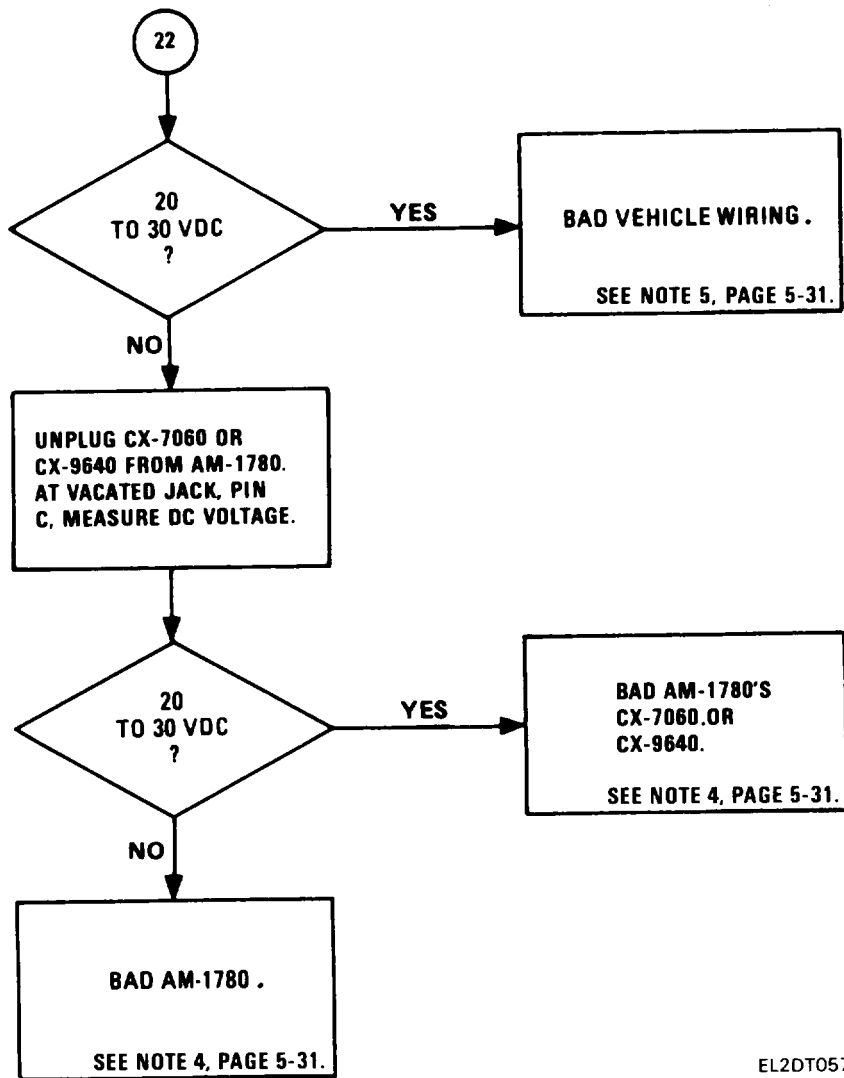

EL2DT057

Figure 5-10. Troubleshooting intercom talk/listen circuits, adverse for depositions of MONITOR switch (Sheet 16 of 26).

5-9. Troubleshooting Flow Charts - Continued

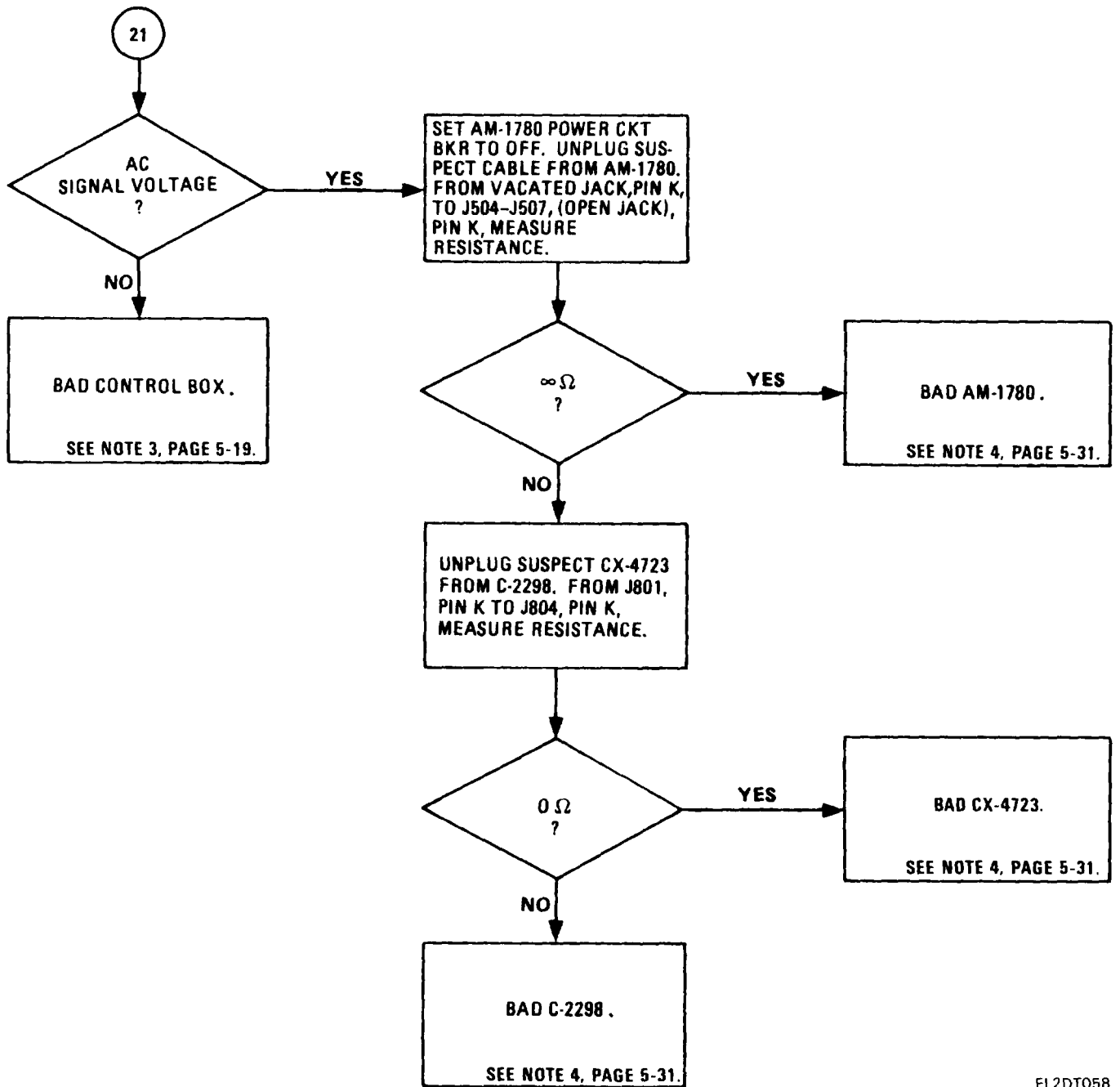

EL2DT058

Figure 5-10. Troubleshooting intercom talk/listen circuits, adverse for all positions of MONITOR switch (Sheet 17 of 26)

5-9. Troubleshooting Flow Charts - Continued

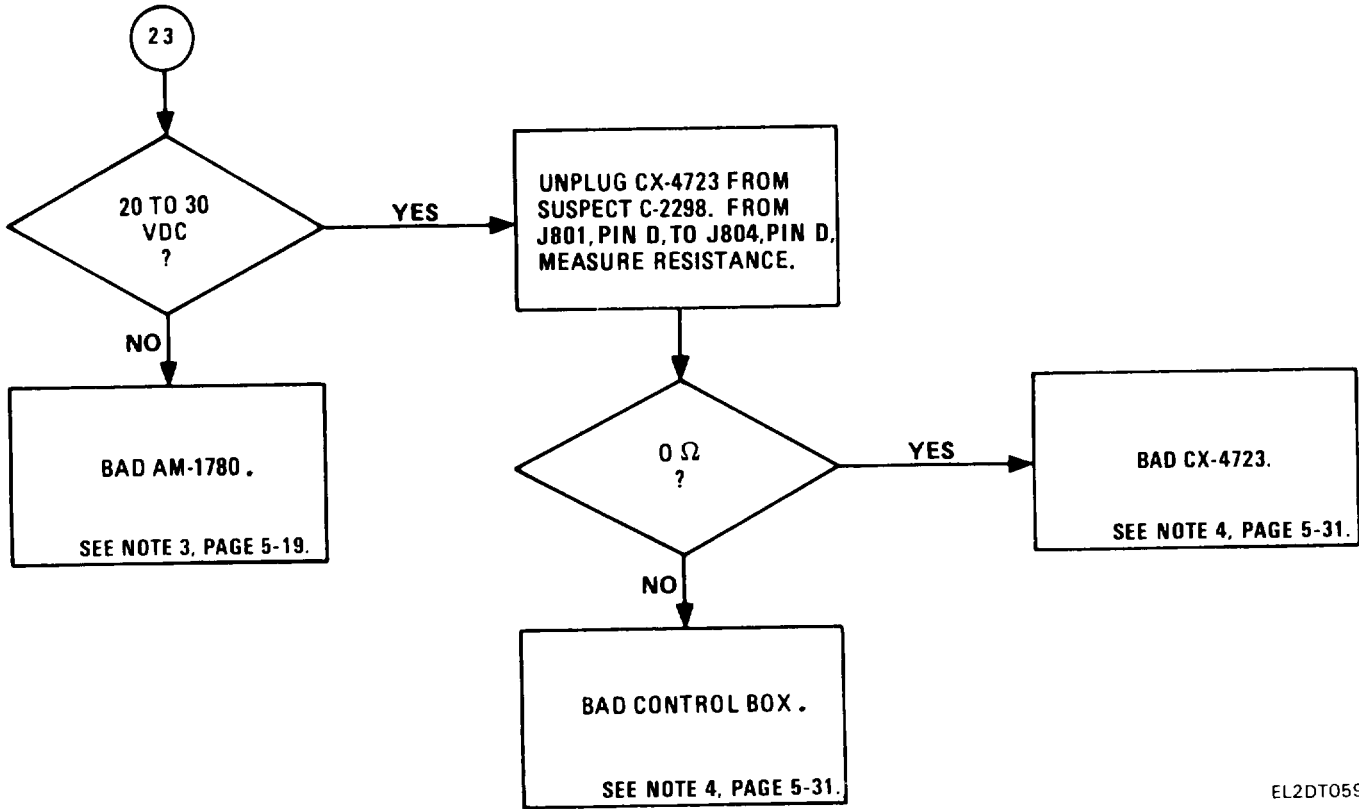

EL2DT059

Figure 5-10. Troubleshooting intercom talk/listen circuits, adverse for all positions of MONITOR switch (sheet 18 of 26).

5-9. Troubleshooting Flow Charts - Continued

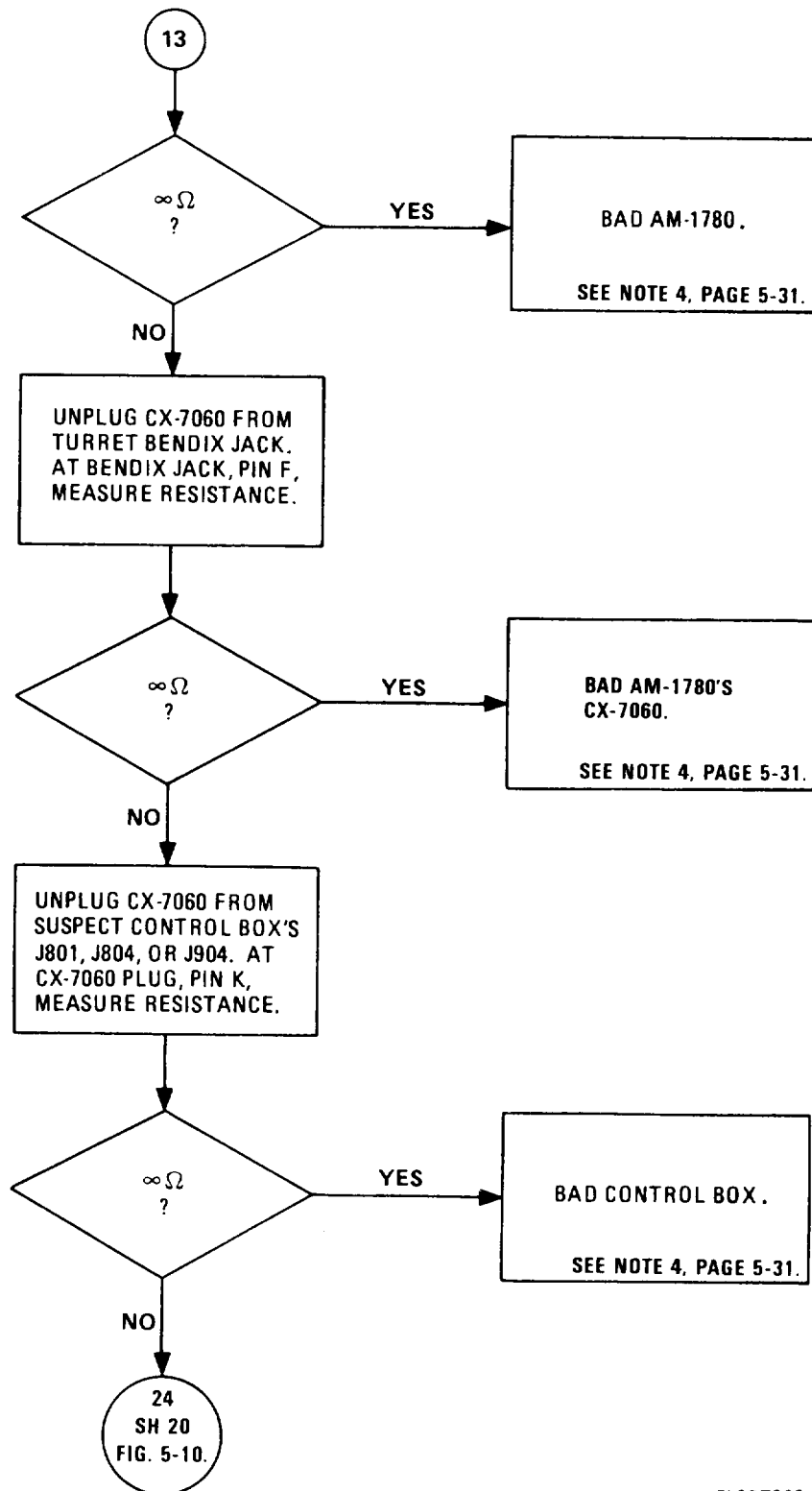

EL2DT060

Figure 5-10. Troubleshooting intercom talk/listen circuits, adverse for all positions of MONITOR switch (Sheet 19 of 26).

5-9. Troubleshooting Flow Charts- Continued

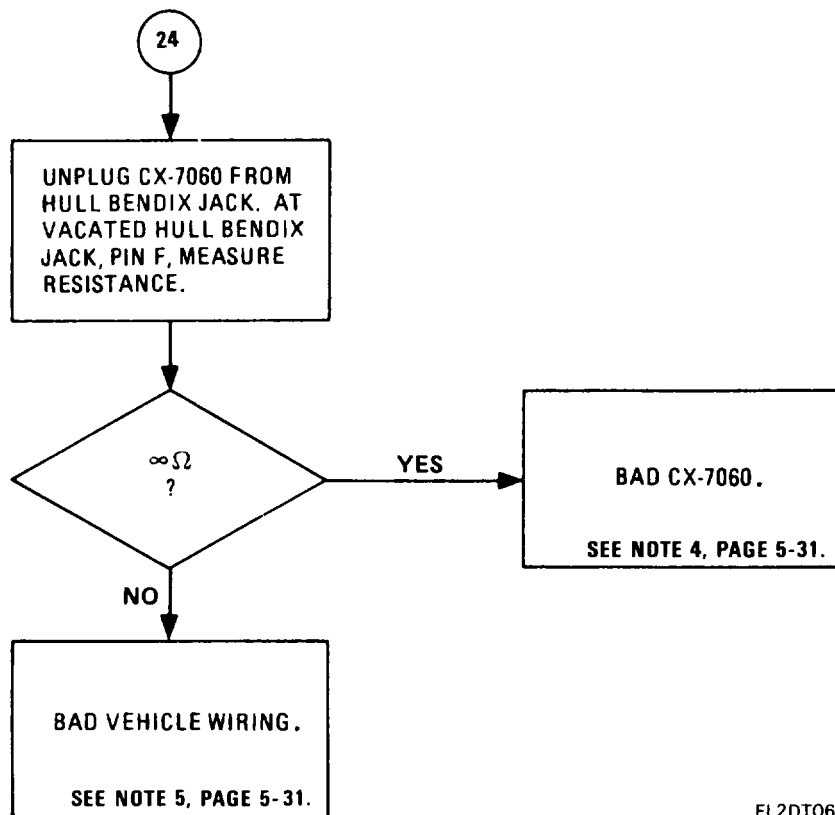

EL2DT061

Figure 5-10. Troubleshooting intercom talk/list circuits, adverse for all positions of MONITOR switch (Sheet 20 of 26).

5-9. Troubleshooting Flow Charts- Continued

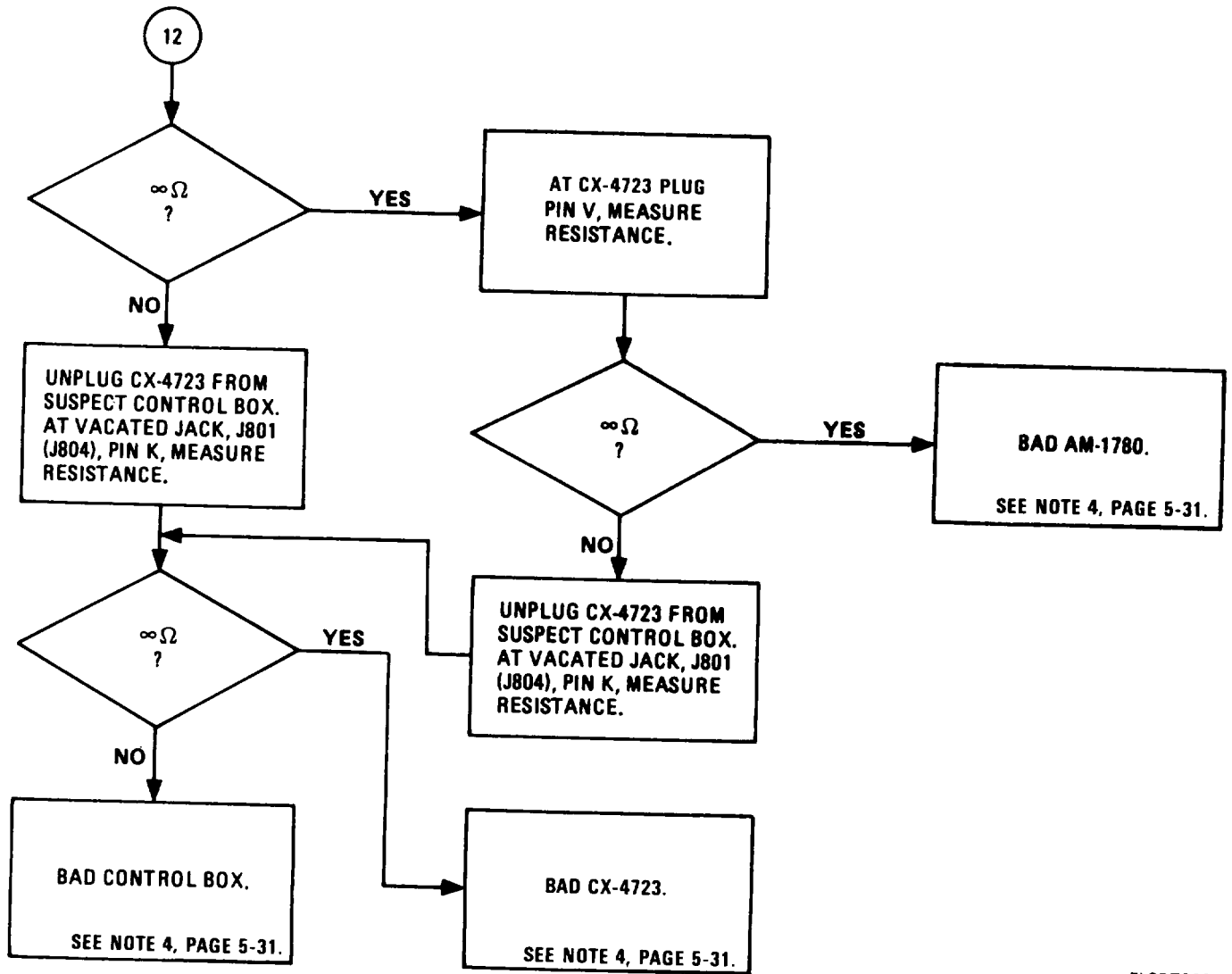

EL2DT062

Figure 5-10, Troubleshooting intercom talk/listen circuits, adverse for all positions of MONITOR switch (Sheet 21 of 26).

5-9. Troubleshooting Flow Charts – continued

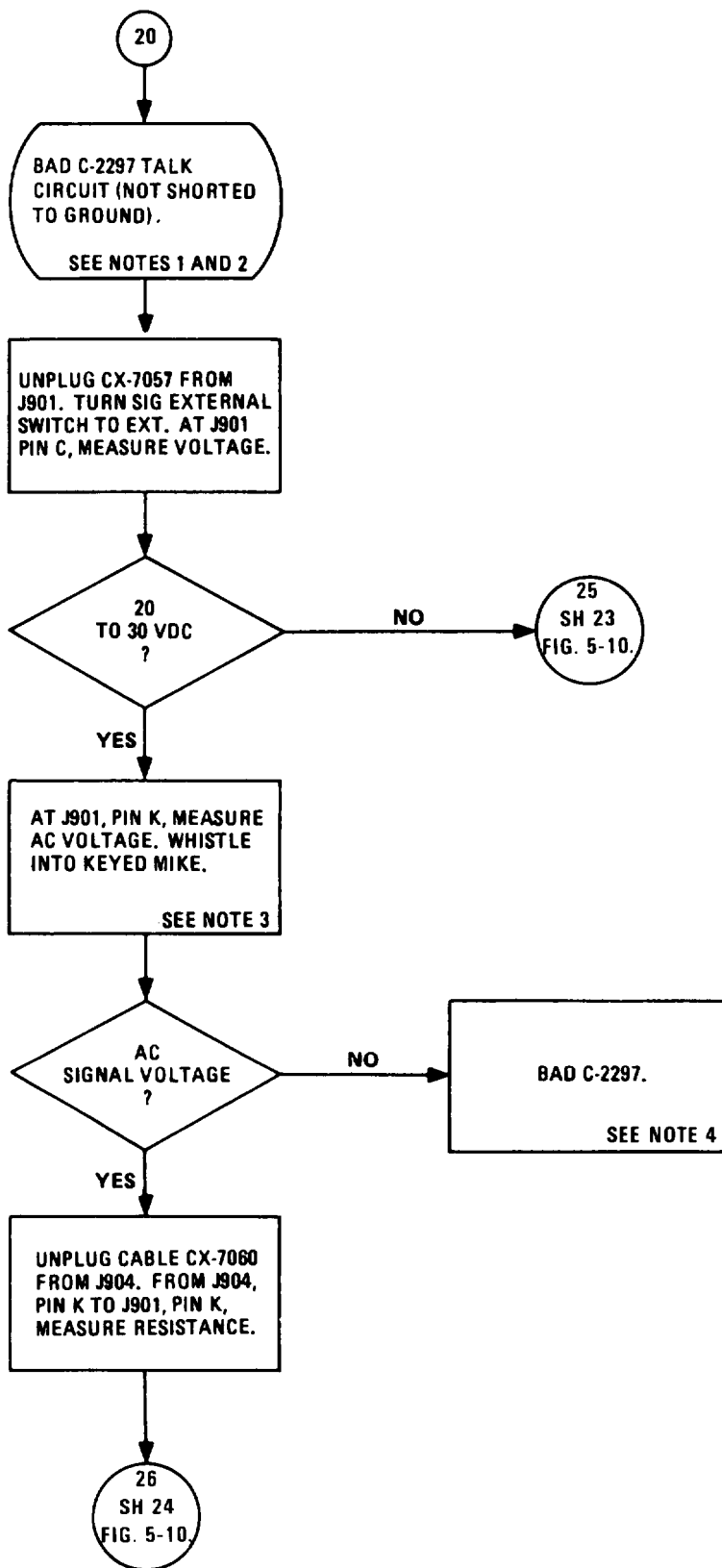

NOTES :

1. Refer to figure FO-1 in back of this manual.
2. Use this flow chart if vehicle is equipped with e C-2297 driver's control box.
3. Set up multimeter as an AC voltmeter (lowest range) connect motor probes between signal line (test point) and chassis ground; then key mike and note reading. Next sharply whistle into keyed mike and see if motor reading changes. A change in AC voltage reading indicates the presence of the talk signal. (Reading is <1 volt.)
4. Fix or replace and return to operational check at this time.
5. Setup multimeter as an ohmmeter to do circuit disturb, RX10.
6. Refer to higher maintenance level.

Figure 5-10. Troubleshooting intercom talk/listen circuits, adverse for all positions of MONITOR switch (Sheet 22 of 26).

5-9. Troubleshooting Flow Charts - Continued

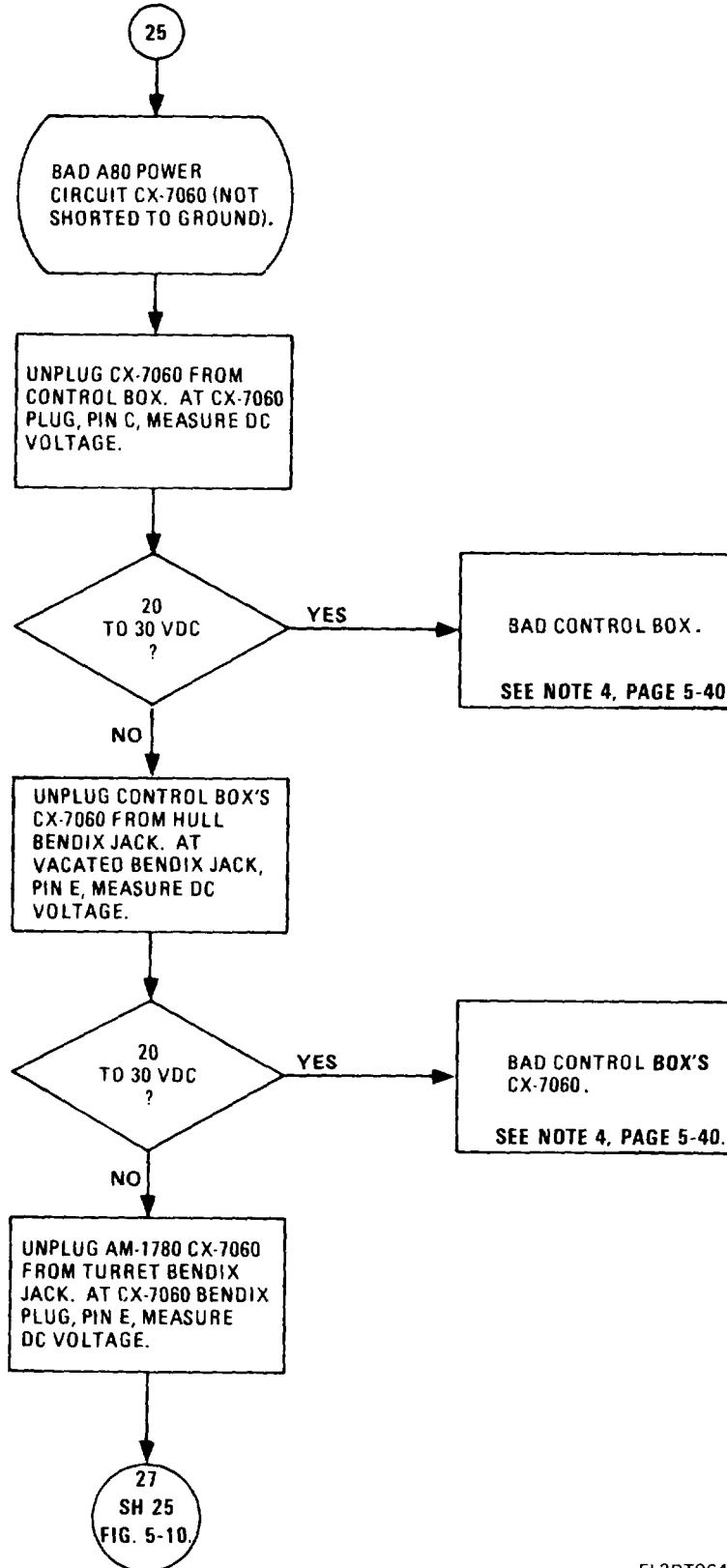

EL2DT064

Figure 5-10. Troubleshooting intercom talk/listen circuits, adverse for all positions of MONITOR switch (Sheet 23 of 26).

5-9. Troubleshooting Flow Charts - Continued

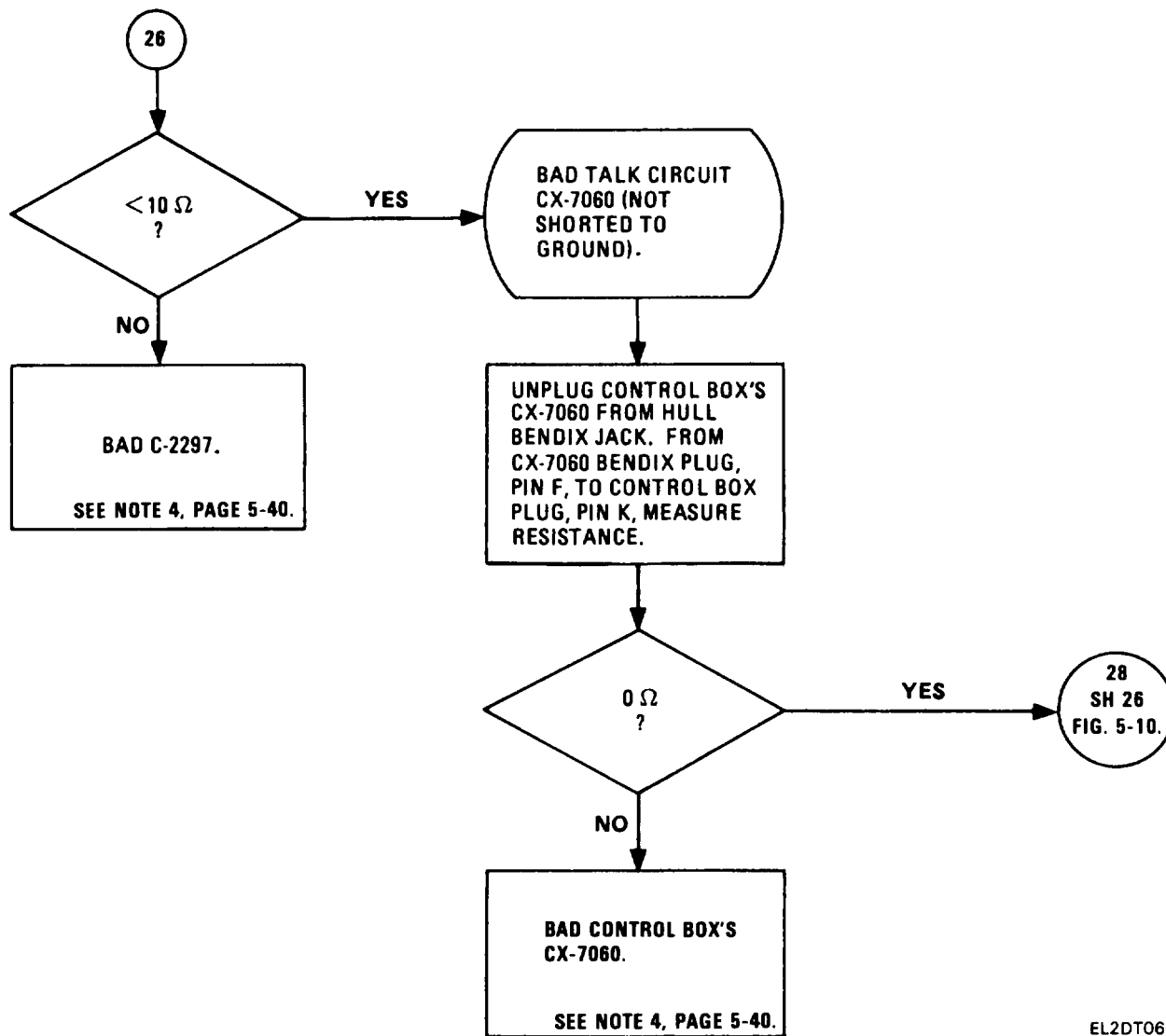

EL2DT065

Figure 5-20. Troubleshooting intercom talk/listen circuits, adverse for all positions of MONITOR switch (Sheet 24 of 26)

5-9. Troubleshooting Flow Charts- Continued

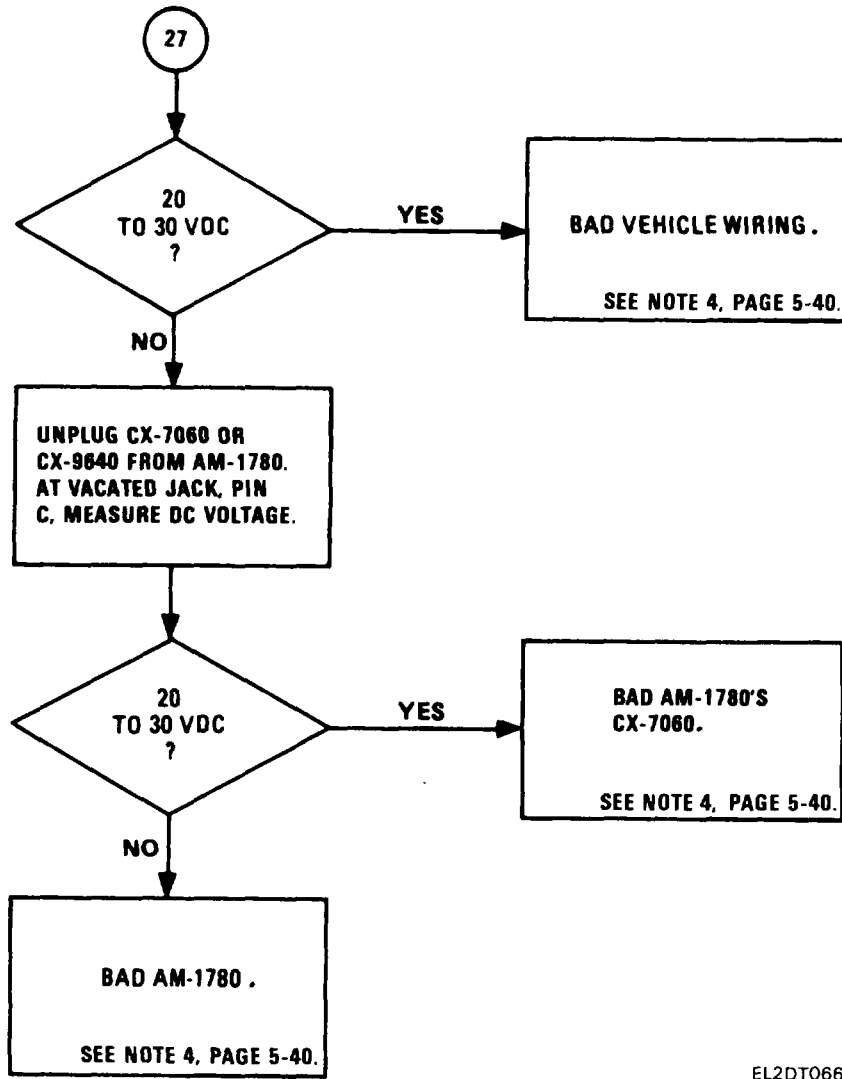

EL2DT066

Figure 5-10. Troubleshooting intercom talk/listen circuits, adverse for all position.s of MONITOR switch (Sheet 25 of 26).

5-9. Troubleshooting Flow Charts - Continued

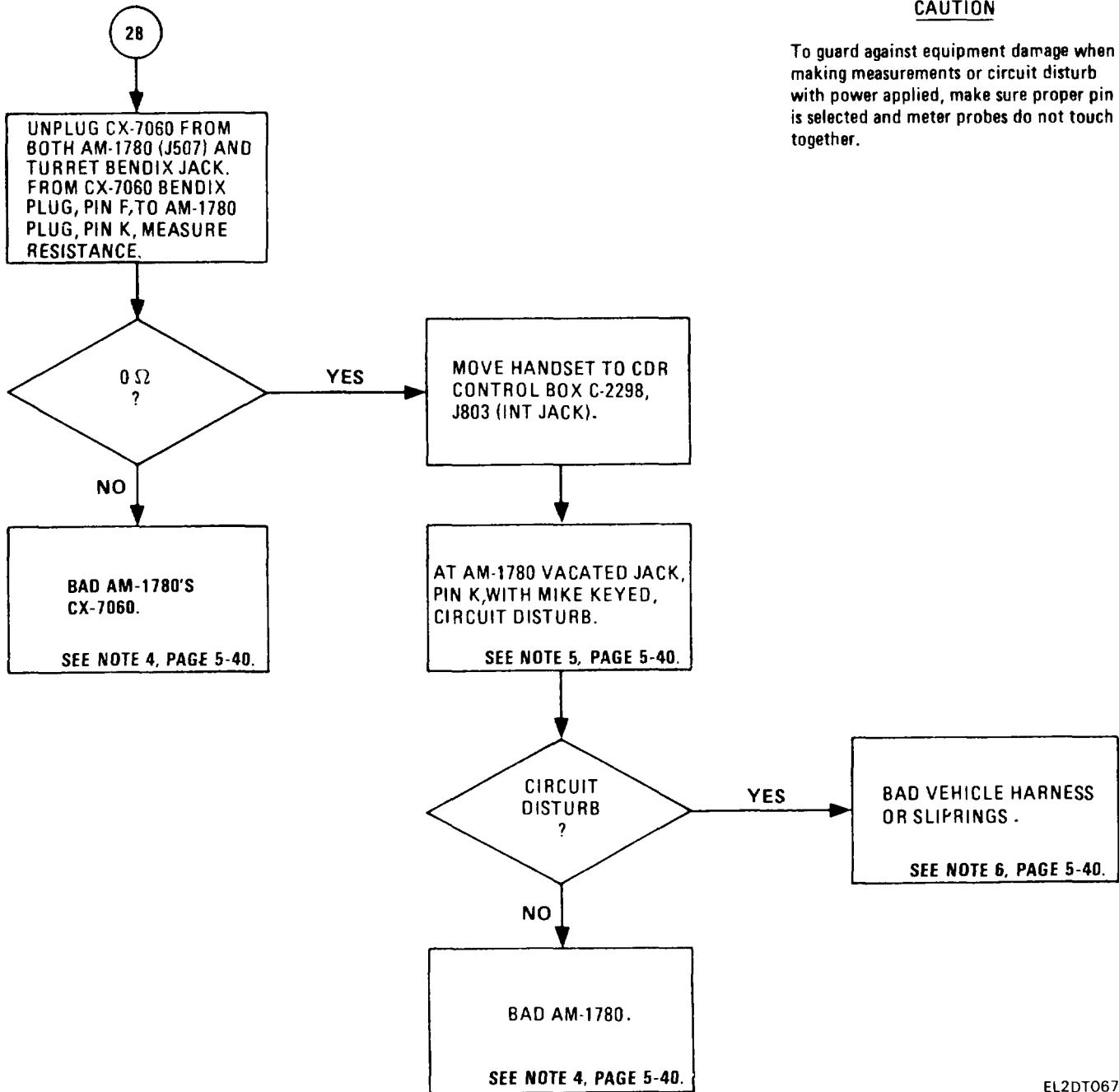

CAUTION

To guard against equipment damage when making measurements or circuit disturb with power applied, make sure proper pin is selected and meter probes do not touch together.

EL2DT067

Figure 5-10. Troubleshooting intercom talk/listen circuits, adverse for all positions of MONITOR switch (Sheet 26 of 26).

5-9. Troubleshooting Flow Charts - Continued

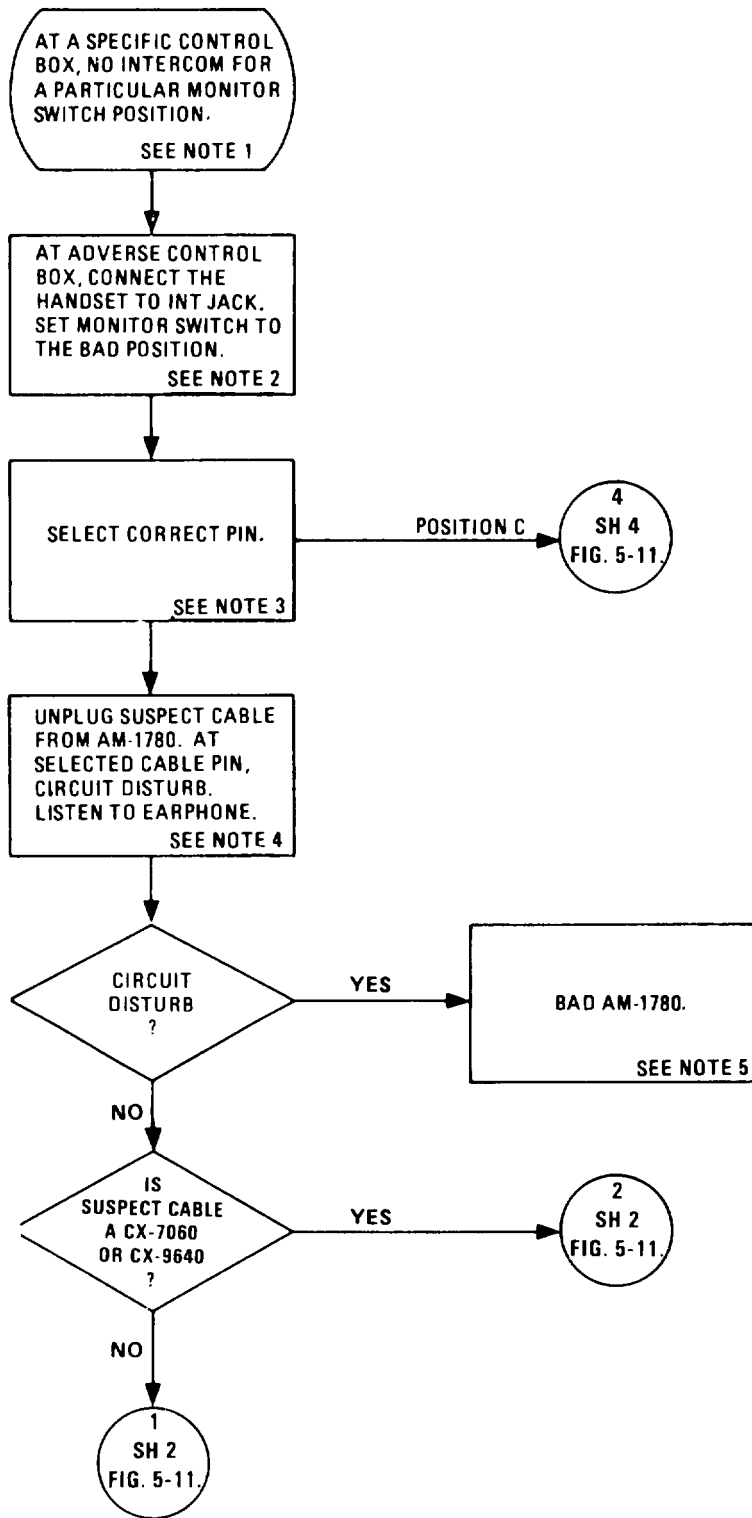

NOTES:

1. Refer to figure F0-1 in back of this manual.
2. Follow this chart in sequence for any position of the MONITOR switch and for any commander's, driver's, and crewmember's control boxes.
3. Select the correct pin for the MONITOR switch or the Bendix cable from the below listed chart.

Position	Use	CX-7060 Bendix	CX-9640 Bendix
ALL	Pin L	B	B
A	Pin M	A	N/A
INT	Pin E	G	N/A
B	Pin B	J	N/A
C	See 4 SH 4 FIG. 5-11.	N/A	N/A

4. Set up multimeter as an ohmmeter to perform circuit disturb, RX10.
5. Fix or replace and return to operational check at this time.
6. Refer to higher maintenance level.
7. Set up multimeter as an AC voltmeter (lowest range) connect meter probes between signal line (test point) and chassis ground, then key mike and note reading. Next, sharply whistle into mike and look to see if the meter reading changes. Any change in AC voltage reading indicates the presence of the talk signal. (Reading is 1 volt.)

Figure 5-11. Troubleshooting intercom talk/listen circuits, a particular position of MONITOR switch is adverse (Sheet 1 of 6).

5-9. Troubleshooting Flow Charts- continued

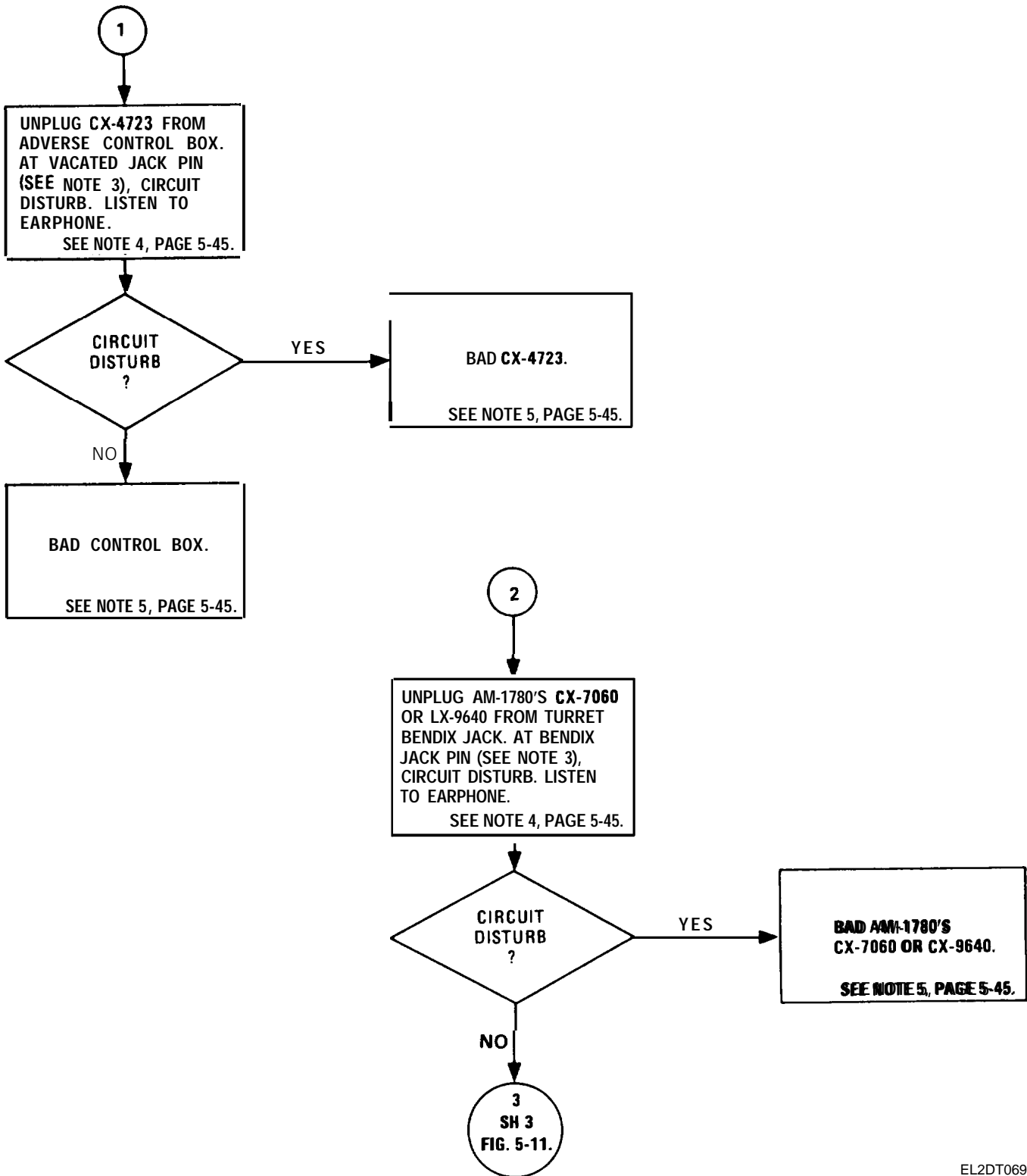

EL2DT069

Figure 5-11. Troubleshooting intercom talk/listen circuits, a particular position of MONITOR switch is adverse (Sheet 2 of 6)

5-9. Troubleshooting Flow charts - Continued

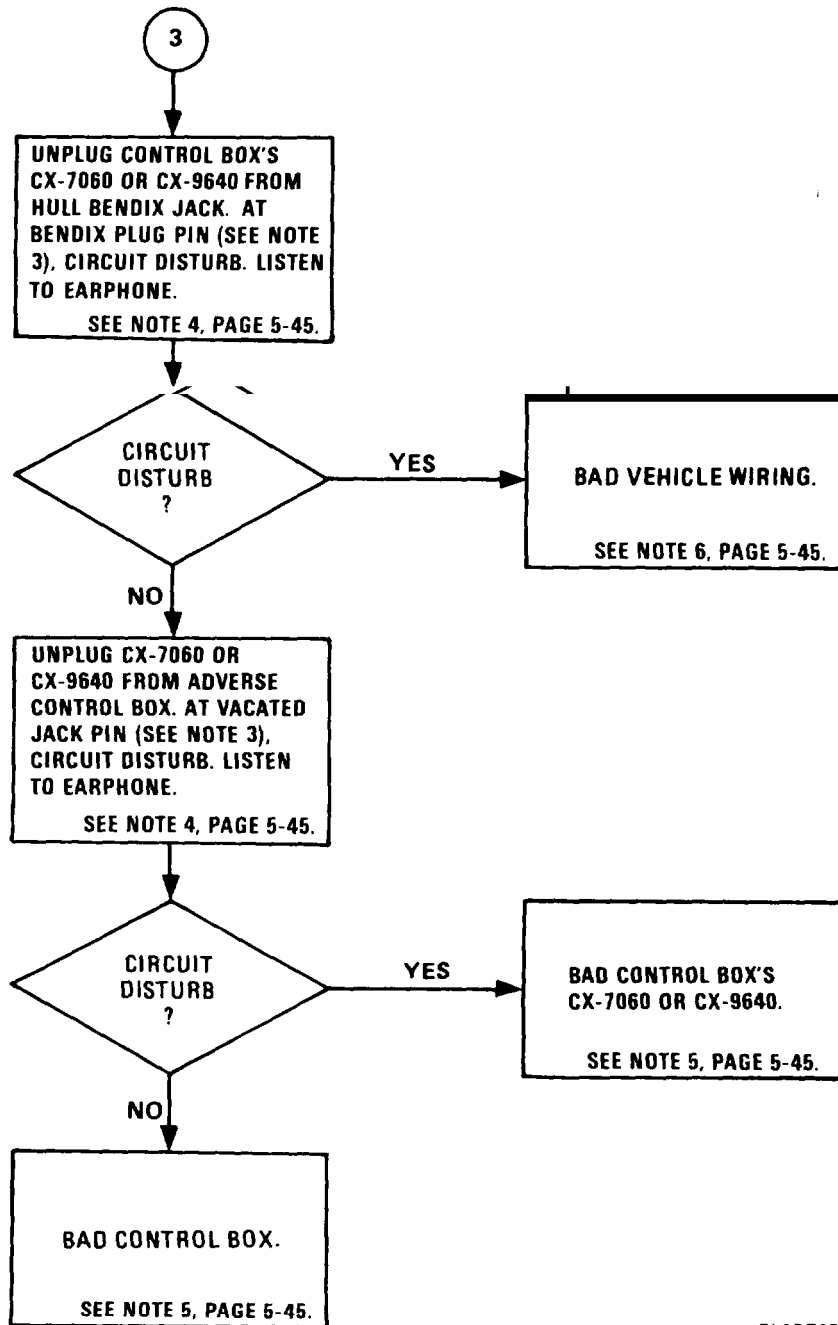

EL2DT070

Figure 5-11. Troubleshooting intercom talk/listen circuits, a particular position of MONITOR switch is adverse (Sheet 3 of 6).

5-9. Troubleshooting Flow Charts - Continued

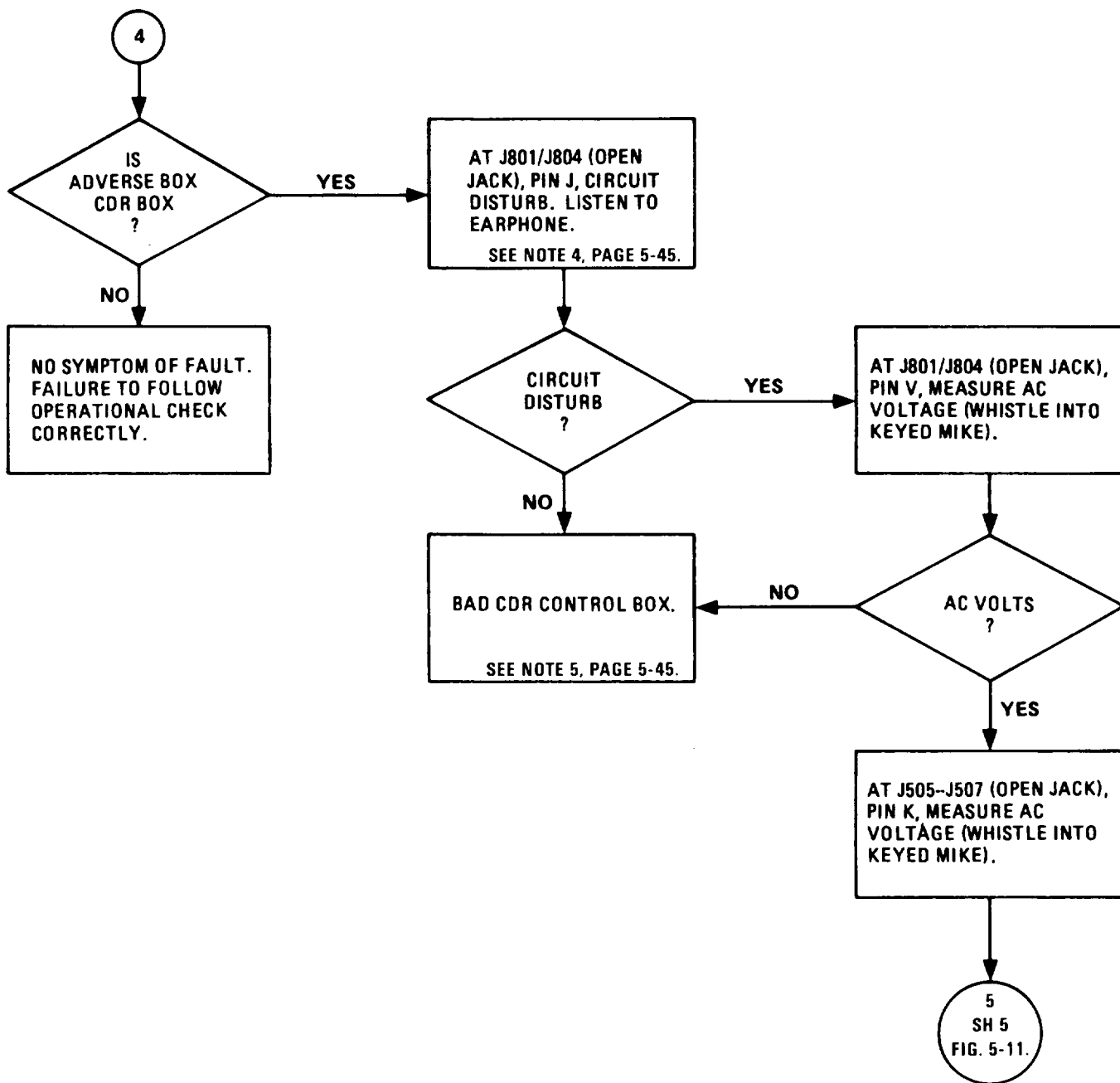

EL2DT071

Figure 5-11. Troubleshooting intercom talk/listen circuits, a particular position of MONITOR switch is adverse (Sheet 4 of 6)

5-9. Troubleshooting Flow Charts - Continued

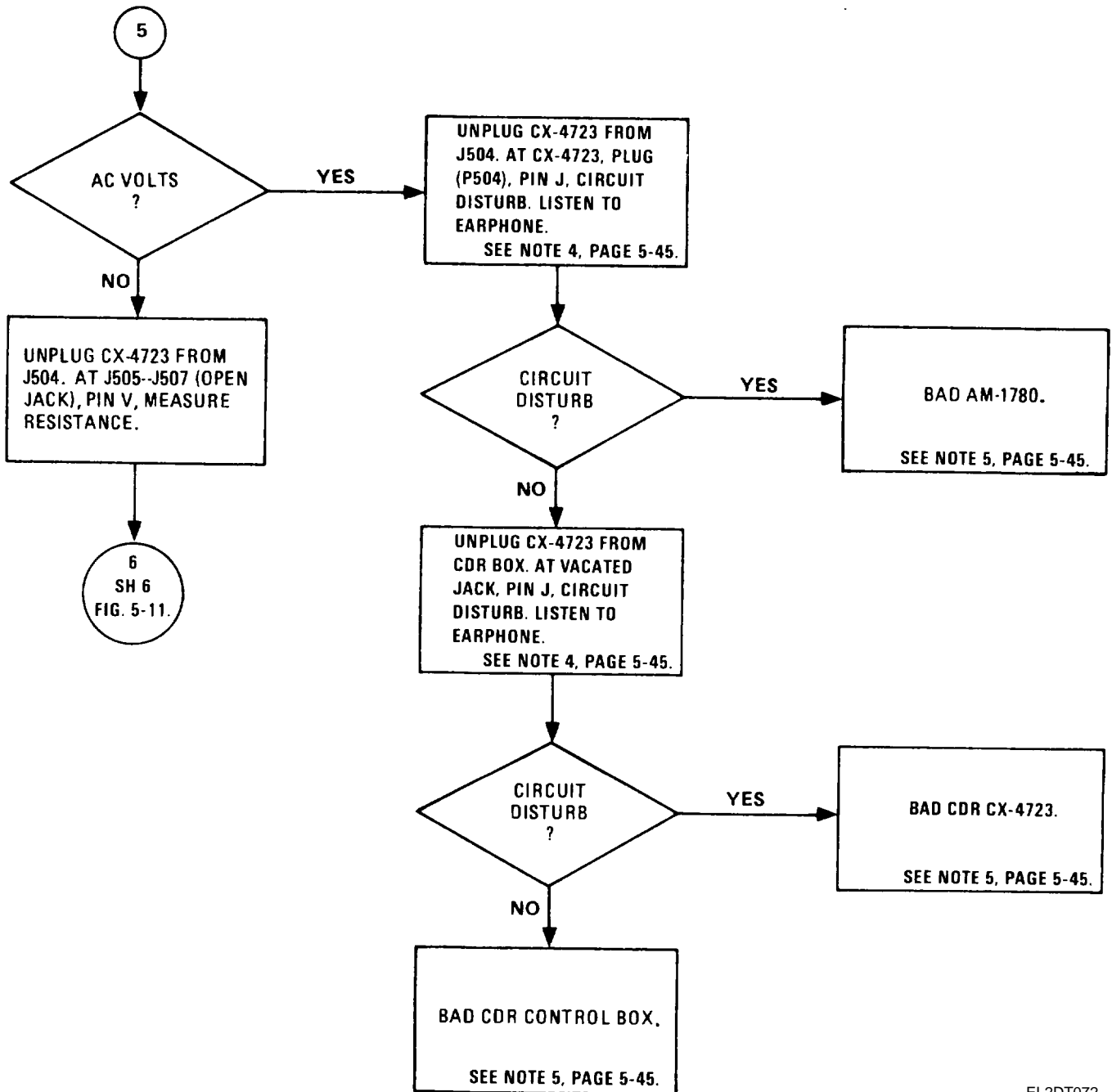

EL2DT072

Figure 5-11. Troubleshooting intercom talk/listen circuits, a particular position of MONITOR switch is adverse (Sheet 5 of 6)

5-9. Troubleshooting Flow Charts - Continued

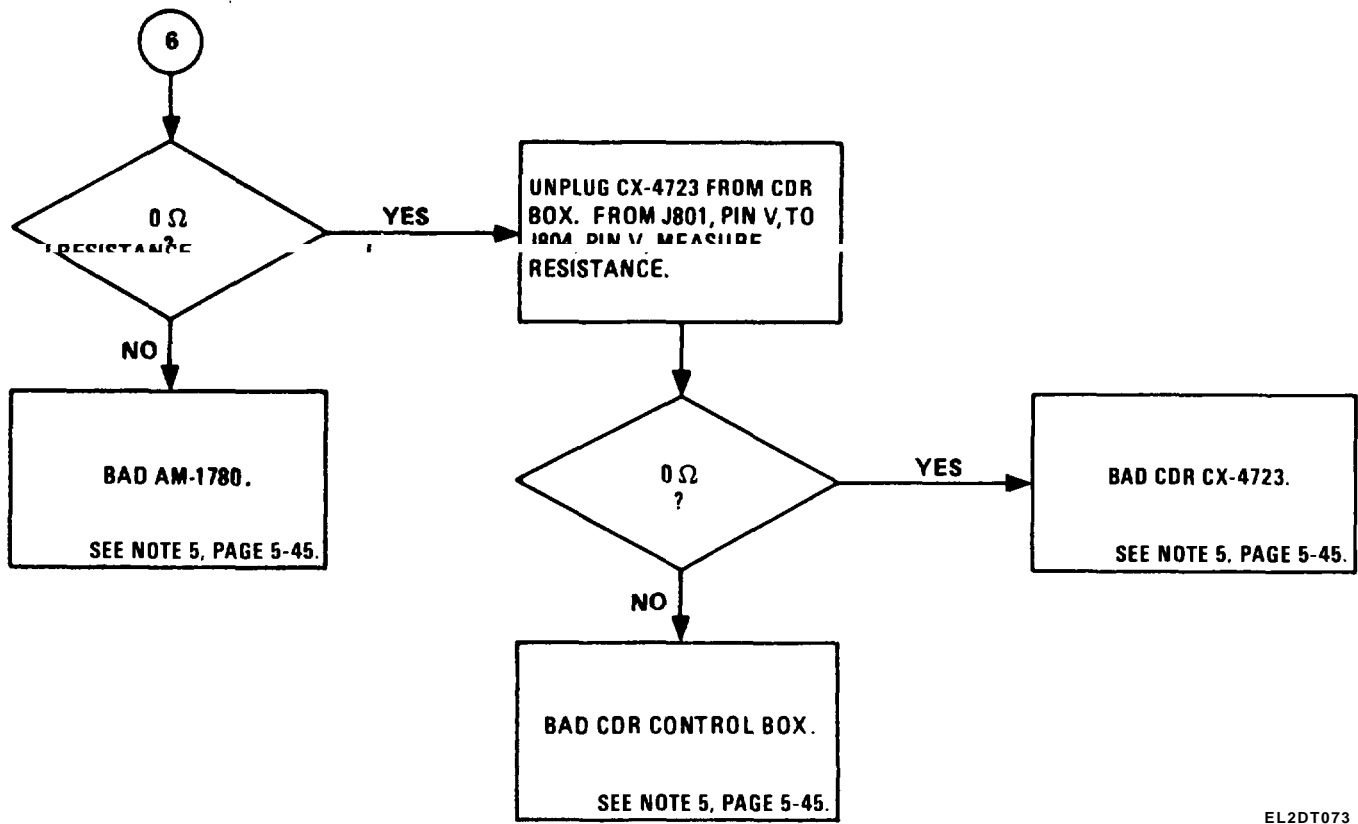

EL2DT073

Figure 5-11. Troubleshooting intercom talk/listen circuits, a particular position of MONITOR switch is adverse (Sheet 6 of 6).

5-9. Troubleshooting Flow Charts - Continued

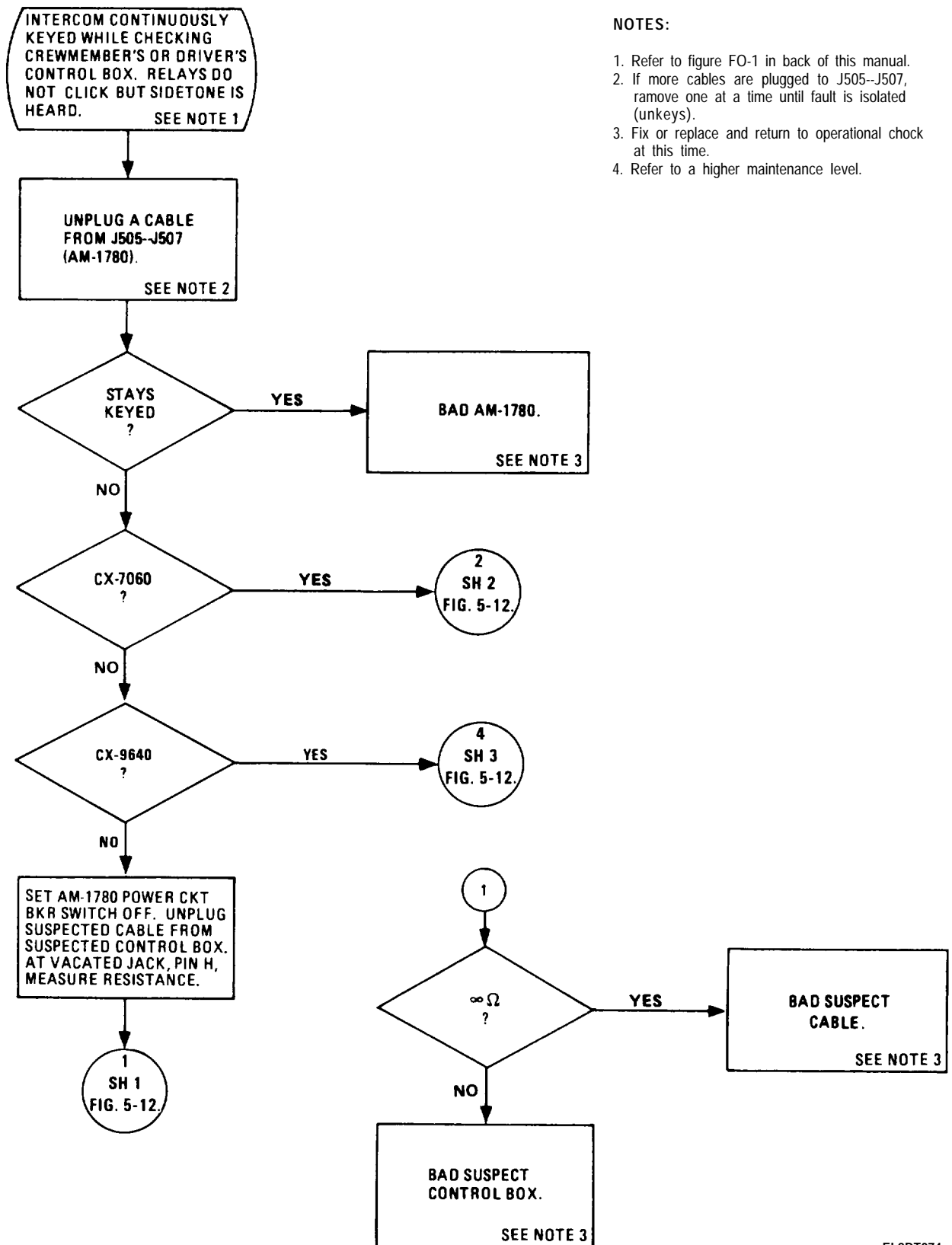

NOTES:

1. Refer to figure FO-1 in back of this manual.
2. If more cables are plugged to J505-J507, remove one at a time until fault is isolated (unkeys).
3. Fix or replace and return to operational check at this time.
4. Refer to a higher maintenance level.

Figure 5-12. Troubleshooting intercom keying circuits, adverse short (Sheet 1 of 3).

EL2DT074

5-9. Troubleshooting Flow Charts - continued

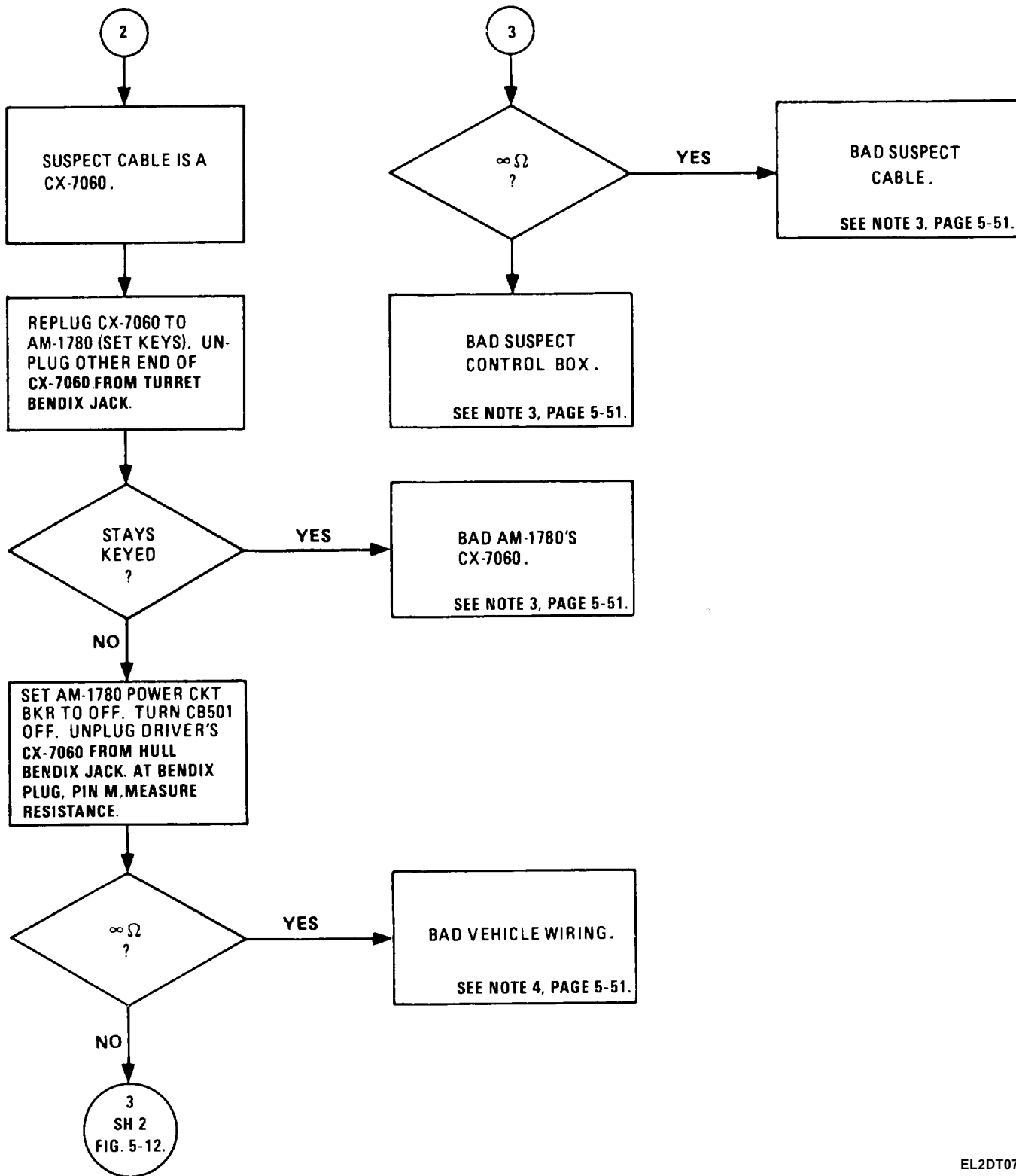

EL2DT075

Figure 5-12. Troubleshooting intercom keying circuits, adverse short (Sheet 2 of 3).

5-9. Troubleshooting Flow Charts - Continued

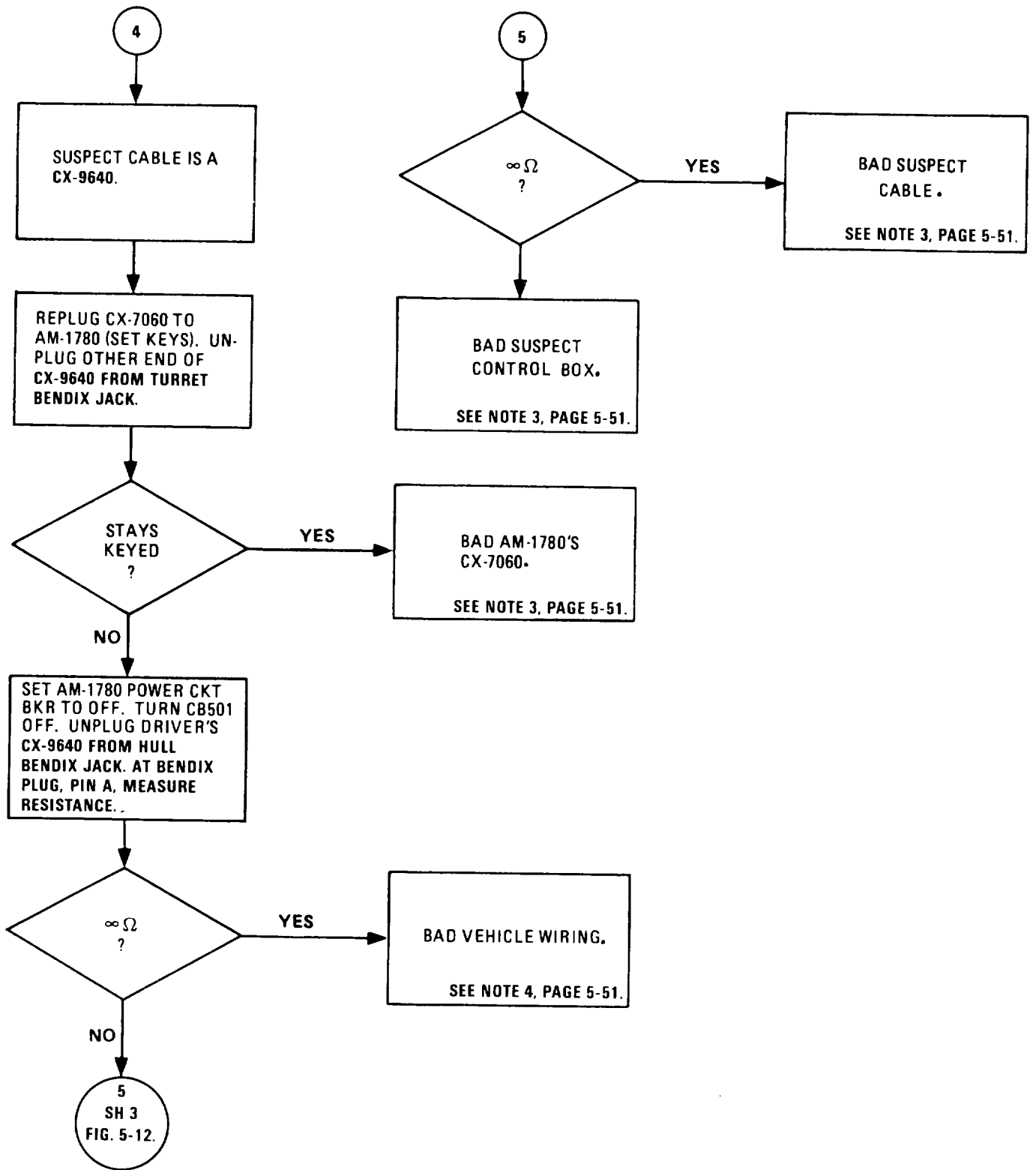

EL2DT076

Figure 5-12. Troubleshooting intercom keying circuits, adverse short (Sheet 3 of 3).

5-9. Troubleshooting Flow Charts - Continued

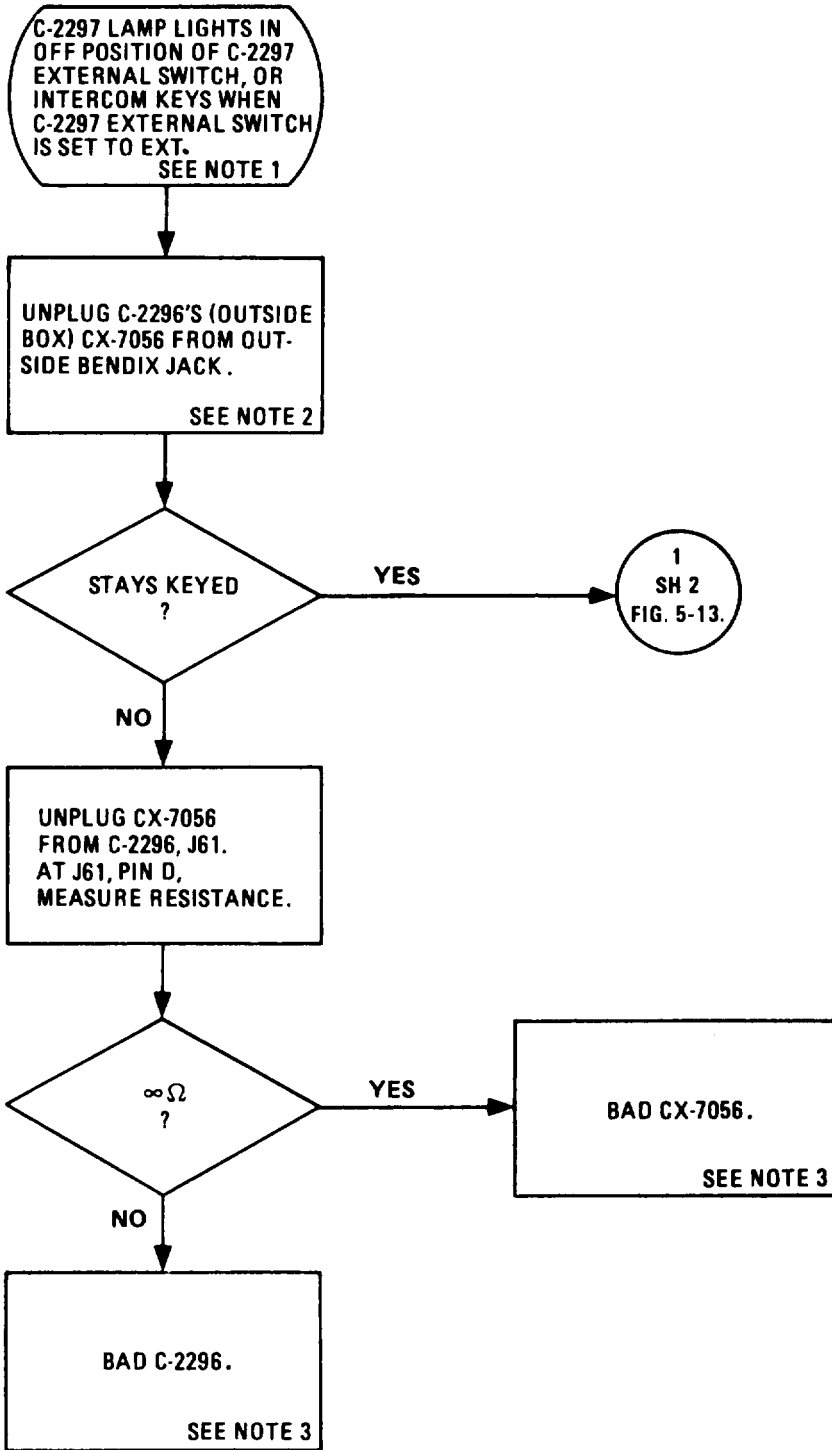

NOTES

1. Refer to figure FO-1 in back of this manual.
2. Use this flow chart if the vehicle is equipped with a C-2297/VRC driver's control box.
3. Fix or replace and return to operational check at this time.
4. Refer to higher level of maintenance.

EL2DT077

Figure 5-13. Troubleshooting C-2296 intercom keying circuits, adverse short (Sheet 1 of 2).

5-9. Troubleshooting Flow Charts - Continued

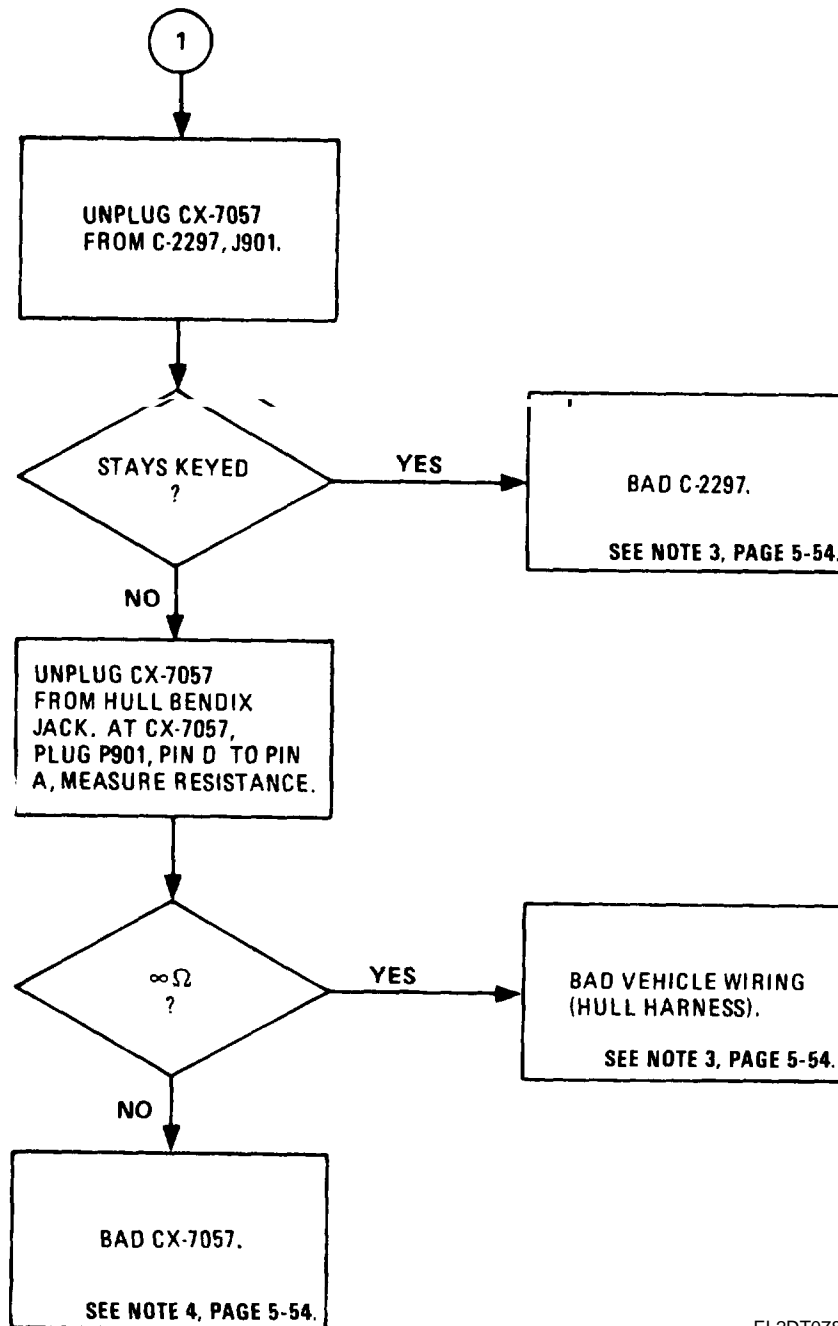

EL2DT078

Figure 5-13. Troubleshooting C-2296 intercom keying circuits, adverse short (Sheet 2 of 2).

5-9. Troubleshooting Flow Charts - Continued

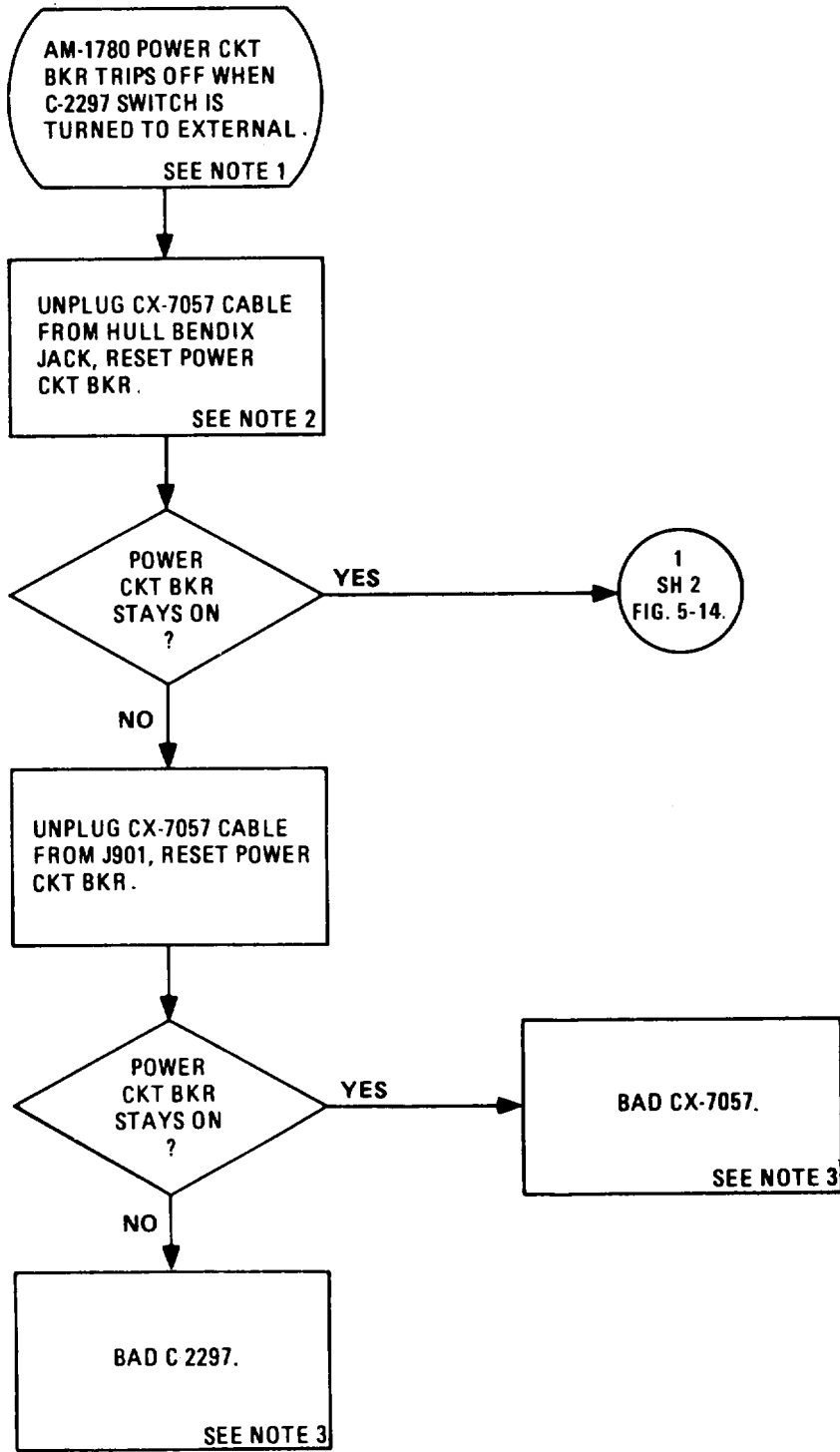

NOTES:

1. Refer to figure FO-2 in back of this manual.
2. Use this chart if vehicle is equipped with a C-2297/VRC control box.
3. Fix or replace and return to operational check at this time.
4. Refer to higher level of maintenance.

EL2DT079

Figure 5-14. Troubleshooting intercom power distribution circuits, adverse short (Sheet 1 of 2).

5-9. Troubleshooting Flow Charts - Continued

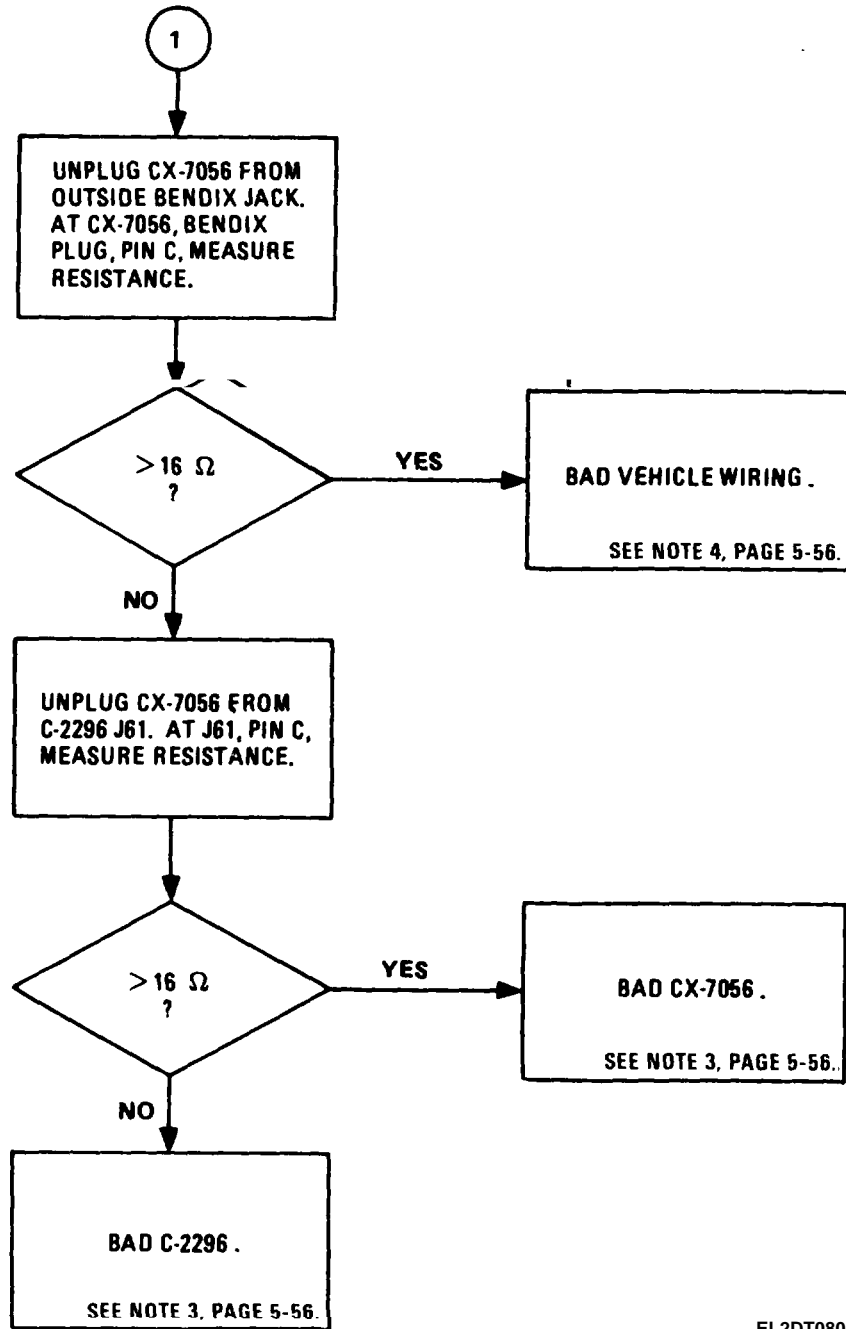

EL2DT080

Figure 5-14. Troubleshooting intercom power distribution circuits, adverse short (Sheet 2 of 2).

5-9. Troubleshooting Flow Charts - Continued

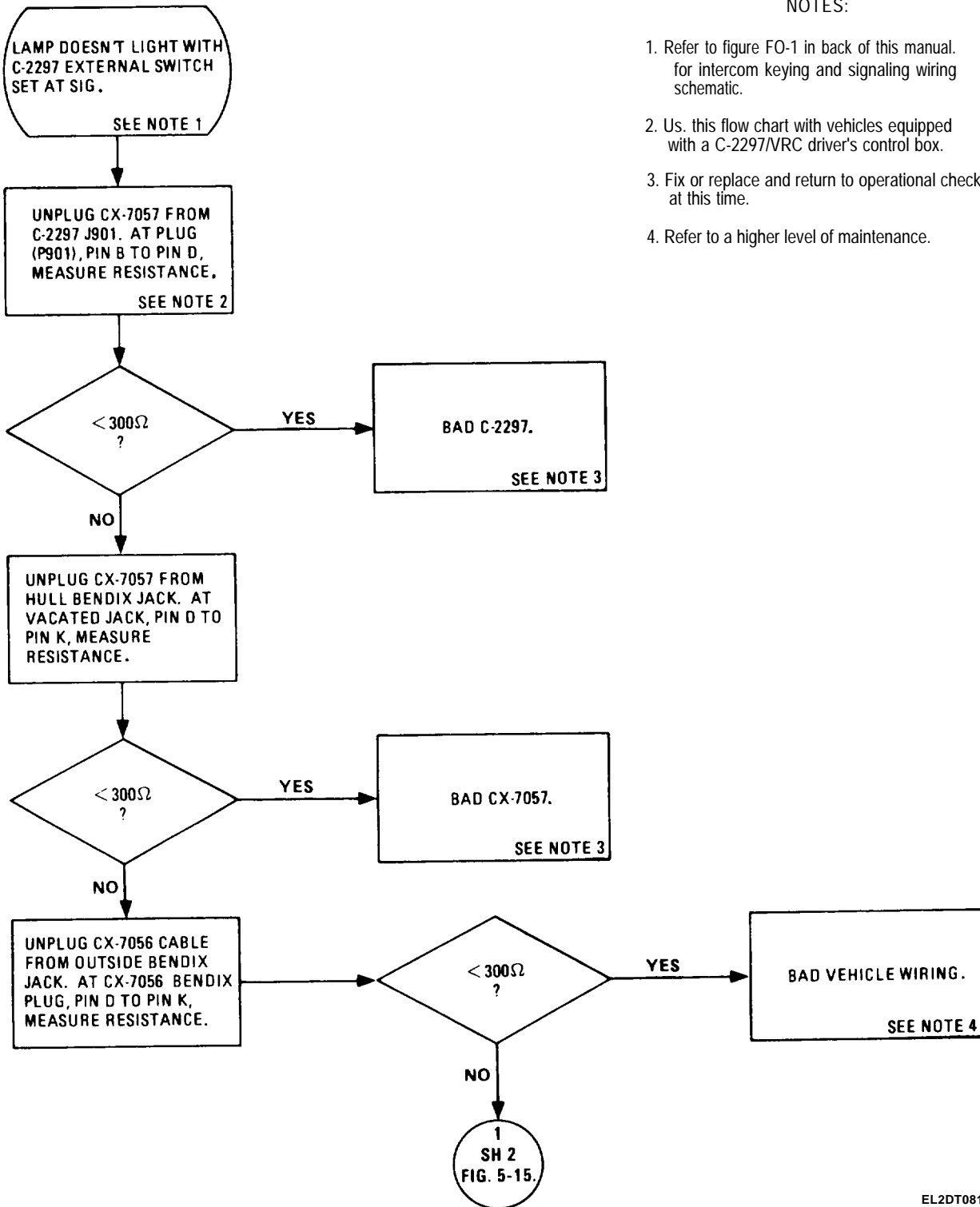

NOTES:

1. Refer to figure FO-1 in back of this manual. for intercom keying and signaling wiring schematic.
2. Us. this flow chart with vehicles equipped with a C-2297/VRC driver's control box.
3. Fix or replace and return to operational check at this time.
4. Refer to a higher level of maintenance.

EL2DT081

Figure 5-15. Troubleshooting intercom keying and signaling circuit, adverse open (Sheet 1 of 2).

5-9. Troubleshooting Flow Charts - Continued

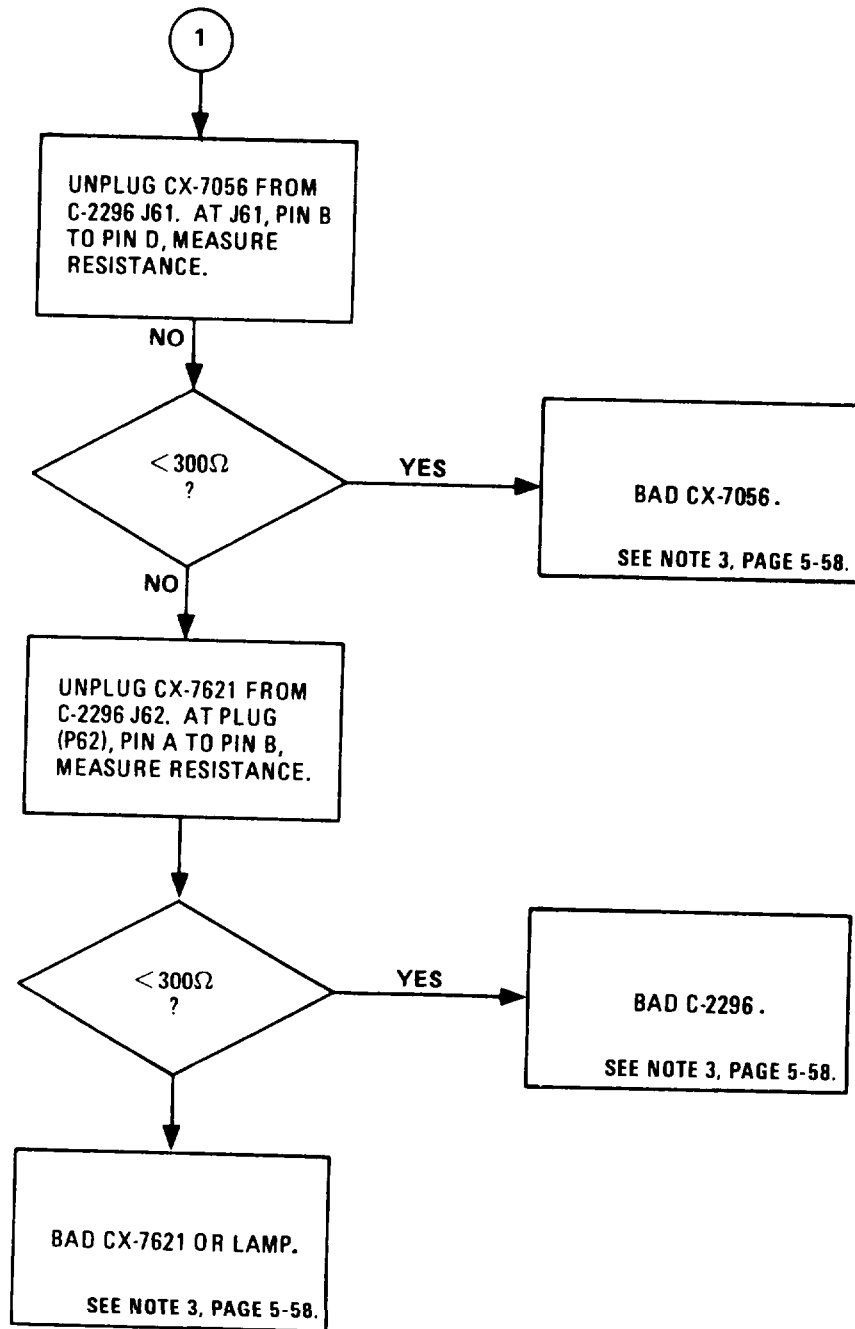

EL2DT082

Figure 5-15. Troubleshooting intercom keying and signaling circuit, adverse open (Sheet 2 of 2).

5-9. Troubleshooting Flow Charts - Continued

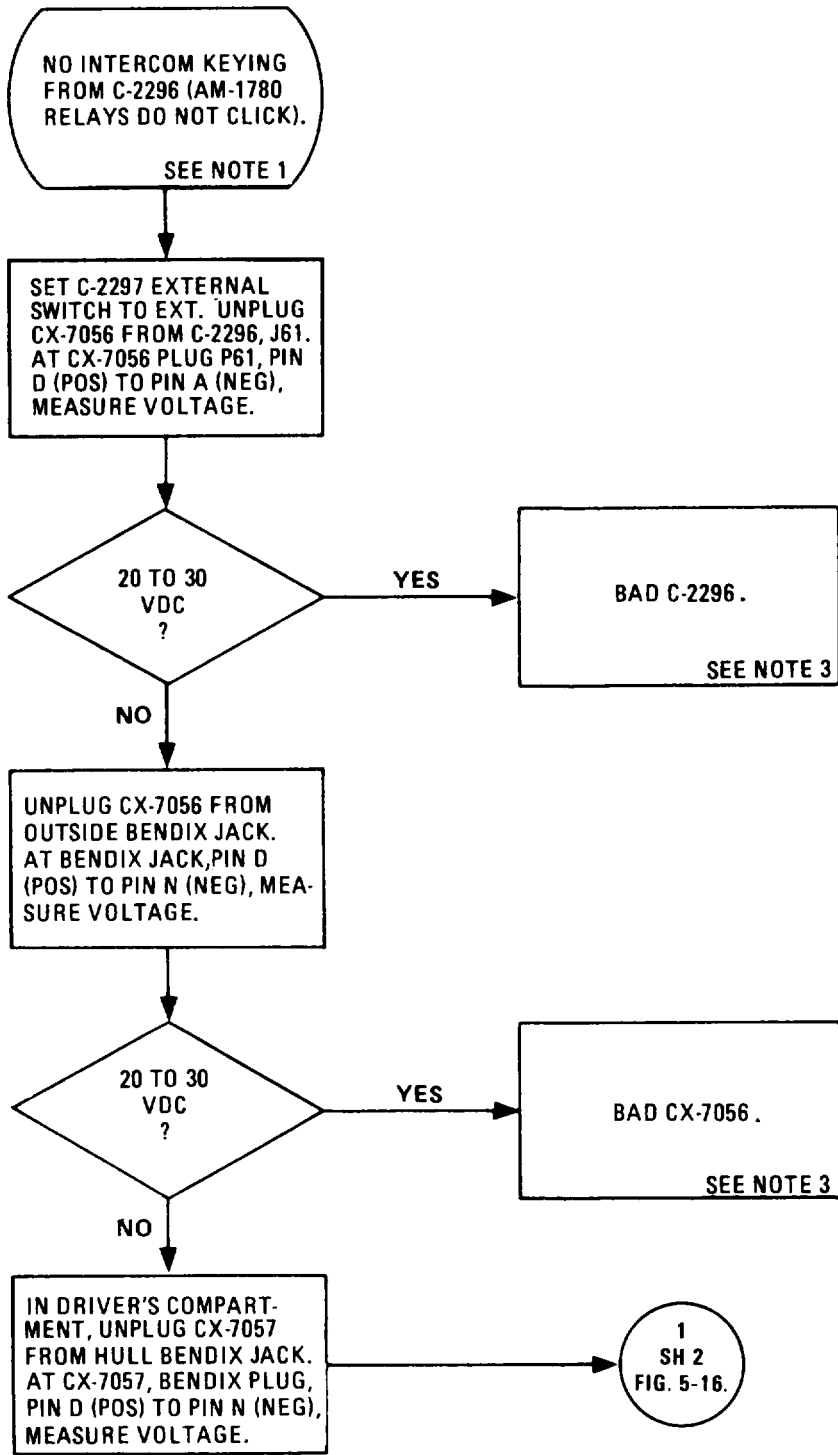

NOTES :

1. Refer to figure FO-1 in back of this manual.
2. Use this chart with vehicles equipped with e C-2297/VRC driver's control box and C-2296/VRC outside control box.
3. Fix or replace and return to operational check at this time.
4. Refer to higher maintenance level.

EL2DT083

Figure 5-16. Troubleshooting C-2296 intercom keying and signaling circuit, adverse open (Sheet 1 of 2).

5-9. Troubleshooting Flow Charts - Continued

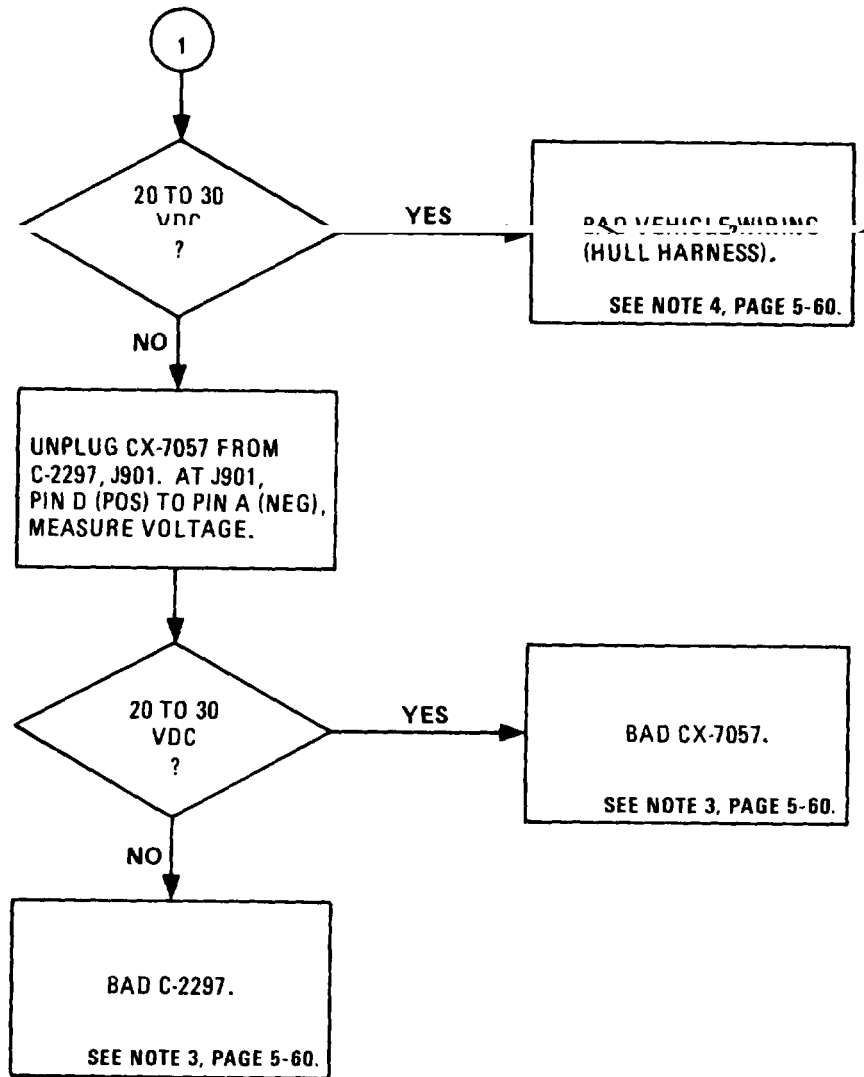

EL2DT084

Figure 5-16. Troubleshooting C-2296 intercom keying and signaling circuit, adverse open (Sheet 2 of 2).

5-9. Troubleshooting Flow Charts - continued

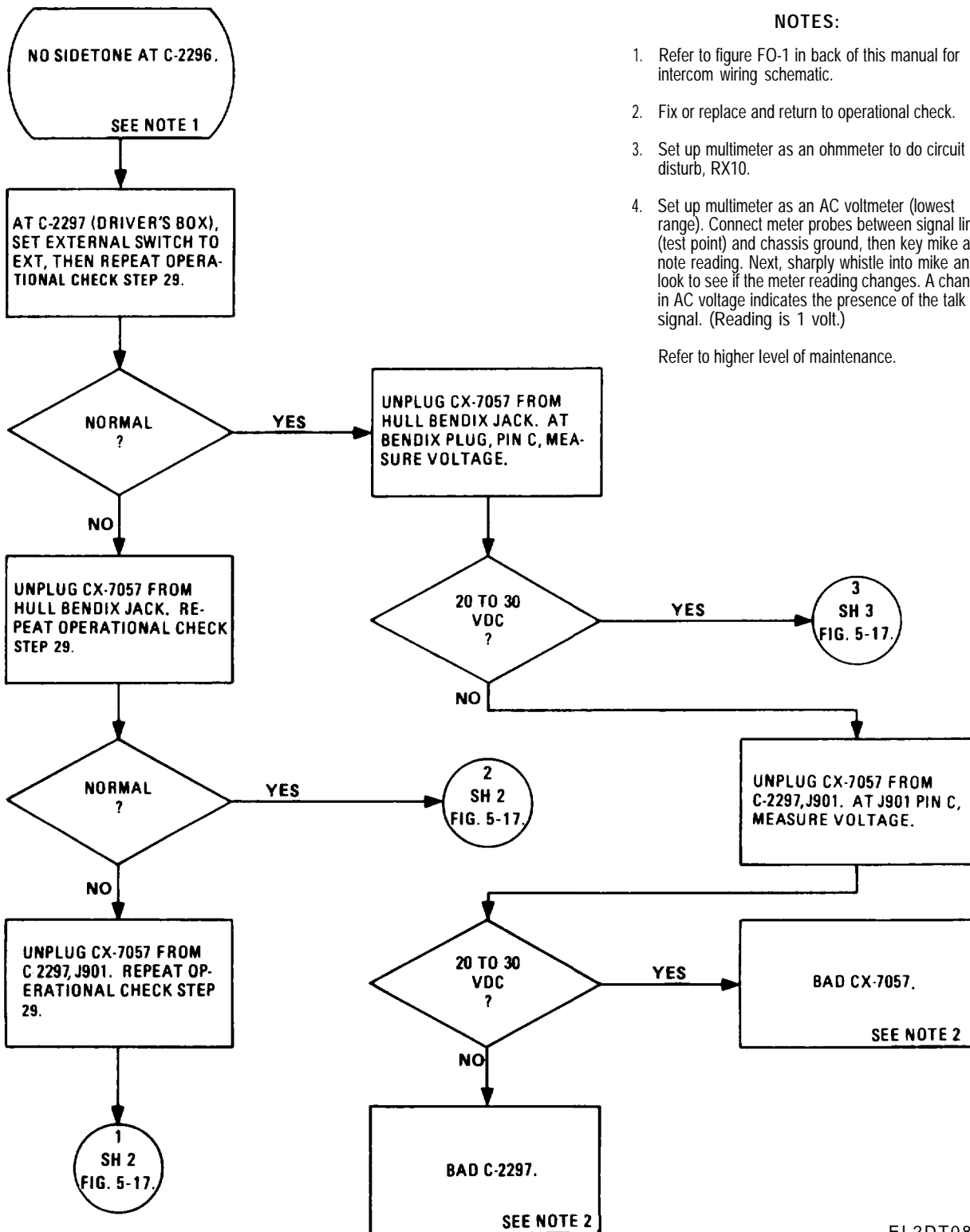

NOTES:

1. Refer to figure FO-1 in back of this manual for intercom wiring schematic.
2. Fix or replace and return to operational check.
3. Set up multimeter as an ohmmeter to do circuit disturb, RX10.
4. Set up multimeter as an AC voltmeter (lowest range). Connect meter probes between signal line (test point) and chassis ground, then key mike and note reading. Next, sharply whistle into mike and look to see if the meter reading changes. A change in AC voltage indicates the presence of the talk signal. (Reading is 1 volt.)

Refer to higher level of maintenance.

EL2DT085

Figure 5-17. Troubleshooting intercom talk/listen circuit, adverse for all positions of MONITOR switch (Sheet 1 of 5).

5-9. Troubleshooting Flow Charts - Continued

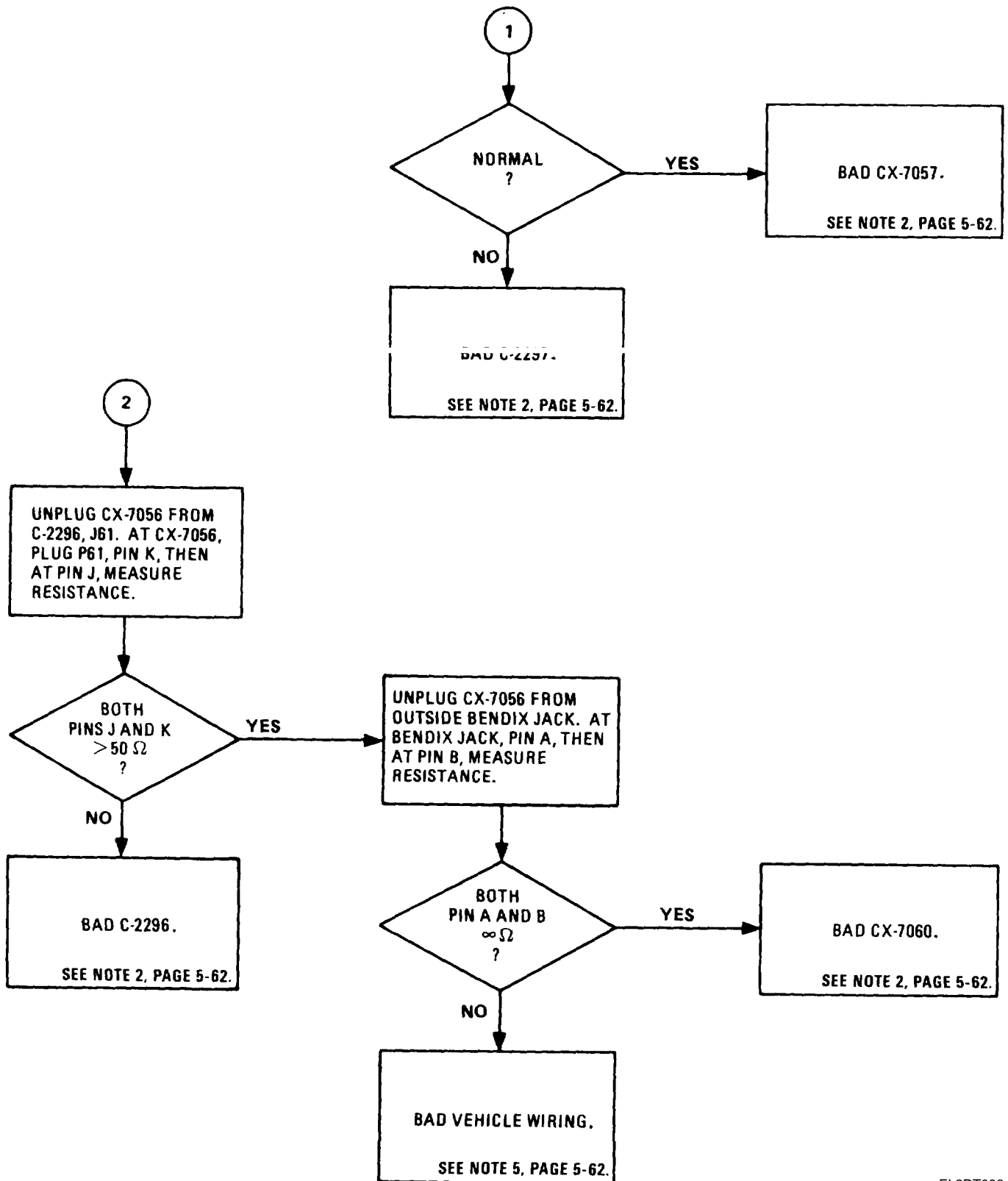

EL2DT086

Figure 5-17. Troubleshooting intercom talk/listen circuit, adverse for all positions of MONITOR switch (Sheet 2 of 5).

5-9. Troubleshooting Flow Charts - continued

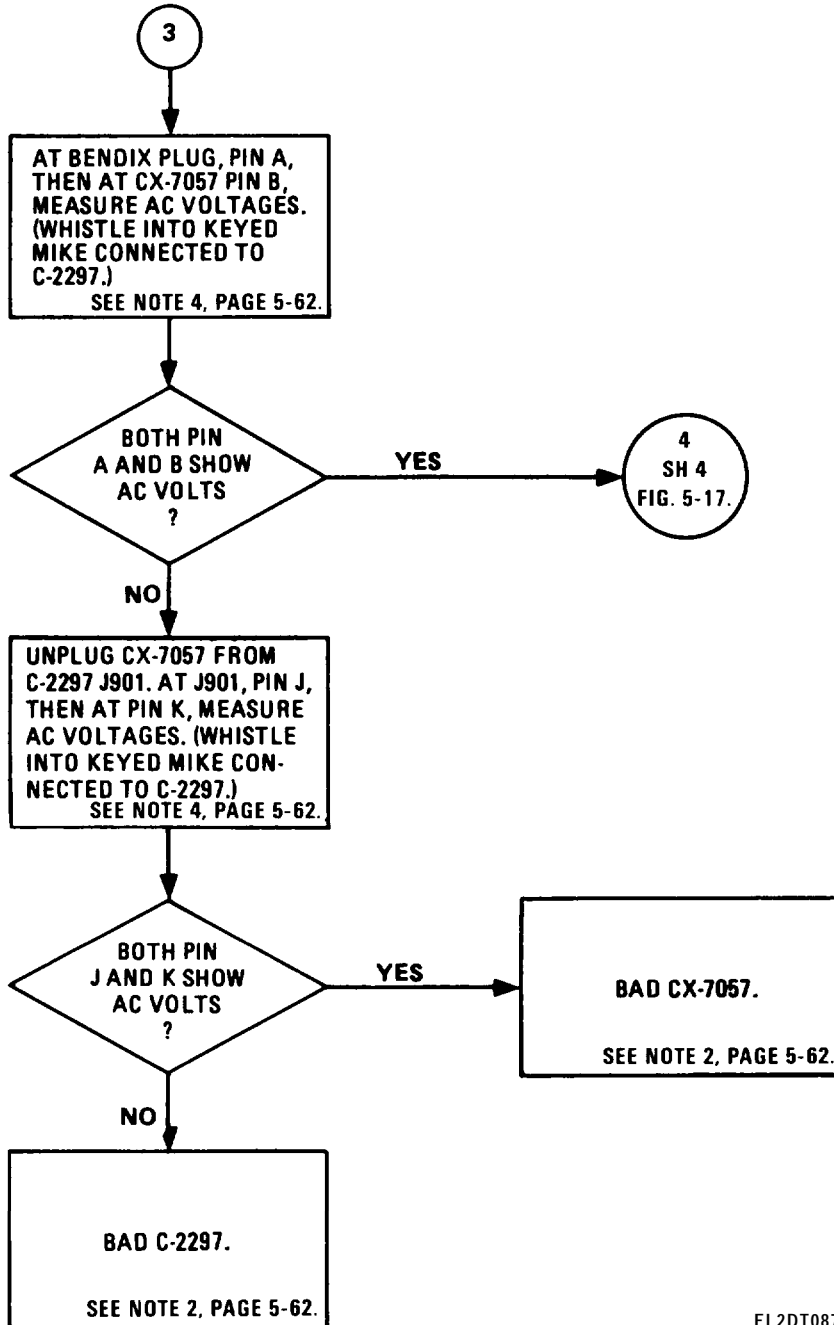

EL2DT087

Figure 5-17. Troubleshooting intercom talk/listen circuit, adverse for all positions of MONITOR switch (Sheet 3 Of 5).

5-9. Troubleshooting Flow Charts - Continued

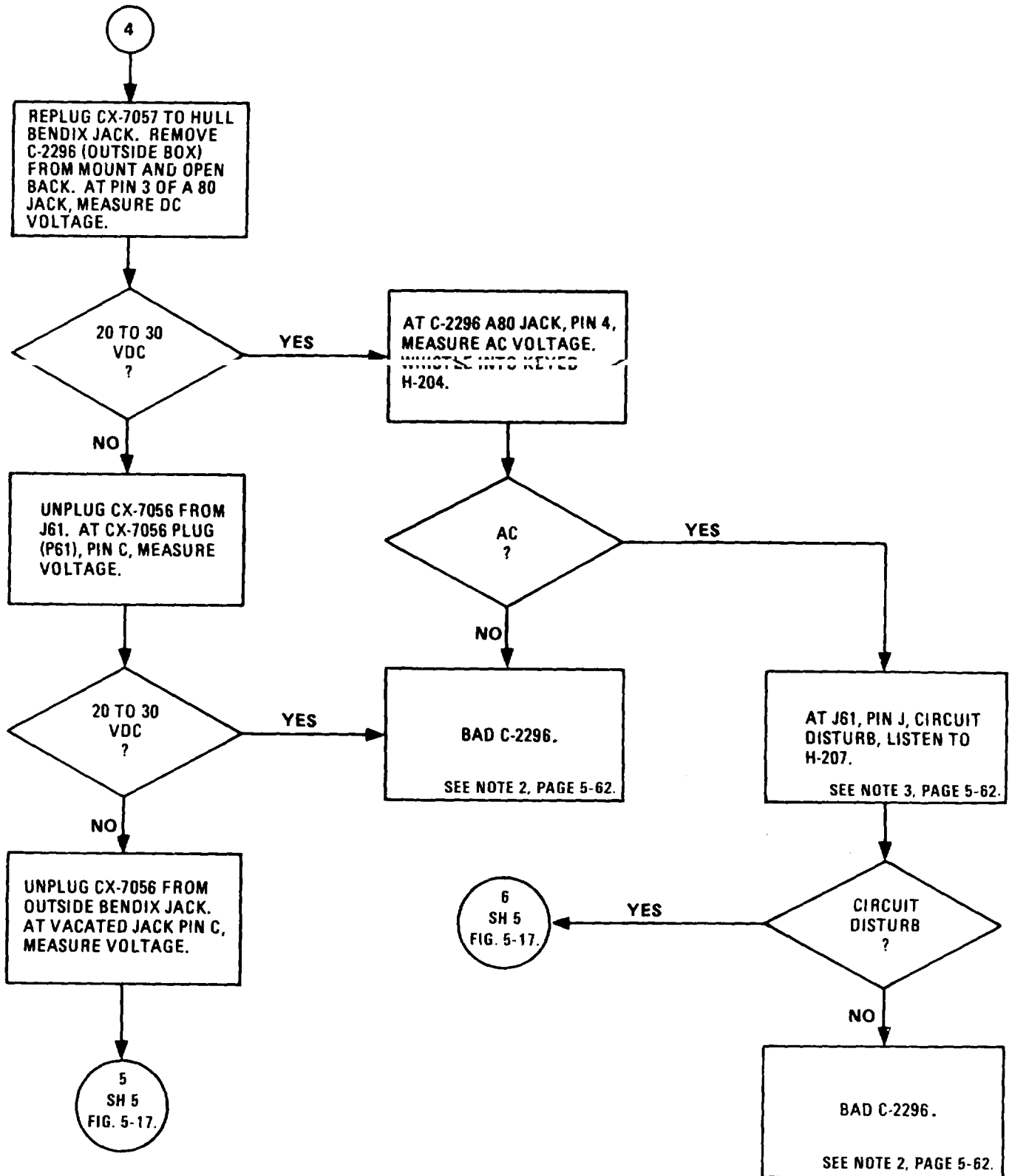

EL2DT088

Figure 5-17. Troubleshooting intercom talk/listen circuit, adverse for all positions of MONITOR switch (Sheet 4 of 5).

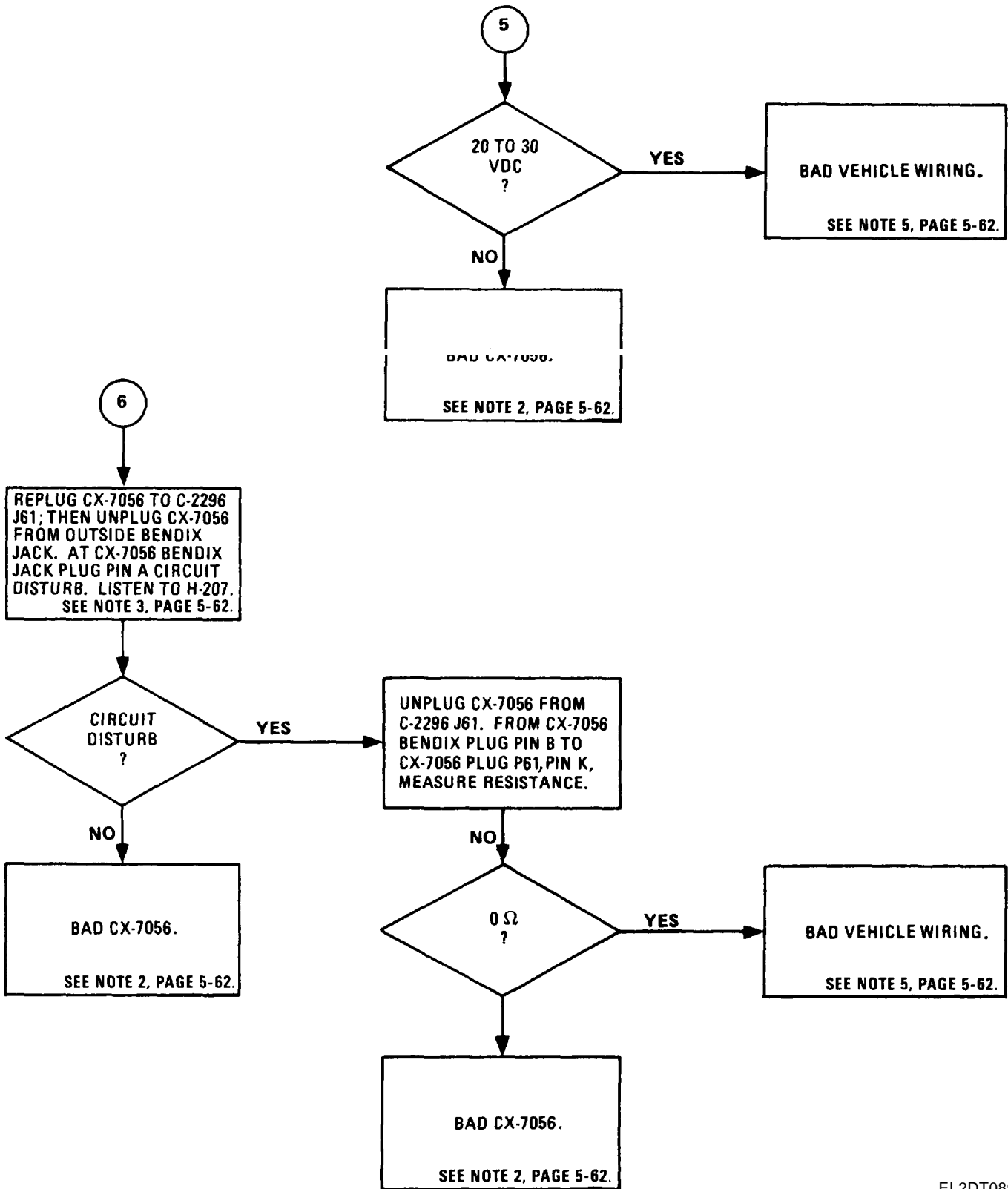

EL2DT089

Figure 5-17. Troubleshooting intercom talk/listen circuit, adverse for all positions of MONITOR switch (Sheet 5 of 5).

5-10. Troubleshooting C-10456/VRC in Radio-Intercom System

C-10456/VRC troubleshooting procedures for radio-intercom system are the same as those for the C-2298/VRC. To use the procedures, perform the following operations, in turn, at each C-10456/VRC:

- a.* Remove the remote keying control cable connected to the remote keying jack J805 (fig. 2-5),
- b.* Secure the remote keying dummy plug P805 to J805.
- c.* Operate the system. If the malfunction still exists, use the procedures outlined in the EPC.
- d.* If the system now operates normally, connect each remote keying control cable to the associated C-10456/VRC. Test the system after each cable connection. When malfunction reoccurs, remove the last remote keying cable connected, replace the dummy plug, P805, on J05. If the system operates normally, defect is isolated to the remote keying cable and/or switch associated with the remote keying cable. Refer

to maintenance level for the vehicle for the repair of the cable and/or switch.

5-11. Maintenance of AN/VIC-1(V) and Radio Intercom System

- a.* Repair of the AM-1780/VRC and control boxes includes replacing front panel knobs, indicator lamps, dust covers, and back cover assembly,
- b.* Parts for components of the radio intercom system (fig. 4-4 through 4-10), including the AN/VIC-1(V) are listed in SB 11-131 under the National stock number of the electronic equipment harness (para 1-10a(2)), accessory kits (para 1-10a(3)), and installation kit (para 1-10a(4) and (5)) applicable to the vehicle in which the equipment is installed. See also TM 11-5820-401-10-2-HR for listing of major components of the vehicle systems associated with the AN/VRC-12 series radios (para 1-6) and to TM 11-5820-498-12-HR for major components of the vehicle systems associated with AN/VRC-53, -64, AN/GRC-125, and -160.

CHAPTER 6

MATERIEL USED IN CONJUNCTION WITH INTERCOMMUNICATION SET AN/VIC-1(V)

6-1. General

Refer to paragraph 1-10 for information covering equipment required to make the AN/VIC-1(V) operational.

6-2. Description of Radio System Equipment

a. AN/VRC-12 Series Radios. The AN/VRC-12 series radios include Radio Sets AN/VRC-12, and AN/VRC-43 through AN/VRC-49. Figure 4-7 shows AN/VRC-12 used with the AN/VIC-1(V); figure 4-8 shows AN/VRC-49 used with the AN/VIC-1(V). These radio sets provide short-range, two-way, radio-telephone communication in 30.00 through 75.95 MHz range using frequency-modulated (fm) transmission and reception. The receiver-transmitters of these radio sets can transmit on low (approximately 5 watts) and high (approximately 35 watts) rf power. Description and operation of the radios in conjunction with the AN/VIC-1(V) in the radio-intercom system are provided in TM 11-5820-401-10-2.

b. Radio Teletypewriter Set AN/VSC-3. When the AN/VSC-3, which includes Radio Set AN/GRC-106 or AN/GRC-106A, is used with the AN/VIC-1(V), it is connected to J503 of the AM-1780/VRC (fig. 4-7) as "C" radio. Operating procedures are provided in TM 11-5815-332-15.

c. Radio Sets AN/VRC-53, AN/VRC-64, AN/GRC-125, and AN/GRC-160. These radio set configurations are similar to AN/VRC-12 series radios (*a* above) except they transmit only on low power (approximately 5 watts maximum). Figure 4-9 shows AN/VRC-53 or AN/VRC-64 used with the AN/VIC-1(VI). Description and operation of the radios in conjunction with the AN/VIC-1(V) in the radio-intercom system are provided in TM 11-5820-498-12.

6-3. Description of Audio Accessories

The following or equivalent audio accessories can be used with the radios and radio system equipment. Information on the use of the audio accessories is discussed in paragraph 2-8.

a. Hand Microphone. The microphone used with the equipment is Microphone, Dynamic (fig. 2-6). It has a push-to-talk switch, a microphone element behind which is a noise-cancelling element, and a retractile cord terminated in a five-pin connector.

b. Headsets. Typical headsets include Headsets, Electrical H-140A/U (TM 11-5965-260-24P) and H-251/U (fig. 2-6). The headsets have a pair of earphones separated by a spring-steel band and each

earphone assembly is provided with a rubber cushion to fit over the user's ears. A retractile cord is terminated in a five-pin connector.

c. Handsets. Typical handsets include Handsets H-250/U, H-189/GR (TM 11-5965-280-15), and H-138/GR (TM 11-5965-257-15). A handset includes a dynamic microphone, earphone, and a push-to-talk switch. A retractile cord is terminated in a five-pin connector.

d. Headset-Microphone. Typical headset-microphone is Headset-Microphone H-161/U (TM 11-5965-262-13) (fig. 2-6). It has a pair of earphones similar to those on the headsets (*b* above), and a dynamic microphone mounted on a boom that can be positioned in front of the user's lips. Neck and body bands are used to attach the switch assembly to the user's body. The switch assembly contains a three-position switch and a retractile cord, CX-8650(*)/GR terminated in a pair of five-pin connectors. The retractile cord is connected to the switch assembly section by means of quick-disconnect connectors (bail-out connectors). In some installation kits, CX-8650(*)/GR may be replaced with longer retractile cord assemblies (para 2-6a).

e. Helmets with Installed Audio Accessories. Some crewmembers are issued their own size Combat Vehicle Crewmember (CVC) DH-132 Helmet (fig. 2-9) or Armored Vehicle Crewmember (AVC) DH-132A Helmet (fig. 2-8). The AVC helmet will be issued as a direct replacement for the CVC helmet. Each unit includes straps for adjusting the helmet to the user's head and for holding the earphones of the audio accessory. Maintenance of both helmets is provided in TM 10-8400-201-23. A typical audio accessory used in the CVC helmet is Headset-Microphone Kit MK-1039/G (TM 11-5965-282-15). A typical audio accessory used in the AVC helmet is Headset-Microphone Kit MK-1697/G (TM 11-5965-286-14). Each audio accessory has a switch assembly attached to the side of the helmet, earphones which are attached inside the helmet, a dynamic microphone mounted on a boom that can be positioned in front of the user's lips, and a retractile cord, CX-8650(*)/GR, with bail-out connectors, and terminated in a pair of five-pin connectors. In some installation kits, CX-8650(*)/GR may be replaced with longer retractile cord assemblies (para 2-6a).

f. Loudspeaker and Extension Cord. Typical loudspeaker available is Loudspeaker LS-454/U (fig. 2-7) (TM 11-5965-255-15P). It is provided with a cord terminated in a five-pin connector. The loudspeaker

case has a clamp to enable the unit to be mounted in a convenient place near the equipment. Cable Assembly, Special Purpose, Electrical CX-7867/VRC (of various lengths) can be used between the equipment and the loudspeaker to enable the loudspeaker to be located at a distance from the equipment.

6-4. Cable Assemblies Used With Radio Sets and Radio-Intercom Systems

(fig. 4-1)

Following are typical cable assemblies that may be used with the radios and radio-intercom system. Each cable assembly is available in various lengths suitable to the vehicle in which it is used (SB 11-131). Most of the cable assemblies are shown installed in figures 4-4 through 4-10.

a. Cable Assembly, Special Purpose, Electrical CX-4722/VRC. This cable assembly is the control cable between the receiver-transmitters and the antenna matching unit. It has two 12-terminal connectors; a male on one end and female on the other.

b. Cable Assembly, Radio Frequency CG-1773/U. This rf antenna cable assembly is used to connect the radio to the antenna. It is type RG-58/U cable terminated on one end with a right-angle BNC connector and on the other end with a straight BNC connector. An adapter UG-306/U is provided in some installations to provide less strain on the CG-1773/U in its position in the equipment.

c. Cable Assembly, Radio Frequency CG-1127/U. This is a short rf cable assembly used between two R-442(*)/VRCs. It is type RG-58/U terminated on both ends with a right-angle BNC connector.

d. Cable Assembly, Special Purpose, Electrical CX-4723/VRC. This cable is the type most commonly used throughout the radio-intercom system. It is terminated in 18-terminal male connectors at both ends.

e. Cable Assembly, Special Purpose, Electrical CX-7056/VRC. This cable has a nine-terminal male connector on one end and a 14-terminal male connector on the other.

f. Cable Assembly, Special Purpose, Electrical CX-7057/VRC. This cable has a 14-terminal female connector on one end and a nine-terminal male connector on the other.

g. Cable Assembly, Special Purpose, Electrical CX-7058/VRC. This cable has a nine-terminal male connector on each end.

h. Cable Assembly, Special Purpose, Electrical CX-7059/VRC. This cable has a 19-terminal male connector on one end and an 18-terminal male connector

on the other.

i. Cable Assembly, Special Purpose, Electrical CX-7060/VRC. This cable has an 18-terminal male connector on one end and a 14-terminal male connector on the other.

j. Cable Assembly Special Purpose, Electrical CX-7621/VRC. This is a short two-wire cable terminated on one end with a four-terminal male connector attached to the C-2296/VRC and a pair of tinned wires on the other end to be attached to the external call lamp on the box containing the C-2296/VRC on the outside of some vehicles.

k. Cable Assembly,, Special Purpose, Electrical CX-9640/VRC. This is a five-wire cable terminated on both ends with an 18-terminal male connector.

l. Cable Assembly, Power, Electrical CX-4720/VRC (fig. 4-11). This power cable is terminated on one end with a four-terminal female connector and on the other end the four wires are paired and tinned. The tinned pairs are connected to terminal lugs or a Bendix connector, as required for the installation of each particular vehicle.

m. Cable Assembly, Power, Electrical CX-4721/VRC. This power cable is terminated on one end with a four-terminal female connector and a four-terminal male connector on the other.

6-5. Power Supply PP-2953(*)/U

The PP-2953(*)/U (TM 11-6130-233-12) is used to provide regulated and filtered 27.2 volts dc from an ac power source. It may be used in fixed installations to provide power for radios or the AM-1780/VRC.

a. Ac power sources may be 115 volts, 50-60 Hz, 4 amperes maximum; 230 volts, 50-60 Hz, 2 amperes, maximum; and 115 volts, 400 Hz, 4 amperes, maximum.

b. The regulated 27.2 volts output (fixed; but variable to 22 volts dc output by internal control) is applied through CX-4721/VRC to the radio or J508 of AM-1780/VRC.

c. Transformer, Variable TF-523/U (TM 11-5950-212-15) can be used with the PP-2953(*)/U to provide controlled ac input when the ac power source voltage is beyond the ac input limits of the PP-2953(*)/U.

6-6. Electrical Transient Suppressor MX-7778(*)/GRC

The MX-7778(*)/GRC consists of suppressor MX-7777(*), Cable CX-10613, and all other items needed to complete the installation.

APPENDIX A REFERENCES

AR 55-38	Reporting of Transportation Discrepancies in Shipments (NAVSUPINST 4610.33C; AFR 75-18; MCO P4610.19D; DLAR 4500.15)
AR 735-11-2	Reporting of Item and Packaging Discrepancies (DLAR 4140.55; AFR 4355,73A; AFR 400-54; MCO 4430.3F)
DA Pam 25-35	Consolidated Index of Army Publications and Blank Forms.
DA Pam 738-750	The Army Maintenance Management System (TAMMS).
DA Pam 750-10	US Army Equipment Index of Modification Work Orders.
SB 11-131	Vehicular Radio Sets and Authorized Installations.
SB 11-573	Painting and Preservation Supplies Available for Field Use for Electronics Command Equipment.
SB 11-624	Warning Notice for Vehicles in Which Radios are Mounted.
TB 385-4	Safety Precautions for Maintenance of Electrical/Electronic Equipment.
TB 43-0118	Field Instructions for Painting and Preserving Electronic Command Equipment Including Camouflage Pattern Painting of Electrical Equipment Shelters.
TM 10-8400-201-23	Organizational and Direct Support Maintenance Manual: General Repair Procedures for Clothing and Individual Equipment
TM 11-2300-372-14-2	Instructions for Installing Installation Kits, Electronic Equipment MK-1255/VIC-I(V), MK-1256/VIC-I(V), and MK-1257/VIC-I(V) in Truck, Cargo, 1/4 Ton, 6 X 6, M561 for Intercommunication Set AN/VIC-I(V).
TM 11-5815-332-15	Operator's, Organizational, Direct Support General Support and Depot Maintenance Manual: Radio Teletypewriter Set, AN/VSC-3 (NSN 5815-00-224-8130) and AN/VSC-3A (5815-01-102-5916) (Reprinted W/Basic Incl C1-10)
TM 11-5820-401-10-2	Operator's Manual, Radio Sets, AN/VRC-12 (NSN 5820-00-223-7412), AN/VRC-43 (5820-00-223-7415), AN/VRC-44 (5820-00-223-7417), AN/VRC-45 (5820-00-223-7418), AN/VRC-46 (5820-00-223-7433), AN/VRC-47 (5820-00-223-7434), AN/VRC-48 (5820-00-223-7435) and AN/VRC-49 (5820-00-223-7437) (Used with an Intercom System)
TM 11-5820-401-10-2-HR	Hand Receipt Manual Covering the End Item/Components of End Items (COEI), Basic Issue Items (BII) and Additional Authorization List (AAL) for Radio Sets, AN/VRC-12 (NSN 5820-00-223-7412), AN/VRC-43 (5820-00-223-7415), AN/VRC-44 (5820-00-223-7417), AN/VRC-45 (5820-00-223-7418), AN/VRC-46 (5820-00-223-7433), AN/VRC-47 (5820-00-223-7434), AN/VRC-48 (5820-00-223-7435), and AN/VRC-49 (5820-00-223-7437) (Used With Intercom System).
TM 11-5820-401-20-2	organizational Maintenance Manual for Radio Sets, AN/VRC-12 (NSN 5820-00-223-7412), AN/VRC-43 (5820-00-7415), AN/VRC-44 (5820-00-223-7417), AN/VRC-45 (5820-00-223-7418), AN/VRC-46 (5820-00-223-7433), AN/VRC-47 (5820-00-223-7434), AN/VRC-48 (5820-00-223-7435) and AN/VRC-49 (5820-00-223-7437) (Used W/Intercom System, AN/VIC-I(V) (EE 150-JA-MMO-020/E 154-VRC-12, 43)
TM 11-5820-498-12	Operator's and Organizational Maintenance Manual: Radio Sets, AN/VRC-53 (NSN 5820-00-223-7467), AN/VRC-64 (5820-00-223-7475), AN/GRC-125 (5820-00-223-7411) and AN/GRC-160 (5820-00-223-7473) and Amplifier Power Supply Groups OA-3633/GRC and OA-3633A/GRC (5820-00-973-3383) (Reprinted W/Basic Incl C1-9)
TM 11-5820-498-12-HR	Hand Receipt Manual Covering End Item/Components of End Item (COEI), Basic Issue Items (BH), and Additional Authorization List (AAL) for Radio Sets, AN/VRC-53 (NSN 5820-00-223-7467), AN/VRC-63 (5820-00-223-7475), AN/GRC-125 (5820-00-223-7411) and AN/GRC-160 (5820-00-223-7473)

TM 11-5830-340-12

- TM 11-5820-667-12 **Operator's and Organizational Maintenance Manual: Radio Set AN/PRC-77 (NSN 5820-00-930-3724) (Including Receiver-Transmitter, Radio RT-841/PRC-77) (5820-00-930-3725) (Reprinted W/Basic Incl C1-8).**
- TM 11-5820-898-20P **Organizational Maintenance Repair Parts and Special Tools List for Amplifiers, Audio Frequency AM-1780A/VRC (NSN 5820-01-147-8637) and AM-1780B/VRC (5895-01-284-3057).**
- TM 11-5830-340-23P **Organizational and Direct Support Maintenance Repair Parts and Special Tools List for Inter-communications Set AN/VIC-1(V) (NSN 5830-00-856-3273).**
- TM 11-5895-1548-24P **Unit, Direct Support and General Support Maintenance Repair Parts and Special Tools List for Amplifier, Audio Frequency AM-1780B/VRC (NSN 5895-01-284-3057).**
- TM 11-5895-1548-34 **Direct Support and General Support Maintenance Manual for Amplifier, Audio Frequency AM-1780B/VRC (NSN 5895-01-284-3057).**
- TM 11-5915-223-12 **Operator's and Organizational Maintenance Manual Including Repair Parts and Special Tools Lists: Suppressor, Electrical Transient MX-7778/GRC (NSN 5915-00-937-9564).**
- TM 11-5915-224-14 **Operator's, Organizational, Direct Support, and General Support Maintenance Manual Including Repair Parts and Special Tools List: Suppressor, Electrical Transient MX-778A/GRC (NSN 5915-00-413-6718).**
- TM 11-5950-212-15 **Operator's, Organizational, DS, GS, and Depot Maintenance Manual Including Repair Parts and Special Tools Lists: Transformer, Variable Power TF-523/U (NSN 5950-00-926-0742).**
- TM 11-5965-255-14P **Operator, Organizational, Direct and General Support Maintenance Repair Parts and Special Tools Lists (Including Depot Maintenance Repair Parts and Special Tools): Loudspeaker, Permanent Magnet LS-454/U (NSN 5965-00-892-3538).**
- TM 11-5965-257-15 **Operator's, Organizational, Direct Support, General Support, and Depot Maintenance Manual (Including Repair Parts and Special Tools Lists): Handset H-138/U (NSN 5985-00-892-0972).**
- TM 11-5965-260-24P **Organizational, Direct Support and General Support Maintenance Repair Parts and Special Tools Lists (Including Depot Maintenance Repair Parts and Special Tools): Headset, Electrical H-140A/U (NSN 5965-00-892-0972).**
- TM 11-5965-262-13 **Organizational and DS Maintenance Manual Including Repair Parts and Special Tool Lists: Headset-Microphones H-161/U and H-161A/U (NSN 5965-00-082-4037 and 5965-00-824-4871).**
- TM 11-5965-280-15 **Operator's, Organizational, Direct Support, General Support, and Depot Maintenance Manual (Including Repair Parts and Special Tools Lists): Handset H-189/GR (NSN 5965-00-069-8886).**
- TM 11-5965-282-15 **Organizational, DS, GS, and Depot Maintenance Manual Including Repair Parts and Special Tools Lists: Headset-Microphone Kit MK-1039/G.**
- TM 11-5965-286-14 **Operator's, Organizational, Direct Support, and General Support Maintenance Manual: Headset-Microphone Kit MK-1697/G (NSN 5965-00-313-8958).**
- TM 11-5965-286-23P **Organizational and Direct Support Maintenance Repair Parts and Special Tool Lists for Headset-Microphone Kit MK-1697/G (NSN 5965-00-313-8958).**
- TM 11-6130-233-12 **Operator's and Organizational Maintenance Manual: Power Supplies, PP-2953/U, PP-2953A/U, PP-2953B/U and PP-2953C/U (NSN 6130-00-985-7899).**
- TM 11-6625-3199-14 **Operator's, Unit, Intermediate Direct Support, and General Support Maintenance Manual for Digital Multimeter AN/PSM-45A (NSN 6625-01-265-6000).**
- TM 740-90-1 **Administrative Storage of Equipment.**
- TM 750-244-2 **Procedures for Destruction of Electronics Materiel to Prevent Enemy Use (Electronics Command).**

APPENDIX B

MAINTENANCE ALLOCATION CHART (MAC)

Section I. INTRODUCTION

B.1 THE ARMY MAINTENANCE SYSTEM MAC.

a. This introduction (section 1) provides a general explanation of all maintenance and repair functions authorized at various maintenance levels under the standard Army Maintenance System concept.

b. The Maintenance Allocation Chart (MAC) in section II designates overall authority and responsibility for the performance of maintenance functions on the identified end item or component. The application of the maintenance functions to the end item or component will be consistent with the capacities and capabilities of the designated maintenance levels, which are shown on the MAC in column (4) as:

Unit – includes two subcolumns, C (operator/crew) and O (unit) maintenance.

Direct Support – includes an F subcolumn.

General Support – includes an H subcolumn.

Depot - includes a D subcolumn.

c. Section III lists the tools and test equipment (both special tools and common tool sets) required for each maintenance function as referenced from section ii.

d. Section IV contains supplemental instructions and explanatory notes for a particular maintenance function.

B.2 MAINTENANCE FUNCTIONS.

Maintenance functions are limited to and defined as follows:

a. **Inspect** To determine the serviceability of an item by comparing its physical, mechanical, and/or electrical characteristics with established standards through examination (e.g., by sight, sound, or feel).

b. **Test.** To verify serviceability by measuring the mechanical, pneumatic, hydraulic, or electrical characteristics of an item and comparing those characteristics with prescribed standards.

c. **Service.** Operations required periodically to keep an item in proper operating condition; e.g., to clean (includes decontaminate, when required), to preserve, to drain, to paint, or to replenish fuel, lubricants, chemical fluids, or gases.

d. **Adjust.** To maintain or regulate, within prescribed limits, by bringing into proper position, or by setting the operating characteristics to specified parameters.

e. **Align.** To adjust specified variable elements of an item to bring about optimum or desired performance.

f. **Calibrate.** To determine and cause corrections to be made or to be adjusted on instruments or test, measuring, and diagnostic equipment used in precision measurement. Consists of comparisons of two instruments, one of which is a certified standard of known accuracy, to detect and adjust any discrepancy in the accuracy of the instrument being compared.

g. **Remove/Install.** To remove and install the same item when required to perform service or other maintenance functions. Install maybe the act of emplacing, seating, or fixing into position a spare, repair part, or module (component or assembly) in a manner to allow the proper functioning of an equipment or system.

h. **Replace.** To remove an unserviceable item and install a serviceable counterpart in its place. "Replace" is authorized by the MAC and assigned maintenance level is shown as the third position code of the SMR code.

i. **Repair.** The application of maintenance services¹ including fault location/troubleshooting², removal/installation, and disassembly/assembly³ procedures, and maintenance actions⁴ to identify troubles and restore serviceability to an item by correcting specific damage, fault, malfunction, or failure in a part, subassembly, module (component or assembly), end item or system.

j. **Overhaul.** That maintenance effort (service/action) prescribed to restore an item to a completely serviceable/operational condition as required by maintenance standards in appropriate technical publications (i.e., DMWR). Overhaul is normally the highest degree of maintenance performed by the Army. Overhaul does not normally return an item to like new condition.

k. **Rebuild.** Consists of those services/actions necessary for the restoration of unserviceable equipment to a like new condition in accordance with original manufacturing standards, Rebuild is the highest degree of materiel maintenance applied to Army equipment. The rebuild operation includes the act of returning to zero those age measurements (e.g., hours/miles) considered in classifying Army equipment/components.

¹ Services – Inspect, test, service, adjust, align, calibrate, and/or replace.

² Fault location/troubleshooting – The process of investigating and detecting the cause of equipment malfunctioning; the act of isolating a fault within a system or unit under test (UUT).

³ Disassembly/assembly – The step-by-step breakdown (taking apart) of a spare/functional group coded item to the level of its least component, that is assigned an SMR code for the level of maintenance under consideration (i.e., identified as maintenance significant)

⁴ Actions – Welding, grinding, riveting, straightening, facing, machining, and/or resurfacing.

B.3 EXPLANATION OF COLUMNS IN MAC, SECTION II.

a. *Column 1, Group Number.* Column 1 lists functional group code numbers, the purpose of which is to identify maintenance significant components, assemblies, subassemblies, and modules with the next higher assembly.

b. *Column 2, Component/Assembly.* Column 2 contains the item names of components, assemblies, subassemblies, and modules for which maintenance is authorized.

c. *Column 3, Maintenance Function.* Column 3 lists the functions to be performed on the item listed in column 2. (For detailed explanation of these functions, see para B-2.)

d. *Column 4, Maintenance Level.* Column 4 specifies each level of maintenance authorized to perform each function listed in column 3, by indicating work time required (expressed as man-hours in whole hours or decimals) in the appropriate subcolumn. This work-time figure represents the active time required to perform that maintenance function at the indicated level of maintenance. If the number or complexity of the tasks within the listed maintenance function vary at different maintenance levels, appropriate work-time figures are to be shown for each level. The work-time figure represents the average time required to restore an item (assembly, subassembly, component, module, end item or system) to a serviceable condition under typical field operating conditions. This time includes preparation time (including any necessary disassembly/assembly time), troubleshooting/ fault location time, and quality assurance time in addition to the time required to perform the specific tasks identified for the maintenance functions authorized in the maintenance allocation chart. The symbol designations for the various maintenance levels are as follows:

- C** Operator or crew maintenance
- O** Unit maintenance
- F** Direct support maintenance
- L** Specialized Repair Activity (SRA)⁵
- H** General support maintenance
- D** Depot maintenance

⁵ This maintenance level is not included in Section II, column (4) of the Maintenance Allocation Chart. Functions to this level of maintenance are identified by a work-time figure in the "H" column of Section II, column (4), and an associated reference code is used in the Remarks column (6). This code is keyed to Section IV, Remarks, and the SRA complete repair application is explained there.

e. **Column 5, Tools and Test Equipment Reference Code.** Column 5 specifies, by code, those common tool sets (not individual tools), common TMDE, and special tools, special TMDE, and special support equipment required to perform the designated function. Codes are keyed to tools and test equipment in section III.

f. **Column 6, Remarks.** When applicable, this column contains a letter code, in alphabetical order, which is keyed to the remarks contained in Section IV.

B.4 EXPLANATION OF COLUMNS IN TOOLS AND TEST EQUIPMENT SECTION III.

a. **Column 1, Reference Code.** The tool and test equipment reference code correlates with a code used in the MAC, section II, column 5.

b. **Column 2, Maintenance Level.** The lowest level of maintenance authorized to use the tool or test equipment.

c. **Column 3, Nomenclature.** Name or identification of the tool or test equipment.

d. **Column 4, National Stock Number.** The national stock number of the tool or test equipment.

e. **Column 5, Tool Number.** The manufacturer's part number, model number, or type number.

B.5. EXPLANATION OF COLUMNS IN REMARKS, SECTION IV.

a. **Column 1, Remarks Code.** The code recorded in column 6, Section II.

b. **Column 2, Remarks.** This column lists information pertinent to the maintenance function being performed as indicated in the MAC, section II.

Section II. MAINTENANCE ALLOCATION CHART
FOR
INTERCOMMUNICATION SET AN/VIC- 1(V)

(1) GROUP NUMBER	(2) COMPONENT/ASSEMBLY	(3) MAINTENANCE FUNCTION	(4) MAINTENANCE LEVEL					(5) TOOLS AND EQUIPMENT REF CODE	(6) REMARKS CODE
			UNIT		DIRECT SUPPORT	GENERAL SUPPORT	DEPOT		
			C	O	F	H	D		
00	Intercommunication Set AN/VIC-1(V)	Inspect	.25						
		Service	.5						A
		Test		.5				1	B
		Install		.5				2	
		Repair		1.0				2	C
01	Amplifier, Audio Frequency AM-1780/VRC	Inspect	.25						
		Service	.25						A
		Test		.25					B
		Test			1.0			1,4-9, 12-14,18, 20	D
		Test			1.0			1,4-7,9 12-14,18 20	I
		Adjust			.5			1,4-9	E
		Replace		.25				2	H
		Repair		.25				2	F
Repair				2.5		3,15	G		
02	Control, Intercommunication Set C-2296/VRC	Inspect	.1						
		Service	.1						A
		Test		.1					B
		Test			.5			1,4-8,13, 14,30	D
		Test			.5			4-8,13, 14,30	I
		Test			.5			4,24-27, 29,31-34, 36,37,38 OR 4,24-27, 31-35,38, 39	J
		Repair		.25				2	F
		Repair				1.5		3,15	G
Replace		.5				2			
03	Control, Intercommunication Set C-2297/VRC	Inspect	.1						
		Service	.1						A
		Test		.1					B
		Test			.5			1,4-8,10, 12,13,14, 30	D
		Test			.5			4-8,10,12 13,14,30	I
Test			.75			4,24-28, 31-34,36, 38,40	J		

(1) GROUP NUMBER	(2) COMPONENT/ASSEMBLY	(3) MAINTENANCE FUNCTION	(4) MAINTENANCE LEVEL					(5) TOOLS AND EQUIPMENT REF CODE	(6) REMARKS CODE
			UNIT		DIRECT SUPPORT	GENERAL SUPPORT	DEPOT		
			C	O	F	H	D		
04	Control, Intercommunication Set C-2298/VRC	Repair		.25				OR 4,24-27, 31-35, 38-40	F
		Repair			1.5			2	G
		Replace		.5				3,15	
								2	
		Inspect	.1						
		Service	.1						A
		Test		.1					B
		Test			.5			1,4-10,12, 30	D
		Test			.5			4,9,10,14, 30	I
		Test			.75			1,4,24-27, 31-34,36, 37,38,40, 41	K
05	Control, Intercommunication Set C-10456/VRC	Repair		.25				2	F
		Repair			1.5			3,15	G
		Replace		.5				2	
		Inspect	.1						
		Service	.1						A
		Test		.25					B
		Test			.5			1,4-12,14, 22,30	D
		Test			.75			1,4,24-27, 31-34,36, 38,40	K
		Repair		.25				2	F
		Replace		.5	1.5			3,15	G
06	Amplifier, Audio Frequency AM-1780A/VRC	Inspect	.1						
		Service	.1						A
		Test		.25					B
		Replace		.25				2	H
		Repair		.25				2	F
07	Amplifier, Audio Frequency AM-1780B/VRC	Inspect	.25						
		Service	.25						A
		Test		.25				1	B
		Test			1.0			1,4,5,7-9, 12-14,16, 18,20,23	M,P
		Test				1.5		1,4,5,7-9, 12-14,16, 18,20,23	N,P

(1) GROUP NUMBER	(2) COMPONENT/ASSEMBLY	(3) MAINTENANCE FUNCTION	(4) MAINTENANCE LEVEL					(5) TOOLS AND EQUIPMENT REF CODE	(6) REMARKS CODE
			UNIT		DIRECT SUPPORT	GENERAL SUPPORT	DEPOT		
			C	O	F	H	D		
0701	CCA, Audio Amplifier AM-1780B/VRC	Replace		.25				2	
		Repair		.25				2	F
		Repair				1.0		3,15	G
0702	Heat Sink Assembly AM-1780B/VRC	Test				1.0		4,5,7,8,9, 12-14, 16-21,23	D,L,P
		Repair				1.0		3,15	G
		Test Repair				1.0		3,15	O G

**Section III. TOOLS AND TEST EQUIPMENT
FOR
INTERCOMMUNICATION SET AN/VIC-1(V)**

TOOL OR TEST EQUIPMENT REF CODE	MAINTENANCE LEVEL	NOMENCLATURE	NATIONAL STOCK NUMBER	TOOL NUMBER
1	O,F,H	Multimeter AN/PSM-45A	6625-01-265-6000	
2	O	Tool Kit, Electronic TK-101/G	5180-00-064-5178	
3	F,H	Tool Kit, Electronic TK-100/G	5180-000-605-0079	
4	F,H	Power Supply PP-2953	6130-000-985-7899	
5	F,H	Signal Generator AN/URM-127 OR Radio Test Set AN/GRM-114A	6625-00-783-5965 6625-01-144-4481	
6	F	Spectrum Analyzer TS-723/U OR Radio Test Set AN/GRM-114A	6625-00-668-9418 6625-01-144-4481	
7	F,H	Voltmeter, Electronic ME-30/U OR Radio Test Set AN/GRM-114A	6625-01-643-1670 6625-01-144-4481	
8	F,H	Oscilloscope AN/USM-281A OR Oscilloscope AN/USM-488	6625-00-228-2201 6625-01-187-7848	
9	F,H	Test Cable 1 (Locally Fabricated)		
10	F	Test Cable 2 (Locally Fabricated)		
11	F	Test Cable 3 (Locally Fabricated)		
12	F,H	Test Cable 4 (Locally Fabricated)		
13	F,H	Test Cable 5 (Locally Fabricated)		
14	F,H	Cable Assembly CG-1471/U	6625-00-880-6081	
15	F,H	Solder-Desolder Kit	6695-01-073-9492 or equal	
16	F,H	Distortion Analyzer TS-4084/G OR Radio Test Set AN/GRM-114A	6625-01-217-0054	
17	H	Digital Multimeter AN/USM-486	6625-01-145-2430	

**Section III. TOOLS AND TEST EQUIPMENT
FOR
INTERCOMMUNICATION SET AN/VIC-1(V)**

TOOL OR TEST EQUIPMENT REF CODE	MAINTENANCE LEVEL	NOMENCLATURE	NATIONAL STOCK NUMBER	TOOL NUMBER
18	F,H	Resistor, 100 OHM	5905-00-141-1183	
19	F,H	Resistor, 150 OHM	5905-00-119-8811	
20	F,H	Resistor, 620 OHM 2W	5905-00-407-6167	
21	H	Resistor, 5000 OHM	5905-00-111-1679	
22	F	Resistor, 68000 OHM	5905-00-119-3505	
23	F,H	Test Cable 6 (Locally Fabricated)		
24	F	Test Box (Locally Fabricated)		
25	F	Receiver-Transmitter, Radio RT-524/VRC OR Receiver-Transmitter, Radio RT-246/VRC	5820-00-892-0622 5820-00-892-0623	
26	F	Mounting MT-1029/VRC	5820-00-893-1323	
27	F	RF Wattmeter AN/URM-120 OR Radio Test Set AN/GRM-114A	6625-00-790-2746	
28	F	Control, Intercommunication C-2296/VRC	5820-00-892-3337	
29	F	Control, Intercommunication C-2297/VRC	5820-00-892-3338	
30	F	Resistor, 150 OHM 2W	5305-00-173-1119	
31	F	Cable Assembly CX-4720/VRC 10'	5995-00-823-2726	
32	F	Cable Assembly CX-4723/VRC 5'	5995-00-823-2833	
33	F	Cable Assembly RF CG-1773/U 10'	5995-00-823-3073	
34	F	Dummy Load, Electrical DA-75/U	5985-00-177-1639	
35	F	Control Intercommunication C-2298/VRC	5820-00-892-3339	
36	F	Cable Assembly CX-4722/VRC 10'	5995-00-823-2818	
37	F	Cable Assembly CX-7058/VRC 6'	5995-00-261-9880	

**Section III. TOOLS AND TEST EQUIPMENT
FOR
INTERCOMMUNICATION SET AN/VIC-1(V)**

TOOL OR TEST EQUIPMENT REF CODE	MAINTENANCE LEVEL	NOMENCLATURE	NATIONAL STOCK NUMBER	TOOL NUMBER
38	F	Adapter Connector UG-201A/U	5935-00-259-0205	
39	F	Adapter Cable (Locally Fabricated)		
40	F	Handset H-250A/U	5965-00-043-3463	
41	F	Loudspeaker LS-454/U	5965-00-876-2375	

SECTION IV. REMARKS FOR INTERCOMMUNICATION SET AN/VIC - 1(V)

REMARKS CODE	REMARKS
A	Limited to cleaning and touch up of painted surfaces.
B	An operational test to fault locate defective major component or cable (Black Box).
C	Repair is limited to replacement of major components or cables.
D	All tests to fault locate a defective component.
E	Adjust Variable Gain Interphone Amplifier.
F	Limited to replacement of knobs and lamps.
G	Repair by replacement of defective electrical and/or electronic components.
H	Replace with 1780/VRC or 1780B/VRC.
I	All operational checks made without the use of the optional test box.
J	All operational checks made with the optional test box and an Intercommunication Control Set.
K	All operational checks made only with the optional test box.
L	Test is completed with board still connected to AM-1780B/VRC.
M	Go - No Go Test, done with test box/cables.
N	Test to component level.
O	Tested along with tests in group 07, no additional testing time required.
P	Refer to TM 11-5895-154&34 for repair.

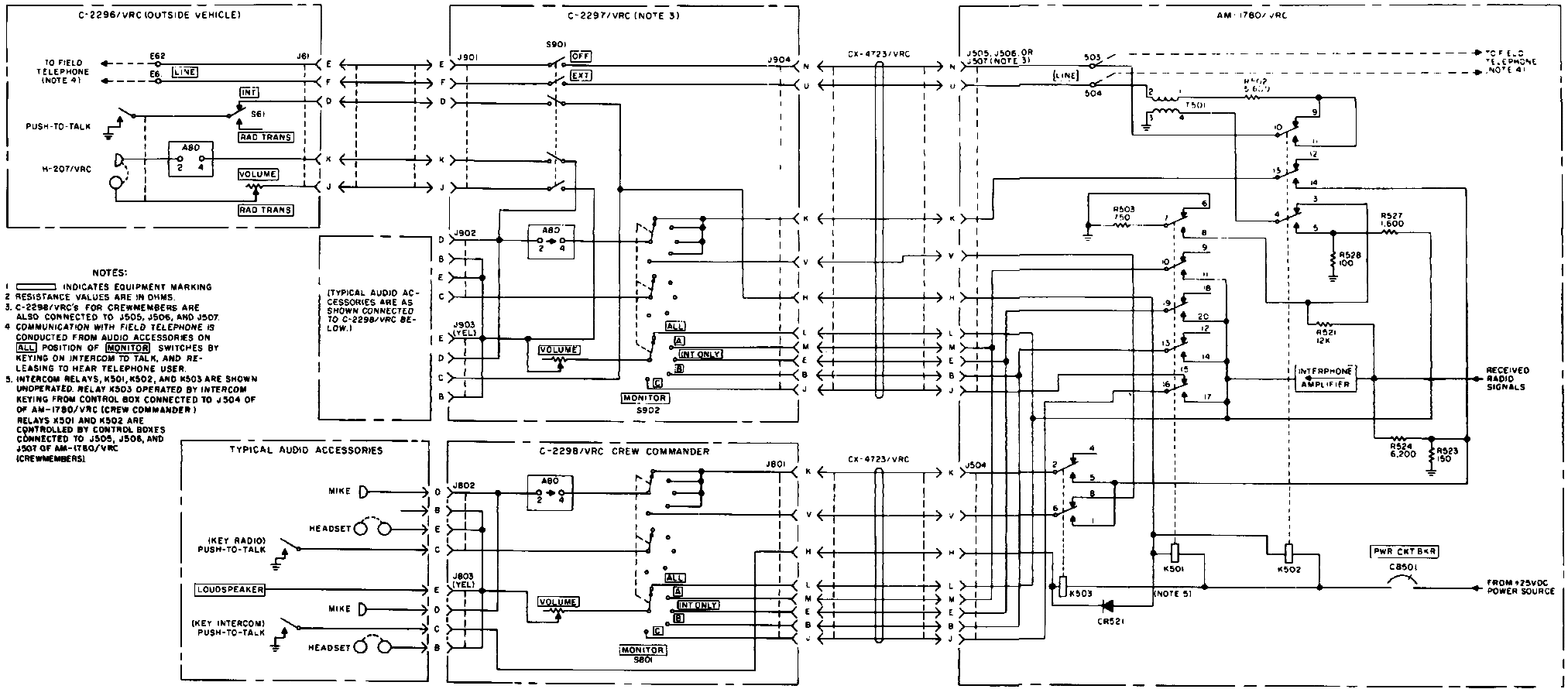



Figure FO-1. AN/VIC-1(V), audio signals and keying control circuits (without radios).

- NOTES:**
1.  INDICATES EQUIPMENT MARKING.
 2. RESISTANCE VALUES ARE IN OHMS.
 3. A/B1 IS A SOLID STATE RELAY WHICH CLOSES WHEN RADIO OR INTERCOM IS KEYPED FROM THE CVC HELMET OR REMOTE SWITCH OF THIS STATION.
 4. COMMUNICATION WITH FIELD TELEPHONE IS CONDUCTED FROM AUDIO ACCESSORIES ON **ALL** POSITION OF **MONITOR** SWITCHES BY KEYING ON INTERCOM TO TALK, AND RE-LEASING TO HEAR TELEPHONE USER.
 5. INTERCOM RELAYS K501, K502, AND K503 ARE SHOWN UNOPERATED. RELAY K503 OPERATED BY INTERCOM KEYING FROM CONTROL BOX CONNECTED TO J504 OF AM-1780/VRC (CREW COMMANDER). RELAYS K501 AND K502 ARE CONTROLLED BY CONTROL BOXES CONNECTED TO J505, J506, AND J507 OF AM-1780/VRC (CREW MEMBERS).
 6. SOME CREWMEMBERS MAY HAVE REMOTE INTERCOM KEYING FUNCTION ONLY.

7. ON CONTRACT DAAB07-80-C-0021 (1980), THE BINDING POSTS ARE LABELED TELE/REMOTE.

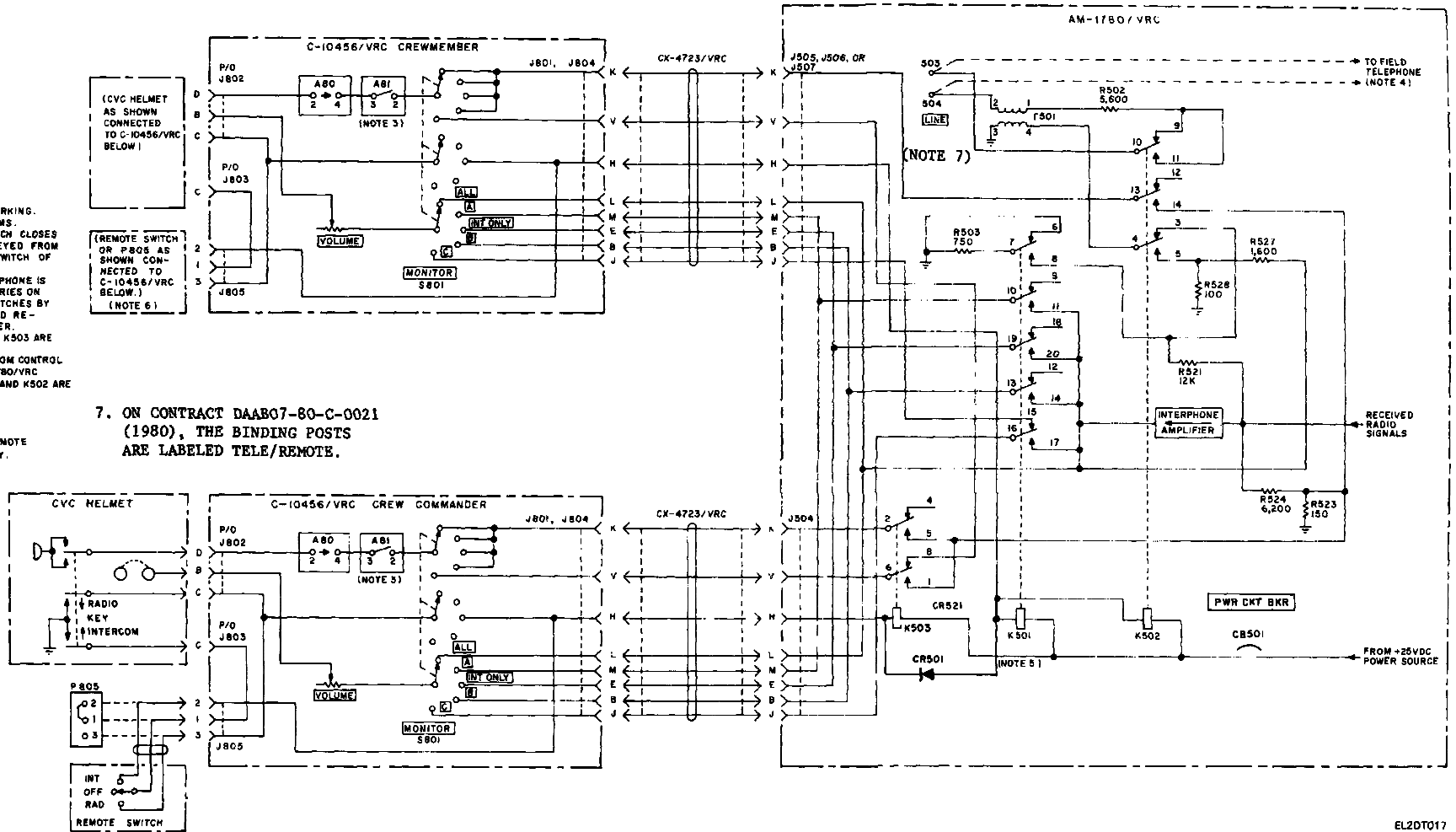

Figure FO-3. AN/VRC-1(V) using C-10456/VRC, audio signals and keying control circuits (without radios).

By Order of the Secretary of the Army:

JOHN A. WICKHAM JR.
General, United States Army
Chief of Staff

Official:

MILDRED E. HEDBERG
Brigadier General, United States Army
The Adjutant General

DISTRIBUTION :

To be distributed in accordance with DA Form 12-51 literature requirements for AN/VIC-1(V).

☆ U.S. GOVERNMENT PRINTING OFFICE : 1987 - 201-421 (71150)

RECOMMENDED CHANGES TO EQUIPMENT TECHNICAL PUBLICATIONS



THEN JOT DOWN THE DOPE ABOUT IT ON THIS FORM. CAREFULLY TEAR IT OUT. FOLD IT AND DROP IT IN THE MAIL.

SOMETHING WRONG WITH THIS PUBLICATION?

FROM (PRINT YOUR UNIT'S COMPLETE ADDRESS)

Commander
Stateside Army Depot
ATTN: AMSTA-US
Stateside, N.J. 07703

DATE SENT

10 July 1975

PUBLICATION NUMBER

TM 11-5840-340-12

PUBLICATION DATE

23 Jan 74

PUBLICATION TITLE

Radar Set AN/PRC-76

BE EXACT PIN-POINT WHERE IT IS

PAGE NO.	PARA GRAPH	FIGURE NO.	TABLE NO.
2-25	2-28		
3-10	3-5		3-1
5-6	5-8		

2-25

2-28

3-10

3-5

3-1

5-6

5-8

F03

IN THIS SPACE TELL WHAT IS WRONG AND WHAT SHOULD BE DONE ABOUT IT:

Recommend that the installation antenna alignment procedure be changed throughout to specify a 2° IFF antenna lag rather than 1°.

REASON: Experience has shown that with only a 1° lag, the antenna servo system is too sensitive to wind gusting in excess of 25 knots, and has a tendency to rapidly accelerate and decelerate as it hunts, causing strain to the drive train. Hunting is minimized by adjusting the lag to 2° without degradation of operation.

Item 5, Function column. Change "2 db" to "3db."

REASON: The adjustment procedure the the TRANS POWER FAULT indicator calls for a 3 db (500 watts) adjustment to light the TRANS POWER FAULT indicator.

Add new step f.1 to read, "Replace cover plate removed step e.1, above."

REASON: To replace the cover plate.

Zone C 3. On J1-2, change "+24 VDC to "+5 VDC."

REASON: This is the output line of the 5 VDC power supply. +24 VDC is the input voltage.

PRINTED NAME GRADE OR TITLE AND TELEPHONE NUMBER

SSG I. M. DeSpirito 999-1776

SIGN HERE

DA FORM 2028-2
1 JUL 79

PREVIOUS EDITIONS ARE OBSOLETE

P.S. - IF YOUR UNIT WANTS TO KNOW ABOUT YOUR RECOMMENDATION MAKE A CARBON COPY OF THIS AND GIVE IT TO YOUR HEADQUARTERS

FILL IN YOUR
UNIT'S ADDRESS



FOLD BACK

DEPARTMENT OF THE ARMY

OFFICIAL BUSINESS
PENALTY FOR PRIVATE USE, \$300

POSTAGE AND FEES PAID
DEPARTMENT OF THE ARMY
DOD-314



**Commander
US Army Communications
Electronics Command and Fort Monmouth
ATTN: AMSEL-ME-MP
Fort Monmouth, New Jersey 07703-5007**

TEAR ALONG DOTTED LINE

FOLD BACK

THE METRIC SYSTEM AND EQUIVALENTS

WEIGHT MEASURE

1 Centimeter = 10 Millimeters = 0.01 Meters = 0.3937 Inches
 1 Meter = 100 Centimeters = 1000 Millimeters = 39.37 Inches
 1 Kilometer = 1000 Meters = 0.621 Miles

WEIGHTS

1 Gram = 0.001 Kilograms = 1000 Milligrams = 0.035 Ounces
 1 Kilogram = 1000 Grams = 2.2 lb.
 1 Metric Ton = 1000 Kilograms = 1 Megagram = 1.1 Short Tons

LIQUID MEASURE

1 Milliliter = 0.001 Liters = 0.0338 Fluid Ounces
 1 Liter = 1000 Milliliters = 33.82 Fluid Ounces

SQUARE MEASURE

1 Sq. Centimeter = 100 Sq. Millimeters = 0.155 Sq. Inches
 1 Sq. Meter = 10,000 Sq. Centimeters = 10.76 Sq. Feet
 1 Sq. Kilometer = 1,000,000 Sq. Meters = 0.386 Sq. Miles

CUBIC MEASURE

1 Cu. Centimeter = 1000 Cu. Millimeters = 0.06 Cu. Inches
 1 Cu. Meter = 1,000,000 Cu. Centimeters = 35.31 Cu. Feet

TEMPERATURE

$5/9(^{\circ}\text{F} - 32) = ^{\circ}\text{C}$
 212° Fahrenheit is equivalent to 100° Celsius
 90° Fahrenheit is equivalent to 32.2° Celsius
 32° Fahrenheit is equivalent to 0° Celsius
 $9/5^{\circ}\text{C} + 32 = ^{\circ}\text{F}$

APPROXIMATE CONVERSION FACTORS

TO CHANGE	TO	MULTIPLY BY
Inches	Centimeters	2.540
Feet	Meters	0.305
Yards	Meters	0.914
Miles	Kilometers	1.609
Square Inches	Square Centimeters	6.451
Square Feet	Square Meters	0.093
Square Yards	Square Meters	0.836
Square Miles	Square Kilometers	2.590
Acres	Square Hectometers	0.405
Cubic Feet	Cubic Meters	0.028
Cubic Yards	Cubic Meters	0.765
Fluid Ounces	Milliliters	29.573
its	Liters	0.473
arts	Liters	0.946
allons	Liters	3.785
Ounces	Grams	28.349
Pounds	Kilograms	0.454
Short Tons	Metric Tons	0.907
Pound-Feet	Newton-Meters	1.356
Pounds per Square Inch	Kilopascals	6.895
Miles per Gallon	Kilometers per Liter	0.425
Miles per Hour	Kilometers per Hour	1.609

TO CHANGE	TO	MULTIPLY BY
Centimeters	Inches	0.394
Meters	Feet	3.280
Meters	Yards	1.094
Kilometers	Miles	0.621
Square Centimeters	Square Inches	0.155
Square Meters	Square Feet	10.764
Square Meters	Square Yards	1.196
Square Kilometers	Square Miles	0.386
Square Hectometers	Acres	2.471
Cubic Meters	Cubic Feet	35.315
Cubic Meters	Cubic Yards	1.308
Milliliters	Fluid Ounces	0.034
Liters	Pints	2.113
Liters	Quarts	1.057
ers	Gallons	0.264
ms	Ounces	0.035
ograms	Pounds	2.205
Metric Tons	Short Tons	1.102
Newton-Meters	Pounds-Feet	0.738
Kilopascals	Pounds per Square Inch	0.145
ometers per Liter	Miles per Gallon	2.354
ometers per Hour	Miles per Hour	0.621



PIN: 018990-004