

602
U113
.2
TM
1944

TM 11-2600

WAR DEPARTMENT TECHNICAL MANUAL

U.S. Dept. of Army

TEST SET

I-179

RESTRICTED. DISSEMINATION OF RESTRICTED MATTER.
The information contained in restricted documents and the essential characteristics of restricted material may be given to any person known to be in the service of the United States and to persons of undoubted loyalty and discretion who are cooperating in Government work, but will not be communicated to the public or to the press except by authorized military public relations agencies. (See also par. 23b, AR 380-5, 15 Mar. 1944.)

WAR DEPARTMENT 11 NOVEMBER 1944

WAR DEPARTMENT TECHNICAL MANUAL
TM 11-2600

TEST SET
I-179



WAR DEPARTMENT

11 NOVEMBER 1944

RESTRICTED. DISSEMINATION OF RESTRICTED MATTER.

The information contained in restricted documents and the essential characteristics of restricted material may be given to any person known to be in the service of the United States and to persons of undoubted loyalty and discretion who are cooperating in Government work, but will not be communicated to the public or to the press except by authorized military public relations agencies. (See also par. 23*b*, AR 380-5, 15 Mar 1944.)

WAR DEPARTMENT,
WASHINGTON 25, D. C., 11 November 1944.

TM 11-2600, Test Set I-179, is published for the information and guidance of all concerned.

[A. G. 300.7 (17 Sep 43).]

BY ORDER OF THE SECRETARY OF WAR:

G. C. MARSHALL,
Chief of Staff.

OFFICIAL:

J. A. ULIO,
*Major General,
The Adjutant General.*

DISTRIBUTION:

As prescribed in paragraph 9a, FM21-6:

Armies (Sig) (5); Corps (Sig) (5); SvC (Sig) (5);
Depts (5); Def C (2);** Arm & Sv Boards (2); Sig C
Rep Shs (2); ASF Deps (Sig Sec) (2); Sig Deps (Over-
sea) (10); Gen Deps (Sig Sec) (10); PE (2); Sig C In-
spec Zones (2); Sig C Proc Dists (2).

**Symbols: IBn 11 (2); IC 4 (10); IU 4 (4); IC 11, 44
(4).

IBn 11: T/O 11-400, Sig AW Orgn—Bn, Hq.

IC 4: T/O 4-260-1.

IU 4: T/O 4-232; 4-240.

IC 11: T/O 11-107; 11-237; 11-287; 11-400, Sig AW
Orgn—(B) Co, Hq Team; Radar Rep Plat;
11-500, Sig Sv Orgn—(EC) Radar Maint Team;
11-587; 11-592; 11-597; 11-617.

IC 44: T/O & E 44-1-3S; 44-16; 44-17; 44-116; 44-117;
44-136; 44-138.

For explanation of symbols, see FM21-6.

TABLE OF CONTENTS

U113
 1
 TM 1200
 19-19
 ★ ★

SECTION	I. Description.	<i>Paragraph •</i>	<i>Page</i>
	General	1	1
	Controls on panel	2	1
	Types of measurement	3	4
	Mechanical details	4	4
	II. Operation.		
	D-c current measurements	5	6
	A-c voltage measurements	6	7
	D-c voltage measurements at 20,000 ohms-per-volt	7	9
	D-c voltage measurements at 1,000 ohms-per-volt	8	10
	A-c current measurements	9	13
	Output voltage measurements	10	13
	Resistance measurements	11	14
	III. Functioning of parts.		
	General	12	19
	Test Set I-179 as an ohmmeter	13	19
	Test Set I-179 as a d-c voltmeter, 20,000 ohms-per-volt	14	19
	Test Set I-179 as a d-c milliammeter	15	19
	Test Set I-179 as an a-c voltmeter.....	16	19
	Test Set I-179 as an a-c current meter	17	20
	Test Set I-179 as a d-c voltmeter, 1,000 ohms-per-volt	18	20
	List of schematic parts		22
	List of manufacturers' names and addresses		25
	IV. Maintenance.		
	General	19	28
	Calibration procedure	20	28
	Moistureproofing and fungiproofing..	21	29
	V. Supplementary data.		
	Maintenance parts list	22	33

M558600

III

DESTRUCTION NOTICE

WHY — To prevent the enemy from using or salvaging this equipment for his benefit.

WHEN When ordered by your commander, or when in imminent danger of capture by the enemy.

HOW — 1. Smash — Use sledges, axes, handaxes, pickaxes, hammers, crow-bars, heavy tools.

2. Cut — Use axes, handaxes, machetes.

3. Burn — Use gasoline, kerosene, oil, flame throwers, incendiary grenades.

4. Explosives — Use firearms, grenades, TNT.

5. Disposal — Bury in slit trenches, fox holes, other holes. Throw in streams. Scatter.

USE ANYTHING IMMEDIATELY AVAILABLE FOR DESTRUCTION OF THIS EQUIPMENT.

WHAT — 1. Smash — Meters, controls, panels.

2. Cut — Cables and all wiring.

3. Burn — Resistors, capacitors, all technical manuals, instruction books, tube charts.

4. Bury or scatter — Any or all of the above pieces after destroying their usefulness.

DESTROY EVERYTHING

WARNING
HIGH VOLTAGE

is used in the operation
of this equipment.

DEATH ON CONTACT

may result if personnel fail
to observe safety precautions.

In using Test Set I-179, special high-voltage precautions must be observed. Exercise the utmost care to avoid accidental contact with, or even close proximity to, high-voltage points. Use one hand only. Make sure that hands and shoes are dry. If possible, ground the instrument panel. Attach the test leads to the circuit to be measured when the power is off. After completing the measurement, turn the power off again and make sure that any capacitors in the circuit are discharged before removing the test leads. Be sure to have a complete-circuit diagram of the unit under test, with the location of all high-potential terminals well-marked in the diagram.

FIRST AID TREATMENT FOR ELECTRIC SHOCK

I. FREE THE VICTIM FROM THE CIRCUIT IMMEDIATELY.

Shut off the current. If this is not immediately possible, use a dry nonconductor (rubber gloves, rope, board) to move either the victim or the wire. Avoid contact with the victim. If necessary to cut a live wire, use an axe with a dry wooden handle. Beware of the resulting flash.

II. ATTEND INSTANTLY TO THE VICTIM'S BREATHING.

Begin resuscitation at once on the spot. Do not stop to loosen the victim's clothing. Every moment counts. Keep the patient warm. Wrap him in any covering available. Send for a doctor. Remove false teeth or other obstructions from the victim's mouth.

RESUSCITATION

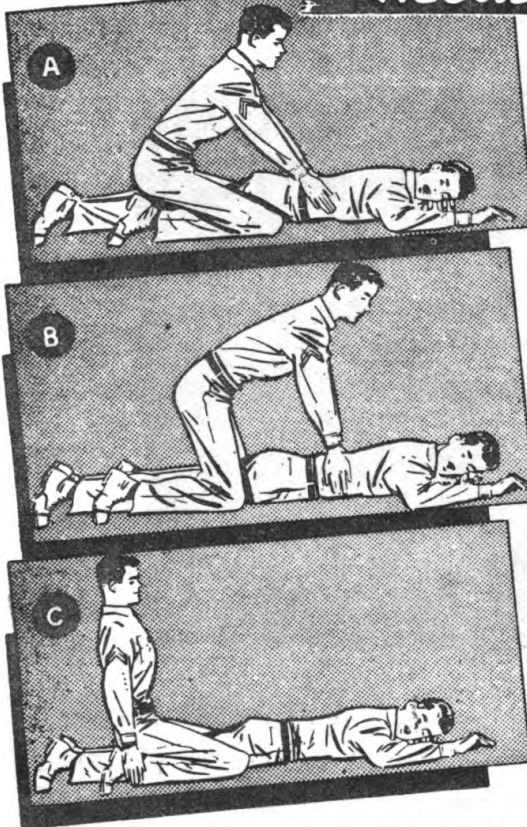

POSITION

1. Lay the victim on his belly, one arm extended directly overhead, the other arm bent at the elbow, the face turned outward and resting on hand or forearm, so that the nose and mouth are free for breathing (fig. A).
2. Straddle the patient's thighs, or one leg, with your knees placed far enough from his hip bones to allow you to assume the position shown in figure A.
3. Place your hands, with thumbs and fingers in a natural position, so that your palms are on the small of his back, and your little fingers just touch his lowest ribs (fig. A).

FIRST MOVEMENT

4. With arms held straight, swing forward slowly, so that the weight of your body is gradually brought to bear upon the victim. Your shoulders should be directly over the heels of your hands at the end of the forward swing (fig. B). Do not bend your elbows. The first movement should take about 2 seconds.

SECOND MOVEMENT

5. Now immediately swing backward, to remove the pressure completely (fig. C).
6. After 2 seconds, swing forward again. Repeat this pressure-and-release cycle 12 to 15 times a minute. A complete cycle should require 4 or 5 seconds.

CONTINUED TREATMENT

7. Continue treatment until breathing is restored or until there is no hope of the victim's recovery. Do not give up easily. Remember that at times the process must be kept up for hours.
8. During artificial respiration, have someone loosen the victim's clothing. Wrap the victim warmly; apply hot bricks, stones, etc. Do not give the victim liquids until he is fully conscious. If the victim must be moved, keep up treatment while he is being moved.
9. At the first sign of breathing, withhold artificial respiration. If natural breathing does not continue, immediately resume artificial respiration.
10. If operators must be changed, the relief operator kneels behind the person giving artificial respiration. The relief takes the operator's place as the original operator releases the pressure.
11. Do not allow the revived patient to sit or stand. Keep him quiet. Give hot coffee or tea, or other internal stimulants.

HOLD RESUSCITATION DRILLS REGULARLY

TL 37451

VII

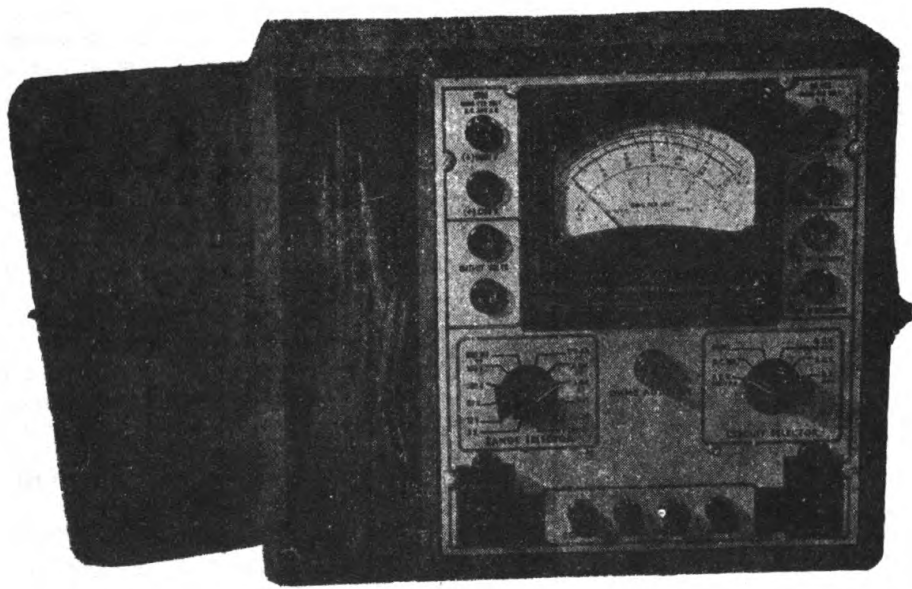

TL-38116

Figure 1. Test Set I-179.

RESTRICTED

SECTION I

DESCRIPTION

1. GENERAL.

Test Set I-179 is a service instrument designed to cover a wide range of voltage, current, and resistance measurements (fig. 1). Voltage measurements can be made at either of two separate meter sensitivities: 1,000 ohms per volt or 20,000 ohms per volt. The 1,000 ohms-per-volt sensitivity is commonly used for standard point-to-point voltage readings as given in the manufacturer's service notes. The 20,000 ohms-per-volt sensitivity is necessary for d-c voltage measurements in resistance-coupled amplifier channels, AFC and AVC circuits, and many other types of high-resistance circuits, including television and FM. In general, results obtained with Test Set I-179 are accurate to within 3 percent on d-c measurements and within 5 percent on a-c measurements.

2. CONTROLS ON PANEL.

The design of Test Set I-179 includes several features which permit speed and simplicity in servicing, ease of maintenance, and which also reduce the hazard of damage to the tester. These features include the following (fig. 2):

a. Two rotary-selector switches: the RANGE SELECTOR, which makes it possible to set the tester quickly to the proper range, and CIRCUIT SELECTOR for choosing the type of measurement desired. The necessity of setting two switches reduces the chances of injuring the meter because of incorrect setting.

b. A jack marked —COMMON on the lower right corner of the panel which is to be used for the negative connection for all voltage, resistance, and d-c current measurements, except for the 12 amps, d-c range. The binding post marked \pm COMMON on the lower center of the panel is the common for all a-c current ranges. The two jacks marked OUTPUT VOLTS are used for measuring output voltages below 600 volts. If output voltages above 600 volts are to be measured, the 1,200-volt or 6,000-volt jacks are used in conjunction with the proper output-volt jack.

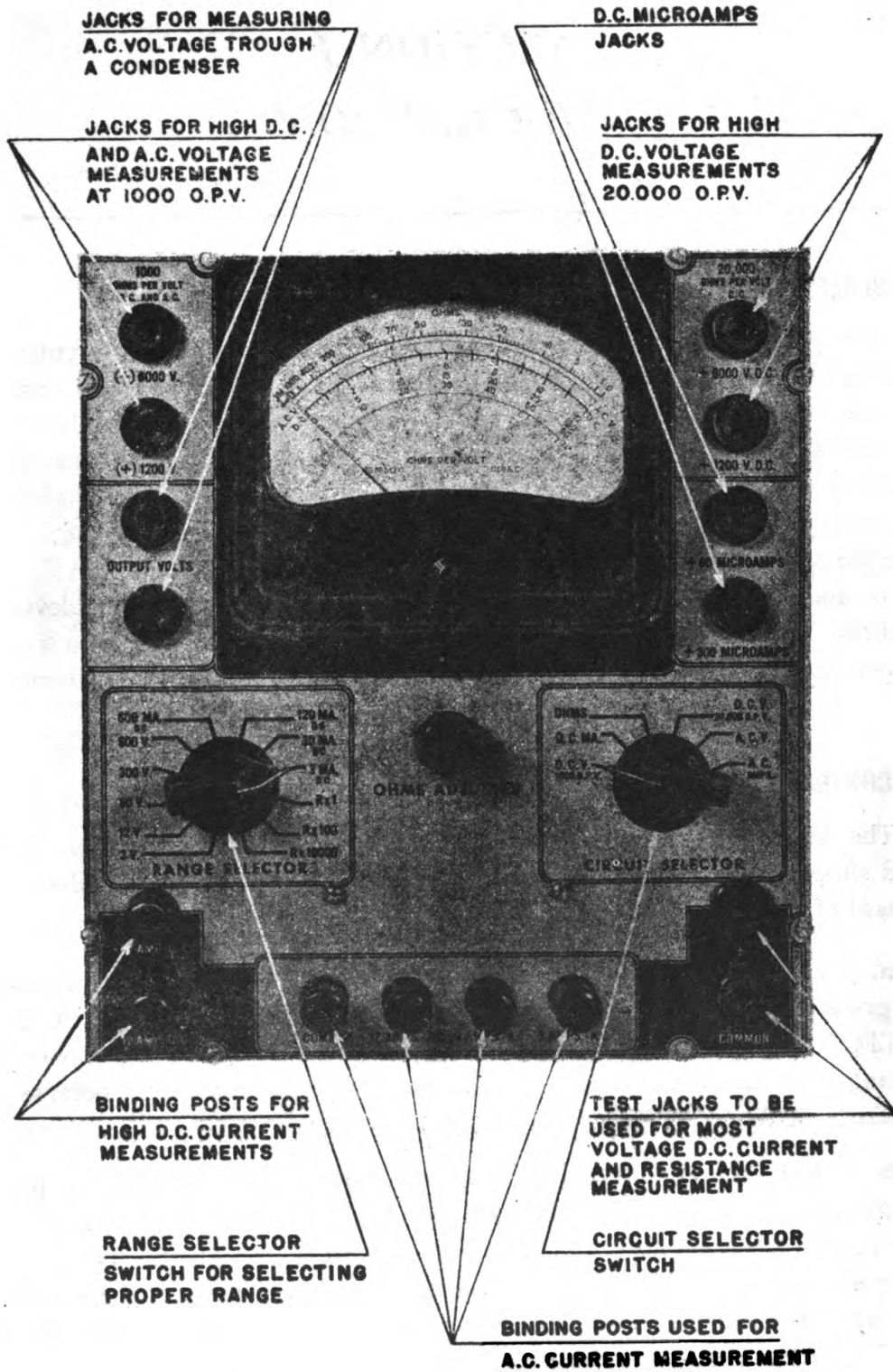

TL-38117

Figure 2. Front panel showing controls.

**BLACK D.C. SCALE FOR
ALL D.C. MEASUREMENTS.**

**BLACK SCALE FOR
RESISTANCE MEASUREMENTS.**

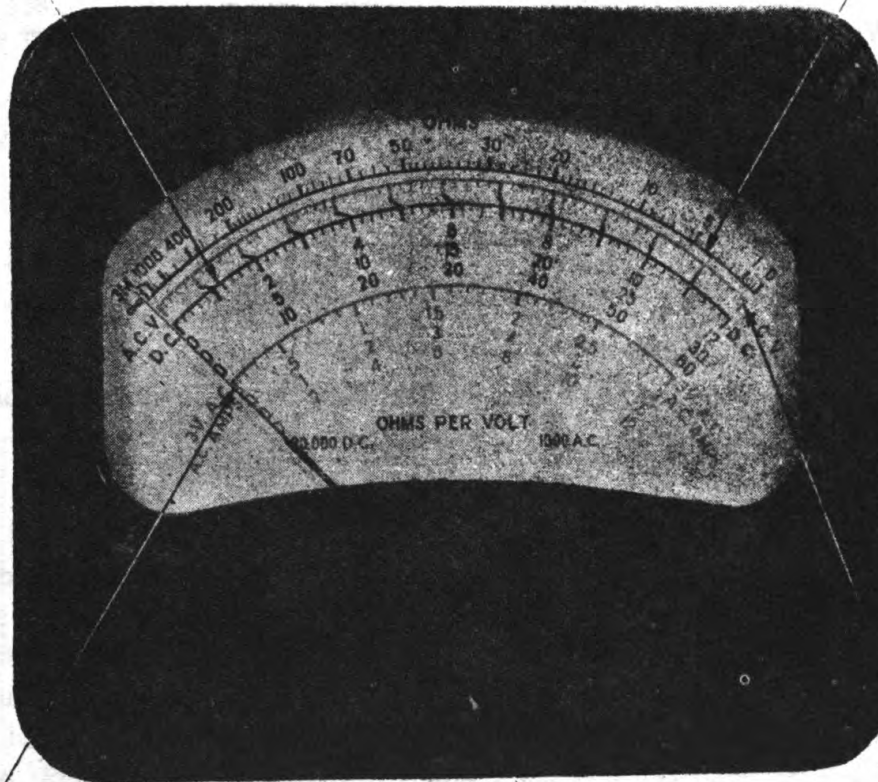

**RED SCALE FOR
3V. AND A.C. CURRENT
MEASUREMENT.**

**RED SCALE FOR
A.C. V. MEASUREMENT
EXCEPT 3V.A.C.**

**ADJUSTMENT SCREW FOR
SETTING POINTER TO ZERO**

TL-38118

Figure 3. Meter face.

e. Two red scales on the meter face (fig. 3) which are used for reading all a-c measurements. All d-c and resistance measurements are read on the black scale.

3. TYPES OF MEASUREMENT.

The multi-range tester may be used for taking a wide variety of measurements including:

a. Voltages from 1/10 volt to 6,000 volts d-c at 20,000 ohms-per-volt in seven convenient ranges.

b. Voltages from 1/10 volt to 6,000 volts d-c at 1,000 ohms-per-volt in seven convenient ranges.

c. Voltages from 1/10 volt to 6,000 volts a-c at 1,000 ohms-per-volt in seven convenient ranges.

d. Resistances from $\frac{1}{4}$ ohm to 30 megohms.

e. D-c current measurements from 1 microampere to 12 amperes.

f. A-c current measurements from 1/10 ampere to 12 amperes.

g. Output-voltage measurements where d-c has to be isolated from the output.

4. MECHANICAL DETAILS.

Test Set I-179 is housed in an olive-drab wooden case with a handle for carrying. Over-all dimensions are $9\frac{7}{8}$ inches by $12\frac{1}{8}$ inches by $6\frac{9}{16}$ inches. Its weight is $10\frac{1}{4}$ pounds. The tester is furnished with high-voltage test leads which are kept in a compartment in the case next to the instrument. The tester is supplied with the necessary batteries which include one Signal Corps type BA-42, 1.5-volt cell and one Signal Corps type BA-2, $22\frac{1}{2}$ -volt battery. These batteries are mounted beneath the panel. To insert or replace them, it is necessary to remove the screws which attach the panel to the case. The batteries should be inserted without soldering the connections. The tester is supplied with a copper-oxide rectifier which plugs in and can be replaced easily without unsoldering any leads. All uncoded resistors and parts have their values marked directly on them.

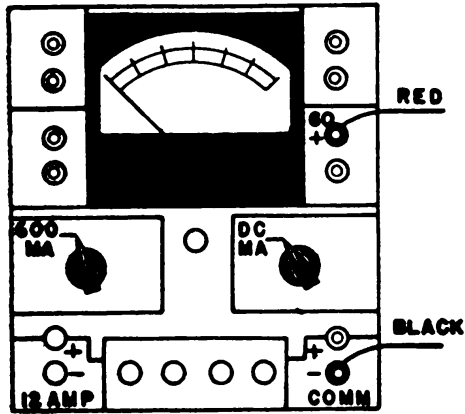

FIG. 4 A: 60 MICROAMPS D.C.
300 MICROAMPS D.C.

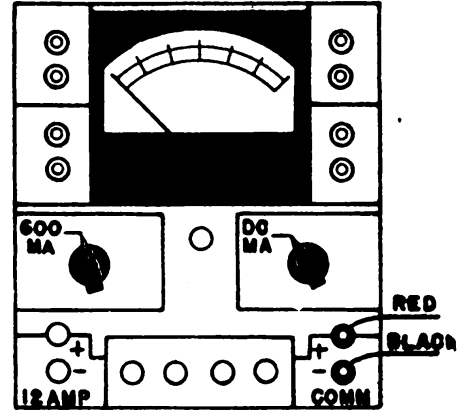

FIG. 4 C: D.C. RANGES: 0-3MA,
0-30MA, 0-120 MA,
0-600 MA.

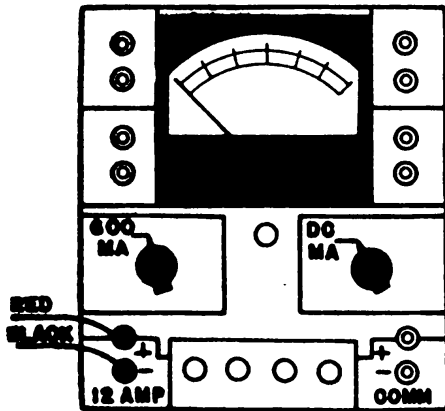

FIG. 4 B: 12 AMP D.C.

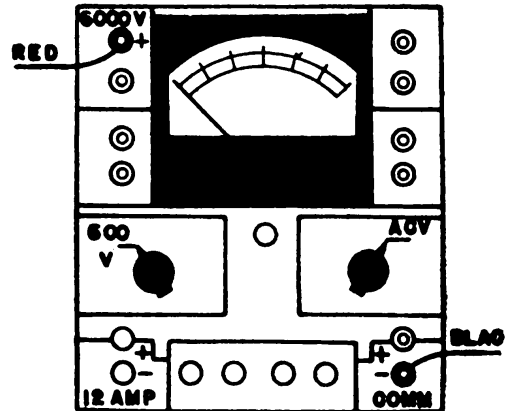

FIG. 4 D: 0-1200V, 0-6000V,
ACV RANGES

TL-38119

Figure 4. Cable connections and switch settings.

SECTION II

OPERATION

5. D-C CURRENT MEASUREMENTS.

CAUTION: Whenever the approximate value of the current to be measured is unknown, always use the highest range first. After observing the approximate value of the current, turn the SELECTOR switch to the range which will give a reading as close to full scale as possible without the pointer going off scale. This will assure maximum accuracy and will also protect the meter from damage. All current measurements should be made with the tester connected in series with the load under test. When measuring current in amperes, do not remove the test leads from the binding posts while the current is flowing. If this precaution is not observed, personal injury may result.

a. When using 0-60 and 0-300 microampere d-c ranges, see figure 4A and table II (at the end of this section) for switch positions, meter scale, and jack connections and proceed as follows:

- (1) Set the meter pointer to zero with the zero adjust screw located near the bottom of the meter.
- (2) Set the circuit selector switch to D.C. MA. position.
- (3) Set the range selector switch to 600 MA. position.
- (4) Insert the black test lead into pin jack marked —COMMON and the red test lead into either +60 MICROAMPS or the +300 MICROAMPS pin jack, depending upon the range desired.
- (5) For the 0-60 microampere range, read directly on the black 0-60 d-c scale. For the 0-300 microampere range, multiply the reading on the black 0-30 d-c scale by 10.

b. When using 0-3 ma, 0-30 ma, 0-120 ma, and 0-600 ma ranges, see figure 4c and table II for switch positions, meter scales, and jack connections, and proceed as follows:

- (1) Observe the cautions given for d-c current measurements.

- (2) Set the circuit selector switch to D.C. MA. position.
- (3) Set the range selector switch as follows:
 - For 0-3 ma set at 3 MA. position.
 - For 0-30 ma set at 30 MA. position.
 - For 0-120 ma set at 120 MA. position.
 - For 0-600 ma set at 600 MA. position.
- (4) Insert the red test lead into the +jack and black lead into the —COM-MON tip jack.
- (5) Read as follows:
 - For 0-3 ma, divide reading on black 0-30 d-c scale by 10.
 - For 0-30 ma, read directly on black 0-30 d-c scale.
 - For 0-120 ma, multiply reading on black 0-12 d-c scale by 10.
 - For 0-600 ma, multiply reading on black 0-60 d-c scale by 10.

c. When using 12-ampere d-c range, see figure 4B and table II for switch positions, meter scales, and jack connections, and proceed as follows:

- (1) Observe the cautions given for d-c current measurements.
- (2) Set the circuit selector switch to D.C. MA. position.
- (3) Set the range selector switch to 600 MA. position.
- (4) Insert red test lead into +12 AMP D.C. binding post and the black test lead into —12 AMP D.C. binding post.
- (5) Read directly on the 0-12 black d-c scale.

6. A-C VOLTAGE MEASUREMENTS.

a. When using 0-1,200 volts or 0-6,000 volts a-c ranges, see figure 4D and table I for switch positions, meter scales, and jack connections, and proceed as follows:

- (1) Observe the precautions for voltage measurements, especially the high-voltage precautions.
- (2) Set the circuit selector switch to A.C.V. position.
- (3) Set the range selector switch to 600 V. position.
- (4) Insert the red test lead into either the +1200 V. or +6,000 V. jack, depending upon the range desired, and the black test lead into the —COMMON tip jack.
- (5) For the 0-1,200 volts range, multiply reading on red 0-12 a-c scale by 100.

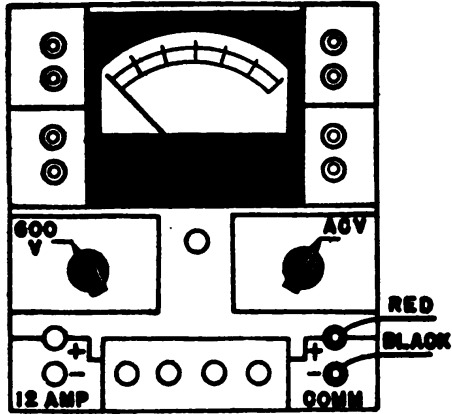

FIG. 5A: 0-3V, 0-12V, 0-60V,
0-300V, 0-600V
ACV RANGES

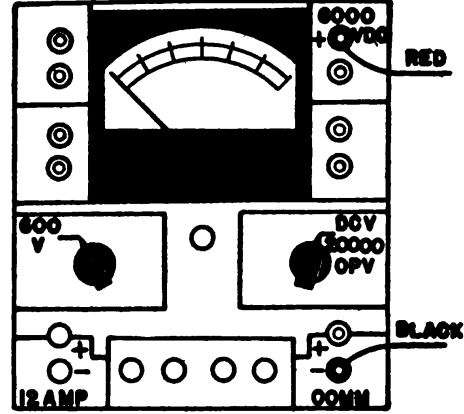

FIG. 5C: 0-1200 V, 0-6000 V,
20,000 O.P.V., D.C.

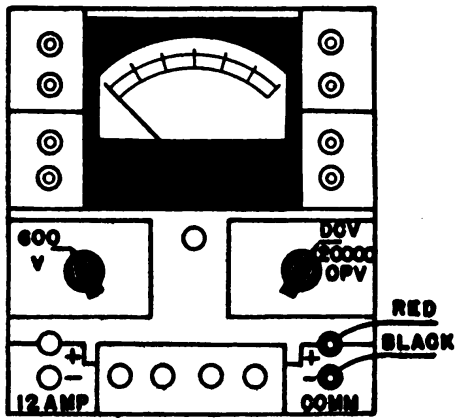

FIG. 5B: 0-3V, 0-12V, 0-60V,
0-300, 0-600,
20,000 O.P.V., D.C.

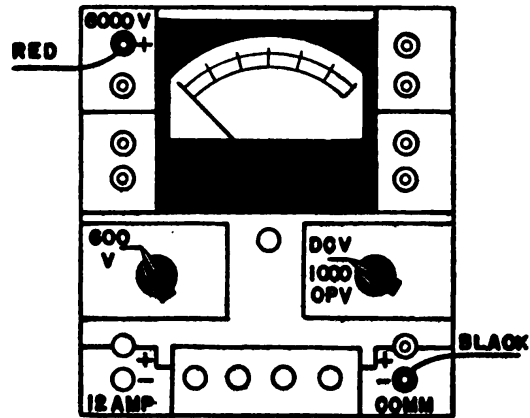

FIG. 5D: 0-1200 V, 0-6000V,
1000 O.P.V., D.C.

TL-38120

Figure 5. Cable connections and switch settings.

(6) For the 0-6,000 volts range, multiply reading on red 0-60 a-c scale by 100.

b. When using 0-3, 0-12, 0-60, 0-300 or 0-600 a-c volt ranges at 1,000 ohms-per-volt see figure 5A and table I for switch positions, meter scales, and jack connections, and proceed as follows:

- (1) Observe the cautions for voltage measurements.
- (2) Set the circuit selector switch to A.C.V. position.
- (3) Set the range selector switch as follows:

For 0-3 volts.....set to 3 V. position.
For 0-12 volts.....set to 12 V. position.
For 0-60 volts.....set to 60 V. position.
For 0-300 volts.....set to 300 V. position.
For 0-600 volts.....set to 600 V. position.

(4) Insert the black test lead into the —COMMON tip jack and the red lead into the +tip jack.

(5) Read as follows:

For 0-3 volts.....read directly on red 0-3V a-c scale.
For 0-12 volts.....read directly on red 0-12V a-c scale.
For 0-60 volts.....read directly on red 0-60V a-c scale.
For 0-300 volts.....multiply reading on red 0-30V a-c scale by 10.
For 0-600 volts.....multiply reading on red 0-60V a-c scale by 10.

7. D-C VOLTAGE MEASUREMENTS WITH METER SENSITIVITY AT 20,000 OHMS PER VOLT.

a. When using 0-1,200 volts and 0-6,000 volts d-c ranges at 20,000 ohms-per-volt, see figure 5C for switch positions and jack connections, and proceed as follows:

- (1) Observe the precautions for voltage measurements, particularly the high-voltage precautions.
- (2) Set circuit switch to D.C.V. 20,000 O.P.V.
- (3) Set the range selector switch to 600 V. position.
- (4) Insert the black test lead into the —COMMON tip jack and the red test lead into either the +1,200 V.D.C. or +6,000 V.D.C. jacks, 20,000 ohms-per-volt d-c, depending upon the range desired.
- (5) For the 0-1,200 volt range, multiply reading on black 0-12 d-c scale by 100.

(6) For the 0-6,000 volt range, multiply reading on black 0-60 d-c scale by 100.

b. When using 0-3, 0-12, 0-60, 0-300, or 0-600 volt d-c range at 20,000 ohms-per-volt see figure 5B and table I for switch positions, meter scales, and jack connections, and proceed as follows:

(1) Observe the cautions for voltage measurements.

(2) Set the circuit selector switch to D.C.V. 20,000 O.P.V. position.

(3) Set the range selector switch as follows:

For 0-3 volts set at 3 V. position.

For 0-12 volts set at 12 V. position.

For 0-60 volts set at 60 V. position.

For 0-300 volts set at 300 V. position.

For 0-600 volts set at 600 V. position.

(4) Insert the black test lead into the —COMMON tip jack and the red test lead into the + tip jack.

(5) Read as follows:

For 0-3 volts, divide reading on black 0-30 d-c scale by 10.

For 0-12 volts, read directly on black 0-12 d-c scale.

For 0-60 volts, read directly on black 0-60 d-c scale.

For 0-300 volts, multiply reading on black 0-30 d-c scale by 10.

For 0-600 volts, multiply reading on black 0-60 scale by 10.

8. D-C VOLTAGE MEASUREMENTS WITH SENSITIVITY AT 1,000 OHMS PER VOLT.

NOTE: Since this instrument provides for both 20,000 and 1,000 ohms-per-volt sensitivity, it will be found that, when using the same voltage range, the reading obtained with 20,000 ohms-per-volt sensitivity will be greater than that obtained with the 1,000 ohms-per-volt sensitivity. This results from the fact that for the same voltage range, the meter has a much higher resistance at the 20,000 ohms-per-volt sensitivity (20 times as high) than it has at the 1,000 ohms-per-volt sensitivity. Consequently, the shunting connection, as a 20,000 ohms-per-volt meter, is much less than it is as a 1,000 ohms-per-volt meter. This will be particularly noticeable when measuring the voltage in high-resistance circuits. At all times, the meter will give a much more accurate voltage indication with the 20,000 ohms-per-volt sensitivity than it will with the 1,000 ohms-per-volt sensitivity. In low-resistance circuits, the difference between the two readings will be negligible.

a. When using 0-1,200 volt and 0-6,000 volt d-c ranges at 1,000 ohms-per-volt, see figure 5D and table I for switch positions, meter scales, and jack connections, and proceed as follows:

- (1) Observe the cautions for voltage measurements, particularly the high-voltage precautions.
- (2) Set the circuit selector switch to D.C.V. 1,000 O.P.V. position.
- (3) Set the range selector switch to 600 V. position.
- (4) Insert the black test lead into the —COMMON tip jack and the red test lead into either the +1,200 V. or +6,000 V. tip jack, depending upon the range desired.
- (5) For the 0-1,200 volt range, multiply reading on the black 0-12 d-c scale by 100.
- (6) For the 6,000 volt range, multiply the reading on the black 0-60 d-c scale by 100.

b. When using 0-3, 0-12, 0-60, 0-300, or 0-600 volt ranges at 1,000 ohms-per-volt, see figure 6A and table I for switch positions, meter scales, and jack connections, and proceed as follows:

- (1) Observe the cautions given for voltage measurements.
- (2) Set the circuit selector switch to D.C.V. 1,000 O.P.V. position.
- (3) Set the range selector switch as follows:
 - For 0-3 volts set to 3 V. position.
 - For 0-12 volts set to 12 V. position.
 - For 0-60 volts set to 60 V. position.
 - For 0-300 volts set to 300 V. position.
 - For 0-600 volts set to 600 V. position.
- (4) Insert the black test lead into the —COMMON tip jack and the red test lead into the +tip jack.
- (5) Read as follows:
 - For 0-3 volts divide reading on black 0-30 d-c scale by 10.
 - For 0-12 volts read directly on black 0-12 d-c scale.
 - For 0-60 volts read directly on black 0-60 d-c scale.
 - For 0-300 volts multiply reading on black 0-300 d-c scale by 10.
 - For 0-600 volts read directly on black 0-60 d-c scale by 10.

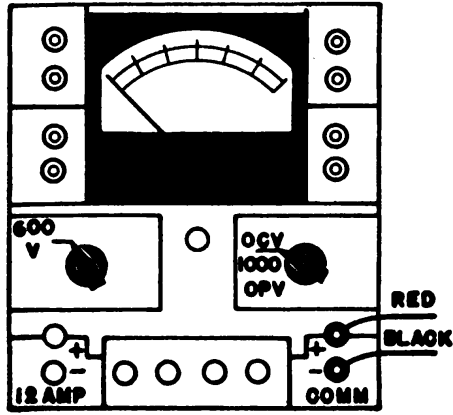

FIG. 6A: 0-3V, 0-12V, 0-60V,
0-300V, 0-600V,
1000 O.P.V.

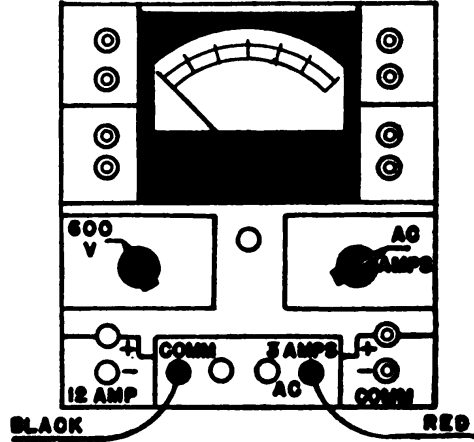

FIG. 6C: 0-3 AMPS, 0-6 AMPS,
0-12 AMPS. A.C.

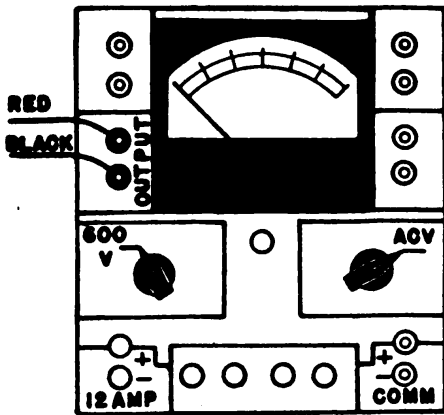

FIG. 6B: OUTPUT VOLTS

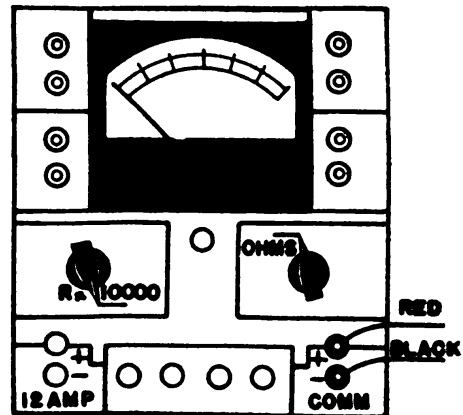

FIG. 6D: R x 1, R x 100,
R x 10,000 RANGES

TL-38121

Figure 6. Cable connections and switch settings.

9. A-C CURRENT MEASUREMENTS.

CAUTION: When measuring current in amperes, do not remove the test leads from the binding posts while the current is flowing. The resulting arc may cause the binding posts to char if this precaution is not observed. See figure 6C and table II for switch positions, meter scales, and jack connections, and proceed as follows:

- (1) Observe the caution outlined above.
- (2) Set the circuit selector switch to A.C. AMPS. position.
- (3) Set the range selector switch to 600 V. position. The range selector switch may actually be set at any position, but it is always safe to keep it at 600 V. whenever possible in order to reduce the chances of damaging the meter by an improper connection.
- (4) Insert the red test lead in the 3 AMPS-A.C., 6 AMPS-A.C., or 12 AMPS A.C. binding post, depending upon the range desired. Connect the black test lead to the —COMMON binding post.

(5) Read as follows:

For 0-3 amps a-c read directly on red 0-3 a-c amps scale.

For 0-6 amps a-c read directly on red 0-6 a-c amps scale.

For 0-12 amps a-c read directly on red 0-12 a-c amps scale.

NOTE: The a-c amps scale is the same as that used for the 3-volt a-c range.

10. OUTPUT VOLTAGE MEASUREMENTS.

When there is no d-c component in the output voltage, as when measuring the voltage across the secondary of an output transformer or across the voice coil, the meter is used exactly as an a-c voltmeter.

a. If the voice coil or secondary transformer-output leads are not accessible, the meter should be connected from the plate of the output tube to ground. In that case, insert the test leads in the two jacks marked OUTPUT VOLTS. (See figure 6B for switch positions and jack connections.) The circuit selector switch should be set to A.C.V. position, and the range selector to the 3 V., 12 V., 60 V., 300 V. or 600 V., depending upon the range desired.

b. By using the two output jacks, a 0.2-microfarad 1,000-volt capacitor is automatically connected in series with one of the a-c lines and effectively blocks any d-c component.

11. RESISTANCE MEASUREMENTS.

CAUTION: Make sure that the resistor to be measured is *dead*; that is, there is no external current flow through it. Always disconnect one end of the resistor from the circuit before taking measurements. This will prevent erroneous readings caused by other resistors in the circuit shunting the resistor to be measured.

a. See figure 6D and table II for switch positions and jack connections and proceed as follows:

(1) Set the circuit selector switch to OHMS position.

(2) Set the range selector switch as follows:

For 0-3,000 ohms range, set to Rx1 position.

For 0-300,000 ohms range, set to Rx100 position.

For 0-30 megohms range, set to Rx10,000 position.

(3) Insert the black test lead into the —COMMON output jack and the red test lead into the +tip jack.

(4) Short the free ends of the test leads and rotate the ohms adjuster control until the meter reads full scale (zero on the ohms scale) on the range being used.

(5) Separate the leads and place the resistor to be measured across them.

(6) Read as follows on the ohms scale:

For Rx1 range, read directly.

For Rx100 range, multiply readings on ohms scale by 100.

For Rx10,000 range, multiply readings on ohms scale by 10,000.

b. When it is no longer possible to adjust for full scale deflection on the Rx1 or Rx100 ranges, the instrument should be removed from the case and the 1½-volt cell should be replaced with a BA-42 cell (fig. 7). When it is no longer possible to adjust for full scale deflection on the Rx10,000 range, the 22½-volt battery should be replaced with a BA-2 battery. When replacing the BA-42 cell, observe proper polarity when inserting cell between the spring clips. The correct position is marked on the label pasted between the two contacts. The + side of the cell is the cap end.

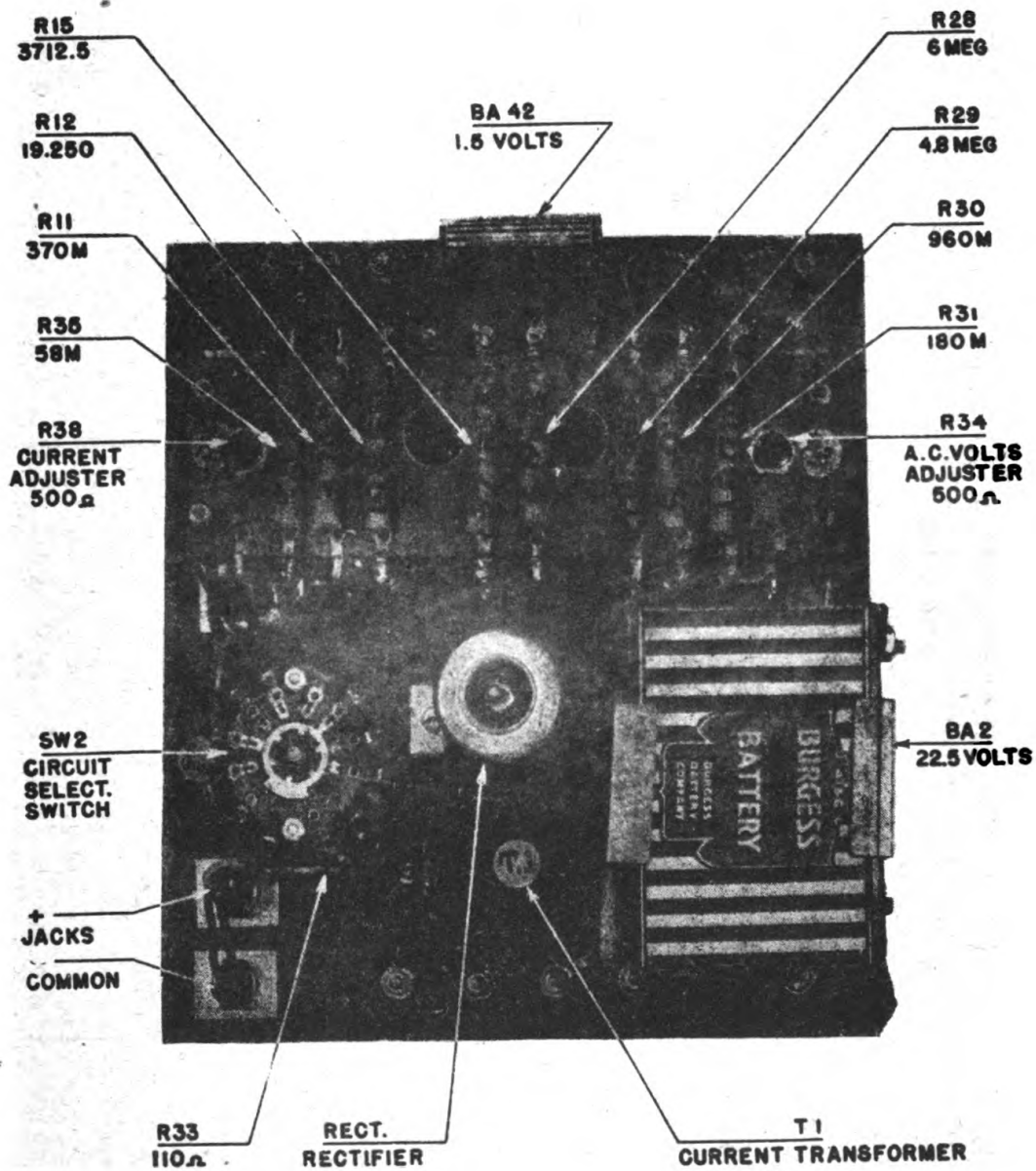

TL-38122

Figure 7. Test Set I-179, bottom view.

**TABLE I
VOLTAGE CONNECTIONS**

TYPE OF MEASUREMENT	CIRCUIT SELECTION SWITCH		RANGE SELECTION SWITCH		TERMINALS	METER SCALE
	TOR SWITCH	SELEC-TOR SWITCH	TOR SWITCH	SELEC-TOR SWITCH		
D. C. VOLTAGE 20,000 OHMS PER VOLT	High Voltage Ranges	D. C. V. 20,000 O.P.V.	600 V.		20,000 ohms per volt +6,000 V.D.C. +1,200 V.D.C. —COMMON TIP JACK	BLACK D.C. 0-60x100 D.C. 0-12x100
	Low Voltage Ranges	D. C. V. 20,000 O.P.V.	600 V. 300 V. 60 V. 12 V. 3 V.		+TIP JACK —COMMON TIP JACK	BLACK D.C. 0-60x10 D.C. 0-30x10 D.C. 0-60 D.C. 0-12 D.C. 0-30 ÷ 10
D. C. VOLTAGE 1,000 OHMS PER VOLT	High Voltage Ranges	D. C. V. 1,000 O.P.V.	600 V.		1,000 OHMS PER VOLT (+) 6,000 (+) 1,200 — COMMON TIP JACK	BLACK D.C. 0-60x100 D.C. 0-12x100
	Low Voltage Ranges	D. C. V. 1,000 O.P.V.	600 V. 300 V. 60 V. 12 V. 3 V.		+ TIP JACK — COMMON TIP JACK	BLACK D.C. 0-60x10 D.C. 0-30x10 D.C. 0-60 D.C. 0-12 D.C. 0-30 ÷ 10

TYPE OF MEASUREMENT	CIRCUIT SELEC-TOR SWITCH	RANGE SELEC-TOR SWITCH	TERMINALS	METER SCALE
A. C. VOLTAGE	High Voltage Ranges	A. C. V.	1,000 OHMS PER VOLT (+) 6,000 (+) 1,200 —COMMON TIP JACK	RED A.C.V. 0-60x100 A.C.V. 0-30x100
	Low Voltage Ranges	A. C. V.	+ TIP JACK — COMMON TIP JACK	RED A.C.V. 0-60x10 A.C.V. 0-30x10 A.C.V. 0-60 A.C.V. 0-12 3V. A.C. 0-3

**TABLE II
CURRENT OUTPUT AND RESISTANCE CONNECTIONS**

TYPE OF MEASUREMENT	CIRCUIT SELEC-TOR SWITCH		RANGE SELEC-TOR SWITCH	TERMINAL		METER SCALE
	MICRO-AMPS	D.C. MA.	600 MA.	+ 60 MICROAMPS + 300 MICROAMPS - COMMON TIP JACK		BLACK
D. C. CURRENT	MILLI-AMPS	D.C. MA.	600 MA. 120 MA. 30 MA. 3 MA.	+ TIP JACK - COMMON TIP JACK		BLACK D.C. 0-60x10 D.C. 0-12x10 D.C. 0-30 D.C. 0-30 ÷ 10
	AMPS	D.C. MA.	600 MA.	+ 12 AMP binding post - 12 AMP binding post		BLACK D.C. 0-12
	A. C. CURRENT	A.C. AMPS.	600 V.	12 AMPS-A.C. 6 AMPS-A.C. 3 AMPS-A.C. - COMMON BINDING POST		RED A.C. AMPS 0-12 A.C. AMPS 0-6 A.C. AMPS 0-3
OUTPUT	A. C. V.	600 V. 300 V. 60 V. 12 V. 3 V.	OUTPUT VOLTS TIP JACKS		RED A.C.V. 0-60x100 A.C.V. 0-30x100 A.C.V. 0-30 A.C.V. 0-12 A.C.V. 0-30 ÷ 10	
RESISTANCE	OHMS	Rx10,000 Rx100 Rx1	+ TIP JACK - COMMON TIP JACK		BLACK D.C. 0-∞ x10,000 D.C. 0-∞ x100 D.C. 0-∞	

SECTION III

FUNCTIONING OF PARTS

12. GENERAL.

The schematic diagram and the break-down diagrams for each function of the instrument, which are included in this section, are to be used only as an aid to a better understanding of this instrument (figs. 8 to 14).

13. TEST SET I-179 AS AN OHMMETER (fig. 9).

The Range Selector Switch and Circuit Selector Switch select the proper shunt and multiplying resistances for each of the three resistance ranges. The BA-42 (1.5-volt cell) is connected in the circuit for all three ranges. The 22.5-volt BA-2 battery furnishes current only for the Rx10,000 range.

14. TEST SET I-179 AS A D-C VOLTMETER, 20,000 OHMS PER VOLT (fig. 10).

When the Range Selector Switch is set at any of the voltage positions, the proper multiplier is automatically connected in series with the basic meter movement which is 50 microamperes.

15. TEST SET I-179 AS A D-C MILLIAMMETER (fig. 11).

When the Circuit Selector Switch is at the D.C.MA position and the Range Selector Switch at one of the four current positions, the correct shunt and series resistances are connected to the indicating meter so that for each current scale the proper resistors are in the circuit. Separate terminals are used for the twelve amps d-c range, while separate jacks are used for the 60- and 300-microampere ranges.

16. TEST SET I-179 AS AN A-C VOLTMETER (fig. 12).

With the Circuit Selector Switch at the A.C.V. position and the Range Selector Switch at any voltage position, the proper multiplier resistance is connected in series with the rectifier. The rectifier changes the alternating current to direct current so that the d-c meter indicates the voltage applied to the instrument terminals. The sensitivity of the instrument for a-c voltage

measurements is 1,000 ohms-per-volt and the a-c voltage ranges are calibrated by a variable resistor (R34 on diagram) which is then sealed. This resistor is connected across the meter and adjusted until the meter indicates the correct value of the standard voltage applied. Separate jacks are used for the 1,200-volt and 6,000-volt ranges.

17. TEST SET I-179 AS AN A-C CURRENT METER (fig. 13).

With the Circuit Selector Switch at A.C. AMPS. position, the a-c current applied to the binding posts induces an a-c current in the secondary of current transformer T1 which is changed from a-c to d-c by the rectifier so that the meter M1 can indicate the correct value of the applied a-c current to the primary of the transformer T1. The variable resistor, R-38, is adjusted at the factory so that with three amps a-c applied, the meter will indicate exactly full scale. The resistor R-36 is permanently connected across the secondary of the current transformer to prevent any voltage surge when the meter and rectifier are disconnected from the current transformer. The setting of the variable R-34 resistor remains exactly the same as for a-c voltage measurements.

18. TEST SET I-179 AS A D-C VOLTMETER, 1,000 OHMS PER VOLT (fig. 14).

With the Circuit Selector Switch at D.C.V. 1,000 ohms-per-volt position, the correct shunt resistor is connected across the meter to adjust the meter sensitivity to 1 milliampere. With the Range Selector Switch at any d-c voltage position, the correct multiplier resistors are placed in series with the indicating meter.

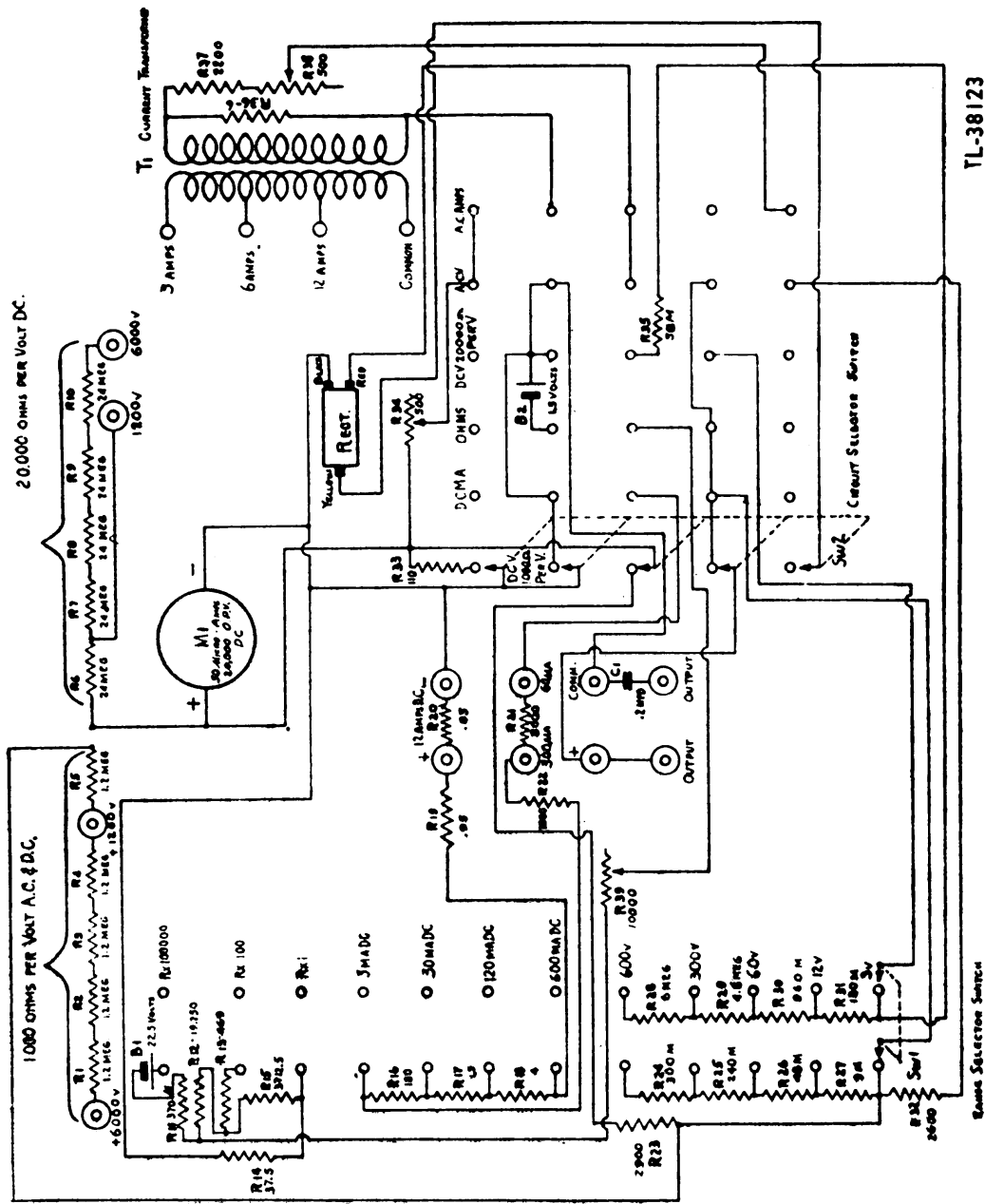

Figure 8. Test Set I-170, schematic diagram.

SCHEMATIC PARTS LIST

Circuit symbol	No. req.	Function	Description	Mfr's code	Mfr's No.
M-1	1	meter	DC-0-50 microamps, 4½" square, 2,000 ohms, model 29.	A	488-1
Rc-1	1	rectifier	Suppressor type, half-wave, copper oxide, type B2.	B	GI-22A
SW-1	1	Selector	2 gang, 12 position, range selector No. 25135H2.	C	488-4
.SW-2	1	Selector	2 gang, 6 position, circuit selector No. 25136H2.	C	488-5
T1	1	Transformer	Current transformer No. 11594.	D	488-6
B1	1	cell	1.5V cell, Burgess No. 1 or BA-42	E	GI-43
B2	1	battery	22.5V Battery, Burgess No. 4156 or BA-2.	E	488-7
R39	1	rheostat	10,000-ohm, ohmmeter adjuster, ¼" bushing, 5/16" shaft, composition type.	F	488-35
R38	1	rheostat	500-ohm, slotted-shaft control, wire-wound, type 801, ¼" bushing.	G	488-36
R36	1	rheostat	500-ohm, slotted-shaft control, wire-wound, type 801, ¼" bushing.	G	488-36
C1	2	capacitor	0.1 mfd—1,000V—Oil filled tubular.	H	488-37

SCHEMATIC PARTS LIST

Circuit symbol	No. req.	Function	Description	Mfr's code	Mfr's No.
R27	1	resistor	pair BT $\frac{1}{2}$ series matched to 9K \pm 1%	I	488-9
R26	1	resistor	pair BT $\frac{1}{2}$ series matched to 48K \pm 1%	I	488-10
R25	1	resistor	pair BT $\frac{1}{2}$ series matched to 240K \pm 1%	I	488-11
R24	1	resistor	pair BT $\frac{1}{2}$ series matched to 300K \pm 1%	I	488-12
R31	1	resistor	pair BT $\frac{1}{2}$ series matched to 180K \pm 1%	I	488-13
R30	1	resistor	pair BT $\frac{1}{2}$ series matched to 960K \pm 1%	I	488-14
R29	1	resistor	pair BT $\frac{1}{2}$ series matched to 4.8 meg \pm 1%	I	488-15
R28	1	resistor	pair BT $\frac{1}{2}$ series matched to 6 meg \pm 1%	I	488-16
R23	1	resistor	pair BT $\frac{1}{2}$ series matched to 2,900 \pm 1%	I	488-17
R21	1	resistor	pair BT $\frac{1}{2}$ series matched to 8,000 \pm 1%	I	488-18
R22	1	resistor	pair BT $\frac{1}{2}$ series matched to 1,800 \pm 1%	I	488-19
R1, R2, R3, R4, R5	5	resistor	pair BT $\frac{1}{2}$ series matched to 1.2 meg \pm 1%	I	488-20
R6, R7, R8, R9, R10	5	resistor	pair BT $\frac{1}{2}$ series matched to 24 meg \pm 1%	I	488-21

SCHEMATIC PARTS LIST

Circuit symbol	No. req.	Function	Description	Mfr's code	Mfr's No.
R35	1	resistor	pair BT $\frac{1}{2}$ series matched to 58M \pm 1%	I	488-22
R11	1	resistor	pair BT $\frac{1}{2}$ series matched to 370M \pm 1%	I	488-23
R12	1	resistor	pair BT $\frac{1}{2}$ series matched to 19,250 \pm 1%	I	488-24
R15	1	resistor	pair BT $\frac{1}{2}$ series matched to 3,712.5 \pm 1%	I	488-25
R37	1	resistor	2200 ohm-BT $\frac{1}{2}$ -5%	I	488-26
R32	1	resistor	2600 ohm-BT $\frac{1}{2}$ -5%	I	488-27
R13	1	resistor	469 ohm- $\frac{1}{2}$ FX-2- $\frac{1}{2}$ %	J	488-28
R14	1	resistor	37.5 ohm- $\frac{1}{2}$ FX-2- $\frac{1}{2}$ %	J	488-29
R16	1	resistor	180 ohm- $\frac{1}{2}$ FX-2- $\frac{1}{2}$ %	J	488-30
R17	1	resistor	1.5 ohm- $\frac{1}{2}$ FX-2- $\frac{1}{2}$ %	J	488-31
R18	1	resistor	4 ohm- $\frac{1}{2}$ FX-2- $\frac{1}{2}$ %	J	488-32
R19	1	resistor	0.95 ohm- $\frac{1}{2}$ FX-2- $\frac{1}{2}$ %	J	488-33
R36	1	resistor	6 ohm-2FY-5%	J	488-34
R33	1	resistor	110 ohm- $\frac{1}{2}$ FX-2- $\frac{1}{2}$ %	J	488-35
R20	1	resistor	0.05 ohm-12 amp d-c shunt	K	488-35

CODE **MANUFACTURERS' NAME AND ADDRESS**

A	Simpson Electric Company, Chicago, Ill.
B	Schauer, Cincinnati, Ohio
C	Oak Manufacturing Co., Chicago, Ill.
D	Freed Manufacturing Co., New York, N. Y.
E	Burgess Battery Company, Freeport, Ill.
F	Centralab, Milwaukee, Wis.
G	Wirt Manufacturing Co., Phila., Pa.
H	Cornell Dubilier, South Plainfield, N. J.
I	International Resistance Corp., Phila., Pa.
J	Clarostat Manufacturing Co., Brooklyn, N. Y.
K	Radio City Products Co., New York, N. Y.

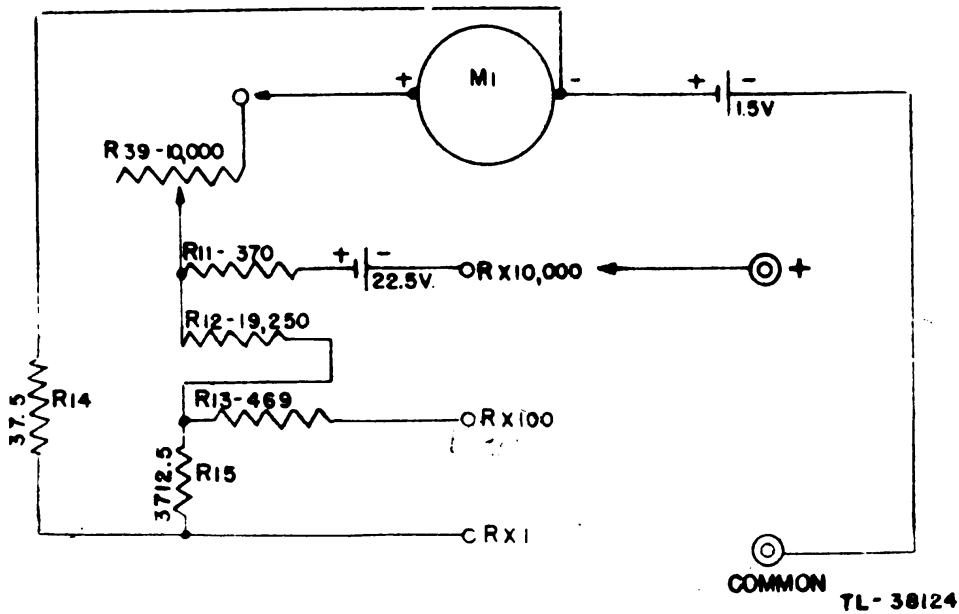

Figure 9. Test Set, I-179, simplified ohms circuit.

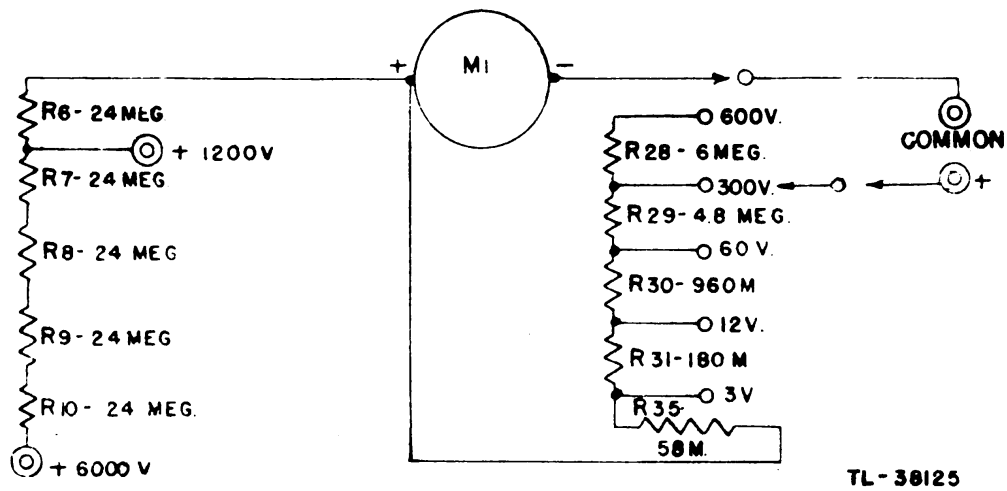

Figure 10. Test Set I-179. simplified D.C. volts circuit, 20,000 O.P.V.

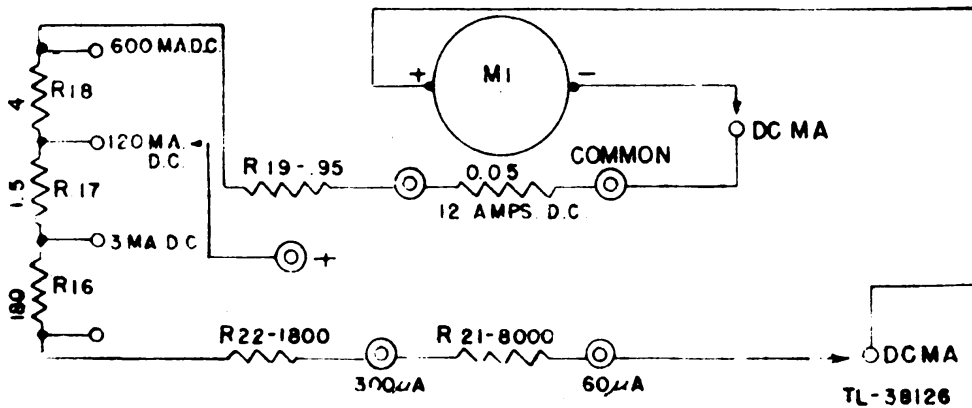

Figure 11. Test Set I-179, simplified D.C. amps circuit.

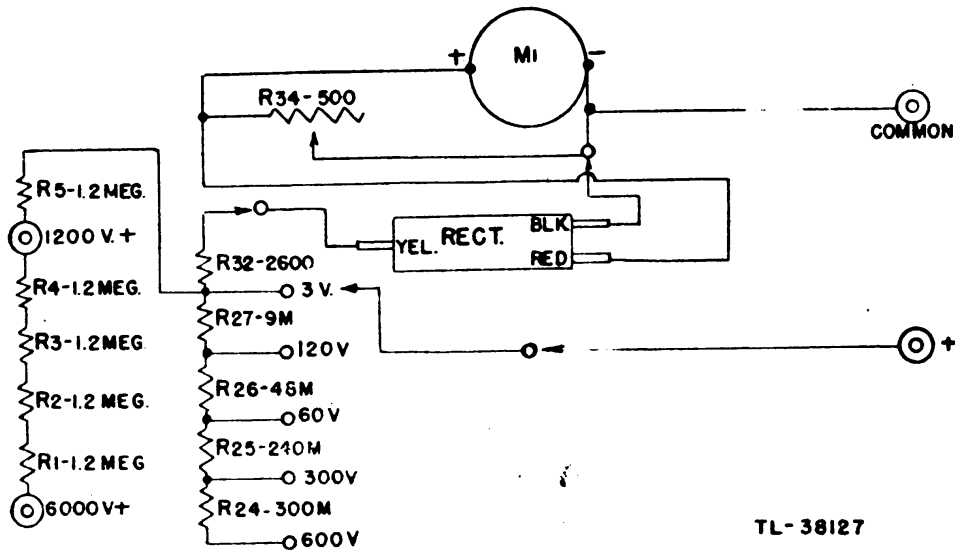

Figure 12. Test Set I-179, simplified A.C. volts circuit.

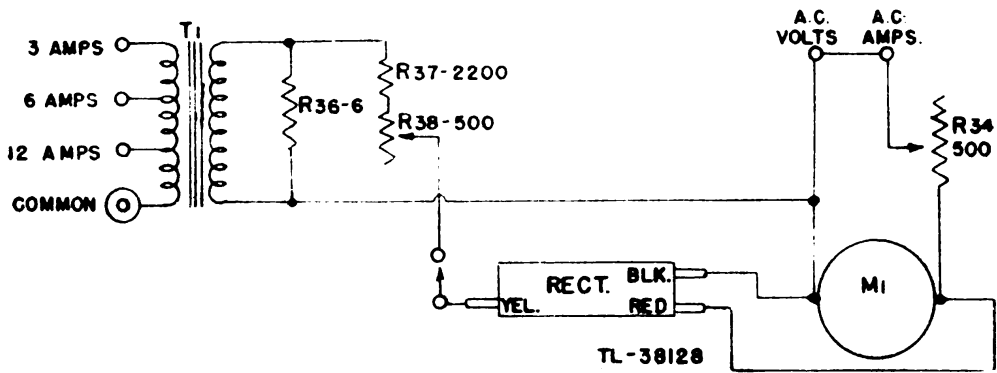

Figure 13. Test Set I-179, simplified A.C. amps circuit.

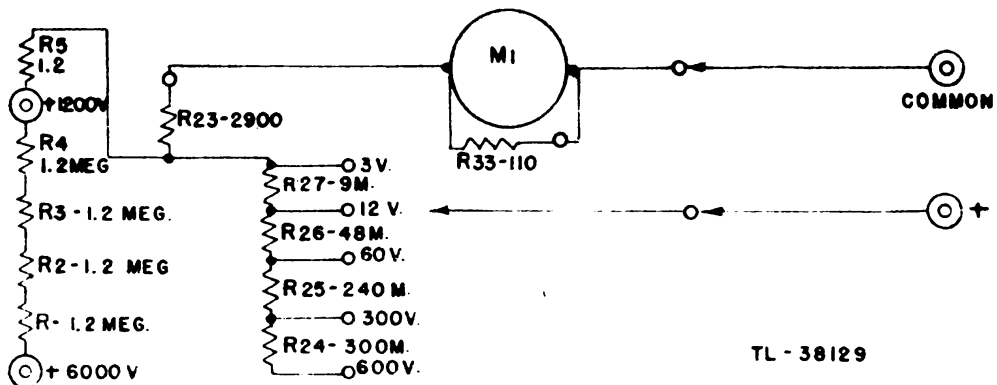

Figure 14. Test Set I-179, simplified D.C. volts circuit, 1,000 O.P.V.

SECTION IV

MAINTENANCE

UNSATISFACTORY PERFORMANCE OF THIS EQUIPMENT WILL BE REPORTED IMMEDIATELY ON W.D. A.G.O. FORM NO. 468. IF FORM IS NOT AVAILABLE, SEE TM 38-250.

19. GENERAL.

If the cautions outlined for the various measurements are followed, the instrument should give trouble-free service for at least 6 months. At the end of that time, the batteries may have to be replaced.

a. If the unit should not function on any a-c measurement, the copper-oxide rectifier is probably defective. In this event, the instrument should be removed from the case and the rectifier pulled out of its socket and replaced with a new one.

b. There are two factory-sealed controls on the resistor strip, mounted back of the meter. The control, labeled R34, is used for calibrating the a-c voltage ranges. If at any time it is desired to recalibrate the instrument against an external standard, simply use an external 60-cycle a-c supply of exactly 60 volts. Connect the external standard in parallel with the tester. When the external standard reads exactly 60 volts, the R34 control should be adjusted with a screwdriver until the meter on the tester reads exactly full scale. The range selector should be set to 60V position and the circuit selector to ACV position. After adjusting the tester for full scale deflection, the R34 control should be resealed.

20. CALIBRATION PROCEDURE.

The R38 control is used for calibrating the a-c current ranges. If it is desired to calibrate the instrument against an external a-c current standard, the procedure is as follows:

- a.** Set the circuit selector to AC amps position.
- b.** Connect test leads to —COMMON and 6 AMPS A-C binding posts.
- c.** Connect the tester in series with an external standard capable of reading 6 amperes a-c accurately.
- d.** Adjust the current through both meters until the external standard reads exactly 6 amperes.

e. Set the tester to full scale by adjusting the R38 control with a screw-driver.

f. Reseal the R38 control, when the tester reads exactly 6 amperes, and the external standard reads exactly 6 amperes.

21. MOISTUREPROOFING AND FUNGIPROOFING.

a. General. Communication failures commonly occur when Signal Corps equipment is operated in tropical areas where temperature and relative humidity are extremely high. The following problems are typical:

- (1) Resistors and capacitors fail.
- (2) Electrolytic action takes place in coils, transformer windings, etc., causing eventual break-down.
- (3) Hook-up wire and cable insulation break-down. Fungus growth accelerates deterioration.
- (4) Moisture forms electrical leakage paths on terminal boards and insulation strips causing flash-overs.
- (5) Moisture provides leakage paths between battery terminals.

b. Treatment. A moistureproofing and fungiproofing treatment has been devised which, if properly applied, provides a reasonable degree of protection against fungus growth, insects, corrosion, salt spray, and moisture. The treatment involves the use of a moisture-and fungi-resistant varnish applied by means of a spray gun.

c. Step-by-step Instructions.

(1) PREPARATION.

(a) Make all repairs and adjustments necessary for the proper operation of the equipment.

(b) Thoroughly clean equipment to be processed of all dirt, dust, rust, fungus, oil, grease, etc.

(2) DISASSEMBLY.

(a) Remove the six screws holding the front panel to the case.

(b) Lift the tester from the case.

(c) Remove the leads from Battery BA-2.

(d) Remove Battery BA-2 from the brackets.

- (e) Remove Battery BA-2 from its clips.
 - (f) Remove the nuts holding the meter-lead terminals.
 - (g) Remove the nuts and washers holding the meter to the panel.
 - (h) Remove the meter from the panel.
 - (i) Remove the nuts and washers holding Battery BA-2 bracket to the wafer switch and remove the battery-clip assembly.
 - (j) Remove the rectifier cover.
- (3) MASKING. The following components should be covered with masking tape as shown in figures 15 and 16.
- (a) Contacts of the Range Selector Switch, item A, figure 16.
 - (b) Contacts of the Circuit Selector Switch, item B, figure 16.
 - (c) Contact-strips of Battery BA-42, item A, figure 15.
 - (d) Terminals of the meter leads, item B, figure 15.

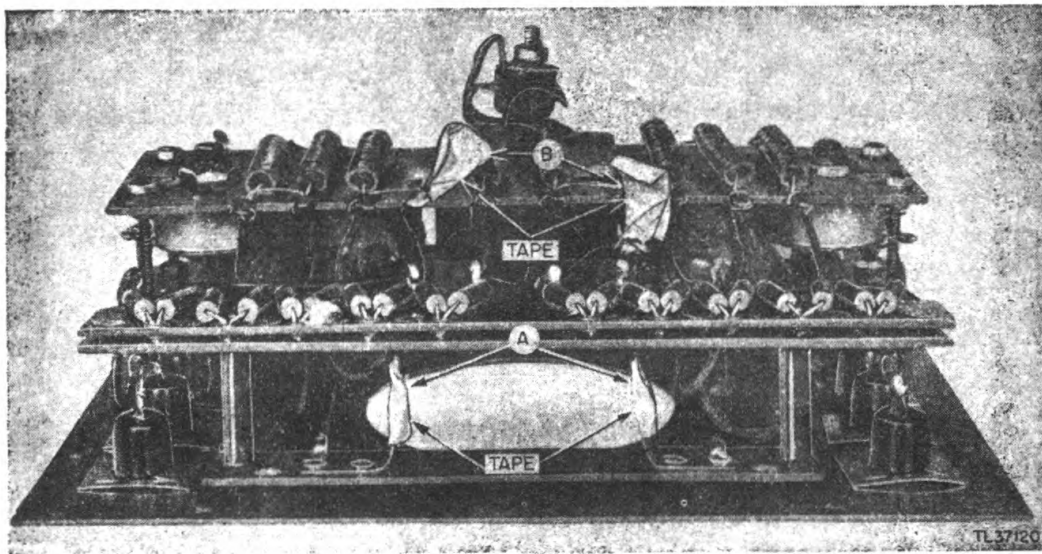

Figure 15. Test Set I-179, method of masking contact strips and meter leads.

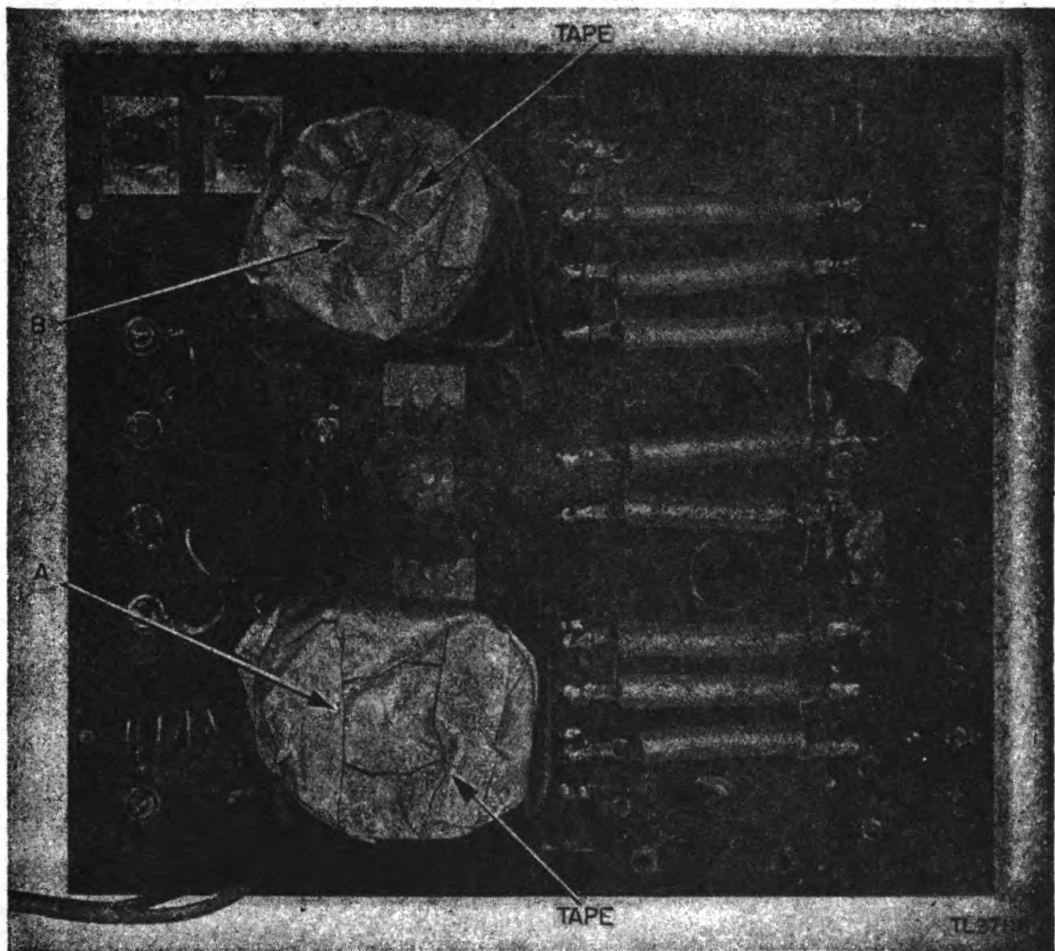

Figure 16. Test Set I-179, method of masking switches.

(4) DRYING.

(a) Place the chassis and meter in a heating chamber.

(b) Bake for approximately 2 hours at 160°F.

CAUTION: Do not exceed 160°F.

(c) If melting of the wax occurs on any of the components, decrease the temperature to 150°F and lengthen the baking time approximately 2 hours.

(5) VARNISHING.

(a) Spray three coats of Lacquer, Fungus-resistant, Spec. No. 71-2202 (Stock No. 6G1005.3) or equal, on all components, including the inside of the wooden case, allowing a 15- to 20-minute drying period after each coat.

CAUTION: Varnish spray may have toxic effects. Use respirator if available. Otherwise fasten cheesecloth or cloth material over the nose and mouth.

(b) Use a brush to apply varnish to those portions not reached by the spray gun, making sure that all components are adequately protected by the varnish.

(6) REASSEMBLY.

(a) Remove all masking tape from the components.

(b) Reassemble the tester by following the disassembly procedure in the reverse order.

(c) Check the over-all performance of the tester.

(7) MARKING. Mark MFP and date of treatment.

EXAMPLE: MFP . . . 1 Aug 1944.

d. Reference. For a full description of the varnish-spray method of moistureproofing and fungiproofing refer to TB SIG 13.

SECTION V SUPPLEMENTARY DATA

22. MAINTENANCE PARTS LIST FOR TEST SET I-179.

Ref symbol	Signal Corps stock No.	Major comp	Name of part and description	Quan per unit	Orgn stock			3d ech	4th ech	Depot stock
					1st ech	2d ech				
6 M-1	3F865,10		METER: 0-50 microamp. d-c; 4½" square.	1						•
RC-1	3F14050/R1		RECTIFIER: half-wave, suppressor type, B2.	1						•
SW-1	3Z9826-29.1		SELECTOR SWITCH: 2 gang-12 position; range selector; No. 25135H2.	1						•
SW-2	3Z9826-29		SELECTOR SWITCH: 2 gang-6 position; range selector; No. 25135H2.	1						•
T1	2Z9900.13		TRANSFORMER: CURRENT No. 11594.	1						•
B1	3A42		CELL: 1.5-v; Burgess No. 1 or BA-42.	1						•
B2	3A4156		BATTERY: 22.5-v; Burgess No. 4156 or BA-2.	1						•
R39	2Z7269.134		RHEOSTAT: ohmmeter adjuster; 10K ohms.	1						•
R38	2Z7278-56		RHEOSTAT: slotted shaft control; 500 ohms.	1						•

* Indicates stock available

22. MAINTENANCE PARTS LIST FOR TEST SET I-179 (contd).

Ref symbol	Signal Corps stock No.	Major comp	Name of part and description	Quan per unit	Orgn stock			3d ech	4th ech	Depot stock
					1st ech	2d ech				
R54	2Z7278-56		RHEOSTAT: slotted shaft control; 500 ohms.	1						•
C1	3DA100-151.3		CAPACITOR: 0.1-mf; 1000 v	2						•
R27	3Z6960-20		RESISTOR: pair BT-1/2 series matched to 9,000 ohms $\pm 1\%$.	1						•
R26	3Z6960-20.2		RESISTOR: pair BT-1/2 series matched to 48K ohms $\pm 1\%$.	1						•
R25	3Z6960-20.4		RESISTOR: pair BT-1/2 series matched to 240K ohms $\pm 1\%$.	1						•
R24	3Z6960-20.5		RESISTOR: pair BT-1/2 series matched to 300K ohms $\pm 1\%$.	1						•
R31	3Z6960-20.9		RESISTOR: pair BT-1/2 series matched to 180K ohms $\pm 1\%$.	1						•
R30	3Z6960-20.12		RESISTOR: pair BT-1/2 series matched to 960 ohms $\pm 1\%$.	1						•
R29	3Z6960-20.13		RESISTOR: pair BT-1/2 series matched to 4.8 megohms $\pm 1\%$.	1						•
R28	3Z6960-20.11		RESISTOR: pair BT-1/2 series matched to 6 megohms $\pm 1\%$.	1						•

• Indicates stock available

22. MAINTENANCE PARTS LIST FOR TEST SET I-179 (contd).

Ref symbol	Signal Corps stock No.	Major comp	Name of part and description	Quan per unit	Orgn stock			4th ech	Depot stock
					1st ech	2d ech	3d ech		
R23	3Z6960-23		RESISTOR: pair BT-½ series matched to 2,900 ohms ±1%.	1				•	
R21	3Z6960-23.1		RESISTOR: pair BT-½ series matched to 8,000 ohms ±1%.	1				•	
R22	3Z6960-23.2		RESISTOR: pair BT-½ series matched to 1,800 ohms ±1%.	1				•	
R1, R2, R3, R4, R5	3Z6960-23.3		RESISTOR: pair BT-½ series matched to 1.2 megohms ±1%.	5				•	
R6, R7, R8, R9, R10	3Z6960-23.4		RESISTOR: pair BT-½ series matched to 24 megohms ±1%.	5				•	
R35	3Z6960-23.5		RESISTOR: pair BT-½ series matched to 58K ohms ±1%.	1				•	
R11	3Z6960-23.6		RESISTOR: pair BT-½ series matched to 370K ohms ±1%.	1				•	
R12	3Z6960-23.7		RESISTOR: pair BT-½ series matched to 19,250 ohms ±1%.	1				•	
R15	3Z6960-23.8		RESISTOR: pair BT-½ series matched to 3712.5 ohms ±1%.	1				•	

• Indicates stock available

22. MAINTENANCE PARTS LIST FOR TEST SET I-179 (contd).

Ref symbol	Signal Corps stock No.	Major comp	Name of part and description	Quan per unit	Orgn stock		3d ech	4th ech	Depot stock
					1st ech	2d ech			
R37	3RC21BE222J		RESISTOR: 2,200 ohms, BT-1/2, ±5%.	1					*
R32	3Z6260		RESISTOR: 2,600 ohms, BT-1/2, ±5%.	1					*
R13	3Z6046J9		RESISTOR: 469 ohms, 1/2 FX, ±2-1/2%.	1					*
R14	3Z6003G7		RESISTOR: 37.5 ohms, 1/2 FX, ±2-1/2%.	1					*
R16	3Z6018-18		RESISTOR: 180 ohms, 1/2 FX, ±2-1/2%.	1					*
R17	3Z5991-67		RESISTOR: 1.5 ohms, 1/2 FX, ±2-1/2%.	1					*
R18	3Z5994-24		RESISTOR: 4 ohms, 1/2 FX, ±2-1/2%.	1					*
R19	3Z5989-3		RESISTOR: 0.95 ohm, 1/2 FX, ±2 1/2%.	1					*
R36	3Z5996-25		RESISTOR: 6 ohms, 2FY, ±5%.	1					*
R33	3Z6011-12		RESISTOR: 110 ohms, 1/2 FX, ±2 1/2%.	1					*
R20	3F3800-12		RESISTOR: 0.05 ohm, 12 amp; d-c shunt.	1					*

* Indicates stock available

Order No. 6470-SCRL-43, 3338 Copies (11 November 1944)