

760  
U113  
12  
TM  
1943

# TM 9-1808A

WAR DEPARTMENT TECHNICAL MANUAL

U.S. Dept. of Army

## POWER PLANT, CLUTCH, AND ELECTRICAL SYSTEM FOR BASIC VEHICLES $\frac{3}{4}$ -TON 4x4 and $1\frac{1}{2}$ -TON 6x6 DODGE

*This is a reprint of TM 9-1808A, Power Plant and Electrical system for basic vehicles  $\frac{3}{4}$ -ton and  $1\frac{1}{2}$ -ton 6x6 (Dodge). No distribution will be made to personnel possessing the original publication.*

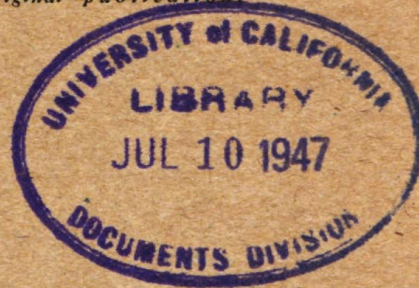

WAR DEPARTMENT

3 SEPTEMBER 1943

*WAR DEPARTMENT TECHNICAL MANUAL*  
*TM 9-1808A*

---

POWER PLANT, CLUTCH,  
AND ELECTRICAL SYSTEM  
FOR BASIC VEHICLES  $\frac{3}{4}$ -TON 4 x 4  
and  $1\frac{1}{2}$ -TON 6 x 6 DODGE



*WAR DEPARTMENT*

• *3 SEPTEMBER 1943*

WAR DEPARTMENT  
Washington 25, D. C., 3 September 1943

TM 9-1808A, Power Plant, Clutch and electrical system for basic vehicles  $\frac{3}{4}$ -ton 4 x 4 and 1½-ton 6 x 6 (Dodge) is published for the information and guidance of all concerned.

[A.G. 300.7 (29 July 43) ]

BY ORDER OF THE SECRETARY OF WAR:

G. C. MARSHALL,  
*Chief of Staff.*

OFFICIAL:

J. A. ULIO,  
*Major General,*  
*The Adjutant General.*

DISTRIBUTION: R 9 (4); Bn 9 (2); C 9 (8).

(For explanation of symbols, see FM 21-6.)

U113

2

CONTENTS TM 9: 1808 A

1943

	★ Paragraphs	★ Pages
CHAPTER 1. INTRODUCTION .....	1- 6	4- 11
CHAPTER 2. ENGINE AND CLUTCH.....	7- 78	12- 181
SECTION I. General description and construction .....	7- 14	12- 32
II. Engine trouble shooting .....	15- 24	33- 42
III. Engine repairs (engine in vehicle) .....	25- 34	43- 67
IV. Removal of engine .....	35- 37	68- 75
V. Disassembly of engine.....	38- 39	76- 85
VI. Inspection and repair of engine components .....	40- 50	86-105
VII. Assembly of engine.....	51- 53	106-120
VIII. Carburetor and governor (Zenith) and fuel pump rebuilding .....	54- 62	121-148
IX. Water pump rebuilding .....	63- 65	149-155
X. Oil pump rebuilding .....	66- 68	156-162
XI. Clutch rebuilding .....	69- 71	163-167
XII. Installation of engine .....	72- 76	168-177
XIII. Engine fits and tolerances .....	77- 78	178-181
CHAPTER 3. ELECTRICAL SYSTEM .....	79-103	182-264
SECTION I. General description and construction .....	79- 85	182-198
II. Electrical trouble shooting .....	86- 87	199-218
III. Starter rebuilding .....	88- 90	219-228
IV. Generator and regulator rebuilding .....	91- 98	229-254

7574692

Generated on 2016-06-20 18:29 GMT / http://hdl.handle.net/2027/uc1.b3243992  
Public Domain, Google-digitized / http://www.hathitrust.org/access\_use#pd-google

# TM 9-1808A

	Paragraphs	Pages
SECTION V. Ignition distributor rebuilding .....	99-101	255-261
VI. Electrical system fits and tolerances .....	102-103	262-264
CHAPTER 4. TOOL EQUIPMENT .....	104	265-267
REFERENCES .....		267-268
INDEX .....		269-275
CARTER CARBURETOR AND GOVERNOR		
REBUILDING .....	(See supplement in back of manual)	

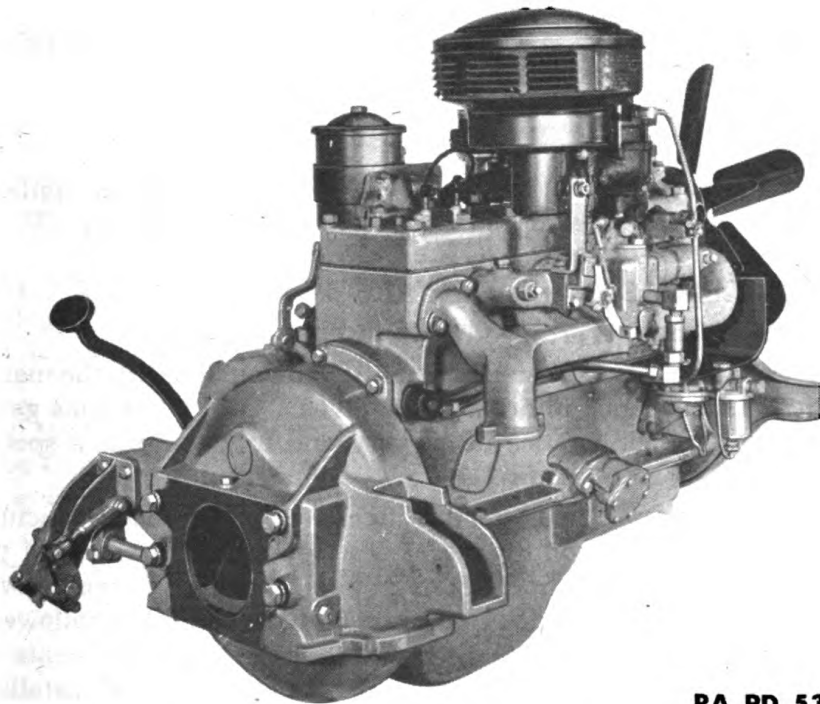
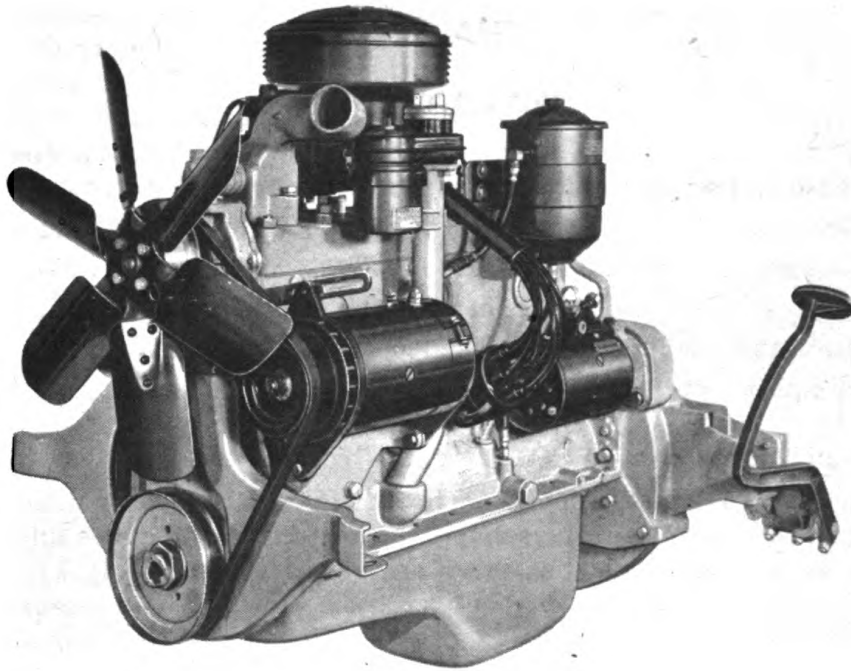

RA PD 53233

**Figure 1—Dodge  $\frac{3}{4}$  Ton 4 x 4 and  $1\frac{1}{2}$  Ton 6 x 6 Engine**

**ORDNANCE MAINTENANCE—POWER PLANT, CLUTCH, AND ELECTRICAL SYSTEM— $\frac{3}{4}$  AND  $1\frac{1}{2}$  TON VEHICLES (DODGE)**

**CHAPTER 1**

**INTRODUCTION**

	Paragraph
Purpose and scope .....	1
References .....	2
Arrangement of manual .....	3
Distinguishing characteristics of materiel .....	4
Organization maintenance .....	5
Tool equipment .....	6

**1. PURPOSE AND SCOPE**

a. This manual is published for the information and guidance of Ordnance maintenance personnel. It contains maintenance information on the engine assembly, clutch and electrical system (fig. 1) of the Dodge  $\frac{3}{4}$  ton 4 x 4 and  $1\frac{1}{2}$  ton 6 x 6 basic vehicles. Maintenance instructions are supplementary to those contained in the Operator's Manuals TM 9-808, TM 9-750A and TM 9-810 published for the using arms.

b. In addition to the instructions contained in this manual on carburetors, maintenance information is also contained in TM 9-1826A for the Carter carburetor and TM 9-1826C for the Zenith carburetor.

c. Another manual, TM 9-1808B, contains maintenance information on the power train and chassis of these vehicles.

**2. REFERENCES**

a. Standard nomenclature lists and other publications applicable to the materiel described in this manual are listed in Chapter IV.

**3. ARRANGEMENT OF MANUAL**

a. The manual is arranged as follows:

(1) CHAPTER 1. Contains information to help identify the materiel on which maintenance information is given. It also contains general information on maintenance terms used and tool equipment specified for servicing, repairing and rebuilding the materiel.

(2) CHAPTER 2. Concerns the engine and components (including the clutch), beginning with general description and function of parts and specifications and data. Engine trouble shooting and repairs which may be made with the engine in the truck are treated next, followed by removal and complete disassembly of the engine and components. Inspection and repair of engine components, reassembly and installation of the engine in the truck, and finally a chart of engine fits and tolerances completes Chapter 2.

## INTRODUCTION

(3) CHAPTER 3. Concerns the electrical system which is divided into sections containing information on the starting system, generating system and ignition system. It contains electrical trouble shooting information, rebuilding instructions and a table of fits and tolerances for electrical units. Wiring circuit diagrams show all electrical circuits of the vehicles. No maintenance information is given covering the lighting system, replacement of wiring, or miscellaneous electrical equipment, as these subjects are treated fully in TM 9-808 and TM 9-810.

U.S.A. REGISTRATION NUMBER  
IS SHOWN ON BOTH  
SIDES OF THE HOOD

AND ON THE REAR OF SOME BODIES

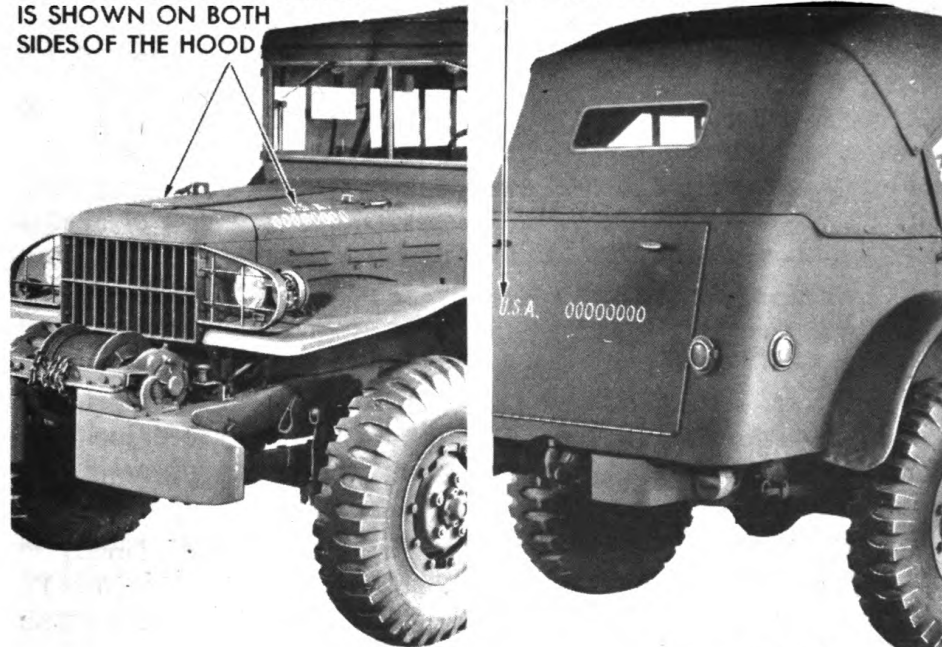

RA PD 53212

**Figure 2—U. S. A. Registration Numbers**

(4) CHAPTER 4. Contains a list of special tools. Chapter 4 is followed by a list of references to other publications applicable to the materiel described.

(5) CARTER CARBURETOR SUPPLEMENT. A supplement has been added to the back of this manual containing maintenance instructions on the Carter ETW1 carburetor with which later model vehicles are equipped.

## 4. DISTINGUISHING CHARACTERISTICS OF MATERIEL

a. **General.** The  $\frac{3}{4}$  ton, 4 x 4 basic vehicles are manufactured in different models for various tactical uses. The electrical systems of the various models differ insofar as the voltage output is concerned, however, to provide for the installation of radio equipment in certain body styles. The  $1\frac{1}{2}$  ton, 6 x 6 vehicle is manufactured in one body



**ORDNANCE MAINTENANCE—POWER PLANT, CLUTCH, AND ELECTRICAL SYSTEM— $\frac{3}{4}$  AND  $1\frac{1}{2}$  TON VEHICLES (DODGE)**

style with a 6-volt electrical system identical to that used in  $\frac{3}{4}$  ton 4 x 4 models equipped with 6-volt systems. The electrical system is explained in paragraphs 79 through 85. The stripped engine and components is identical in all  $\frac{3}{4}$  ton, 4 x 4 and  $1\frac{1}{2}$  ton, 6 x 6 models.

b. **U. S. A. Registration Numbers** (fig. 2). The following tabulation of U. S. A. registration numbers is given to help identify the materiel described in this manual. Operator's Manuals TM 9-808, TM 9-720A and TM 9-810 contain pictures of the various models listed below:

Model	Body Style	U. S. A. Registration Numbers
WC-51	Weapon carrier ( $\frac{3}{4}$ ton, 4 x 4)	252293 to 254792 (incl.)
		259135 to 289212 (incl.)
		291910 to 291992 (incl.)
		293685 to 294209 (incl.)
		2110000 to 2125113 (incl.)
WC-52	Weapon carrier with winch ( $\frac{3}{4}$ ton, 4 x 4)	2232075 to 2233424 (incl.)
		245845 to 246394 (incl.)
		289213 to 291384 (incl.)
		291993 to 292512 (incl.)
		2160419 to 2179292 (incl.)
WC-53	Command field sedan ( $\frac{3}{4}$ ton, 4 x 4)	2180276 to 2199555 (incl.)
		2092777 to 2092778 (incl.)
WC-53	Carryall ( $\frac{3}{4}$ ton, 4 x 4)	2072128 to 2073327 (incl.)
		20163146 to 20167956 (incl.)
		2089952 to 2091083 (incl.)
		2089176 to 2089947 (incl.)
		2080156 to 2089175 (incl.)
WC-54	Ambulance ( $\frac{3}{4}$ ton, 4 x 4)	20260793 to 20261257 (incl.)
		77841 to 79999 (incl.)
		710000 to 719045 (incl.)
		750068 to 750083 (incl.)
WC-55	37mm. gun motor carriage M6 ( $\frac{3}{4}$ ton, 4 x 4)	721000 to 732635 (incl.)
		6016072 to 6021066 (incl.)
WC-56	Command ( $\frac{3}{4}$ ton, 4 x 4)	6022453 to 6022837 (incl.)
		20167957 to 20182608 (incl.)
WC-57	Command with winch ( $\frac{3}{4}$ ton, 4 x 4)	2091084 to 2091983 (incl.)
		20184953 to 20185868 (incl.)
		2092119 to 2092618 (incl.)
WC-58	Radio ( $\frac{3}{4}$ ton, 4 x 4)	20291158 to 20295751 (incl.)
		20182690 to 20184952 (incl.)
WC-59	Telephone maintenance (L.I.U. body) ( $\frac{3}{4}$ ton, 4 x 4)	0015366 to 0015914 (incl.)

**INTRODUCTION**

Model	Body Style	U. S. A. Registration Numbers
WC-60	Emergency repair chassis ( $\frac{3}{4}$ ton, 4 x 4)	0015915 to 0015986 (incl.) 0026383 to 0026606 (incl.)
WC-61	Telephone maintenance (body model 4551) ( $\frac{3}{4}$ ton, 4 x 4)	0051312 to 0051369 (incl.)
WC-62	Personnel and cargo ( $1\frac{1}{2}$ ton, 6 x 6)	3297503 to 3328846 (incl.)
WC-63	Personnel and cargo with winch ( $1\frac{1}{2}$ ton, 6 x 6)	3328847 to 3342502 (incl.)

**5. MAINTENANCE ALLOCATION.**

a. **Scope.** The scope of maintenance and repair by the crew and other units of the using arms is determined by the availability of suitable tools, availability of necessary parts, capabilities of the mechanics, time available, and the tactical situation. All of these are variable and no exact system of procedure can be prescribed.

b. **Allocation of Maintenance.** Indicated below are the maintenance duties for which tools and parts have been provided for the using arm and ordnance maintenance personnel. Replacements and repairs which are the responsibility of ordnance maintenance personnel may be performed by using arm personnel when circumstances permit, within the discretion of the commander concerned. Echelons and words as used in this list of maintenance allocations are defined as follows:

- SECOND ECHELON:** Line organization regiments, battalions, companies, detachments, and separate companies.
- THIRD ECHELON:** Ordnance light maintenance companies, ordnance medium maintenance companies, ordnance divisional maintenance battalions, and post ordnance shops.
- FOURTH ECHELON:** Ordnance heavy maintenance companies, and service command shops.
- FIFTH ECHELON:** Ordnance base regiments, ordnance bases, arsenals, and manufacturers' plants.
- SERVICE (including preventive maintenance):** Consists of servicing, cleaning, lubricating, tightening bolts and nuts, and making external adjustments of sub-assemblies or assemblies and controls. Refer to AR 850-15, paragraph 23 a (1) and (2).

**ORDNANCE MAINTENANCE—POWER PLANT, CLUTCH, AND ELECTRICAL SYSTEM— $\frac{3}{4}$  AND 1 $\frac{1}{2}$  TON VEHICLES (DODGE)**

**REPLACE:** Refer to AR 850-15, paragraph 23 a (4).

Consists of removing the part, sub-assembly or assembly from the vehicles and replacing it with a new or reconditioned or rebuilt part, sub-assembly or assembly, whichever the case may be.

**REPAIR:** Refer to AR 850-15, paragraph 23 a (3) and (5), in part.

Consists of making repairs to, or replacement of the part, subassembly or assembly that can be accomplished without completely disassembling the subassembly or assemblies, and does not require heavy welding, or riveting, machining, fitting and/or alining or balancing.

**REBUILD:** Refer to AR 850-15, paragraph 23 a (5) in part, and (6).

Consists of completely reconditioning and replacing in serviceable condition any unserviceable part, subassembly or assembly of the vehicle, including welding, riveting, machining, fitting, alining, balancing, assembling and testing.

c. The following chart indicates maintenance allocation for only those components of the vehicle, the maintenance of which is covered in this manual. For a complete chart of the maintenance duties for a specific vehicle, refer to the pertinent 100-series Technical Manual.

CLUTCH	ECHELONS			
	2nd	3rd	4th	5th
Clutch—replace . . . . .	E	X		
Clutch—repair . . . . .		X		
Clutch—rebuild . . . . .			E	X
Controls and linkage—service and/or replace . . . . .	X			
Controls and linkage—repair . . . . .		X		
Housing, clutch—replace . . . . .		X		
Housing, clutch—rebuild . . . . .			X	

**NOTE:** Operations allocated will normally be performed in the echelon indicated by "X".

Operations allocated to the echelons as indicated by "E" may be accomplished by the respective echelons in emergencies only.

**NOTE:** \*The second echelon is authorized to remove and reinstall items marked by an asterisk. However, when it is necessary to replace an item marked by an asterisk with a new or rebuilt part, sub-assembly or unit assembly, the assembly marked by an asterisk may be removed from the vehicle by the second echelon *only after authority has been obtained from a high echelon of maintenance.*

**INTRODUCTION**

	ECHELONS			
	2nd	3rd	4th	5th
<b>COOLING GROUP</b>				
Connections—replace . . . . .	X			
Radiator assembly—replace . . . . .	X			
Radiator assembly—repair . . . . .		X		
Radiator assembly—rebuild . . . . .			E	X
System, cooling—service . . . . .	X			
Tank, surge—replace . . . . .	X			
Tank, surge—repair . . . . .		X		
<b>ELECTRICAL GROUP</b>				
Battery—service, recharge and/or replace . . . . .	X			
Battery—repair . . . . .		X		
Battery—rebuild . . . . .			E	X
Cables, battery—replace and/or repair . . . . .	X			
Coil, ignition—replace . . . . .	X			
Horn assembly—service and/or replace . . . . .	X			
Horn assembly—repair . . . . .		X		
Lamp assemblies—service and/or replace . . . . .	X			
Lamp assemblies—repair . . . . .		X		
Regulator, current and voltage—replace . . . . .	X			
Regulator, current and voltage—service and/or repair . . . . .		X		
Regulator, current and voltage—rebuild . . . . .			X	
Switch assemblies—replace . . . . .	X			
Switch assemblies—repair . . . . .		X		
Wiring—replace . . . . .	X			
<b>ENGINE</b>				
Bearings, connecting rod (inserts)—replace . . . . .		E	E	X
Bearings, crankshaft (inserts)—replace . . . . .		E	E	X
Belt—service and/or replace . . . . .	X			
Block, cylinder—rebuild (recondition) . . . . .			E	X
Carburetor assembly—service and/or replace . . . . .	X			
Carburetor assembly—repair . . . . .		X		
Carburetor assembly—rebuild . . . . .			X	
Chain, timing—replace . . . . .		X		
Cleaner, air—service and/or replace . . . . .	X			
Cleaner, air—repair . . . . .		X		
Condenser, distributor—replace . . . . .	X			
Controls and linkage—service and/or replace . . . . .	X			
Controls and linkage—repair . . . . .		X		
Crankshaft—rebuild (recondition) . . . . .			E	X
Distributor assembly—service and/or replace . . . . .	X			
Distributor assembly—repair . . . . .		X		
Distributor assembly—rebuild . . . . .			X	

**ORDNANCE MAINTENANCE—POWER PLANT, CLUTCH, AND ELECTRICAL SYSTEM— $\frac{3}{4}$  AND 1  $\frac{1}{2}$  TON VEHICLES (DODGE)**

	ECHELONS			
	2nd	3rd	4th	5th
*Engine assembly—replace .....	*	X		
Engine assembly—repair .....		X		
Engine assembly—rebuild .....			E	X
Fan assembly—replace .....	X			
Fan assembly—repair .....		X		
Fan assembly—rebuild .....			X	
Filter assembly, oil—service or replace cartridge..	X			
Filter assembly, oil—replace .....	X			
Filter assembly, oil—repair .....		X		
Flywheel assembly—replace and/or repair .....		X		
Flywheel assembly—rebuild (recondition) .....			E	X
Gaskets, cylinder head, manifold and oil pan— replace .....	X			
Generator assembly—replace .....	X			
Generator assembly—repair .....		X		
Generator assembly—rebuild .....			X	
Governor assembly—adjust and/or replace .....		X		
Governor assembly—rebuild .....			E	X
Head, cylinder—replace and/or repair .....		X		
Lines and connections, oil (external)—replace and/or repair .....	X			
Lines and connections, oil (internal)—replace and/or repair .....		X		
Manifolds—replace .....	X			
Manifolds—rebuild .....			X	
Motor assembly, starting—replace .....	X			
Motor assembly, starting—repair .....		X		
Motor assembly, starting—rebuild .....			X	
Pan assembly, oil—service and replace gaskets...	X			
Pan assembly, oil—replace and/or repair .....		X		
Pistons and rings—replace .....		E	E	X
Plugs, spark—service and/or replace .....	X			
Plugs, spark (two piece)—repair .....		X		
Points, breaker, distributor—replace .....	X			
Pump assembly, fuel—service and/or replace .....	X			
Pump assembly, fuel—repair .....		X		
Pump assembly, fuel—rebuild .....			X	
Pump assembly, oil—replace and/or repair .....		X		
Pump assembly, oil—rebuild .....			X	
Pump assembly, water—replace .....	X			
Pump assembly, water—repair .....		X		
Pump assembly, water—rebuild .....			X	

\*See Note on Page 8.

**INTRODUCTION**

	ECHELONS			
	2nd	3rd	4th	5th
Rods, connecting—replace . . . . .		E	E	X
Seal, oil, timing chain cover—replace . . . . .	E	X		
Sprockets, timing chain—replace . . . . .		X		
Thermostat—replace . . . . .	X			
Valves—service . . . . .	X			
Ventilator, crankcase—service and/or replace . . . . .	X			
Wiring, ignition—replace . . . . .	X			
<b>EXHAUST GROUP</b>				
Muffler and exhaust pipes—replace . . . . .	X			
<b>FUEL GROUP</b>				
Filter assembly, fuel—service and/or replace . . . . .	X			
Lines and connections—replace and/or repair . . . . .	X			
Tank—service and/or replace . . . . .	X			
Tank—repair . . . . .		X		
<b>INSTRUMENTS</b>				
Instruments—replace . . . . .	X			
Instruments—repair . . . . .		X		
Instruments—rebuild . . . . .			E	X

**6. TOOL EQUIPMENT.**

a. Ordnance maintenance personnel is supplied with sets of general issue tool equipment which has been utilized in describing maintenance and repair of trucks covered by this manual. The tools applicable to the work described are designated by the federal stock number of the particular tool employed, and a complete list is given in paragraph 104.

**ORDNANCE MAINTENANCE—POWER PLANT, CLUTCH, AND  
ELECTRICAL SYSTEM— $\frac{3}{4}$  AND  $1\frac{1}{2}$  TON VEHICLES (DODGE)**

**CHAPTER 2**

**ENGINE AND CLUTCH**

**Section I**

**GENERAL DESCRIPTION AND CONSTRUCTION**

	Paragraph
Engine and serial numbers.....	7
Engine and components.....	8
Fuel system.....	9
Exhaust system.....	10
Engine oiling system.....	11
Cooling system.....	12
Clutch .....	13
Data and specifications.....	14

**7. ENGINE AND SERIAL NUMBERS (fig. 3).**

a. The engine number is stamped on a boss on the left side of the engine block opposite the No. 1 cylinder. The letter on the circular bosses on the block are for the use of factory inspectors only, and are not to be used with the engine number. The vehicle serial number is stamped on a plate which is attached to the face of the instrument panel, and on the left frame side member just forward of the front axle. The  $\frac{3}{4}$  ton, 4 x 4 engine numbers start with number T214-1001, and vehicle serial numbers start with number 81,534,381. The  $1\frac{1}{2}$  ton, 6 x 6 engine numbers start with number T223-1001, and vehicle serial numbers start with number 82,000,001.

**8. ENGINE AND COMPONENTS.**

a. **General.** The engine (fig. 4) is of the poppet valve gasoline-burning type, with liquid cooling and pressure lubrication.

b. **Crankshaft and Crankshaft Bearings** (fig. 4). The crankshaft is counterweighted and thoroughly balanced. It is mounted in four replaceable precision-type bearings. The crankshaft can be removed and installed with the engine in the truck. The crankshaft bearings are babbitt on steel backs, and are accessible for inspection or replacement with the engine oil pan removed.

c. **Camshaft and Bearings** (fig. 4). A chain-driven camshaft actuates the valves and fuel pump, and also drives the oil pump and

## GENERAL DESCRIPTION AND CONSTRUCTION

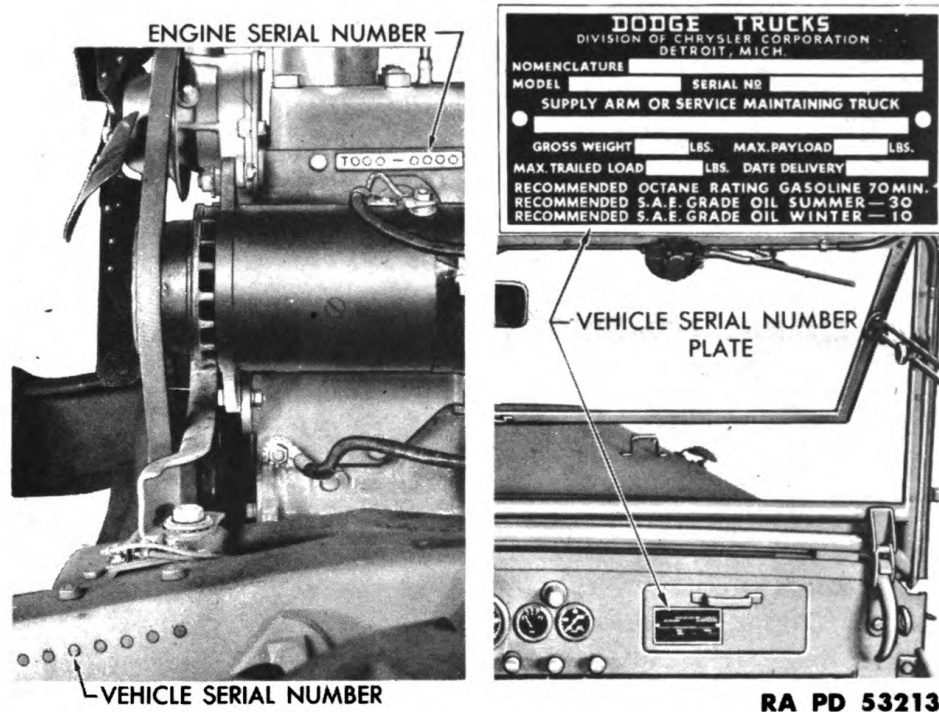

**Figure 3—Engine and Serial Numbers**

distributor. The camshaft has four bearings. The three forward bearings are replaceable with the camshaft removed; the rear bearing is machined into the cylinder block. The timing chain, which drives the camshaft, can be replaced with the radiator core and chain case cover removed.

d. **Pistons, Connecting Rods and Bearings (fig. 4).** Pistons of the U slot type are attached to the upper end of the connecting rods by floating-type piston pins. The piston pins are retained in the pistons by a steel retaining ring at each end of the pins. Piston and connecting rod assemblies can be removed through the upper end of the cylinder bore with the cylinder head and oil pan removed. Connecting rod bearings are accessible for inspection or replacement with the oil pan removed.

e. **Valves (fig. 4).** The valves, valve seats, guides and valve springs are accessible for inspection, repairs or replacement with the cylinder head and tappet covers removed. Hardened steel inserts are installed in the exhaust valve port of the block and the exhaust valve seats are ground into the inserts. The intake valve seats are machined into the metal of the block. Valve stems operate in cast iron guides which are replaceable with the valves and springs removed. The valve tappets are of the mushroom type, with a self-locking adjusting screw. The ad-



ORDNANCE MAINTENANCE—POWER PLANT, CLUTCH, AND ELECTRICAL SYSTEM— $\frac{3}{4}$  AND  $1\frac{1}{2}$  TON VEHICLES (DODGE)

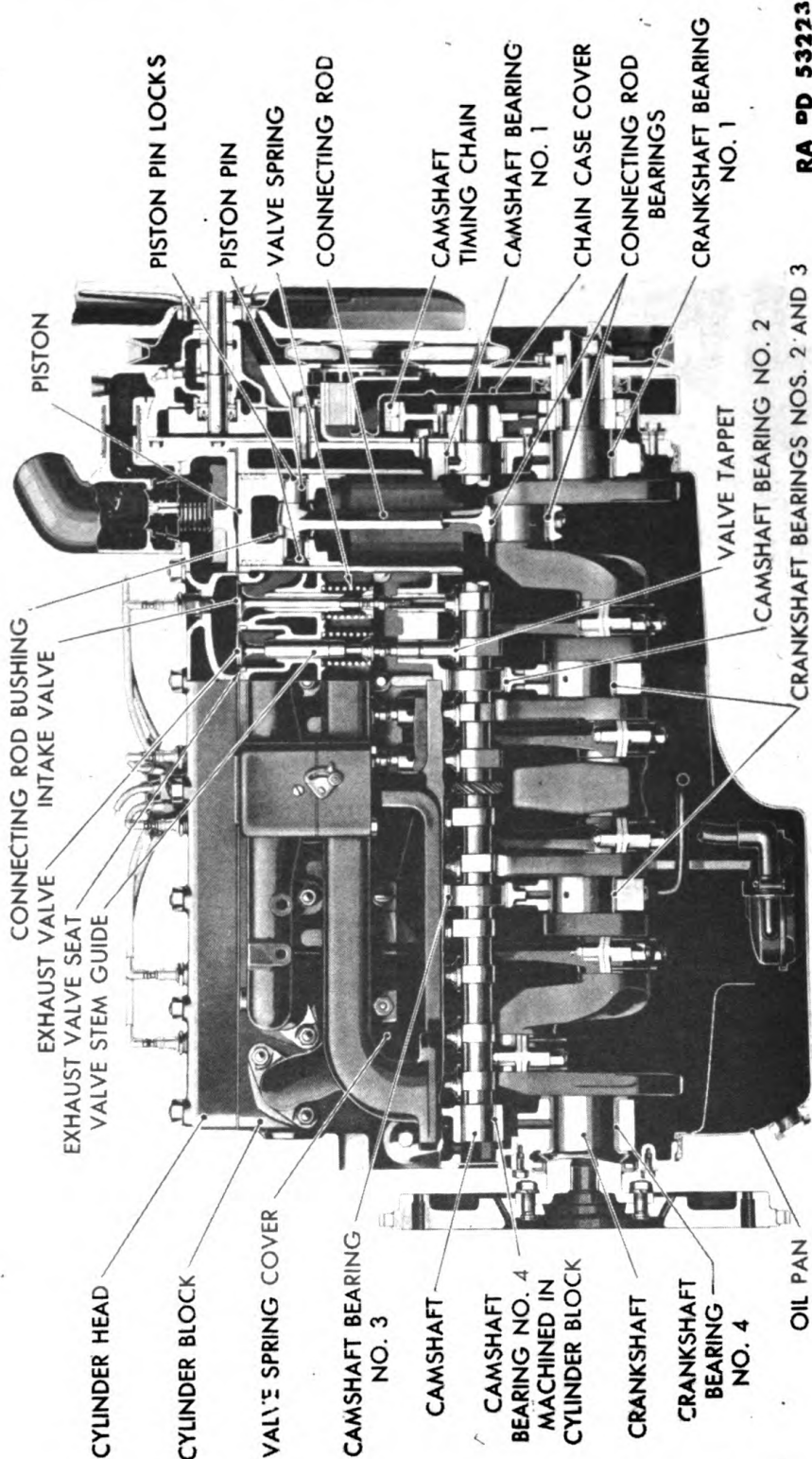
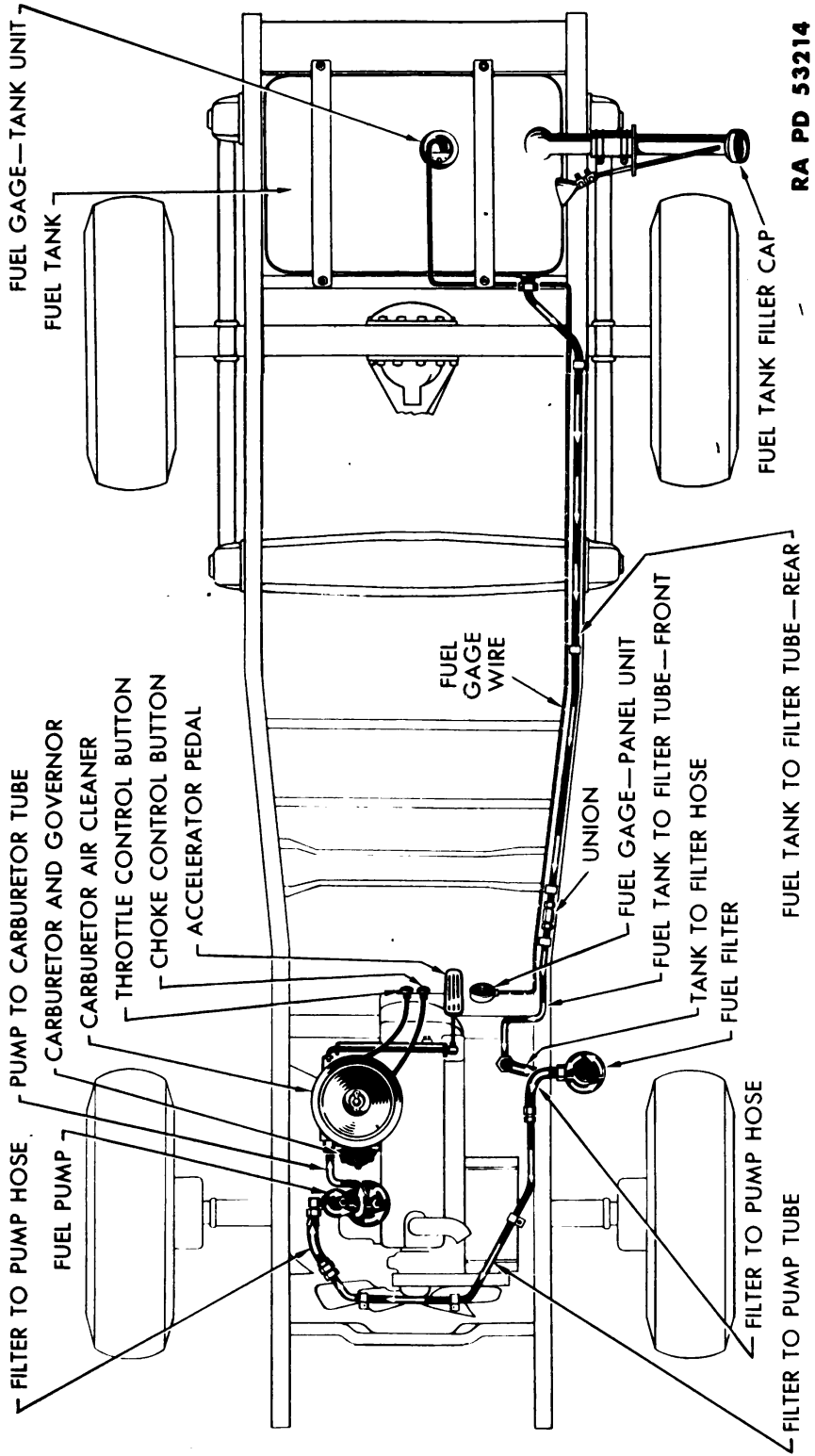

Figure 4—Engine—Side Sectional View

RA PD 53223

GENERAL DESCRIPTION AND CONSTRUCTION



RA PD 53214

Figure 5—Fuel System

729923 O - 47 - 2

Generated on 2016-06-20 20:13 GMT / http://hdl.handle.net/2027/uc1.b3243992  
Public Domain, Google-digitized / http://www.hathitrust.org/access\_use#pd-google

**ORDNANCE MAINTENANCE—POWER PLANT, CLUTCH, AND ELECTRICAL SYSTEM— $\frac{3}{4}$  AND  $1\frac{1}{2}$  TON VEHICLES (DODGE)**

justing screw is replaceable with the valve and spring removed, and the tappet can be replaced with the camshaft removed.

**9. FUEL SYSTEM (fig. 5).**

**a. Fuel Pump (fig. 6).** Fuel is drawn from the supply tank at the rear of the truck by a fuel pump located on the right side of the engine, and is delivered by the pump to the carburetor. The fuel pump consists

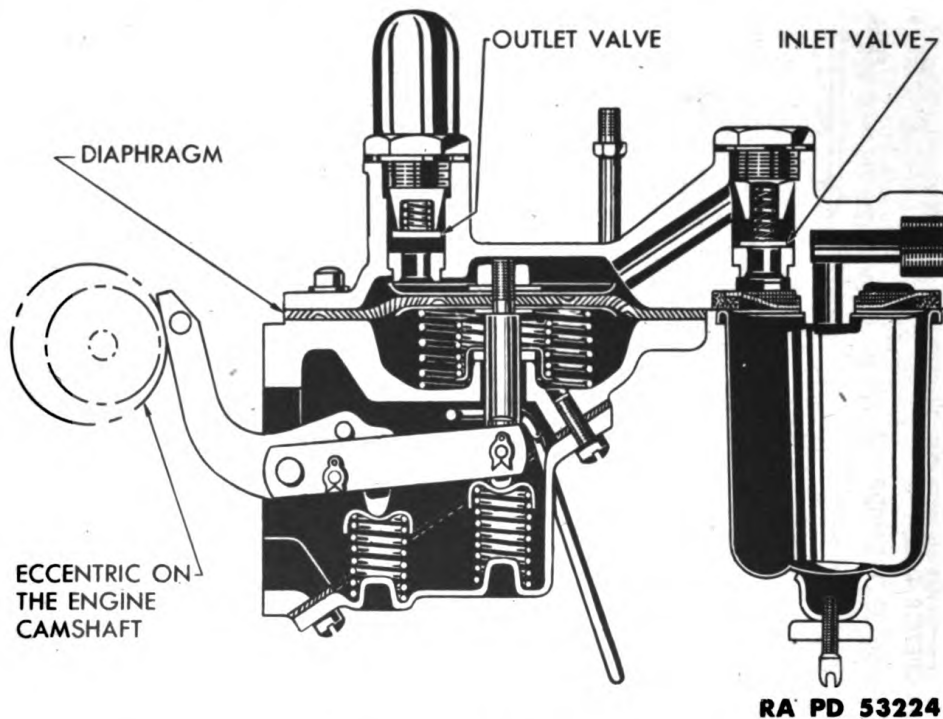
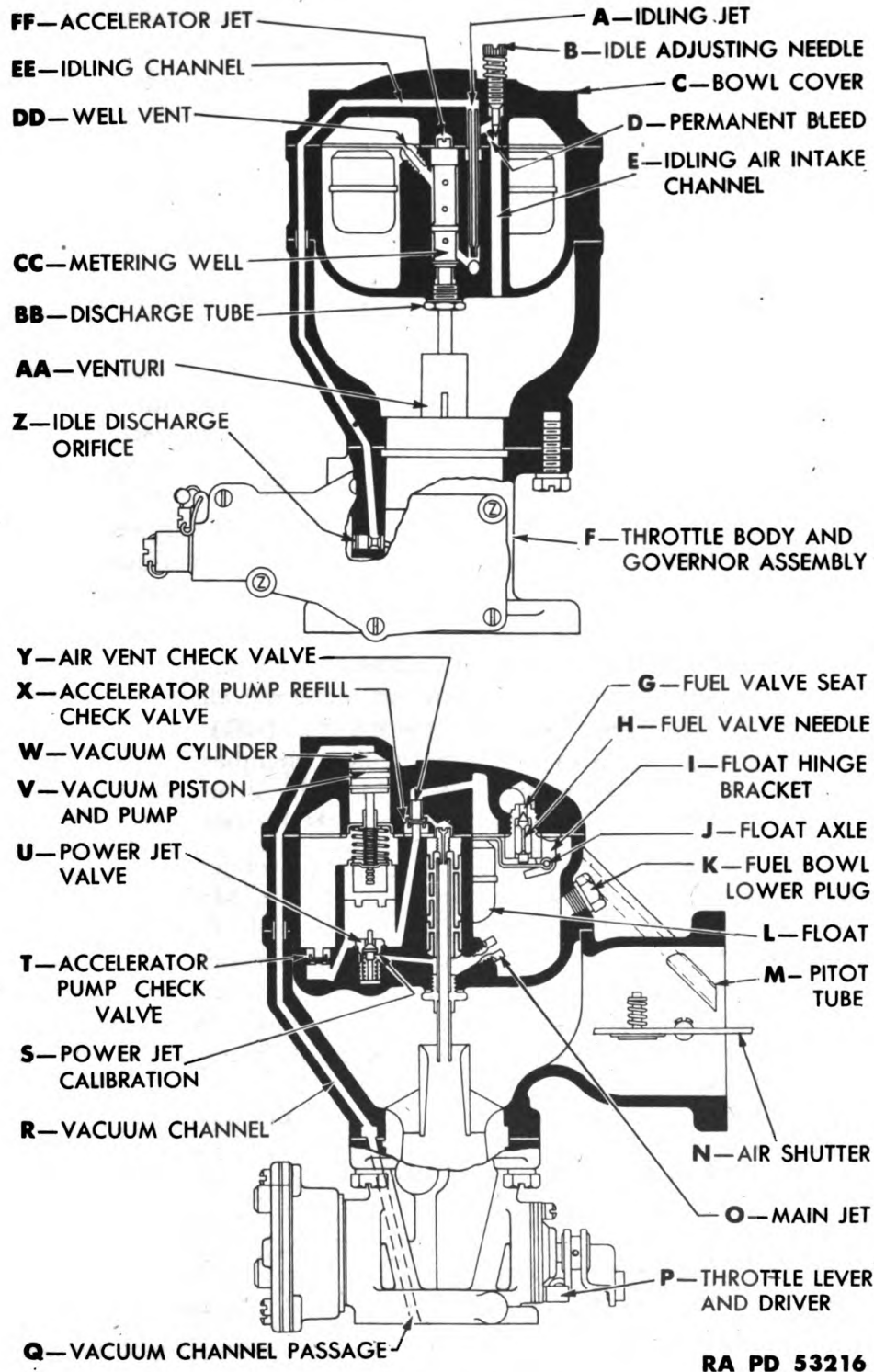

**Figure 6—Fuel Pump**

mainly of a diaphragm and inlet and outlet valves. It is operated by an eccentric on the engine camshaft and can be readily removed from the engine for inspection, repairs or replacement.

**b. Carburetor (Zenith) (fig. 7).** The carburetor is the downdraft type. Air for fuel chamber ventilation enters through the air cleaner to eliminate dirt, and to provide a constant fuel-air ratio. The carburetor incorporates a vacuum-controlled power jet and an accelerating system to provide the extra fuel needed for certain operations. Air passing through the carburetor under atmospheric pressure, picks up fuel from the carburetor and enters the combustion chambers of the engine as a combustible mixture of air and gasoline. The five fuel circuits in the carburetor are described in the following paragraphs. All key letters in the following description refer to figure 7.

GENERAL DESCRIPTION AND CONSTRUCTION



RA PD 53216

Figure 7—Carburetor

**ORDNANCE MAINTENANCE—POWER PLANT, CLUTCH, AND ELECTRICAL SYSTEM— $\frac{3}{4}$  AND  $1\frac{1}{2}$  TON VEHICLES (DODGE)**

(1) **FUEL SUPPLY SYSTEM** (fig. 7). Under normal fuel pump pressure, fuel enters the float chamber through the fuel valve seat (G) controlled by the float (L) which, moving on its axle (J), closes the fuel valve needle (H) when the fuel reaches a predetermined level in the bowl.

(2) **IDLING SYSTEM** (fig. 7). At idling speeds, the throttle plate is almost closed and a very high suction exists at the edge of the throttle plate. The priming plug or idle discharge orifice is located at this point. As engine speed is increased, the mixture from the idling system becomes less and less until the idling system is not a factor in the operation of the engine. Fuel from the float chamber flows through the main jet (O) into the metering well (CC). Fuel for idling is drawn from this well through the metering orifice in the lower end of the idling jet (A). As the fuel reaches the idling channel (EE), it is mixed with air which is admitted from air intake channel (E) through the permanent bleed (D) plus that admitted by the idling adjusting needle (B). The mixture passes through the channel (EE) to the idle discharge orifice (Z) at which point it is discharged into the air stream. The permanent bleed (D) prevents the fuel from being syphoned into the manifold.

(3) **MAIN JET SYSTEM** (fig. 7). As the throttle is opened, the suction at the idle discharge orifice diminishes, but the increased volume of air entering the engine creates sufficient vacuum in the secondary venturi (AA) to draw fuel from the metering well (CC) up and over into the discharge tube (BB). Air from the float chamber, which is vented through a channel to the pitot tube (M) in the air intake, is admitted to the outer side of the metering well through the well vent (DD).

(4) **POWER JET SYSTEM** (fig. 7). The power jet system supplies the additional fuel necessary for maximum power. Manifold vacuum is communicated through passage (Q) and channel (R) to the vacuum cylinder (W). Under normal part-throttle operating conditions, the vacuum piston and pump assembly (V) is held in the upper position as illustrated and the power jet valve (U) is closed. When the throttle is opened wide, or when the load on the engine is increased, due to road conditions, to a point where the manifold vacuum drops below a predetermined point, the pump assembly drops and holds the power jet valve (U) open. This permits fuel to flow through the power jet calibration (S) to supplement the main jet fuel in the well and provide a full power mixture. When the throttle position, or the road and load condition, allows the manifold vacuum to rise above a predetermined point, the pump assembly is lifted and the power jet valve closed, permitting the carburetor to deliver an economical mixture again.

(5) **ACCELERATING SYSTEM** (fig. 7). A quick opening of the throttle produces a sudden drop in the manifold vacuum, which in turn allows the pump piston to be forced down by the pump spring supplying

## GENERAL DESCRIPTION AND CONSTRUCTION

the additional fuel needed for rapid acceleration. The downward movement of the pump piston closes the pump check valve (T); opens refill check valve (X); closes air vent check valve (Y); and discharges the pump fuel through accelerating jet (FF) into the main discharge tube (BB). As soon as the pump stroke is completed, the refill check valve disk drops, opening the air vent (Y). The pump check valve (T) also opens (by gravity) to permit fuel to flow to the power jet or to refill the pump cylinder on the upward stroke of the pump. The air vent check valve (Y) supplies air from the float chamber to the accelerating jet to break the suction on the accelerating and power jet system the instant the vacuum piston starts to lift the pump assembly.

c. **Governor Assembly** (fig. 7). The built-in velocity type governor protects the engine against damage from excessive engine speeds by limiting the top speed of the engine. It in no way affects the power or acceleration of the engine up to the governed speed. The governor is calibrated with special tools and equipment and then sealed to prevent unauthorized adjustments or disassembly.

d. **Carburetor and Governor (Carter)**. See supplement in back of this manual for description of Carter carburetor used on later model vehicles.

e. **Fuel Filter**. A cleanable type metal disk filter is located in the fuel line between the fuel tank and the fuel pump (fig. 5). If clogged with foreign matter, the filter will restrict the supply of fuel to the engine, but can be readily removed and cleaned.

### 10. EXHAUST SYSTEM.

a. The exhaust manifold is equipped with an adjustable valve which regulates the amount of exhaust heat bypassed around the intake manifold heater body. More heat on the intake manifold is required when operating in cold climates; therefore, winter and summer settings of the control valve are provided.

### 11. ENGINE OILING SYSTEM (fig. 8).

a. The engine is lubricated by oil drawn from the oil pan by the oil pump (fig. 9) and forced under pressure through drilled passages in the cylinder block to the crankshaft and crankshaft bearings (fig. 10). Passages are drilled in the crankshaft to allow oil to be forced through the crankshaft bearings to the connecting rod bearings (fig. 11). A limited amount of oil is forced from the camshaft front bearing to the chain case to lubricate the timing chain and sprockets (fig. 11). The cylinder walls, the pistons, the piston pins and valve tappets are lubricated by an oil spray from the connecting rod bearings (fig. 12). The camshaft thrust plate is lubricated through an oil passage in the camshaft (fig. 12). Oil pressure is controlled by a relief valve mounted on the left side of the engine (fig. 13). The engine oil passes through the filter when the relief valve plunger is off its seat (fig. 13).

ORDNANCE MAINTENANCE—POWER PLANT, CLUTCH, AND ELECTRICAL SYSTEM— $\frac{3}{4}$  AND  $1\frac{1}{2}$  TON VEHICLES (DODGE)

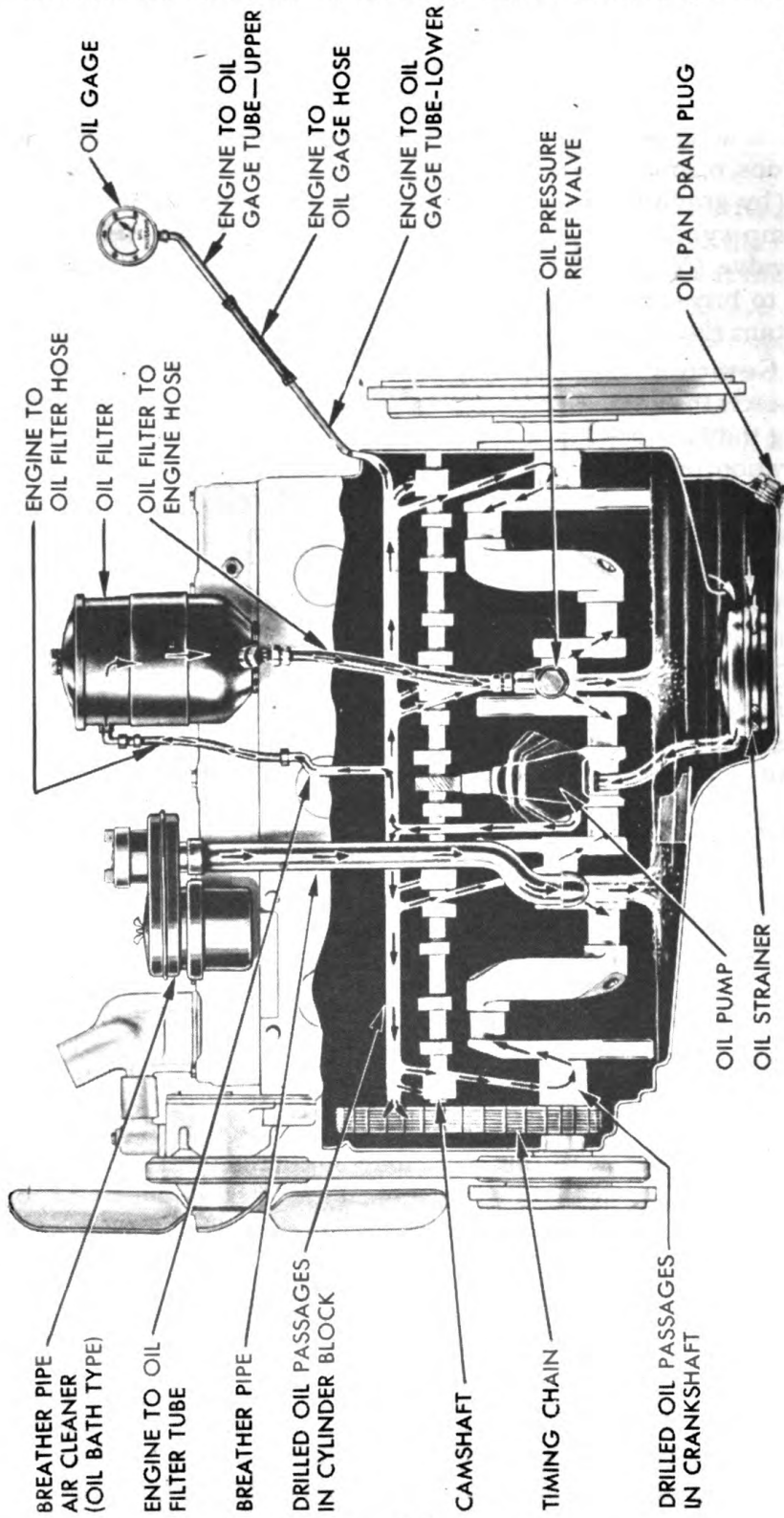

RA PD 53227

Figure 8—Engine Oiling System

**GENERAL DESCRIPTION AND CONSTRUCTION**

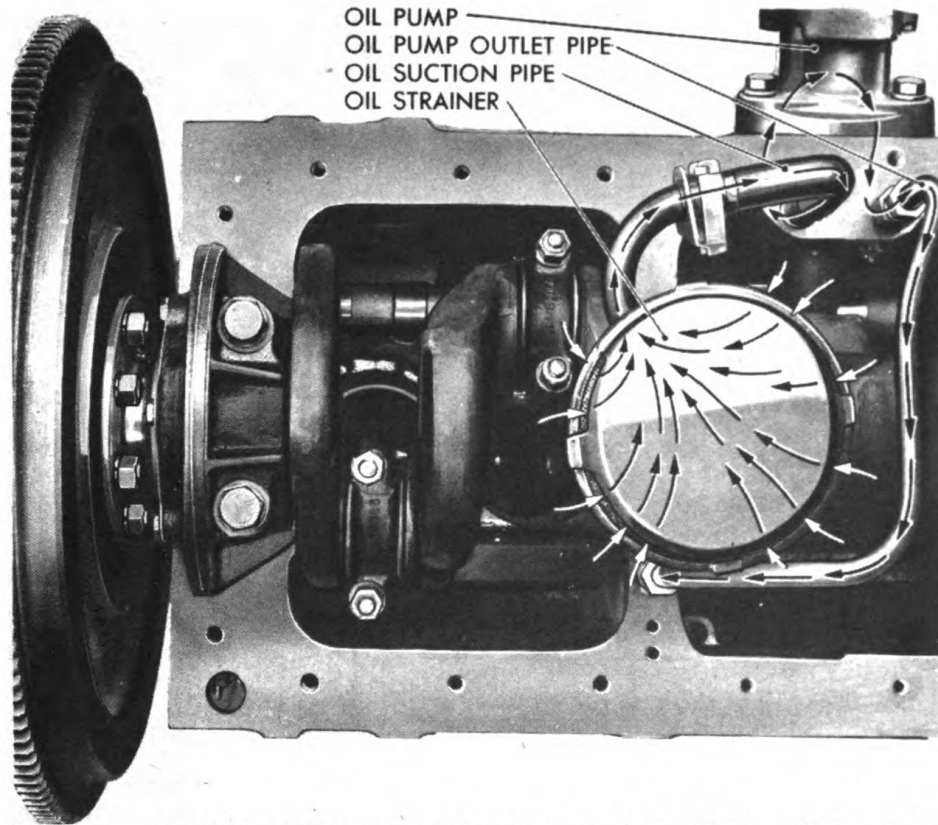

SUCTION CREATED BY REVOLVING GEARS IN THE OIL PUMP DRAWS OIL FROM THE OIL PAN THROUGH A STRAINER SCREEN INTO THE PUMP, THE OIL IS FORCED THROUGH THE PUMP BY THE REVOLVING ACTION OF THE PUMP GEARS INTO THE OIL PUMP OUTLET PIPE. THE OIL PUMP OUTLET PIPE CARRIES THE OIL FROM THE OIL PUMP LOCATED ON THE RIGHT SIDE OF THE ENGINE TO THE DRILLED OIL PASSAGES AT THE LEFT SIDE OF THE ENGINE.

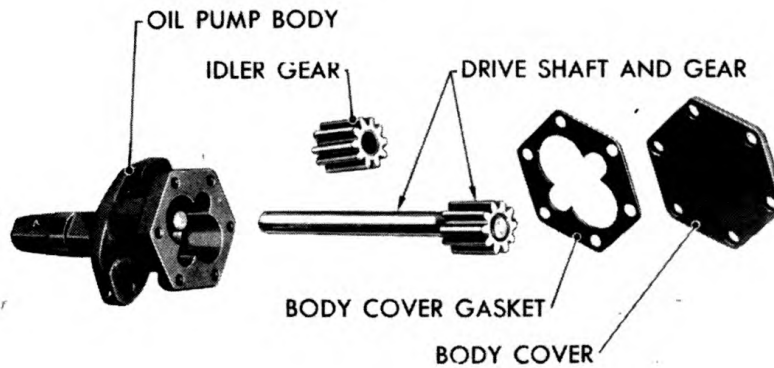

RA PD 53228

**Figure 9—Engine Oiling (Oil Strainer and Pump)**



**ORDNANCE MAINTENANCE—POWER PLANT, CLUTCH, AND ELECTRICAL SYSTEM— $\frac{3}{4}$  AND 1 $\frac{1}{2}$  TON VEHICLES (DODGE)**

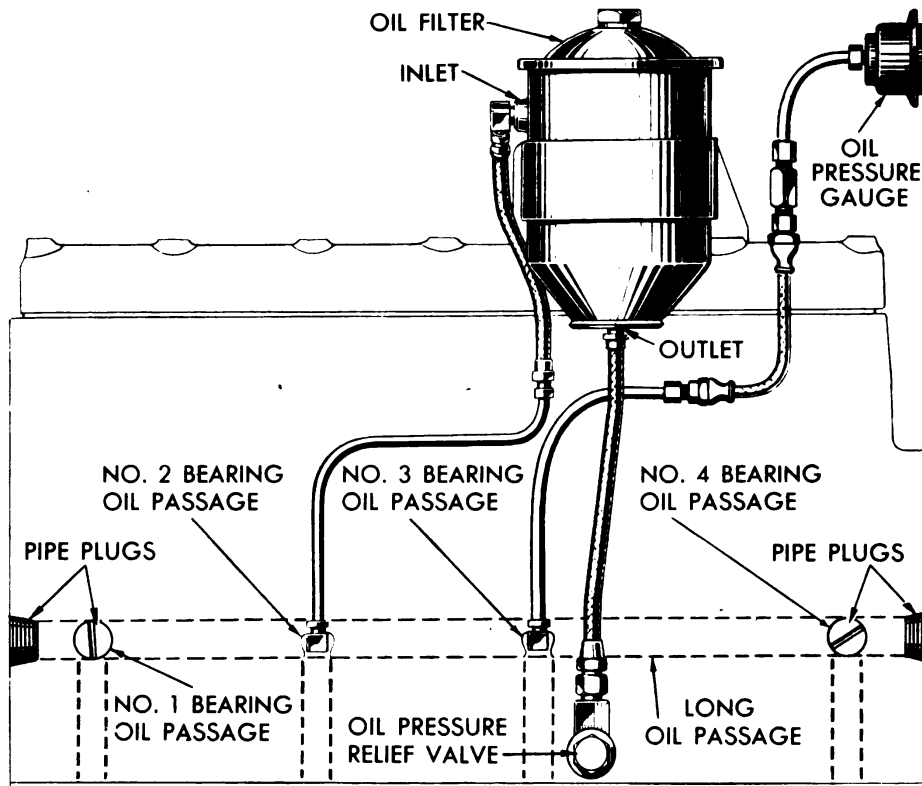

OIL PASSAGES ARE DRILLED IN THE CYLINDER BLOCK AND ARE THE PASSAGES THROUGH WHICH THE OIL TRAVELS TO ALL CAMSHAFT AND CRANKSHAFT BEARINGS. THE OUTER ENDS OF THE No. 1 AND No. 4 BEARING OIL PASSAGES ARE CLOSED WITH PIPE PLUGS ALONG THE LEFT SIDE OF THE ENGINE. THE OIL FILTER INLET TUBE IS ATTACHED AT No. 2 AND THE OIL PRESSURE GAGE TUBE AT No. 3. THE LONG OIL PASSAGE DRILLED THE FULL LENGTH OF THE CYLINDER BLOCK IS CLOSED AT EACH END WITH A COUNTER-SUNK HEAD PIPE PLUG.

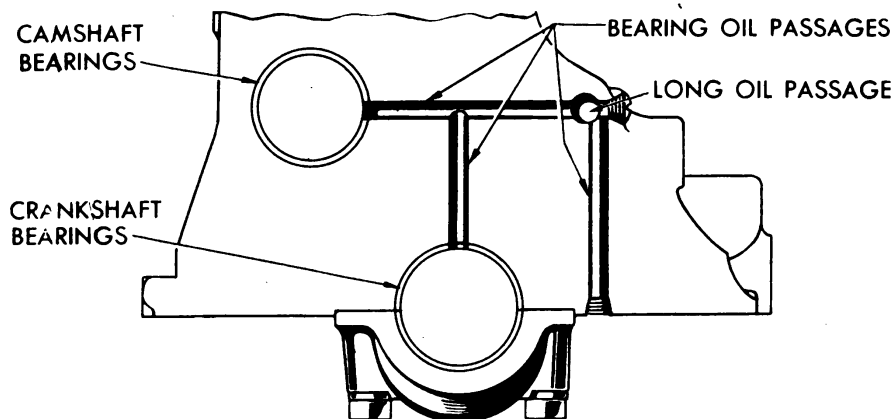

RA PD 53229

**Figure 10—Engine Oiling (Crankshaft and Camshaft Bearings)**

### GENERAL DESCRIPTION AND CONSTRUCTION

OIL PASSAGES DRILLED IN THE CRANKSHAFT

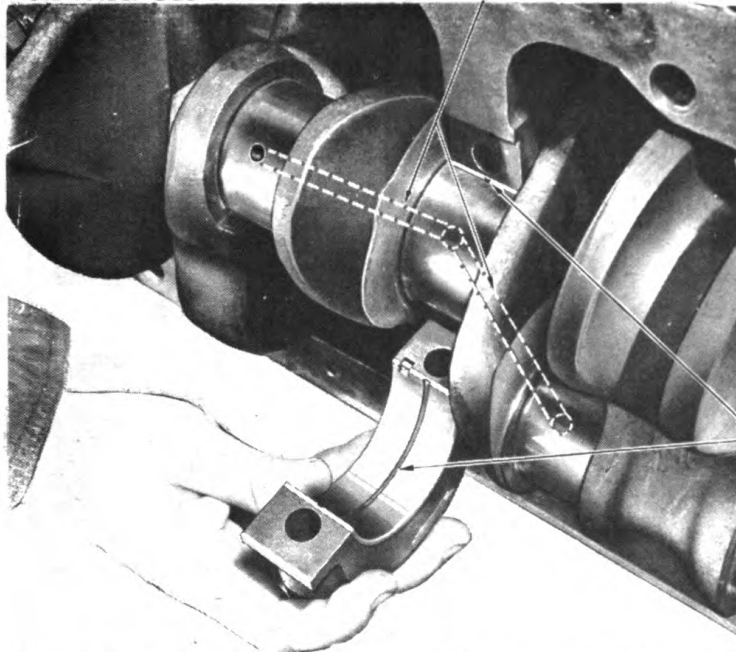

OIL GROOVE  
MACHINED  
IN CRANKSHAFT  
BEARINGS

OIL PASSAGES ARE DRILLED IN THE CRANKSHAFT FROM THE MAIN BEARINGS TO THE CONNECTING ROD BEARINGS. THESE OIL PASSAGE OPENINGS REVOLVE WITH THE CRANKSHAFT BUT ARE SUPPLIED WITH AN UNINTERRUPTED FLOW OF OIL FROM THE CIRCULAR OIL GROOVE MACHINED IN THE CRANKSHAFT BEARINGS.

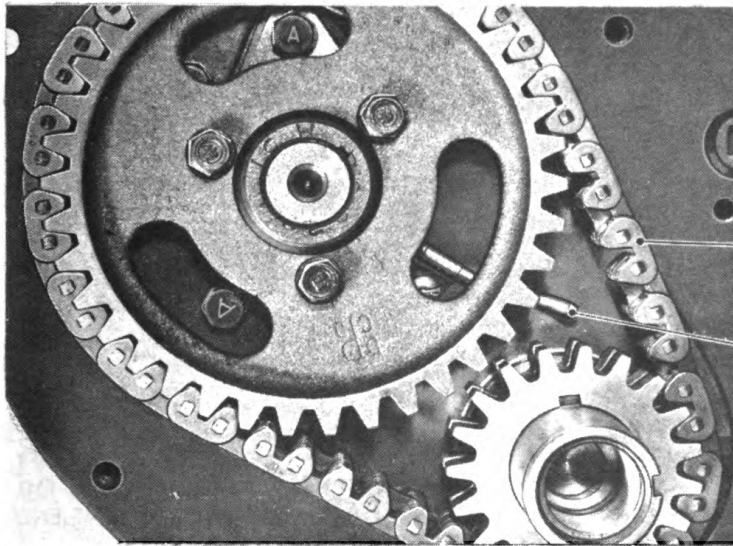

TIMING CHAIN

OIL TUBE

THE TIMING CHAIN IS OILED THROUGH A PASSAGE DRILLED FROM THE FRONT FACE OF THE CYLINDER BLOCK TO THE CAMSHAFT FRONT BEARING INTO WHICH A SHORT TUBE IS INSERTED THAT DIRECTS THE OIL TO THE TIMING CHAIN

RA PD 53230

**Figure 11—Engine Oiling (Connecting Rod Bearings and Timing Chain)**

**ORDNANCE MAINTENANCE—POWER PLANT, CLUTCH, AND ELECTRICAL SYSTEM— $\frac{3}{4}$  AND 1 $\frac{1}{2}$  TON VEHICLES (DODGE)**

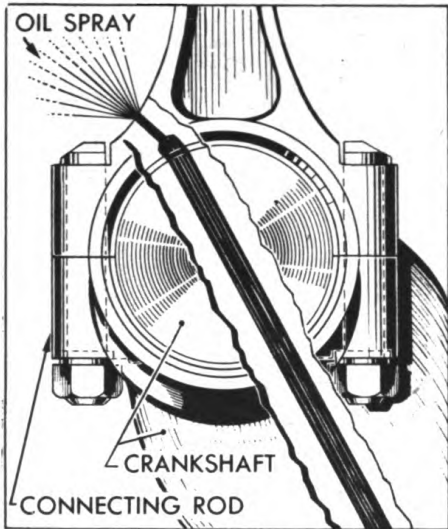

AS THE CRANKSHAFT REVOLVES AND THE OIL HOLE DRILLED IN EACH CONNECTING ROD PASSES THE OIL PASSAGE IN THE CRANKSHAFT, A SPRAY OF OIL IS RELEASED TO THE CYLINDER BORE WALLS, PISTON PINS AND VALVE TAPPETS.

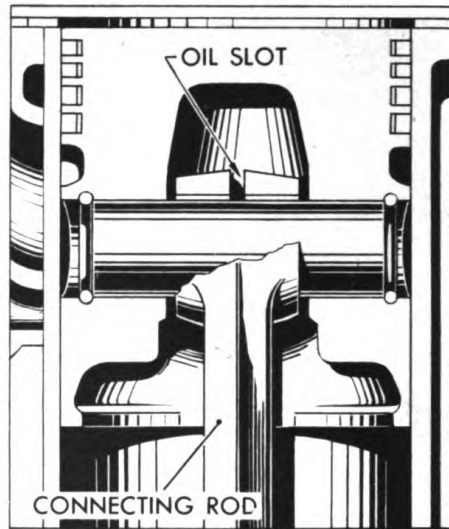

AN OIL SLOT IS MACHINED IN THE TOP OF EACH CONNECTING ROD THROUGH WHICH OIL SPRAYED FROM THE OIL HOLE IN THE CONNECTING ROD LOWER BEARINGS CAN REACH THE CONNECTING ROD PISTON PIN BUSHING.

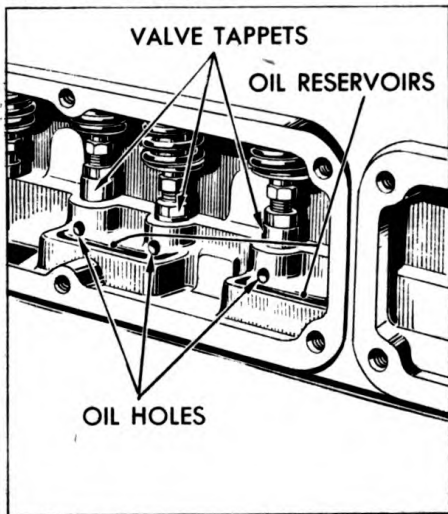

OIL HOLES ARE DRILLED IN THE CYLINDER BLOCK AT EACH VALVE TAPPET TO ALLOW THE OIL SPRAYED FROM THE OIL HOLE IN THE CONNECTING ROD LOWER BEARINGS AND COLLECTED IN OIL RESERVOIRS TO REACH THE VALVE TAPPETS.

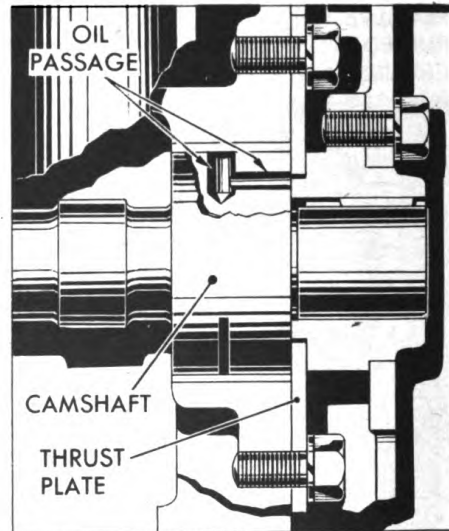

OIL IS SUPPLIED TO THE CAMSHAFT THRUST PLATE THROUGH AN OIL PASSAGE DRILLED IN THE FRONT END OF THE CAMSHAFT THAT OBTAINS ITS SUPPLY OF OIL AS IT REVOLVES PAST THE CYLINDER BLOCK OIL PASSAGE OPENING

RA PD 53231

**Figure 12—Engine Oiling (Pistons, Piston Pins, Valve Tappets and Camshaft)**

**GENERAL DESCRIPTION AND CONSTRUCTION**

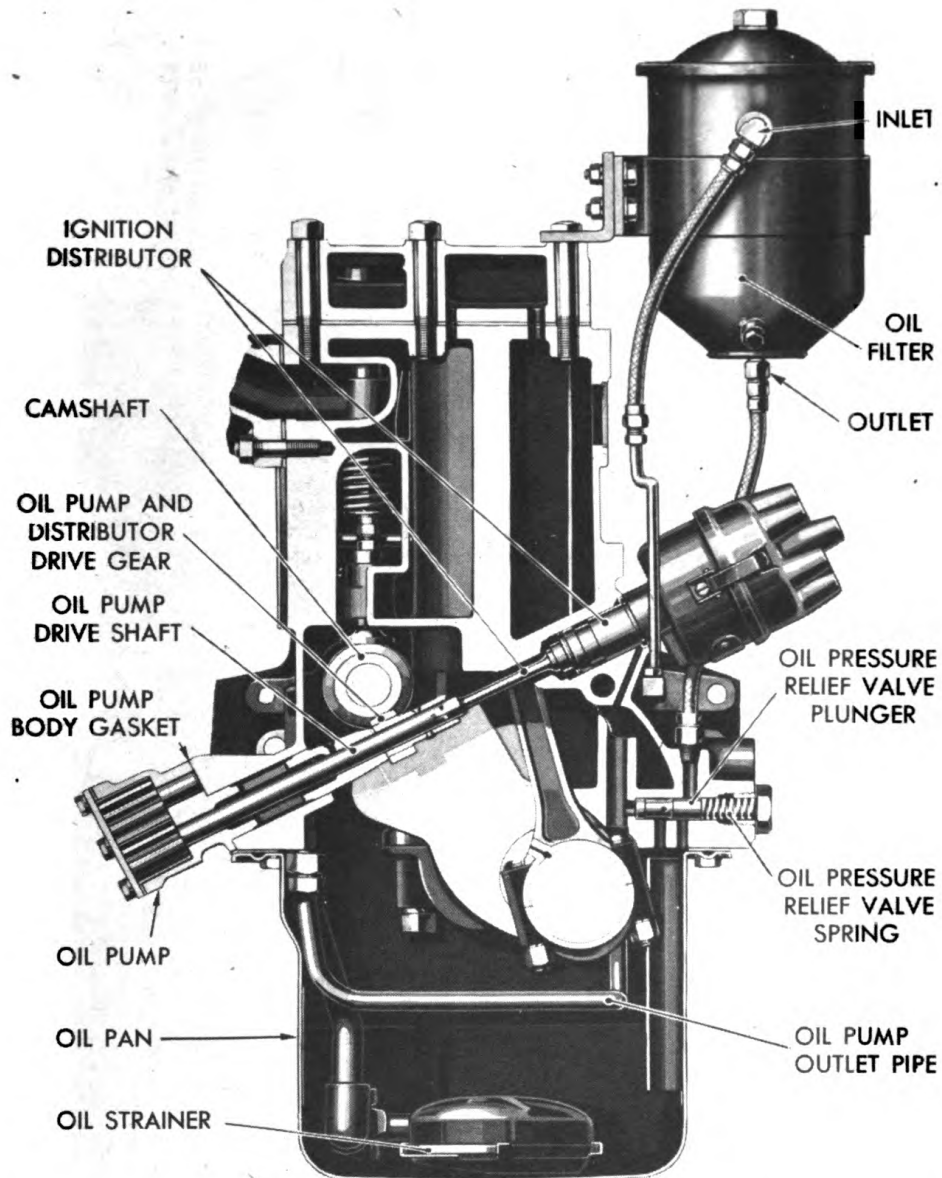

OIL PRESSURE IS CONTROLLED AUTOMATICALLY BY A PLUNGER WHICH OPERATES AGAINST SPRING PRESSURE. WHEN THE OIL PRESSURE IN THE SYSTEM OVERCOMES THE SPRING PRESSURE THE OIL PRESSURE RELIEF VALVE PLUNGER IS UNSEATED AND EXCESS OIL RETURNS TO THE OIL PAN. THE OIL GOES THROUGH THE FILTER AFTER THE BEARINGS HAVE BEEN SUPPLIED AND THE OIL PRESSURE RELIEF VALVE PLUNGER IS UNSEATED. THE OIL FILTER TUBES ARE NOT DIRECT OIL PASSAGES AND IF THE OIL FILTER BECOMES CLOGGED, OIL WILL STILL CIRCULATE TO THE BEARINGS.

**RA PD 53232**

**Figure 13—Engine Oiling (Oil Pressure Relief Valve and Filter)**

ORDNANCE MAINTENANCE—POWER PLANT, CLUTCH, AND ELECTRICAL SYSTEM— $\frac{3}{4}$  AND  $1\frac{1}{2}$  TON VEHICLES (DODGE)

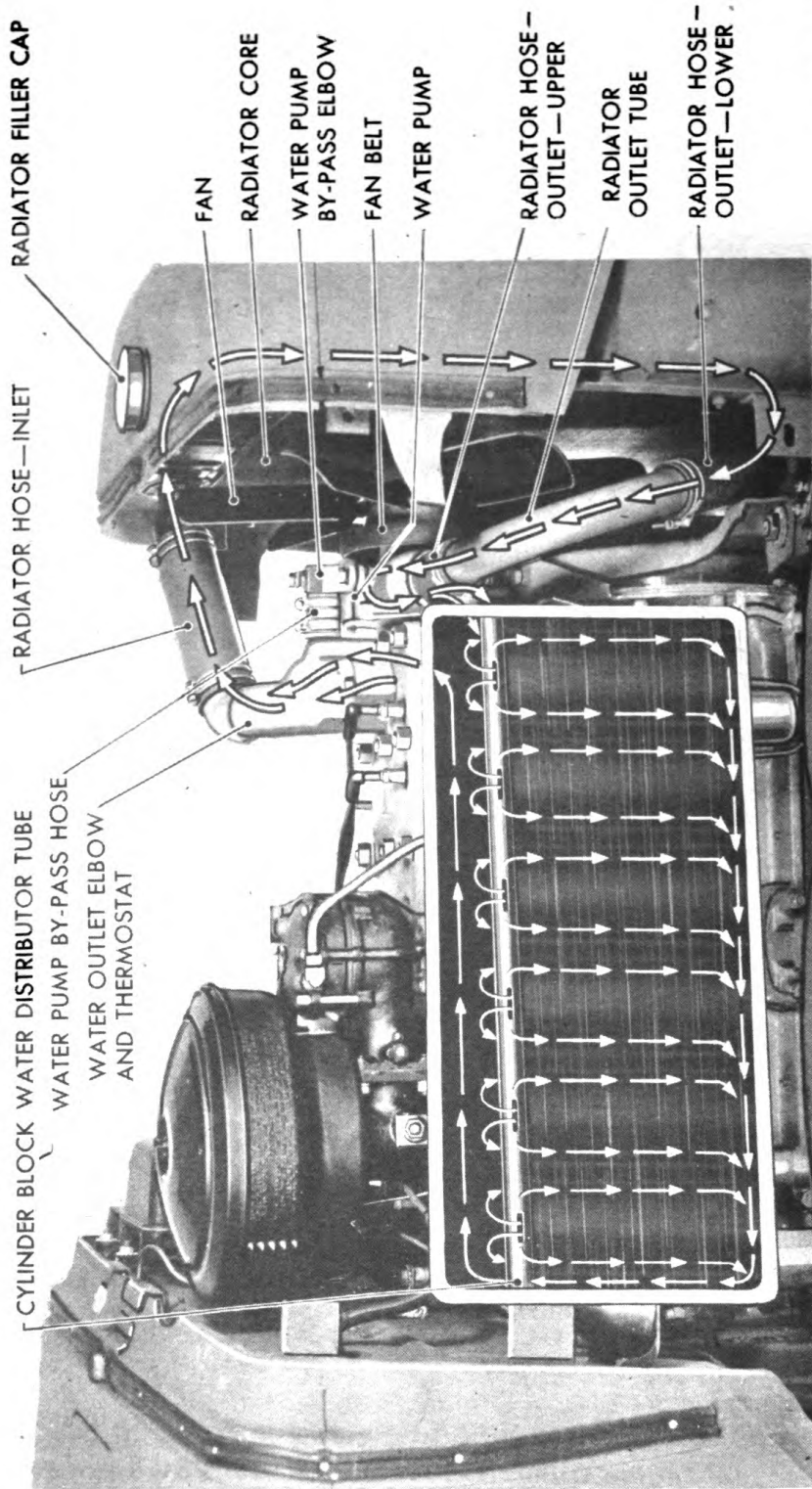

RA PD 53234

Figure 14—Cooling System (Thermostat Open)

**GENERAL DESCRIPTION AND CONSTRUCTION**

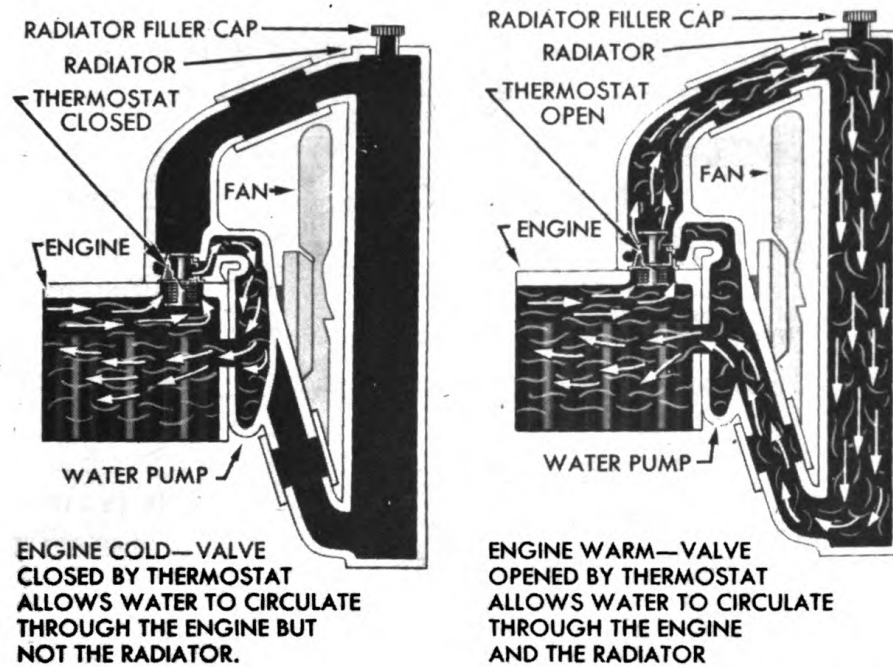

RA PD 53235

**Figure 15—Operation of Cooling System Thermostat**

**12. COOLING SYSTEM (fig. 14).**

a. The cooling solution is circulated by a centrifugal pump, through water jackets around the cylinder bores and valve ports where it picks up heat generated by combustion. From the cylinder block, the solution circulates to and through the fin and tube type radiator where heat is dissipated into air drawn through the radiator by a fan. The circulation of the cooling solution and engine temperature are automatically controlled by a thermostat and bypass located in the cylinder head (fig. 15). The water pump and fan are mounted on the front of the engine and are belt driven (fig. 16). The water pump consists of a shaft and impeller mounted in two bushings in the housing. The fan is bolted to a hub mounted on the forward end of the shaft.

b. In the 1½ ton, 6 x 6 vehicle, the cooling system is closed to prevent loss of cooling liquids. Should excessive pressure develop in the system, it releases through the overflow tank. Any condensation which forms in the overflow tank during operation is syphoned back into the radiator when the temperature of the cooling system is reduced.

**13. CLUTCH (fig. 17):**

a. The single dry-plate type clutch is located in the clutch housing at the rear of the engine. It can be removed through the bottom of the housing when the housing pan and transmission have been removed.

**ORDNANCE MAINTENANCE—POWER PLANT, CLUTCH, AND ELECTRICAL SYSTEM— $\frac{3}{4}$  AND  $1\frac{1}{2}$  TON VEHICLES (DODGE)**

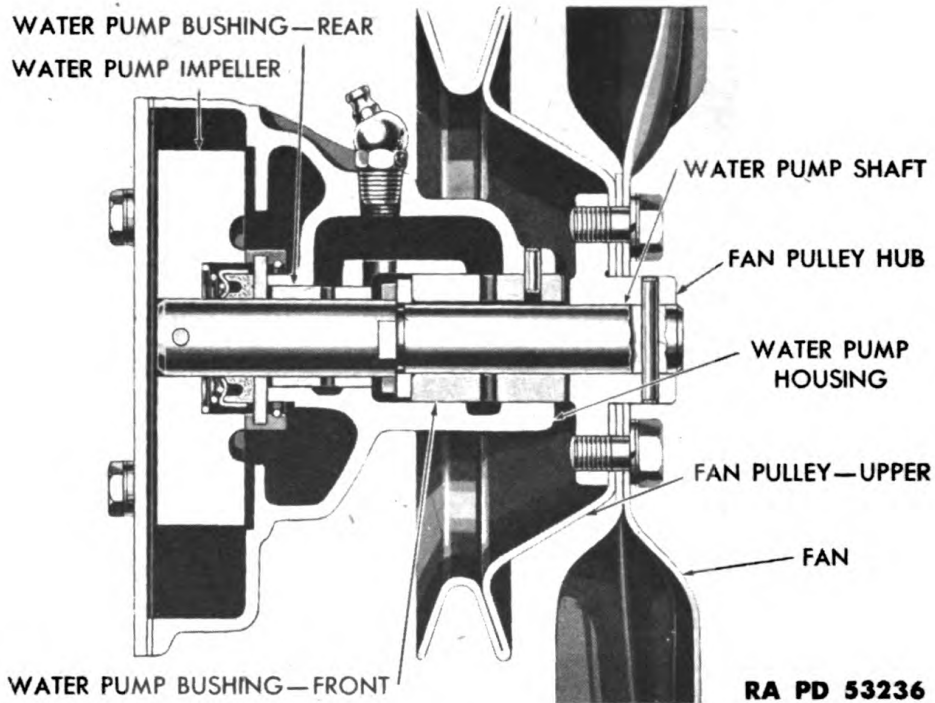

**Figure 16—Water Pump**

**14. DATA AND SPECIFICATIONS.**

**a. Engine—general.**

Make .....	Dodge
Type .....	L-head
Number of cylinders.....	Six
Cylinder bore .....	3 $\frac{1}{4}$ in.
Stroke.....	4 $\frac{5}{8}$ in.
Piston displacement.....	230.2 cu in.
Compression ratio.....	6.7 to 1
Governed speed.....	3200 rpm (road load)
Compression pressure at cranking speed.....	108 to 118 lb.
Maximum torque.....	180 ft-lb at 1200 rpm
Brake horsepower (gross).....	92 at 3200 rpm 54.5 at 1600 rpm
Firing order.....	1-5-3-6-2-4

**b. Cylinder Block.**

Type .....	L-head
Material.....	Gray iron

**c. Camshaft.**

Drive .....	Chain
Material.....	Cast iron

GENERAL DESCRIPTION AND CONSTRUCTION

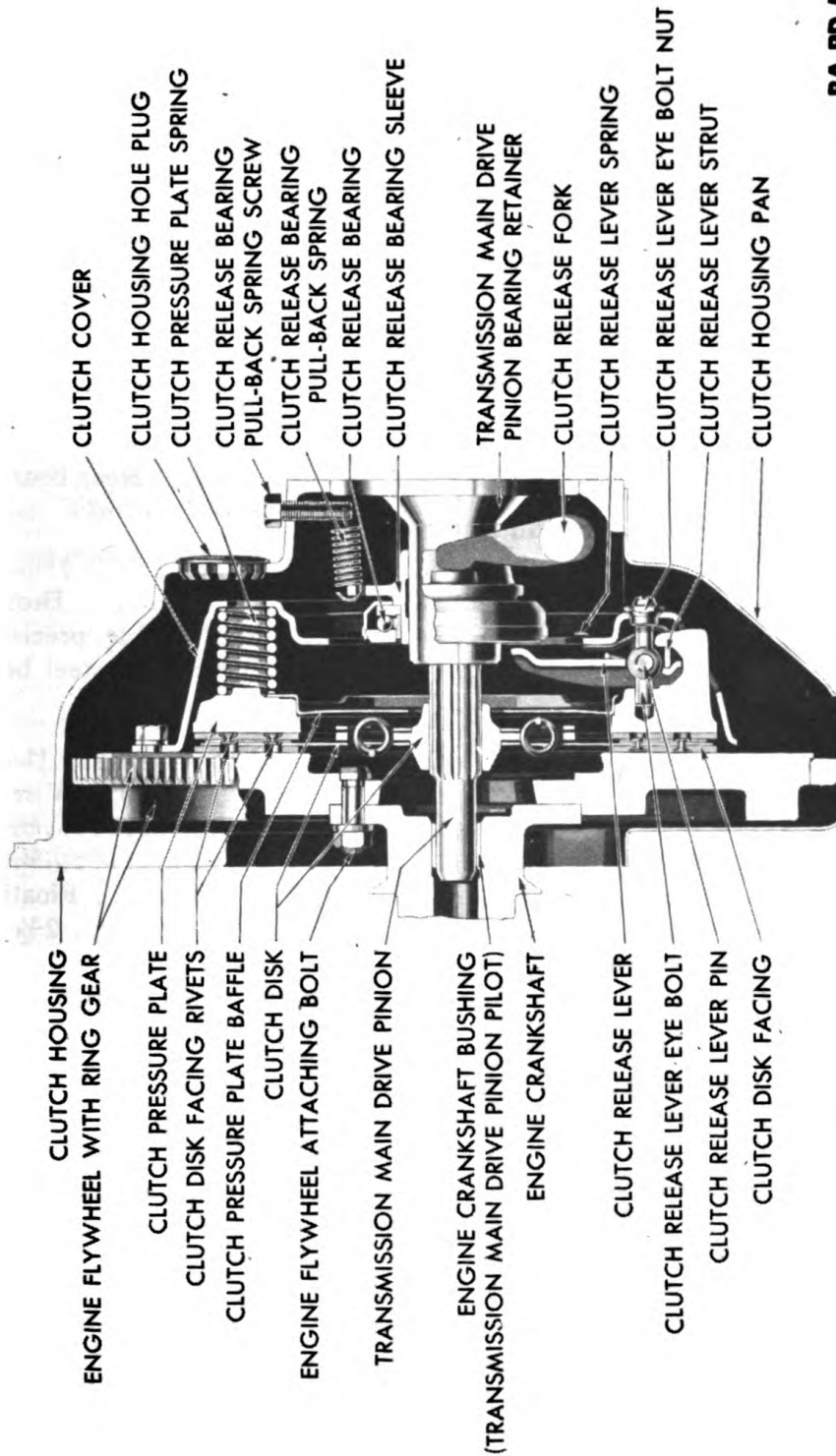

RA PD 53237

Figure 17—Clutch



**ORDNANCE MAINTENANCE—POWER PLANT, CLUTCH, AND ELECTRICAL SYSTEM— $\frac{3}{4}$  AND  $1\frac{1}{2}$  TON VEHICLES (DODGE)**

Number of bearings.....Four  
 Type of bearings.....Steel backed babbitt except rear  
 which is machined in block.  
 Thrust taken by.....Thrust plate

**d. Timing Chain.**

Make.....Morse  
 Type.....Non-adjustable  
 Number of links.....48  
 Width.....1 in.  
 Pitch.....0.5 in.

**e. Crankshaft and Main Bearings.**

Number of main bearings.....Four  
 Type.....Replaceable precision  
 Material.....Babbitt on steel back  
 Thrust taken by.....Rear bearing

**f. Connecting Rods and Bearings.**

Center to center length..... $7\frac{13}{16}$  in.  
 Piston pin bushing—material.....Bronze  
 Bearings—type.....Replaceable precision  
 material.....Babbitt on steel back

**g. Pistons, Pins and Rings.**

Pistons—type.....U-slot  
 length..... $3\frac{11}{16}$  in.  
 compression ring groove width..... $\frac{3}{32}$  in.  
 oil ring groove width..... $\frac{5}{32}$  in.  
 Piston pins—type.....Floating  
 length..... $2\frac{3}{4}$  in.  
 Number rings per piston.....Four  
 type.....2 compression—2 oil control

**h. Valves, Tappets and Guides.**

Type of head—intake.....Flat  
 exhaust.....Crown  
 Location.....Right side of engine  
 Head diameter—intake..... $1\frac{17}{32}$  in.  
 exhaust..... $1\frac{13}{32}$  in.  
 Port diameter—intake..... $1\frac{13}{32}$  in.  
 exhaust..... $1\frac{9}{32}$  in.  
 Length..... $4\frac{27}{32}$  in.  
 Seat angle.....45 degrees  
 Valve lift.....0.379 in.  
 Exhaust valve seat.....Hard alloy insert  
 Valve stem guide—length..... $2\frac{13}{16}$  in.

**GENERAL DESCRIPTION AND CONSTRUCTION**

Valve tappets—type . . . . .Mushroom with self-locking  
adjusting screw.  
head diameter . . . . .1.280 in.

**i. Valve Timing.**

Intake opens . . . . .12 degrees or 0.060-in. B.T.D.C.  
Intake closes . . . . .44 degrees A.B.D.C.  
Exhaust opens . . . . .50 degrees B.B.D.C.  
Exhaust closes . . . . .6 degrees or 0.015-in. A.T.D.C.

**j. Oiling System.**

Oil pump—type . . . . .Gear  
drive . . . . .Camshaft  
pump intake . . . . .Floating screen  
pressure setting of relief valve . . . . .40 to 45 lb per sq in.  
Oil gage—make and model . . . . .Auto-Lite 10017A  
Oil capacity . . . . .5 qt refill; 6 qt new

**k. Cooling System.**

Water pump—type . . . . .Centrifugal  
location . . . . .Front of cylinder block  
drive . . . . .Belt  
capacity . . . . .26.1 gal per min at 2000 rpm  
(pump speed)  
Fan—diameter . . . . .18 in.  
number of blades . . . . .Six  
belt type . . . . .V-endless  
belt adjustment . . . . .By moving generator  
Radiator core—make . . . . .Fedders or Jamestown  
type . . . . .Fin and tube  
thickness . . . . .3 in.  
frontal area . . . . .395 sq in.  
Cooling system capacity . . . . .17 qt

**l. Fuel System.**

Carburetor—make and model . . . . .Zenith, series 29 and Carter ETW1  
(See supplement in back of manual)  
size . . . . .1½ in.  
adjustment . . . . .Idling adjustment only  
Carburetor air cleaner—make and model . . . . .AC-1542841  
type . . . . .Oil bath  
oil capacity . . . . .1 qt  
Governor—make and model . . . . .Zenith—No. B351-6-1  
type . . . . .Built-in, velocity  
Fuel pump—make and model . . . . .AC—model 1537715  
type . . . . .Diaphragm with hand primer  
location . . . . .Right side of engine

**ORDNANCE MAINTENANCE—POWER PLANT, CLUTCH, AND ELECTRICAL SYSTEM— $\frac{3}{4}$  AND  $1\frac{1}{2}$  TON VEHICLES (DODGE)**

Fuel filter—make and model . . . . . Zenith—F363 X 2-2  
 type . . . . . Metal disk  
 location . . . . . On front of dash  
 Fuel tank capacity . . . . . 30 gal

**m. Clutch.**

Make . . . . . Borg and Beck  
 Type . . . . . Single dry-disk  
 Size . . . . . 10 in.  
 Facing material . . . . . Moulded woven asbestos  
 (2 used)  
 Release bearing—type . . . . . Ball—prelubricated  
 make and model . . . . . Aetna A-893-1  
 Crankshaft pilot bushing—material . . . . . Oilite bushing  
 Number of pressure springs . . . . . Nine  
 Pressure plate assembly number . . . . . 919 (Borg and Beck)  
 Disk number . . . . . 11261 (Borg and Beck)  
 Disk facing—number . . . . . 4084 (Borg and Beck)  
 inside diameter . . . . . 6 in.  
 outside diameter . . . . . 10 in.

**CHAPTER 2**  
**ENGINE AND CLUTCH (Cont'd)**

**Section II**

**ENGINE TROUBLE SHOOTING**

	<b>Paragraph</b>
General information .....	15
Engine fails to start.....	16
Improper engine performance.....	17
Engine noises .....	18
Improper oil pressure.....	19
Excessive oil consumption.....	20
Excessive fuel consumption.....	21
Improper engine operating temperature.....	22
Loss of cooling solution.....	23
Improper clutch operation.....	24

**15. GENERAL INFORMATION.**

**a. Engine Operation Depends on these Factors.**

- (1) Cranking engine to start.
- (2) A proper mixture of gasoline and air entering the cylinders.
- (3) Proper timing and seating of valves to allow the fuel mixture to enter the cylinders on the intake stroke of the piston and hold it there to be compressed by the compression stroke of the piston.
- (4) Adequate spark at the proper time to ignite the compressed fuel mixture.

**b.** Additional trouble shooting information on the electrical units of the engine is contained in paragraphs 86 and 87.

**16. ENGINE FAILS TO START.**

**a. Starter Does Not Crank Engine.**

<b>Possible Cause</b>	<b>Possible Remedy</b>
Battery discharged.	Test battery.
Battery posts and terminals corroded.	Remove terminals and clean.
Ground cable poorly grounded.	Clean and tighten ground connection.
Starter switch not making contact.	Replace switch.
Starter inoperative.	Rebuild starter (pars. 88 thru 90).

**ORDNANCE MAINTENANCE—POWER PLANT, CLUTCH, AND ELECTRICAL SYSTEM— $\frac{3}{4}$  AND  $1\frac{1}{2}$  TON VEHICLES (DODGE)**

Possible Cause	Possible Remedy
Excessive friction in engine due to use of improper oil.	Change oil, using proper viscosity.
Excessive friction in engine causing seizure of internal parts (engine will not turn with hand starting crank).	Disassemble engine, inspect for internal damage and replace faulty parts (pars. 28 and 29).

**b. Engine Cranks but Fails to Start.**

**(1) COMBUSTION CHAMBERS FLOODED WITH FUEL.**

Excessive use of choke when cranking engine.	Push choke button all the way in and crank engine with throttle open.
Choke not opening fully when button is pushed in.	Inspect choke for opening fully when choke button is pushed in.
Fuel tank pressure cap not functioning.	Replace cap.
Carburetor float valve not seating, causing carburetor to flood.	Repair carburetor (pars. 54 thru 56).

**(2) IGNITION INADEQUATE.** Test by removing wire from spark plug and holding end of wire about  $\frac{1}{4}$  inch from cylinder head while engine is being cranked with ignition switch on. If spark jumps  $\frac{1}{4}$  to  $\frac{3}{8}$  inch to cylinder head, ignition is adequate to start engine. Refer to paragraph 87 for instructions on use of ignition circuit tester.

Ignition switch off.	Turn on switch.
Accumulation of moisture on distributor, cables, coil or spark plug.	Wipe thoroughly with dry cloth.
Ignition switch not making contact.	Test with jumper wire across switch; if faulty replace switch.
Distributor breaker points dirty or burned.	Test breaker points (par. 87 c (4)); clean and adjust points or replace if excessively burned.
Spark plugs fouled or damaged.	Clean and adjust spark plugs (par. 25 i).
Condenser lead wire to distributor loose or broken.	Tighten lead or replace condenser.
Primary wire from coil to distributor loose or broken.	Test with jumper wire and replace if broken.
Condenser shorted.	Test condenser (par. 87 c (3)); if faulty, replace.
Ignition coil faulty.	Replace coil.

**ENGINE TROUBLE SHOOTING**

Possible Cause	Possible Remedy
Ignition cable from coil to distributor cap disconnected.	Connect cable.
Distributor cap or rotor cracked.	Replace damaged parts.
Distributor rotor does not turn when engine is cranked (distributor shaft broken).	Rebuild distributor (pars. 99 thru 101).
Distributor filter shorted (if so equipped).	Test with jumper wire; if faulty, replace filter.
Radio interference filter on dash faulty.	Test with jumper wire; if faulty, replace filter.

(3) **FUEL IN FUEL TANK DOES NOT REACH CARBURETOR.** Test for fuel delivery by disconnecting fuel tube at carburetor, operate hand priming lever on fuel pump which should cause fuel to flow from the open tube. (If fuel pump primer moves freely without actuating diaphragm, turn engine one revolution by hand to move fuel pump rocker arm off high spot of cam on camshaft.) If fuel is not being delivered to the carburetor, disconnect the flexible fuel line at the pump and hold finger tightly over the inlet opening of the pump. If suction is felt at that point when the engine is cranked or when the hand priming lever is operated, the fuel pump is operative. Refer to paragraph 76 a (5) for fuel pump pressure test.

Fuel filter clogged.	Remove and clean filter element.
Fuel pump bowl strainer clogged.	Remove bowl and clean screen.
Air leak in fuel tube between tank and fuel pump.	Tighten connections or repair.
Fuel tubes clogged.	Disconnect and blow out tubes.

(4) **FUEL DOES NOT REACH CYLINDERS.**

Choke valve not closing.	Inspect choke for closing when button is pulled out.
Fuel passages in carburetor clogged.	Rebuild carburetor (pars. 54 thru 56).
Carburetor float valve stuck.	Rebuild carburetor (pars. 54 thru 56).

**17. IMPROPER ENGINE PERFORMANCE.**

**a. Engine Does Not Idle Properly.**

Carburetor throttle stop screw allows throttle to close completely.	Adjust stop screw for desired idling speed (par. 25 j).
Carburetor idling adjustment incorrect.	Adjust carburetor (par. 25 j).

**ORDNANCE MAINTENANCE—POWER PLANT, CLUTCH, AND ELECTRICAL SYSTEM—¾ AND 1½ TON VEHICLES (DODGE)**

Possible Cause	Possible Remedy
Air leak at intake manifold or carburetor flange.	Tighten flange nuts or replace gaskets.
Air leak in windshield wiper tube.	Locate and eliminate leak.
Spark plugs defective or gaps improperly adjusted.	Remove plugs, adjust gaps or replace plugs (par. 25 i).
Ignition timing too early.	Adjust timing (par. 25 g and h).
Crankcase ventilator metering valve stuck or dirty (if so equipped).	Service metering valve (par. 25 b).
Compression low on one or more cylinders.	Test compression (par. 25 e); inspect internal parts of engine and replace faulty parts (pars. 27 and 29).
Carburetor idling speed orifice clogged.	Rebuild carburetor (pars. 54 thru 56).

**b. Engine Miss at High Speed.**

Distributor breaker points improperly adjusted or burned.	Test breaker points (par. 87 c (4)); clean and adjust or replace points.
Insufficient tension on breaker arm spring.	Set tension on breaker arm spring (par. 101 h).
Excessive play in distributor shaft bushings.	Rebuild distributor (pars. 99 thru 101).
Spark plugs defective or gaps too wide.	Adjust gaps or replace plugs (par. 25 i).
Ignition coil weak.	Test coil (par. 87 c (2)); if faulty, replace.
Valves sticking, weak or broken valve springs.	Test vacuum (par. 25 j); test compression (par. 25 e); grind valves (par. 27).

**c. Engine Miss on Acceleration.**

Distributor cap dirty or cracked.	Clean or replace cap.
Spark plug gaps too wide or plugs defective.	Clean and adjust or replace plugs (par. 25 i).
Insufficient fuel delivered to carburetor.	Clean fuel filter; test fuel pump pressure (par. 76 a (5)).
Ignition coil weak.	Test coil (par. 87 c (2)).
Manifold heat control valve setting incorrect.	Check heat control valve setting (par. 25 k).

**ENGINE TROUBLE SHOOTING**

**d. Loss of Power** (engine fires on all cylinders but does not develop normal power).

Possible Cause	Possible Remedy
Air cleaner restricted.	Service air cleaner (par. 25 h).
Ignition timing late.	Adjust ignition timing (par. 25 g and h).
Improper fuel mixture.	Clean fuel filter; test fuel pump pressure (par. 76 a (5)); rebuild carburetor (pars. 54 thru 56).
Manifold heat control valve improperly set.	Check heat control valve setting (par. 25 k).
Exhaust pipe, muffler or tail pipe damaged or clogged.	Repair or replace faulty parts.
Low compression, broken valve springs or valves sticking.	Test compression (par. 25 e); grind valves (par. 27); replace pistons and rings (par. 29).

**e. Variation in Top Governed Speed** (engine surges).

Governor improperly adjusted.      Adjust governor (par. 76 a (9)).

**18. ENGINE NOISES.**

**a. Ping or Spark Knock** (ping or spark knock is a sharp metallic knock occurring on acceleration or when operating under heavy load).

Ignition timing too early.	Adjust timing (par. 25 g and h).
Excessive carbon deposit in combustion chambers.	Remove cylinder head, clean carbon and inspect valves (par. 27).
Engine overheated.	Inspect cooling system (par. 22 a).
Improper operation of distributor advance mechanism.	Rebuild distributor (pars. 99 thru 101).

**b. Valve Noise.**

Tappets improperly adjusted.	Adjust tappets (par. 25 d).
Valve spring cocked, broken or improperly seated.	Replace faulty springs (par. 27).
Excessive valve stem or tappet side clearance, worn tappets or misalignment in valve assembly.	Inspect valve stems and tappets and replace faulty parts (par. 27).

**c. Piston Slap.** (Heard as a clear, metallic knock, occurring when the engine is under load at low speed but not usually heard at higher speed or when the engine is idling. Piston slap is always more noticeable when the engine is cold and usually disappears when normal oper-



**ORDNANCE MAINTENANCE—POWER PLANT, CLUTCH, AND ELECTRICAL SYSTEM—¾ AND 1½ TON VEHICLES (DODGE)**

ating temperature is reached, unless the piston has been scored). If piston slap is excessive with engine at normal operating temperature, inspect the piston and cylinder wall. Recondition the cylinder wall (par. 41 e) if damaged, and install properly fitted piston (par. 29).

**d. Piston Pin Noise.** (Heard as a metallic knock usually occurring when the engine is hot and running at idling speed. The noise will come and go as the piston pin turns or shifts in the piston). Replace piston pin and/or piston pin bushing (par. 29).

**e. Bearing Noise.**

(1) **LOOSE BEARING.** (Usually heard momentarily when accelerating at about two-thirds maximum engine speed in a series of rapid distinct knocks. It is difficult to distinguish by sound between main and connecting rod bearing noise). Inspect bearings and crankshaft (par. 28).

(2) **BURNED OUT CONNECTING ROD BEARING.** (Heard as a sharp, distinct knock at most engine speeds; especially noticeable on quick acceleration. The bearing responsible for the knock can usually be determined by shorting out the ignition at the spark plugs.) Inspect bearings and crankshaft (par. 28).

(3) **BURNED OUT MAIN BEARING.** (Heard as a knock at moderate speeds; especially under acceleration. If the front or an intermediate main bearing is responsible, the noise usually can be shorted out; if in the rear main bearing, the knock will have a duller sound due to the additional area of that bearing.) Inspect bearings and crankshaft (par. 31).

**f. Unusual Noises.**

Possible Cause	Possible Remedy
Partially broken fan belt.	Replace belt.
Spark plug loose in the cylinder head.	Tighten spark plug.
Manifold heat control valve loose.	Repair or replace valve (par. 47 a).
Loose or glazed fan belt.	Adjust or replace belt.
Air leak at intake manifold or carburetor flange.	Tighten flange bolt nuts or replace gaskets.
Hard spot in generator brush.	Repair generator (pars. 91 thru 96).
Clutch housing pan damaged and rubbing flywheel.	Replace pan (par. 33).
Fan pulley (lower) loose or broken.	Tighten or replace pulley (par. 30).

**ENGINE TROUBLE SHOOTING**

Possible Cause	Possible Remedy
Flywheel loose on the crankshaft. (Heard under acceleration; may sound the same as exhaust pipe or muffler vibration.)	Tighten flywheel attaching bolts (par. 33).
Piston striking carbon or foreign object in the cylinder head.	Remove cylinder head and inspect (par. 27 in part).
Scored cylinders. (Will cause noise similar to piston slap after engine has reached operating temperature and vehicle is accelerated under load. The noise can be heard through the oil breather pipe after removing breather pipe oil filler cap.)	Disassemble engine (par. 39); inspect cylinders; recondition cylinders (par. 41 e).

**19. IMPROPER OIL PRESSURE.**

**a. Inadequate Oil Pressure.** (Normal oil pressure is 30 to 40 pounds when oil is hot at speeds above 30 miles per hour.)

Engine oil level below oil pump strainer.	Replenish oil in crankcase.
Leak in oil gage or filter tube.	Tighten connections or replace tube.
Oil pressure relief valve plunger not seating.	Service relief valve.
Oil pump suction or outlet pipe leaking.	Remove oil pan (par. 28) and tighten or replace pipe.
Oil pump drive shaft broken.	Rebuild oil pump (pars. 66 thru 68).
Oil pump gears or body worn.	Rebuild oil pump (pars. 66 thru 68).
Excessive clearance in engine bearings.	Replace bearings (pars. 28 and 31).

**b. Excessive Oil Pressure.**

Oil pressure relief valve plunger sticking.	Service relief valve.
---	-----------------------

**20. EXCESSIVE OIL CONSUMPTION.**

Engine filled above the recommended oil level.	Lower to running level.
Oil leaks at oil pan gaskets, chain case cover oil seal, rear main bearing or oil tubes.	Replace faulty gaskets or oil seals.

**TM 9-1808A**  
**20-22**

**ORDNANCE MAINTENANCE—POWER PLANT, CLUTCH, AND ELECTRICAL SYSTEM— $\frac{3}{4}$  AND  $1\frac{1}{2}$  TON VEHICLES (DODGE)**

Possible Cause	Possible Remedy
Oil pressure relief valve sticking.	If oil pressure is higher than normal when oil is hot, service relief valve.
Worn, stuck or broken piston rings.	Replace rings (par. 29).
Oil ring slots or piston oil return holes clogged with carbon or sludge.	Clean pistons and replace rings (par. 29).
Scored or excessively worn cylinder bores.	Recondition cylinder bores (par. 41 e).
Excessive clearance between intake valve stems and guides.	Replace valves and/or guides (par. 27).
Excessive clearance in crankshaft, connecting rod or camshaft bearings.	Rebuild engine (pars. 38 thru 53).

**21. EXCESSIVE FUEL CONSUMPTION.**

Engine requires servicing.	Make engine tests and adjustments (par. 25).
Choke not opening fully when button is pushed in.	Inspect choke for opening fully when choke button is pushed in.
Engine idles too fast.	Adjust carburetor throttle stop screw.
Brakes dragging.	Adjust brakes.
Lubricant in transmission, front or rear axle too heavy.	Change lubricant to proper grade.
Engine temperature too low.	Inspect cooling system (par. 22 b).
Carburetor float level too high.	Repair carburetor (pars. 54 thru 56).
Fuel pump pressure too high.	Test fuel pump pressure (par. 76 a (5)); rebuild if necessary (pars. 60 thru 62).

**22. IMPROPER ENGINE OPERATING TEMPERATURE.**

**a. Operating Temperature Too High.** (Under normal vehicle operation, the maximum operating temperature as shown by the thermometer on the instrument panel, should not exceed 100 degrees above the prevailing atmospheric temperature.)

Insufficient cooling solution.	Replenish solution.
Fan belt loose or broken.	Adjust or replace belt.

**ENGINE TROUBLE SHOOTING**

Possible Cause	Possible Remedy
Hose connections collapsed or obstructed.	Replace hose.
Dirt or other foreign matter lodged between radiator fins.	Blow out with compressed air or flush from engine side with water from hose.
Thermostat damaged by freezing, blocking circulation.	Replace thermostat (par. 26 in part).
Thermostat removed.	Install thermostat.
Water pump impeller pin sheared.	Rebuild pump (pars. 63 thru 65).
Obstructed radiator core or cylinder block.	Reverse flush (par. 26); or boil out if necessary.
Water distributor tube in cylinder block corroded.	Remove water pump (par. 30 a through e) and inspect tube (par. 38 i).

**b. Operating Temperature Too Low.**

Thermostat removed.	Install thermostat.
Thermostat does not close.	Replace thermostat (par. 26).
Thermostat opens at too low temperature.	Test thermostat (par. 26 d).
Thermostat gasket left out.	Install gasket (par. 26).
Atmospheric temperature extremely low.	Install partial radiator cover.

**23. LOSS OF COOLING SOLUTION.**

Hose connection leaks.	Tighten hose clamps or replace hose.
Drain cocks leak.	Tighten or replace.
Cylinder head gasket leaks, allowing combustion pressures to force cooling solution out radiator overflow pipe.	Tighten or replace gasket (par. 27).
Water pump leaks.	Rebuild water pump (pars. 63 thru 65).
Radiator core leaks.	Repair core.
Improper radiator cap used.	Install pressure type cap.

**24. IMPROPER CLUTCH OPERATION.**

**a. Clutch Chatter.**

Grease on the disk, flywheel or pressure plate.	Replace disk (par. 34) and thoroughly clean other parts.
Binding of clutch release linkage.	Clean and free up linkage

**ORDNANCE MAINTENANCE—POWER PLANT, CLUTCH, AND ELECTRICAL SYSTEM— $\frac{3}{4}$  AND  $1\frac{1}{2}$  TON VEHICLES (DODGE)**

Possible Cause	Possible Remedy
Facings loose on disk.	Replace disk (par. 34).
Broken pressure plate.	Rebuild pressure plate assembly (pars. 69 thru 71).
Release levers out of adjustment.	Rebuild pressure plate assembly (pars. 69 thru 71).
Engine rear mountings loose.	Tighten engine mounting bolts.
Engine rear support spacers worn.	Replace spacers and adjust springs (par. 73 a).

**b. Clutch Grabbing.**

Oil or grease on disk, flywheel or pressure plate.	Replace disk (par. 34) and thoroughly clean other parts.
Clutch disk or pressure plate broken.	Rebuild clutch assembly (pars. 69 thru 71).
Hub of disk not sliding freely on splined shaft.	Remove and free up (par. 34).
Release linkage binding.	Free up linkage.

**c. Clutch Slippage.**

Lack of pedal free play.	Adjust pedal free play (par. 76 a (2)).
Release linkage binding.	Free up linkage.
Pressure springs weak or broken.	Rebuild pressure plate assembly (pars. 69 thru 71).
Disk facings badly worn.	Replace disk (par. 34).
Pressure plate badly worn.	Rebuild pressure plate assembly (pars. 69 thru 71).

**d. Clutch Dragging.**

Excessive pedal free play.	Adjust pedal free play (par. 76 a (2)).
Clutch disk bent or dished.	Replace disk (par. 34).
Clutch disk facings loose or broken.	Replace disk (par. 34).
Pressure springs improperly adjusted.	Rebuild pressure plate assembly (pars. 69 thru 71).
Excessive friction in crankshaft.	Remove clutch (par. 34); replace pilot bushing (par. 42 a).

**e. Clutch Spinning.** Clutch spinning is frequently confused with clutch dragging. A clutch disk which releases perfectly will spin under its own weight and momentum immediately after being released if the transmission gears are in neutral position. Gear clash, when shifting from neutral to first speed or reverse, is usually caused by clutch spinning, and can be overcome only by waiting for the clutch to stop.

**CHAPTER 2**  
**ENGINE AND CLUTCH (Cont'd)**

**Section III**

**ENGINE REPAIRS (ENGINE IN VEHICLE)**

	Paragraph
Engine tests and adjustments . . . . .	25
Reverse flushing of cooling system . . . . .	26
Valve replacement and grinding . . . . .	27
Connecting rod bearing replacement . . . . .	28
Piston and ring replacement . . . . .	29
Chain case cover oil seal, timing chain and sprocket replacement	30
Crankshaft bearing replacement . . . . .	31
Valve tappet adjusting screw replacement . . . . .	32
Flywheel assembly replacement . . . . .	33
Clutch assembly replacement . . . . .	34

**25. ENGINE TESTS AND ADJUSTMENTS.**

a. **Clean and Test Battery** (fig. 18). Clean the top of the battery and battery connections with water and brush, if necessary, and wipe

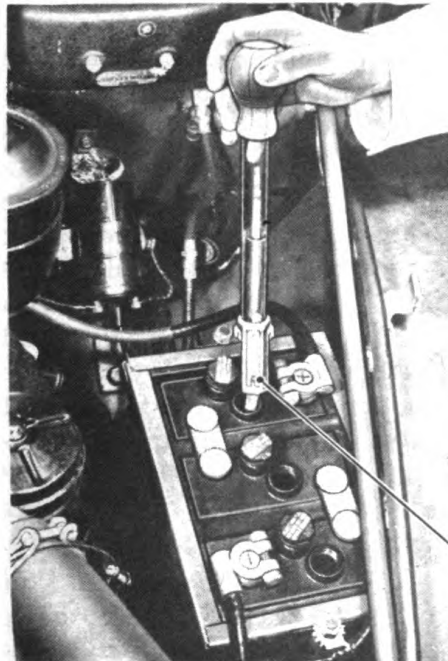

SUBMERGE THE END OF THE HYDROMETER TUBE IN THE BATTERY ELECTROLYTE SOLUTION AND COMPRESS THE BULB. THEN RELEASE THE BULB AND ALLOW HYDROMETER TO PARTIALLY FILL WITH SOLUTION. THE SMALL TUBE WITHIN THE HYDROMETER WILL FLOAT IN THE SOLUTION IF THERE IS ANY CHARGE IN THE BATTERY. THE CHARGE IN THE BATTERY WILL BE INDICATED BY THE FIGURE ON THE SMALL TUBE WHICH SHOWS JUST ABOVE THE LEVEL OF THE SOLUTION. THE FOLLOWING HYDROMETER READINGS SHOW THE CHARGE CONDITION OF THE BATTERY.

FULLY CHARGED . . . 1.275 to 1.300  
 HALF CHARGED . . . 1.225  
 DANGEROUSLY LOW. 1.150

STORAGE BATTERY  
 HYDROMETER (18-H-1240)

RA PD 53238

**Figure 18—Battery Electrolyte Test**

**ORDNANCE MAINTENANCE—POWER PLANT, CLUTCH, AND ELECTRICAL SYSTEM— $\frac{3}{4}$  AND  $1\frac{1}{2}$  TON VEHICLES (DODGE)**

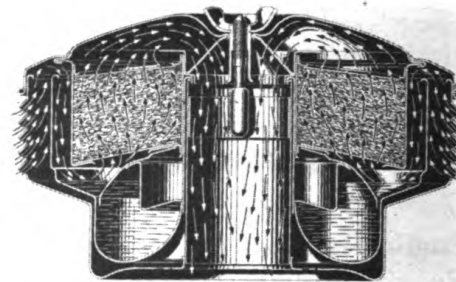
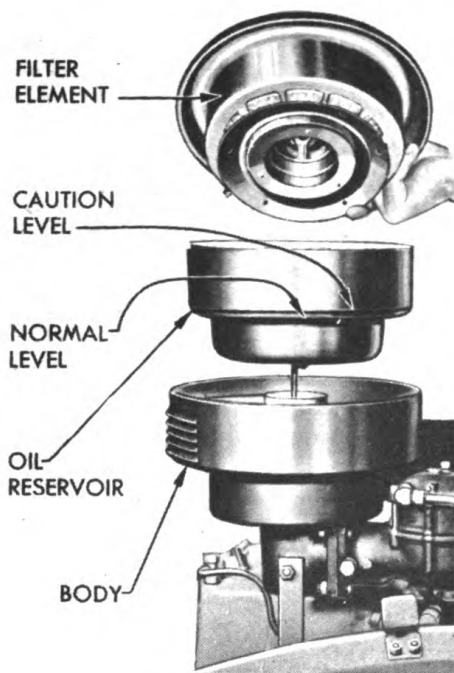

BACK OFF WING NUT AND LIFT OUT FILTER ELEMENT. DO NOT ALLOW THE OIL COLLECTED ON THE BAFFLE TO DRIP INTO THE AIR CLEANER ELBOW. CLEAN THE ELEMENT WITH SOLVENT, DRY CLEANING AND COMPRESSED AIR. LIFT OUT RESERVOIR AND REMOVE OLD OIL AND DIRT. PLACE OIL RESERVOIR IN AIR CLEANER BODY AND FILL TO NORMAL LEVEL WITH CLEAN ENGINE OIL. INSTALL FILTER ELEMENT —TIGHTEN WING NUT.

RA PD 53240

**Figure 19—Carburetor Air Cleaner Service**

dry with cloth. Tighten terminal bolts and ground wire connections to engine or chassis. Tighten battery hold-down clamp bolts. Check the condition of the battery with a battery hydrometer. If the battery is not fully charged, replace it with a battery that is fully charged.

b. **Service Carburetor Air Cleaner and Positive Type Crankcase Ventilator** (figs. 19 and 20). Clean the element of the carburetor air cleaner with dry-cleaning solvent and compressed air, and fill to the marked level with clean engine oil (fig. 19). If engine is equipped with a positive-type crankcase ventilator (fig. 20), remove the vent tube and the metering valve. Clean out the opening in the manifold. Clamp the lower end of the metering valve in a vise and screw off the upper part of the valve body. Wash the metering valve and vent tube in dry-cleaning solvent and remove any carbon or gum formation. Assemble the metering valve in the valve body with the pintle end of the valve up. Screw the metering valve into the manifold and install the vent tube.

c. **Tighten Cylinder Head and Manifold Stud Nuts and Oil Pan Cap Screws.** Tighten the cylinder head stud nuts to  $52\frac{1}{2}$  to  $57\frac{1}{2}$  foot-pounds, and the cap screw to 65 to 70 foot-pounds. Tighten manifold to block stud nuts, carburetor to manifold stud nuts and oil pan cap screws.

d. **Adjust Valve Tappets** (fig. 21). Remove right front wheel and

ENGINE REPAIRS (ENGINE IN VEHICLE)

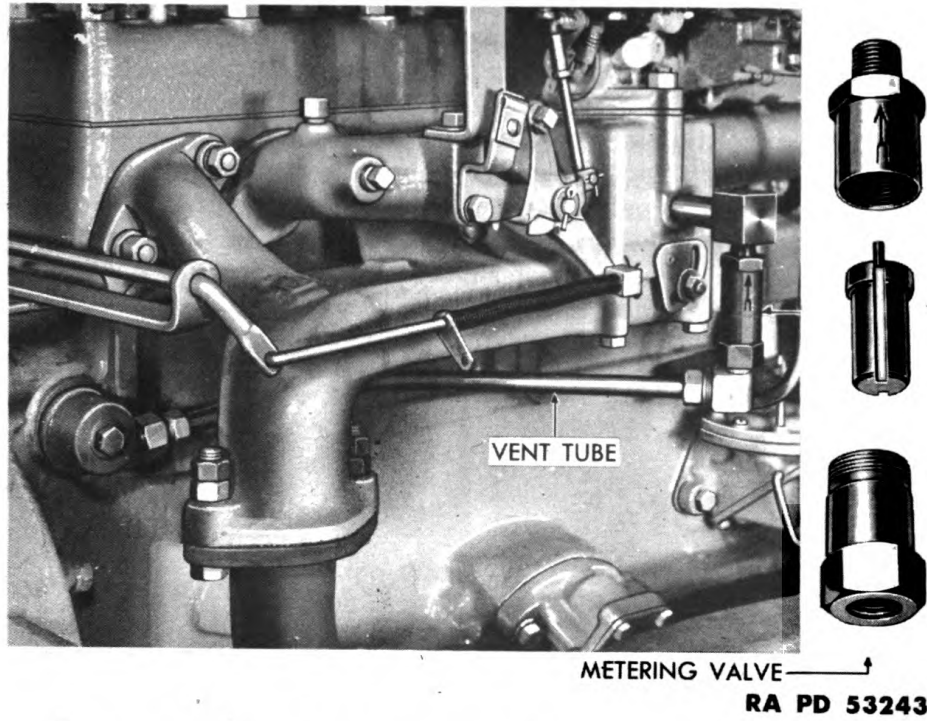

Figure 20—Positive Type Crankcase Ventilator

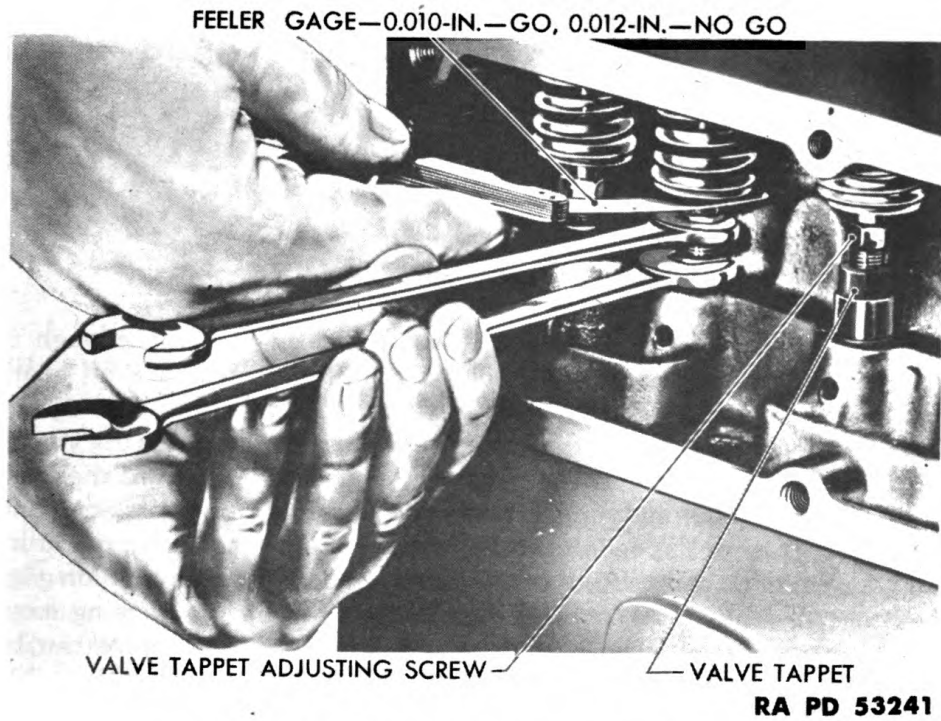
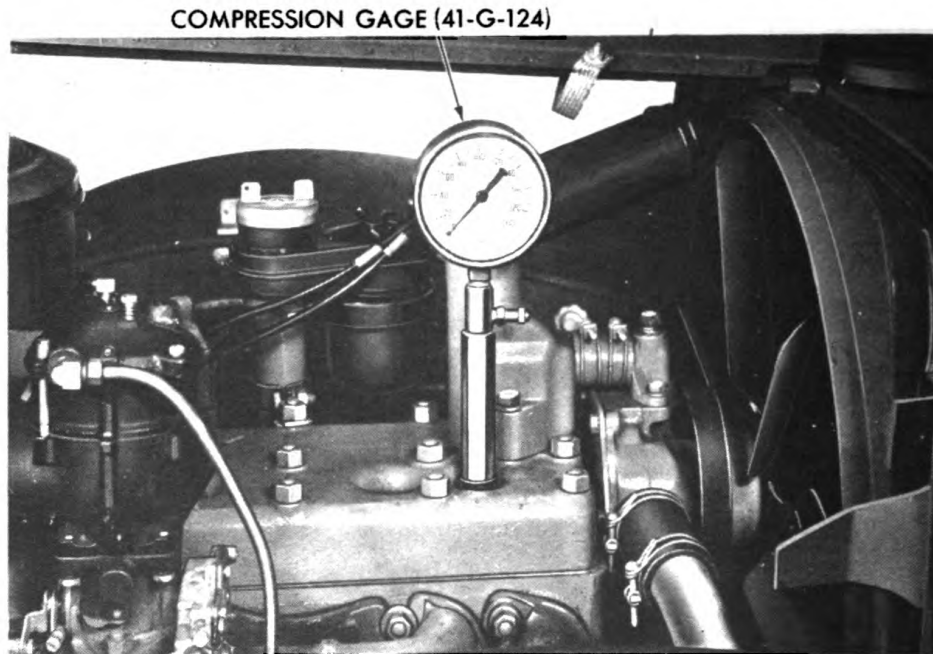

Figure 21—Valve Tappet Adjustment



**ORDNANCE MAINTENANCE—POWER PLANT, CLUTCH, AND ELECTRICAL SYSTEM— $\frac{3}{4}$  AND  $1\frac{1}{2}$  TON VEHICLES (DODGE)**

fender splash shield (par. 27 d). Remove valve spring covers (par. 27 e). Run the engine until normal operating temperature is reached. With the engine running at idling speed, hold tappet from turning and adjust the self-locking adjusting screw until a 0.010-inch feeler gage will go between the adjusting screw and the end of the valve stem, but a 0.012-inch feeler will *not* go between the screw and the stem. Make the same adjustment on all intake and exhaust valve tappets. Install valve spring covers (par. 27 p), fender splash shield and wheel (par. 27 q).



90 TO 110 LBS. MAXIMUM COMPRESSION WITH ENGINE AT 160 F.

RA PD 53250

**Figure 22—Compression Test**

e. **Test Compression** (fig. 22). Run the engine long enough to establish normal operating temperature (160 F). Remove all spark plugs and install the compression gage in the spark plug hole of one cylinder. With the throttle wide open, crank the engine with the starter until maximum compression is registered on the gage. Record the reading for that cylinder and repeat the test on the other five cylinders. Compression pressure depends upon cranking speeds, engine temperature and compression ratio. If the reading indicated by the compression gage is reasonably high (90 to 110 pounds at sea level), not varying more than 20 pounds between cylinders, the compression pressure can be considered normal. If the pressure in any cylinder is weak, inject oil in spark plug hole on top of the piston with piston down. Wait a few minutes for oil to run down over rings, to prevent oil getting on valves and

**ENGINE REPAIRS (ENGINE IN VEHICLE)**

repeat compression test. The oil seals the rings so that a low reading on the first test, which remains low on the second test, indicates leaky valves. A low reading on the first test, which becomes a high reading on the second test, indicates leaky rings. If either condition exists, grind the valves (par. 27) or replace the piston rings (par. 29). An extremely low compression reading on two adjacent cylinders indicates a leaking cylinder head gasket. A gasket which has blown out between cylinders will cause erratic explosions between the two cylinders. Replace gasket (par. 27).

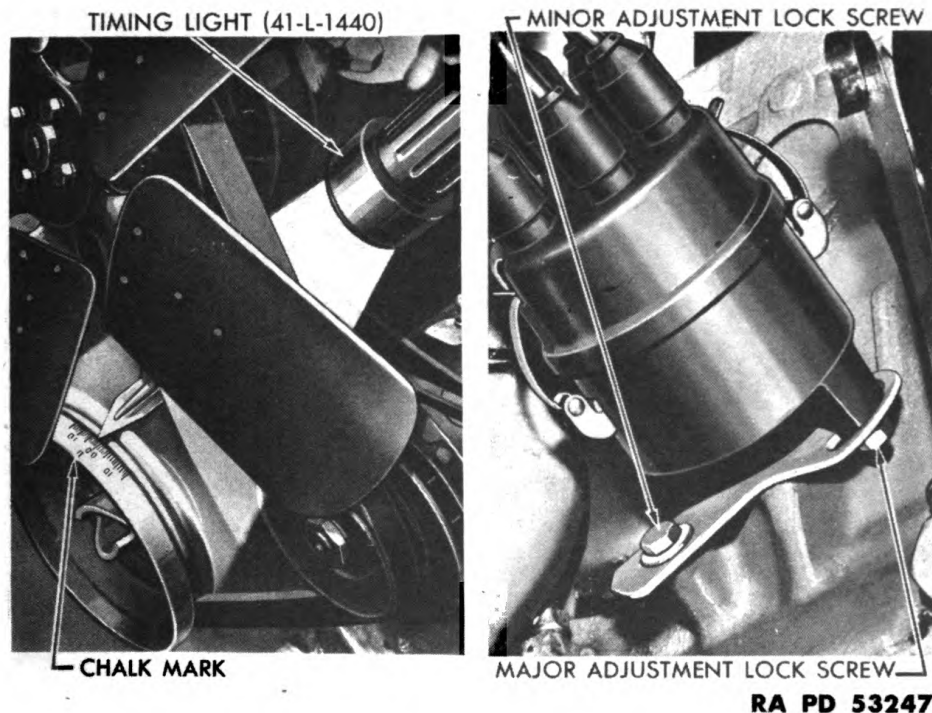

**Figure 23—Ignition Timing Adjustment**

f. **Service Ignition System.** Make ignition circuit tests (par. 87). Wipe all dirt or oil off distributor cap and rotor and inspect the cap and rotor for cracks or damage.

g. **Timing Specifications.** In low altitudes, gasoline of 70 octane rating will give best engine performance with timing set at two degrees after top dead center. With this timing, there will be a trace of spark ping from 10 to 30 miles per hour when accelerating with wide open throttle. When using lower grade fuels, or after carbon has accumulated, spark ping may be excessive with the engine timed at two degrees after top dead center. In such cases, retard the timing not to exceed six degrees after top dead center. In high altitudes there is less tendency for spark ping, and the same thing is true in low altitudes when using fuel with a higher octane rating than 70. In such cases, improved perform-

**ORDNANCE MAINTENANCE—POWER PLANT, CLUTCH, AND ELECTRICAL SYSTEM— $\frac{3}{4}$  AND 1  $\frac{1}{2}$  TON VEHICLES (DODGE)**

ance may be obtained by advancing the spark not to exceed two degrees before top dead center. Within the foregoing limits (2 degrees before top dead center to 6 degrees after top dead center), a good rule to follow is to set the ignition timing at a point where a slight ping is audible when accelerating from ten miles per hour with wide open throttle.

**h. Adjust Ignition Timing (fig. 23).** Connect one lead from the timing light to number one spark plug and the other lead to a convenient ground. Place a chalk mark on crankshaft pulley at desired setting (par. 25 g) and run engine at idling speed. Loosen the major adjustment lock

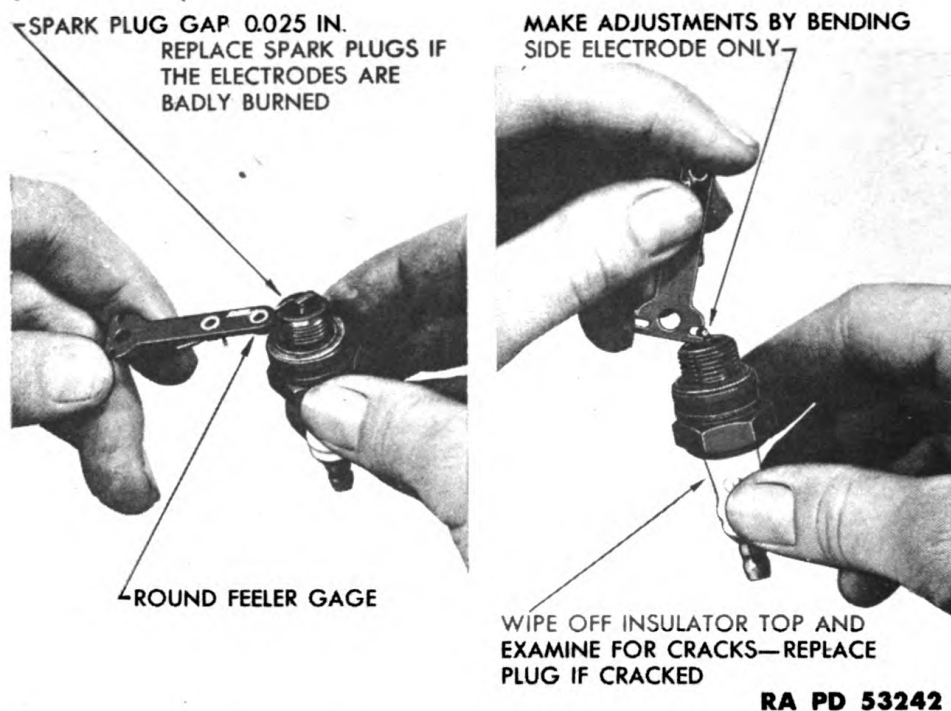

**Figure 24—Spark Plug Adjustment**

screw and rotate distributor body clockwise to retard and counterclockwise to advance ignition timing. Point the neon light at the pointer over pulley. The neon light should flash when the chalk mark is opposite pointer over pulley, indicating correct setting of ignition timing (position of piston when firing occurs). To make a minor change in ignition timing, loosen the minor adjustment lock screw and rotate the distributor body slightly in the proper direction.

**i. Clean, Test and Adjust Spark Plugs (fig. 24).** Remove spark plugs from engine and wipe exterior of plugs clean and dry. Clean the plugs in spark plug cleaner and tester (41-C-1013) and inspect for mechanical defects. Reset gap to 0.025-inch, and test in tester before

**ENGINE REPAIRS (ENGINE IN VEHICLE)**

installing in engine. Use round feeler gage and make all adjustments on the side wire of the plug. If the center electrode is bent, the porcelain may crack, resulting in plug failure. Install plugs that test satisfactorily and replace those that do not.

j. **Test Vacuum** (fig. 25). Disconnect the windshield wiper hose at the tube leading to the intake manifold. Connect the vacuum gage to the tube. Start the engine and allow it to run at idling speed until normal operating temperature is reached. A steady reading of 18 to 21 inches of vacuum at sea level indicates normal performance of the engine at idling speed. The pointer of the gage fluctuating back and forth

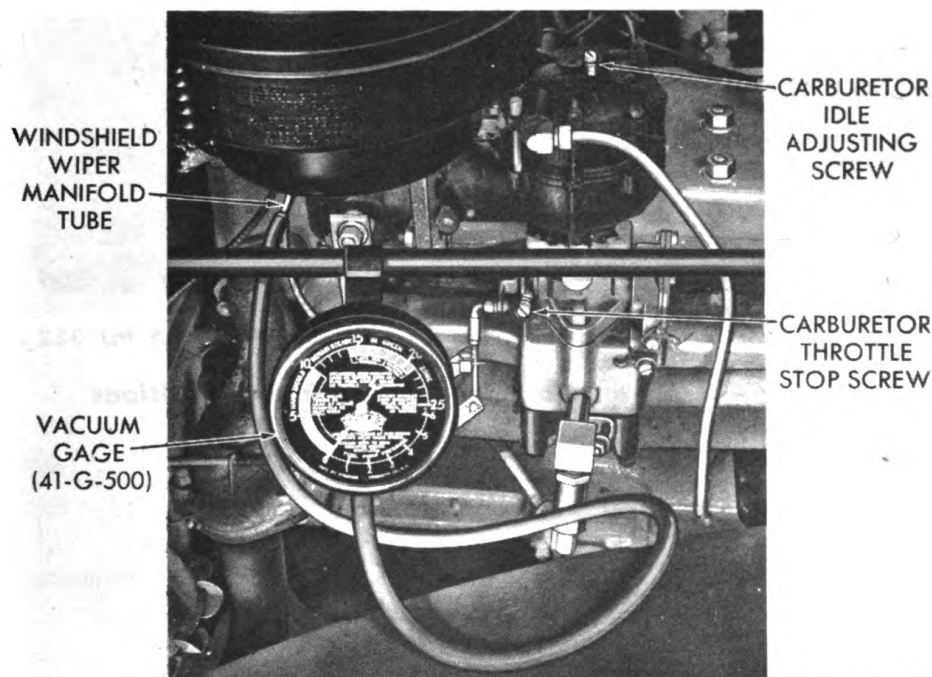

RA PD 53295

**Figure 25—Vacuum Test**

indicates too rich or too lean a fuel mixture. Adjust the idle adjusting screw and throttle stop screw on the carburetor to obtain maximum reading on the vacuum gage and proper idling speed of the engine. If adjustment of the carburetor idle adjusting screw does not cause a normal reading on the vacuum gage and the compression test (par. 25 e) indicated normal engine performance, remove and inspect the carburetor (pars. 54, 55 and 56).

k. **Check Setting of Manifold Heat Control Valve** (fig. 26). Loosen the locking plate cap screw and turn the valve plate to the correct position for the season of the year.

**ORDNANCE MAINTENANCE—POWER PLANT, CLUTCH, AND  
ELECTRICAL SYSTEM— $\frac{3}{4}$  AND  $1\frac{1}{2}$  TON VEHICLES (DODGE)**

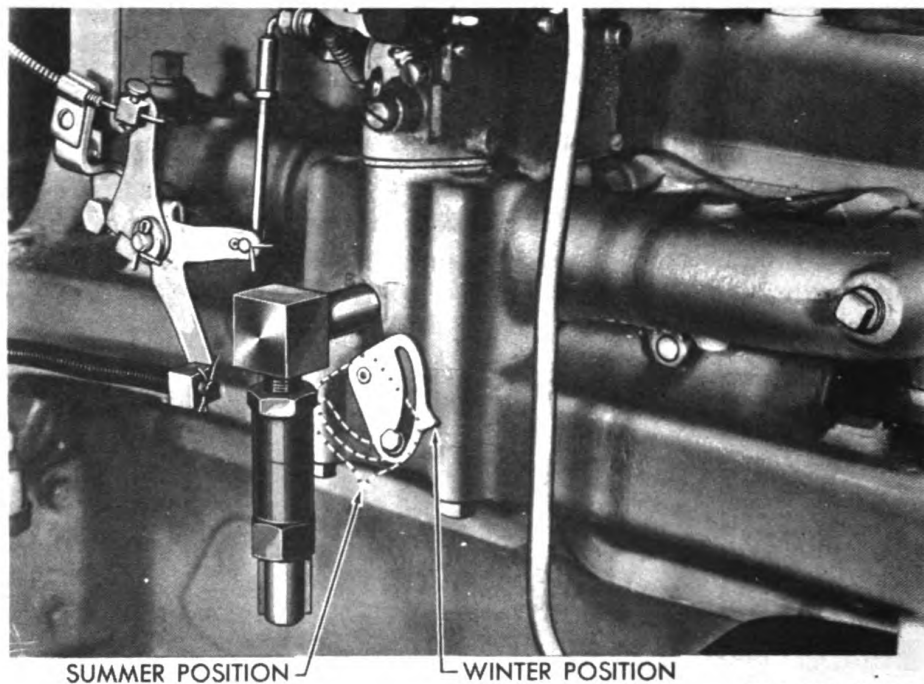

RA PD 53226

**Figure 26—Manifold Heat Control Valve Positions**

**26. REVERSE FLUSHING OF COOLING SYSTEM.**

a. **Disconnect Hose and Remove Thermostat (fig. 27).** Open radiator drain cock and disconnect hose from the top and bottom of the radiator. Remove the cylinder head water outlet elbow and thermostat. Plug the bypass elbow with a cork and install the elbow leaving the thermostat out.

b. **Flush Engine (fig. 27).** Attach flushing gun to the engine outlet elbow at the top of the cylinder block. Turn on the water and compressed air and force the water downward through the cylinder head and block until the water jackets are clean. A pulsating flow of water will loosen sediment quicker than a steady flow.

c. **Flush Radiator (fig. 27).**

(1) Attach the flushing gun to the radiator outlet elbow at the bottom of the radiator and force the water up through the radiator until the radiator is clean.

(2) **CAUTION:** *When pressure flushing the radiator do not apply excessive pressure which might damage the radiator. Never flush a cylinder block while it is connected to the radiator, as rust scales may be forced from the block into the radiator and permanently clog the radiator.*

**ENGINE REPAIRS (ENGINE IN VEHICLE)**

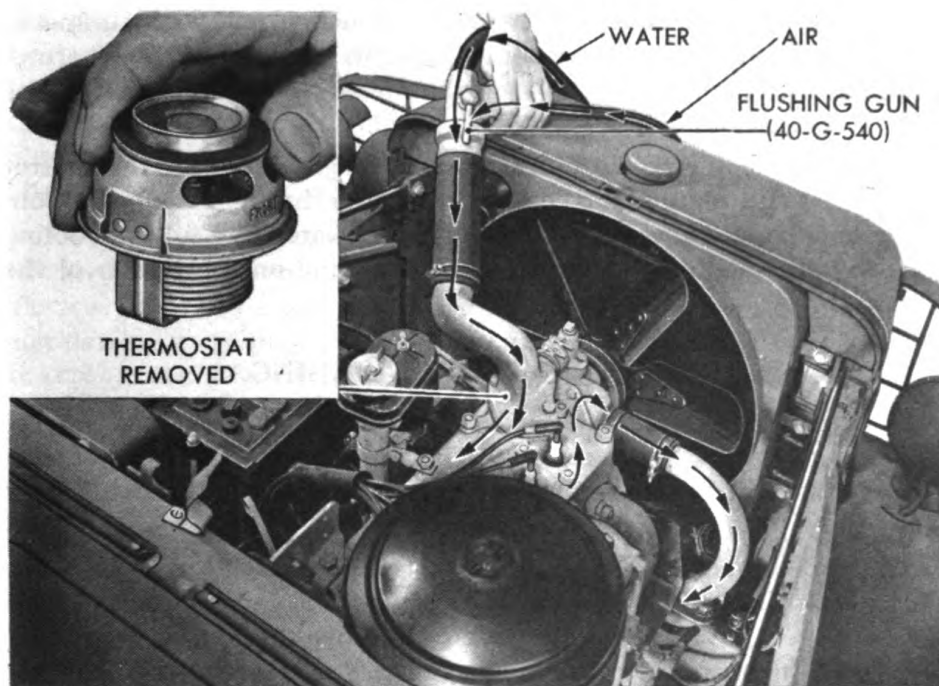

**REVERSE FLUSHING THE ENGINE**

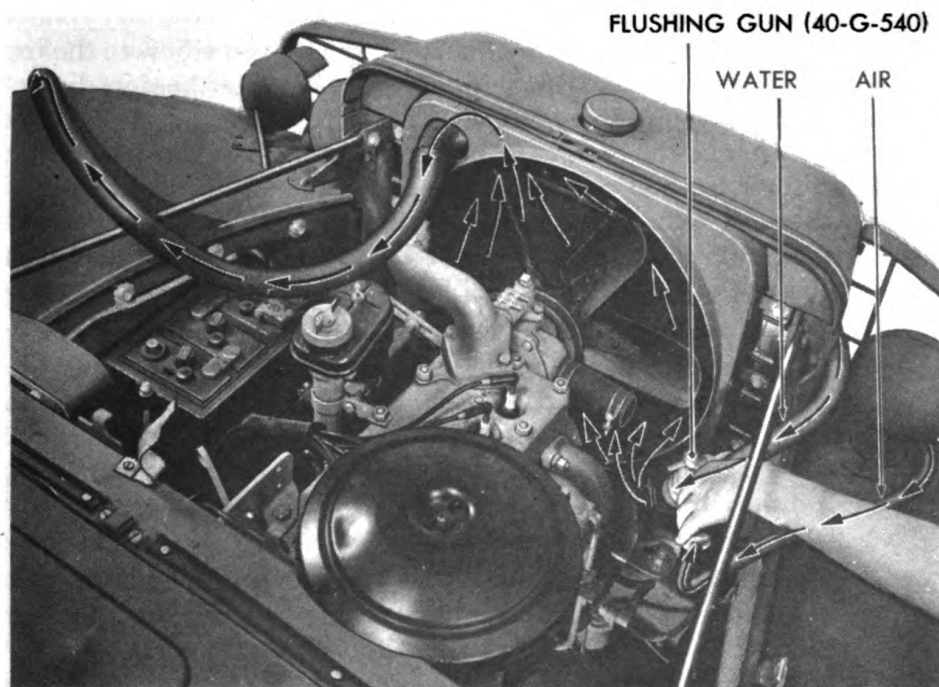

**REVERSE FLUSHING THE RADIATOR**

**RA PD 53335**

**Figure 27—Reverse Flushing Cooling System**

## TM 9-1808A

26-27

### ORDNANCE MAINTENANCE—POWER PLANT, CLUTCH, AND ELECTRICAL SYSTEM—¾ AND 1½ TON VEHICLES (DODGE)

d. **Test Thermostat.** Heat a pan of water to 160 F, immerse thermostat in water and note whether it begins to open. Remove thermostat, heat water to 185 F and again immerse thermostat. If it opens fully, it is functioning properly.

e. **Install Thermostat and Connect Hose.** Install the thermostat (par. 30 r) and remove the cork or plug from the bypass elbow. Connect water hose at top and bottom of the radiator and fill the cooling system with water and/or antifreeze depending on the season of the year.

### 27. VALVE REPLACEMENT AND GRINDING.

a. **Drain Radiator and Disconnect Battery Cable.** Open the drain cock at the lower front corner of the radiator and drain out the cooling solution. Disconnect the battery to starting motor cable from the battery to avoid damage from short circuit.

b. **Disconnect Parts Attached to Cylinder Head.** Back off the wing nut at the top of the carburetor air cleaner and lift out the filter element; then lift out the oil reservoir. Remove the four screws in the bottom of the air cleaner body and remove the cleaner body. Lift the spark plug wires from the spark plugs and remove the spark plugs. Disconnect the ground strap from the right rear cylinder head cap screw. Disconnect the radiator inlet hose from outlet elbow on cylinder head and remove the cap screws which hold the bypass elbow to the top of the water pump. If truck is equipped with hot water heater, disconnect heater hose from bypass elbow and from cylinder head. Remove two nuts which hold the horn to its bracket. Open clip which holds horn wire to oil filter bracket and move the horn to one side. Open clip on cylinder head which holds thermometer bulb tube; then remove thermometer bulb from cylinder head. Disconnect choke control wire and housing at the carburetor.

c. **Remove Cylinder Head Nuts and Cylinder Head.** Remove 20 cylinder head stud nuts and one cap screw. Lift off oil filter and bracket assembly, spark plug cables and clip for the thermometer tube. Loosen clamp bolt in breather pipe bracket and slide the bracket up off the cylinder head stud. Install a lifting eye in number five spark plug hole and lift the cylinder head off the engine. Clean all carbon from the cylinder head, cylinder block and tops of pistons.

d. **Remove Right Front Wheel and Fender Splash Shield.** Jack up the wheel and place a stand under the axle housing. Remove the five large nuts which hold the wheel to the hub with wheel lug nut wrench (41-W-3830) and remove the wheel and tire assembly. Remove the cap screws which attach the lower side of the shield to the front and rear brackets. Remove the cap screws which hold the upper side of the shield to fender and pull the shield from under the fender.

**ENGINE REPAIRS (ENGINE IN VEHICLE)**

e. **Remove Valve Spring Covers.** Remove wing nut from top of fuel pump heat shield. Loosen manifold front stud nut and remove the heat shield. Remove crankcase ventilator outlet pipe from rear of crankcase (if so equipped). If equipped with positive type ventilator, disconnect vent tube at metering valve and crankcase and remove tube. Remove the thumb screw and nut from each cover and pull covers from engine.

f. **Remove Valves and Springs.** If cover studs interfere with use of valve lifter, lock two nuts together on the stud and remove the studs. Tuck a small piece of cloth in the oil return holes in the valve tappet compartments to prevent the valve spring retaining locks falling into the crankcase. Then remove the valves, valve retainer locks and springs as explained in paragraph 39 e.

g. **Inspect Valves, Seats, Guides and Springs** (par. 46 a through d).

h. **Replace Valve Stem Guides.**

(1) **REMOVE VALVE STEM GUIDES.** With the valve spring removed and tappet down, drive the valve stem guide down nearly to the tappet screw with valve stem guide drift (par. 46 e). Strike the lower end of the valve guide with a hammer and break off the exposed portion of the guide so that the rest of the guide can be driven down and out of the block.

(2) **INSTALL VALVE STEM GUIDES** (par. 46 f).

i. **Replace Valve Seat Inserts (Exhaust) and Grind Valve Seats** (par. 46 g and i).

j. **Reface Valves** (par. 46 h).

k. **Install Valves and Springs.** Install the valves, valve springs and valve retainer locks as explained in paragraph 52 c. Then remove the piece of cloth from the oil return holes.

l. **Install Cylinder Head and Nuts** (fig. 28). With a clean cloth, wipe the surfaces of the cylinder head and block thoroughly clean. Apply a thin coating of engine oil or gasket seal to both sides of a new cylinder head gasket and put the gasket over the studs on the block. Place the head in position on the block. Install spark plugs in cylinder head and place oil filter bracket on studs "9" and "15" (fig. 28). Place shakeproof lock washer on stud 6, then put the breather pipe bracket over that stud. Place shakeproof lock washer over stud 3, then place spark plug cable tube bracket on that stud with another shakeproof lock washer on top of the bracket. Place thermometer wire clip over stud 21. Install nut on each cylinder head stud and install cap screw in right rear corner of head. Tighten stud nuts in the order shown in figure 28, to 52½ to 57½ foot-pounds and the cap screw to 65 to 70 foot-pounds with torque wrench.



**ORDNANCE MAINTENANCE—POWER PLANT, CLUTCH, AND ELECTRICAL SYSTEM— $\frac{3}{4}$  AND  $1\frac{1}{2}$  TON VEHICLES (DODGE)**

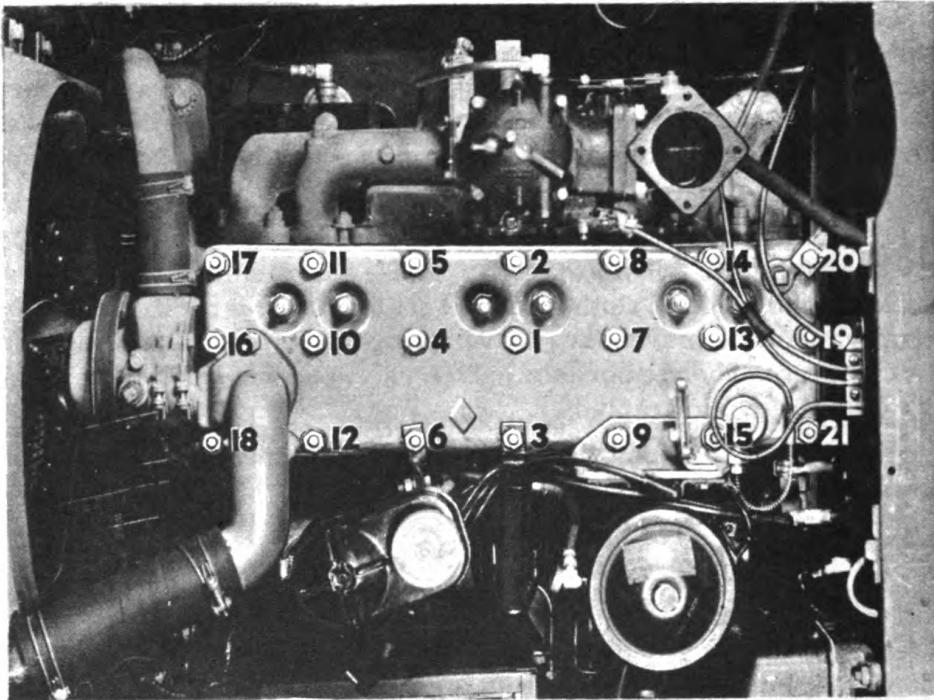

**CYLINDER HEAD NUT TIGHTENING SEQUENCE**

TIGHTEN STUD NUTS  $52\frac{1}{2}$  TO  $57\frac{1}{2}$  FOOT POUNDS—  
CAP SCREW 65 TO 70 FOOT POUNDS

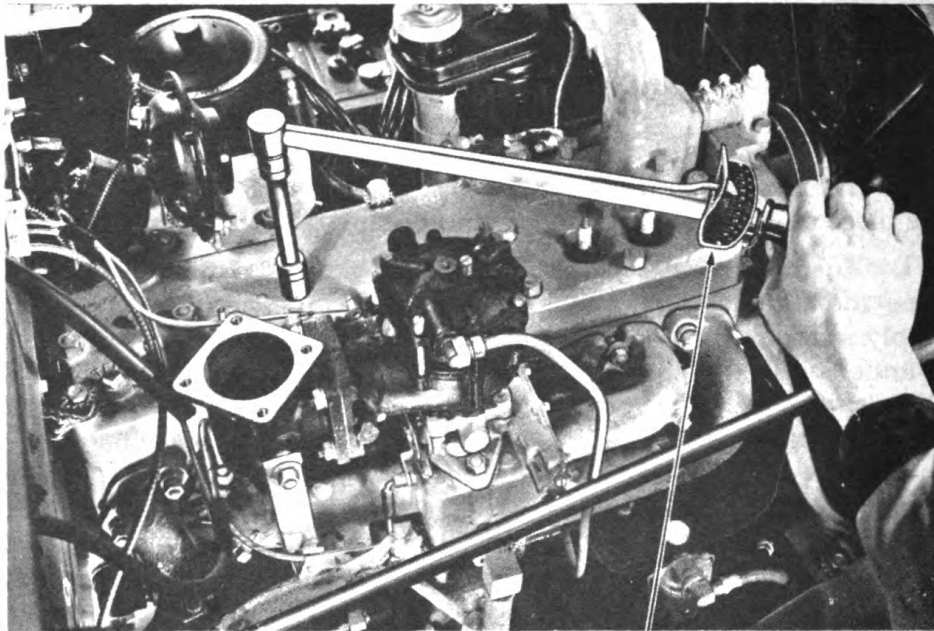

TORQUE INDICATING WRENCH (41-W-3630)—

RA PD 53246

**Figure 28—Tightening Cylinder Head Nuts**

**ENGINE REPAIRS (ENGINE IN VEHICLE)**

**m. Attach Parts to Cylinder Head and Carburetor.** Connect choke control wire and housing to carburetor. Install thermometer bulb in cylinder head, place thermometer tube in clip on cylinder head and close the clip. Install the horn on its bracket, place the horn wire in the clip at the oil filter bracket and close the clip. Place a shakeproof lock washer on each side of the ground strap and connect the strap with a cap screw to the cylinder head cap screw. Push the spark plug cable terminals over the tops of the spark plugs. Install new gasket between bypass elbow and water pump and connect hose to cylinder head outlet elbow. If truck is equipped with hot water heater, connect heater hose to bypass elbow and cylinder head. Install the four screws which hold the carburetor air cleaner to the elbow on the carburetor. Place the oil reservoir in the cleaner body and fill to the marked level with clean engine oil. Install filter element and tighten the wing nut.

**n. Fill Radiator and Connect Battery Cable.** Close the drain cock at the lower front corner of the radiator and fill the radiator to within  $2\frac{1}{4}$  inches of the top of the filler tube. Connect the cable to the battery.

**o. Adjust Valve Tappets.** Start the engine and run it until normal operating temperature is reached. With the engine running at idling speed, adjust the tappets (par. 25 d).

**p. Install Valve Spring Covers.** If the spring cover studs were removed, screw them into the front and rear holes of the cylinder block. Install the covers with new gaskets on the covers, as well as on the screws and studs and screw the thumb screws into place. Install plain washers over the gaskets on the two end studs and install the nuts. Install the ventilator outlet pipe at the rear of the crankcase (if so equipped). If equipped with positive type ventilator, connect the vent tube between metering valve and crankcase. Slide the fuel pump heat shield into place back of the manifold front nut and over the stud at the top of the fuel pump. Tighten the manifold nut and the wing nut on the fuel pump.

**q. Install Fender Splash Shield and Wheel.** Place the splash shield into position under the fender and install cap screws and special washers which attach the shield to the fender. Install the front and rear bracket cap screws with shakeproof lock washers under the heads of the cap screws. Place the wheel and tire assembly on the hub and install the five large nuts with wheel lug nut wrench (41-W-3830). Remove the stand from under the axle and lower the wheel to the ground.

**28. CONNECTING ROD BEARING REPLACEMENT.**

**a. Remove Connecting Rod Bearings.** Drain the engine oil and remove the cap screws which hold the engine oil pan to the crankcase. Lower the oil pan, remove the old gaskets and clean the pan thoroughly. Install the oil drain plug. Remove the cap bolt nuts and bearing caps

**ORDNANCE MAINTENANCE—POWER PLANT, CLUTCH, AND ELECTRICAL SYSTEM— $\frac{3}{4}$  AND 1 $\frac{1}{2}$  TON VEHICLES (DODGE)**

from the connecting rods. Raise the rods off the crankshaft and remove the bearings.

b. **Inspect Crankshaft Connecting Rod Bearing Journals and Bearings** (fig. 29). If the journals are scored or rough or if when measured with a micrometer (41-C-307), the journal wear exceeds 0.002 inch (par. 78 c); taper or out of round exceeds 0.001 inch, re-grind the journals or rebuild the engine. If the crankshaft journals are smooth and the wear does not exceed the maximum allowable, inspect the bearings. If the bearing metal is checked or cracked, replace the

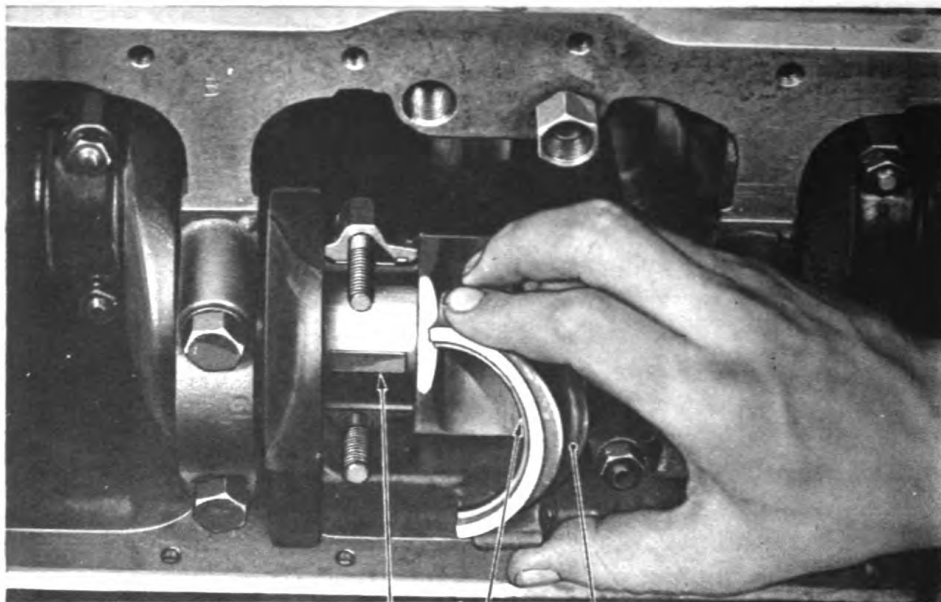

0.003-IN. BRASS SHIM STOCK  $\frac{1}{4}$ -IN. WIDE AND 1-IN. LONG RA PD 53322

**Figure 29—Checking Connecting Rod Bearing Clearance**

bearings. To check connecting rod bearing clearance, oil the crankshaft journal and place a piece of 0.003-inch brass shim stock  $\frac{1}{4}$  inch wide and one inch long lengthwise between the bearing and journal (fig. 29). Install the bearing cap and tighten the cap bolt nuts to 45 to 50 foot-pounds with torque wrench (41-W-3630). If the shim does not almost lock the crankshaft when it is moved, the bearing clearance exceeds the maximum allowable of 0.0025 inch, and new standard or undersize bearings will be required. Connecting rod bearings are available in undersizes of 0.002, 0.010, 0.012, 0.020 and 0.030 inch.

c. **Install Connecting Rod Bearings.** Clean the bores of the connecting rods, the bearings and the journals thoroughly. Place the bear-

**ENGINE REPAIRS (ENGINE IN VEHICLE)**

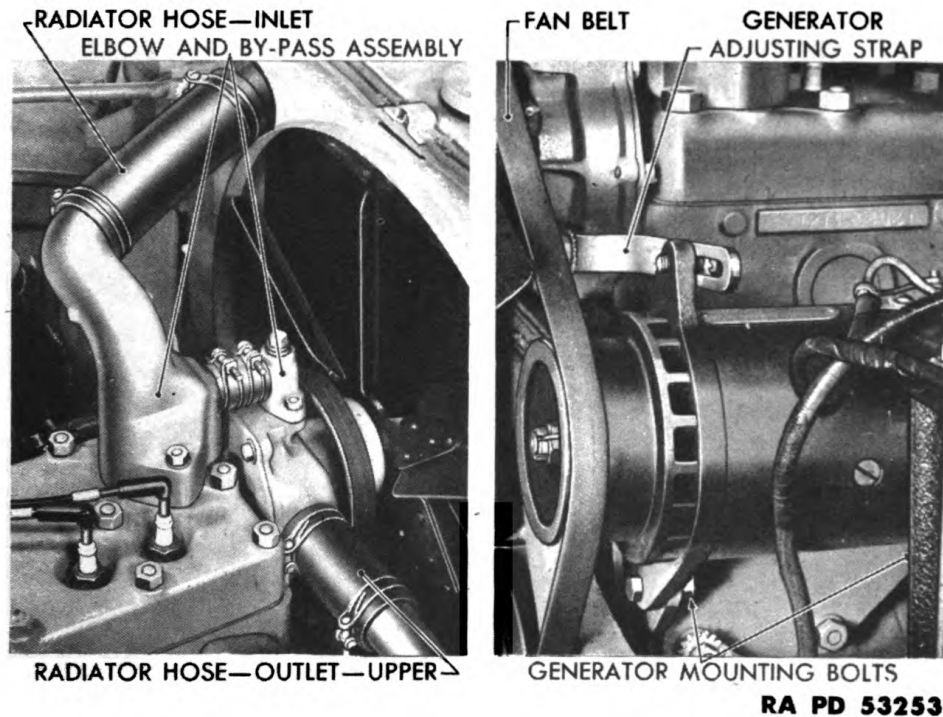

**Figure 30—Radiator Hose, Fan Belt and Generator Mounting**

ings in the rods and caps and attach the rods to the crankshaft. Tighten the cap bolt nuts to 45 to 50 foot-pounds with torque wrench (41-W-3630).

d. **Install Oil Pan.** Install new gaskets on the oil pan as explained in paragraph 52 n. Raise the pan into position and install the attaching cap screws. Fill the engine with engine oil of the proper grade for the season of the year.

**29. PISTON AND RING REPLACEMENT.**

- a. **Remove Cylinder Head** (par. 27 a, b and c).
- b. **Remove Oil Pan and Disconnect Connecting Rods** (par. 28 a).
- c. **Remove Cylinder Bore Ridge; Remove and Inspect Piston, Ring and Connecting Rod Assemblies.** Remove any ridge that may have formed in the cylinder bores at the top of the ring travel with cylinder reamer (41-R-2275). Do not cut more than  $\frac{1}{64}$  inch below bottom edge of ridge. Push the piston and connecting rod assemblies out the top of the cylinder bores. Refer to paragraph 45 for inspection and repair procedure of piston, pin and connecting rod assemblies.
- d. **Assemble and Install Piston, Ring and Connecting Rod Assemblies** (par. 52 f and g).
- e. **Install Connecting Rod Bearings** (par. 28 c).

**ORDNANCE MAINTENANCE—POWER PLANT, CLUTCH, AND ELECTRICAL SYSTEM— $\frac{3}{4}$  AND  $1\frac{1}{2}$  TON VEHICLES (DODGE)**

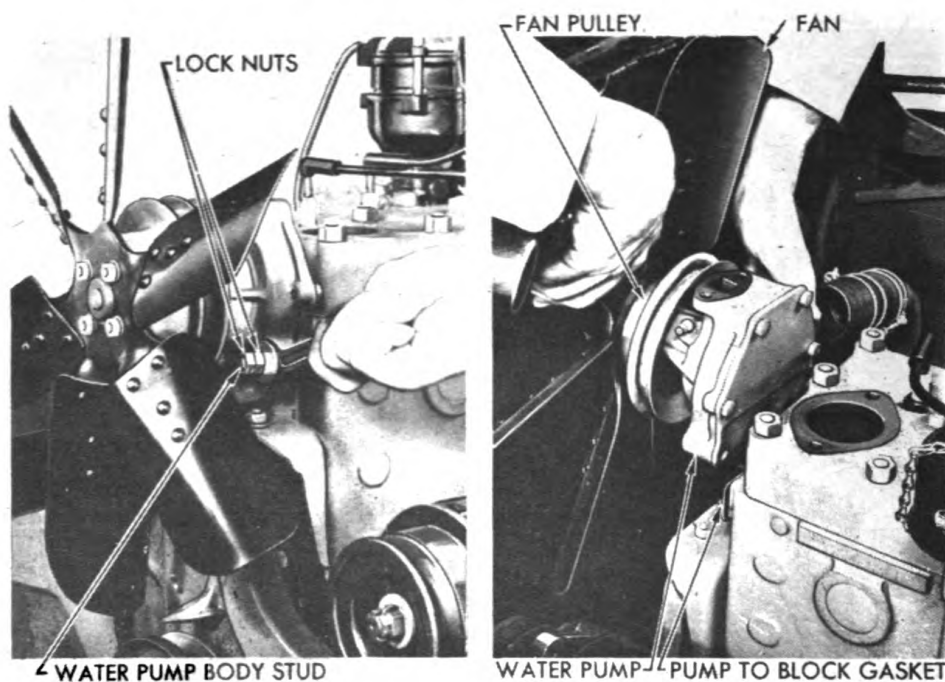

RA PD 53254

**Figure 31—Water Pump Removal (Vehicles without Fan Shroud)**

- f. Install Oil Pan (par. 28 d).
- g. Install Cylinder Head (par. 27 l, m and n).

**30. CHAIN CASE COVER OIL SEAL, TIMING CHAIN AND SPROCKET REPLACEMENT.**

a. **Drain Radiator, Remove Hood, and Disconnect Radiator Hose** (fig. 30). Drain the radiator, and remove hood (par. 35 a). Loosen hose clamp at lower radiator hose at the water pump housing connection and pull hose away from pump. Loosen both hose clamps of the upper radiator inlet hose and pull hose away from radiator core and remove it from the elbow and bypass assembly. If vehicle is equipped with a hot water heater, disconnect heater hose at water pump.

b. **Remove Fan Belt** (fig. 30). Loosen the generator mounting bolt nuts and the adjusting strap cap screw. Remove the nut from water pump stud that holds the adjusting strap and move the strap off the stud. Then move the generator toward the engine and remove the fan belt from the generator drive pulley.

c. **Remove Elbow and Bypass Assembly** (fig. 30). Remove the water pump bypass elbow to pump cap screws. Remove the cylinder head water outlet elbow attaching cap screws and lift off the elbow and bypass assembly carefully to prevent damaging the thermostat.

**ENGINE REPAIRS (ENGINE IN VEHICLE)**

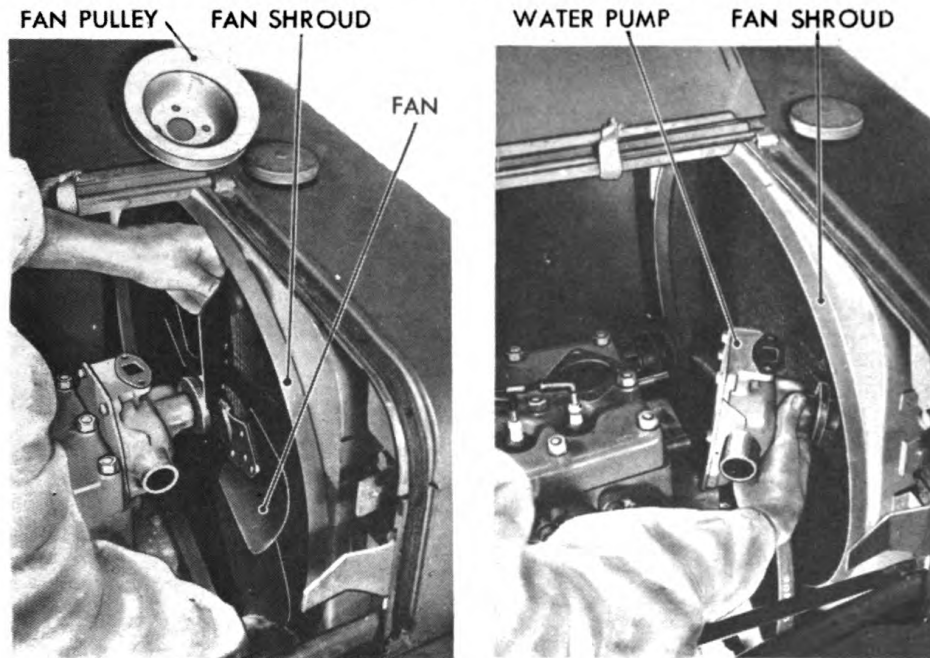

RA PD 53255

**Figure 32—Water Pump Removal (Vehicles with Fan Shroud)**

**d. Remove Water Pump (Trucks without Fan Shroud) (fig. 31).** Remove the water pump to cylinder block stud nuts and lock washers. Install two nuts and lock the nuts together on each stud to remove the studs. Turn the inner nut counterclockwise and screw the studs out of the block. Lift the water pump and fan assembly from the cylinder block.

**e. Remove Water Pump (Trucks with Fan Shroud) (fig. 32).** Remove the four cap screws that attach the fan blades to the water pump and remove the fan blades and fan hub. Remove the water pump stud nuts, move the pump forward off the studs and lift it out.

**f. Remove Radiator Core Assembly (fig. 33).** Remove the screws that hold the radiator core, and fan shroud (if so equipped), to the radiator support. Unscrew the radiator cap and remove the cap by compressing the lock at the end of the retainer chain. Lift out the shroud (if so equipped). Move core out of the support and lift it out.

**g. Remove Radiator Guard Assembly.** Remove the nuts and bolts that attach the radiator guard to the sides of the radiator support and remove the right and left head lamp guards. Remove the cap screws that attach the radiator to the upper parts of the support and remove the guard.

**h. Remove Engine Front Support.** Place a jack under the front of the engine to support it. Then remove the nuts from the studs that

**ORDNANCE MAINTENANCE—POWER PLANT, CLUTCH, AND ELECTRICAL SYSTEM— $\frac{3}{4}$  AND  $1\frac{1}{2}$  TON VEHICLES (DODGE)**

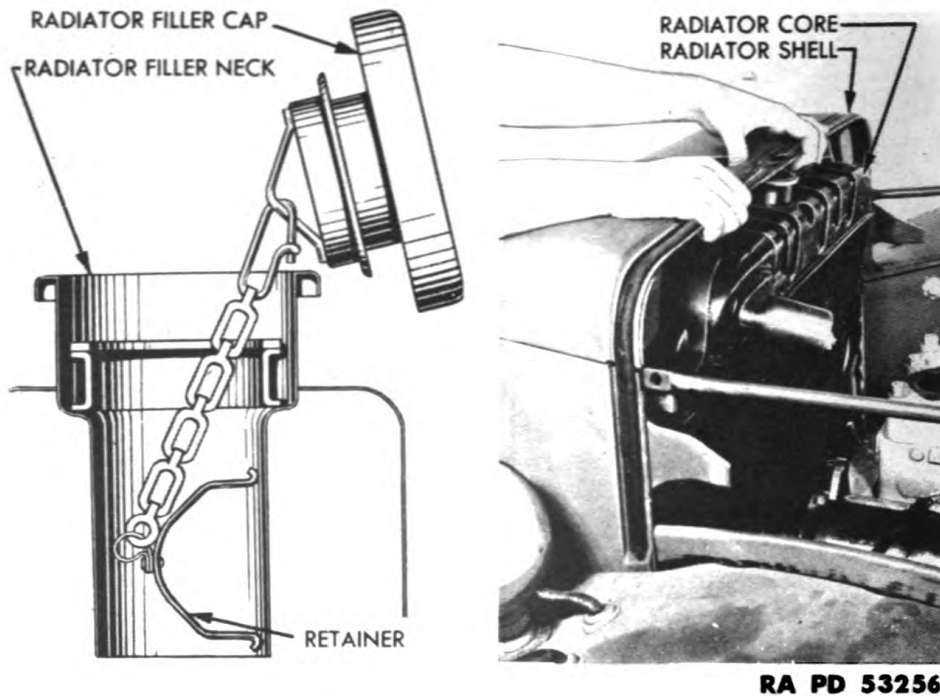

**Figure 33—Radiator Core Removal**

attach the support insulator to front cover plate. Remove the cap screws from each side of the engine support frame cross member. Raise the engine slightly with the jack and remove the support.

- i. **Inspect and Remove Timing Chain and Sprockets** (par. 39 f).
- j. **Install Oil Seal in Chain Case Cover** (par. 50).
- k. **Install Crankshaft Sprocket.** Install the crankshaft sprocket drive key in the crankshaft and press the crankshaft sprocket on the shaft with the mark O facing out.
- l. **Install Camshaft Sprocket and Timing Chain** (par. 52 h).
- m. **Install Chain Case Cover, Engine Support and Fan Pulley** (par. 52 i).
- n. **Attach Engine Support.** Lower the engine with the jack and attach the engine support to the front frame cross member with the cap screws and shakeproof lock washers at each end of the support. Remove the jack.
- o. **Install Radiator Core.** Place the radiator, and fan shroud (if so equipped) in the radiator support and line up the attaching screw holes. Install the cap screws with shakeproof lock washers to attach the radiator to the support.
- p. **Install Water Pump (Vehicles without Fan Shroud).** Hold the water pump and fan assembly with a new gasket in position against

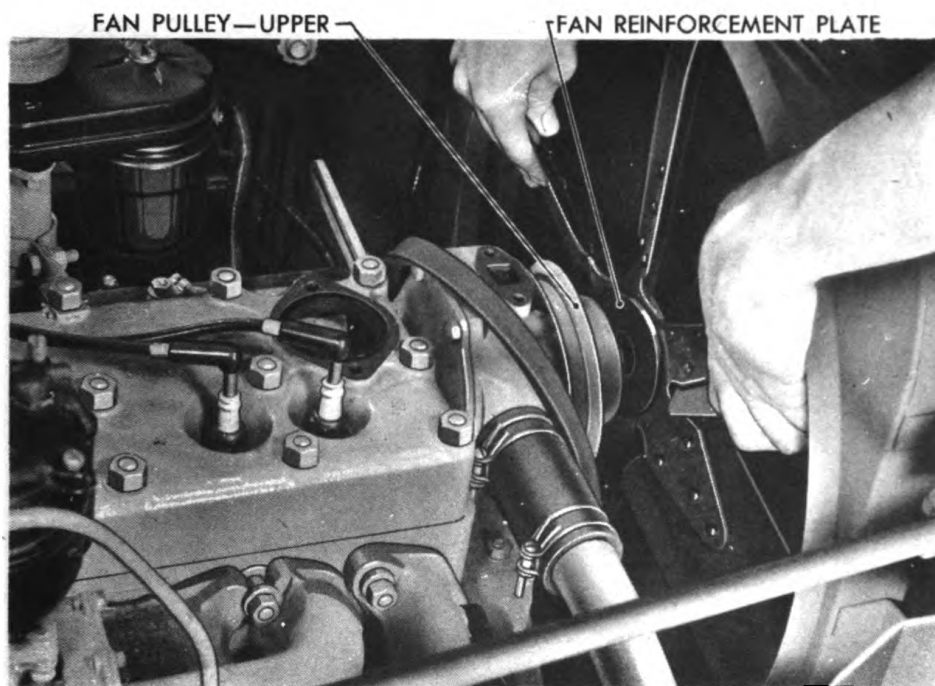
**ENGINE REPAIRS (ENGINE IN VEHICLE)**

RA PD 53320

**Figure 34—Fan Installation**

the cylinder block. Install the studs with two nuts locked on them and turn the outer nuts clockwise until studs are tight in block. Loosen and remove the nuts from the studs and reinstall one nut with lock washer on each stud.

**q. Install Water Pump and Fan (Vehicles with Fan Shroud) (fig. 34).** Install the pump with a new gasket, on the attaching studs. Install the stud nuts with lock washers. Attach the fan pulley and fan to the water pump with fan reinforcement plate toward pulley, install cap screws and lock washers and tighten securely.

**r. Install Cylinder Head Water Outlet Elbow and Bypass Elbow Assembly (fig. 35).** If the thermostat has been removed, install with mark FRONT nearest radiator, with gaskets above and below thermostat (fig. 35). Place the cylinder head water outlet elbow and bypass elbow assembly over the head and pump openings. Install the cap screws with lock washers to attach the outlet elbow and the cap screws with lock washers to attach the bypass elbow.

**s. Connect and Adjust Fan Belt (fig. 36).** Attach the generator adjusting strap to the water pump stud and to the generator, but do not tighten connections. Place the fan belt over the crankshaft fan drive pulley and generator pulley. Pivot the generator away from the engine by hand until the fan belt is taut with less than  $\frac{1}{2}$  inch slack. Tighten the adjusting strap and mounting bolts.



**ORDNANCE MAINTENANCE—POWER PLANT, CLUTCH, AND ELECTRICAL SYSTEM— $\frac{3}{4}$  AND  $1\frac{1}{2}$  TON VEHICLES (DODGE)**

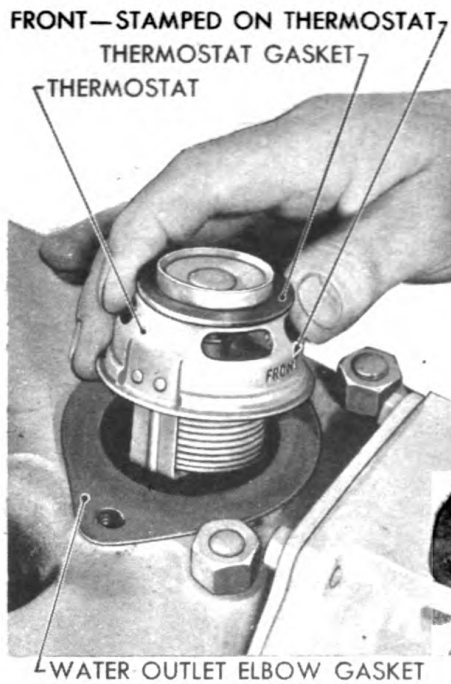

RA PD 53274

**Figure 35—Thermostat Installation**

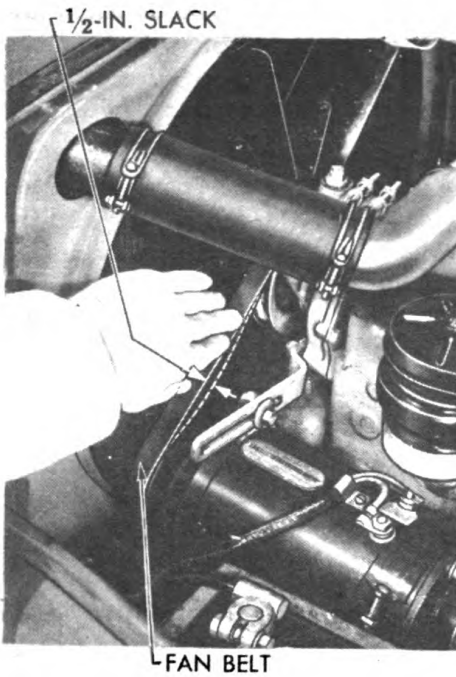

RA PD 53257

**Figure 36—Fan Belt Adjustment**

**ENGINE REPAIRS (ENGINE IN VEHICLE)**

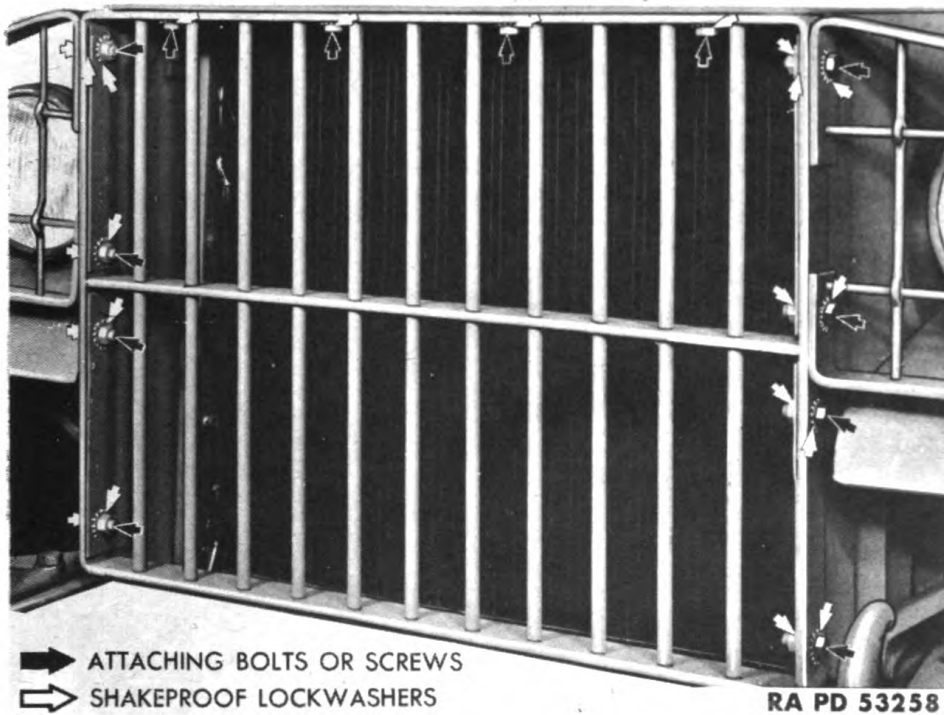

**Figure 37—Radiator Guard Mounting**

**OIL PAN FRONT END OIL SEAL PLATE FASTENING SCREWS**

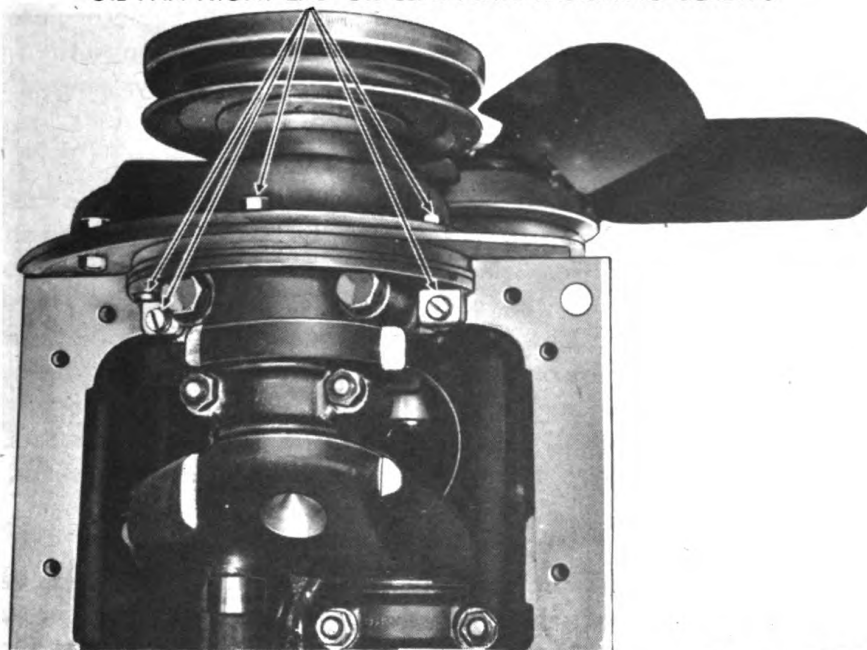

**Figure 38—Oil Pan Front End Oil Seal Plate Fastening Screws**

729923 O - 47 - 5

ORDNANCE MAINTENANCE—POWER PLANT, CLUTCH, AND  
ELECTRICAL SYSTEM— $\frac{3}{4}$  AND  $1\frac{1}{2}$  TON VEHICLES (DODGE)

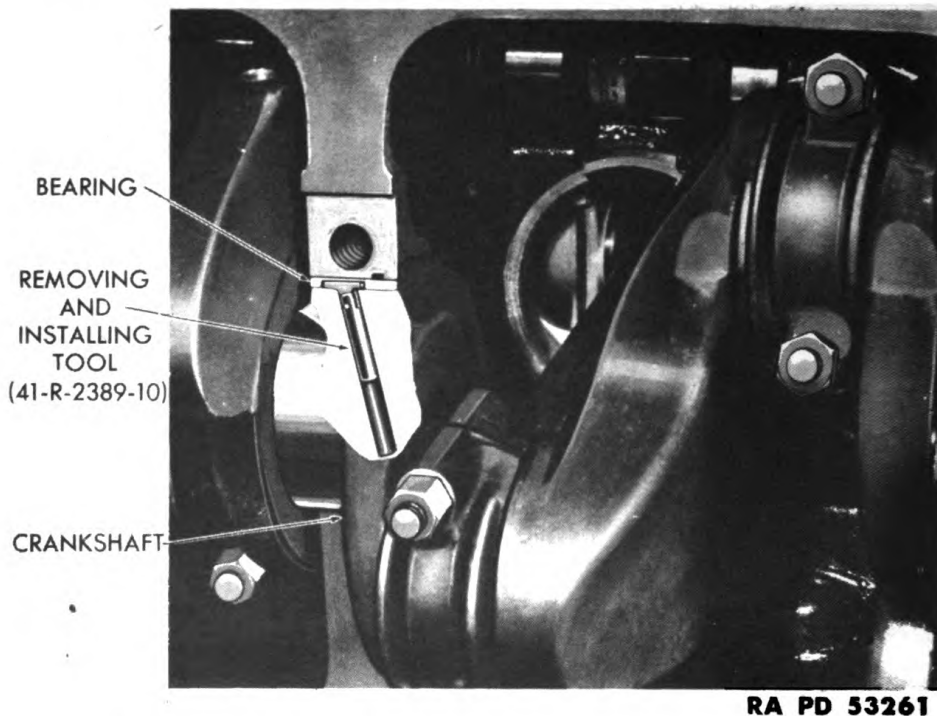

**Figure 39—Upper Crankshaft Bearing Removal**

t. **Connect and Fill Radiator.** Install the upper radiator hose and tighten the hose clamps securely. Connect the lower hose to the pump opening and tighten the hose clamp. Refill the cooling system with the required coolant.

u. **Install Hood** (par. 75 h).

v. **Install Radiator Guard** (fig. 37). Attach the top of the radiator guard to the top of the radiator support with the cap screws and shakeproof lock washers. Spread the space between the guard and support and insert a shakeproof lock washer on each side of the guard between the guard and support. Line up the washers with the bolt holes. Install shakeproof lock washers on each of the guard side attaching bolts. Insert the upper bolts through the head lamp guard, the support and the radiator guard and install shakeproof lock washers with the nuts. Install the remaining bolts and nuts with shakeproof lock washers.

### 31. CRANKSHAFT BEARING REPLACEMENT.

a. **Remove Crankshaft Bearings** (figs. 38 and 39). Remove engine oil pan (par. 28 a). Remove oil pump outlet pipe and screw the oil strainer and suction pipe out of the block. Remove the two lower chain case cover cap screws which enter the oil pan front end oil seal plate and three screws which hold the plate to the block (fig. 38). Mark

**ENGINE REPAIRS (ENGINE IN VEHICLE)**

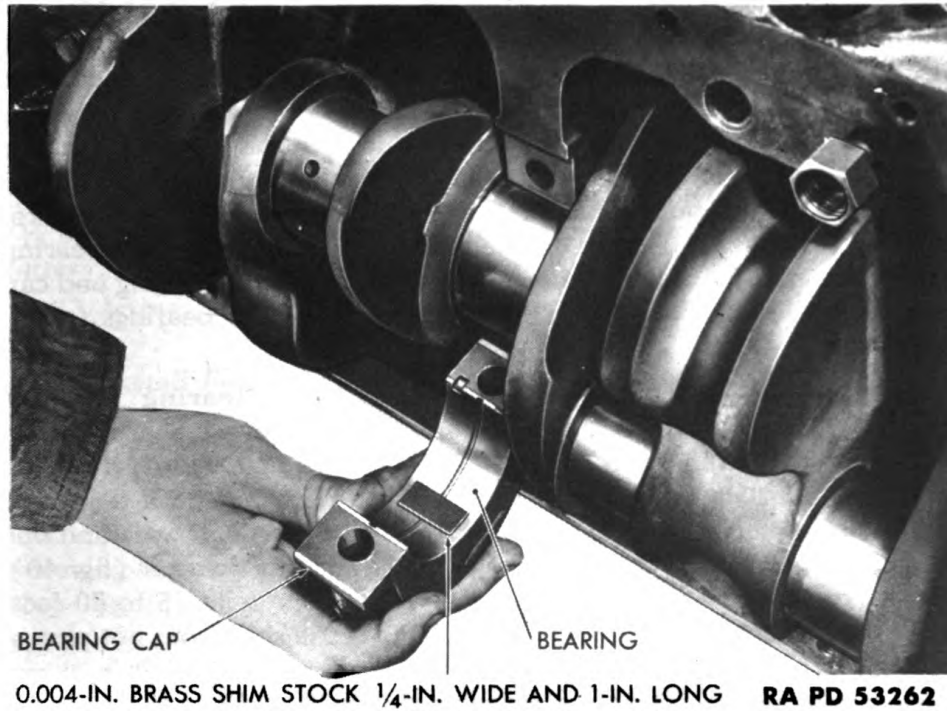

BEARING CAP

BEARING

0.004-IN. BRASS SHIM STOCK 1/4-IN. WIDE AND 1-IN. LONG RA PD 53262

**Figure 40—Checking Crankshaft Bearing Clearance**

CRANKSHAFT BEARING—FRONT—UPPER

CRANKSHAFT BEARING—REAR—UPPER

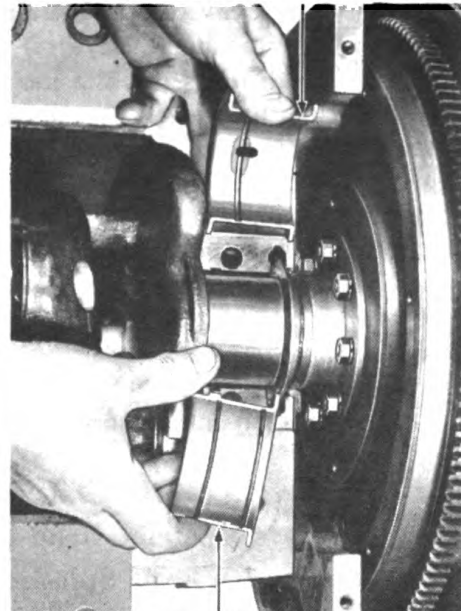
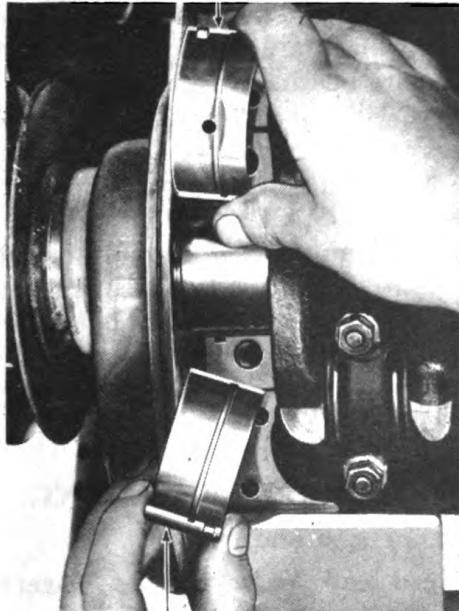

CRANKSHAFT BEARING—FRONT—LOWER

CRANKSHAFT BEARING—REAR—LOWER

RA PD 53263

**Figure 41—Crankshaft Front and Rear Bearings**

**ORDNANCE MAINTENANCE—POWER PLANT, CLUTCH, AND ELECTRICAL SYSTEM— $\frac{3}{4}$  AND  $1\frac{1}{2}$  TON VEHICLES (DODGE)**

the bearing caps and the cylinder block so that the caps can be installed in their original position. The center bearing caps are machined with a slight offset and damage will result if they are installed in the wrong position. Remove the front bearing cap and turn the crankshaft in the direction it runs to remove the upper half of the bearing. If the upper half of the bearing does not rotate freely with the crankshaft, use removing tool (fig. 39) or an old bearing shell. After the front bearing and crankshaft journal have been inspected, install the bearing and cap to hold the crankshaft in line and remove the other bearings for inspection.

**b. Inspect Bearings and Crankshaft Main Bearing Journals** (fig. 40). Examine the bearing for scores or cracks in the bearing metal and inspect the crankshaft journals for scores or roughness. If the bearings and journals are smooth and in no way damaged, oil a journal and place a piece of 0.004 inch brass shim stock  $\frac{1}{4}$  inch wide and one inch long lengthwise between the bearing and the journal (fig. 40). Install the bearing cap and tighten the cap bolt nuts to 75 to 80 foot-pounds with torque wrench (41-W-3630). If the shim does not almost lock the crankshaft when it is moved, the bearing clearance is in excess of the maximum allowable clearance of 0.0035 inch. If the bearings are scored or damaged or if the bearing clearance exceeds 0.0035 inch, replace the bearings. If the crankshaft journals are scored or damaged, rebuild the engine assembly.

**c. Install Crankshaft Bearings** (fig. 41). The upper half of the front and rear bearings have oil holes while the lower halves do not (fig. 41). Both halves of the intermediate bearings are the same. Install the upper halves of the new bearings with special replacer (fig. 39). Install the lower halves of the bearings and bearing caps. Use new cap gaskets and oil seal at rear bearing. Tighten the bearing cap screws to 75 to 80 foot-pounds with torque wrench (41-W-3630). Screw oil suction pipe and strainer into the block and connect the oil pump outlet pipe. Place oil pan front end oil seal plate in position and install three screws which hold it to the crankcase. Install the two lower chain case cover cap screws which enter the oil pan front end oil seal plate. Install engine oil pan (par. 52 n) and fill engine with proper grade of engine oil, depending on the season of the year.

**32. VALVE TAPPET ADJUSTING SCREW REPLACEMENT.**

- a. Remove Cylinder Head** (par. 27 a, b and c).
- b. Remove Wheel, Splash Shield and Valve Spring Covers** (par. 27 d and e).
- c. Remove Valves, Valve Springs and Tappet Screws.** Remove valves and springs (par. 27 f) and screw the adjusting screws out of the tappets.

**ENGINE REPAIRS (ENGINE IN VEHICLE)**

- d. **Install Tappet Screws, Valve Springs and Valves.** Screw the tappet screws into the tappets far enough to allow the valves to rest on their seats. Install the valve springs and valves (par. 27 k).
- e. **Install Cylinder Head and Attaching Parts** (par. 27 l and m).
- f. **Fill Radiator and Connect Battery Cable.** Close the drain cock at the lower front corner of the radiator and fill the radiator to within 2¼ inches of the top of the filler tube. Connect the battery cable to the battery.
- g. **Adjust Valve Tappets and Install Spring Covers** (par. 27 o and p).
- h. **Install Fender Splash Shield and Wheel** (par. 27 q).

**33. FLYWHEEL ASSEMBLY REPLACEMENT.**

- a. **Remove Transmission and Clutch** (pars, 36, and 38 b).
- b. **Remove Dust Seal and Plate.** Remove the dust seal plate by removing the attaching cap screws.
- c. **Remove Flywheel.** Remove the nuts and attaching bolts and pull the flywheel.
- d. **Install Flywheel.** Place the flywheel against the crankshaft flange. Install the bolts and nuts with lock washers. Tighten all bolt nuts securely.
- e. **Install Clutch Dust Seal and Plate.** Attach the clutch housing dust seal and plate assembly to the clutch housing, with the cap screws and lock washers.
- f. **Install Clutch and Transmission** (pars. 53 h, and 74).

**34. CLUTCH ASSEMBLY REPLACEMENT.**

- a. **Remove Transmission** (par. 36).
- b. **Remove Clutch** (par. 38 b).
- c. **Repair Clutch** (pars. 69, 70 and 71).
- d. **Install Clutch** (par. 53 h).
- e. **Install Transmission** (par. 74).

**ORDNANCE MAINTENANCE—POWER PLANT, CLUTCH, AND ELECTRICAL SYSTEM— $\frac{3}{4}$  AND 1  $\frac{1}{2}$  TON VEHICLES (DODGE)**

**CHAPTER 2**

**ENGINE AND CLUTCH (Cont'd)**

**Section IV**

**REMOVAL OF ENGINE FROM TRUCK**

	Paragraph
Removal of front fender and radiator assembly . . . . .	35
Removal of transmission assembly . . . . .	36
Removal of engine assembly . . . . .	37

**35. REMOVAL OF FRONT FENDER AND RADIATOR ASSEMBLY.**

a. **Drain Radiator and Remove Hood.** Drain the radiator. Remove the two screws from hood hinge front support. Remove the support and tapping plate from hood hinge. Disconnect the hood to dash ground strap at the dash. Slide the hood forward out of the rear support and remove it from the vehicle.

b. **Disconnect Radiator Hose and Remove Tie Rods.** Loosen the upper radiator hose clamp at the cylinder head water outlet elbow and the lower radiator hose clamp at the water pump. Remove the nuts and bolts that attach the tie rods to the radiator shell. Loosen the lock nuts at the front of the cowl bracket. Hold the rear nuts located in the brackets and turn the tie rods out of the nuts. On 1  $\frac{1}{2}$  ton, 6 x 6 vehicles disconnect overflow tank pipe at radiator.

c. **Remove Battery (6-volt trucks only).** Loosen terminal bolt nuts and remove terminals from battery. Remove the two hold-down clamp bolt nuts and lift out the battery.

d. **Disconnect Battery (12-volt trucks only).** Remove the cap screws that hold battery cover in place and swing cover open. Loosen positive terminal nut and remove the terminal from the battery.

e. **Disconnect Generator and Regulator Wiring.** Disconnect the generator to regulator wiring at the generator. Disconnect the cable holding clip at generator. Pry open the cable holding clip at dash. Disconnect the two wires of the generator to regulator wiring assembly at the regulator and also remove the wiring to regulator holding clip screw. Leave the generator to regulator wiring assembly attached to left front fender splash shield.

f. **Disconnect Lamp Wiring and Ground Strap.** Pull the black-out lamp wires from their sockets near the terminal blocks on each side

**REMOVAL OF ENGINE FROM TRUCK**

of the front cross member. Remove the nuts attaching the lamp wires to the terminal blocks. Open the clips holding the cables to the cross member and remove the cables from the clips. Remove the screw from the frame side member attaching the ground strap at the front of the left fender splash shield. Remove the nut from the bolt attaching the battery tray to fender splash shield ground strap at the splash shield and disconnect the strap.

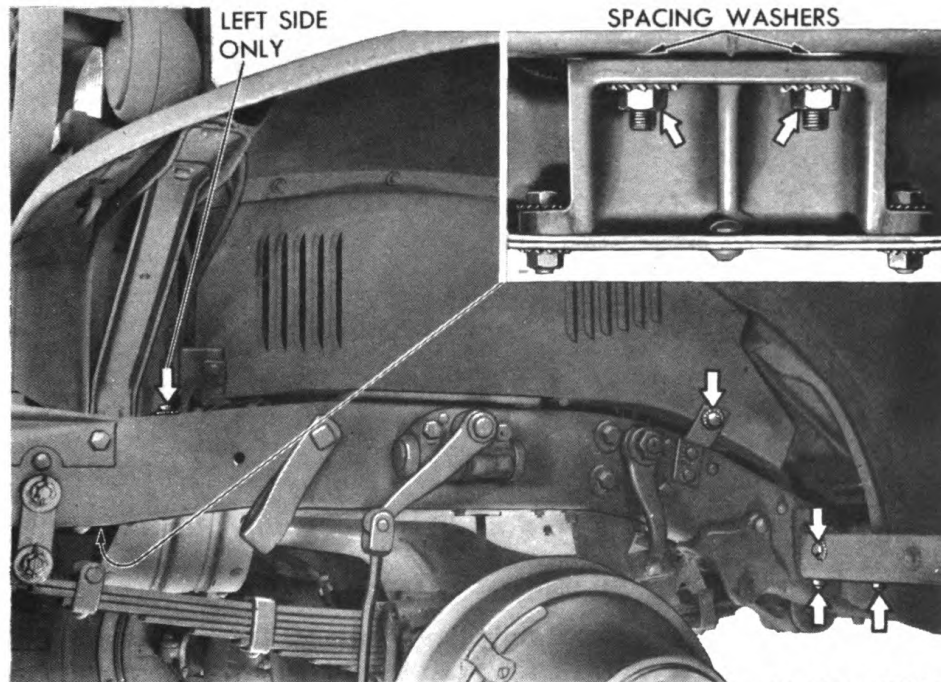

RA PD 53318

**Figure 42—Fender and Radiator Assembly Fastening Screws**

g. **Remove Front Fender and Radiator Assembly** (figs. 42 and 43). Remove the screws attaching the left and right front fender splash shield to frame rear brackets. Remove the six screws that attach the front fender rear supports to the front fender rear support brackets. If the truck is equipped with six volt electrical system, remove the three bolts that attach the battery tray to frame and remove the tray. Remove the two nuts attaching the radiator shell assembly to the front cross member. Attach a chain fall to the radiator, shell, and fender assembly and lift it off the vehicle (fig. 43). Have a helper at the rear of each fender to assist in guiding the assembly while it is being removed. If there are any spacing washers (fig. 42) between the radiator support and front cross member, note their location and save them in order to return them to their original positions for proper alignment of the hood when installing the assembly.



**ORDNANCE MAINTENANCE—POWER PLANT, CLUTCH, AND ELECTRICAL SYSTEM— $\frac{3}{4}$  AND  $1\frac{1}{2}$  TON VEHICLES (DODGE)**

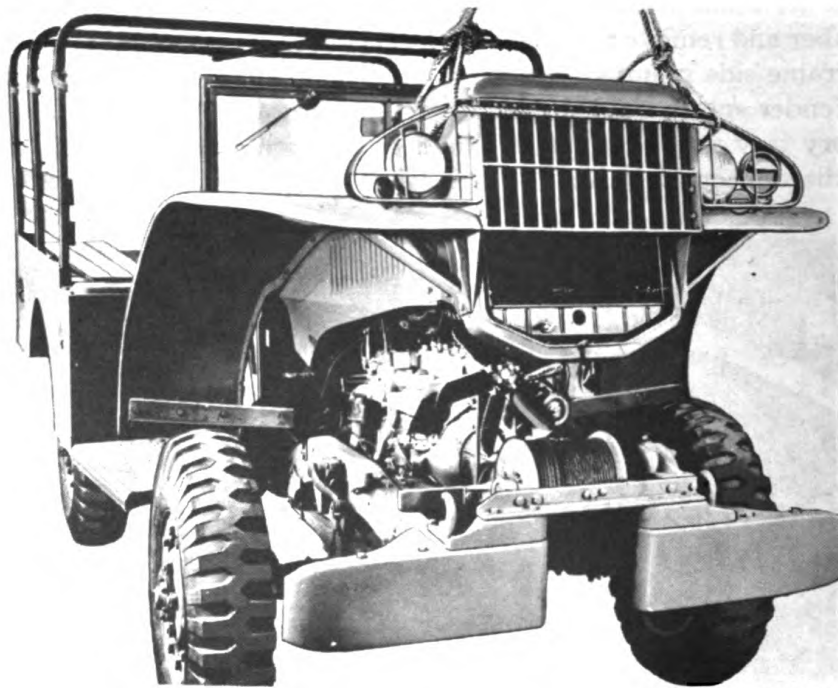

RA PD 53266

**Figure 43—Fender and Radiator Assembly Removal**

**36. REMOVAL OF TRANSMISSION ASSEMBLY.**

a. **Remove Floor Mat (ambulance only).** Tilt the attendant's seat forward and remove the four cap screws from the seat support bracket. Raise the driver's seat to its highest position and tilt forward. Remove the seat adjusting mechanism to floor cap screws. Remove the cotter pin and pin from the accelerator pedal at the accelerator pedal rod. Remove the screws from floor mat front section. Remove the mat. Remove the screws from the center and two end linoleum retainer angles. Remove the screws from the mat extension and remove the extension.

b. **Remove Floor Plates.** Remove the spare tire lock. Remove the spare wheel and tire assembly from the carrier (except ambulance). Remove the clutch and brake pedal draft pad retainers. Remove the left floor plate screws and the plate. Unhook the throttle control spring from the throttle bell crank rod at right floor plate. Remove the right floor plate screws and the plate.

c. **Remove Floor Center Panel.** Remove the floor center panel cap screws. Remove the cotter pin and pin from the pedal where it is attached to the accelerator rod and disconnect the pedal from the rod. If the vehicle is equipped with a power take-off, remove the cotter pin from the clevis pin in the control lever end plate. Lift the center panel

**REMOVAL OF ENGINE FROM TRUCK**

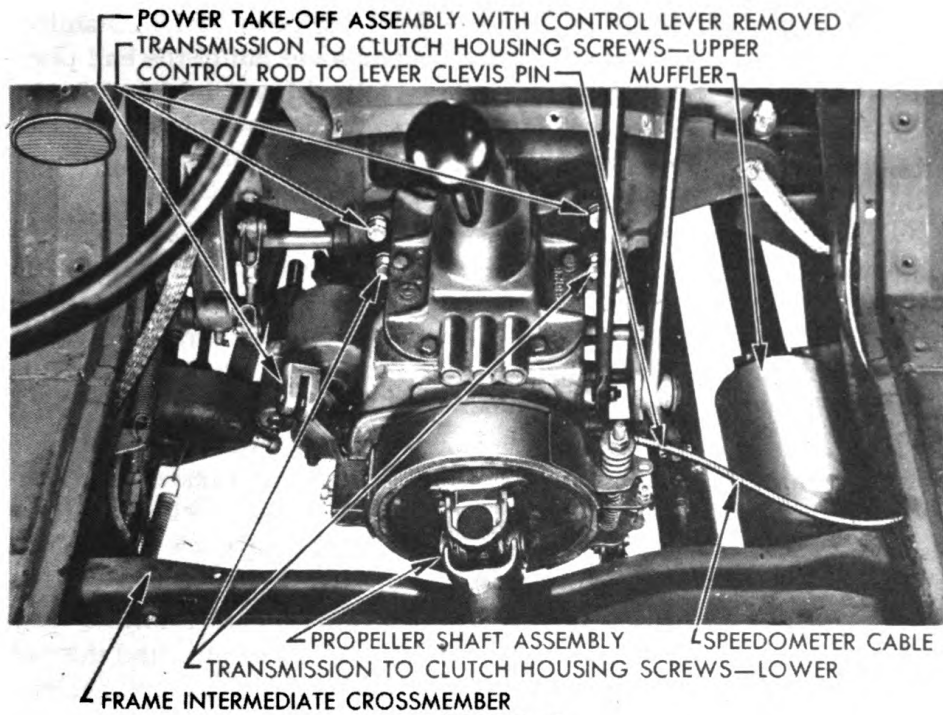

**Figure 44—Transmission Removal**

**ORDNANCE MAINTENANCE—POWER PLANT, CLUTCH, AND ELECTRICAL SYSTEM— $\frac{3}{4}$  AND  $1\frac{1}{2}$  TON VEHICLES (DODGE)**

and remove the cotter pin and washer from the power take-off shifter shaft eyebolt and pin. Then move the control lever out of the end plate yoke and remove the lever from the vehicle. Move the hand brake lever and transfer case control levers back so they will not interfere with the removal of the floor panel and lift the panel out of the vehicle.

d. **Disconnect Power Take-Off** (if so equipped) (fig. 44). Remove the lock wire and loosen the set screw that holds the drive shaft collar ahead of the rear universal joint of the winch propeller shaft. Remove the lock wire and loosen the set screw that holds the rear universal joint on the power take-off drive shaft. Slide the rear universal joint forward on the winch propeller shaft to disengage the joint from the shaft and lower the shaft under the vehicle.

e. **Disconnect Transfer Case Control Rods, Hand Brake Cable and Speedometer Cable** (fig. 44). Disconnect the transfer case control rods at the transmission end. On the  $1\frac{1}{2}$  ton, 6 x 6 vehicle, disconnect both ends of the hand brake cable. On the  $\frac{3}{4}$  ton, 4 x 4 vehicle, disconnect the speedometer cable housing from the transmission.

f. **Loosen and Move Intermediate Frame Cross Member** (except ambulance) (fig. 44). Remove the two bolts and nuts and the two cap screws that attach the rear gusset to the frame cross member and left frame side member. Remove the two cross member to front gusset cap screws. Remove the two bolts and nuts that attach the cross member to the upper flange of the left and right side members. Remove the two large bolts and nuts from cross member to right side member. Move the cross member toward the rear of truck as far as it will go.

g. **Disconnect Propeller Shaft** (fig. 44). Open the universal joint clamp bolt lock nuts and remove the nuts. Remove the bolts and bolt locks, then the universal joint clamps. Slide the splined yoke on the shaft as far as it will go to disengage it from the transmission.

h. **Remove Transmission** (fig. 44). Remove the two upper transmission to clutch housing cap screws and screw pilot studs in place of the cap screws to guide the transmission while removing it. Pilot studs can be made by sawing the heads from  $\frac{5}{16}$ -inch 12 x  $1\frac{3}{4}$ -inch cap screws and slotting the ends for a screwdriver. Remove the two lower transmission attaching cap screws. Place a jack under the transmission to support it and move it towards the rear until the main drive pinion is released from the clutch disk. Then lower the transmission to the floor and remove it from under the vehicle.

**37. REMOVAL OF ENGINE ASSEMBLY.**

- a. **Remove Front Fender and Radiator Assembly** (par. 35).
- b. **Remove Transmission Assembly** (par. 36).
- c. **Disconnect Distributor and Starter Switch Wiring.** Disconnect the coil to distributor wire at the distributor. Pull the high-tension

**REMOVAL OF ENGINE FROM TRUCK**

wire out of the distributor cap socket. Remove the terminal nut attaching the wires to the starter switch and remove the wires.

**d. Disconnect Oil Gage, Thermometer and Starter Pedal.** Disconnect the oil gage tube at the flexible hose connections. Spread the thermometer tube clip at the rear of the cylinder head and unscrew the thermometer gland nut from the cylinder head. Move the tube against the dash out of the way to prevent damage. Pry off the clip that retains the pin in the starter shift lever yoke and remove the pin to release the pedal rod.

**e. Remove Horn and Carburetor Air Cleaner.** Disconnect the horn wires at the horn. Remove the horn to bracket attaching nuts and remove the horn. Remove the wing nut from the carburetor air cleaner and remove the air cleaner filter element and cover assembly. Remove the oil reservoir. Remove the air cleaner body by removing the four body to elbow attaching screws. Remove the nut from the stud that holds the air cleaner elbow support bracket to the elbow and the screw that attaches to the manifold. Remove the nuts from the elbow attaching studs and slide the elbow away from the carburetor.

**f. Disconnect Fuel Line at Pump; Throttle and Choke Controls; Windshield Wiper Hose.** Disconnect the flexible fuel pump hose at the fuel pump. Disconnect the throttle bell crank at the manifold. Loosen the screws and disconnect the choke wire and guide at the carburetor. Pull the windshield wiper hose from the manifold tube.

**g. Disconnect Exhaust Pipe.** Remove the two nuts from each of the bolts that attach the exhaust pipe to the manifold; remove the bolts and disconnect the parts.

**h. Disconnect Ground Straps.** Remove the cap screw attaching the engine to dash ground strap at the rear of the cylinder head. Remove the screw attaching the ground strap to the right side of clutch housing and disconnect the strap. Remove the screw attaching the ground strap to the left side of clutch housing.

**i. Remove Clutch Pedal and Bracket and Brake Pedal and Bracket Assemblies.** Remove the cotter pin from the clutch operating rod pin. Remove the screws from the clutch bracket that attach it to the clutch housing. Disconnect the clutch pedal pull-back spring from the frame bracket with spring pliers (41-P-1579) and remove the assembly from the truck. Remove the rear end of the brake pull-back spring from the pull rod spring frame bracket and unhook the spring from the pedal extension. Remove the cotter pin from the master cylinder push rod end pin and remove the pin. Remove the four bolts that attach the brake pedal bracket to the frame. Pull the brake pedal loose from the push rod and remove the brake pedal and bracket assembly.

**j. Remove Right Engine Dust Pan.** Remove the torque arrester attached to underside of the frame side member. Open the fender lamp cable clip at the screw attaching the pan to the front cross member and

TM 9-1808A

37

**ORDNANCE MAINTENANCE—POWER PLANT, CLUTCH, AND ELECTRICAL SYSTEM— $\frac{3}{4}$  AND  $1\frac{1}{2}$  TON VEHICLES (DODGE)**

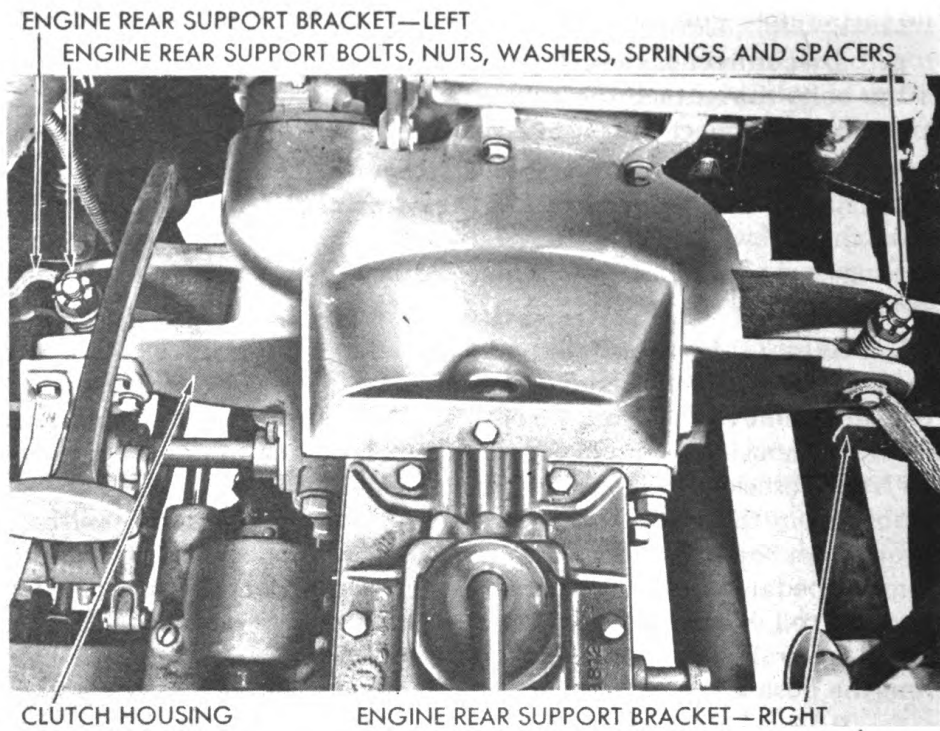
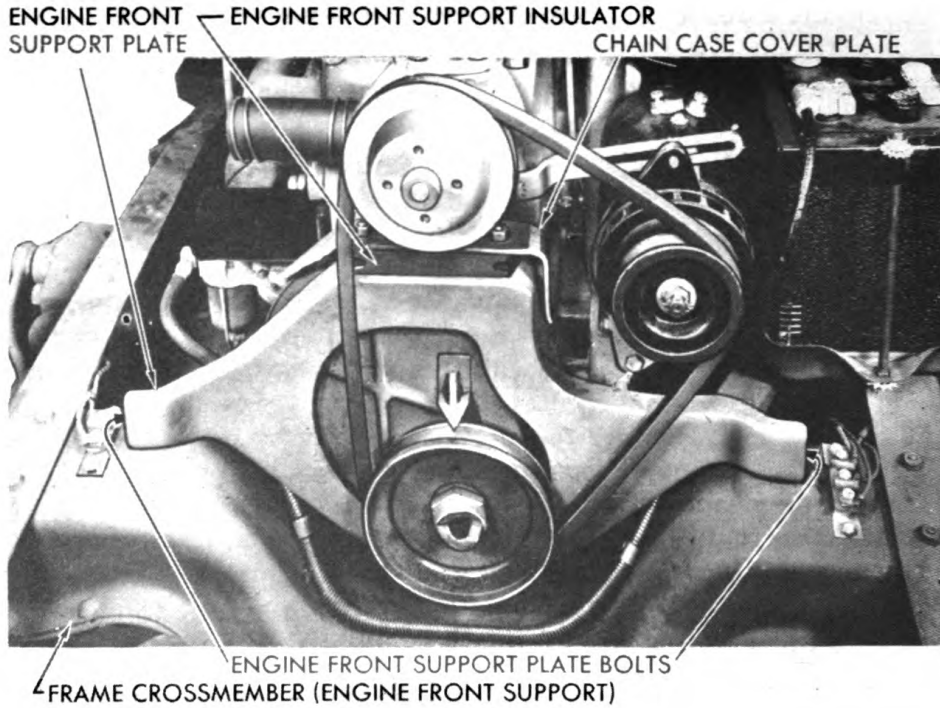

RA PD 53268

**Figure 45—Engine Supports**

**REMOVAL OF ENGINE FROM TRUCK**

move cable out of the way. Remove the clip screw and the other two attaching screws.

**k. Remove Engine from Frame (fig. 45).** Lift the engine slightly to relieve the pressure on the support bolts. Remove the cotter pins from the rear engine support bolts and remove the nuts, washers, springs, spacers, and the bolts. Remove the front engine support plate bolts. Lift the engine out of the truck carefully to prevent damaging the attaching parts and accessories.

**ORDNANCE MAINTENANCE—POWER PLANT, CLUTCH, AND ELECTRICAL SYSTEM— $\frac{3}{4}$  AND  $1\frac{1}{2}$  TON VEHICLES (DODGE)**

**CHAPTER 2**

**ENGINE AND CLUTCH (Cont'd)**

**Section V**

**DISASSEMBLY OF ENGINE**

	<b>Paragraph</b>
Removal of engine accessories (engine removed) . . . . .	38
Disassembly of stripped engine . . . . .	39

**38. REMOVAL OF ENGINE ACCESSORIES (ENGINE REMOVED).**

a. **Remove Carburetor and Governor Assembly (fig. 46).** Disconnect the fuel tube at the carburetor connection. Disconnect the carburetor control rod from the carburetor throttle lever. Remove the carburetor attaching stud nuts and remove the carburetor.

b. **Remove Clutch Assembly (figs. 46 and 47).** Remove the clutch housing pan and detach the clutch pull-back spring. Move the release bearing and sleeve off the release fork and remove it through the transmission attaching opening. Remove the screws that attach the clutch over to the flywheel, then remove the cover assembly and the clutch disk.

c. **Remove Starter (fig. 47).** Remove the attaching cap screws and pull starter out of engine clutch housing.

d. **Remove Generator (fig. 47).** Remove the two nuts and bolts that attach the generator to the generator mounting bracket.

e. **Remove Ignition Units (fig. 47).** Remove the spark plug cables from the spark plugs. Remove the spark plugs. Remove the nut from the cylinder head stud that attaches the cable tube and mounting bracket and remove the bracket from the stud. Release the distributor cap springs and remove the distributor cap and spark plug cables. Remove the cap screw that holds the distributor lock plate to the cylinder block, and pull the distributor assembly out of the block.

f. **Clean Engine Assembly.** Thoroughly wash the engine exterior with dry-cleaning solvent, and dry with compressed air.

g. **Remove Fuel Pump (fig. 46).** Remove the wing nut which holds the heat shield to the fuel pump. Loosen the exhaust manifold stud nut that attaches the end of the shield and slide the shield from the stud. Remove the shield from the pump. Disconnect the fuel pump

DISASSEMBLY OF ENGINE

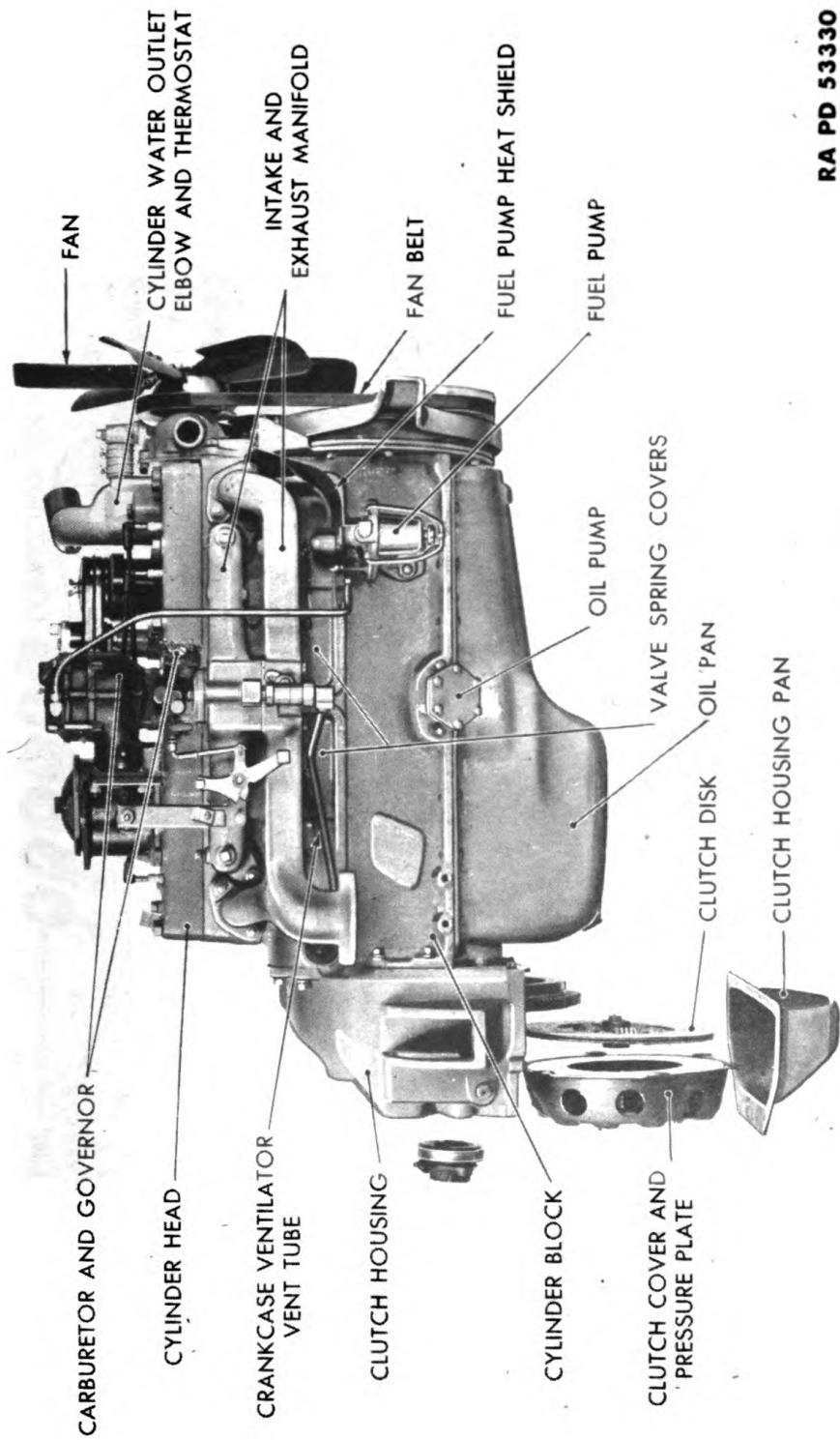

RA PD 53330

Figure 46—Right Side View of Engine



ORDNANCE MAINTENANCE—POWER PLANT, CLUTCH, AND ELECTRICAL SYSTEM— $\frac{3}{4}$  AND  $1\frac{1}{2}$  TON VEHICLES (DODGE)

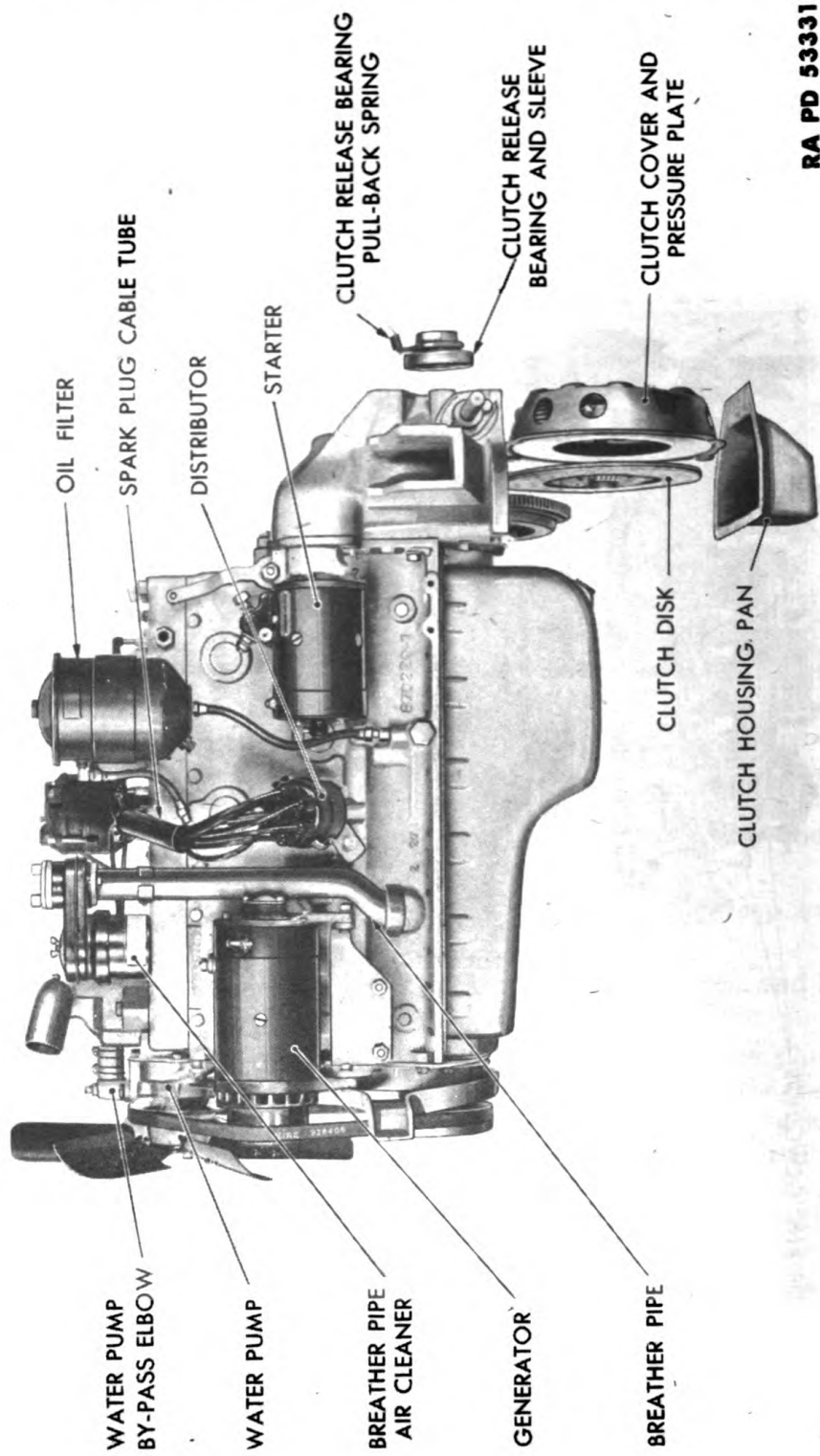

RA PD 53331

Figure 47—Left Side View of Engine

DISASSEMBLY OF ENGINE

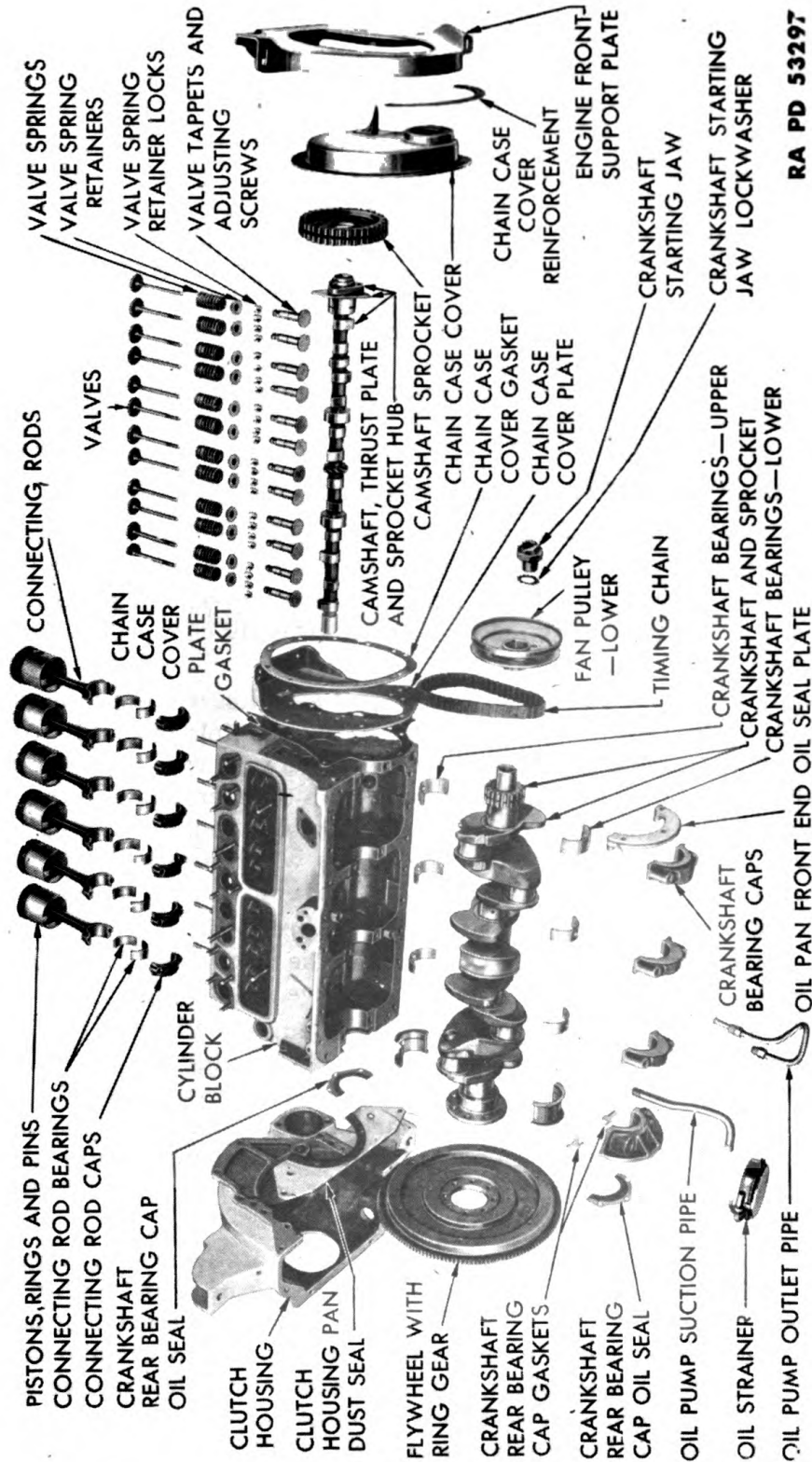

RA PD 53297

Figure 48—Stripped Engine Disassembled

**TM 9-1808A**  
**38-39**

**ORDNANCE MAINTENANCE—POWER PLANT, CLUTCH, AND ELECTRICAL SYSTEM— $\frac{3}{4}$  AND  $1\frac{1}{2}$  TON VEHICLES (DODGE)**

to carburetor tube at the pump. Remove the two attaching cap screws and remove the pump.

**h. Remove Oil Pump.** Remove the two oil pump attaching cap screws and pull the pump out of the cylinder block.

**i. Remove Water Pump and Water Distributing Tube.** Remove the two attaching cap screws and disconnect the bypass elbow. Loosen the generator adjusting strap at the generator adjusting screw. Remove the nuts from the three pump attaching studs and remove the pump (fig. 47). Pull the water distributing tube out of the block. If the tube is corroded or damaged by removal, install a new tube when the engine is assembled. Remove the cylinder head elbow and thermostat. Then temporarily install the elbow and pump and reverse flush the cylinder block (par. 26).

**39. DISASSEMBLY OF STRIPPED ENGINE.**

**a. Remove Oil Pan (fig. 46) and Mount Engine in Stand.** Drain oil from engine and remove oil pan. Remove oil pan gaskets and thoroughly clean the oil pan. Mount the engine in an engine stand so that the oil pan flange of the crankcase can be securely clamped to the engine stand.

**b. Remove Manifold Assembly and Crankcase Ventilator (fig. 46).** Remove the stud nuts which attach the manifold assembly to the block. If the engine is equipped with positive type crankcase ventilator, disconnect the ventilator vent tube from the manifold and remove the manifold. If the engine is equipped with outlet pipe and air cleaner type of ventilator, remove the cap screws which attach the bracket and cleaner to the cylinder block and remove the ventilator assembly.

**c. Remove Thermostat and Oil Pressure Relief Valve (fig. 46).** Remove the water outlet elbow and lift out the thermostat. Remove the oil pressure relief valve cap, spring and valve.

**d. Remove Oil Filter, Breather Pipe and Air Cleaner (fig. 47).** Remove cylinder head stud nut which holds breather pipe bracket in place and drive the pipe out of the crankcase by tapping the under side of the bracket with a hammer. Disconnect the oil filter outlet and inlet tubes from the crankcase. Remove two cylinder head stud nuts which hold the oil filter bracket to the cylinder head and remove the oil filter and tubes.

**e. Remove Cylinder Head and Valves (figs. 48 and 49).** Remove the cylinder head stud nuts and cap screw and lift the cylinder head and gasket from the cylinder block. Clean carbon from the cylinder head, block and piston heads. Remove the valve spring covers and cover studs from the cylinder block. Turn engine until the front valve is all the way down on its seat and insert jaws of valve lifter (fig. 49) between the lower end of the valve spring and the cylinder block, with

**DISASSEMBLY OF ENGINE**

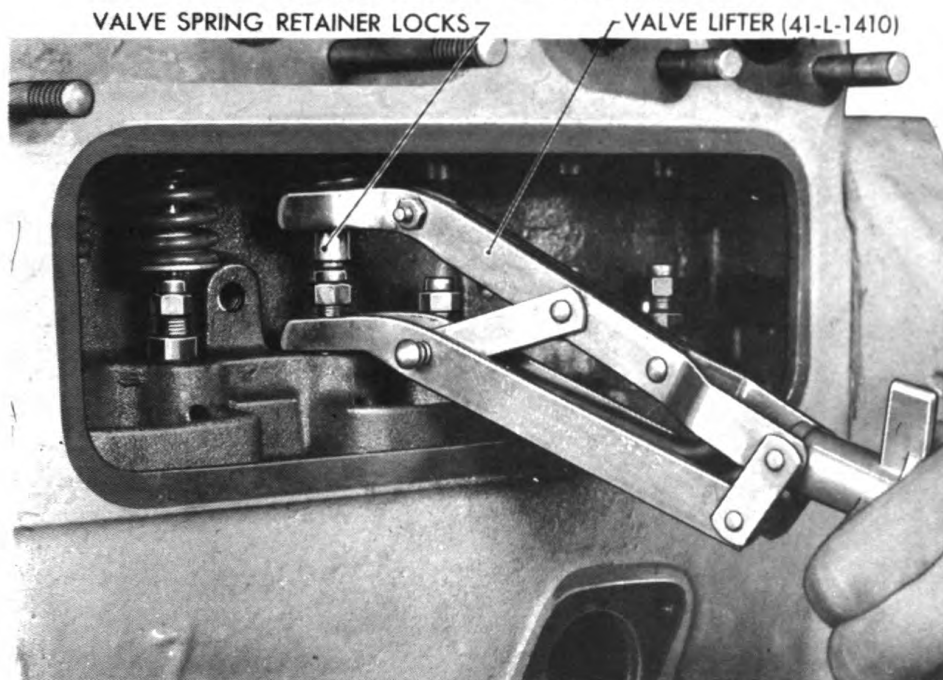

RA PD 53321

**Figure 49—Valve Spring Removal**

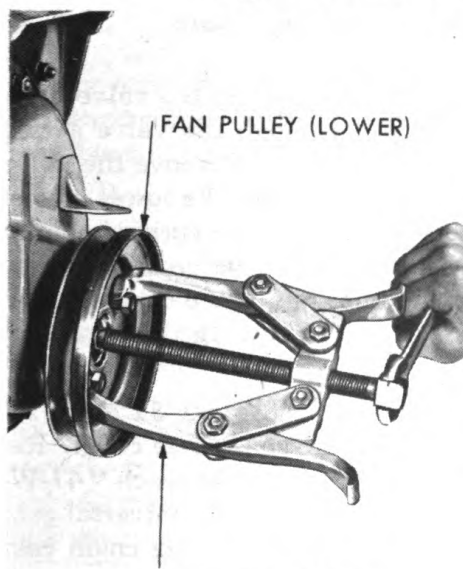

UNIVERSAL TYPE PULLER  
(41-P-2911)

RA PD 53328

**Figure 50—Lower Fan  
Pulley Removal**

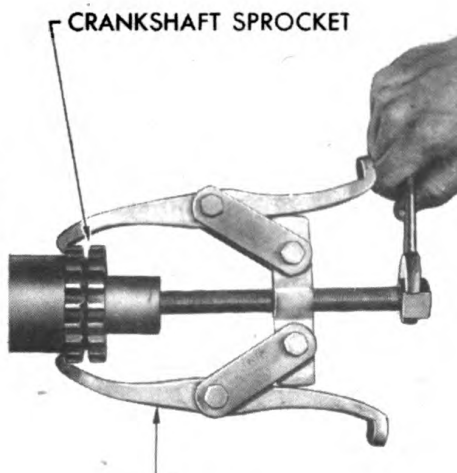

UNIVERSAL TYPE PULLER  
(41-P-2911)

RA PD 53329

**Figure 51—Crankshaft  
Sprocket Removal**

**ORDNANCE MAINTENANCE—POWER PLANT, CLUTCH, AND ELECTRICAL SYSTEM— $\frac{3}{4}$  AND  $1\frac{1}{2}$  TON VEHICLES (DODGE)**

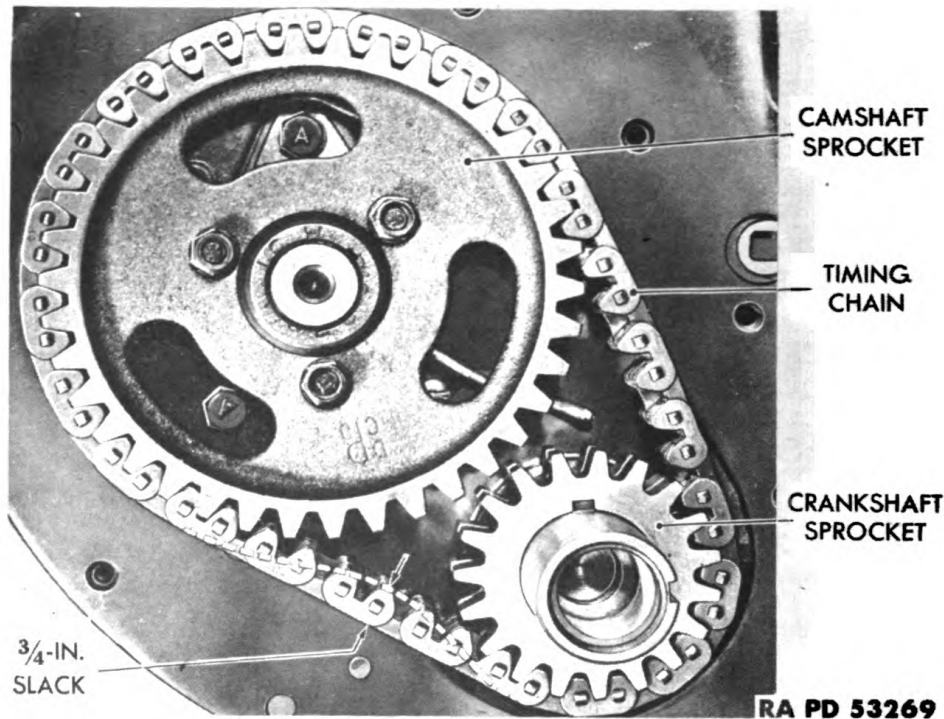

**Figure 52—Testing Slack in Timing Chain**

the cupped jaw up. Hold the valve down and screw up the valve lifter until the valve spring is fully compressed. Remove the valve spring retainer locks from the lower end of the valve stem. Remove the valve lifter and lift the valve out of the valve guide. Raise the lower end of the valve spring above the tappet screw and pull the spring retainer and spring out between the tappet screw and the valve stem guide. Remove all valves and springs in this manner and place the valves in board or other device so that they can be identified with the port from which they were removed.

**f. Remove Timing Chain and Sprockets (figs. 50, 51 and 52).** Remove the engine front support plate from the chain case cover. Remove the starting crank jaw with  $1\frac{1}{16}$ -inch socket wrench (41-W-2620) and pull the fan pulley from the crankshaft, using universal gear puller and two  $\frac{3}{8}$ -inch cap screws (fig. 50). Remove the chain case cover. Turn the crankshaft clockwise so that the top span of the chain is tight. If the amount of slack in the lower span is greater than  $\frac{3}{4}$  inch (fig. 52), replace the chain. If sprockets are noticeably worn, replace the sprockets (fig. 51). Remove the camshaft sprocket and chain. Remove the chain case cover plate and gasket.

**g. Remove Piston and Connecting Rod Assemblies (fig. 48).** Remove the oil strainer assembly from oil pump inlet pipe and unscrew

## DISASSEMBLY OF ENGINE

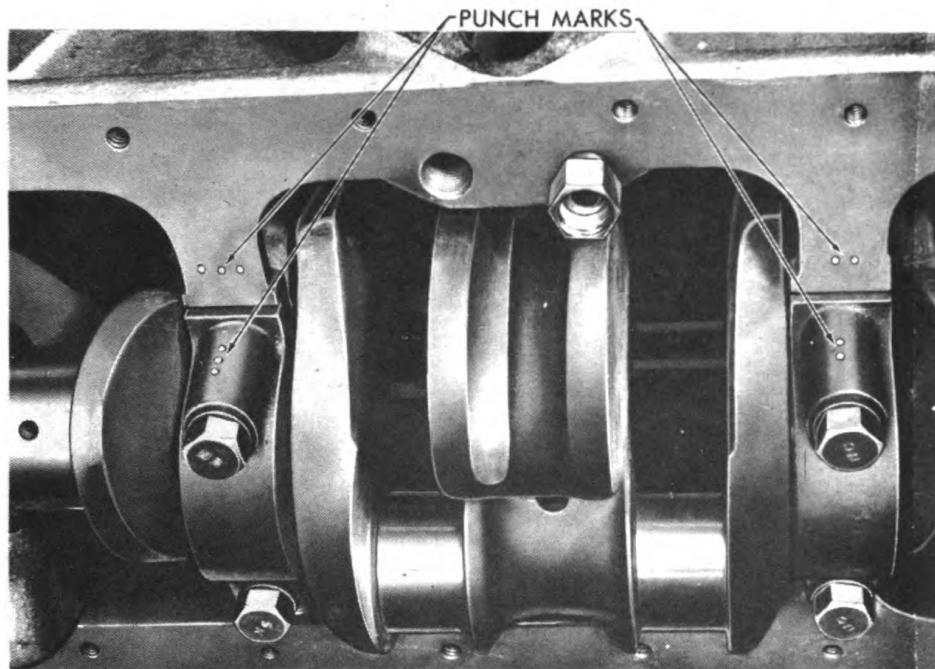

RA PD 53260

**Figure 53—Punch Marks on Cylinder Block and Crankshaft Bearing Caps**

the pipe from the cylinder block. Remove the connecting rod bolt nuts, the bearing caps and bearings. Push the piston and connecting rod assemblies out through the top of the cylinder bores.

**h. Remove Crankshaft, Flywheel and Bearings (figs. 48 and 53).** Remove three screws which hold the oil pan front seal plate in place and remove the plate. Remove the clutch housing dust seal from the clutch housing. Prick punch the front and intermediate crankshaft bearing caps and the block so that the caps can be installed in their original position (fig. 53). The intermediate caps are machined off center and damage will result if they are installed wrong. Remove the cap screws and bearing caps and lift the crankshaft out of the block. Remove the bearings from the caps and block. Remove cap screws which hold rear bearing oil seal upper half to end of crankcase. Remove the bolts which attach the flywheel to the crankshaft and remove the flywheel. Remove the crankshaft sprocket with universal puller or arbor press (fig. 51).

**i. Measure Camshaft Bearing Clearance (fig. 54).** Attach a dial indicator to the cylinder block with the plunger of the indicator resting against the back of the cam adjacent to the bearing. Pry the camshaft to and from the indicator so that the clearance in the bearing will be shown on the indicator. Check all bearings in the same manner.

**ORDNANCE MAINTENANCE—POWER PLANT, CLUTCH, AND ELECTRICAL SYSTEM— $\frac{3}{4}$  AND  $1\frac{1}{2}$  TON VEHICLES (DODGE)**

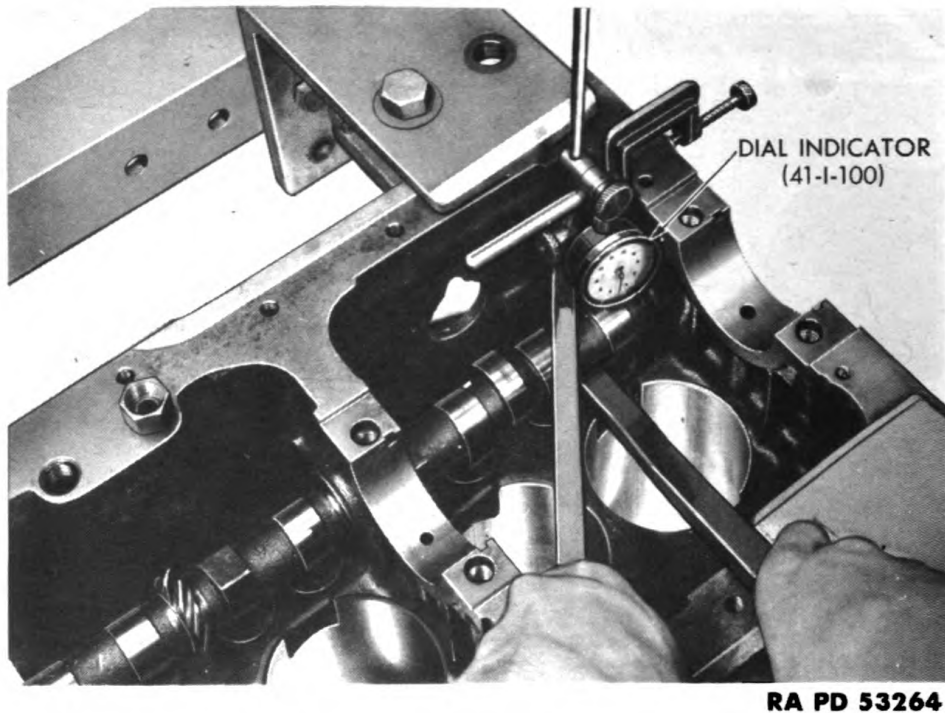

**Figure 54—Measuring Camshaft Bearing Clearance**

**j. Remove Camshaft and Tappets (fig. 48).** Remove two cap screws which hold the camshaft thrust plate to the cylinder block. Turn the camshaft one revolution to move the tappets away from the cams and pull the camshaft out slowly, being careful not to damage the camshaft or bearings. Lift the tappets from their guides and keep them in order so that they can be installed in their original position.

**k. Measure Camshaft Journals and Determine Bearing Wear.** If the camshaft bearing clearance, as determined by check made in paragraph 39 i, exceeds 0.002 inch, measure each camshaft bearing journal with micrometer (41-C-307) and replace the camshaft if the journals are worn 0.002 inch or more below the standard journal sizes which are as follows:

No. 1 (front bearing journal) . . . . .	1.9980-in.
No. 2 (intermediate) . . . . .	1.9665-in.
No. 3 (intermediate) . . . . .	1.9350-in.
No. 4 (rear bearing journal) . . . . .	1.2475-in.

The camshaft bearing wear will be the amount of the measured clearance (par. 39 i), minus the standard clearance of 0.002 inch and the camshaft journal wear. If the bearing wear exceeds 0.002 inch, replace the bearings.

DISASSEMBLY OF ENGINE

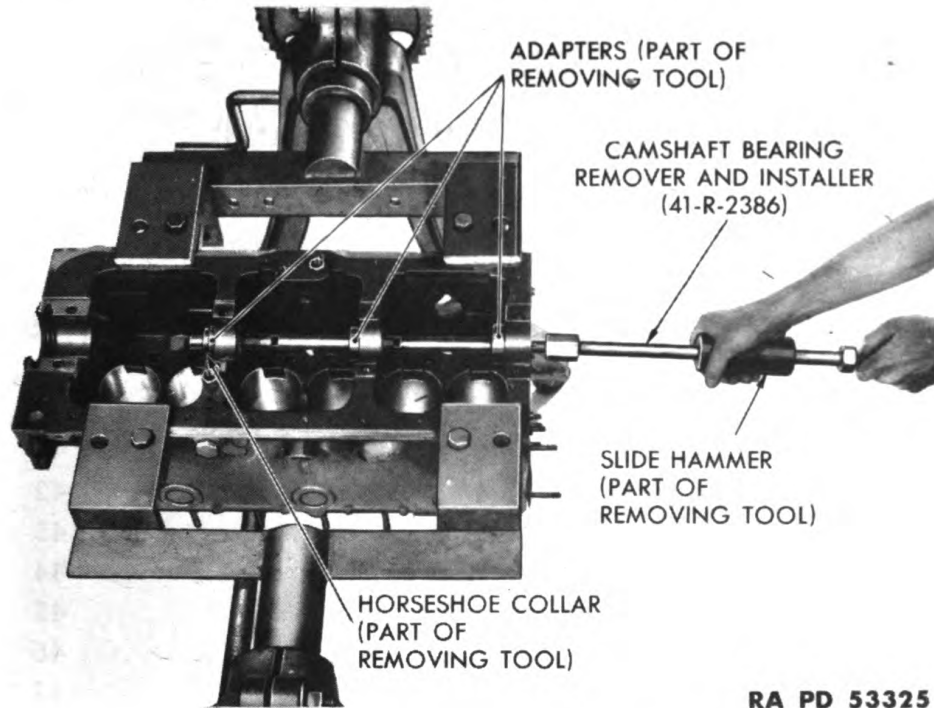

RA PD 53325

**Figure 55—Camshaft Bearing Removal**

l. **Remove Camshaft Bearings** (fig. 55). Select the proper size tool adapter for each of the three removable bearings. Insert the adapters into the bearings from the rear. Insert the puller shaft through the adapters and install one of the horseshoe collars behind one adapter. Slide the hammer of the tool against the outside nut on the driving rod with sufficient force to start the bearing and repeat the operation until the bearing is out of the bore. Leave the adapter in the block to guide the puller shaft and pull the other bearings in the same manner. When all three replaceable bearings have been pulled from the block, remove the puller and bearings.

m. **Remove Clutch Housing** (fig. 48). Remove the cap screws which attach the clutch housing to the cylinder block and pull the housing off the dowel pins.



**ORDNANCE MAINTENANCE—POWER PLANT, CLUTCH, AND ELECTRICAL SYSTEM— $\frac{3}{4}$  AND 1 $\frac{1}{2}$  TON VEHICLES (DODGE)**

**CHAPTER 2**

**ENGINE AND CLUTCH (Cont'd)**

**Section VI**

**INSPECTION AND REPAIR OF ENGINE COMPONENTS**

	Paragraph
Cleaning and inspection—general . . . . .	40
Cylinder block and head . . . . .	41
Crankshaft and bearings . . . . .	42
Camshaft, bearings and tappets . . . . .	43
Timing chain and sprockets . . . . .	44
Pistons, piston pins and connecting rods . . . . .	45
Valves and springs . . . . .	46
Manifold assembly . . . . .	47
Flywheel and clutch housing . . . . .	48
Oil pan and strainer . . . . .	49
Chain case cover and fan pulley . . . . .	50

**40. CLEANING AND INSPECTION—GENERAL.**

a. After the engine has been completely torn down and subassemblies have been disassembled, clean all component parts of the engine thoroughly to remove oil, grease and carbon.

**b. Cleaning of parts:**

(1) Soak all aluminum parts in dry cleaning solvent. Rinse the parts off in hot water and dry them.

(2) Place all steel parts in a suitable cleaning solution. Leave them in long enough to dissolve all grease and dirt. Remove the parts, rinse in hot water, blow out with compressed air, and wipe dry. Never, under any circumstances, immerse an aluminum or aluminum alloy part in a steel stripping solution, regardless of how weak the solution may be.

(3) Thoroughly clean all oil lines and passages in the crankcase, crankshaft, connecting rods and other parts where such passages are employed for lubricating reciprocating parts, by forcing steam through each opening until it flows without restriction.

(4) Strip off all gaskets shellacked onto the various parts. Clean all surfaces where sealing compound has been used by scraping and washing with denatured alcohol and dry cleaning solvent.

## INSPECTION AND REPAIR OF ENGINE COMPONENTS

### c. Inspection of Parts:

- (1) As soon as each part has been cleaned as explained in paragraph 40 b, inspect it and keep it properly covered to protect it from dust and dirt if it is to be used for reassembly.
- (2) If available, apply the magnaflux inspection process to all steel parts except ball and roller bearings, studs, standard nuts and washers.
- (3) Install new piston rings at every overhaul.
- (4) Install new crankshaft (main) bearings and connecting rod bearings at every overhaul.

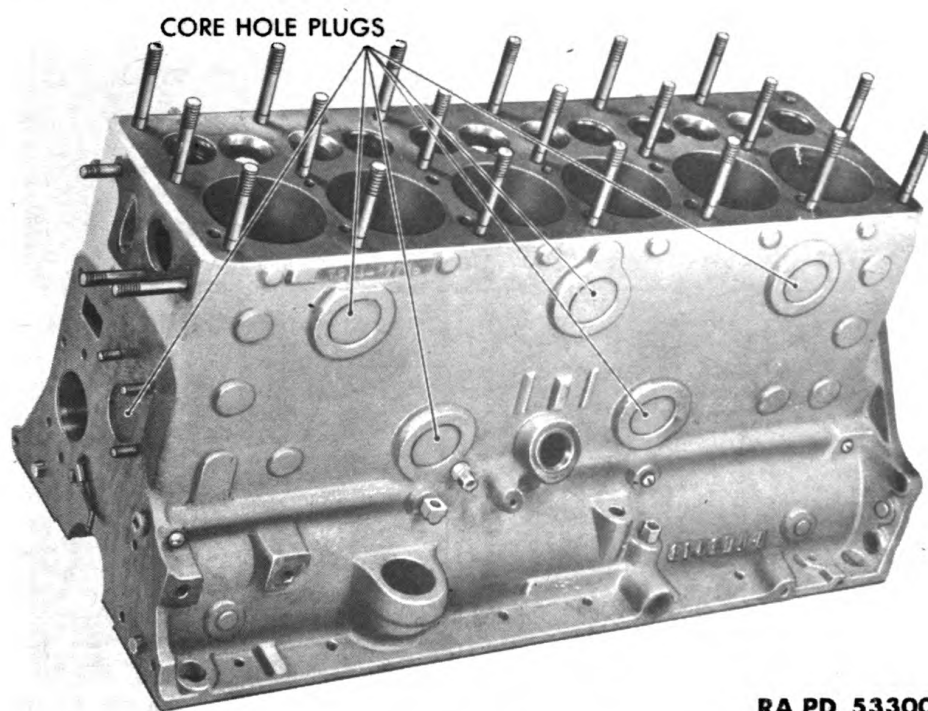

RA PD 53300

**Figure 56—Cylinder Block**

- (5) Replace loose, damaged or worn bushings with new bushings.
- (6) Replace all loose, broken or damaged studs with new studs.

### 41. CYLINDER BLOCK AND HEAD.

a. **Inspect and Repair Cylinder Block Casting (fig. 56).** Inspect the casting thoroughly including the bearing supports for cracks. If crack is found other than in cylinder bore or valve seat and the crack is accessible, repair by welding. If crack is found in cylinder bore or valve seat or in such a location that a satisfactory welding job cannot be done, replace the cylinder block. Remove camshaft sprocket oil tube, blow out with compressed air and reinstall.

**ORDNANCE MAINTENANCE—POWER PLANT, CLUTCH, AND ELECTRICAL SYSTEM— $\frac{3}{4}$  AND 1  $\frac{1}{2}$  TON VEHICLES (DODGE)**

b. **Inspect Crankshaft Bearing Bore Diameter** (fig. 58). Install the crankshaft bearing caps and tighten the cap screws to 75 to 80 foot-pounds with torque wrench (41-W-3630). Measure the diameter of the bearing bores with inside micrometer. If the diameter of a bearing bore is greater than 2.6570 inches, it will not impose the proper crush to the bearing inserts. Dress the cap down by rubbing the cap over a piece of abrasive cloth on a surface plate until the diameter of the bore is 2.6570 inches. Never dress down a bearing cap to reduce bearing clearance. If the diameter of a bearing bore is less than 2.6565 inches,

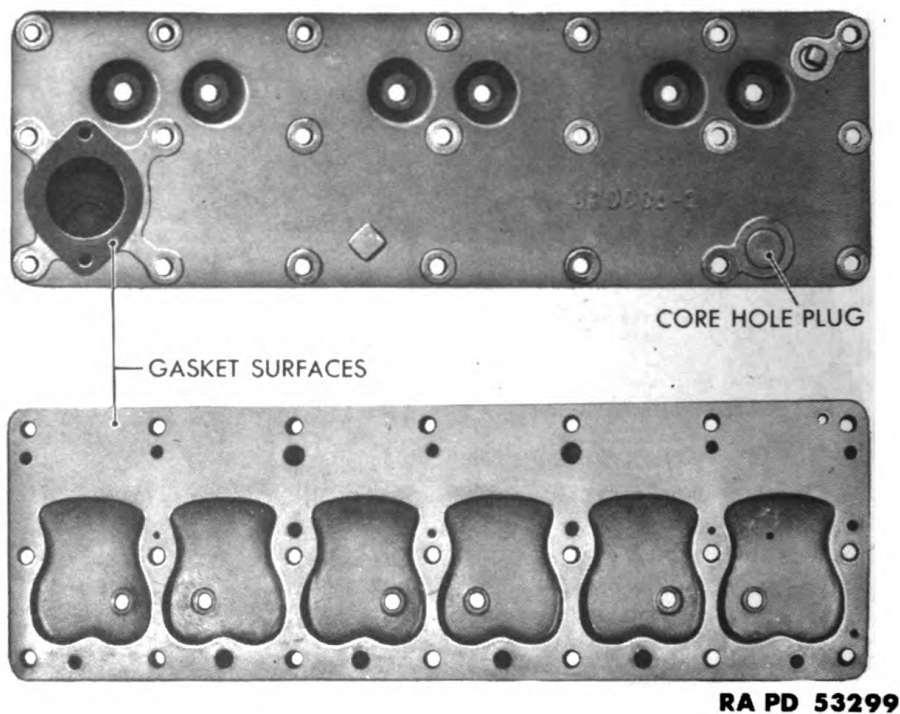

**Figure 57—Cylinder Head**

replace the cylinder block as the bearing cap has been filed or excessively dressed down.

c. **Inspect Gasket Surfaces of Cylinder Block and Head** (figs. 56 and 57). Lay a straightedge (41-S-5858) across the gasket surfaces of the block and head. With a 0.006-inch feeler gage, check for low spots in the surface around the combustion chambers. If the feeler gage can be passed between the straightedge and the surface of the block or head, resurface the part until it is just flat. Do not remove more metal than necessary, as metal removed from either gasket surface alters the compression ratio of the engine.

**INSPECTION AND REPAIR OF ENGINE COMPONENTS**

d. **Inspect and Replace Core Hole Plugs** (fig. 56). If leakage at a core hole plug is apparent, drive a center punch or similar tool through the center of the plug and remove the plug. Clean the plug seat thoroughly and remove any sharp edges or irregularities from the new plug. Coat the edge of the plug with white lead and insert the plug in the core hole with the concaved surface facing inward. Expand the plug tight in the hole by striking it in the center with a blunt drift and hammer.

e. **Inspect and Repair Cylinder Bores** (fig. 59). Remove any

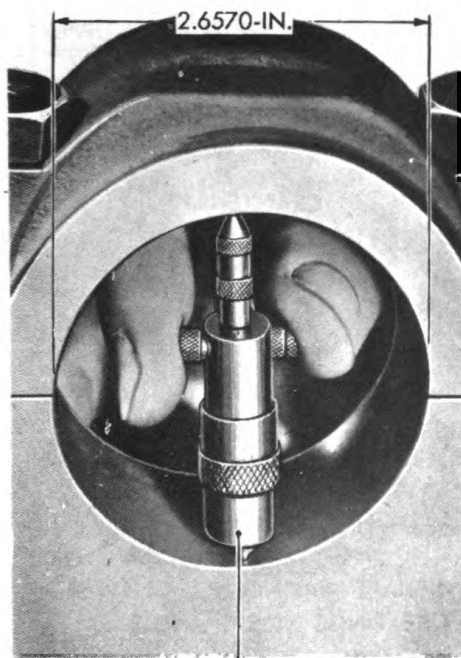

MICROMETER CALIPERS (41-C-304)  
RA PD 53312

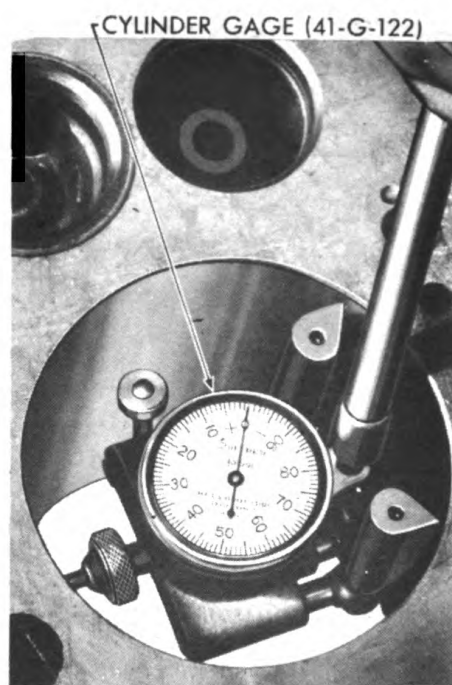

CYLINDER GAGE (41-G-122)  
RA PD 53313

**Figure 58—Checking Crankshaft Bearing Bore Diameter**

**Figure 59—Checking Cylinder Bore Wear**

ridge that may have formed at the top of the piston ring travel with the ridge reamer (41-R-2275). Do not cut more than  $\frac{1}{64}$  inch below bottom edge of ridge. Measure out of round and taper of cylinder bores with cylinder gage. If cylinder bore is out of round more than 0.005 inch, tapered more than 0.020 inch or scored, recondition the bore for oversize piston. Bore with machine (40-M-4) to within 0.001 inch of the finished size, then hone with cylinder hone (40-G-151) to a smooth, bright finish to assure satisfactory ring life. If the cylinder walls are smooth, not tapered more than 0.020 inch or out of round more than 0.005 inch, reboring is not necessary.

**ORDNANCE MAINTENANCE—POWER PLANT, CLUTCH, AND ELECTRICAL SYSTEM— $\frac{3}{4}$  AND  $1\frac{1}{2}$  TON VEHICLES (DODGE)**

**42. CRANKSHAFT AND BEARINGS.**

a. **Inspect and Repair Crankshaft** (figs. 60, 61 and 62). Examine the crankshaft bearing and connecting rod bearing journals for scores or damage and measure the journals for wear with micrometer (41-C-307). If one or more journals are tapered or out of round more than 0.001 inch, or wear on the diameter of the journal is greater than 0.002 inch (par. 78 c) regrind the journals with crankshaft grinder (40-G-107) for undersize bearings selected. When regrinding the journals,

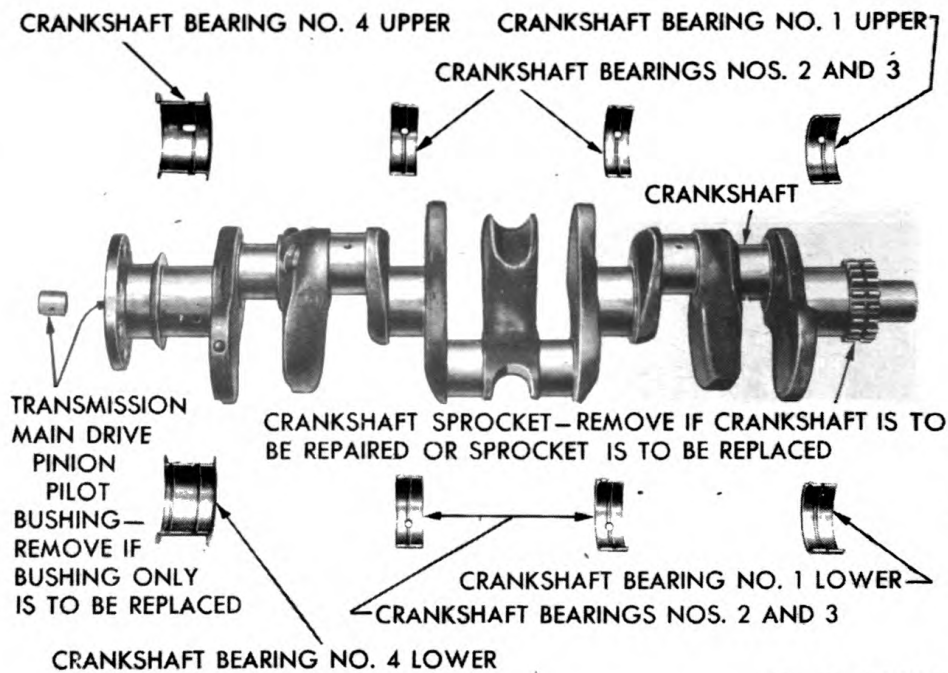

RA PD 53301

**Figure 60—Crankshaft and Bearings**

maintain bearing fillets with a true radius of  $\frac{3}{32}$  to  $\frac{7}{32}$  inch for the connecting rod bearings and  $\frac{1}{16}$  to  $\frac{1}{8}$  inch for the crankshaft (main) bearings (fig. 61). Run-out should not exceed 0.002 inch. Inspect the transmission main drive pinion pilot bushing and if rough or badly worn replace the bushing, using replacer and burnishing tool and burnish new bushing to size (fig. 62). *Do not ream the bushing to size.*

b. **Inspect Bearings** (fig. 60). If the crankshaft (main) bearings and connecting rod bearings are damaged or the surface metal is cracked or checked, replace the bearings. Crankshaft (main) bearings and connecting rod bearings are available in standard size and undersizes of 0.002, 0.010, 0.012, 0.020 and 0.030 inch.

INSPECTION AND REPAIR OF ENGINE COMPONENTS

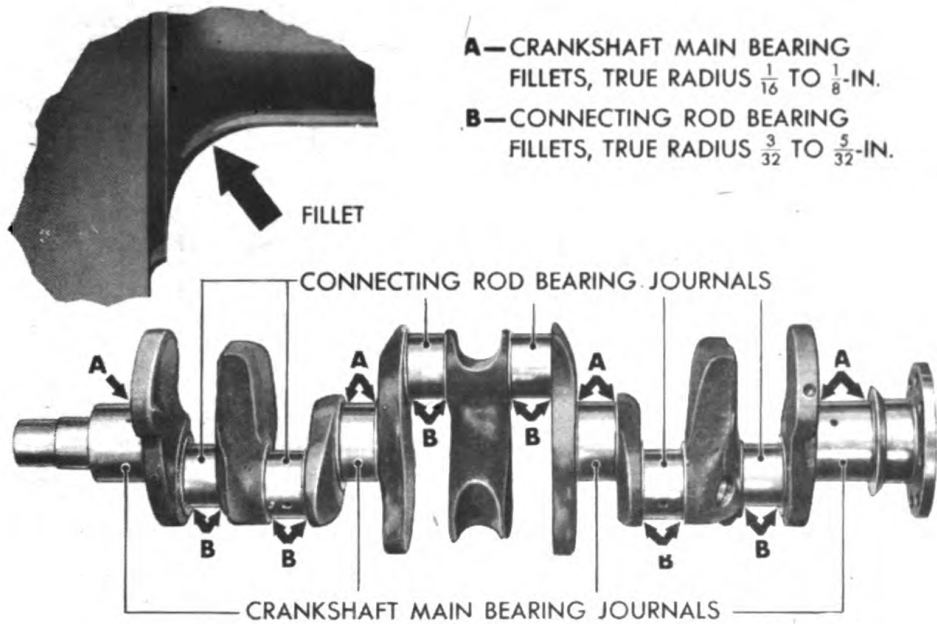

RA PD 53316

Figure 61—Crankshaft Bearing Fillets

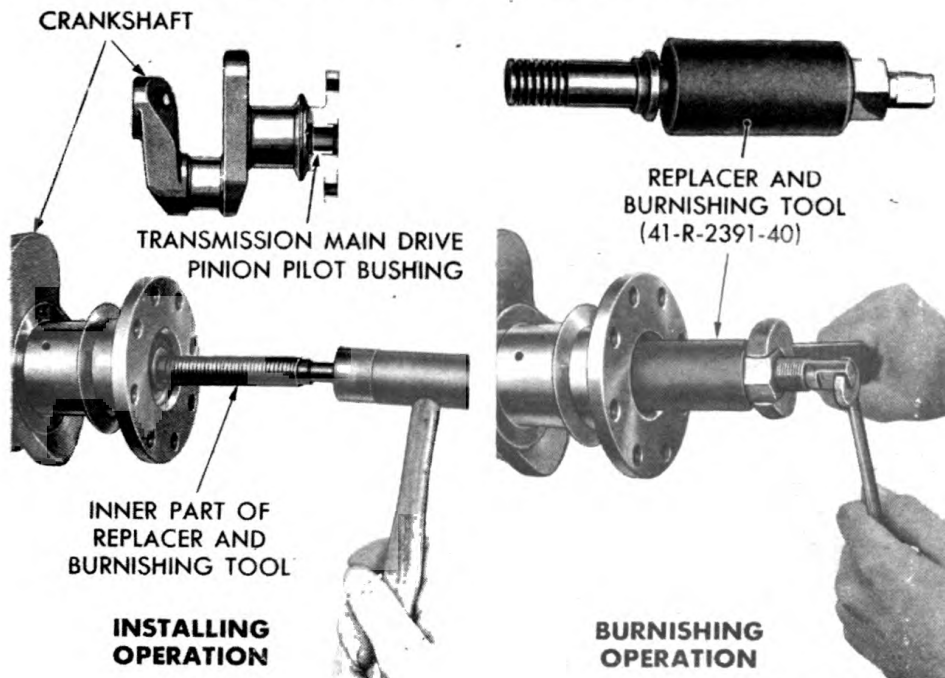

RA PD 53327

Figure 62—Transmission Main Drive Pinion Pilot Bushing Installation

ORDNANCE MAINTENANCE—POWER PLANT, CLUTCH, AND ELECTRICAL SYSTEM— $\frac{3}{4}$  AND  $1\frac{1}{2}$  TON VEHICLES (DODGE)

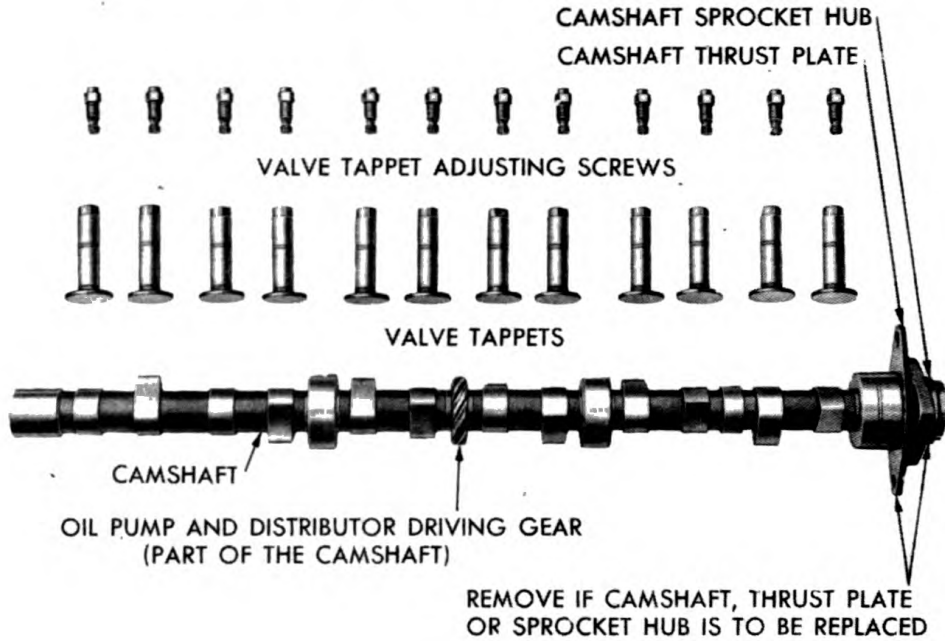

RA PD 53302

Figure 63—Camshaft and Tappets



RA PD 53314

Figure 64—Checking Camshaft End Play

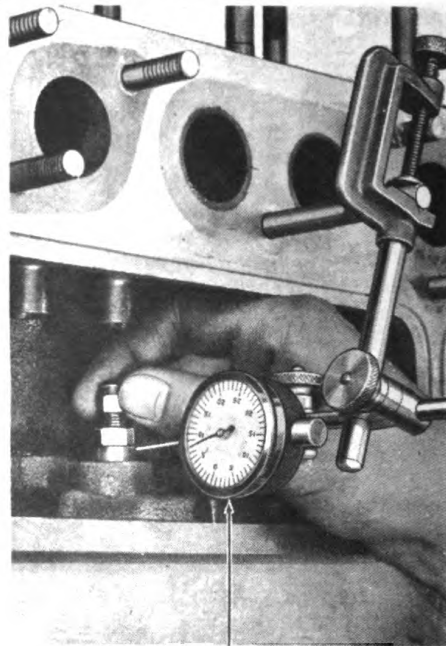

DIAL INDICATOR-(41-I-100)

RA PD 53315

Figure 65—Checking Valve Tappet Guide Clearance

**INSPECTION AND REPAIR OF ENGINE COMPONENTS**

**43. CAMSHAFT, BEARINGS AND TAPPETS.**

a. **Inspect Camshaft** (fig. 63). Measure camshaft bearing journals with micrometer (41-C-307) (par. 39 k). Examine oil pump and distributor driving gear and if damaged or worn to any noticeable extent, replace the camshaft. Measure camshaft end play by inserting feeler gage between the sprocket thrust plate and the front end of the front bearing journal (fig. 64). The standard clearance is 0.002 to 0.006 inch. If the clearance at that point is greater than 0.010 inch, replace the thrust plate, sprocket hub or both.

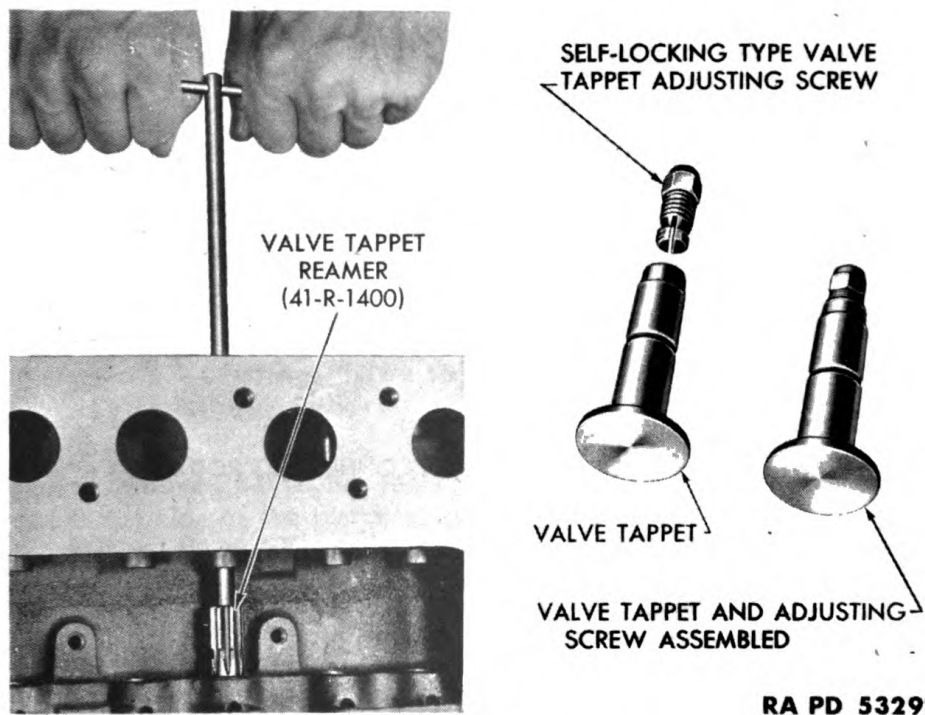

RA PD 53292

**Figure 66—Reaming Cylinder Block for Oversize Valve Tappet**

b. **Inspect Camshaft Bearings** (par. 39 i and k).

c. **Inspect Tappets** (figs. 65 and 66). Insert tappet in its guide and attach a dial indicator to valve spring cover stud (fig. 65). Raise the tappet just above the lower end of its normal travel. Adjust the plunger of the indicator against the upper end of the tappet and move the top of the tappet in and out (crosswise of the engine). The tappet guide clearance will be shown by the indicator. If the clearance is greater than 0.002 inch, ream cylinder block opening (fig. 66) and install 0.008-inch oversize tappet. If the top of the tappet screws are worn unevenly, grind the surface of the screws flat and smooth.



**ORDNANCE MAINTENANCE—POWER PLANT, CLUTCH, AND ELECTRICAL SYSTEM— $\frac{3}{4}$  AND  $1\frac{1}{2}$  TON VEHICLES (DODGE)**

**44. TIMING CHAIN AND SPROCKETS.**

a. Refer to paragraph 39 f for inspection procedure. Replace chain or sprockets if worn or damaged.

**45. PISTONS, PISTON PINS AND CONNECTING RODS.**

a. Inspect Pistons and Rings (fig. 67). Install piston in piston vise (41-V-425) and remove piston pin. Remove piston rings and thoroughly clean carbon from piston ring grooves with groove cleaner (41-

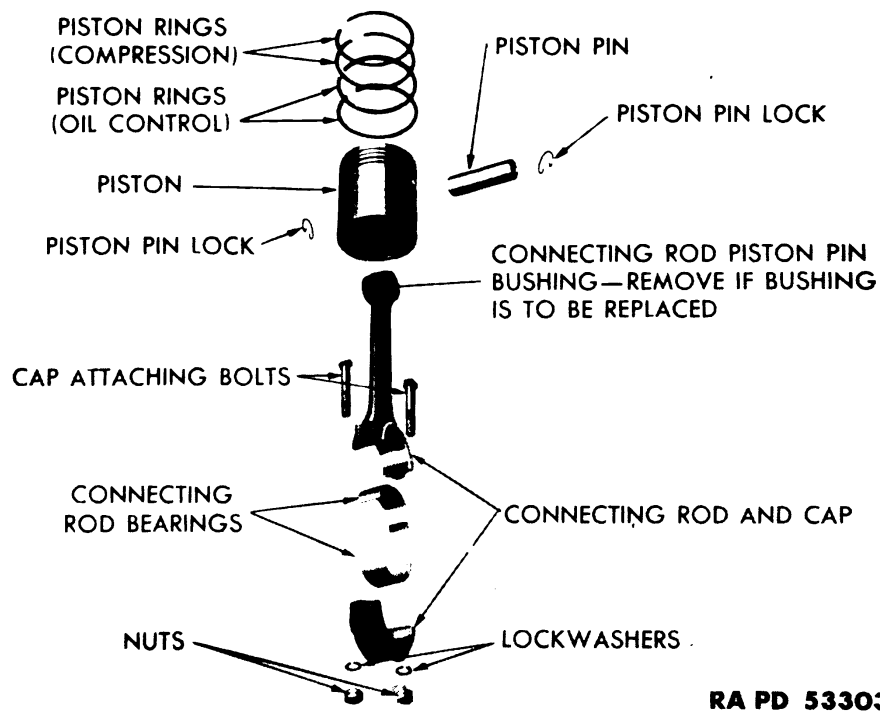

RA PD 53303

**Figure 67—Piston and Connecting Rod Disassembled**

C-2155) and oil return holes. Examine piston carefully and if cracked or damaged, replace the piston. Check ring side clearance in grooves with new piston rings. If the side clearance exceeds the maximum allowable clearance of 0.008 inch for compression rings or 0.004 inch for oil rings, replace the piston. If the cylinders are not rebored, it is not necessary to replace a piston unless the piston is damaged or the ring grooves are worn in excess of the maximum allowable specifications.

b. Fit Pistons to Cylinder Bores (figs. 68 and 69).

(1) FITTING PISTONS: If the cylinders are not rebored, select or machine pistons that will just slide down through the bottom of the cylinder bores under their own weight (fig. 68). If the cylinders have been rebored, select or machine pistons that will require six to eight pounds

## INSPECTION AND REPAIR OF ENGINE COMPONENTS

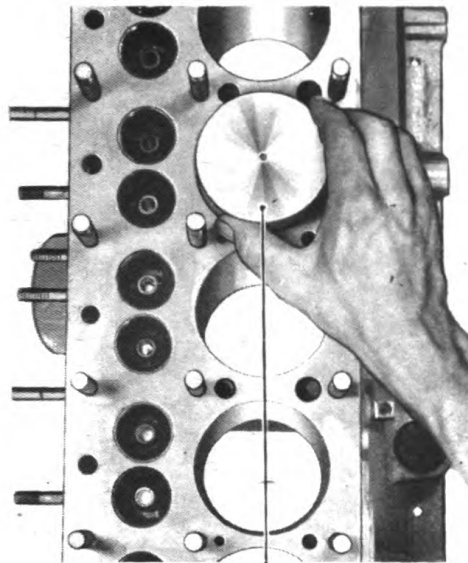

PISTON TO JUST SLIDE DOWN  
THROUGH THE CYLINDER BORE  
UNDER ITS OWN WEIGHT

RA PD 53310

**Figure 68—Fitting Piston to  
Cylinder not Rebored**

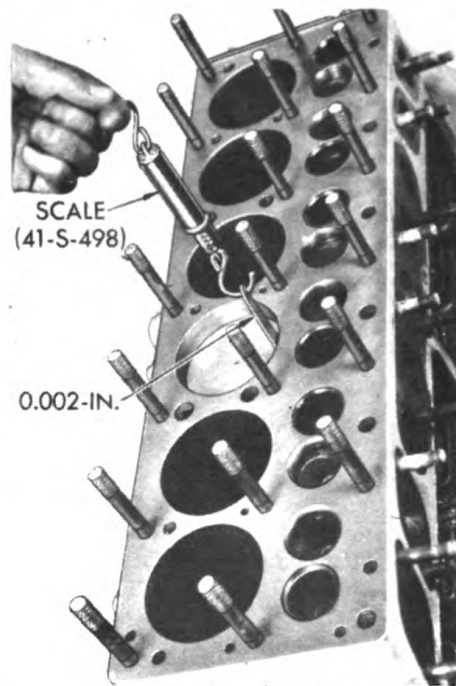

RA PD 53319

**Figure 69—Fitting Piston to  
Rebored Cylinder**

pull to remove a 0.002-inch feeler,  $\frac{1}{2}$  inch wide, when installed between the thrust side of the piston skirt and the cylinder wall (fig. 69). Fit the piston at normal room temperature ( $70^{\circ}\text{F}$ ). Finished pistons are available in standard size and oversizes of 0.020 and 0.040 inch.

(2) **GRINDING PISTONS** (fig. 70): A semi-finished piston is available which can be finished to 0.025 to 0.050 inch oversize. This semi-finished piston cannot be used in cylinders smaller than 0.025 inch oversize as the ring grooves will be too shallow. Grind semi-finished pistons with cam and general purpose grinder (40-G-149) so that the clearance between the high spot of the piston skirt contour, about  $\frac{1}{4}$  inch from the bottom of the piston, and the cylinder wall is 0.0005 inch. Use a C cam to secure the proper contour of the skirt and grind the diameter of the piston at the pin holes (A, fig. 70) 0.010 to 0.012 inch less than the diameter across the thrust faces (B, fig. 70). Grind the skirt of the piston so that the diameter just below the rings (C, fig. 70) is from 0.0005 to 0.0015 inch less than the diameter at the bottom of the piston (D, fig. 70). The ring lands on Dodge semi-finished pistons are ground to the correct dimension for use in cylinder bores from 0.025 to 0.050 inch oversize. If other types of semi-finished pistons are used, and it is necessary to grind the ring lands, grind them round for a clearance of 0.028 to 0.033 inch.

**ORDNANCE MAINTENANCE—POWER PLANT, CLUTCH, AND ELECTRICAL SYSTEM— $\frac{3}{4}$  AND 1 $\frac{1}{2}$  TON VEHICLES (DODGE)**

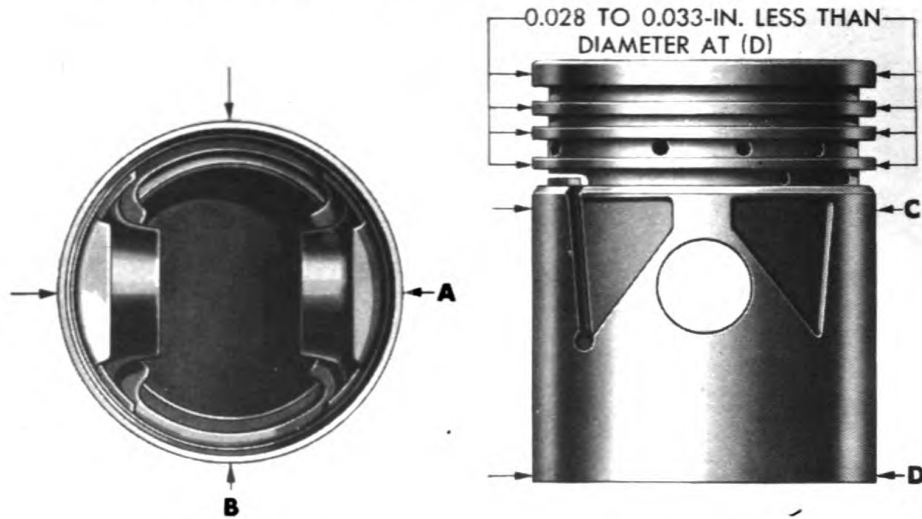

THE ELLIPTICAL SHAPE OF THE PISTON SKIRT SHOULD BE 0.010 TO 0.012-IN. LESS AT DIAMETER (A) THAN ACROSS THE THRUST FACES AT DIAMETER (B)

THE SKIRT OF THE PISTON SHOULD TAPER SO THAT THE DIAMETER AT (C) IS FROM 0.0005 TO 0.0015-IN. LESS THAN AT (D).

RA PD 53294

**Figure 70—Cam Ground Piston**

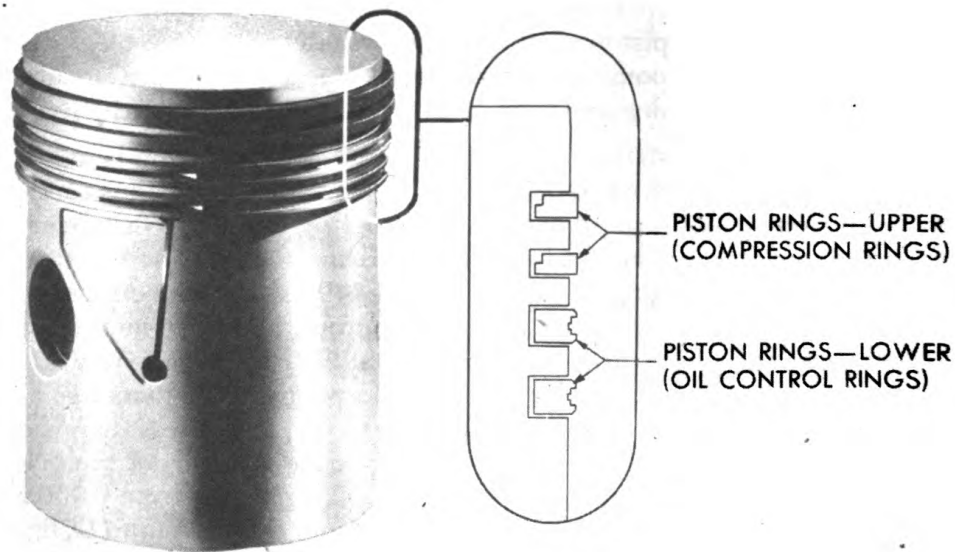

RA PD 53287

**Figure 71—Standard Piston Rings**

**INSPECTION AND REPAIR OF ENGINE COMPONENTS**

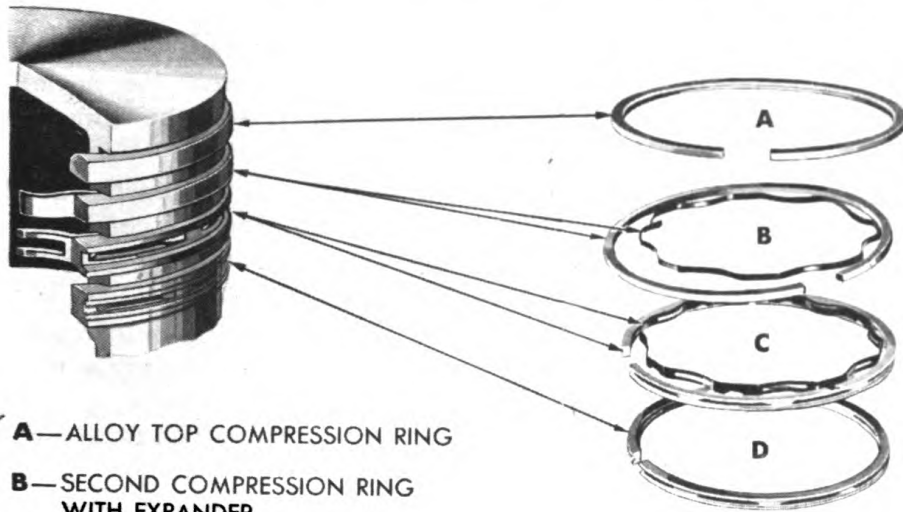

- A**—ALLOY TOP COMPRESSION RING
- B**—SECOND COMPRESSION RING WITH EXPANDER
- C**—CHANNELED UPPER OIL CONTROL RING WITH EXPANDER
- D**—STANDARD LOWER OIL CONTROL RING

RA PD 53304

**Figure 72—Mopar Oil Master Piston Rings**

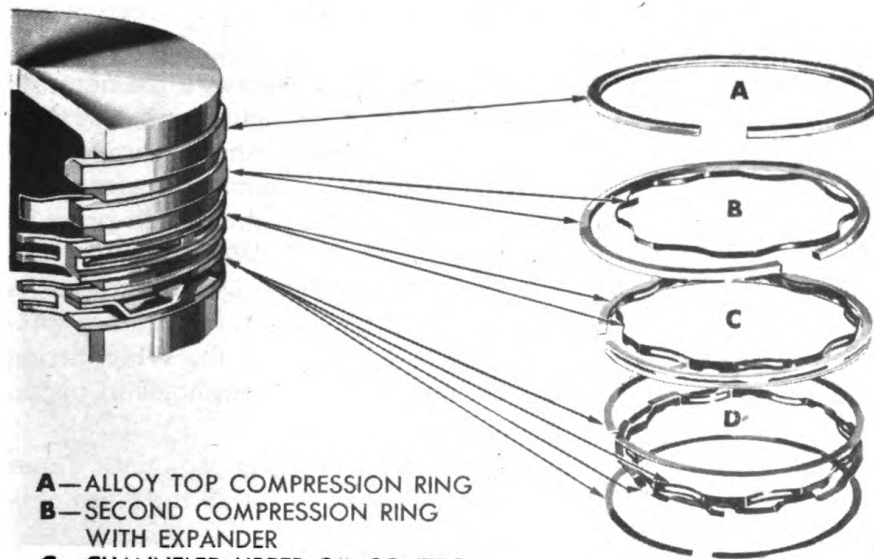

- A**—ALLOY TOP COMPRESSION RING
- B**—SECOND COMPRESSION RING WITH EXPANDER
- C**—CHANNELED UPPER OIL CONTROL RING WITH EXPANDER
- D**—FOUR SECTION LOWER OIL CONTROL RING

RA PD 53305

**Figure 73—Mopar Oil Master Piston Rings**

**ORDNANCE MAINTENANCE—POWER PLANT, CLUTCH, AND ELECTRICAL SYSTEM— $\frac{3}{4}$  AND  $1\frac{1}{2}$  TON VEHICLES (DODGE)**

**c. Select Proper Piston Ring Set as follows (figs. 71, 72 and 73):**

(1) Install standard piston rings if cylinder bore wear does not exceed 0.002 inch out of round or 0.0025 inch taper; or if the cylinders are rebored (fig. 71).

(2) Install oil master ring set with substitution of standard coated oil control ring in lower groove, and expanders under the second compression ring and upper oil control ring, if cylinder bore wear is within 0.002 to 0.003 inch out of round and 0.0025 to 0.007 inch taper (fig. 72).

(3) Install oil master ring set, which includes an expander under the second compression ring, and under both oil control rings with a steel laminated type lower oil control ring, if cylinder bore wear is within 0.003 to 0.005 inch out of round and 0.007 to 0.020 inch taper (fig. 73).

(4) Standard coated ring sets are available in sizes of standard to 0.004 inch oversize, 0.015 to 0.024 inch oversize and 0.035 to 0.044 inch oversize. Oil master rings sets are available in sizes of standard to 0.009 inch oversize, 0.020 to 0.029 inch oversize, and 0.040 to 0.049 inch oversize.

**d. Fit Piston Rings.** Measure cylinder bore diameter with dial gage (41-G-122) near the bottom of the bore and use piston rings selected (par. 45 c) for that size bore. Place the rings squarely in the bottom of the cylinder bore and measure the end gap. If necessary, file the ends of the rings with piston ring filer (41-F-2950) to create a gap of 0.007 to 0.015 inch.

**e. Inspect and Fit Piston Pins** (fig. 74). Measure diameter of piston pin with micrometer (41-C-307) and if the diameter is less than 0.8591 inch, replace the pin. Fit piston pin in the bushing at upper end of connecting rod with a tight thumb press fit at room temperature of 70 F. Fit piston pin in the piston bosses with a tight thumb press fit with the piston heated to 160 F and pin at 70 F. When fitting a pin to a new piston and the clearance at the connecting rod bushing is excessive, replace the bushing and ream with adjustable reamer (41-R-2300) or grind with grinder (40-G-103) for proper fit. When fitting an oversize piston pin to old piston, ream or grind pin holes in piston and connecting rod bushing for the correct fit.

**f. Inspect Connecting Rods.** Check connecting rods with aliner (41-A-135). If rod is bent or twisted more than 0.0025 inch, use connecting rod press (41-P-2730) to straighten the rod.

**46. VALVES AND SPRINGS.**

**a. Clean and Inspect Valves.** If the valve seat is badly burned, the head cracked or warped, replace the valve. Measure the valve stem in several places with micrometer (41-C-307). The standard measurement for the stem is 0.3405 inch. If the stem is worn more than 0.002

**INSPECTION AND REPAIR OF ENGINE COMPONENTS**

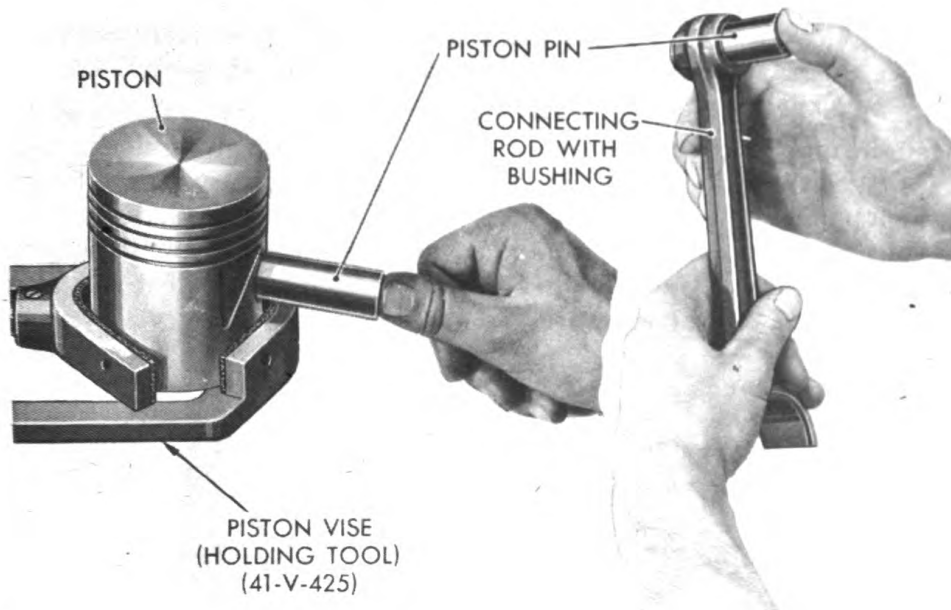

RA PD 53306

**Figure 74—Fitting Piston Pin**

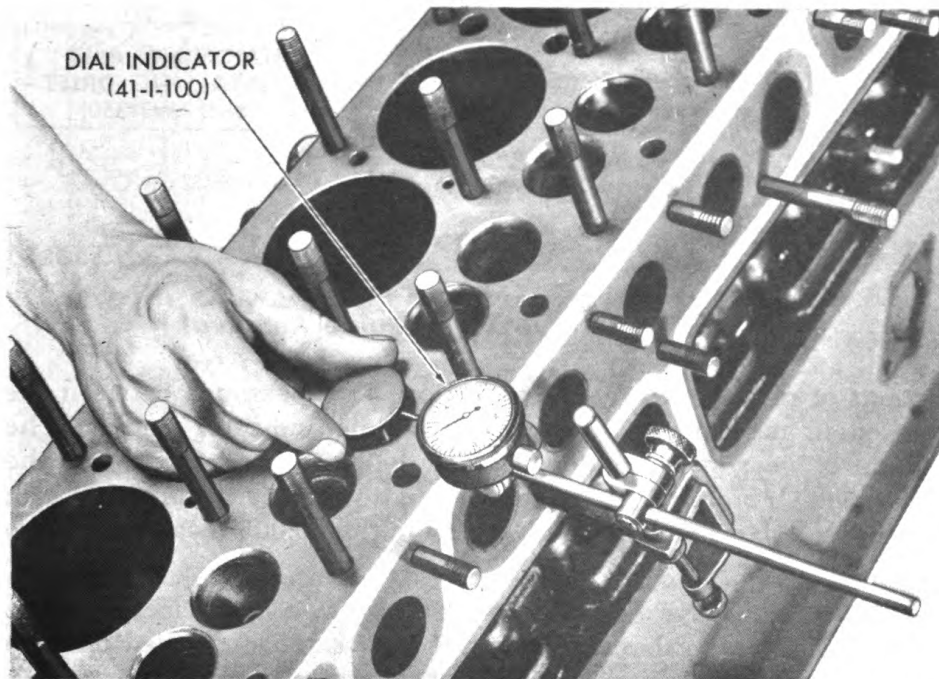

RA PD 53307

**Figure 75—Checking Valve Stem Clearance**

**ORDNANCE MAINTENANCE—POWER PLANT, CLUTCH, AND ELECTRICAL SYSTEM— $\frac{3}{4}$  AND 1  $\frac{1}{2}$  TON VEHICLES (DODGE)**

inch, replace the valve. If the valve stem is worn excessively uneven, replace the valve spring as the spring is not seating squarely.

b. **Clean and Inspect Valve Stem Guides (fig. 75).** Thoroughly clean the interior of the valve stem guide with a wire valve guide brush and dry cleaning solvent. Place the valve in the guide with the head  $\frac{7}{16}$  inch above the top of the cylinder block. Attach a dial indicator to one of the cylinder block studs and adjust the plunger of the indicator against the edge of the valve head. Hold the valve so that it will not turn and move the valve toward and away from the indicator and note

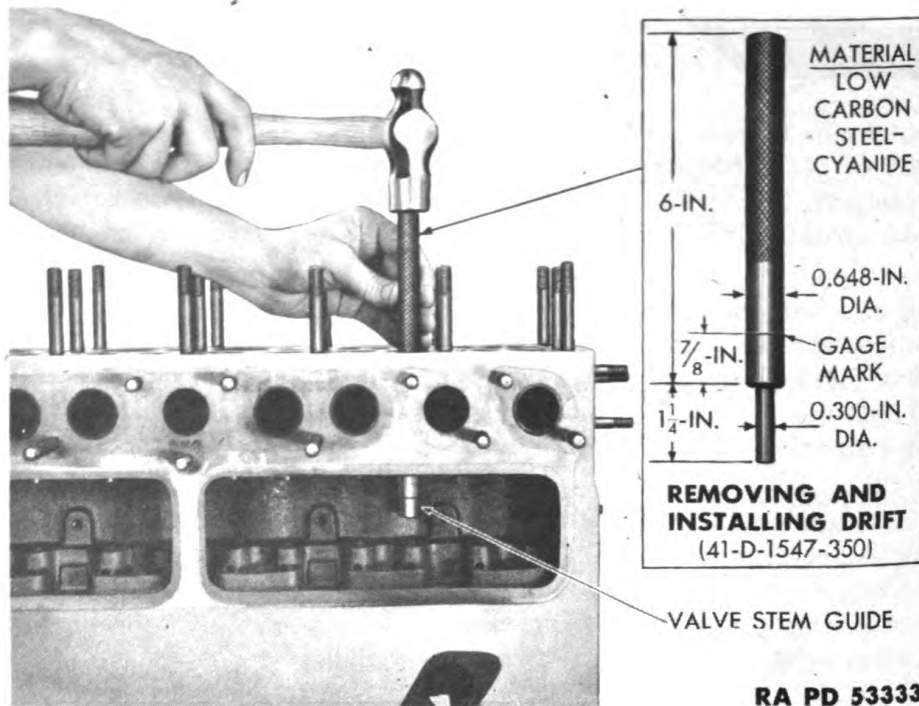

RA PD 53333

**Figure 76—Valve Stem Guide Removal**

amount of play shown by the indicator. The clearance between the valve stem and guide will be one-half the dial indicator reading. The amount of wear in the guide would be the clearance less wear on the valve stem. If an intake valve stem guide is worn more than 0.003 inch or exhaust valve stem guide is worn more than 0.005 inch, replace the guide (par. 46 e and f).

c. **Inspect Valve Seats.** Inspect intake valve seat for cracks or damage. Examine exhaust valve steel inserts and if cracked or loose in the cylinder block, replace with oversize insert (par. 46 g).

d. **Inspect and Test Valve Springs.** Wash the springs in dry-cleaning solvent, and examine the spring carefully. If the metal is rusted

## INSPECTION AND REPAIR OF ENGINE COMPONENTS

or etched, replace the spring. Test the springs for proper tension by using a valve spring tester (17-T-1600). The tension of a standard spring is 40 to 45 pounds when the spring is compressed to a length of  $1\frac{3}{4}$  inch, or 107 to 115 pounds when the spring is compressed to a length of  $1\frac{3}{8}$  inch. Replace any spring which compresses to either length with less than the minimum specified pressure as such a spring is weak and will cause inefficient engine performance.

e. **Remove Valve Stem Guides** (fig. 76). Drive the valve stem guide down and out of the block with special drift.

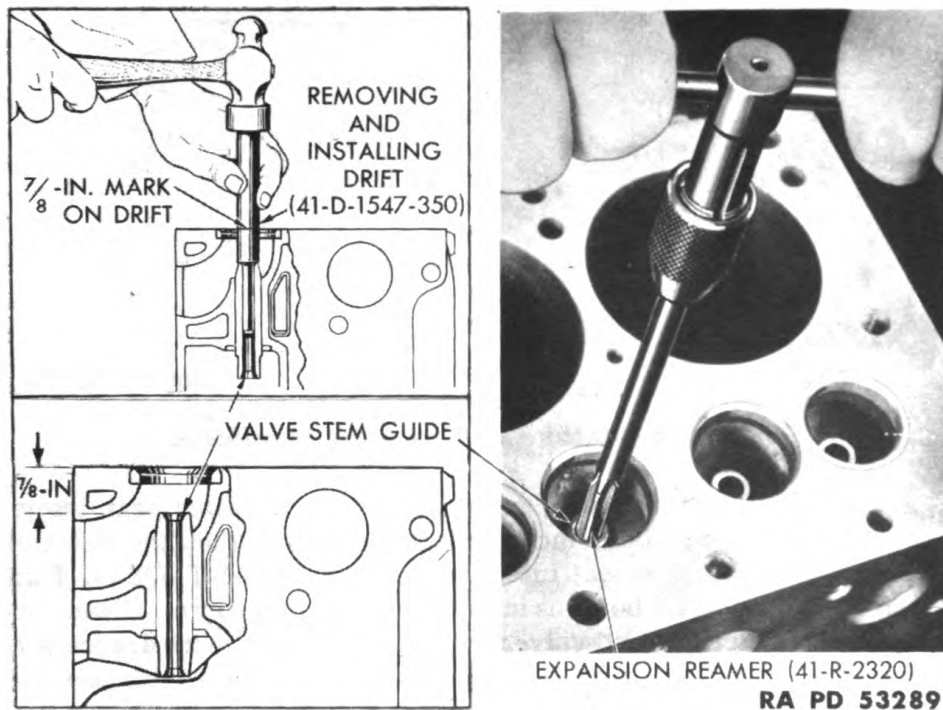
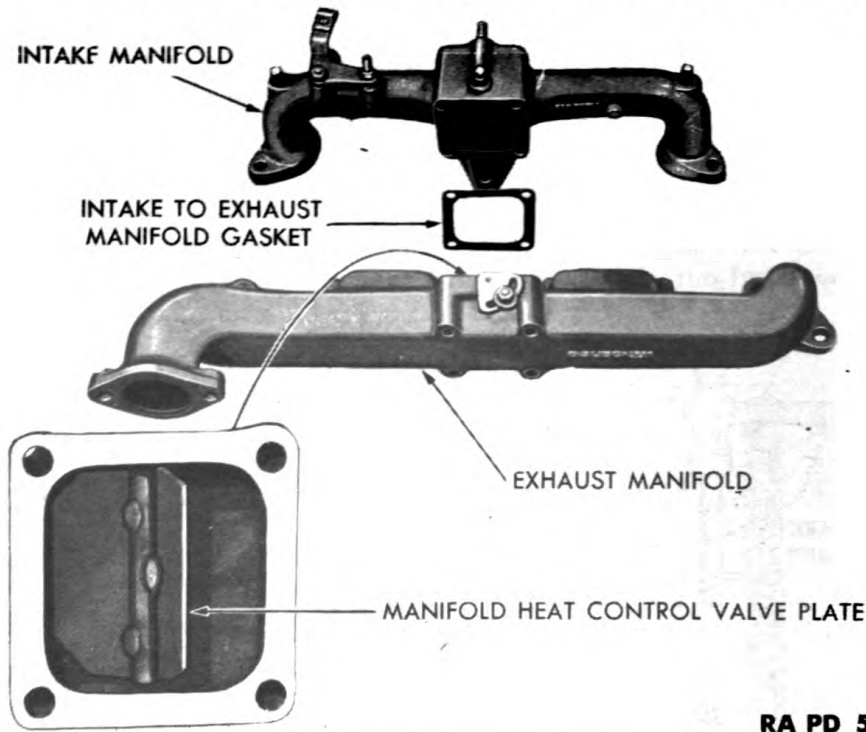

**Figure 77—Installing and Reaming Valve Stem Guide**

f. **Install Valve Stem Guides** (figs. 76 and 77). Wipe the exterior of valve stem guide clean and blow out the hole in the block with compressed air. Start the guide in the hole with the tapered end up. Use the valve stem guide installing drift and drive the guide down until the top of the guide is located  $\frac{7}{8}$  inch below the top surface of the cylinder block (fig. 77). Ream new intake valve guides with an expansion type reamer to 0.342 inch to 0.343 inch and new exhaust valve guides to 0.344 to 0.345 inch (fig. 77). If a valve with a slightly worn stem is to be installed, reduce these dimensions the amount of the wear on the valve stem. Use micrometer (41-C-307) and adjust the reamer so that the maximum diameter of the reamer at any point corresponds to the desired inside diameter of the valve stem guide.



**ORDNANCE MAINTENANCE—POWER PLANT, CLUTCH, AND ELECTRICAL SYSTEM— $\frac{3}{4}$  AND  $1\frac{1}{2}$  TON VEHICLES (DODGE)**



**Figure 78—Intake and Exhaust Manifolds**

**g. Replace Valve Seat (exhaust).** Remove valve seat insert. Cut the counterbore 0.0035 inch smaller in diameter than the insert to be installed with valve seat insert replacing tool (41-T-3383). Run the cutter down until it bottoms in the original counterbore. Clean cuttings from counterbore and valve port. Chill the insert with dry ice and use drift to install the insert in the block and peen over with peening tool.

**h. Reface Valves.** Set the valve refacer (40-V-505) to reface the valves at an angle of 45 degrees, and dress the abrasive wheel so that it is smooth and true. Install the valve in the chuck and reface it smooth and true. Do not remove more metal than is necessary, to get a smooth, even surface. If the head is warped or burned enough to require excessive grinding, replace the valve. If the end of the valve stem is worn uneven from tappet contact, square it up on valve refacer.

**i. Grind Valve Seats.** Install the  $1\frac{1}{2}$ -inch pilot in the valve stem guide. Install the correct size stone with an angle of 45 degrees on the valve reseating outfit (40-V-535) and dress the stone on the dresser which is a part of the valve seat grinder kit. Place the grinder and stone assembly over the pilot in the valve stem guide and grind just enough to make a smooth seat  $\frac{1}{16}$  inch to  $\frac{3}{32}$  inch wide with less than 0.0005 inch run-out. Check the concentricity of the seat with a dial indicator.

**INSPECTION AND REPAIR OF ENGINE COMPONENTS**

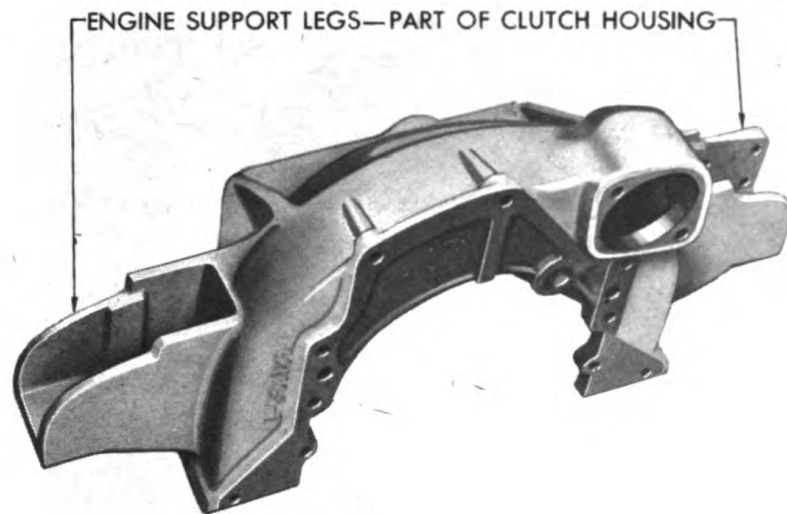

RA PD 533C9

**Figure 79—Clutch Housing**

If the seats are too wide, use a 20-degree angle stone to reduce the width. When the grinding operation has been completed, remove all abrasive and cuttings from the valve seats and ports.

**47. MANIFOLD ASSEMBLY.**

a. **Inspect and Disassemble Intake and Exhaust Manifold Assembly** (fig. 78). Inspect the manifold flanges for cracks and true flat surfaces. Remove the four cap screws which hold the intake and exhaust manifolds together and inspect the heat control valve. If the valve is burned or damaged or the valve shaft is excessively loose in the manifold, chisel away the welds where the valve is welded to the shaft, raise the tabs of the valve and remove the shaft and valve. Install new shaft bushings and valve. Lay the valve against the flat side of the shaft, bend the tabs around the shaft and weld the tabs to the shaft.

b. **Assemble Intake Manifold to Exhaust Manifold.** Lay straightedge (41-S-5858) lengthwise over the gasket surfaces of port flanges of the manifold assembly to check for uniform height of the flanges. If a 0.010-inch feeler gage will pass between the straightedge and any of the manifold flanges, loosen the cap screws which hold the manifolds together and shift the manifolds, if possible, to overcome the uneven con-

**ORDNANCE MAINTENANCE—POWER PLANT, CLUTCH, AND ELECTRICAL SYSTEM— $\frac{3}{4}$  AND  $1\frac{1}{2}$  TON VEHICLES (DODGE)**

**STRAINER ASSEMBLY (CUTAWAY VIEW OF COVER)**



**Figure 80—Oil Strainer**

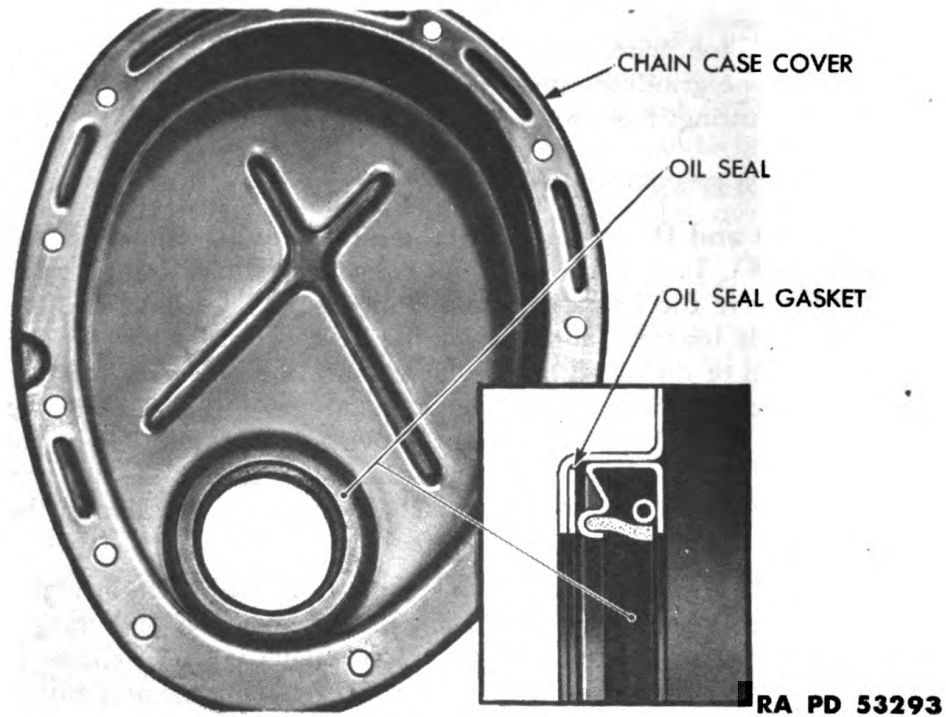

**Figure 81—Chain Case Cover Oil Seal**

## INSPECTION AND REPAIR OF ENGINE COMPONENTS

dition of the flanges. If necessary, resurface the flanges just enough to make them even.

### 48. FLYWHEEL AND CLUTCH HOUSING.

a. **Inspect Flywheel.** Inspect the teeth of the flywheel ring gear and, if damaged, replace the ring gear. Inspect the clutch surface of the flywheel and, if rough or damaged, replace the flywheel.

b. **Replace Ring Gear.** Cut the old ring gear with a chisel, spread it apart and remove it from flywheel. Clean ring gear recess in flywheel thoroughly. Heat the new ring gear to 600 F. (Solder will flow freely at 600 F) Place the ring gear over the flywheel and allow it to shrink into the recess in the flywheel.

c. **Inspect Clutch Housing** (fig. 79). Inspect the clutch housing casting thoroughly, especially the engine support legs for cracks. If any cracks are found, replace the clutch housing.

### 49. OIL PAN AND STRAINER.

a. **Oil Pan.** Inspect the oil pan for dents. If the gasket surfaces are damaged or not level, repair or replace the oil pan.

b. **Oil Strainer** (fig. 80). Open one of the lips on the strainer plate and remove the plate. Remove strainer screen and wash it in dry-cleaning solvent. Shape the screen so that the edges of the relief hole in the center of screen fully contacts the plate. Install strainer plate and bend over lip.

### 50. CHAIN CASE COVER AND FAN PULLEY.

a. **Chain Case Cover** (fig. 81). Inspect the chain case cover gasket surface for being true and smooth. Remove the chain case cover oil seal and gasket from the inside of the cover. Install a new gasket in the cover and drive a new seal into place, making sure the seal seats against the gasket.

b. **Fan Pulley.** Inspect the surface of the fan pulley. If it is worn or scored where the oil seal contacts, replace the pulley.

**ORDNANCE MAINTENANCE—POWER PLANT, CLUTCH, AND  
ELECTRICAL SYSTEM— $\frac{3}{4}$  AND  $1\frac{1}{2}$  TON VEHICLES (DODGE)**

**CHAPTER 2**

**ENGINE AND CLUTCH (Cont'd)**

---

**Section VII**

**ASSEMBLY OF ENGINE**

	<b>Paragraph</b>
General .....	51
Assembly of stripped engine.....	52
Installation of engine accessories.....	53

**51. GENERAL.**

a. **Gaskets and Oil Seals.** When assembling the engine, use new gaskets and oil seals.

b. **Preservative Coating on New Parts.** Remove all traces of grease-type or wax-like preservative coating on new metal parts to be installed in the engine by scrubbing thoroughly with a stiff brush and dry-cleaning solvent.

**52. ASSEMBLY OF STRIPPED ENGINE.**

a. **Mount Cylinder Block in Engine Stand and Install Camshaft Bearings** (figs. 82 and 83). An oil hole is machined in each bearing which must line up with an oil hole in the block (fig. 82). The front bearing has a second oil hole which must line up with the hole which supplies oil to the timing chain. The oil holes are drilled off center in the front bearing, therefore, this bearing must be installed with the oil holes to the rear. After mounting the cylinder block in an engine stand, install the correct size adapter of camshaft bearing tool (fig. 83) in each of the two intermediate bores. Install the correct adapter in the front bearing and start the front bearing in its bore. Insert the installer shaft through all three adapters and install a horseshoe collar forward of the front adapter. With the sliding hammer of the tool, drive the front bearing into place, being sure the oil holes are in alignment. Remove the installer shaft but leave the front and rear adapters in the bores to guide the shaft when installing number two bearing. Place the adapter in number two bearing and start the bearing in its bore. Install the horseshoe collar forward of that bearing and drive the bearing into place. Remove the installer shaft and number three adapter. Place number three bearing in the adapter and drive it into place with the procedure used on the other bearings. The bearings are manufactured to such close limits that no fitting or burnishing is required.

ASSEMBLY OF ENGINE

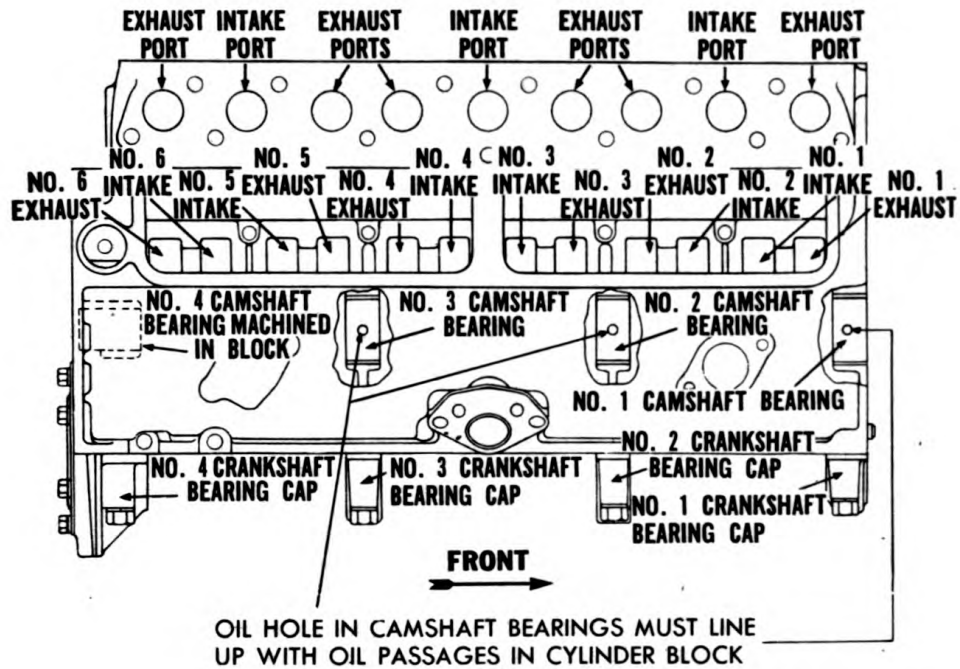

RA PD 53271

Figure 82—Cylinder Block Diagram

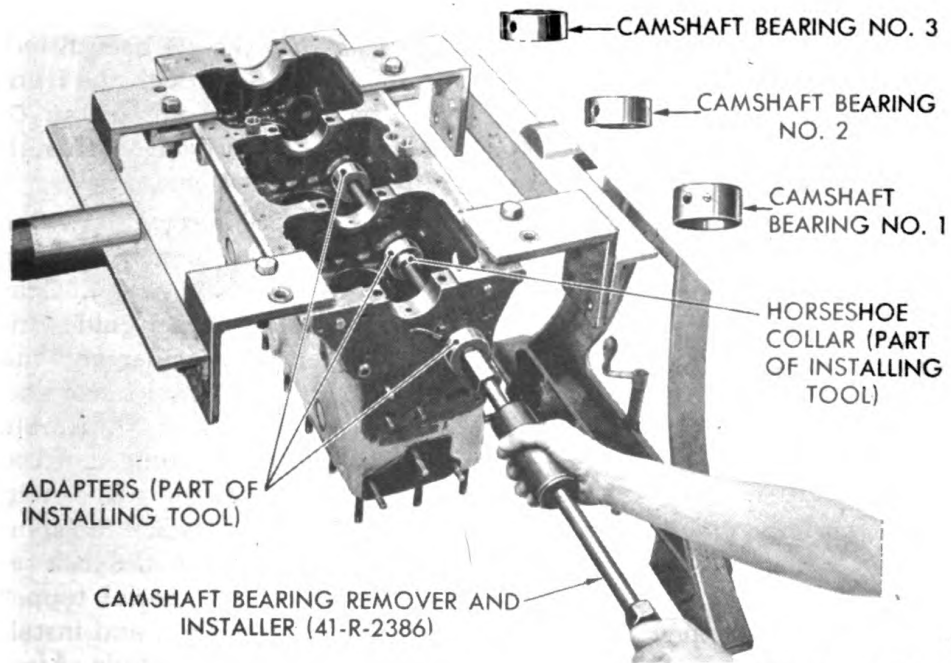

RA PD 53317

Figure 83—Camshaft Bearing Installation

**ORDNANCE MAINTENANCE—POWER PLANT, CLUTCH, AND ELECTRICAL SYSTEM— $\frac{3}{4}$  AND  $1\frac{1}{2}$  TON VEHICLES (DODGE)**

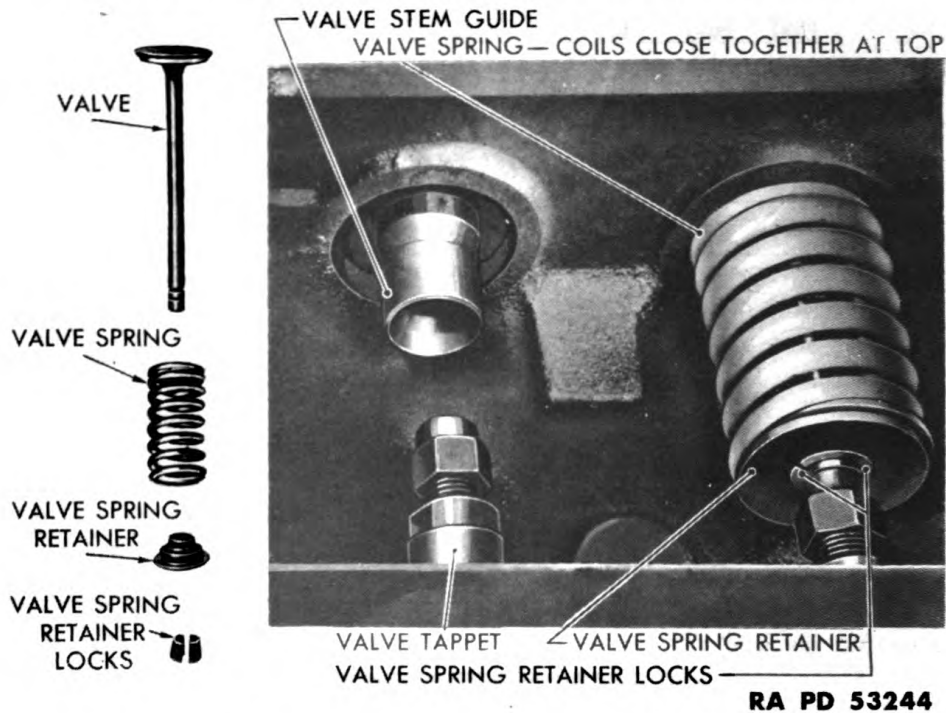
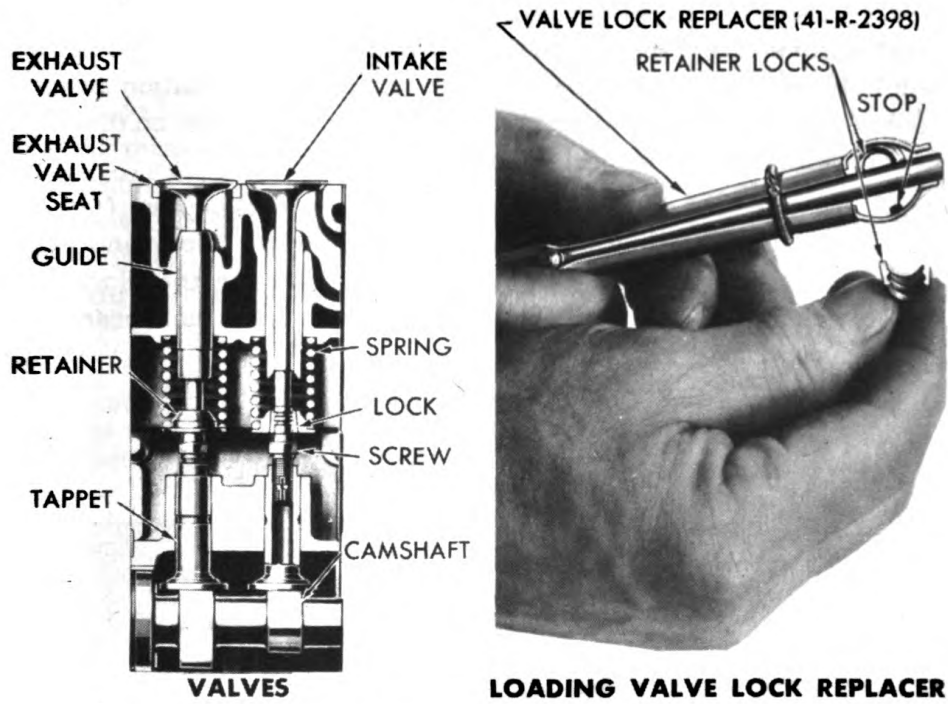

**Figure 84—Valves and Springs**

**b. Install Tappets and Camshaft.** Place the tappets in the guides out of which they originally came, or to which they have been fitted. Coat the camshaft journals with oil, insert the shaft through the front bearing and move it back into position, being careful not to burr or scratch the bearings with the edge of a cam or bearing journal. Install the cap screws which hold the sprocket thrust plate in place.

**c. Install Valves and Springs** (figs. 84 and 85). Place the valve springs in position with the close coiled end of the springs up and the valve spring retainers in the lower end of the springs (fig. 84). Coat the valve stems with oil and install each valve in its proper guide. Insert the jaws of the valve lifter between the spring retainer and the cylinder block with the cupped jaw up. Hold the valve on its seat and raise the valve lifter until the spring is fully compressed. Assemble the valve locks in the lock replacer (fig. 85) with the plunger of the tool pushed out. Place the end of the plunger against the valve stem in line with the grooves in the stem, and push the tool toward the stem to place the locks in position. Lower the lifter and remove the lock replacer. Set valve tappets with a thickness gage and special tappet wrenches so that they have 0.010- to 0.012-inch clearance, and install valve tappet covers with new gaskets on covers, screws and studs. After the engine has been assembled and run-in, readjust the tappets to the proper clearance.

ASSEMBLY OF ENGINE



LOADING VALVE LOCK REPLACER

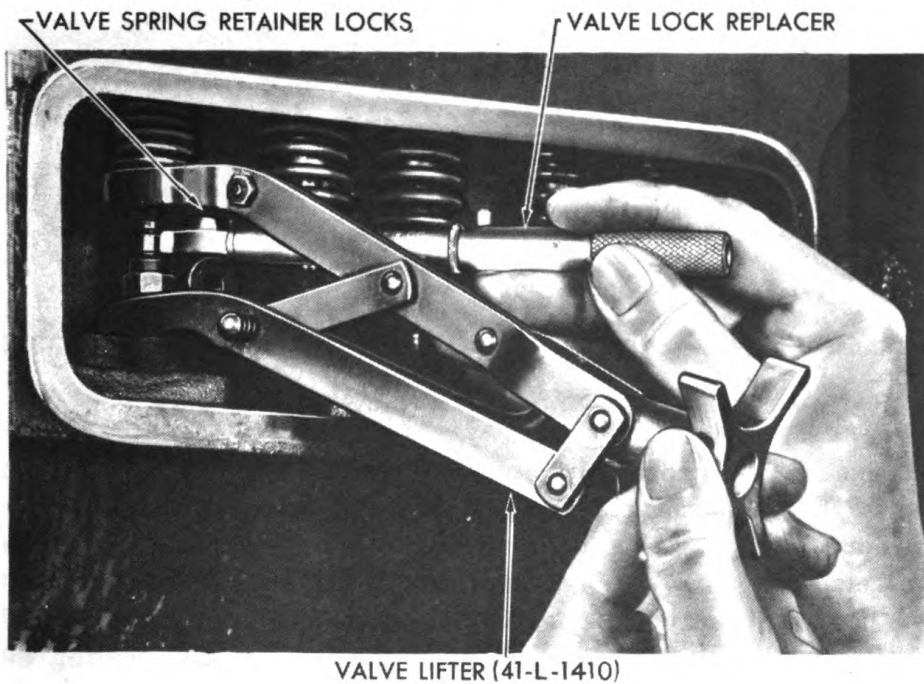

VALVE LIFTER (41-L-1410)

RA PD 53239

Figure 85—Valve Spring Installation



**ORDNANCE MAINTENANCE—POWER PLANT, CLUTCH, AND ELECTRICAL SYSTEM— $\frac{3}{4}$  AND 1 $\frac{1}{2}$  TON VEHICLES (DODGE)**

d. **Assemble Flywheel and Sprocket to Crankshaft.** Place the flywheel over the flange of the crankshaft and install the bolts. The bolt holes are unevenly spaced and will line up in one position only. Install key in crankshaft and press the timing chain sprocket on the end of the crankshaft with the mark O facing out.

e. **Install Clutch Housing, Crankshaft and Bearings (fig. 86).** Place the clutch housing over the dowel pins in the block and install the attaching cap screws. Wipe the bearing bores in the block thoroughly clean and install the upper halves of the crankshaft bearings in

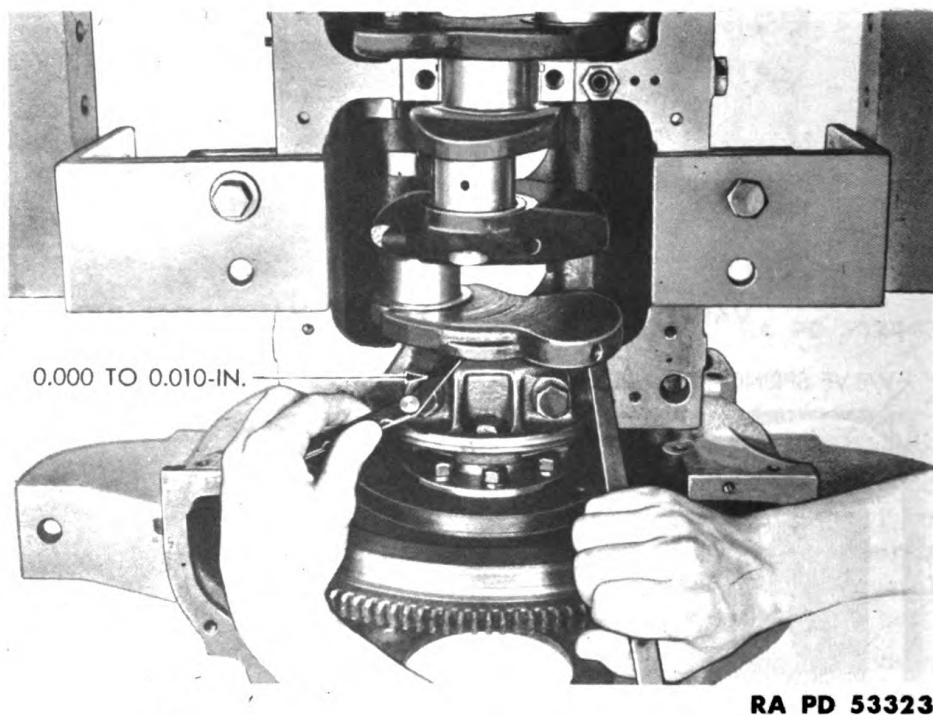

RA PD 53323

**Figure 86—Checking Crankshaft Endplay**

the bores. The upper halves of the front and rear bearings have oil holes while the lower halves do not (fig. 41). Both halves of the intermediate bearings are the same. Assemble the right and left rubber gaskets in the recesses of rear bearing cap (fig. 48). Attach oil seals to the block and cap, leaving the oil seal cap screws loose. Lay the crankshaft assembly in the bearings. Install the rear cap and bearing with gaskets and tighten the bearing and oil seal cap screws. Check the end play of the crankshaft by prying the shaft toward and measuring the clearance between the front end of the bearing and the side of the adjacent crankthrow (fig. 86). If the end play exceeds 0.010 inch with new

**ASSEMBLY OF ENGINE**

bearing, replace the crankshaft. Install other bearings and caps and tighten the cap screws to 75 to 80 foot-pounds.

f. **Assemble Pistons and Connecting Rods.** Heat the piston to 160 F, and place the upper end of the connecting rod in the piston with the small oil hole in the lower end of the rod opposite the slotted side of the piston. Insert the piston pin through the piston and connecting rod bushing. Install a new retaining ring in the piston at each end of the pin. Install the piston rings of the type selected (par. 45 c) with piston ring applier (fig. 87).

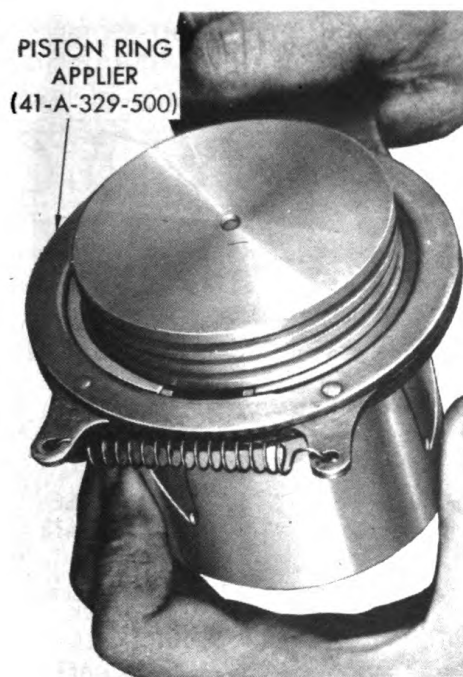

RA PD 53332

**Figure 87—Piston Ring Installation**



RA PD 53324

**Figure 88—Piston and Connecting Rod Assembly Installation**

g. **Install Piston and Connecting Rod Assemblies** (figs. 88 and 89). Coat the piston and rings with engine oil and space the ring gaps evenly around the circumference of the piston. Install the piston ring compressor over the rings and install the piston in the cylinder (fig. 88) with the oil hole in large end of the connecting rod toward the valve side of the engine. Connecting rods for numbers 1, 3 and 5 cylinders are offset in one direction and numbers 2, 4 and 6 are offset in the opposite direction (fig. 89). Therefore, each connecting rod must be installed in its original position. If one or more new connecting rods are to be

**ORDNANCE MAINTENANCE—POWER PLANT, CLUTCH, AND ELECTRICAL SYSTEM— $\frac{3}{4}$  AND 1 $\frac{1}{2}$  TON VEHICLES (DODGE)**

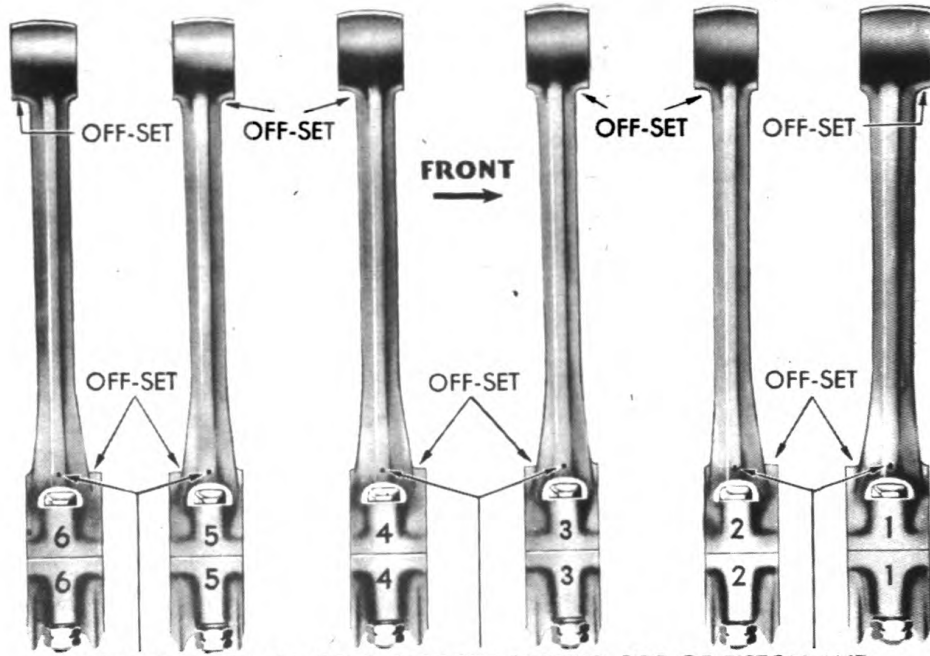

ASSEMBLE WITH OIL HOLE OPPOSITE SLOTTED SIDE OF PISTON AND TOWARDS VALVE SIDE OF ENGINE

**RA PD 53272**

**Figure 89—Connecting Rod Sequence**

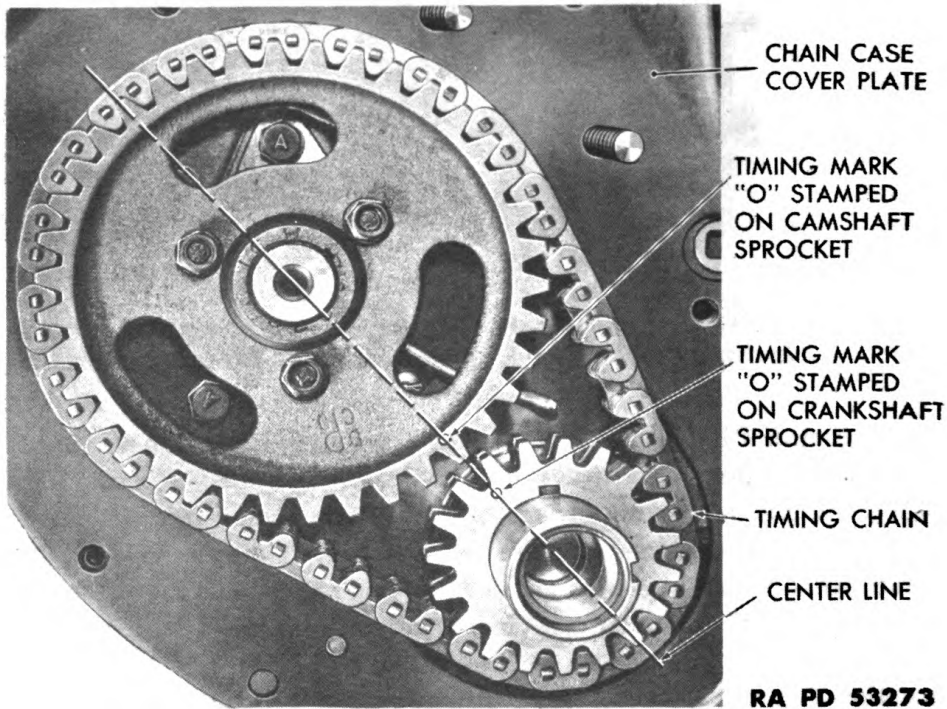

**RA PD 53273**

**Figure 90—Timing Chain and Sprocket Installation**

**ASSEMBLY OF ENGINE**

used, be sure each rod has the proper offset for the cylinder in which it is to be installed. Wipe the bores of the connecting rods and the bearing caps thoroughly clean, install the bearings and attach the connecting rods to the crankshaft using new lock washers. Tighten the cap bolt nuts to 45 to 50 foot-pounds with torque wrench.

**h. Install Camshaft Sprocket and Timing Chain (fig. 90).** Install the chain case cover plate with a new gasket. Turn the crankshaft so that the mark O on the face of the crankshaft sprocket is directly in line with the crankshaft and camshaft centers. Place the camshaft sprocket on its hub and install two cap screws temporarily. Turn the camshaft until the mark O on the camshaft sprocket is also directly in line with the crankshaft and camshaft centers, then remove the camshaft sprocket. Place the chain around both sprockets and reinstall the camshaft sprocket. When the installation is completed, the O marks on

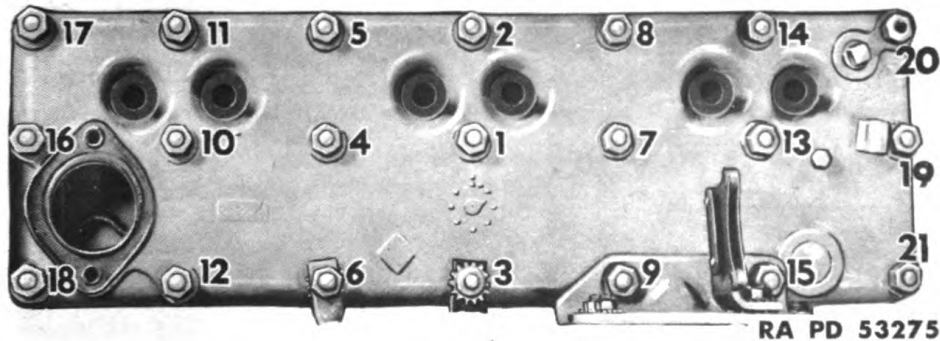

**Figure 91—Cylinder Head Nut Tightening Sequence**

both sprockets must be directly between the crankshaft and camshaft centers.

**i. Install Chain Case Cover, Engine Support and Fan Pulley.** Place a new gasket on the cover and install the cover with the cover reinforcement over the five lower screw holes. Start the attaching cap screws but do not tighten. Drive or push the fan pulley into place and install shakeproof lock washer and starting crank jaw (1<sup>3</sup>/<sub>16</sub>-inch socket, 41-W-2620). Then tighten the cover attaching screws and nuts. Attach the engine front support to the chain case cover plate.

**j. Install Cylinder Head (fig. 91).** With a clean cloth, wipe the surfaces of the cylinder head and block thoroughly clean. Wipe the tops of the cylinder bores and pistons clean and blow off with compressed

**ORDNANCE MAINTENANCE—POWER PLANT, CLUTCH, AND ELECTRICAL SYSTEM—¾ AND 1½ TON VEHICLES (DODGE)**

air. Apply a thin coating of engine oil or joint and thread compound to both sides of a new cylinder head gasket and place the gasket over the cylinder head studs. Place the oil filter bracket over studs 9 and 15 (fig. 91). Connect the oil filter pipes to the filter and crankcase. Place a shakeproof lock washer, then thermometer wire clip over stud 19, and a shakeproof lock washer over stud 6. Install the breather pipe in the crankcase with the pipe bracket over stud 6. Install the cylinder head stud nuts and cap screws in the order shown in figure 91. Tighten the stud nuts to 52½ to 57½ foot-pounds and the cap screw to 65 to 70 foot-pounds with torque wrench (41-W-3630).

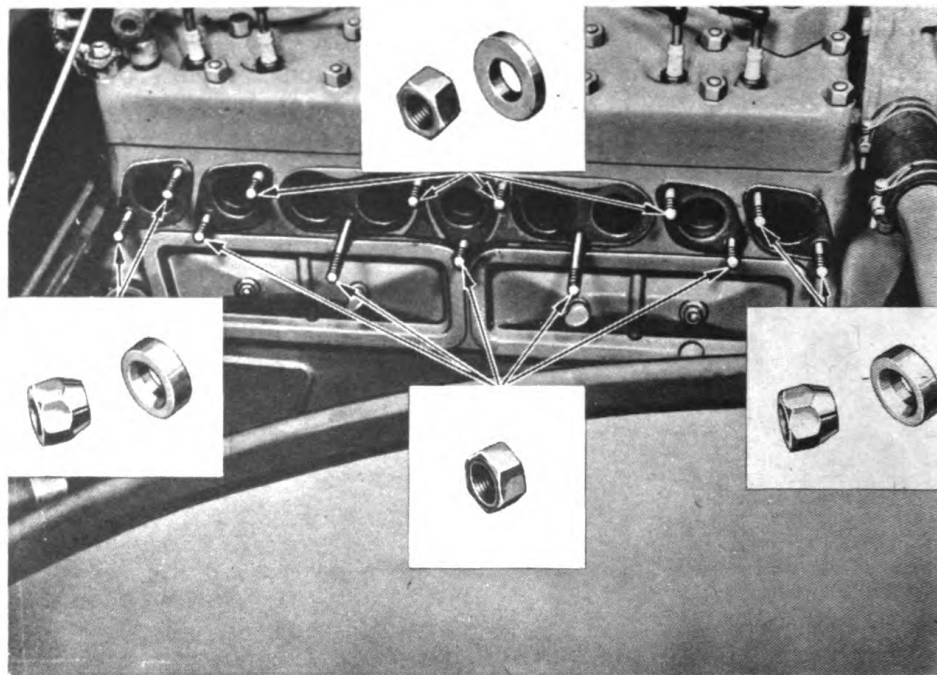

RA PD 53278

**Figure 74—Manifold Stud Nuts and Washers**

**k. Install Manifold Assembly (fig. 92).** Place the manifold assembly over the flange studs and install washers and nuts in the order shown in figure 92. If the crankcase ventilator is of the outlet pipe and air cleaner type put the ventilator in place and install the attaching cap screws. If the ventilator is of the positive type connect the vent tube to the crankcase and the manifold.

**l. Install Oil Relief Valve and Thermostat (figs. 93 and 94).** Apply compressed air to the oil relief valve opening to remove any dirt or foreign matter. Wash the plunger, spring and cap in engine oil, and install in that order with a good gasket under the cap (fig. 93). Install the thermostat with mark **FRONT** toward radiator with gaskets above

ASSEMBLY OF ENGINE

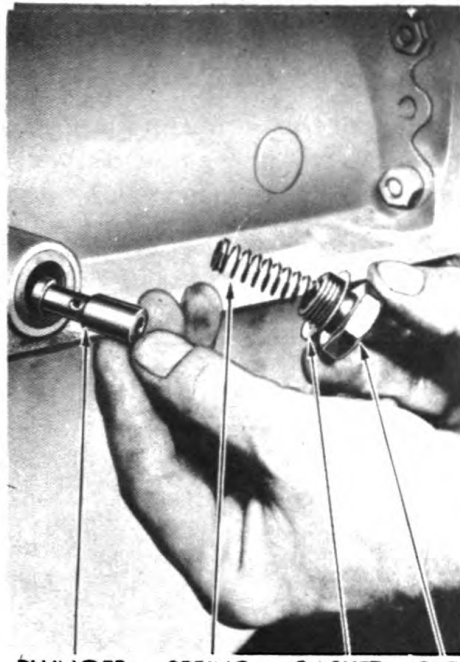

PLUNGER SPRING GASKET CAP  
RA PD 53277

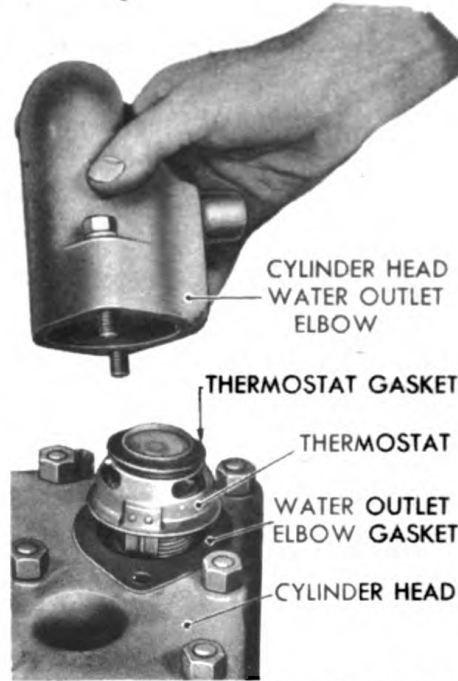

RA PD 53276

**Figure 93—Oil Pressure Relief Valve Installation**

**Figure 94—Thermostat Installation**

ASSEMBLE OIL STRAINER AND SUCTION PIPE IN LINE WITH THE CRANKSHAFT REAR BEARING ATTACHING SCREW—RIGHT

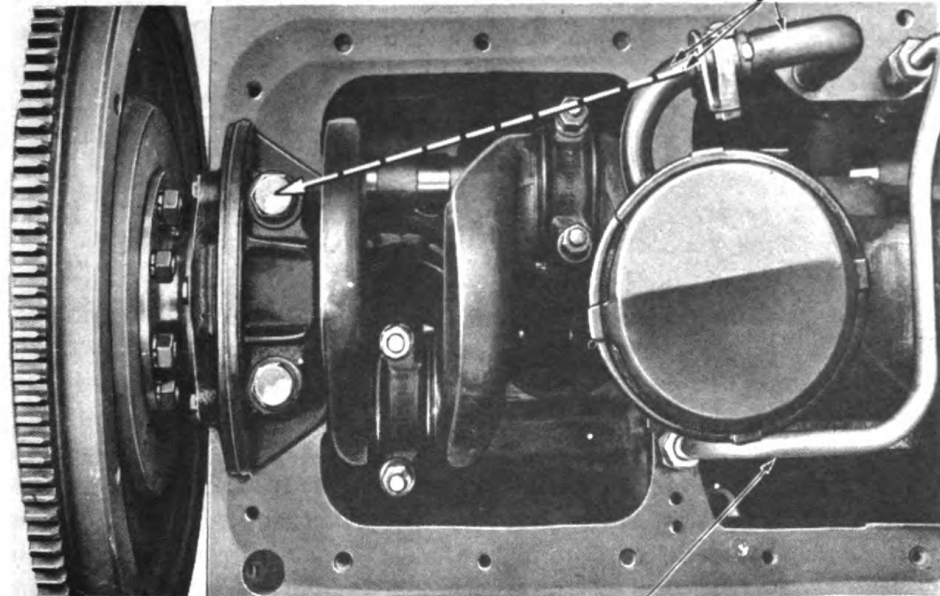

OIL PUMP OUTLET PIPE

RA PD 53291

**Figure 95—Floating Oil Strainer Installation**

**ORDNANCE MAINTENANCE—POWER PLANT, CLUTCH, AND ELECTRICAL SYSTEM— $\frac{3}{4}$  AND 1 $\frac{1}{2}$  TON VEHICLES (DODGE)**

and below thermostat (fig. 94). Install the elbow and tighten the cap screws.

m. **Install Oil Strainer** (fig. 95). Install the oil pump inlet pipe. Then connect the strainer to the pipe and insert a new cotter pin. *Position the strainer and elbow as shown in figure 95, so that movement of the strainer is not restricted by the oil pan baffles.*

n. **Install Oil Pan** (fig. 96). Place new end gaskets in position and let the ends of the gaskets protrude, as they will be compressed into place when the pan is installed. Place new side gaskets over the ends of the end gaskets. Remove the engine from the stand, and install the pan and attaching cap screws.

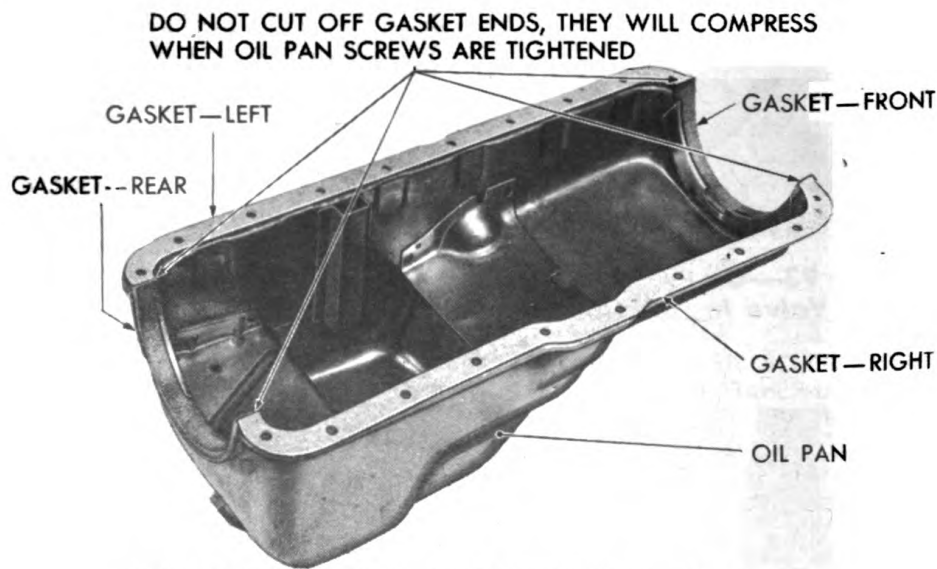

HOLD SIDE GASKETS IN PLACE WITH HEAVY GREASE OR TIE IN PLACE WITH LIGHT STRING THROUGH SEVERAL SCREW HOLES WHILE INSTALLING THE OIL PAN. IF STRING IS USED, REMOVE STRING BEFORE TIGHTENING SCREWS.

**RA PD 53252**

**Figure 96—Oil Pan Gaskets**

**53. INSTALLATION OF ENGINE ACCESSORIES.**

a. **Install Carburetor and Governor Assembly.** Examine carburetor manifold studs and replace or tighten, as required. Place a new gasket over the manifold studs and install the carburetor with the air opening facing the rear of the engine. Attach the carburetor to the manifold with lock washers and nuts. Attach the carburetor control rod ball joint to the carburetor throttle lever. Connect the fuel tube to the carburetor.

ASSEMBLY OF ENGINE

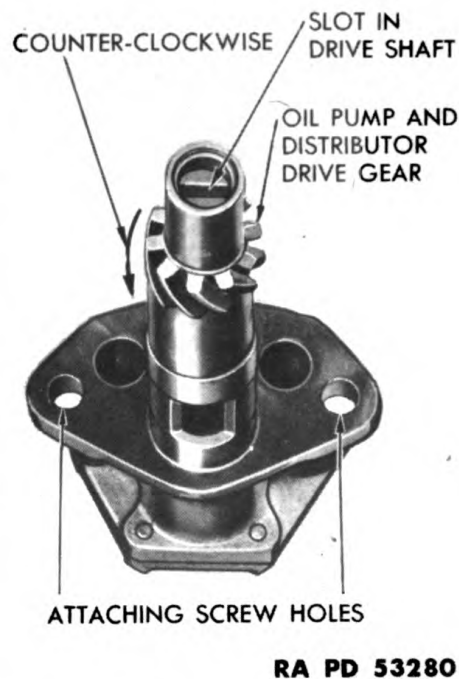
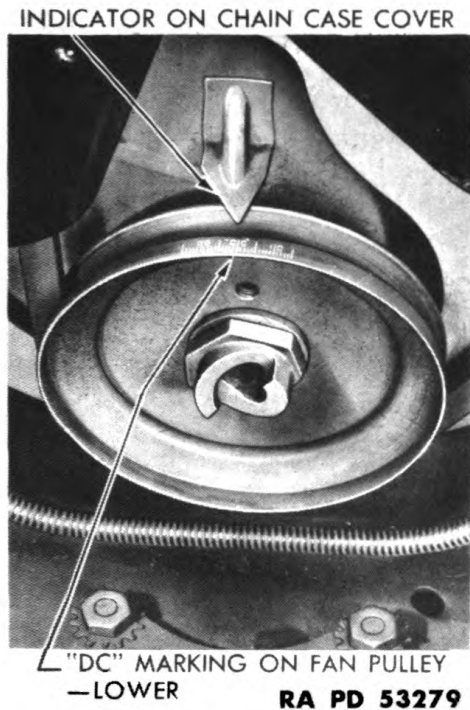

**Figure 97—Timing Marks on Fan Pulley**

**Figure 98—Lining Up Slot in Oil Pump Shaft**

**b. Install Fuel Pump.** Place a new cylinder block to fuel pump gasket on the fuel pump and insert the fastening cap screws with lock washers into the fuel pump body. Attach the fuel pump to the block. Connect the carburetor fuel tube to the pump. Place the heat shield over the stud on the pump and insert the end of the shield under the exhaust manifold end stud nut. Tighten the exhaust stud nut and install and tighten the wing nut on the pump.

**c. Install Water Distributing Tube and Water Pump.** Insert the water distributing tube in the block. Place a new water pump gasket on the three water pump attaching studs and install the water pump on the studs. Install the generator adjusting strap on the left hand stud and install the stud nut with a shakeproof lock washer. Do not tighten the nut securely until the fan belt is adjusted. Install the other two lock washers and nuts on the water pump attaching studs and tighten securely. Install the bypass elbow and hose assembly on the pump, using new gaskets.

**d. Install Oil Pump** (figs. 97 and 98). Crank engine by hand and hold thumb tightly over number one cylinder spark plug hole, or install a compression gage in the number one spark plug hole to determine when the piston is rising on the compression stroke. When compression is felt by thumb or shows on gage, turn crank until piston is on top dead



**ORDNANCE MAINTENANCE—POWER PLANT, CLUTCH, AND ELECTRICAL SYSTEM— $\frac{3}{4}$  AND  $1\frac{1}{2}$  TON VEHICLES (DODGE)**

center as indicated when the indicator points to "DC" on fan pulley (fig. 97). Turn pump drive shaft until the slot in the end of the drive shaft lines up with the holes in the mounting flange. Then turn the shaft gear one tooth counterclockwise (fig. 98). Carefully install the pump while holding it in this position. Do not turn the drive gear while installing the pump.

e. **Install Ignition Units** (figs. 99 and 100). Turn the distributor rotor until it points to about "seven o'clock" (fig. 99). Then insert dis-

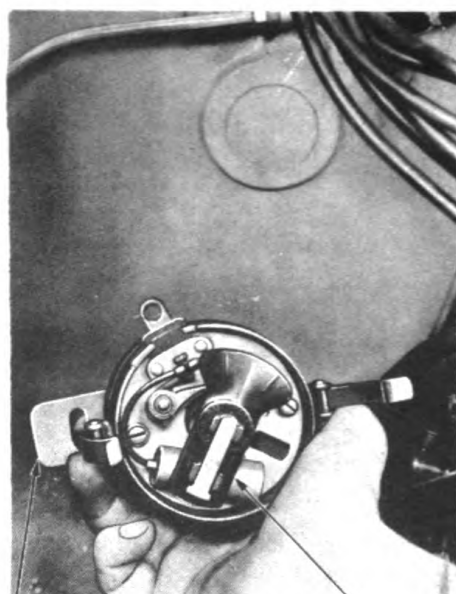

DISTRIBUTOR LOCK PLATE  
DISTRIBUTOR ROTOR IN SEVEN  
O'CLOCK POSITION

RA PD 53281

**Figure 99—Distributor Installation**

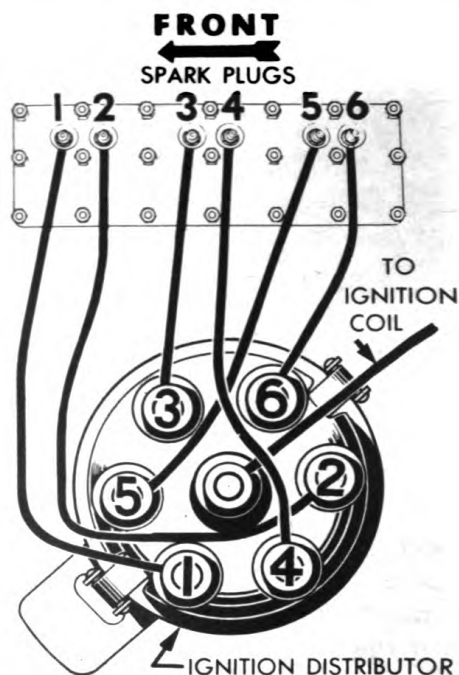

RA PD 53282

**Figure 100—Spark Plug Cable Connections**

tributor into the cylinder block opening and move the rotor back and forth slightly to allow tongue of distributor shaft to engage slot of oil pump drive shaft. Install lock plate hold-down cap screw with a shake-proof lock washer but do not tighten. Rotate distributor body until the points are just about to open. Tighten hold-down cap screw. Install the distributor cap with the distributor to spark plug cables attached (fig. 100) registering the projection in the cap opening with the notch in the distributor body. Lock the distributor cap in place with the two cap hold-down springs. Attach the cable bracket to the left hand center cylinder stud. Install the spark plugs with new gaskets and attach the spark plug cables to the plug terminals.

**ASSEMBLY OF ENGINE**

COAT CRANKSHAFT BUSHING WITH GREASE. GENERAL PURPOSE NO. 2

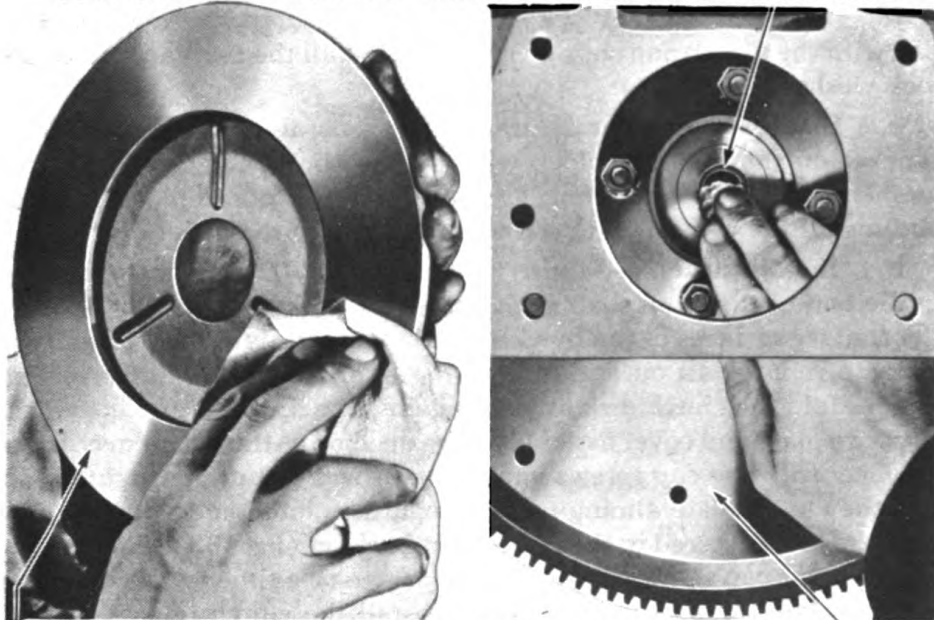

WIPE CONTACT SURFACES OF FLYWHEEL AND PRESSURE PLATE CLEAN

RA PD 53283

**Figure 101—Cleaning Clutch Friction Surfaces and Lubricating Pilot Bushing**

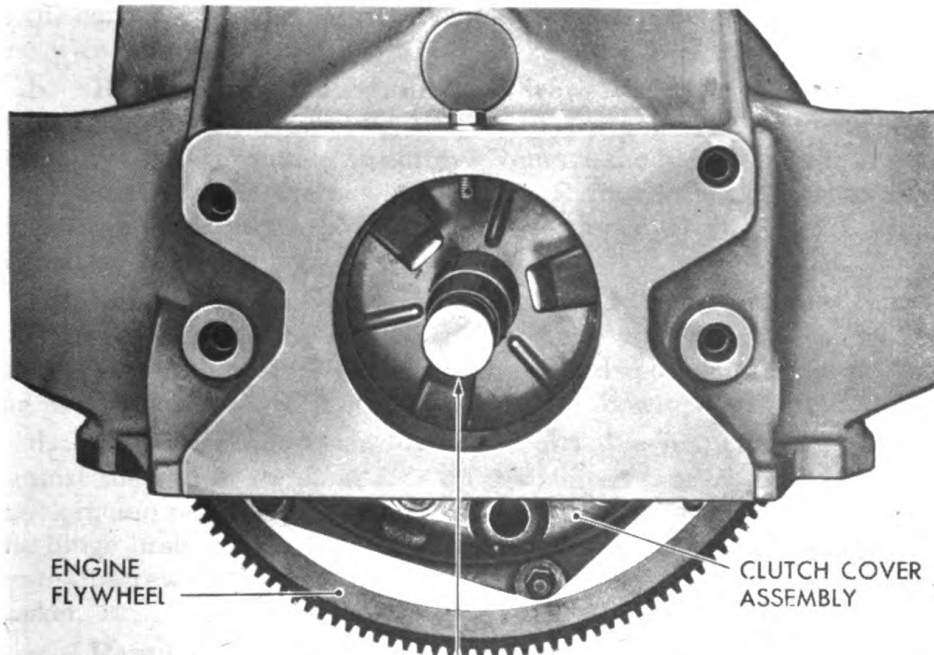

ENGINE FLYWHEEL

CLUTCH COVER ASSEMBLY

CLUTCH DISK ALINING TOOL (41-T-3085)

RA PD 53284

**Figure 102—Clutch Disk Installation**

**ORDNANCE MAINTENANCE—POWER PLANT, CLUTCH, AND ELECTRICAL SYSTEM— $\frac{3}{4}$  AND  $1\frac{1}{2}$  TON VEHICLES (DODGE)**

f. **Install Starter.** Place starter on the clutch housing attaching pad with the switch and shift lever up and install the two cap screws and lock washers.

g. **Install Generator.** Attach the generator to the mounting bracket on the cylinder block with the two bolts and nuts with lock washers. Attach the adjusting strap to the water pump mounting stud and install the cap screw to connect the strap to the generator.

h. **Install Clutch Assembly** (figs. 101 and 102). Coat the bushing in the end of the crankshaft with general purpose grease, No. 2. Wipe the contact surfaces of the flywheel and pressure plate with a clean dry cloth to remove all oil and foreign material from these surfaces (fig. 101). Hold the clutch disk in place against the flywheel and install the pressure plate and cover assembly over the disk. Attach the cover to the flywheel with the cap screws and lock washers, but do not tighten. Insert the clutch plate alining tool through the clutch and aline the disk with the tool centered in the crankshaft bushing (fig. 102). Tighten the clutch cover cap screws evenly a turn or two at a time to avoid distorting the cover, and remove the tool. Install the clutch release bearing and sleeve and connect the spring to the pull-back spring screw in the clutch housing. Attach the clutch housing pan.

CHAPTER 2

ENGINE AND CLUTCH (Cont'd)

Section VIII

**CARBURETOR AND GOVERNOR (ZENITH) AND FUEL PUMP REBUILDING**

	Paragraph
Disassembly of carburetor.....	54
Inspection of carburetor parts.....	55
Assembly of carburetor.....	56
Disassembly of throttle body and governor assembly.....	57
Inspection and repair of governor parts.....	58
Assembly of throttle body and governor assembly.....	59
Disassembly of fuel pump.....	60
Inspection and repair of fuel pump parts.....	61
Assembly of fuel pump.....	62

(See supplement in back of this manual for maintenance information on Carter carburetor).

**54. DISASSEMBLY OF CARBURETOR.**

a. **Clean Carburetor and Governor Assembly.** Wash the outside of the carburetor and governor assembly with dry-cleaning solvent, and dry with compressed air.

b. **Remove Bowl Cover and Bowl from Air Intake (fig. 103).** Remove the two long screws (fig. 103, A) that attach the carburetor bowl assembly to the air intake assembly. Remove the bowl to intake gasket (fig. 103, AA) from the bowl assembly. Remove the two screws that attach the cover to the bowl and remove the cover (fig. 103, C) and gasket.

c. **Remove Main Discharge Tube and Idle Adjustment Screw (fig. 103).** Remove the main discharge tube (fig. 103, ZZ) and fiber washer from the bottom of the fuel bowl and remove the idle adjusting needle (fig. 103, R) and spring from the bowl cover.

d. **Remove Float Assembly and Fuel Valve Seat (fig. 104).** Press against the end of the float axle on the slotted side of the float hinge bracket, and pull the float axle (fig. 103, N) out of the opposite side of the hinge bracket. Remove the fuel valve needle from the fuel valve seat. Unscrew the fuel valve seat with wrench and remove the seat and gasket.

e. **Remove Vacuum Piston and Pump Assembly (fig. 104).** The pump piston assembly is held in the bowl cover with a spring retainer pressed into the bore of the pump cylinder. Push the piston down against the spring as far as it will go and withdraw the piston sharply.

ORDNANCE MAINTENANCE—POWER PLANT, CLUTCH, AND  
ELECTRICAL SYSTEM— $\frac{3}{4}$  AND  $1\frac{1}{2}$  TON VEHICLES (DODGE)

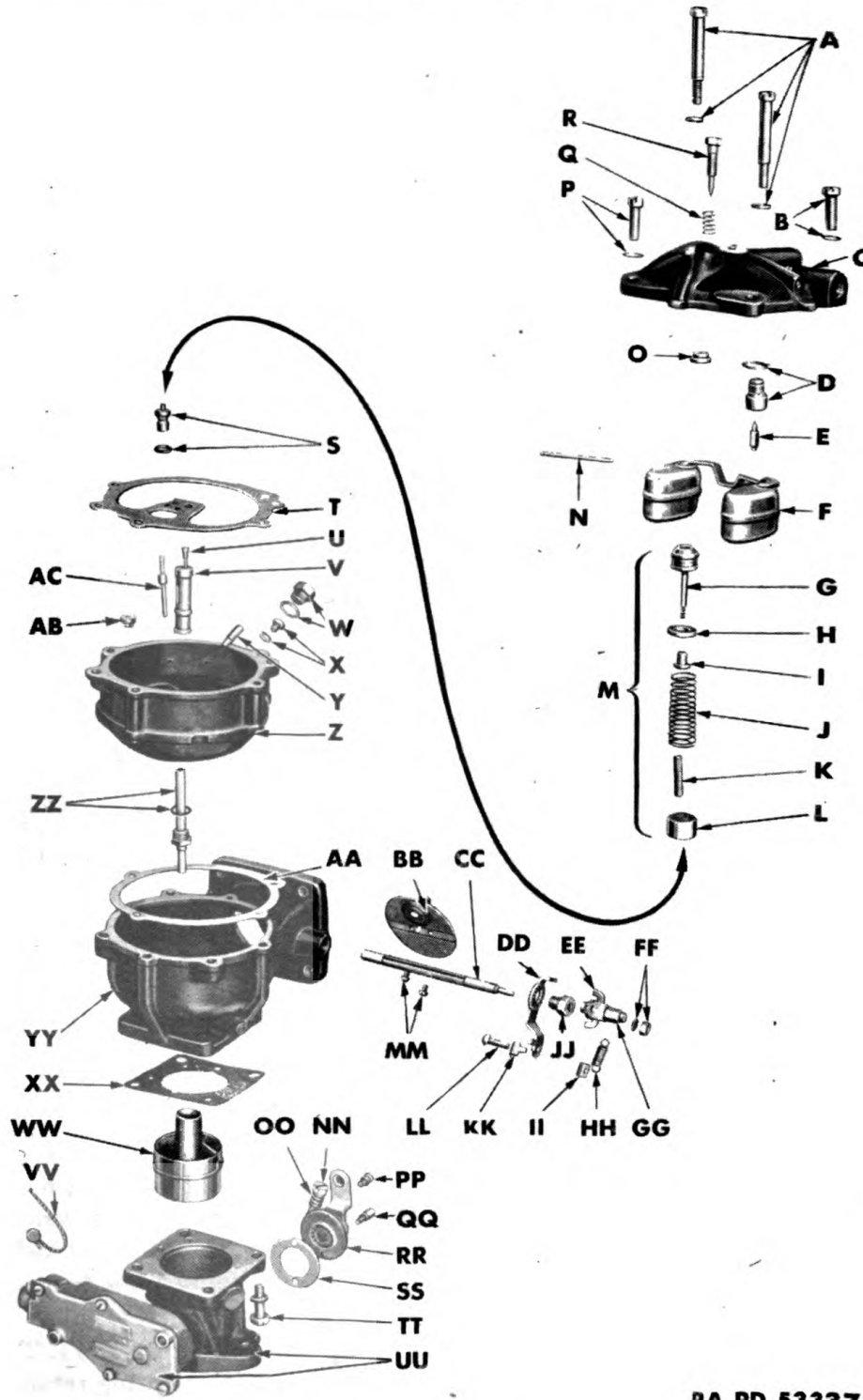

RA PD 53337

Figure 103—Carburetor Disassembled

**CARBURETOR AND GOVERNOR (ZENITH) AND  
FUEL PUMP REBUILDING**

- A**—FUEL BOWL TO INTAKE SCREWS AND LOCKWASHERS
- B**—BOWL COVER SCREWS AND LOCKWASHERS
- C**—BOWL COVER
- D**—FUEL VALVE SEAT AND GASKET
- E**—FUEL VALVE NEEDLE
- F**—FLOAT
- G**—VACUUM PISTON AND ROD
- H**—VACUUM PUMP SPRING RETAINER
- I**—VACUUM PUMP COLLAR
- J**—VACUUM PUMP SPRING—OUTER
- K**—VACUUM PUMP SPRING—INNER
- L**—ACCELERATOR PUMP PISTON
- M**—VACUUM PISTON AND PUMP ASSEMBLY
- N**—FLOAT AXLE
- O**—ACCELERATOR PUMP REFILL CHECK VALVE
- P**—BOWL COVER SCREWS AND LOCKWASHERS
- Q**—IDLE ADJUSTING NEEDLE SPRING
- R**—IDLE ADJUSTING NEEDLE
- S**—POWER JET VALVE AND GASKET
- T**—BOWL TO COVER GASKET
- U**—ACCELERATOR JET
- V**—METERING WELL
- W**—FUEL BOWL LOWER PLUG AND GASKET
- X**—MAIN JET AND GASKET
- Y**—WELL VENT
- Z**—FUEL BOWL
- AA**—FUEL BOWL TO INTAKE GASKET
- BB**—AIR SHUTTER
- CC**—AIR SHUTTER SHAFT
- DD**—AIR SHUTTER BRACKET
- EE**—AIR SHUTTER LEVER
- FF**—AIR SHUTTER SHAFT NUT AND LOCKWASHER
- GG**—AIR SHUTTER LEVER SWIVEL SCREW
- HH**—AIR SHUTTER SPRING
- II**—AIR SHUTTER BRACKET WIRE CLAMP SCREW NUT
- JJ**—AIR SHUTTER BRACKET SCREW
- KK**—AIR SHUTTER BRACKET WIRE CLAMP
- LL**—AIR SHUTTER BRACKET WIRE CLAMP SCREW
- MM**—AIR SHUTTER RETAINER SCREWS
- NN**—THROTTLE STOP SCREW
- OO**—THROTTLE STOP SCREW SPRING
- PP**—THROTTLE LEVER AND DRIVER SCREW AND LOCKWASHER
- QQ**—THROTTLE LEVER AND DRIVER STOP SCREW
- RR**—THROTTLE LEVER AND DRIVER
- SS**—THROTTLE LEVER AND DRIVER GASKET
- TT**—THROTTLE BODY TO INTAKE SCREW AND LOCKWASHER
- UU**—THROTTLE BODY AND GOVERNOR ASSEMBLY
- VV**—GOVERNOR SEAL AND WIRE
- WW**—SECONDARY VENTURI
- XX**—THROTTLE BODY TO INTAKE GASKET
- YY**—AIR INTAKE
- ZZ**—DISCHARGE TUBE AND GASKET
- AB**—ACCELERATOR PUMP CHECK VALVE
- AC**—IDLING JET

**RA PD 53337-B**

**Legend for Figure 103, Carburetor Disassembled**

**ORDNANCE MAINTENANCE—POWER PLANT, CLUTCH, AND ELECTRICAL SYSTEM—¾ AND 1½ TON VEHICLES (DODGE)**

This will cause the piston to strike the retainer and release the assembly (fig. 103, M) from the cover. If the retainer is a very tight fit, it may be necessary to repeat the operation.

f. **Remove Accelerating Pump Refill Check Valve and Disk** (fig. 104). Insert the tapered thread end of extractor tool into the check valve in the cover, and turn the tool counterclockwise until it is firmly fastened in the valve. Strike the sliding weight sharply against the stop bar of the tool until valve is removed, then remove the disk.

g. **Remove Idle Jet, Bowl Plug and Main Jet** (fig. 104). Lift out the idle jet (fig. 103, AC) and remove the fuel bowl lower plug (fig. 103, W) and fiber washer from the side of the fuel bowl. Then remove the main jet and fiber washer from the inside of the bottom of the fuel bowl.

h. **Remove Well Vent, Well and Accelerating Jet** (fig. 104). Remove the well vent from the fuel bowl with wrench. Insert the hollow end of metering well drift into the passage in the bottom center of the fuel bowl and when it contacts with the metering well, tap the end of the drift lightly to remove the well. Unscrew the accelerating jet (fig. 103, U) from the well.

i. **Remove Accelerator Pump Check Valve and Disk** (fig. 105). Insert the tapered thread end of extractor into the valve body inside of the fuel bowl, and turn the tool counterclockwise until tool is firmly fastened into valve body. Strike the bent over end of the tool lightly until the valve body is removed.

j. **Remove Power Jet Valve and Fiber Gasket** (fig. 105). Unscrew the power jet valve (fig. 103) and fiber gasket from the bottom of the pump cylinder with wrench.

k. **Separate Air Intake from Throttle Body Assembly and Remove Secondary Venturi** (fig. 103). Place a scratch or file mark across the sides of the flanges attaching the air intake assembly to the throttle body for identification. Remove the attaching screws from the air intake. Remove the secondary venturi and gasket from the air intake body. For disassembly of throttle body and governor, refer to paragraph 57.

l. **Remove Air Shutter and Shaft** (figs. 103 and 105). Remove the air shutter spring from the bracket on the intake assembly. Remove the air shutter lever retaining nut, lock washer and lever from the end of the air shutter shaft. Mark the air shutter bracket and air intake body with a file or other identifying mark, so the bracket can be returned to the same position when assembled. Then remove the bracket retaining screw and bracket. File off the two air shutter retainer screw ends where they are riveted over the shaft and remove the screws. Pull the air shutter out of the shaft slot and remove it through the air intake body. Pull the air shutter shaft out of the body. *Do not remove the*

**CARBURETOR AND GOVERNOR (ZENITH) AND FUEL PUMP REBUILDING**

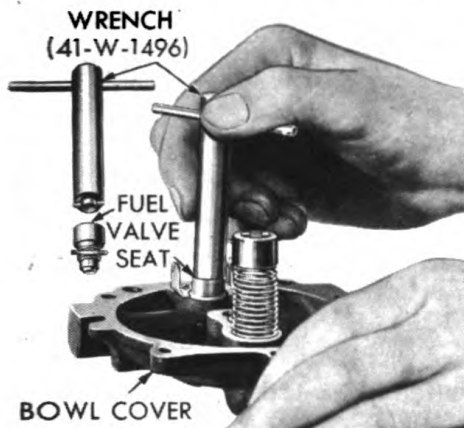

**1—REMOVING FUEL VALVE SEAT**



**2—REMOVING VACUUM ACCELERATING PUMP PISTON ASSEMBLY**



REFILL CHECK VALVE BODY AND DISK  
**3—REMOVING ACCELERATING PUMP REFILL CHECK VALVE**

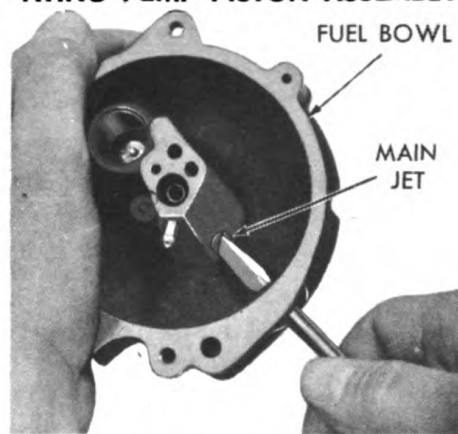

**4—REMOVING MAIN JET**

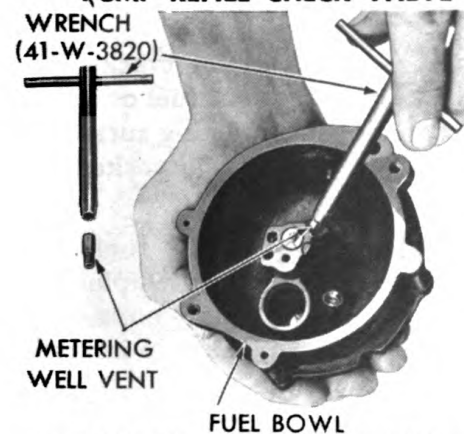

**5—REMOVING OR INSTALLING METERING WELL VENT**

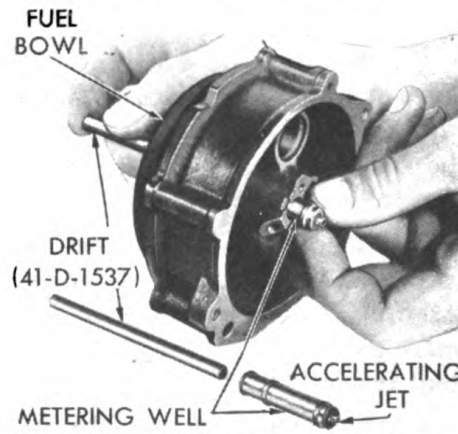

**6—REMOVING METERING WELL AND ACCELERATING JET**

RA PD 53360

**Figure 104—Carburetor Rebuilding**



**ORDNANCE MAINTENANCE—POWER PLANT, CLUTCH, AND ELECTRICAL SYSTEM— $\frac{3}{4}$  AND  $1\frac{1}{2}$  TON VEHICLES (DODGE)**

*pitot tube located in the air entrance, the air shutter bracket locating pin or the channel plug.*

**55. INSPECTION OF CARBURETOR PARTS.**

a. **Clean All Parts.** Wash all parts in dry-cleaning solvent, and dry with compressed air (par. 40 b). Blow out all passages and orifices thoroughly with compressed air. *Do not use metal parts, such as a drill or wire to clean out jets or passages.*

b. **Inspect Float Assembly** (fig. 103). Replace the float assembly if excess wear exists where the float lever contacts the fuel valve needle or if it is crushed, damaged or leaking as indicated by fuel inside the float, as the float assembly cannot be satisfactorily repaired.

c. **Inspect Float Axle** (fig. 103). Replace the float axle if any wear can be detected on the bearing surface.

d. **Inspect Idle Adjusting Needle** (fig. 103). Inspect the idle needle threads and point. Replace the needle if the point is not smooth and free of ridges or scores.

e. **Inspect Air Shutter** (fig. 103). Examine the air shutter for burs, distortion or damaged edges. Check poppet valve for free operation. Replace the air shutter if it appears to be unsatisfactory in any way.

f. **Inspect Air Shutter Shaft and Lever Assembly** (fig. 103). Replace the air shutter shaft (fig. 103) if it is worn on the bearing surfaces. Replace the lever (fig. 103) if it is not a tight fit on the shaft; if the control wire fastening screw does not hold the wire tight, or if the lever is excessively bent. If the lever is only slightly bent out of line, it can be bent back into proper alinement.

g. **Inspect All Castings.** Examine all castings for cracks, sand holes or irregular surfaces which might cause leakage of fuel or air and result in improper fuel-air mixture. Examine all contacting surfaces of the castings for scores or roughness that might damage gaskets and prevent a tight seal between the parts.

h. **Replace Fuel Valve Assembly** (fig. 103). The fuel valve needle and seat (fig. 103) are supplied as an assembly. Replace the assembly when making a complete carburetor repair as both of the valve parts wear. Faulty operation of the valve will result in improper float level.

i. **Replace Vacuum Pump Assembly** (fig. 103). Replace the vacuum pump assembly because the extent of wear of the vacuum and accelerating pistons cannot be determined by visual inspection.

j. **Replace Power Jet Valve** (fig. 103). Replace this part because the extent of wear cannot be determined by visual inspection.

### CARBURETOR AND GOVERNOR (ZENITH) AND FUEL PUMP REBUILDING

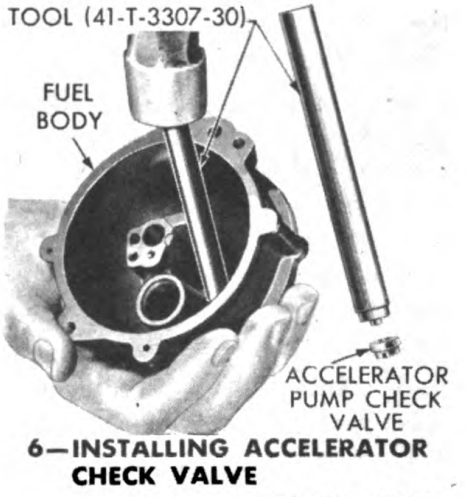
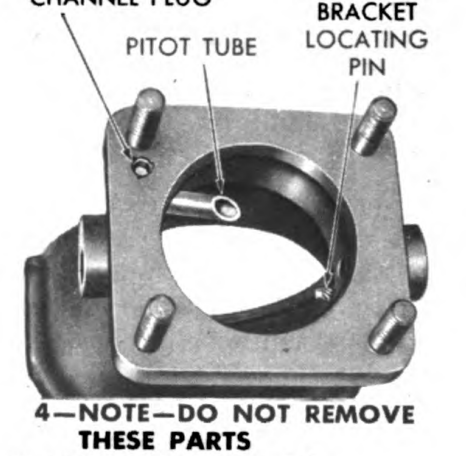
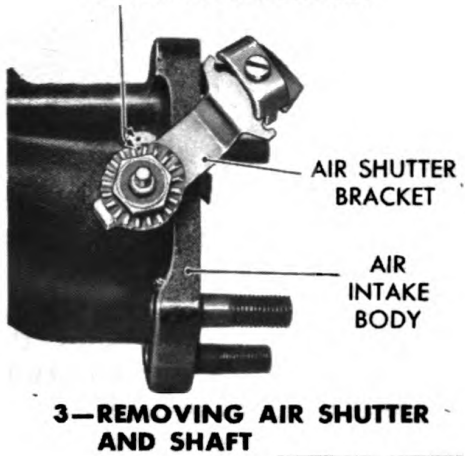
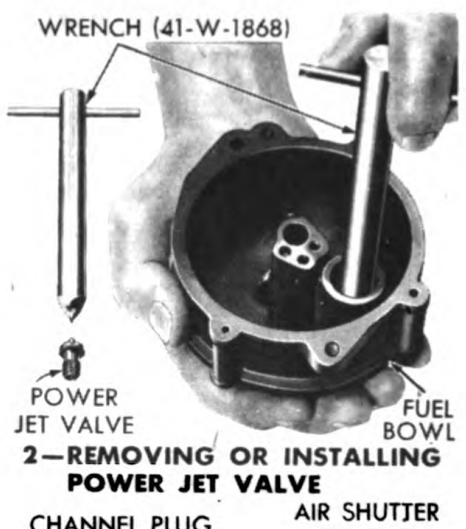
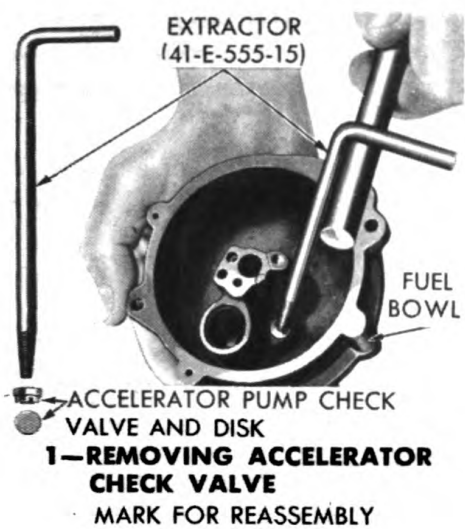

RA PD 53361

Figure 105—Carburetor Rebuilding

**ORDNANCE MAINTENANCE—POWER PLANT, CLUTCH, AND ELECTRICAL SYSTEM—¾ AND 1½ TON VEHICLES (DODGE)**

k. **Replace Accelerator Pump Check Valve and Accelerator Pump Refill Check Valve** (fig. 103). Replace the accelerator pump check valve and pump refill check valve, as these parts are damaged beyond repair when removed.

l. **Replace Gaskets and Washers.** Use a new set of gaskets and washers when assembling the carburetor to insure against leakage of fuel or air.

**56. ASSEMBLY OF CARBURETOR.**

a. **Check Jet Sizes.** Check the size of the new jets to be used for replacement to insure that the proper parts are on hand. The following tabulation shows the proper jet numbers which are stamped on the parts:

Accelerating jet . . . . .	14	Metering well . . . . .	1
Fuel valve seat . . . . .	45	Power jet valve . . . . .	20
Idle jet . . . . .	14	Venturi . . . . .	31
Main discharge tube . . . . .	80	Well vent . . . . .	15
Main jet . . . . .			30

b. **Install Air Shutter Shaft and Plate** (fig. 105). Install the air shutter shaft in the air intake body and turn the shaft so the counter-sunk side of the shaft screw holes face toward the top of the carburetor. Install the air shutter plate in the shaft slot from the inside of the body with the poppet valve in the plate facing up and with the plate resting on the air shutter bracket locating pin inside the air intake. Close the shutter and observe that the poppet spring faces the air entrance. Hold the plate in the closed position, center the plate in the shaft and install the two screws. Tighten the screws securely and test the shutter for free operation. It must not bind. *Do not rivet the ends of the air shutter retaining screws.*

c. **Install Air Shutter Bracket** (fig. 103). Place the air shutter bracket over the end of the shaft and match the marking to line up the bracket in the same position as it was removed (fig. 105). Install the bracket retainer screw and tighten in place. Hold the air shutter plate wide open and install the air shutter lever on the shaft so the lower lug on the lever contacts the upper edge of the lug on the bracket. Install the retainer nut and lock washer. Connect one end of the shutter spring to the lever and the other end to the lug on the bracket.

d. **Install New Accelerator Check Valve** (fig. 105). Start the accelerator pump check valve (fig. 103) evenly into the counterbore of the valve opening in the bottom of the fuel bowl with the small opening of the valve facing out. Insert the end of the pump check valve tool into the valve and drive the valve into the opening until it is seated on the bottom of the counterbore.

**CARBURETOR AND GOVERNOR (ZENITH) AND FUEL PUMP REBUILDING**

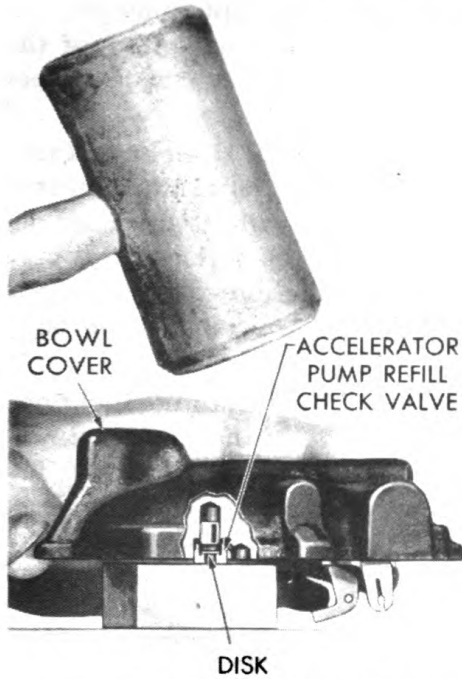

**1—INSTALLING ACCELERATOR PUMP REFILL CHECK VALVE**

FLOAT LEVEL GAGE AND BENDING TOOL (41-G-188)

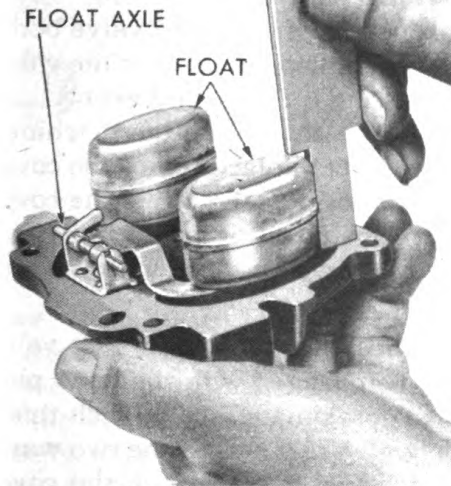

**3—CHECKING FLOAT LEVEL**

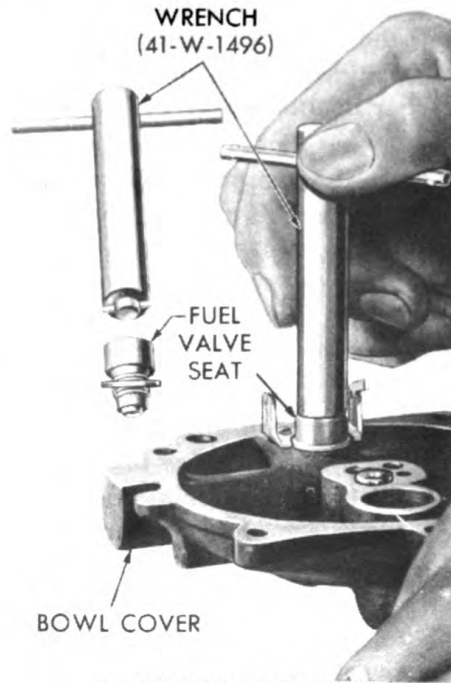

**2—INSTALLING FUEL VALVE SEAT**

FLOAT HINGE (PART OF FLOAT)

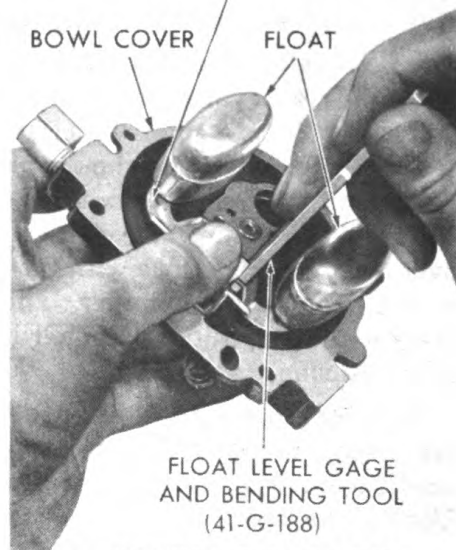

**4—SETTING FLOAT LEVEL**

RA PD 53362

**Figure 106—Carburetor Rebuilding**

**ORDNANCE MAINTENANCE—POWER PLANT, CLUTCH, AND ELECTRICAL SYSTEM—¾ AND 1½ TON VEHICLES (DODGE)**

e. **Install Power Jet Valve** (figs. 104 and 105) and main jet. Install the power jet valve with a new fiber washer on the bottom of the pump cylinder of fuel bowl. Install the main jet with a new fiber washer in the bottom of the fuel bowl.

f. **Install Accelerating Jet and Metering Well, Discharge Tube and Well Vent** (fig. 103). Install the accelerating jet in the metering well. Insert the metering well and jet assembly with accelerating jet up, in the passage located in the center, inside the fuel bowl. Install the discharge tube with a new fiber washer, in the threaded passage in fuel bowl. Install the well vent in the threaded opening in the bowl casting into which the metering well is fitted.

g. **Install Fuel Bowl Lower Plug** (fig. 103). Install the fuel bowl lower plug, with a new fiber washer, in the side of the fuel bowl. *Do not use the fuel valve fiber washer under the bowl plug* (par. 56 k). *The inner and outer diameter of the bowl plug washer is the same as for the fuel valve washer, but on early type carburetors, a thinner washer was used for the bowl plug. On later type carburetors equipped with identical washers, there is no possibility of mixing the washers.*

h. **Test Action of Accelerating Pump.** Fill the carburetor bowl with fuel and check the action of the accelerating pump before continuing to assemble the carburetor. Force the pump piston downward in the pump cylinder several times and notice if the pump check valve leaks, allowing fuel to be forced back into the bowl. If the valve leaks, replace it.

i. **Install Idling Jet** (fig. 103). Install the idle jet, long end down, in the passage alongside the metering well.

j. **Install Accelerating Pump Refill Check Valve** (fig. 106). Place the check valve disk in the large opening of the check valve body. Hold the fuel bowl cover with the valve opening lined up over the valve and start the valve into the opening, pressing it firmly and evenly into place with the fingers. Continue to hold the cover with the machined surface down so the valve disk will not fall out of place. Place the cover over a flat metal surface with the valve in position and strike the cover with a composition hammer. Then turn the cover over and tap valve body with composition hammer until it is driven in flush with the machined surface of the cover.

k. **Install Fuel Valve Seat Assembly** (fig. 106). The fuel valve seat fiber washer is similar to and can be changed with the bowl plug washer. The fuel valve seat washer is approximately 0.050 inch thick. Use the thickest washer under the fuel valve seat, unless the two washers are identical (par. 56 g). Install the fuel valve seat in the cover with a new fiber washer and tighten it in place with the wrench. Drop the fuel valve needle (fig. 103), pointed end down, into the fuel valve seat.

### CARBURETOR AND GOVERNOR (ZENITH) AND FUEL PUMP REBUILDING

l. **Install Float Assembly** (fig. 103). Place the float assembly in the hinge bracket with the float arms toward the cover and the center of the float arms resting on the fuel valve needle. Insert the small end of the tapered float axle (fig. 103, N) into the side of the hinge bracket that has the float arm stop and push the axle through the bracket until an equal amount of the axle extends from each side of the hinge bracket.

m. **Measure and Set Float Level** (fig. 106). Hold the cover assembly in the inverted position and measure from the machined surface of the cover to the top of each float body at the end farthest from the float axle. This dimension should be from  $1\frac{7}{16}$  inch to  $1\frac{3}{8}$  inch, the

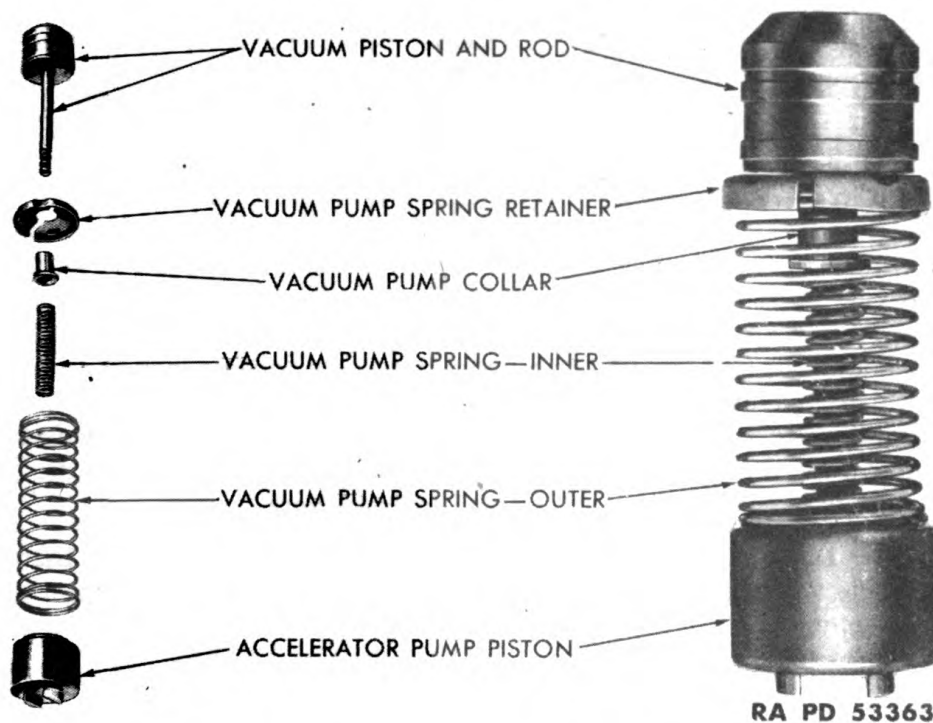

**Figure 107—Vacuum Piston and Pump Assembly**

latter preferred, and the same for both floats. The cut-out portions on each side of the gage indicate the high and low limits of the float setting. If necessary to adjust the float setting, hold the cover in the inverted position and press the float hinge down firmly against the fuel valve needle with the thumb. Insert the slot of the float bending tool at the bend on the horizontal section of the float hinge. Adjust one side of float by bending up or down. Then move the tool to the other end of the horizontal section and adjust the other side of the float. Adjust both float bodies to the same dimension and keep float at right angle to the float axle.

n. **Assemble Vacuum Piston** (fig. 107). The separate parts of

**ORDNANCE MAINTENANCE—POWER PLANT, CLUTCH, AND ELECTRICAL SYSTEM— $\frac{3}{4}$  AND  $1\frac{1}{2}$  TON VEHICLES (DODGE)**

the vacuum piston and pump assembly are not furnished separately so there should be no necessity of disassembling and assembling it. However, if it should accidentally become disassembled, place the vacuum pump spring retainer over the rod of the vacuum piston with the flange of the retainer toward the open end of the rod. Then place the vacuum pump collar over the rod with collar toward the end of the rod. Install the inner and outer springs. Compress the springs and assemble the open end of the accelerator pump piston on the vacuum piston rod. Fit the piston over the middle groove of the rod and lock it in place.

**o. Install Vacuum Piston and Pump Assembly (fig. 103).** Insert the vacuum piston in the vacuum cylinder of the fuel bowl cover assembly and press the spring retainer into the cylinder until the retainer flange is flush with the surface of the cover.

**p. Assemble Bowl Cover and Install Bowl Assembly (fig. 103).** Install a new fuel bowl to cover gasket on the cover and line up the holes in the gasket with the openings in the cover. Insert the vacuum piston and pump assembly located in the cover, into the pump cylinder in the fuel bowl and assemble the bowl cover to bowl while guiding the idle jet into the cover. Attach the cover to the bowl with the two short screws and lock washers. Install a new fuel bowl to air intake gasket on the fuel bowl assembly and line up the openings in the gasket with the openings in the fuel bowl flange. Assemble the fuel bowl assembly to the air intake assembly with the lower bowl plug facing the air entrance side of the air intake assembly. Fasten the bowl to the air intake with the two long screws and lock washers.

**q. Install and Adjust Idle Adjusting Needle (fig. 103).** Install the idle adjustment needle and spring in the opening at the top of the bowl cover. Screw the needle into the cover until it seats lightly and back it out one turn.

**r. Install Secondary Venturi, Throttle Body and Governor Assembly (fig. 103).** Install a new throttle body to air intake gasket to the air intake with the small notch in the gasket center opening indexing with the groove in the intake bore. Install the secondary venturi with the small opening facing the air intake bore and turn the venturi until the small bur on the venturi fits into the notch in the gasket and the groove in the intake body. Line up the file marks on the flange of the air intake body with the throttle body flange marks and assemble the throttle body to the air intake with the four screws and lock washer.

**s. Adjust Throttle Lever (fig. 103).** Hold the throttle lever in the closed position and screw the throttle stop screw until it just contacts the stop screw in the throttle body. Then turn throttle stop screw in one turn against the stop screw.

**CARBURETOR AND GOVERNOR (ZENITH) AND FUEL PUMP REBUILDING**

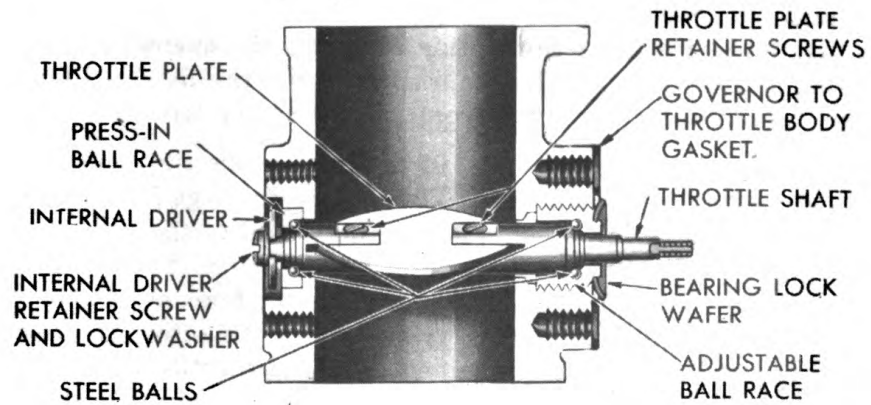
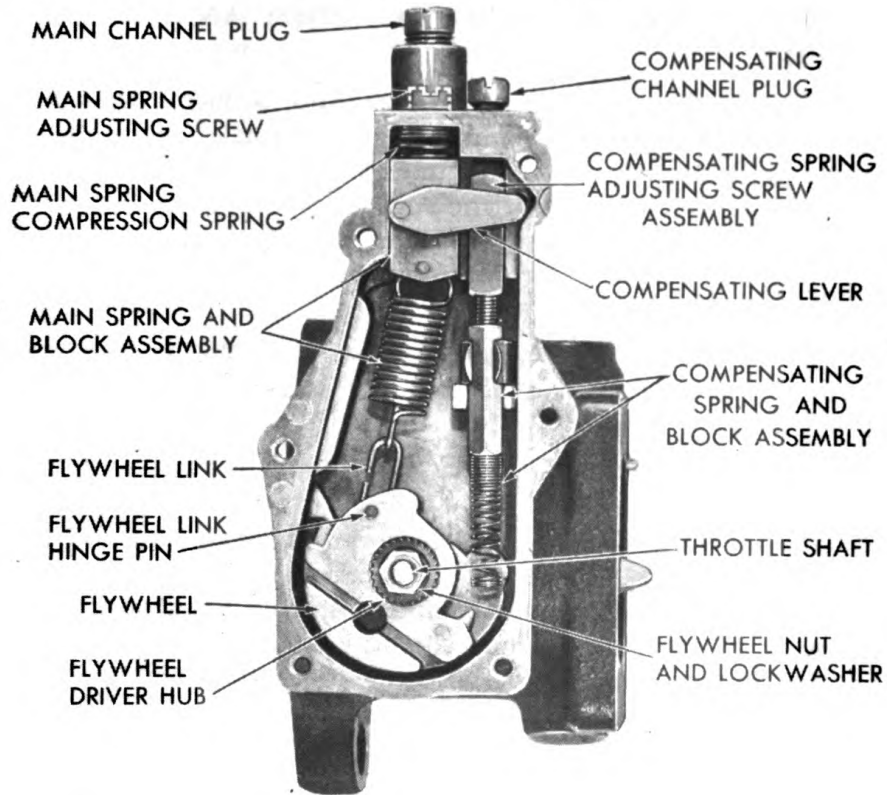

RA PD 53372

**Figure 108—Governor and Throttle Body**



**ORDNANCE MAINTENANCE—POWER PLANT, CLUTCH, AND ELECTRICAL SYSTEM— $\frac{3}{4}$  AND  $1\frac{1}{2}$  TON VEHICLES (DODGE)****57. DISASSEMBLY OF THROTTLE BODY AND GOVERNOR ASSEMBLY.**

a. **Remove Throttle Lever, Driver and Internal Driver** (fig. 103). Remove the two screws attaching the throttle lever and driver assembly to the throttle body and remove the lever and driver assembly and the gasket. Scratch mark the surface of the internal driver for identification when assembling the part (fig. 109). Then remove the driver by removing the attaching screw and washer from the end of the shaft.

b. **Remove Channel Plugs and Cover** (fig. 108). Remove the seal wires from the two channel plugs and screw the plugs out of the governor housing. Pry out the two lead plugs which seal the governor housing cover screws, remove the attaching screws, the cover and gasket.

c. **Remove and Disassemble Compensating Spring and Block Assembly** (fig. 109). Lift out the governor compensating lever from the governor housing. Move the compensating block and spring assembly forward out of the attaching clip and lift out the assembly. Unscrew the compensating spring adjustment screw assembly from the spring and block assembly. *Do not remove the compensating spring from the block* (par. 58 g).

d. **Remove and Disassemble Main Spring and Block Assembly** (fig. 108). Unscrew the main spring adjusting screw until the main spring block is released and then remove the adjusting screw from the housing. Remove the main spring and block assembly together with the main spring compression spring by lifting the assembly out of the housing and disengaging the main spring from the flywheel link. Remove the tapered main spring compression spring from the block.

e. **Remove Flywheel** (fig. 109). Remove the flywheel retaining nut and washer with the wrench. Then insert the large pin of the puller into the hole in the flywheel with the hook end of the puller next to the pointed projection on the side of the flywheel. Swing the puller away from the pointed projection and guide the hook end of the puller into the slot in the side of the flywheel, until the screw in the center of the puller is in line with the center of the throttle shaft. Tighten the puller screw until the flywheel is forced off the throttle shaft. Unscrew puller screw and remove puller from the flywheel.

f. **Remove Governor Housing.** Make a scratch or file mark on the side of the housing paralleling the air intake connecting flange of the throttle body for identification when assembling. Remove the Phillips-head-type screws which attach the governor housing to the throttle body and remove the housing and gasket and the spring adjustable race lock wafer.

**CARBURETOR AND GOVERNOR (ZENITH) AND FUEL PUMP REBUILDING**

MARK INTERNAL DRIVER FOR ASSEMBLY

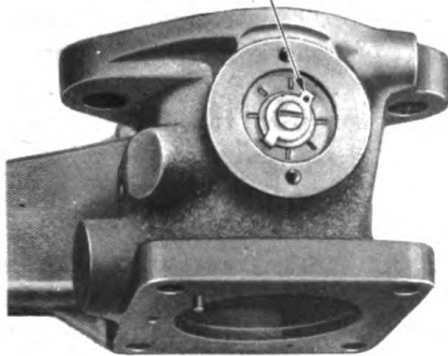

**1—INTERNAL DRIVER ASSEMBLY MARK**

COMPENSATING SPRING AND BLOCK ASSEMBLY

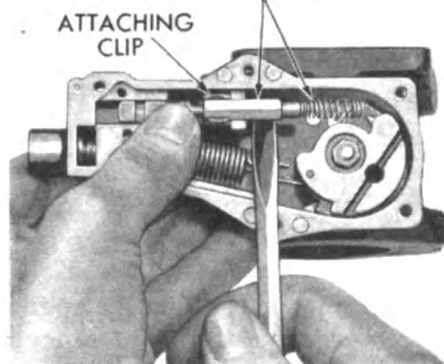

**2—REMOVING COMPENSATING SPRING AND BLOCK ASSEMBLY**

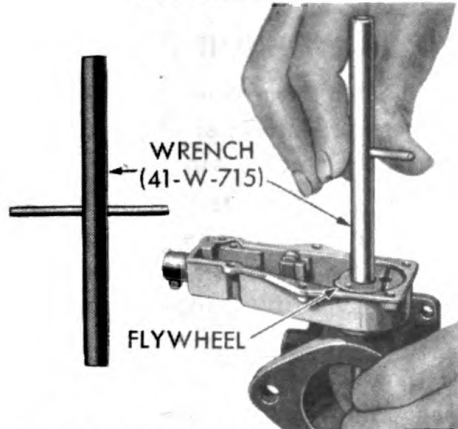

**3—REMOVING OR INSTALLING FLYWHEEL RETAINER NUT**

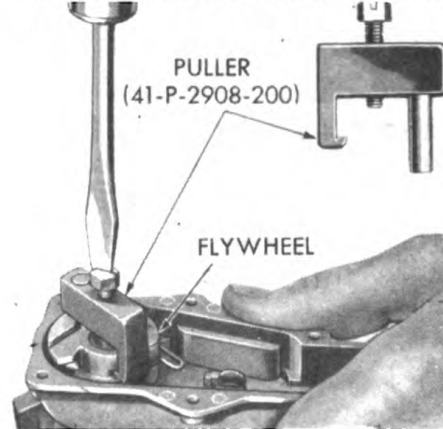

**4—REMOVING FLYWHEEL**

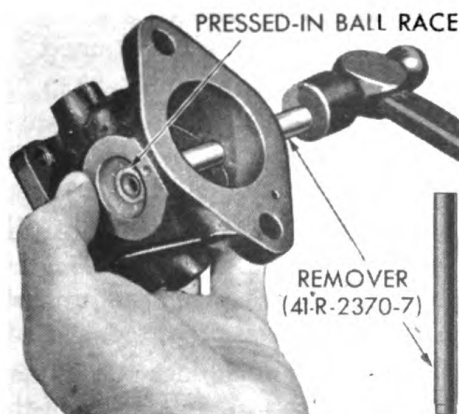

**5—REMOVING PRESSED-IN BALL RACE**

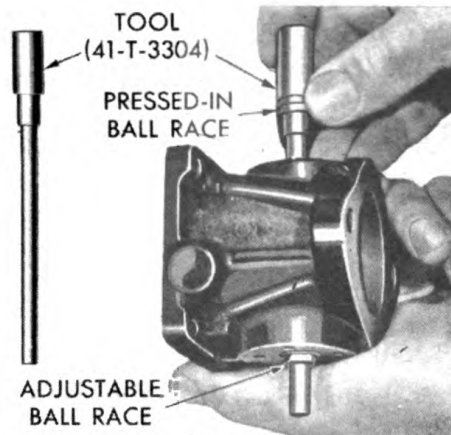

**6—INSTALLING PRESSED-IN BALL RACE**

RA PD 53364

**Figure 109—Governor Rebuilding**

**ORDNANCE MAINTENANCE—POWER PLANT, CLUTCH, AND ELECTRICAL SYSTEM— $\frac{3}{4}$  AND  $1\frac{1}{2}$  TON VEHICLES (DODGE)**

**g. Remove Throttle Plate and Shaft** (fig. 108). File off the riveted ends of the throttle plate retainer screws. Avoid striking or cutting the sides of the throttle body bore or the throttle plate, while performing this operation. Slide the throttle plate out of the shaft and remove it. Unscrew the adjustable ball race from the throttle body and pull the shaft out through this opening. The bearing race in the side of the throttle body opposite the adjustable race is pressed into the throttle body and it is not necessary to remove it unless it is damaged or excessively worn.

**h. Remove Pressed-In Ball Race** (fig. 109). Insert the remover through the adjustable race opening in the throttle body and drive out the pressed-in ball race. Do not remove the idle port plug located in the bore of the throttle body. However, check the opening to insure that it is free of obstructions.

**58. INSPECTION AND REPAIR OF GOVERNOR PARTS.**

**a. Clean All Parts.** Wash all parts except driver assembly in dry-cleaning solvent and dry with compressed air (par. 40 b). Blow out the idle hole in the throttle body with compressed air.

**b. Inspect Throttle Plate** (fig. 108). Examine the throttle plate for warping, damaged edges or burs. Do not clean the plate with a buffing wheel or scratch the edge of the plate with a file or other cutting tool. Replace the plate if unsatisfactory as it cannot be satisfactorily repaired.

**c. Inspect Throttle Shaft** (fig. 108). Examine the throttle shaft bearing race for worn, scored or pitted conditions. If the inner races are only slightly worn or scratched the shaft can be used. If badly worn or grooved, replace the throttle shaft and flywheel as an assembly. The throttle shaft is not available for replacement without a flywheel, as the accurate relationship of these two parts must be maintained.

**d. Inspect Throttle Lever and Driver Assembly** (fig. 103). If the bearing is loose enough to rock or tip the bearing cup on the shaft assembly, or if there is a binding condition, replace the assembly. Do not separate the bearing halves of the driver bearing as they are spot welded together. If the weld has been broken, replace the throttle lever and driver assembly.

**e. Inspect Pressed-In Ball Race** (fig. 108). Replace the pressed-in ball race in the throttle body if it is worn, scored or pitted.

**f. Inspect Adjustable Ball Race** (fig. 108). Replace the adjustable ball race if there is any evidence of wear, scoring or pitting of the bearing surface.

**g. Inspect Compensating Spring and Block Assembly** (fig. 108). Do not remove compensating spring from the block as it is supplied as an assembly (par. 57 c). If the spring is damaged or broken

### CARBURETOR AND GOVERNOR (ZENITH) AND FUEL PUMP REBUILDING

or if the threads are not satisfactory, replace the assembly as a satisfactory adjustment cannot be made if separate parts of the assembly are replaced.

**h. Inspect Housing, Cover and Throttle Body.** Examine the cover and housing for cracks or damage. Check the threads where the seal channel plugs fit into the housing. Carefully inspect the throttle body for cracks or irregular surfaces of the attaching flanges that would cause air leakage. Replace any or all of these parts that are not satisfactory.

**i. Replace Ball Bearings** (fig. 108). The 14 steel ball bearings used in each of the throttle shaft end bearings cannot be visually inspected because of their size. Replace the bearings if they are removed.

### 59. ASSEMBLY OF THROTTLE BODY AND GOVERNOR ASSEMBLY.

**a. Install Pressed-In Ball Race** (fig. 109). If the pressed-in ball race was removed, install a new race. Screw the adjustable race into the throttle body to act as a guide for the tool. Place the new race on the shoulder of the special piloted driver so that the surface of the race that contacts with the steel balls is facing away from the shoulder. Insert the tool through the throttle shaft opening and insert the piloted end through the adjustable ball race shaft opening in the opposite side of the body. Carefully drive on the end of the tool until the race is firmly seated in the body. Tap the tool lightly to prevent bending the metal at the bottom of the hole into the throttle bore. Make sure the race is seated in the body. Leave the tool in place and center punch the eight indentations located around the race to tighten it in the body. Remove the tool and the adjustable ball race.

**b. Install Adjustable Race on Shaft** (fig. 110). Fill the ball bearing scoop with 14 ball bearings. Insert the threaded end of the throttle shaft through the large opening end of the adjustable race. Hold the threaded end of the throttle shaft between the thumb and forefinger and allow just enough room to fit the ball bearings around the race. Pour the balls from the scoop into the bearing race while working the throttle shaft down into the bearing race to move the balls into position. Hold the parts together tightly so the balls will not fall out. Screw the bearing race retainer on the threaded end of the throttle shaft with the counterbored opening facing the ball race, until it contacts the race and holds the balls in place.

**c. Install Throttle Shaft** (fig. 103). Fill the ball bearing scoop with 14 ball bearings. Hold the throttle body with the governor mounting side up. Cover the pressed-in race shaft opening with the middle finger and pour the balls into the inside of the ball race. Arrange the balls in a circle around the finger tip, so all the balls contact with the

**ORDNANCE MAINTENANCE—POWER PLANT, CLUTCH, AND ELECTRICAL SYSTEM— $\frac{3}{4}$  AND  $1\frac{1}{2}$  TON VEHICLES (DODGE)**

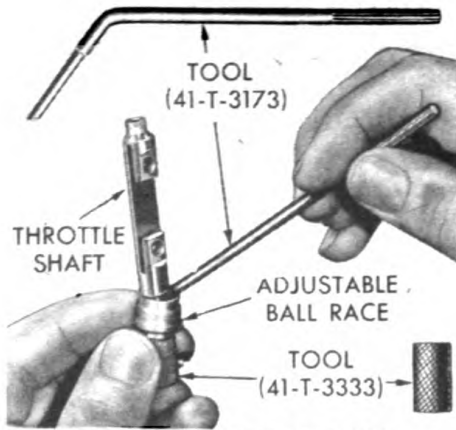

**1—INSTALLING BALLS IN ADJUSTABLE RACE**

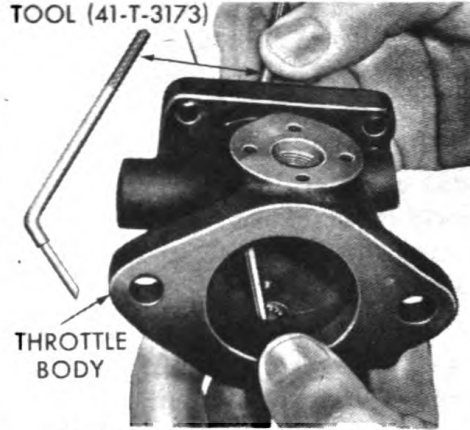

**2—INSTALLING BALLS IN PRESSED-IN RACE**

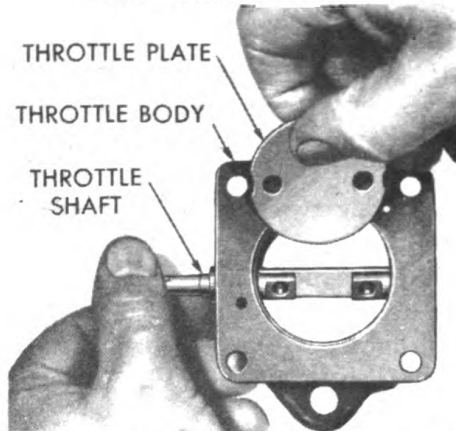

**3—INSTALLING THROTTLE PLATE**

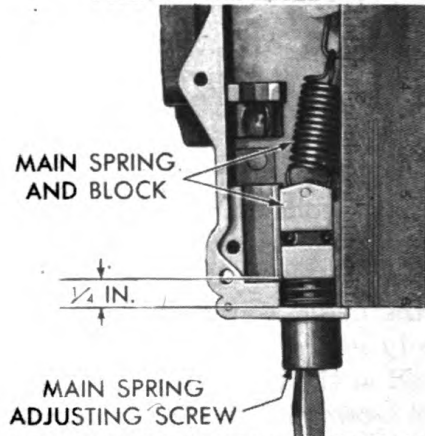

**4—ADJUSTING MAIN SPRING AND BLOCK ASSEMBLY**

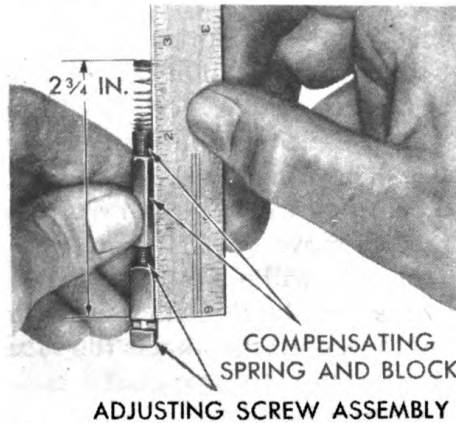

**5—ADJUSTING COMPENSATING SPRING AND BLOCK ASSEMBLY**

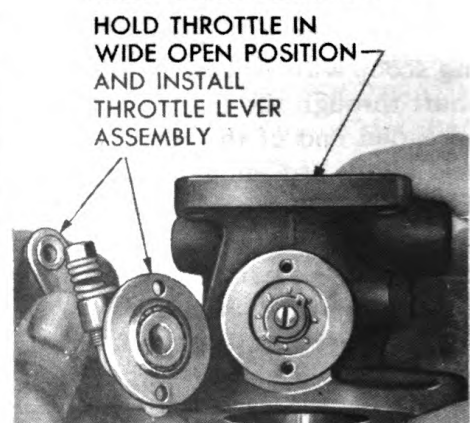

**6—INSTALLING THROTTLE LEVER ASSEMBLY**

RA PD 53365

**Figure 110—Governor Rebuilding**

### CARBURETOR AND GOVERNOR (ZENITH) AND FUEL PUMP REBUILDING

press-in ball race. Insert the throttle shaft, with the adjustable ball race assembled, through the adjustable race opening and screw the adjustable race into the body until the end of the shaft contacts with the balls in the pressed-in race. Rotate the throttle shaft as the adjustable race is screwed in farther, gradually working the shaft through the race to displace the finger tip. Keep the finger tip tightly pressed against the end of the shaft as the finger is forced away from the pressed-in race, to prevent the balls dropping out.

**d. Adjust Throttle Shaft Bearings.** Remove the bearing race retainer from the threaded end of the throttle shaft and turn the bearing race clockwise until the throttle shaft drags slightly when turned. Then turn the adjustable bearing race counterclockwise  $\frac{1}{4}$  turn to allow the proper end play in the shaft.

**e. Install Throttle Plate (fig. 110).** Hold the throttle body with air intake mounting flange up (the flange with four holes) and with the brass idling port plug on the inside of the throttle body bore facing away from you. Turn the throttle shaft so the cut out section faces you, and in this position insert the throttle plate with the shortest distance between the screw holes of the plate and the beveled edge down. The plate is made with the two opposite edges beveled to fit the throttle body bore when closed. The plate will not close properly if it is not correctly installed. Center the plate in the opening and install the two retainer screws. The screw heads will face toward the air intake. Hold the plate firmly in position in the bore while tightening the screws. Do not rivet the ends of the screws but tighten the screws firmly. Any tendency for the plate to bind on the sides of the bore or to stick, should be eliminated as this will prevent proper operation of the governor. Try opening and closing the plate several times and readjust it on the throttle shaft, if necessary.

**f. Install Governor Housing.** Install the spring adjustable bearing race lock wafer over the adjustable bearing race with the outer edge of the wafer turned out. Install the paper governor housing to throttle body gasket so the screw holes of the gasket line up with the holes in the governor housing. Install the governor housing on the throttle body with the marked side parallel with the air intake flange of throttle body (par. 57 f). Attach the housing with the Phillips-head-type screws and tighten. Test the operation of the throttle plate before continuing to assemble the governor. It must operate freely without binding. Grip the throttle plate with the fingers and try to move it lengthwise. The movement should be just perceptible. Open and close the throttle plate and test for free operation. If either test indicates unsatisfactory operation, the adjustable bearing race is not correctly adjusted. Remove the governor housing and adjust the throttle shaft bearings (par. 59 d).

**ORDNANCE MAINTENANCE—POWER PLANT, CLUTCH, AND ELECTRICAL SYSTEM— $\frac{3}{4}$  AND 1  $\frac{1}{2}$  TON VEHICLES (DODGE)**

g. **Install Flywheel** (fig. 109). Hold the throttle plate closed and install the flywheel on the shaft with the link side of the flywheel towards the carburetor attaching flange. Install the lock washer and nut and tighten with special wrench.

h. **Install Main Spring and Block Assembly** (fig. 110). Attach the small end of the cone shaped compression spring on the collar of the main spring block. Hold the block assembly with the slotted side up and hook the free end of the main spring to the flywheel link. Then slide the block into position toward the adjusting screw opening. Insert the main spring adjusting screw into the opening and screw it into the main spring block, compressing the tapered compressing spring until the square edge of the block is located  $\frac{1}{4}$  inch from the inside edge of the housing.

i. **Adjust and Install Compensating Spring and Block Assembly** (fig. 110). Assemble the compensating spring block assembly to the adjusting screw block and adjust the length of the assembly to 2  $\frac{3}{4}$  inches, measured from the end of the spring to the side of the slot in the adjusting screw block nearest the spring. This adjustment is extremely important and must be accurately performed. When properly adjusted for length, install the compensating spring block and adjusting screw assembly with the spring toward the flywheel.

j. **Install Compensating Lever and Channel Plugs** (fig. 108). Hold the compensating lever so the longest of the three pins will fit into the socket in the governor housing. Then fit the other two pins into the slot of the compensating spring block and the main spring block. Install the large and small channel plugs in the housing, attach seal wires to plugs and seal.

k. **Check Compensating Spring for Buckling**. Open and close the throttle a few times and note if the compensating spring buckles. If so, remove the compensating spring and block assembly and rotate the spring on the block  $\frac{1}{6}$  turn, install and again check the operation of the spring. If necessary, repeat the operation until the spring does not buckle.

l. **Install Cover and Gasket**. Install the cover and gasket on the housing and install the two attaching screws, without lock washers, in the holes with the collars. Install the balance of the screws with lock-washers. Install new lead seal plugs in the screw holes to seal the cover and drive in flush with the cover collars.

m. **Install Internal and External Driver and Throttle Lever** (fig. 110). Install the internal driver with the identifying scratch mark (par. 57 a) facing out and install the lock washer and retaining screw. Install the throttle lever assembly gasket on the throttle body. With throttle in wide open position, place throttle lever assembly on throttle body with head of idle adjusting screw pointing directly away from the

### CARBURETOR AND GOVERNOR (ZENITH) AND FUEL PUMP REBUILDING

mounting flange. Hold the throttle plate and external driver in position and insert the long stop screw with lock washer in the screw hole to contact with the idle adjusting screw. Then install the opposite screw and lock washer. Test the operation of the throttle plate. If the driver is not properly installed, the throttle plate will not close. Adjust the throttle stop screw (par. 56 s).

n. **Governor Adjustments.** Adjustment of the main spring and compensating spring lengths (par. 59 h and i) will ordinarily be satis-

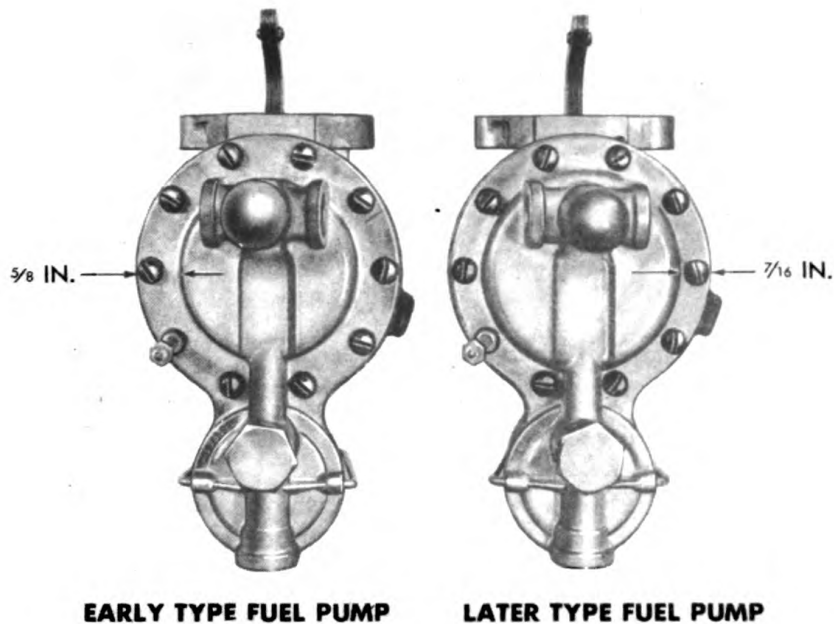

RA PD 53366

**Figure 111—Identification of Fuel Pumps**

factory and no further adjustments will be required. After the carburetor and governor assembly is installed on the truck, however, check the performance of the engine at governed speed (par. 76 a (9)).

#### 60. DISASSEMBLY OF FUEL PUMP.

a. **Identification of Early and Late Type Pumps** (fig. 111). Two types of fuel pumps have been used on trucks covered by this manual. The two different types can be identified with the width of the mounting flange of the top cover assembly. On early type pumps the flange width is  $\frac{5}{8}$  inch and on the later type the flange width is  $\frac{7}{16}$  inch. Later type pumps are equipped with larger diaphragm protectors, an outer diaphragm spring and a different type diaphragm pull rod spring. The late type pump produces a higher pressure 3 to  $5\frac{1}{2}$  pounds.



**ORDNANCE MAINTENANCE—POWER PLANT, CLUTCH, AND ELECTRICAL SYSTEM— $\frac{3}{4}$  AND  $1\frac{1}{2}$  TON VEHICLES (DODGE)**

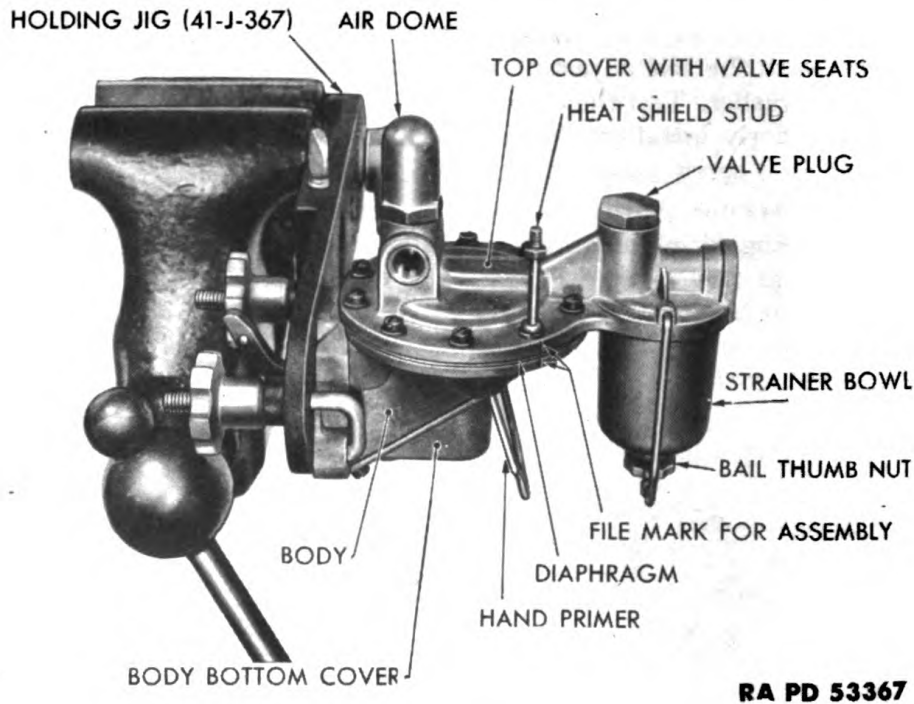

**RA PD 53367**

**Figure 112—Fuel Pump in Holding Jig**

b. **Clean Fuel Pump Assembly.** Wash the outside of the fuel pump assembly with dry-cleaning solvent, and dry with compressed air.

c. **Remove Cover** (fig. 112). Install the fuel pump in the holding jig and clamp the jig in a vise. Remove the carburetor tube nipple from the cover. Place a file mark across the flanges of fuel pump body and cover opposite the heat shield stud for location of the screw hole for the heat shield stud and to assist in assembling the cover in the same position on the body. Remove the heat shield stud, the attaching screws and cover.

d. **Remove Diaphragm** (fig. 113). Remove the nut, lock washer and pull rod nut washer from the pull rod. Remove the upper diaphragm protector, the diaphragm and lower diaphragm protector slowly, so the parts under the diaphragm will not fly out. Remove the diaphragm spring, the spring seat, the pull rod seal and the pull rod washer.

e. **Remove Inlet and Pressure Valves and Springs from Cover** (fig. 113). Remove the top cover airdome and the valve chamber plugs. Turn the cover over and catch the valve springs and valves as they drop out of the cover.

f. **Remove Strainer Screen from Cover** (fig. 113). Unscrew the strainer bowl bail nut and remove the bowl. Spread the sides of the

**CARBURETOR AND GOVERNOR (ZENITH) AND FUEL PUMP REBUILDING**

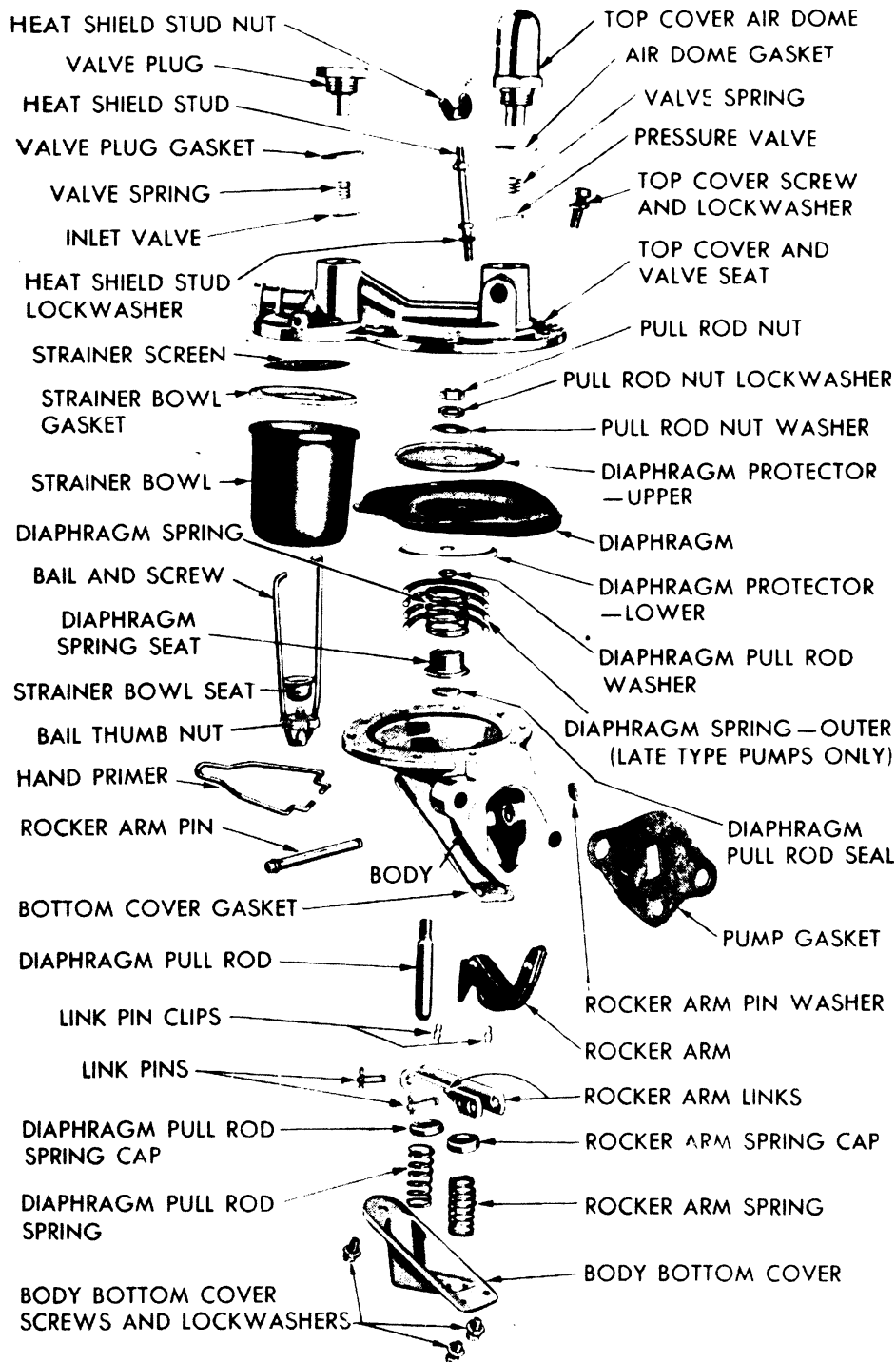

RA PD 53338

**Figure 113—Fuel Pump Disassembled**

**ORDNANCE MAINTENANCE—POWER PLANT, CLUTCH, AND ELECTRICAL SYSTEM— $\frac{3}{4}$  AND  $1\frac{1}{2}$  TON VEHICLES (DODGE)**

bail out of the cover sockets and remove the bowl bail and screw. Remove the bowl gasket and screen strainer.

**g. Remove Priming Lever and Pull Rod (fig. 113).** Hold the pump upside down and hold bottom cover down against the spring pressure and remove the three attaching screws. Slowly release the cover so the rocker arm and pull rod springs will not jump out of position when the cover is removed. As the cover is removed, note the location of and be able to identify the pull rod spring and the rocker arm spring so that they can be installed in their original position. If the springs are painted, simply note the color of the spring used in one of the locations. If the springs are not painted, count the number of coils and measure the spring diameter and length. If one of the springs is replaced, use a spring of the same color and/or number of coils and length. Remove the caps and spring after they have been tagged or otherwise properly identified.

**h. Remove Diaphragm Pull Rod (fig. 113).** Pull the pull rod out of the body opening and remove the cover gasket and the hand primer. Remove the pin clip from one end of the pull rod attaching link pin and remove the pin to release the pull rod.

**i. Remove Linkage and Rocker Arm (fig. 113).** Chisel off the end of the rocker arm pin to release the plain washer and then drive the pin out to release the rocker arm and rocker arm links. Remove the link pin clip from one end of the pin, remove the pin and separate the links.

**61. INSPECTION AND REPAIR OF FUEL PUMP PARTS.**

**a. Clean All Parts.** Wash all parts except the diaphragm and pressure valves with dry-cleaning solvent, and dry with compressed air (par. 40 b.)

**b. Inspect Diaphragm (fig. 113).** Examine diaphragm for cracks or damage. If the diaphragm has become hard or lost its flexibility, replace it.

**c. Inspect Valves (fig. 113).** Replace valves if they show signs of wear, scores or grooves.

**d. Inspect Valve Springs (fig. 113).** If valve springs are distorted or stretched by comparison with a new spring, replace them.

**e. Inspect Strainer Screen (fig. 113).** If strainer screen is corroded, damaged or out of shape, replace it.

**f. Inspect Rocker Arm, Linkage, Pull Rod and Springs (fig. 113).** Examine rocker arm for wear or distortion. Examine rocker arm linkage for wear at the link pins and for distortion. Examine the pull rod for wear at the link pin connection and inspect the threads for damage or wear. Inspect the rocker arm and pull rod springs, and caps for

### CARBURETOR AND GOVERNOR (ZENITH) AND FUEL PUMP REBUILDING

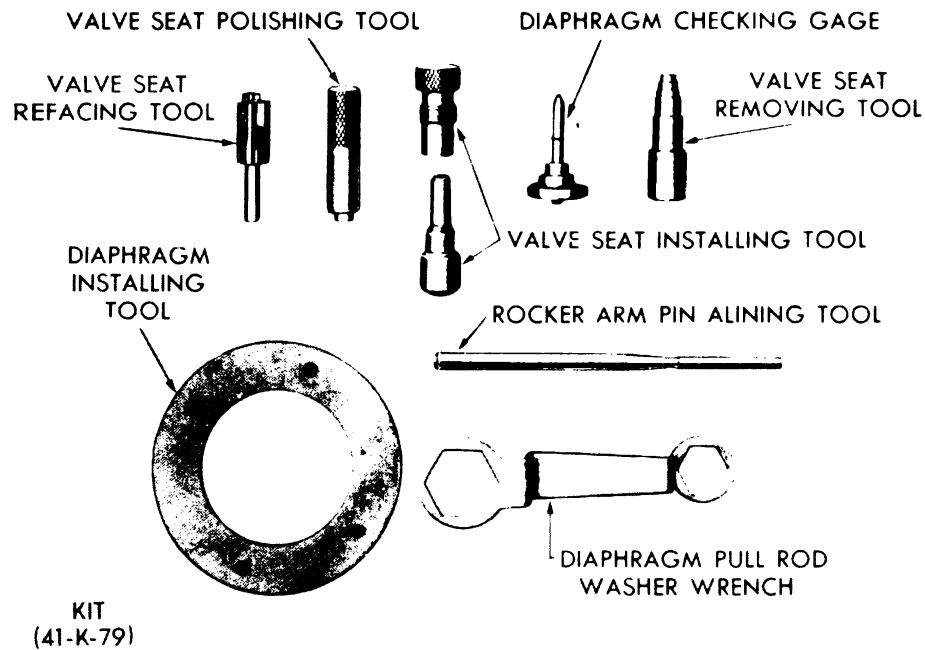

RA PD 53368

**Figure 114—Fuel Pump Repair Tools**

wear. Check springs for distortion. Replace any of the parts which appear unsatisfactory.

**g. Inspect Body, Fuel Bowl and Cover (fig. 113).** Replace the body and cover castings if they are cracked, warped or have irregular mounting surfaces that might cause leakage or poor fitting of parts. Examine fuel bowl and bail for possible causes of leakage and replace if unsatisfactory.

**h. Replace Gaskets.** Replace all gaskets when rebuilding the fuel pump to insure against leakage of air or fuel.

**i. Inspect and Repair Valve Seats (figs. 114 and 115).** Examine the valve seats in the cover for looseness, roughness or wear. If the seats are loose in the cover, tighten them with the special installation tools of the repair kit. Screw the anvil half of the seat installing tool into the opening above the valve seat until the tool contacts the end of the seat. Then install the driver end of the installing tool through the lower end of the valve until the bevel of the tool contacts the lower end of the valve. Tap the driver with a hammer until the lower end of the seat is firmly flared out against the body. If the seat is severely worn or damaged, drive out the old seat with removing tool. Insert the new seat and tighten it in place with the installing tool. Reseat the valve seats with the valve seat refacing tool if the seat is rough and pol-

TM 9-1808A  
61-62

**ORDNANCE MAINTENANCE—POWER PLANT, CLUTCH, AND  
ELECTRICAL SYSTEM— $\frac{3}{4}$  AND  $1\frac{1}{2}$  TON VEHICLES (DODGE)**

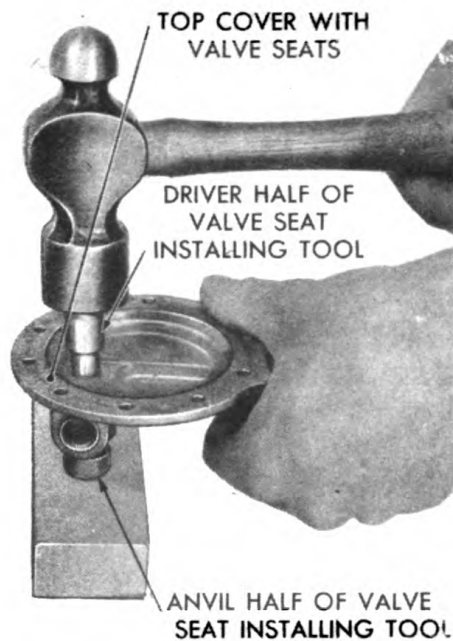

RA PD 53369

**Figure 115—Valve Seat Installation**



RA PD 53370

**Figure 116—Diaphragm Installation**

ish the seat surface with the polishing tool fitted with one of the emery cloth disks supplied with the tool kit.

**62. ASSEMBLY OF FUEL PUMP.**

a. **Assemble Rocker Arm and Linkage** (fig. 113). Line up the linkage and rocker arm in the pump body with the rocker arm pin aligning tool (fig. 114). Insert a new rocker arm pin through the holes of the pump body and the linkage and rocker arm. Place the rocker arm pin washer over the end of the pin and swedge the end of the pin against the washer to hold the pin in position. Move the rocker arm and linkage to determine whether the parts work freely on the pin.

b. **Install Hand Primer and Pull Rod** (fig. 113). Install hand primer in position on the bottom of the pump body and attach the pull rod to the linkage with the link pin and clips. Push the pull rod into position in the hole in the body.

c. **Install Pull Rod Seal** (fig. 113). Hold the pull rod in position and install the pull rod seal over the pull rod. Install the diaphragm spring seat over the seal and install the pull rod washer over the pull rod. Then install the diaphragm spring over the pull rod and the outer diaphragm spring if so equipped (par. 60 a).

**CARBURETOR AND GOVERNOR (ZENITH) AND  
FUEL PUMP REBUILDING**

**d. Install Diaphragm (fig. 116).** Install the lower diaphragm protector on the pull rod with the flange facing toward the bottom of the pump. The lower protector is the smaller of the two protectors on early type pumps. If a new diaphragm is to be installed, soak it in clean kerosene to make it pliable. Before placing the diaphragm on the pull rod, locate the tab or extension of the diaphragm over the unthreaded blind hole which is drilled between two of the screw holes in the flange of the body. When the diaphragm extension is located at the hole, all of the holes of the diaphragm will line up with the cover attaching screws. Then place the diaphragm alining tool over the diaphragm to hold it in proper position. Install the pull rod nut washer (hexagon shaped) on the pull rod and install the lock washer and nut. Hold the pull rod nut washer firmly with the pull rod washer wrench to prevent twisting the diaphragm and tighten the pull rod nut. If the diaphragm is allowed to twist or distort, unsatisfactory operation of the pump will result.

**e. Install Valves, Springs and Plugs (fig. 113).** Make sure the valve seats are clean and free of any foreign material. Drop the valves on the seats so that they do not stand on edge or tip. They must lay flat on the seats to operate properly. Insert the valve springs upright over the center of the valves. Install new fiber washers on the valve plugs and fit the plug stems over the valve springs as the plugs are screwed into place. Install the airdome valve plug over the pressure valve which is located over the diaphragm.

**f. Install Fuel Bowl on Cover (fig. 113).** Install the strainer screen in the fuel cover and install a new cover to bowl gasket. Install the bowl bail and bowl and tighten in place with the thumb nut of the bowl bail.

**g. Install Top Cover Assembly on Body (fig. 113).** Locate the file mark of the cover flange over the mark on the body flange and line up the holes of the diaphragm with the cover and body by pulling down on the pull rod. Install the heat shield stud and lock washer in the screw hole opposite the file mark (fig. 112), and then install the remainder of the attaching screws with lock washers. Push on the lower end of the pull rod to position the diaphragm at the extreme high position of the pump stroke and tighten the cover screws alternately until the cover is tight. The early type pump cover (par. 60, a) cannot be used on late type pumps as the cover will interfere with diaphragm operation.

**h. Install Rocker Arm Springs and Caps and Bottom Cover (fig. 113).** Place a new gasket on the bottom cover with a small amount of heavy grease to hold it in position. Locate the springs for the diaphragm pull rod and the rocker arm in their proper location (par. 60 g) on the bosses located in the cover and place the caps on each spring. Remove the pump assembly from the jig and hold it in an upright posi-

**ORDNANCE MAINTENANCE—POWER PLANT, CLUTCH, AND ELECTRICAL SYSTEM— $\frac{3}{4}$  AND 1 $\frac{1}{2}$  TON VEHICLES (DODGE)**

tion. Carefully move the pump over the cover, fitting the spring caps to the ends of the pull rod and rocker arm. Then push the cover tight against the pump, hold it in position and install the three attaching screws. Install the fuel tube nipple in the outlet opening.

i. **Test Fuel Pump** (fig. 117). Test the operation of the hand primer and the rocker arm to make sure the pump is in operating con-

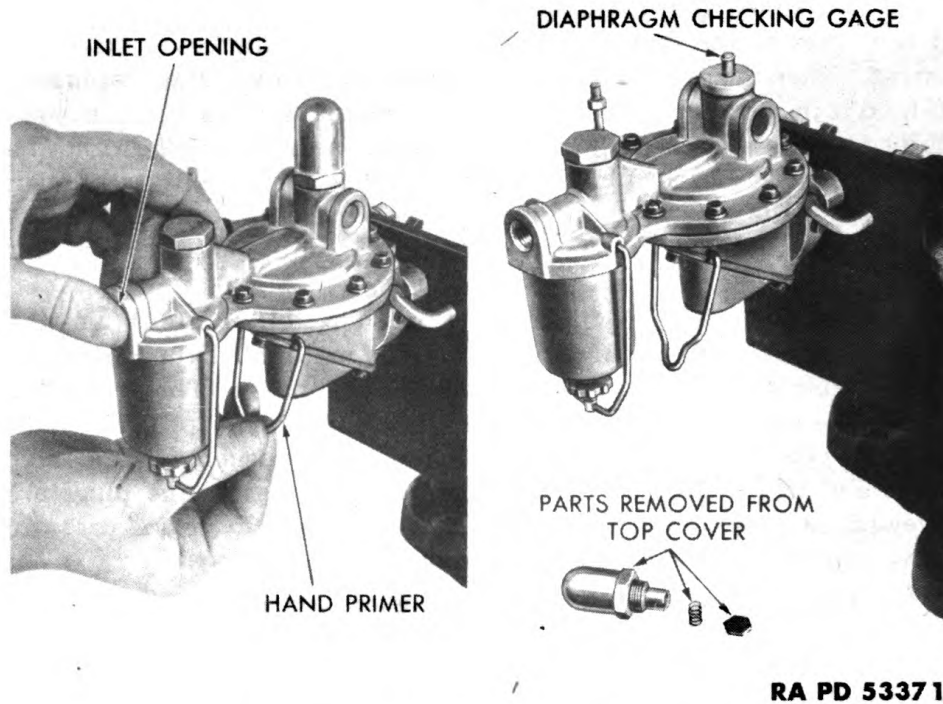

RA PD 53371

**Figure 117—Testing Fuel Pump**

dition. Hold the finger over the inlet opening of the pump. If suction is felt when the hand primer or rocker arm is operated, the fuel pump is operative. Test the position of the diaphragm with the diaphragm checking gage. Remove the airdome and gasket, the valve spring and valve. Insert the tool into the opening with the pointed end contacting the diaphragm. If the grooved mark on the gage is visible with the diaphragm in the high position, the pump is properly assembled. If the mark is not visible, loosen the cover screws and reassemble the pump according to instructions. Refer to paragraph 76 a (5) for fuel pump pressure test after fuel pump has been installed on engine.

**CHAPTER 2**  
**ENGINE AND CLUTCH (Cont'd)**

**Section IX**

**WATER PUMP REBUILDING**

	Paragraph
Disassembly of water pump.....	63
Inspection of water pump parts.....	64
Assembly of water pump.....	65

**63. DISASSEMBLY OF WATER PUMP.**

a. **Clean Water Pump.** Wash the pump in dry-cleaning solvent and dry with compressed air.

b. **Remove Fan Hub, Pump Shaft and Impeller** (figs. 118 and 119). Drive out the fan hub pin. Attach the puller to the fan hub, tighten the puller screw and remove the hub. Remove the water pump rear cover attaching screws and cover. Pull the shaft, impeller and seal assembly out of the pump.

c. **Remove Pump Bushings** (fig. 120). Drive the pump front

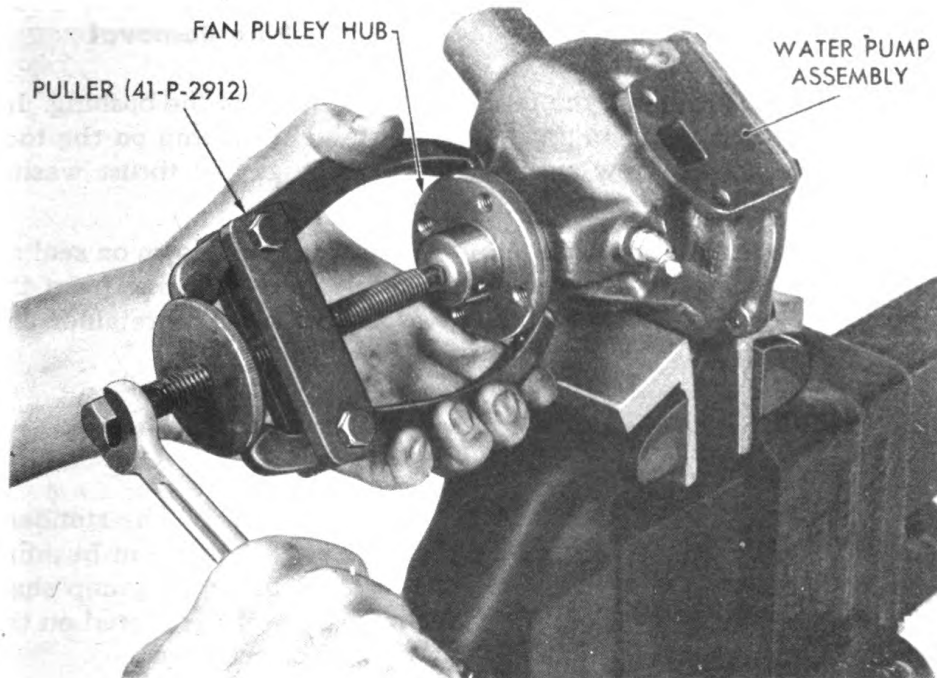

RA PD 53353

**Figure 118—Fan Pulley Hub Removal**



ORDNANCE MAINTENANCE—POWER PLANT, CLUTCH, AND  
ELECTRICAL SYSTEM— $\frac{3}{4}$  AND  $1\frac{1}{2}$  TON VEHICLES (DODGE)

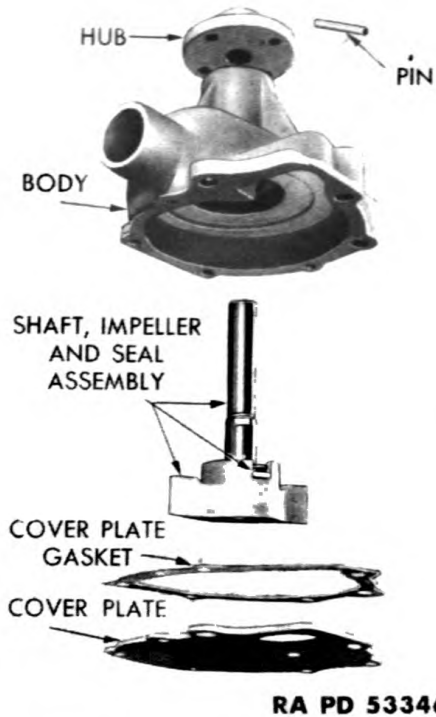

Figure 119—Water Pump Shaft and Impeller Removed

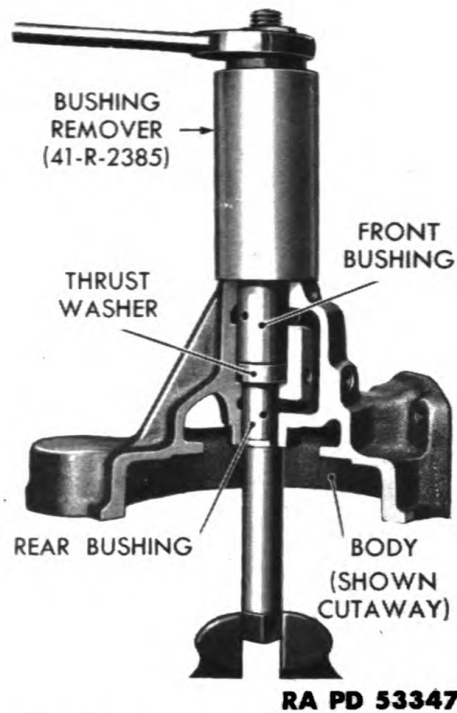

Figure 120—Water Pump Shaft Bushing Removal

bushing lock pin through the bushing into the bore of the bushing. Install the bushing puller in a vise and assemble the pump on the tool. Tighten the puller screw nut until both bushings and thrust washer are removed from the pump.

d. **Disassemble Seal Assembly** (fig. 121). Press down on seal retainer fiber washer and remove the seal retainer lock ring from the impeller. Remove the seal retainer washer, the seal and retainer and seal thrust spring.

#### 64. INSPECTION OF WATER PUMP PARTS.

a. **Clean All Parts** (par. 40 b).

b. **Inspect Impeller and Pump Shaft** (fig. 121). The standard diameter of the pump shaft is 0.593 to 0.594 inch at the front bushing, and 0.668 to 0.669 inch at the rear bushing. Replace the pump shaft and impeller assembly if the shaft is excessively worn or scored on the bearing surfaces or if the impeller is damaged or corroded.

c. **Inspect Body** (fig. 122). Examine the body for cracks, sand holes or deep corrosion. Replace the body if damaged. Inspect the seal surface of the body and if when resurfaced (par. 65 d) the distance

**WATER PUMP REBUILDING**

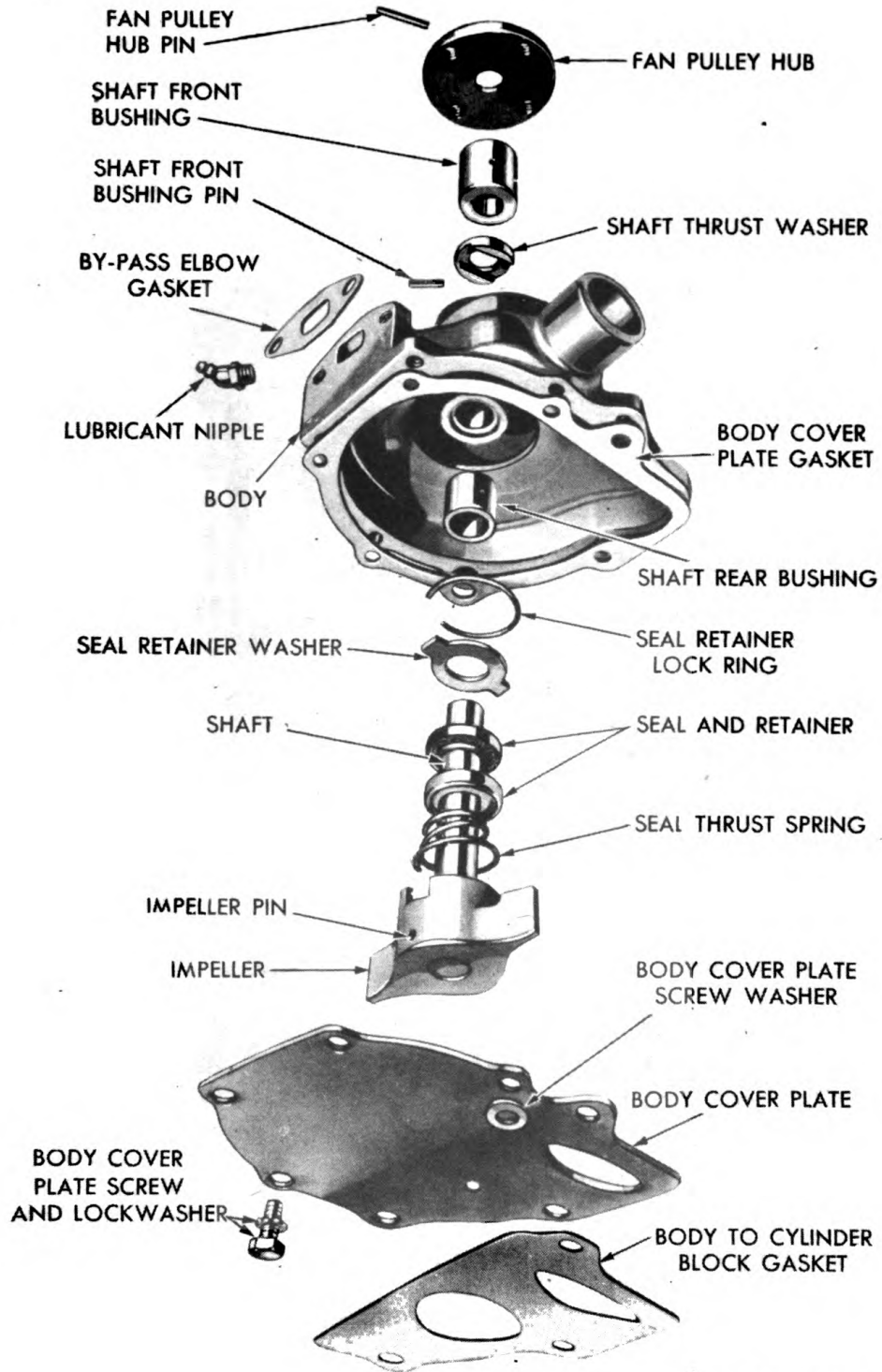

RA PD 53336

**Figure 121—Water Pump Disassembled**

**ORDNANCE MAINTENANCE—POWER PLANT, CLUTCH, AND ELECTRICAL SYSTEM— $\frac{3}{4}$  AND  $1\frac{1}{2}$  TON VEHICLES (DODGE)**

between the seal surface and the face of the body is greater than  $1\frac{1}{16}$  inch, replace the body.

d. **Replace Bushings** (fig. 121). Replace the pump bushings whenever the water pump is rebuilt, as it is not practical to install old bushings after they have been removed:

e. **Replace All Seal Parts** (fig. 121). Replace all water pump sealing parts whenever the pump is disassembled, to insure against leakage.

f. **Inspect Fan Pulley Hub** (fig. 121). Replace the fan pulley hub if it is not a tight fit on the shaft.

REPLACE THE BODY IF THE DIMENSION BETWEEN THE REAR FACE OF THE BODY AND THE SEAL SEAT IS MORE THAN  $1\frac{1}{16}$ -IN. AFTER THE SEAT HAS BEEN REFACED.

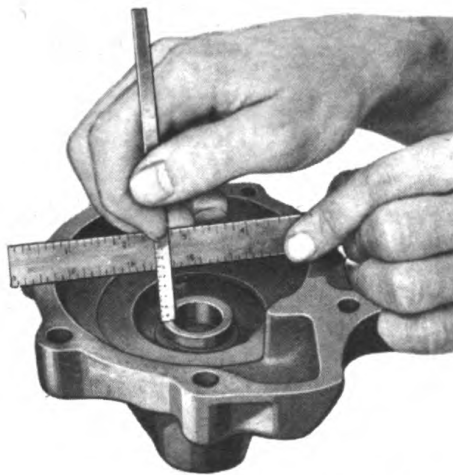

RA PD 53348

**Figure 122—Checking Seal Seat Dimension**

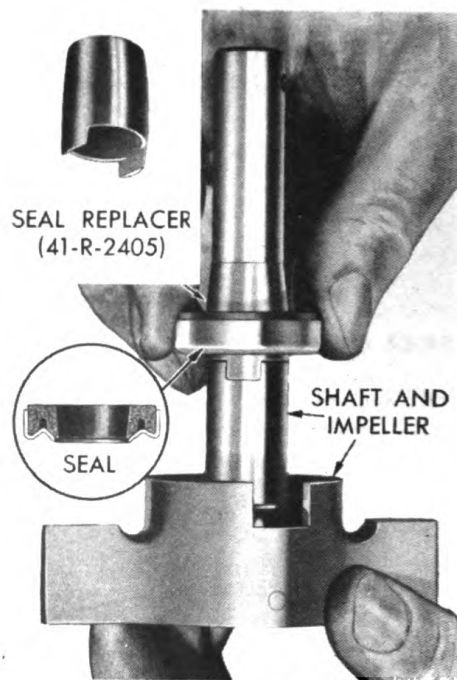

RA PD 53349

**Figure 123—Water Pump Seal Installation**

**65. ASSEMBLY OF WATER PUMP.**

a. **Assemble Parts to Pump Shaft** (fig. 123). Install the seal spring on the shaft with the large end against the impeller. Install the water pump seal installing tool on the pump shaft to prevent damage to the seal and slip the seal retainer, then the seal, on the shaft. Install the fiber seal retainer washer and compress the seal spring by pushing on the fiber washer. Then install and fit the lock ring into the groove in the impeller.

b. **Install Bushings** (figs. 124 and 125). Place the rear (small) bushing over the bushing installing arbor and insert the arbor through

**WATER PUMP REBUILDING**

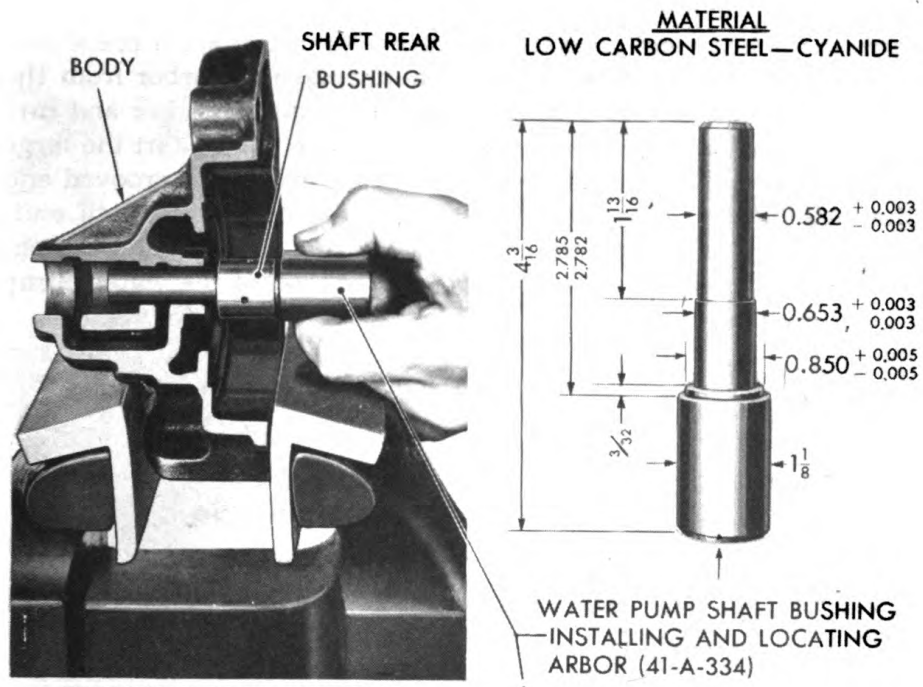

**INSERTING REAR BUSHING  
IN WATER PUMP BODY**

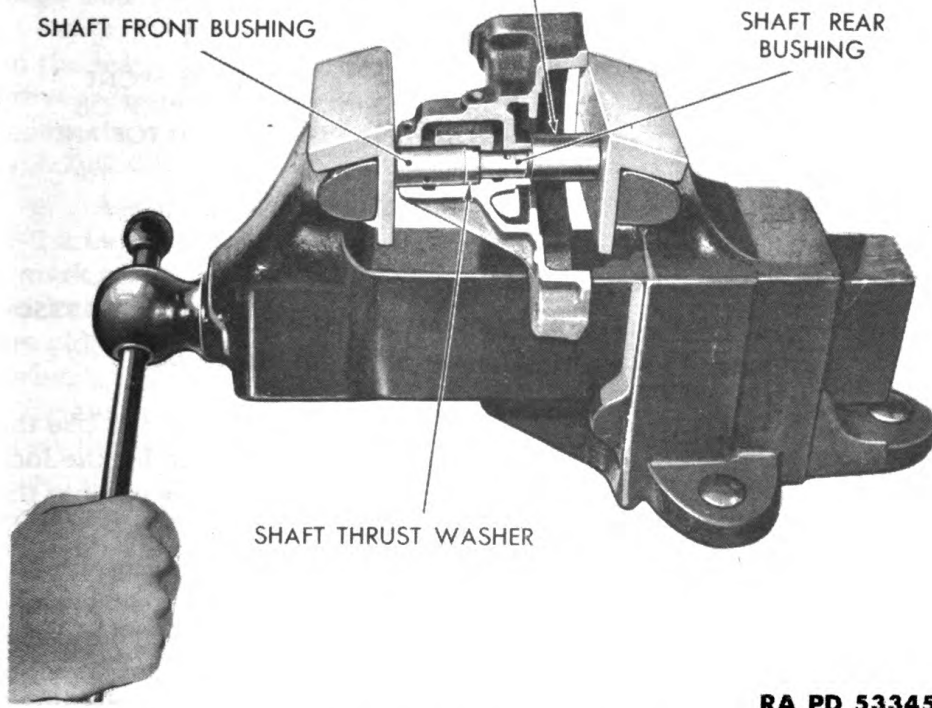

RA PD 53345

**Figure 124—Water Pump Shaft Bushing Installation**

**ORDNANCE MAINTENANCE—POWER PLANT, CLUTCH, AND ELECTRICAL SYSTEM— $\frac{3}{4}$  AND  $1\frac{1}{2}$  TON VEHICLES (DODGE)**

the body from the impeller side of the pump (fig. 124). Start the rear bushing in the body and press it into place with vise or arbor press. Remove the body from the press but do not remove the arbor from the body. Slide the steel thrust washer over the installing arbor and into the body, slotted side first (slot toward rear of pump). Start the large bushing in the body and over the installing arbor with the grooved end of the bushing out. Press the bushing into the body until both ends of the installing arbor contact vise jaws or arbor press. The bushings will then be in position to provide proper location of the water pump seal and impeller (fig. 125).

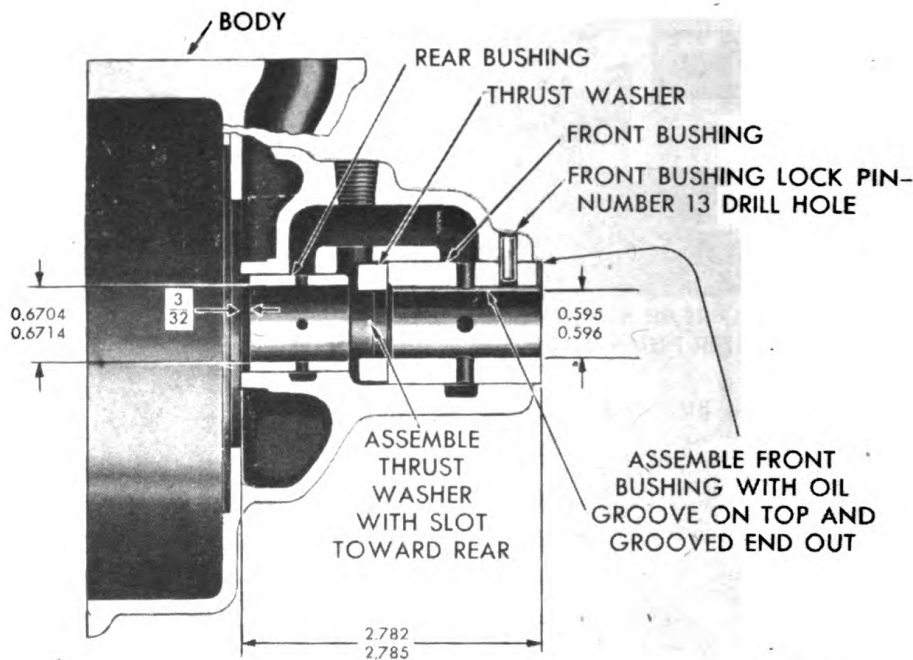

RA PD 53350

**Figure 125—Water Pump Bushings Installed**

c. **Drill Front Bushing and Install Lock Pin** (fig. 125). Use the drill hole in the body as a guide to drill the front bushing for the lock pin. Drill the bushing with a number 13 drill. Drive a new pin into the bushing to lock it in place.

d. **Burnish Bushings and Reface Seat** (fig. 126). Burnish the front bushing to 0.595 to 0.596 inch in diameter and the rear bushing to 0.670 to 0.671 inch with seal seat refacer and bushing burnisher. Clamp the refacer in a vise and install the body over the tool, impeller end down. Turn the body down on the tool slowly in a clockwise direction, until the refacing cutter of the tool contacts the body. Continue turning the body on the tool until a smooth, even cut has been taken

**WATER PUMP REBUILDING**

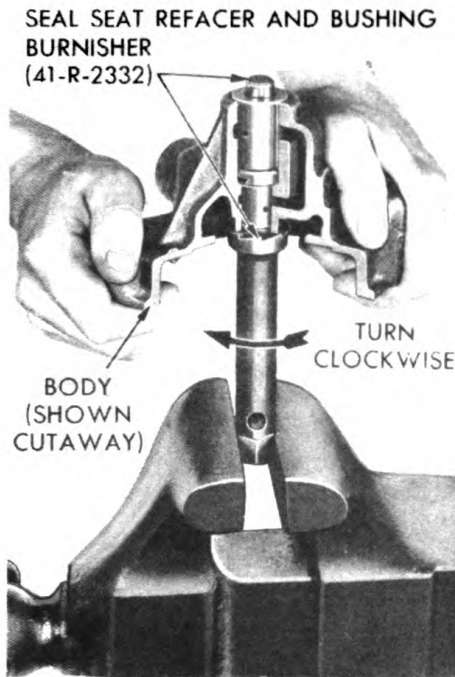

RA PD 53351

**Figure 126—Burnishing Bushings and Refacing Seal Seat**

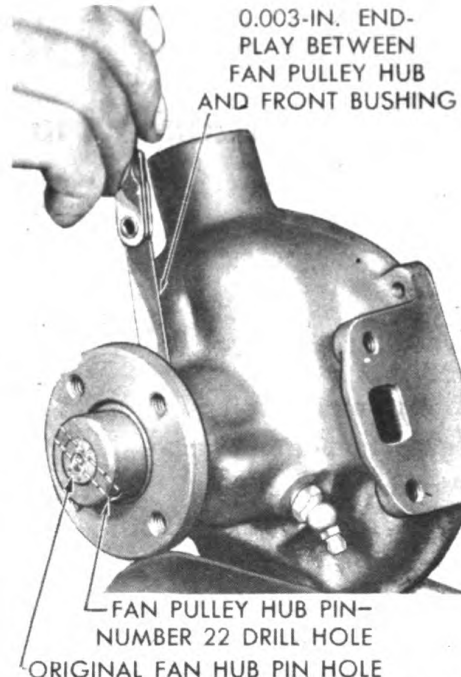

RA PD 53352

**Figure 127—Checking Shaft End Play**

on the seat. Continue turning the body while lifting it off the cutter to prevent leaving a ridge on the seat. Examine the seat carefully and repeat the operation if the seal is not smooth and free of cutter marks or ridges.

e. **Assemble Pump Shaft and Seal Assembly in Body** (fig. 127). If the impeller and pump shaft assembly is *not* being replaced, place a mark across the fan hub end of the shaft, showing the location of the fan hub pin hole in order that the new pin hole can be drilled to cross the old hole at right angle. Install the pump shaft and seal assembly through the rear bushing, the thrust washer and the front bushing. Aline the thrust washer with the pump shaft, so the parts fit together. Press the fan hub on the shaft until there is 0.003-inch clearance between the hub and the front bushing as measured by a feeler gage between the parts. Drill through the hub and shaft with a number 22 drill and install a new pin. Lubricate the bushings with water pump grease.

**ORDNANCE MAINTENANCE—POWER PLANT, CLUTCH, AND ELECTRICAL SYSTEM— $\frac{3}{4}$  AND  $1\frac{1}{2}$  TON VEHICLES (DODGE)**

**CHAPTER 2**

**ENGINE AND CLUTCH (Cont'd)**

**Section X**

**OIL PUMP REBUILDING**

	Paragraph
Disassembly of oil pump . . . . .	66
Inspection of oil pump parts . . . . .	67
Assembly of oil pump . . . . .	68

**66. DISASSEMBLY OF OIL PUMP.**

**a. Remove Cover and Check Drive Shaft End Play (fig. 128).**

(1) **CHECK SHAFT END PLAY** (fig. 128). Remove the cover and gasket. Attach a dial indicator to the pump body so that the indicator button contacts the oil pump drive gear. Move the drive shaft up and down to indicate the amount of end play on the dial. If the end play exceeds 0.010 inch, determine whether the end play is the result of wear at the distributor drive gear end of the shaft or at the oil pump drive gear end of shaft.

(2) **MEASURE CLEARANCE BETWEEN PUMP DRIVE GEAR AND BODY** (fig. 128). Push the pump drive gear into the housing as far as it will go, and lay a small steel scale across the outer end of the gear. Measure the space between the steel scale and the cover flange surface of the oil pump body with a thickness gage. The oil pump drive gear should extend 0.003 inch above the body cover flange and if the measurement is less than this amount, the difference indicates the amount of wear between the inner end of the oil pump drive gear and the body.

(3) **MEASURE CLEARANCE BETWEEN DISTRIBUTOR DRIVE GEAR AND BODY** (fig. 128). Push on the distributor drive gear end of the pump drive shaft so the pump drive gear will be forced out of the pump body as far as it will go, and measure the distance with a thickness gage between a small steel scale, placed across the end of the pump drive gear and pump body cover flange surface. This measurement will indicate the amount of wear between the distributor drive gear and the end surface of the pump body drive shaft housing. The clearance at the distributor drive gear end is excessive if this measurement is more than 0.010 inch.

**b. Remove Pump Drive Shaft and Gear Assembly and Check Pump Gear and Body Wear. Drive out the distributor drive gear**

**OIL PUMP REBUILDING**

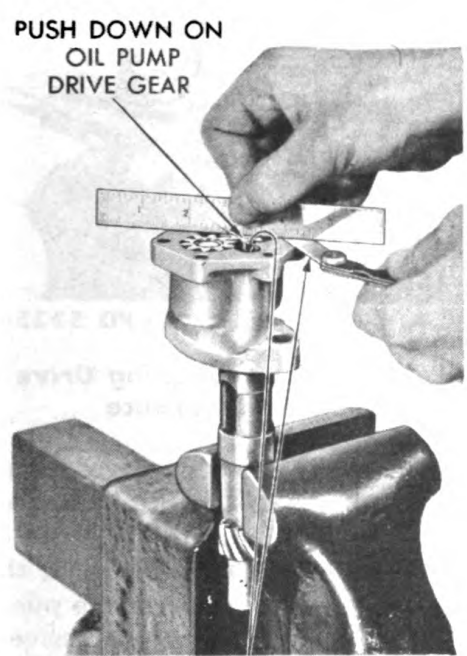
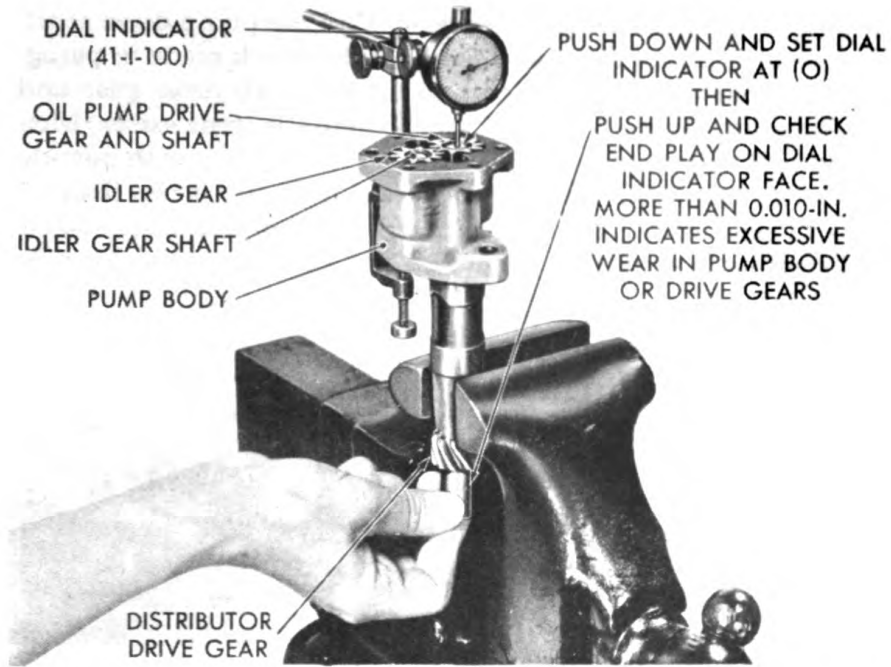

LESS THAN 0.003-IN. INDICATES WEAR IS BETWEEN OIL PUMP DRIVE GEAR AND THE INSIDE OF PUMP BODY

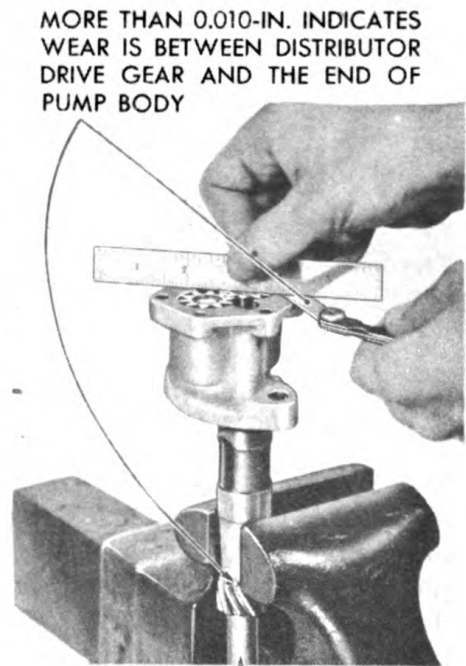

RA PD 53354

**Figure 128—Checking Drive Shaft End Play**

Generated on 2016-06-23 13:21 GMT / http://hdl.handle.net/2027/uc1.b3243992  
 Public Domain, Google-digitized / http://www.hathitrust.org/access\_use#pd-google



**ORDNANCE MAINTENANCE—POWER PLANT, CLUTCH, AND ELECTRICAL SYSTEM— $\frac{3}{4}$  AND  $1\frac{1}{2}$  TON VEHICLES (DODGE)**

pin and press the shaft out of the gear. Pull the pump drive shaft and gear assembly out of the pump body. If the check made in paragraph 66 a indicated excessive wear between the pump drive gear and the body, measure the parts to determine where the wear exists. Measure the width of the oil pump drive gear across the face with outside micrometer (41-C-307). The gear is worn if it measures less than 1.3105 inches. Then install the gear and shaft in the pump body, and lay a small steel scale across the drive gear and over the body cover flange.

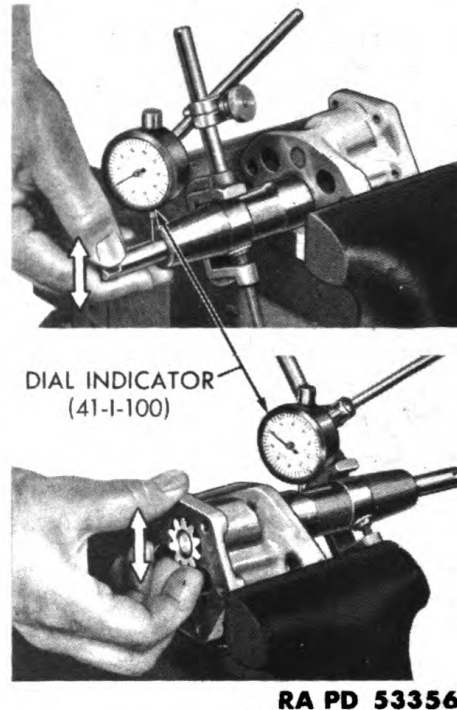
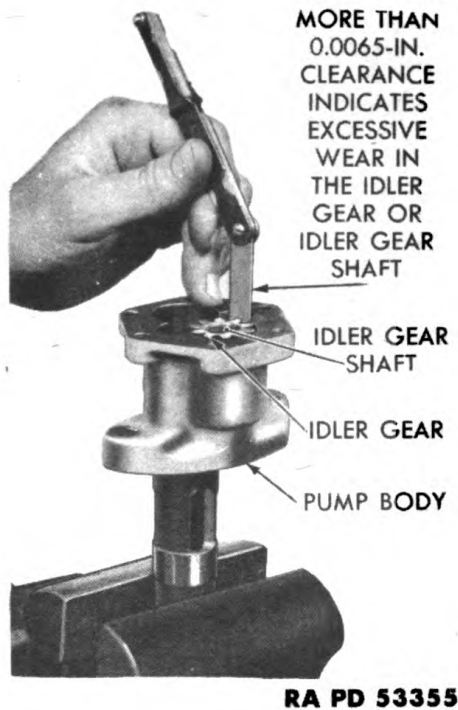

**Figure 129—Checking Idler Gear and Shaft Clearance**

**Figure 130—Checking Drive Shaft Clearance**

Measure the space between the steel scale and the body cover flange of the gear with a thickness gage (fig. 128). The length of the gear plus or minus the feeler gage measurement will indicate the depth of the body gear compartment, which is originally 1.3075 inches. If the depth of the gear compartment is greater than that amount, the pump body is worn. Replace the gear and/or body if they are excessively worn.

c. **Measure Idler Gear Clearance in Body and Idler Gear Shaft Wear** (fig. 129). Insert a thickness gage between the idler gear and pump body and measure the clearance between the shaft and the gear. If the clearance is more than 0.0065 inch, remove the idler gear and drive the idler gear shaft out of the body. Then measure the idler

OIL PUMP REBUILDING

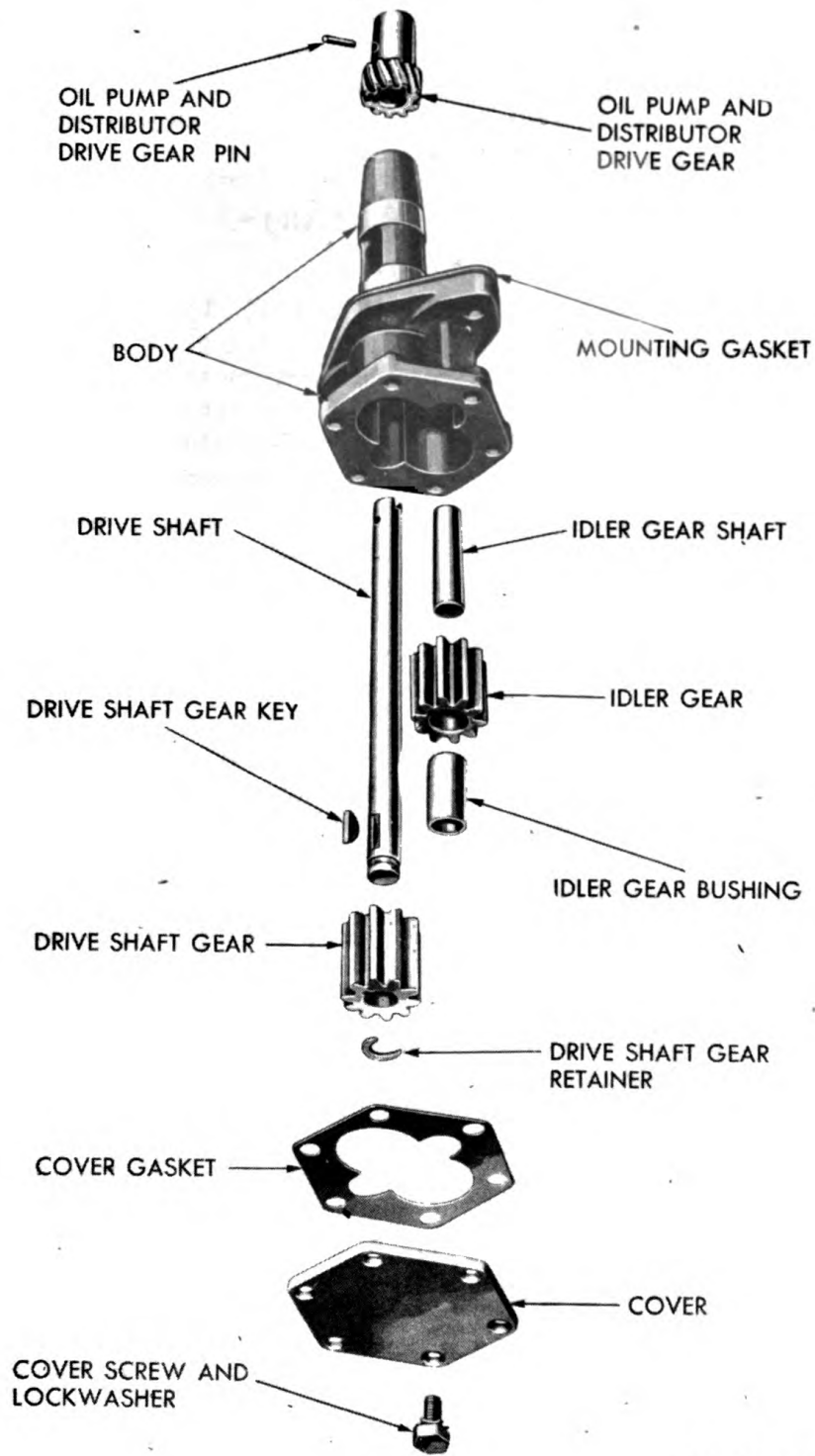

RA PD 53339

Figure 131—Oil Pump Disassembled

**ORDNANCE MAINTENANCE—POWER PLANT, CLUTCH, AND ELECTRICAL SYSTEM— $\frac{3}{4}$  AND  $1\frac{1}{2}$  TON VEHICLES (DODGE)**

gear shaft diameter with a micrometer (41-C-307). If it is worn more than 0.001 inch below 0.4885 inch, which is standard, replace the shaft. If the clearance exceeds the shaft wear by 0.015 inch, replace the idler gear. Replace the idler gear shaft or pump body if the idler gear shaft is not a tight press fit in the body.

**67. INSPECTION OF OIL PUMP PARTS.**

a. **Clean All Parts** (par. 40 b).

b. **Inspect Cover and Gasket** (fig. 131). Inspect the cover for damage or cracks and for wear caused by the gears rubbing on the cover. If the cover is merely scored or worn by the gears, reverse the cover when the pump is reassembled. Cover wear indicates excessive drive shaft end play. Replace the cover gasket when making oil pump repairs to maintain the correct clearance between the cover and the gears.

c. **Inspect Pump Gears** (fig. 131). Inspect the pump drive gear and idler gear teeth and if excessive wear is evident, replace the gears. If wear is not visible, measure the diameter of the gears with a micrometer (41-C-307). Replace the drive gear if the diameter is less than 1.161 inches and replace the idler gear if the diameter is less than 1.163 inches.

d. **Check Gear and Body Clearance.** If the idler gear and shaft and the pump drive gear and shaft assembly are satisfactory, reinstall them in the pump body. Then measure the clearance between the gears and the body with a thickness gage. If the clearance between the body and gears exceeds 0.004 inch, replace the pump body.

e. **Inspect Body** (fig. 131). Inspect the pump body for sand holes, cracks or irregular machined surfaces that might cause leaks. Replace the body if it is unsatisfactory.

f. **Measure Drive Shaft Clearance in Pump Body** (fig. 130). Insert the pump drive shaft and gear assembly in the pump body and attach a dial indicator to the pump body with the indicator button against the drive shaft at the distributor drive gear end. Move the shaft away and then towards the indicator button and note the indicator reading. Then move the dial indicator on the pump body so the indicator button contacts the drive shaft through the opening in the body shaft housing, and determine the clearance at this point. If the clearance at either end of the shaft exceeds 0.002 inch, remove the shaft and measure the diameter with a micrometer (41-C-307). Replace the shaft if it measures less than 0.484 inch. Replace the pump body if the clearance exceeds 0.001 inch more than the shaft is worn.

g. **Check Fit of Pump Drive Gear on Shaft.** Check the fit of the pump drive shaft gear on the pump drive shaft and if it is loose, replace the gear and shaft assembly. To remove the pump drive gear from the

**OIL PUMP REBUILDING**

shaft, press the gear on the shaft until the horseshoe-shaped retainer is exposed and remove the retainer. Then press the gear off the shaft and remove the key.

**68. ASSEMBLY OF OIL PUMP.**

a. **Install Idler Gear Shaft and Gear (fig. 132).** Press the idler gear shaft into the oil pump body until the end of the shaft is flush with the body cover flange and install the idler gear on the shaft.

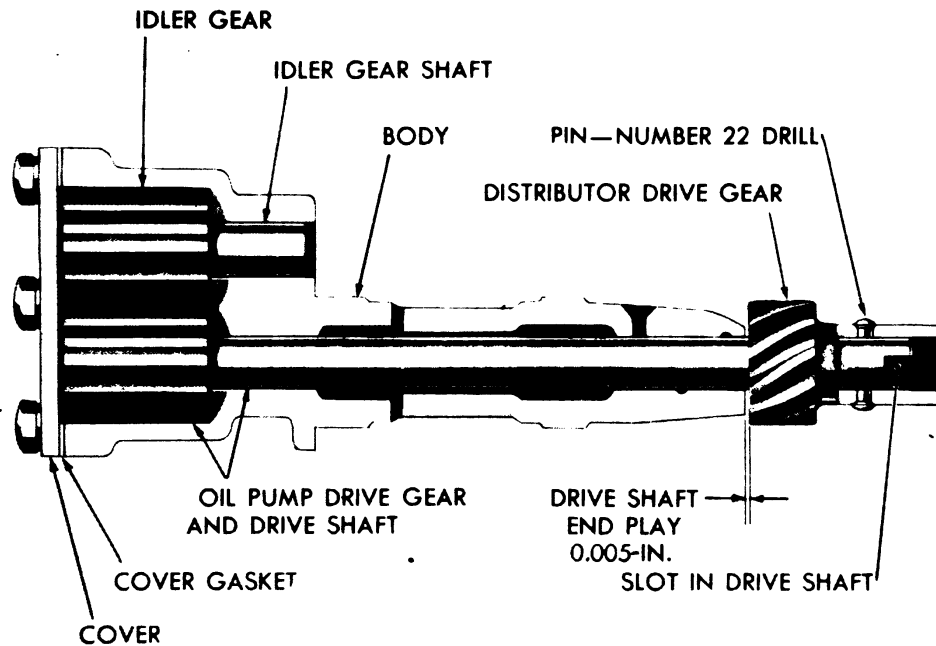

RA PD 53357

**Figure 132—Oil Pump Assembled**

b. **Install Drive Shaft and Gear Assembly (fig. 132).**

(1) **INSTALLATION OF ORIGINAL DRIVE SHAFT AND DISTRIBUTOR DRIVE GEAR (fig. 132).** If the original drive shaft and gear and the distributor gear are to be installed, it is important to hold the end play to 0.005 to 0.010 inch to prevent wear of the pump cover. Install the drive shaft and gear assembly in the pump housing. Line up the pin hole of the distributor drive gear with the hole in the drive shaft and start the gear on the shaft with the gear tooth end of the gear towards the housing. Press the gear on the shaft until the pin hole of the gear is accurately aligned with the hole in the shaft. The location of the distributor gear on the shaft affects the pump drive gear end play, and it is therefore important to use a straight punch to align the pin holes properly before installing the pin. When the gear is properly positioned

**ORDNANCE MAINTENANCE—POWER PLANT, CLUTCH, AND ELECTRICAL SYSTEM—¾ AND 1½ TON VEHICLES (DODGE)**

on the shaft, there should be 0.005 to 0.010 inch clearance between the gear and the housing when measured with a feeler gage. Drive a new pin through the gear and shaft and rivet each end of the pin slightly. Turn the shaft by hand to make sure that it turns freely.

(2) **INSTALLATION OF NEW DRIVE SHAFT AND DISTRIBUTOR DRIVE GEAR** (fig. 132). If the pump drive gear and shaft assembly or the distributor drive gear requires replacement, replace both parts. The new parts must be assembled and properly drilled to maintain the correct end play. Install the drive shaft and gear assembly in the oil pump body. Then start the distributor drive gear on the shaft with the gear tooth end of the gear towards the housing and with the pin hole, which is drilled through one side of the gear hub, at right angle to the drive shaft slot. Press the gear on the shaft until a 0.005 inch thickness gage will just pass between the end of the housing and the end of the gear (fig. 137). Then drill through the shaft and other side of gear with a number 22-size 0.157 inch drill, and countersink the drill hole on each side of the gear. Drive a new pin through the gear and shaft and peen over each side of the pin to retain it in place.

c. **Install Cover** (fig. 132). If the cover is visibly worn, caused by the gears contacting the cover, clean all paint off the cover, turn it over and assemble the unworn surface toward the gears with a new gasket.

**CHAPTER 2**  
**ENGINE AND CLUTCH (Cont'd)**

**Section XI**

**CLUTCH REBUILDING**

	Paragraph
Disassembly of clutch.....	69
Inspection and repair of clutch parts.....	70
Assembly of clutch.....	71

**69. DISASSEMBLY OF CLUTCH.**

a. **Mount Pressure Plate Assembly in Rebuilder.** Mount the clutch on rebuilder (41-C-2480) and compress the cover in accordance with the instructions of the rebuilding tool manufacturer.

b. **Disassemble Pressure Plate and Cover** (fig. 133). Saw or file out the slots of the eyebolt nuts to release them and remove the three nuts. Then release the cover with rebuilder fixture (41-C-2480) according to the instructions of the tool manufacturer. Remove the cover and detach the release lever springs from the cover. Remove the pressure plate springs from the pressure plate. Remove the release levers by holding the lever eyebolt between the thumb and index finger of the hand, while lifting the inner end of the release lever as high as possible with another finger (fig. 134). Press down on the eyebolt to keep it in its socket and lift the release lever strut over the ridge at the outer end of the lever. Then lift the eyebolt lever off the pressure plate and remove the strut. Remove the pressure plate baffle. Release the clutch from the rebuilder and remove the pressure plate.

**70. INSPECTION AND REPAIR OF CLUTCH PARTS.**

a. **Clean All Parts.**

(1) Wash all parts except the release bearing and clutch disk in dry-cleaning solvent and dry with compressed air (par. 40 b).

(2) **CAUTION:** *The release bearing is of the ball type packed with lubricant when manufactured and requires no further lubrication. If the bearing is washed in kerosene, gasoline or similar solvents, the lubricant packed in the bearing will dissolve and the bearing will require replacement.*

b. **Inspect Driving Disk.** Examine disk for broken hub coil springs, broken disk, loose or broken rivets. Try the fit of the driving disk hub on a transmission pinion mainshaft that is not worn in the splines, to determine whether it is too loose and unfit for further service. Check the surface of the disk and lining for warpage. Replace the

ORDNANCE MAINTENANCE—POWER PLANT, CLUTCH, AND  
ELECTRICAL SYSTEM— $\frac{3}{4}$  AND  $1\frac{1}{2}$  TON VEHICLES (DODGE)

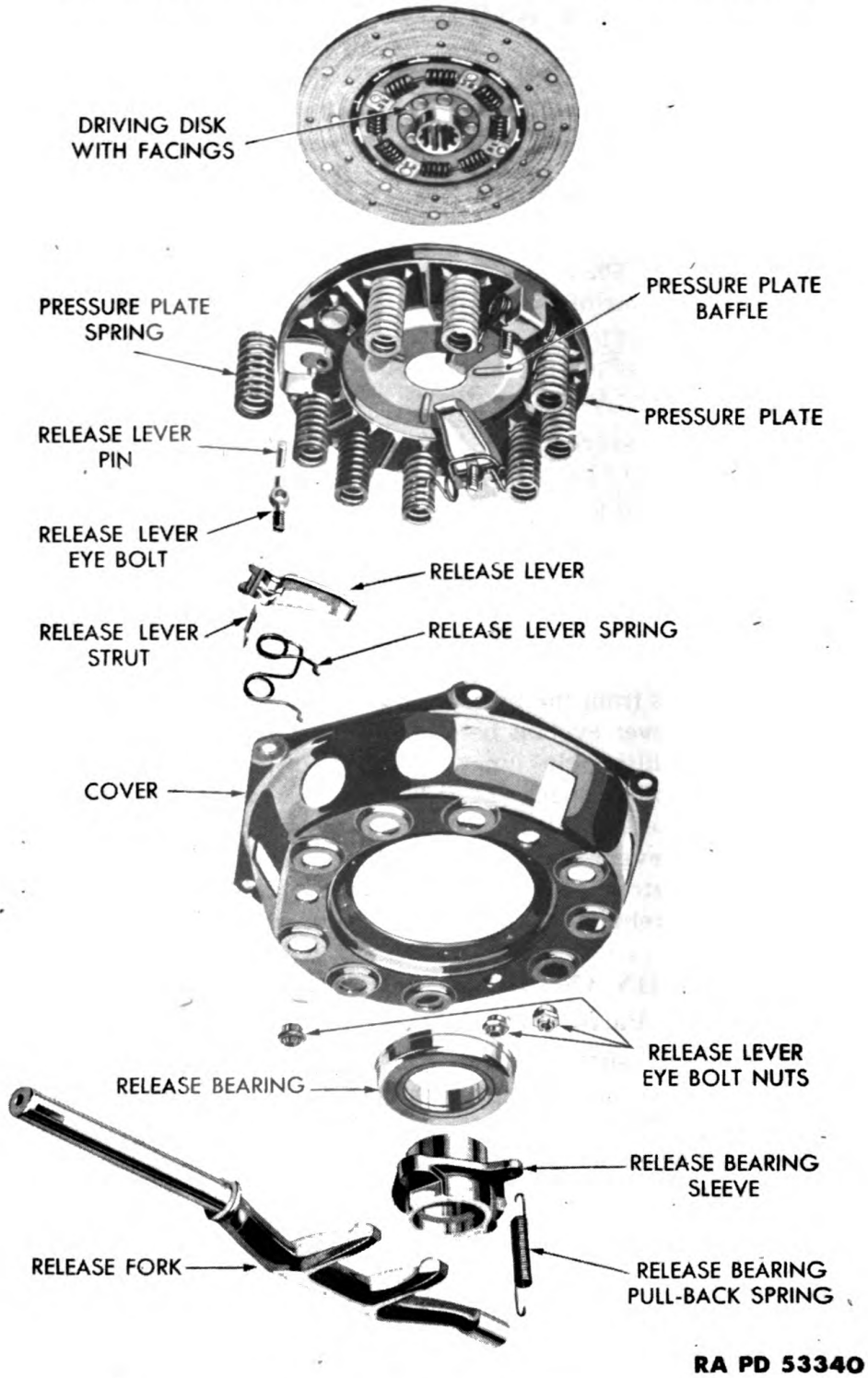

Figure 133—Clutch Disassembled

## CLUTCH REBUILDING

disk assembly if unsatisfactory. Inspect the facings for oil or grease, excess wear and loose rivets or damaged facings. If only the facings are worn or damaged, replace the facings (par. 70 h).

**c. Inspect Pressure Plate and Flywheel Surface.** Examine flywheel and pressure plate surfaces for scoring, ridges, cracks or damage due to heat, such as discoloration or checking of the metal.

**d. Inspect Crankshaft Bushing (Main Drive Pinion Pilot).** Inspect the crankshaft bushing located in the rear end of the crankshaft for roughness or scoring and if necessary replace the bushing.

**e. Inspect Pressure Plate Cover and Springs.** Inspect the driving slots in the clutch cover for wear. Examine the attaching flange or rim of the cover for warpage. Examine the cover carefully for cracks. If any of these conditions exist, replace the cover as it cannot be satisfactorily repaired. Check the clutch pressure springs with coil spring tester (17-T-1600). At their working length,  $1\frac{1}{16}$ -inches, the springs should test 150 to 160 pounds pressure. Replace springs that do not test up to specifications. Replace the release lever springs if distorted, stretched or damaged by overheating.

**f. Inspect Release Levers, Eyebolts, Pins and Struts.** Carefully examine these component parts of the clutch pressure plate for wear and replace those that appear unsatisfactory.

**g. Inspect Release Bearing.** The release bearing is permanently lubricated when it is manufactured and requires no further lubrication (par. 70 a (2) ). Inspect the release bearing for roughness and extreme looseness of the bearing races and for free fit on the bearing sleeve. Replace the bearing if it is not satisfactory.

### **h. Reface Driving Disk.**

(1) **CAUTION:** Do not allow any grease or oil to come in contact with the clutch facings. Remove all oil or grease from the machine parts and hands before working on the clutch disk to avoid chattering or grabbing of the clutch.

(2) Drill out the old rivets and remove the old facings from the clutch disk. Do not punch the rivets out; the use of a punch will damage the clutch cushion springs. After removing the old facings, clean the driving disk with dry-cleaning solvent and dry with compressed air. Remove any burrs or rough edges around the rivet holes or disk with a file. Rivet new facings of the proper thickness (0.125 in.) on the disk with relining machine (40-M-3).

## 71. ASSEMBLY OF CLUTCH.

**a. Assemble Pressure Plate to Rebuilder.** Remove all oil, grease and dirt from the surfaces and accessories of the clutch rebuilder. Install the pressure plate on clutch rebuilder (41-C-2480) in accordance with the instructions of the rebuilder manufacturer.



**ORDNANCE MAINTENANCE—POWER PLANT, CLUTCH, AND ELECTRICAL SYSTEM— $\frac{3}{4}$  AND 1 $\frac{1}{2}$  TON VEHICLES (DODGE)**

b. **Assemble Baffle Plate and Release Levers** (fig. 134). Place the pressure plate baffle in the pressure plate. Lightly coat the release lever pin, the plain end of the eyebolt and the edges of the strut with general purpose grease No. 1, and install the release lever pin in the eyebolt. Place the release lever over the threaded end of the eyebolt so the groove of the lever fits over the release lever pin. Hold the threaded end of the eyebolt between the thumb and forefinger and raise the inner end of the lever as high as possible with one of the other fingers (fig. 134). With the other hand, place the release lever strut in the slot of the pressure plate lug. Lift the strut up into the lug slot and tilt

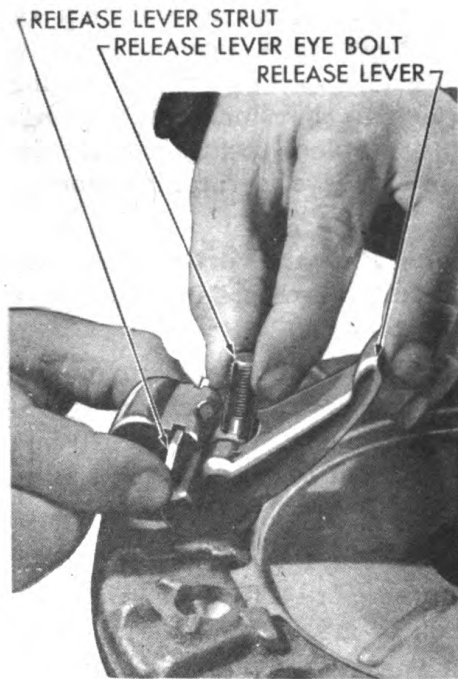

RA PD 53358

**Figure 134—Release Lever Removal and Installation**

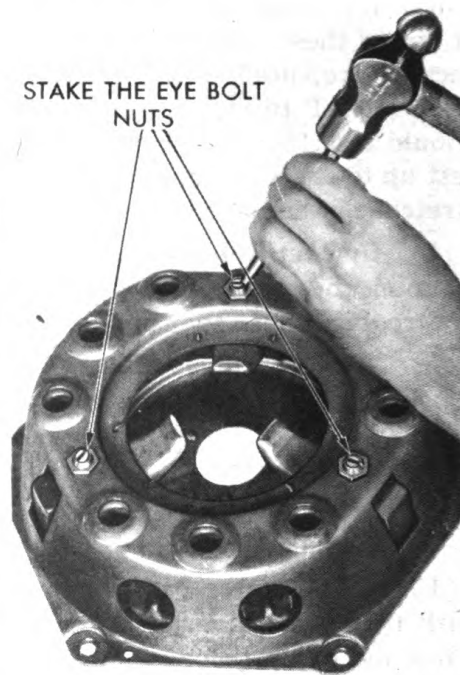

RA PD 53359

**Figure 135—Staking Release Lever Eyebolt Nuts**

it so it will pass the ridge on the lower end of the lever and drop it into the groove in the lever. Follow this same procedure with the other two eyebolt and lever parts.

c. **Assemble Cover to Pressure Plate.** Place the pressure springs over the bosses of the pressure plate. Assemble the release lever tension springs to the cover. Hook the free ends of the springs through the small holes in the inside rim of the top of cover and move the coils so they rest against the inside of cover. Lightly coat the sides of the pressure plate driving lugs where they are fitted into the cover with graphite grease, to prevent squeaking and place the cover carefully over the

### CLUTCH REBUILDING

pressure plate so the ends of the pressure plate springs fit into the seats in the cover and the ends of the eyebolts are in line with the holes in the cover.

**d. Compress Cover on Pressure Plate.** Compress the cover on the pressure plate with clutch rebuilder (41-C-2480) in accordance with the instructions of the rebuilder manufacturer. Make sure the driving lugs of the pressure plate are lined up in the holes in the cover and that the pressure springs are not cocked or off their seat, while compressing the pressure plate assembly.

**e. Install Eyebolt Nuts.** Continue to compress the assembly until the cover flange rests against the rebuilder base and screw the eyebolt nuts, large end toward the cover, on the eyebolts until the top of the nuts and end of eyebolts are flush. Slowly release the pressure on the clutch pressure springs.

**f. Check Clutch Release Lever Adjustment and Adjust** (fig. 135). Adjust the clutch release levers for proper position whenever the clutch is disassembled or whenever clutch parts are replaced or repaired. Install the rebuilder indicator gage and measure the position of the clutch levers according to the rebuilder manufacturer's directions. Make the release lever adjustments carefully so that all levers will be adjusted evenly. Adjust the release lever up or down by turning the release lever eyebolt nut until the proper setting is obtained. Then move the rebuilder gage to the other two release levers and adjust in same manner. Stake the adjusting nuts (fig. 135) to lock the adjustment nuts in place.

ORDNANCE MAINTENANCE—POWER PLANT, CLUTCH, AND  
ELECTRICAL SYSTEM—¾ AND 1½ TON VEHICLES (DODGE)

CHAPTER 2

ENGINE AND CLUTCH (Cont'd)

Section XII

INSTALLATION OF ENGINE

	Paragraph
Pre-installation inspections and service . . . . .	72
Installation of engine assembly . . . . .	73
Installation of transmission assembly . . . . .	74
Installation of front fender and radiator assembly . . . . .	75
Tests and adjustments . . . . .	76

**72. PRE-INSTALLATION INSPECTIONS AND SERVICE.**

a. Before installing a new or rebuilt engine assembly, perform the following inspections and servicing:

- (1) Flush the radiator core (par. 26).
- (2) Inspect condition of radiator inlet and outlet hose and install new hose if deterioration is apparent.
- (3) Inspect exhaust pipe flange for damage and tail pipe for kinks or damage.
- (4) Inspect hand brake lining and drum. Adjust hand brake.
- (5) Inspect fuel line from fuel filter to fuel pump for damage.
- (6) Clean the fuel filter on the dash (fig. 136).

**73. INSTALLATION OF ENGINE ASSEMBLY.**

a. **Place Engine in Chassis and Install Mounting Bolts** (fig. 137). Place the spacer pads on the rear motor support frame brackets. Install an engine-lifting fixture on the engine and move the engine into position in the frame. Guide the accelerator rod into the body opening while the engine is being moved into position. Avoid damaging the engine attaching parts by careful handling. Insert the rear engine support bolts through the frame brackets and engine support from underneath and install the support bolt springs, washers and nuts. Hold the bolts and tighten the nuts until the cotter pin can be installed. Install the engine front support screws with shakeproof lock washers and tighten.

b. **Install Brake Pedal and Bracket, and Clutch Pedal and Bracket Assemblies.** Place the brake pedal bracket on the frame side member and install the attaching bolts with a shakeproof washer under the bolt head and also under the nut. Attach the master cylinder push rod to the brake pedal, with the push rod end pin and lock in place with

**INSTALLATION OF ENGINE**

FILTER ELEMENT RETAINER CUP AND NUT  
FILTER ELEMENT HEAD STUD



FILTER ELEMENT—THE DISCS CAN BE SEPARATED TO CLEAN WITHOUT DISASSEMBLING THE ELEMENT—DO NOT DISASSEMBLE THE ELEMENT

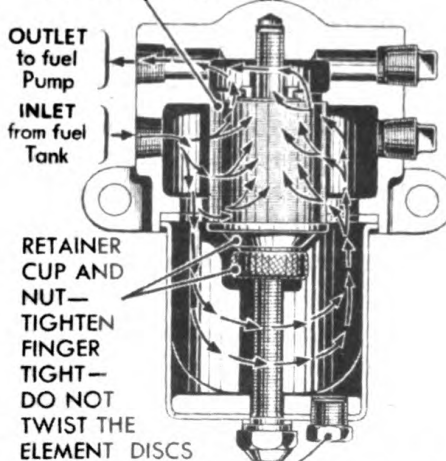

RETAINER CUP AND NUT—TIGHTEN FINGER TIGHT—DO NOT TWIST THE ELEMENT DISCS  
DRAIN PLUG—TO FACILITATE THE DRAINING OF WATER OR DIRT FROM THE FILTER

RA PD 53225

**Figure 136—Fuel Filter**

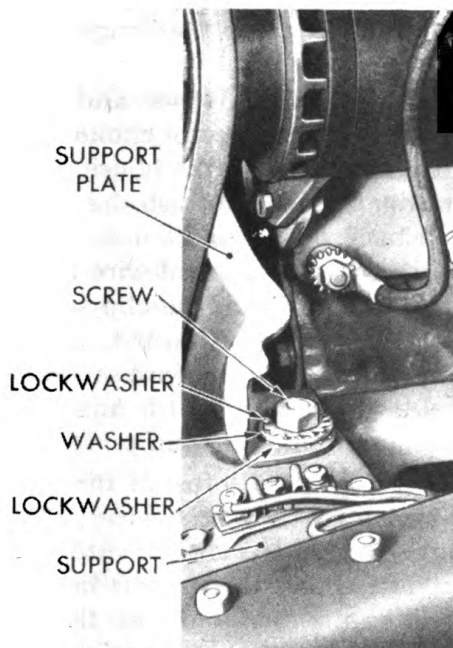

ENGINE FRONT SUPPORT

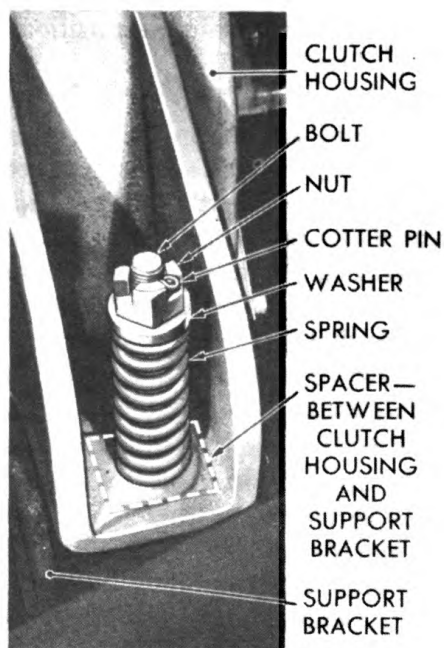

ENGINE REAR SUPPORT

RA PD 53373

**Figure 137—Engine Support Mounting Bolts**

**ORDNANCE MAINTENANCE—POWER PLANT, CLUTCH, AND ELECTRICAL SYSTEM— $\frac{3}{4}$  AND 1  $\frac{1}{2}$  TON VEHICLES (DODGE)**

a cotter pin. Attach the pull-back spring to the extension on the brake pedal and connect the spring to the pull-back spring bracket on the frame, with the brake spring pliers (41-P-1579). Position the clutch pedal and bracket assembly on the left side of rear motor support. Insert the longest attaching screw with lock washer in the lower left screw hole and insert the two short screws with lock washers in the upper and lower right screw holes. Then attach the remaining screw which also attaches the ground strap. Install a shakeproof lock washer on each side of the ground strap when attaching it with the screw. Connect the clutch pedal pull-back spring to the frame bracket with the brake spring pliers. Attach the clutch operating rod to the pedal with the clevis pin and lock in place with a cotter pin.

c. **Connect Ground Straps.** Connect the engine to frame ground strap to the right side of clutch housing, using a shakeproof lock washer on each side of the ground strap. Connect the engine to dash ground strap to the right rear cylinder head screw, using a shakeproof lock washer on each side of the ground strap.

d. **Install Right Engine Dust Pan.** Attach the dust pan to the frame side member at the front end with the two cap screws and lock washers. Attach the pan to the front cross member and fasten the lamp wire clip. Bend the clip over the lamp wire. Install the torque arrester on the frame side member with the two bolts and nuts with lock washers.

e. **Connect Exhaust Pipe.** Install a new exhaust pipe flange gasket and place the pipe in position. Install and tighten the flange bolts, nuts and lock nuts.

f. **Connect Throttle and Choke, Windshield Wiper and Fuel Line Hose.** Insert the choke control wire in the carburetor choke lever swivel and the guide housing in the bracket clip. Set the housing end flush with the forward end of clip and tighten clamp. Push the choke button on the dash all the way in and back off about  $\frac{1}{16}$  inch. Then tighten the swivel set screw. Connect the throttle control wire to the bell crank on the manifold and attach the housing to the clip so it is flush with the end of the clip. Push the throttle on dash to closed position, then pull it back about  $\frac{1}{16}$  inch and tighten the wire set screw at bell crank. Connect the windshield wiper hose to the manifold vacuum tube. Connect the flexible fuel hose to the fuel pump.

g. **Install Horn and Carburetor Air Cleaner.** Install the horn on the engine mounting bracket and attach the two horn wires. Slide the air cleaner elbow and stud assembly on the carburetor attaching studs and install the lock washers and nuts. Place the support bracket over the elbow stud and fasten in place on the manifold with the cap screw and lock washer. Then fasten the bracket to the elbow with the lock washer and nut. Install a new elbow to air cleaner gasket on the elbow and attach the cleaner body to the elbow. Wash the cleaner oil reservoir and install it in the body. Fill the reservoir with engine oil to

### INSTALLATION OF ENGINE

the marked level. Wash and drain the cleaner element, install cover and retaining wing nut.

**h. Connect Oil Gage, Starter Pedal and Thermometer.** Connect the oil gage tube to the flexible hose connection. Insert the clevis pin through the starter shift lever and the pedal rod. Install the retainer clip over the ends of the clevis pin. Move the thermometer tube over the engine retainer clip located at the rear of the cylinder head and install the thermometer tube bulb in the cylinder head opening. Tighten the gland nut.

**i. Connect Distributor and Starter Switch Wiring.** Attach the battery cable, the wiring harness wire, and the lead of the starter switch condenser to the post of the starter switch. Push the high-tension distributor wire into the distributor cap, and connect the coil to distributor wire at the distributor.

**j. Install Transmission Assembly** (par. 74).

**k. Install Front Fenders and Radiator Assembly** (par. 75).

**l. Make Tests and Adjustments** (par. 76).

### 74. INSTALLATION OF TRANSMISSION ASSEMBLY.

**a. Install Transmission.** Guide the transmission main drive pinion through the clutch release bearing and sleeve assembly and through the clutch disk hub splines into the crankshaft bushing in the end of the crankshaft. Move the transmission into place on the pilot studs (par. 36 h) and install the lower transmission cap screws with lock washers. Remove the pilot studs and install the upper transmission cap screws and lock washers.

**b. Connect Intermediate Propeller Shaft.** Slide the universal joint sliding yoke on the intermediate propeller shaft to engage the universal joint with the transmission companion flange. Install the clamps on the universal joint and install the bolts with bolt locks. Install new nut locks on the bolts and install the nuts. Tighten the nuts securely and bend over the lugs of all clamp bolt and nut locks.

**c. Attach Intermediate Cross Member (Except on Ambulance).** Move the cross member into position and insert the four small bolts which attach the cross member to the upper flanges of the frame side rails. Install lock washers and nuts but do not tighten the nuts. Assemble the rear cross member to frame gusset to the cross member with two of the large cap screws with lock washers, also the two large cap screws with lock washers to attach the cross member to the front gusset. Install the two rear gussets to frame side rail bolts and nuts with lock washers; also the two large bolts and nuts with lock washers, attaching the cross member to the right frame side rail. Tighten all bolts and nuts securely.

**d. Connect Transfer Case Control Rod Hand Brake Cable and Speedometer Cable.** Connect the transfer case control rods at the transmission end. Connect both ends of the hand brake cable on the

**ORDNANCE MAINTENANCE—POWER PLANT, CLUTCH, AND ELECTRICAL SYSTEM— $\frac{3}{4}$  AND 1  $\frac{1}{2}$  TON VEHICLES (DODGE)**

1  $\frac{1}{2}$ -ton, 6 x 6 models. Connect speedometer cable and housing to the transmission on  $\frac{3}{4}$ -ton, 4 x 4 models.

e. **Connect Winch Drive Shaft (if so equipped).** Make sure the power take-off drive shaft key is in position. Slide the winch drive shaft joint assembly on the take-off drive shaft. Tighten the set screw which holds the universal joint assembly on the power take-off drive shaft. Place a new wire through the head of the set screw and lock it around the joint. Set the drive shaft collar  $\frac{1}{2}$  inch ahead of the splined yoke and tighten the set screw. Place a new wire through the head of the set screw and lock it around the collar.

f. **Check Transmission Lubricant.** Check the level of the transmission lubricant and refill with lubricant to  $\frac{1}{2}$  inch below level of filler hole with lubricant at room temperature. Install filler plug.

g. **Install Floor Center Panel and Plates.** Lower the floor center panel into position over the gearshift lever, hand brake and transfer case levers. If the vehicle is equipped with a power take-off, slide the end of the power take-off control lever up through the opening in the center floor panel and hold it in position. Lift up the floor panel and install the end plate clevis pin and cotter pin at the shifter lever end plate, also the cotter pin with plain washer in the shifter shaft eye bolt pin. Install the panel cap screws with shakeproof lock washers and tighten. Install the pin and cotter pin which attach the accelerator pedal to the pedal rod. Lay the right floor plate in position and install the screws with shakeproof lock washers. Connect the throttle control spring to the clip on the accelerator shaft to throttle bell crank rod. Lay the left floor plate in position and install the attaching screws with shakeproof lock washers. Install the clutch and brake pedal draft pads and pad retainers. Tighten all the screws securely.

h. **Install Spare Wheel and Tire (except ambulance).** Place the wheel and tire assembly on the carrier and install the carrier plate and nut. Tighten the nut securely and install the lock.

i. **Install Floor Mat (ambulance only).** Place the rear section of the floor mat in position and install the screws with plain washers. Place the center and two end linoleum retainers in position and install the screws. Work the front section of the floor mat into place so that the openings in the mat will slide down over the gearshift, hand brake and transfer case levers and the accelerator pedal. Install the pin and cotter pin to attach the accelerator pedal to the accelerator pedal rod. Install the mat screws with plain washers and tighten. Place the driver's seat in position and, with it raised to its highest position, install the seat adjusting mechanism to floor cap screws with lock washers. Install the one short cap screw in the right rear screw hole of the seat adjusting mechanism. Place the attendant's seat in position and tilt it forward. Install the seat support bracket cap screws with lock washers.

## INSTALLATION OF ENGINE

## 75. INSTALLATION OF FRONT FENDER AND RADIATOR ASSEMBLY.

a. **Install Fender and Radiator Assembly.** Attach a chain fall to the fender and radiator assembly. Hoist the assembly into position with a helper at the rear of each fender to assist in guiding it in place. If there were any spacer washers between the radiator support and frame cross member when the assembly was removed (par. 35 g), see that they are installed. Install the shakeproof washers and nuts on the attaching studs, but do not tighten the nuts until the hood is installed. Install the screws with shakeproof lock washers that fasten the fender supports to the brackets. Install the screws and shakeproof lock washers to attach the left and right splash shields to the fender rear supports.

b. **Install Battery Tray (6-volt system only).** Attach the battery tray to the frame with the three bolts. Place a shakeproof lock washer under the head of each bolt and under the attaching nuts, and attach the fuel line with the clip to the center battery tray bolt. Attach the battery tray to fender splash shield ground strap at the splash shield with the bolt assembled with a shakeproof lock washer under the bolt head and under the nut.

c. **Connect Lamp Wiring and Ground Strap.** Attach the lamp wiring cables to the cross member with the clips. Connect the lamp wires to the terminals of the terminal block having the same color wires attached and install the lock washers and nuts. Push the black-out parking lamp wires into the sockets near the terminal blocks. Connect the ground strap to the frame side member at the front of the left fender, with the screw and shakeproof lock washer.

d. **Connect Generator and Regulator Wiring.** Connect the generator to regulator wires to the generator and connect the wiring cable to the generator by the clip. Connect the small green wire of the cable to the regulator terminal marked GEN and the larger red wire to the terminal marked ARM. Then attach the cable to the regulator with the clip and attach the cable to the dash with the clip.

e. **Connect Battery (12-volt system only).** Place the battery cable on the battery positive post and tighten the terminal nut. Close the cover and fasten in place with the cap screws and lock washers.

f. **Install Battery (6-volt system only).** Install the battery in the battery tray and fasten with the hold-down clamps and clamp bolt nuts. Install the battery cables and tighten the terminal bolts securely.

g. **Connect Radiator Hose.** Connect the radiator hose to the water pump opening and the cylinder head water outlet elbow but do not tighten hose clamps.

h. **Install Hood.** Slide the hood center hinge rod into the rear hood support. Install the front support over the end of the hinge rod and with shakeproof lock washers between the shell and tapping plate, install and tighten the screws. Attach the hood to the dash ground strap at the dash with a shakeproof lock washer on each side of the strap.



**ORDNANCE MAINTENANCE—POWER PLANT, CLUTCH, AND ELECTRICAL SYSTEM—¾ AND 1½ TON VEHICLES (DODGE)**

**i. Install Radiator Tie Rods.**

(1) **TRUCKS WITHOUT FAN SHROUD.** Insert the radiator tie rods into the dash brackets and install the inside bracket attaching shakeproof lock washers and nuts, but do not tighten. Attach the front end of the tie rods to the radiator shell with the bolts assembled with a shakeproof lock washer under the bolt heads and under the nuts. Pull the tie rods towards the dash with the adjusting nut inside the dash bracket until the space between the fan blades and radiator core, measured at the lower flange of the radiator top tank, is at least  $\frac{5}{16}$  inch. Then line up the radiator shell so the hood is equally spaced on both sides and tighten the tie rod adjustment with the outside lock nuts at the dash. Finally, tighten the radiator support stud nuts.

(2) **TRUCKS WITH FAN SHROUDS.** Install the radiator tie rods as outlined in paragraph 75 i (1) and adjust the tie rods so that the hood lines up with the radiator core shell equally on both sides. It is not necessary to adjust the tie rods for a specified clearance between the fan blades and radiator core as more clearance is provided at this point on trucks with a fan shroud.

**j. Tighten Hose Connections and Fill Cooling System.** Tighten all the hose connection clamps securely. On the 1½-ton, 6 x 6 models connect the overflow tank pipe. Fill the cooling system with the proper solution, depending on prevailing atmospheric temperature.

**76. TESTS AND ADJUSTMENTS.**

**a. General.** After a new or rebuilt engine has been installed in a truck, make the tests and adjustments listed below to assure satisfactory performance of the truck:

(1) **POLARIZE GENERATOR.** Polarize the generator with the vehicle battery before starting the engine by momentarily connecting a jumper wire between the starter switch battery terminal and the armature terminal (marked ARM) on the generator. This will give the generator its correct polarity in relation to the battery it is to charge and prevent possible burning of regulator points.

(2) **CHECK CLUTCH PEDAL FREE PLAY** (fig. 138). Adjust clutch pedal free play if the clutch pedal pad has less than  $1\frac{1}{8}$ -inch free movement from the released position to the point where the clutch starts to release. To adjust, loosen the yoke lock nut on the clutch operating rod. Push the operating shaft lever forward to take up its free movement and adjust the yoke on the rod so that the pin will slide through the operating shaft lever when the clutch pedal pad is held down  $1\frac{1}{8}$  inch from its released position. Install the pin and cotter pin and tighten the yoke lock nut.

(3) **ADJUST BRAKE PEDAL FREE TRAVEL** (fig. 138). The brake pedal must have some free travel ( $\frac{1}{8}$  inch desired) to allow the master cylinder piston cup to uncover the relief port when the brakes are

**INSTALLATION OF ENGINE**

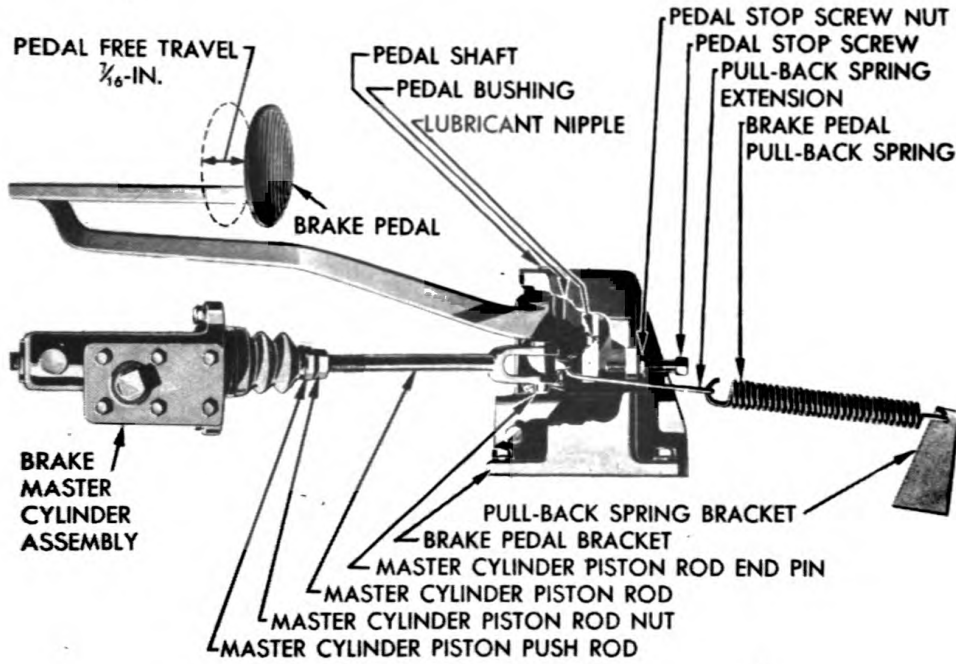

**BRAKE PEDAL**

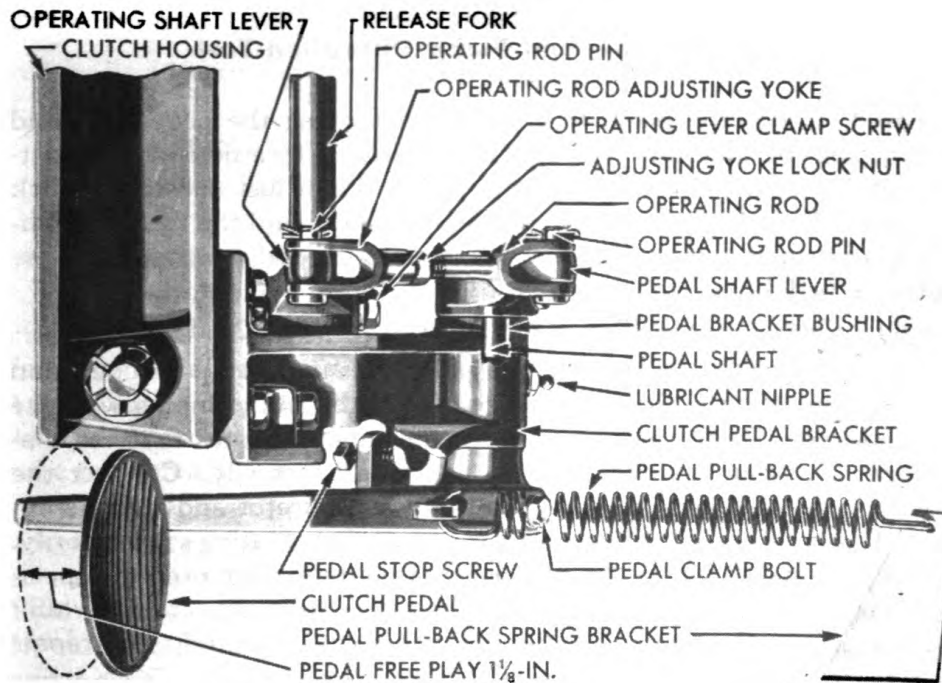

**CLUTCH PEDAL**

RA PD 53376

**Figure 138—Clutch and Brake Pedal Adjustments**

**ORDNANCE MAINTENANCE—POWER PLANT, CLUTCH, AND ELECTRICAL SYSTEM— $\frac{3}{4}$  AND  $1\frac{1}{2}$  TON VEHICLES (DODGE)**

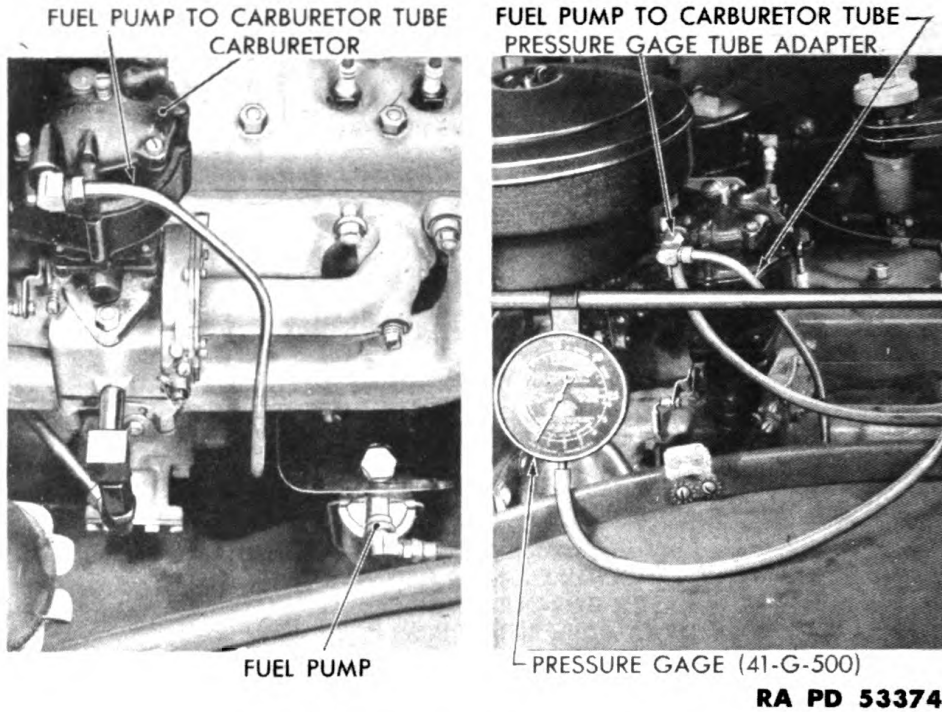

**Figure 139—Fuel Pump Operation Test**

released. Check the pedal free travel by moving the pedal by hand and noting the amount of travel of the pedal before noticeable resistance is felt in the movement of the pedal. To adjust, loosen the lock nut at the front end of the rod between the pedal and the master cylinder and turn the master cylinder piston push rod counterclockwise until the pedal has  $\frac{3}{16}$ -inch travel.

(4) **CHECK VALVE TAPPET ADJUSTMENT** (par. 25 d).

(5) **TEST FUEL PUMP** (fig. 139). Test the fuel pump for operation by disconnecting the fuel tube at the carburetor and pumping with the hand primer. Discharge of fuel from the tube indicates that the diaphragm and pump valves are operating satisfactorily. Connect the pressure gage between the fuel pump and carburetor and run the engine. If pressure is 3 to  $5\frac{1}{2}$  pounds, the pump is operating satisfactorily. If the pressure shown on the gage is less than minimum pressure specified, inspect the fuel tubes and filter between the pump and fuel tank for leakage or obstruction. If the fuel tubes are clear and tight, repair or replace the fuel pump (pars. 60, 61 and 62).

(6) **TEST AND ADJUST CARBURETOR**. Check the choke adjustment for fully opened position when the choke button on the instrument panel is pushed in and for full closing when the button is pulled out. Readjust choke wire position if operation is not correct. Adjust carbu-

## INSTALLATION OF ENGINE

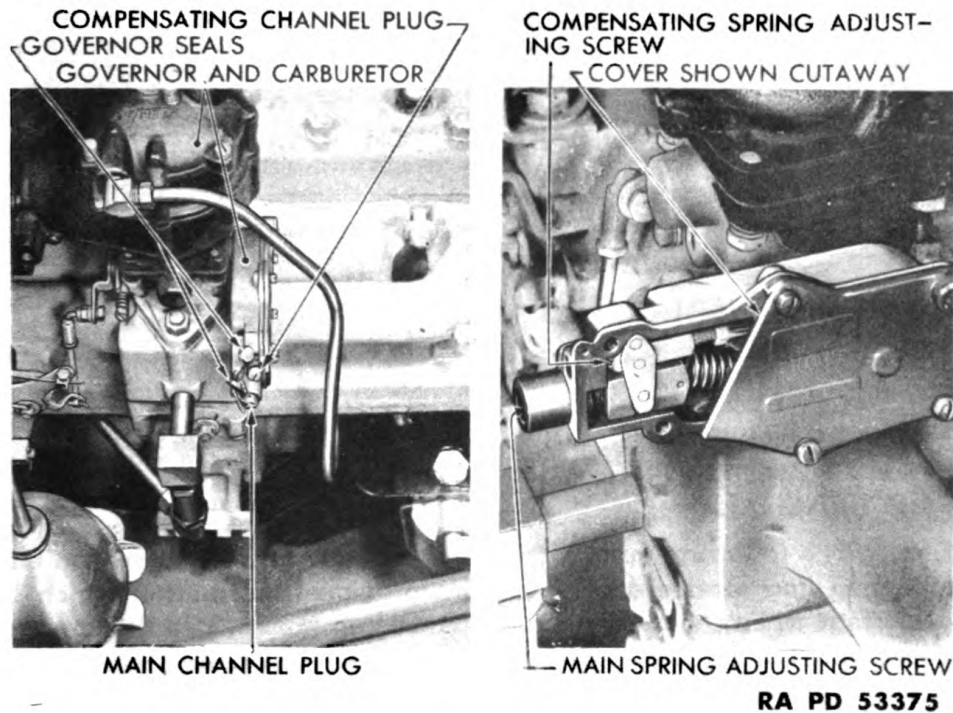

**Figure 140—Governor Adjustments**

retor idle adjustment screw and throttle stop screw, using vacuum gage (par. 25 j).

- (7) ADJUST IGNITION TIMING (par. 25 g and h).
- (8) CHECK SETTING OF MANIFOLD HEAT CONTROL VALVE (par. 25 k).
- (9) CHECK ENGINE PERFORMANCE AT GOVERNED SPEED (fig. 140).

(a) *Speed Adjustment.* New or rebuilt governors are properly calibrated for an engine speed of 3200 revolutions per minute; therefore, the main adjusting screw should not require further adjustment (par. 59 n). However, if adjustment is required, turn the main spring adjusting screw clockwise to increase engine speed and counterclockwise to decrease engine speed.

(b) *Variation in Engine Governed Speed (Surging).* If the governor surges or "hunts," remove plug and insert a narrow screw driver to turn the secondary adjusting screw one half turn counterclockwise. If surge still exists, repeat this procedure until the surge is overcome. If, on the other hand, the governor does not respond quickly enough and is considered "lagging" or "flat," turn the secondary adjusting screw one half turn clockwise. This may be repeated carefully until a surge results; then turn the screw back one half turn counterclockwise. Recheck the governed speed, then replace the plugs, insert the wire through both plugs, and seal.

ORDNANCE MAINTENANCE—POWER PLANT, CLUTCH, AND  
ELECTRICAL SYSTEM— $\frac{3}{4}$  AND  $1\frac{1}{2}$  TON VEHICLES (DODGE)

CHAPTER 2

ENGINE AND CLUTCH (Cont'd)

Section XIII

ENGINE FITS AND TOLERANCES

	Paragraph
General .....	77
Fits and tolerances: .....	78

77. GENERAL.

a. The following tabulation of fits and tolerances is based on engineering and service experience and provides information which is important when rebuilding the engine or component parts. Refer to paragraph 103 for fits and tolerances on electrical units.

78. FITS AND TOLERANCES.

a. Camshaft and Bearings:

	Standard	Maximum Allowable
Bearing journal diameter		
No. 1—front .....	1.998 in.	
No. 2—intermediate .....	1.9665 in.	
No. 3—intermediate .....	1.935 in.	
No. 4—rear .....	1.2475 in.	
Camshaft bearing clearance...	0.002 in.	
Camshaft end play .....	0.002 to 0.006 in.	0.010 in.
Camshaft bearing journal wear .....		0.002 in.
Camshaft bearing diameter		
No. 1—front .....	2.0010 in.	
No. 2—intermediate .....	1.9700 in.	
No. 3—intermediate .....	1.9385 in.	
No. 4—rear .....	1.2515 in.	
Camshaft bearing wear.....		0.002 in.

b. Connecting Rods and Bearings:

Connecting rod bore diameter (crank end) .....	2.1675 to 2.1680 in.	
Connecting rod bearing clearance .....	0.0015 in.	0.0025 in.
Connecting rod twist or bend..		0.0025 in.
Torque wrench pull on bearing bolts .....	45 to 50 ft-lb	

**ENGINE FITS AND TOLERANCES**

<b>c. Crankshaft and Crankshaft Bearings:</b>		<b>Maximum Allowable</b>
	<b>Standard</b>	
Crankshaft bearing clearance . . .	0.002 in.	0.0035 in.
Crankshaft end play . . . . .		0.010 in.
Crankshaft (main) bearing journal diameter . . . . .	2.4995 to 2.5005 in.	
Connecting rod bearing journal diameter . . . . .	2.0615 to 2.0625 in.	
Fillet on journals . . . . .	$\frac{3}{32}$ to $\frac{5}{32}$ in.	
Crankshaft journal (main and connecting rod) wear . . . . .		0.002 in.
Crankshaft journal (main and connecting rod) taper or out of round . . . . .		0.001 in.
Crankshaft run-out . . . . .		0.002 in.
Torque wrench pull on bearing cap screws . . . . .	75 to 80 ft-lb	
<b>d. Cylinder Block and Head:</b>		
Cylinder bore . . . . .	3.250 in.	
Cylinder bore taper . . . . .		0.020 in.
Cylinder bore out of round . . .		0.005 in.
Crankshaft bearing bore . . . . .	2.6565 to 2.6570 in.	
Torque wrench pull on cylinder head stud nuts . . . . .	52½ to 57½ ft-lb	
Torque wrench pull on cylinder head cap screw . . . . .	65 to 70 ft-lb	
<b>e. Pistons, Pins and Rings:</b>		
Piston clearance—top land . . .	0.028 to 0.033 in.	
Total cam of piston . . . . .	0.010 to 0.012 in.	
Taper of piston skirt . . . . .	0.0005 to 0.0015 in.	
Piston skirt clearance, thrust side . . . . .	6 to 8 lb pull on 0.002 x ½-in. feeler	
Piston pin diameter . . . . .	0.8591 to 0.8593 in.	
Piston pin wear . . . . .		0.0005 in.
Piston pin fit in connecting rod . . . . .	Tight thumb push fit at room temperature (70 F)	
Piston pin fit in piston . . . . .	Tight thumb push fit with piston heated to 160 F and pin at 70 F	
Piston ring gap . . . . .	0.007 to 0.015 in.	0.030 in.
Compression ring side clearance in groove . . . . .	0.002 to 0.004 in.	0.008 in.
Oil ring clearance in groove . . .	0.001 to 0.002 in.	0.004 in.

**ORDNANCE MAINTENANCE—POWER PLANT, CLUTCH, AND ELECTRICAL SYSTEM— $\frac{3}{4}$  AND 1 $\frac{1}{2}$  TON VEHICLES (DODGE)**

	Standard	Maximum Allowable
<b>f. Valves, Valve Guides and Springs:</b>		
Valve seat angle . . . . .	45 degrees	
Valve stem clearance in guide		
intake . . . . .	0.001 to 0.003 in.	0.005 in.
exhaust . . . . .	0.003 to 0.005 in.	0.007 in.
Valve stem diameter . . . . .	0.3405 in.	
Valve stem wear . . . . .		0.002 in.
Valve stem guide—ream to		
intake . . . . .	0.342 to 0.343 in.	
exhaust . . . . .	0.344 to 0.345 in.	
Valve spring pressure at length of 1 $\frac{3}{8}$ in. (valve open) . . . .	107 to 115 lb	
Valve spring pressure at length of 1 $\frac{3}{4}$ in. (valve closed) . . . .	40 to 45 lb	
<b>g. Valve Tappets:</b>		
Tappet head diameter . . . . .	1.280 in.	
Tappet stem diameter . . . . .	0.6235 to 0.6240 in.	
Tappet stem clearance in guide	0.0000 to 0.0007 in.	
Tappet stem wear . . . . .		0.002 in.
Tappet clearance (hot)—intake and exhaust . . . . .	0.010 to 0.012 in.	
<b>h. Timing Chain:</b>		
Chain slack at center of chain . . . . .		$\frac{3}{4}$ in.
<b>i. Oil Pump and Relief Valve:</b>		
Drive shaft diameter . . . . .	0.485	
Drive shaft wear . . . . .		0.001 in.
Drive shaft clearance . . . . .	0.0005 in.	0.002 in.
Drive shaft end play . . . . .	0.005 in.	0.010 in.
Drive gear minimum diameter . . . . .	1.161 in.	
Idler gear shaft diameter . . . . .	0.4885 to 0.4890 in.	
Idler gear shaft wear . . . . .		0.001 in.
Idler gear clearance on shaft . . . . .	0.001 in.	0.0025 in.
Idler gear minimum diameter . . . . .	1.163 in.	
Clearance between gears and body . . . . .		0.004 in.
Depth of gear compartment in body . . . . .	1.3075 in.	
Minimum allowable gear width . . . . .	1.3105 in.	
Cover gasket thickness . . . . .	0.012 to 0.13 in.	
Oil pressure relief valve spring pressure at length of $1\frac{5}{16}$ -in. . . . .	8 lb	
<b>j. Water Pump:</b>		
Shaft diameter (front bushing) . . . . .	0.593 to 0.594 in.	
Shaft diameter (rear bushing) . . . . .	0.668 to 0.669 in.	
Pump shaft end play . . . . .	0.003 in.	0.003 in.

**ENGINE FITS AND TOLERANCES**

	<b>Standard</b>	<b>Maximum Allowable</b>
Bushing diameter (front)....	0.595 to 0.596 in.	
Bushing diameter (rear)....	0.670 to 0.671 in.	
Thermostat—starts to open..	157 to 162 F	
fully opened...	183 to 187 F	
<b>k. Carburetor:</b>		
Carburetor float level.....	1 <sup>3</sup> / <sub>16</sub> to 1 <sup>3</sup> / <sub>8</sub> in. (par. 56 m)	
<b>l. Fuel Pump:</b>		
Fuel pump pressure.....	3 to 5 <sup>1</sup> / <sub>2</sub> lb	
<b>m. Clutch:</b>		
Spring pressure when com- pressed to 1 <sup>1</sup> / <sub>16</sub> -in.....	150 to 160 lb	
Clutch pedal free play.....	1 <sup>1</sup> / <sub>8</sub> in.	
Disk facing thickness.....	0.125 in.	
Torque wrench pull on clutch cover cap screws.....	15 to 20 ft-lb	



**ORDNANCE MAINTENANCE—POWER PLANT, CLUTCH, AND ELECTRICAL SYSTEM— $\frac{3}{4}$  AND 1  $\frac{1}{2}$  TON VEHICLES (DODGE)**

**CHAPTER 3  
ELECTRICAL SYSTEM**

**Section I**

**GENERAL DESCRIPTION AND CONSTRUCTION**

	Paragraph
General .....	79
Wiring system .....	80
Starting system .....	81
Generating system .....	82
Ignition system .....	83
Radio interference suppression .....	84
Data and specifications .....	85

**79. GENERAL.**

a. **General.** The trucks covered by this manual are equipped with either 6-volt or 12-volt electrical systems as listed below:

**6-VOLT SYSTEM**

Type of Vehicle	Model
Weapon carrier ( $\frac{3}{4}$ ton, 4 x 4) .....	WC-51
Weapon carrier with winch ( $\frac{3}{4}$ ton, 4 x 4) .....	WC-52
Ambulance ( $\frac{3}{4}$ ton, 4 x 4) .....	WC-54
37 mm gun motor carriage M6 ( $\frac{3}{4}$ ton, 4 x 4) .....	WC-55
Telephone maintenance ( $\frac{3}{4}$ ton, 4 x 4) .....	WC-59
Emergency repair ( $\frac{3}{4}$ ton, 4 x 4) .....	WC-60
Telephone maintenance ( $\frac{3}{4}$ ton, 4 x 4) .....	WC-61
Personnel and cargo (1 $\frac{1}{2}$ ton, 6 x 6) .....	WC-62
Personnel and cargo (1 $\frac{1}{2}$ ton, 6 x 6) .....	WC-63

**12-VOLT SYSTEM**

Caryall ( $\frac{3}{4}$ ton, 4 x 4) .....	WC-53
Command ( $\frac{3}{4}$ ton, 4 x 4) .....	WC-56
Command with winch ( $\frac{3}{4}$ ton, 4 x 4) .....	WC-57
Radio ( $\frac{3}{4}$ ton, 4 x 4) .....	WC-58

b. **Identification of Electrical System Used** (fig. 141). The voltage of the electrical system can readily be determined by the location of the battery. The battery is located under the left side of the engine hood on trucks with a 6-volt electrical system, and on the rear of the right running board of trucks with a 12-volt electrical system.

**GENERAL DESCRIPTION AND CONSTRUCTION**

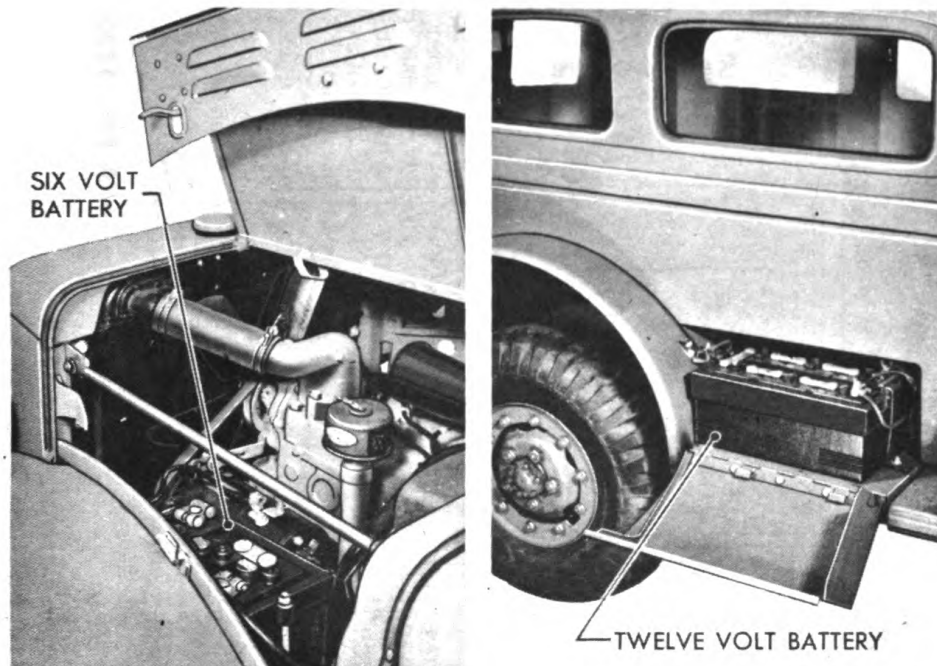

RA PD 53215

**Figure 141—Battery Location**

**80. WIRING SYSTEM.**

a. **Wiring Circuits.** The wiring circuits illustrated in figures 142, 143, and 144 are of the single wire type. A single cable, connected to the positive post of the battery, runs directly to the feed post on the starter switch. When the switch is closed, current flows from the battery through the starter to ground through the battery ground strap. No other wiring is involved in the starter circuit. From the feed post on the starter switch and the generator regulator, single feed wires run through the radio interference filter to the ammeter. From the ammeter, single feed wires which are built into assemblies, run indirectly through switches to all electrically operated units, except the starter. When the switch which controls any unit except the starter is closed, current flows from the battery through the ammeter, through the switch and single wire in the wiring assemblies, then through the unit to ground. The lighting circuits are protected against damage from short circuit by a circuit breaker which opens automatically if any light wire becomes grounded.

b. **Wiring Assemblies.**

(1) **CHASSIS WIRING ASSEMBLY** (fig. 145). Contains a group of single feed wires which run from the main lighting and blackout switch, blackout driving lamp switch, head lamp beam indicator and fuel gage on the instrument panel to the driver's side of the junction block on

ORDNANCE MAINTENANCE—POWER PLANT, CLUTCH, AND ELECTRICAL SYSTEM— $\frac{3}{4}$  AND  $1\frac{1}{2}$  TON VEHICLES (DODGE)

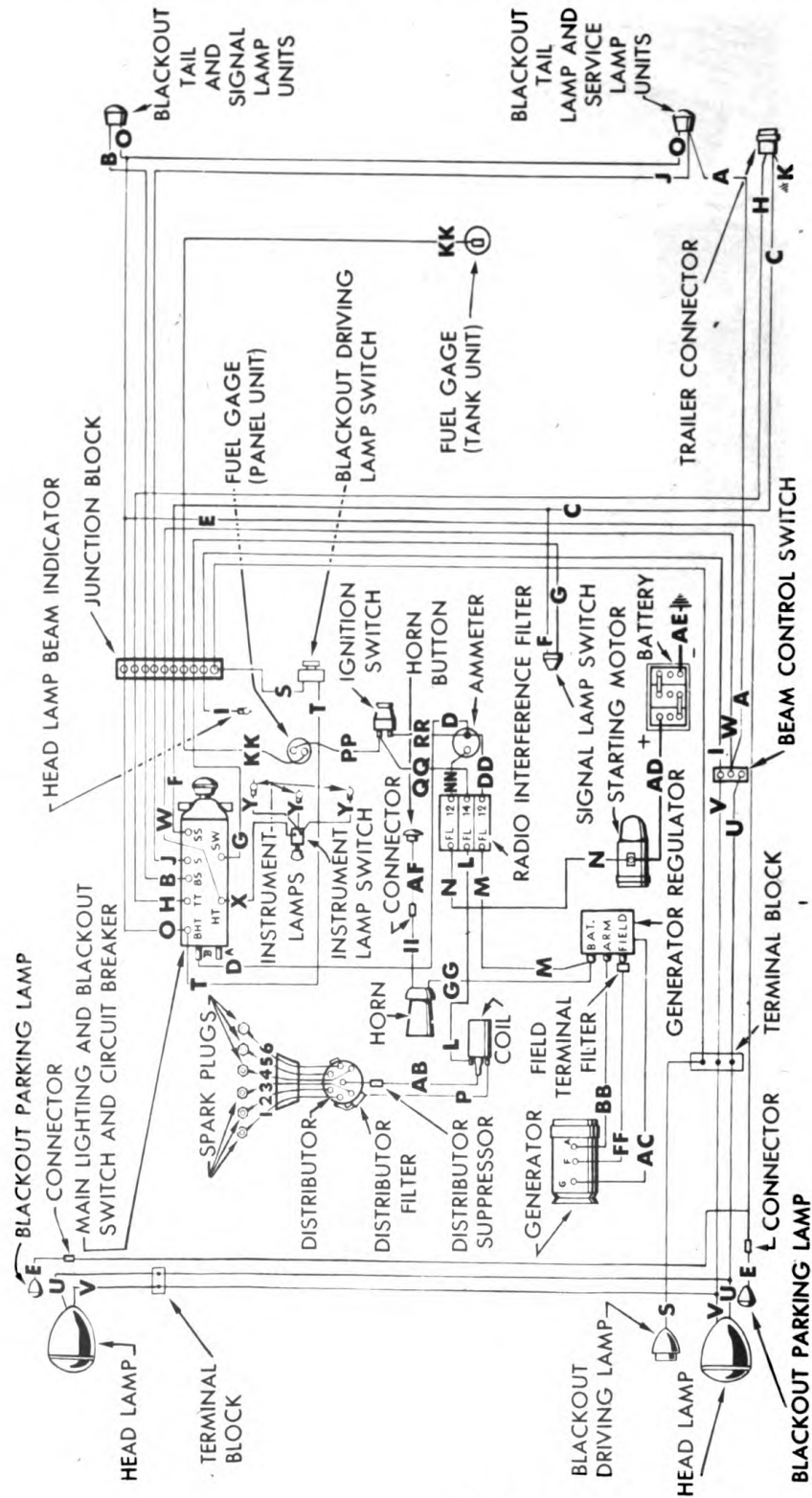

RA PD 53220

Figure 142—Wiring Circuit Diagram (Weapon Carrier, Telephone Maintenance, Emergency Repair, Personnel and Cargo)

GENERAL DESCRIPTION AND CONSTRUCTION

- A**—NO. 14 RED - 2 WHITE TRACERS
- B**—NO. 14 YELLOW - 2 BLACK TRACERS
- C**—NO. 14 BLACK AND GREEN  
2 WHITE TRACERS
- D**—NO. 12 BROWN - 3 WHITE TRACERS
- E**—NO. 16 BLACK - 1 WHITE TRACER
- F**—NO. 14 BLACK AND RED  
2 WHITE TRACERS
- G**—NO. 16 BLACK AND YELLOW  
1 BLACK TRACER
- H**—NO. 14 BLUE - 2 WHITE TRACERS
- I**—NO. 16 BROWN - 1 BLACK TRACER
- J**—NO. 14 RED - 2 BLACK TRACERS
- K**—NO. 14 GREEN - 2 WHITE TRACERS
- L**—NO. 14 BLACK - 2 WHITE TRACERS
- M**—NO. 10 BLACK - 4 WHITE TRACERS
- N**—NO. 10 RED - 4 WHITE TRACERS
- O**—NO. 14 BLACK - 2 WHITE TRACERS
- P**—NO. 14 BLACK - 2 WHITE TRACERS
- Q**—NO. 12 RED - 3 WHITE TRACERS
- R**—NO. 16 RED - 1 WHITE TRACER
- S**—NO. 16 BLACK - 1 WHITE TRACER
- T**—NO. 14 BLACK - 2 WHITE TRACERS
- U**—NO. 14 BLACK - 2 YELLOW TRACERS
- V**—NO. 12 RED - 3 WHITE TRACERS
- W**—NO. 12 YELLOW - 3 BLACK TRACERS
- X**—NO. 16 RED - 1 WHITE TRACER
- Y**—NO. 16 BLACK - 1 WHITE TRACER
- Z**—NO. 14 BLACK - 2 WHITE TRACERS
- AA**—NO. 12 RED - 3 WHITE TRACERS
- BB**—NO. 10 RED - 4 WHITE TRACERS
- CC**—NO. 8 RED - 5 WHITE TRACERS
- DD**—NO. 10 BLACK - 4 WHITE TRACERS
- EE**—NO. 8 BLACK - 5 WHITE TRACERS
- FF**—NO. 16 GREEN - 1 WHITE TRACER
- GG**—NO. 12 RED - 3 WHITE TRACERS
- HH**—NO. 6 BLACK - 6 WHITE TRACERS
- II**—NO. 14 GREEN - 2 WHITE TRACERS
- JJ**—NO. 6 BLACK - 6 WHITE TRACERS
- KK**—NO. 18 BLUE - 0 TRACER
- LL**—NO. 18 BLACK AND YELLOW  
0 TRACER
- MM**—NO. 12 RED - 3 WHITE TRACERS
- NN**—NO. 10 RED - 4 WHITE TRACERS
- OO**—NO. 8 RED - 5 WHITE TRACERS
- PP**—NO. 12 GREEN - 3 WHITE TRACERS
- QQ**—NO. 14 BLACK - 2 WHITE TRACERS
- RR**—NO. 12 BROWN - 3 WHITE TRACERS
- SS**—NO. 8 RED - 5 WHITE TRACERS
- TT**—NO. 12 GREEN - 3 WHITE TRACERS
- UU**—NO. 12 RED - 3 WHITE TRACERS
- VV**—NO. 12 RED - 3 WHITE TRACERS
- WW**—NO. 8 BLACK - 5 WHITE TRACERS
- XX**—NO. 16 RED - 1 WHITE TRACER
- YY**—NO. 16 RED - 1 WHITE TRACER
- ZZ**—NO. 16 RED - 1 WHITE TRACER
- 1 TO 6**—SPARK PLUG CABLES  
(HIGH TENSION CABLE)
- AB**—SECONDARY CABLE  
(HIGH TENSION CABLE)
- AC**—GENERATOR CABLES GROUND  
SHIELD
- AD**—STARTING MOTOR CABLE  
(-) POSITIVE
- AE**—BATTERY GROUND CABLE  
(-) NEGATIVE
- AF**—HORN BUTTON CABLE
- AG**—NO. 14 RED - 2 WHITE TRACERS
- AH**—NO. 18 SILVER - 0 TRACER
- AI**—NO. 12 RED - 3 WHITE TRACERS
- AJ**—NO. 18 BLACK - 0 TRACER

RA PD 53220-B

Legend for Figure 142, Wiring Circuit Diagram (Weapon Carrier,  
Telephone Maintenance, Emergency Repair, Personnel and Cargo)

ORDNANCE MAINTENANCE—POWER PLANT, CLUTCH, AND ELECTRICAL SYSTEM— $\frac{3}{4}$  AND  $1\frac{1}{2}$  TON VEHICLES (DODGE)

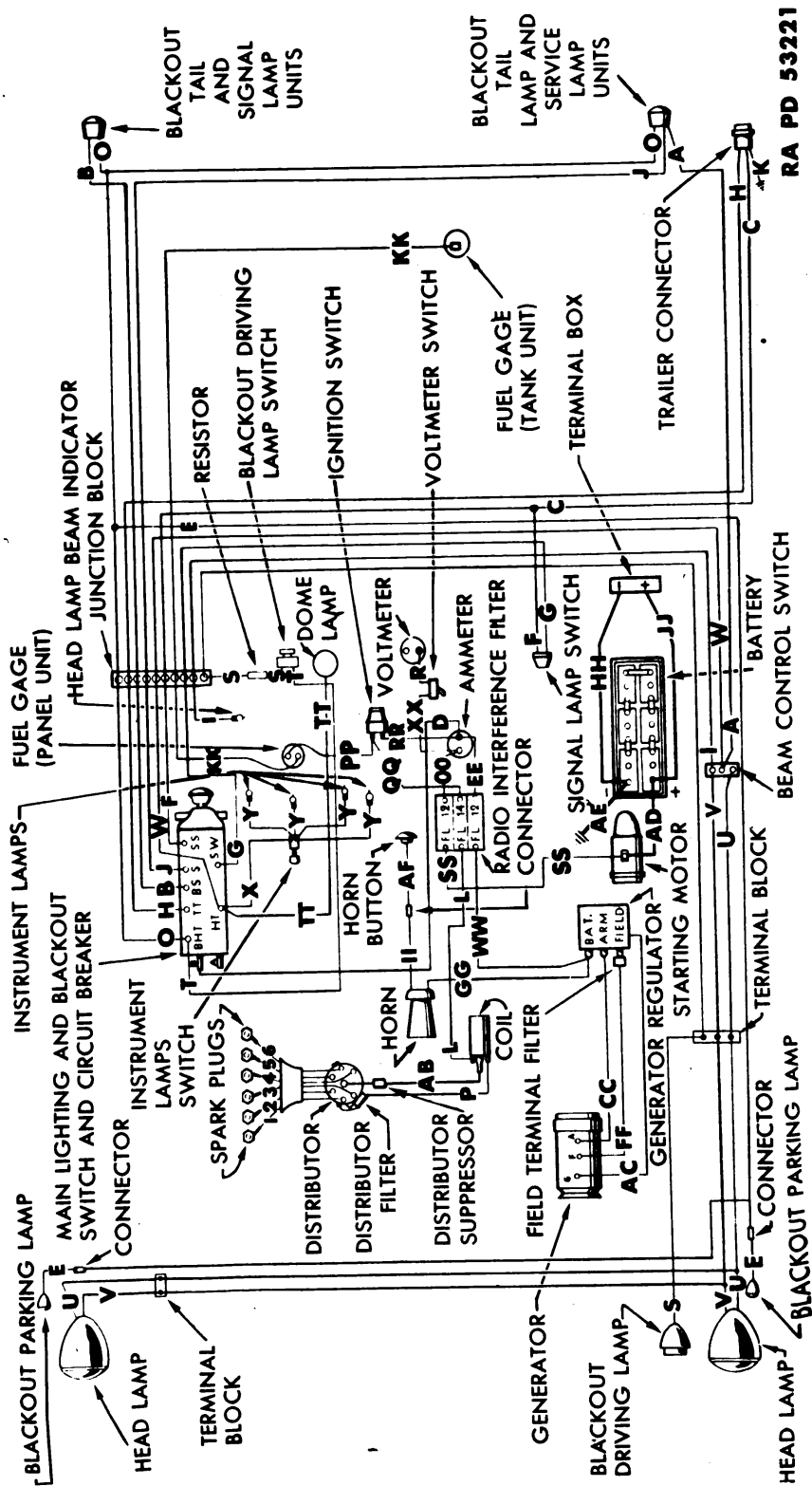

RA PD 53221

Figure 143—Wiring Circuit Diagram (Command and Carryall)

Generated on 2016-06-23 13:50 GMT / http://hdl.handle.net/2027/uc1.b3243992  
Public Domain, Google-digitized / http://www.hathitrust.org/access\_use#pd-google

GENERAL DESCRIPTION AND CONSTRUCTION

- 1 TO 6**— SPARK PLUG CABLES  
 (HIGH TENSION CABLE)  
**AB**— SECONDARY CABLE  
 (HIGH TENSION CABLE)  
**AC**— GENERATOR CABLES GROUND  
 SHIELD  
**AD**— STARTING MOTOR CABLE  
 (+) POSITIVE  
 (-) NEGATIVE  
**AE**— BATTERY GROUND CABLE  
 (-) NEGATIVE  
**AF**— HORN BUTTON CABLE  
**AG**— NO. 14 RED - 2 WHITE TRACERS  
**AH**— NO. 18 SILVER - 0 TRACER  
**AI**— NO. 12 RED - 3 WHITE TRACERS  
**AJ**— NO. 18 BLACK - 0 TRACER
- AA**— NO. 12 RED - 3 WHITE TRACERS  
**BB**— NO. 10 RED - 4 WHITE TRACERS  
**CC**— NO. 8 RED - 5 WHITE TRACERS  
**DD**— NO. 10 BLACK - 4 WHITE TRACERS  
**EE**— NO. 8 BLACK - 5 WHITE TRACERS  
**FF**— NO. 16 GREEN - 1 WHITE TRACER  
**GG**— NO. 12 RED - 3 WHITE TRACERS  
**HH**— NO. 6 BLACK - 6 WHITE TRACERS  
**IJ**— NO. 6 GREEN - 2 WHITE TRACERS  
**JJ**— NO. 6 BLACK - 6 WHITE TRACERS  
**KK**— NO. 18 BLUE - 0 TRACER  
**LL**— NO. 18 BLACK AND YELLOW  
 0 TRACER  
**MM**— NO. 12 RED - 3 WHITE TRACERS  
**NN**— NO. 10 RED - 4 WHITE TRACERS  
**OO**— NO. 8 RED - 5 WHITE TRACERS  
**PP**— NO. 12 GREEN - 3 WHITE TRACERS  
**QQ**— NO. 14 BLACK - 2 WHITE TRACERS  
**RR**— NO. 12 BROWN - 3 WHITE TRACERS  
**SS**— NO. 8 RED - 5 WHITE TRACERS  
**TT**— NO. 12 GREEN - 3 WHITE TRACERS  
**UU**— NO. 12 RED - 3 WHITE TRACERS  
**VV**— NO. 12 RED - 3 WHITE TRACERS  
**WW**— NO. 8 BLACK - 5 WHITE TRACERS  
**XX**— NO. 16 RED - 1 WHITE TRACER  
**YY**— NO. 16 RED - 1 WHITE TRACER  
**ZZ**— NO. 16 RED - 1 WHITE TRACER
- A**— NO. 14 RED - 2 WHITE TRACERS  
**B**— NO. 14 YELLOW - 2 BLACK TRACERS  
**C**— NO. 14 BLACK AND GREEN  
 2 WHITE TRACERS  
**D**— NO. 12 BROWN - 3 WHITE TRACERS  
**E**— NO. 16 BLACK - 1 WHITE TRACER  
**F**— NO. 14 BLACK AND RED  
 2 WHITE TRACERS  
**G**— NO. 16 BLACK AND YELLOW  
 1 BLACK TRACER  
**H**— NO. 14 BLUE - 2 WHITE TRACERS  
**I**— NO. 16 BROWN - 1 BLACK TRACER  
**J**— NO. 14 RED - 2 BLACK TRACERS  
**K**— NO. 14 GREEN - 2 WHITE TRACERS  
**L**— NO. 14 BLACK - 2 WHITE TRACERS  
**M**— NO. 10 BLACK - 4 WHITE TRACERS  
**N**— NO. 10 RED - 4 WHITE TRACERS  
**O**— NO. 14 BLACK - 2 WHITE TRACERS  
**P**— NO. 14 BLACK - 2 WHITE TRACERS  
**Q**— NO. 12 RED - 3 WHITE TRACERS  
**R**— NO. 16 RED - 1 WHITE TRACER  
**S**— NO. 16 BLACK - 1 WHITE TRACER  
**T**— NO. 14 BLACK - 2 WHITE TRACERS  
**U**— NO. 14 BLACK - 2 YELLOW TRACERS  
**V**— NO. 12 RED - 3 WHITE TRACERS  
**W**— NO. 12 YELLOW - 3 BLACK TRACERS  
**X**— NO. 16 RED - 1 WHITE TRACER  
**Y**— NO. 16 BLACK - 1 WHITE TRACER  
**Z**— NO. 14 BLACK - 2 WHITE TRACERS

RA PD 53221-B

Legend for Figure 143, Wiring Circuit Diagram (Command and Carryall)

ORDNANCE MAINTENANCE—POWER PLANT, CLUTCH, AND ELECTRICAL SYSTEM— $\frac{3}{4}$  AND  $1\frac{1}{2}$  TON VEHICLES (DODGE)

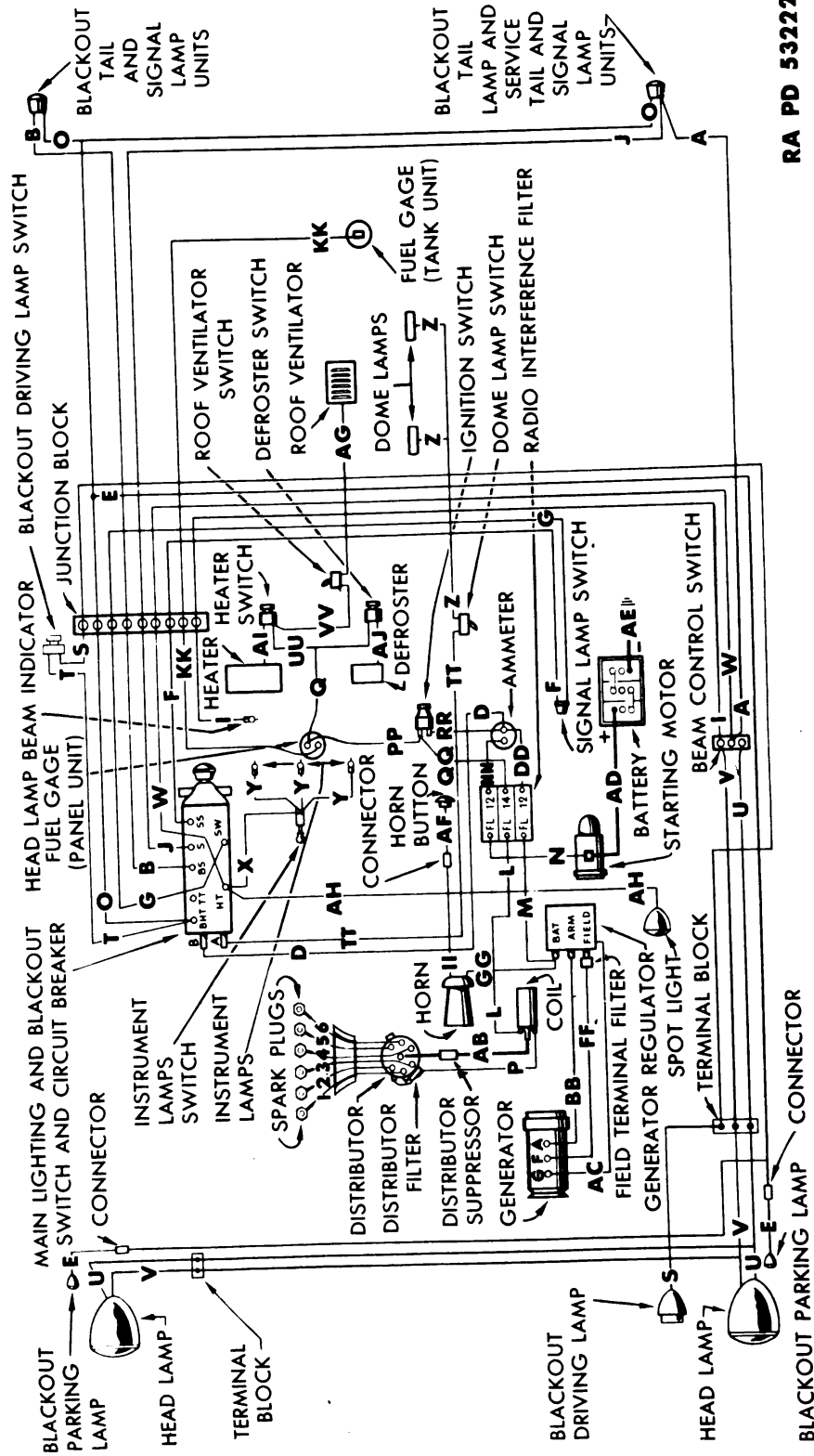

RA PD 53222

Figure 144—Wiring Circuit Diagram (Ambulance)

GENERAL DESCRIPTION AND CONSTRUCTION

- A**—NO. 14 RED - 2 WHITE TRACERS
- B**—NO. 14 YELLOW - 2 BLACK TRACERS
- C**—NO. 14 BLACK AND GREEN  
2 WHITE TRACERS
- D**—NO. 12 BROWN - 3 WHITE TRACERS
- E**—NO. 16 BLACK - 1 WHITE TRACER
- F**—NO. 14 BLACK AND RED  
2 WHITE TRACERS
- G**—NO. 16 BLACK AND YELLOW  
1 BLACK TRACER
- H**—NO. 14 BLUE - 2 WHITE TRACERS
- I**—NO. 16 BROWN - 1 BLACK TRACER
- J**—NO. 14 RED - 2 BLACK TRACERS
- K**—NO. 14 GREEN - 2 WHITE TRACERS
- L**—NO. 14 BLACK - 2 WHITE TRACERS
- M**—NO. 10 BLACK - 4 WHITE TRACERS
- N**—NO. 10 RED - 4 WHITE TRACERS
- O**—NO. 14 BLACK - 2 WHITE TRACERS
- P**—NO. 14 CLACK - 2 WHITE TRACERS
- Q**—NO. 12 RED - 3 WHITE TRACERS
- R**—NO. 16 RED - 1 WHITE TRACER
- S**—NO. 16 BLACK - 1 WHITE TRACER
- T**—NO. 14 BLACK - 2 WHITE TRACERS
- U**—NO. 14 BLACK - 2 YELLOW TRACERS
- V**—NO. 12 RED - 3 WHITE TRACERS
- W**—NO. 12 YELLOW - 3 BLACK TRACERS
- X**—NO. 16 RED - 1 WHITE TRACER
- Y**—NO. 16 BLACK - 1 WHITE TRACER
- Z**—NO. 14 BLACK - 2 WHITE TRACERS
- AA**—NO. 12 RED - 3 WHITE TRACERS
- BB**—NO. 10 RED - 4 WHITE TRACERS
- CC**—NO. 8 RED - 5 WHITE TRACERS
- DD**—NO. 10 BLACK - 4 WHITE TRACERS
- EE**—NO. 8 BLACK - 5 WHITE TRACERS
- FF**—NO. 16 GREEN - 1 WHITE TRACER
- GG**—NO. 12 RED - 3 WHITE TRACERS
- HH**—NO. 6 BLACK - 6 WHITE TRACERS
- II**—NO. 14 GREEN - 2 WHITE TRACERS
- JJ**—NO. 6 BLACK - 6 WHITE TRACERS
- KK**—NO. 18 BLUE - 0 TRACER
- LL**—NO. 18 BLACK AND YELLOW  
0 TRACER
- MM**—NO. 12 RED - 3 WHITE TRACERS
- NN**—NO. 10 RED - 4 WHITE TRACERS
- OO**—NO. 8 RED - 5 WHITE TRACERS
- PP**—NO. 12 GREEN - 3 WHITE TRACERS
- QQ**—NO. 14 BLACK - 2 WHITE TRACERS
- RR**—NO. 12 BROWN - 3 WHITE TRACERS
- SS**—NO. 8 RED - 5 WHITE TRACERS
- TT**—NO. 12 GREEN - 3 WHITE TRACERS
- UU**—NO. 12 RED - 3 WHITE TRACERS
- VV**—NO. 12 RED - 3 WHITE TRACERS
- WW**—NO. 8 BLACK - 5 WHITE TRACERS
- XX**—NO. 16 RED - 1 WHITE TRACER
- YY**—NO. 16 RED - 1 WHITE TRACER
- ZZ**—NO. 16 RED - 1 WHITE TRACER
- 1 TO 6**—SPARK PLUG CABLES  
(HIGH TENSION CABLE)
- AB**—SECONDARY CABLE  
(HIGH TENSION CABLE)
- AC**—GENERATOR CABLES GROUND  
SHIELD
- AD**—STARTING MOTOR CABLE  
(+) POSITIVE
- AE**—BATTERY GROUND CABLE  
(-) NEGATIVE
- AF**—HORN BUTTON CABLE
- AG**—NO. 14 RED - 2 WHITE TRACERS
- AH**—NO. 18 SILVER - 0 TRACER
- AI**—NO. 12 RED - 3 WHITE TRACERS
- AJ**—NO. 18 BLACK - 0 TRACER

RA PD 53222-B

Legend for Figure 144, Wiring Circuit Diagram (Ambulance)



**ORDNANCE MAINTENANCE—POWER PLANT, CLUTCH, AND ELECTRICAL SYSTEM— $\frac{3}{4}$  AND  $1\frac{1}{2}$  TON VEHICLES (DODGE)**

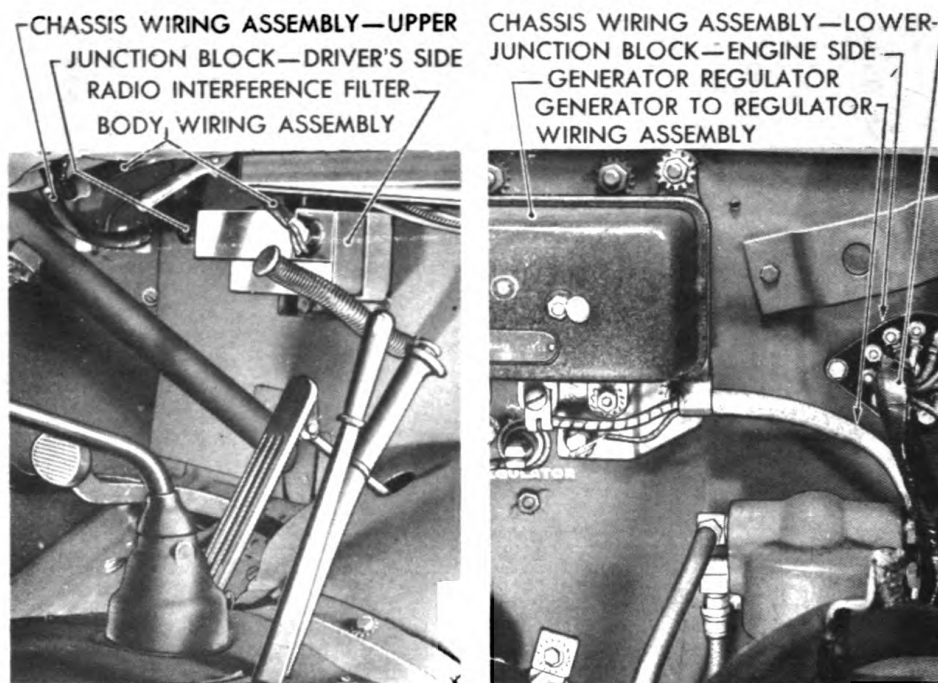

RA PD 53290

Figure 145—Wiring Assemblies

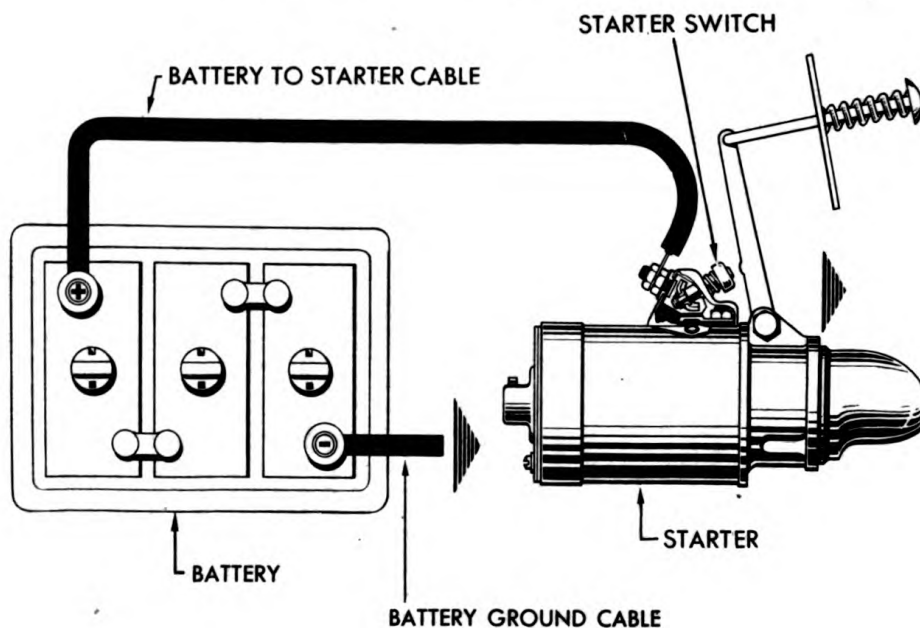

RA PD 53217

Figure 146—Starting Circuit Diagram

### GENERAL DESCRIPTION AND CONSTRUCTION

the dash. The road lamps or fuel gage only can be affected by this wiring assembly.

(2) **LOWER CHASSIS WIRING ASSEMBLY** (fig. 145). Contains a group of single feed wires which run from the engine side of the junction block on the dash to all road lamps, head lamp beam control switch and fuel gage tank unit. The road lamps or fuel gage only can be affected by this wiring assembly, as it is an extension of the upper wiring assembly.

(3) **BODY WIRING ASSEMBLY** (fig. 145). Contains two feed wires which run from the radio interference filter to the ammeter; also feed wires which run from the ammeter to the main lighting and blackout switch, instrument lamp switch, ignition switch, fuel gage and a wire which runs from the ignition switch to the radio interference filter. Any electrical unit on the vehicle, except the starter, can be affected by this wiring assembly.

(4) **GENERATOR TO REGULATOR WIRING ASSEMBLY** (fig. 145). Contains two wires which run from the generator to the generator regulator. Only the charging rate of the generator can be affected by this assembly.

### 81. STARTING SYSTEM.

a. **Starting Circuit** (fig. 146). The starting system consists of the battery, the battery and ground cables, the starter switch and the starter. The starting system operates entirely independently of all other electrical equipment and wiring of the vehicle.

b. **Identification of Starter.** Two different types of starters are used, depending on the voltage of the electrical system. The starter used on trucks with 12-volt electrical systems has a green plate on which model MAY-4132 appears; while 6-volt system starters are equipped with a red plate showing model MAW-4029.

### 82. GENERATING SYSTEM.

a. **Generator** (fig. 147). Vehicles covered by this manual are equipped with either a 6-volt or 12-volt generator, depending on the voltage of the electrical system. The generating circuit for both 6- and 12-volt vehicles is illustrated in figure 147.

b. **Generator Regulator.** The output of the generator is controlled in relation to the voltage requirements by the generator regulator (mounted on the engine side of the dash) keeping the battery fully charged and maintaining proper voltage under normal driving conditions. This means that the pointer of the ammeter mounted on the instrument panel of the vehicle may gradually approach zero, as the battery becomes fully charged. This indicates that the generator output has dropped to a small sustaining charge, necessary for a fully

**ORDNANCE MAINTENANCE—POWER PLANT, CLUTCH, AND ELECTRICAL SYSTEM— $\frac{3}{4}$  AND  $1\frac{1}{2}$  TON VEHICLES (DODGE)**

PARTS SHOWN DOTTED COMPOSE THE STARTING CIRCUIT WHICH MUST FUNCTION BEFORE THE GENERATING CIRCUIT CAN OPERATE.

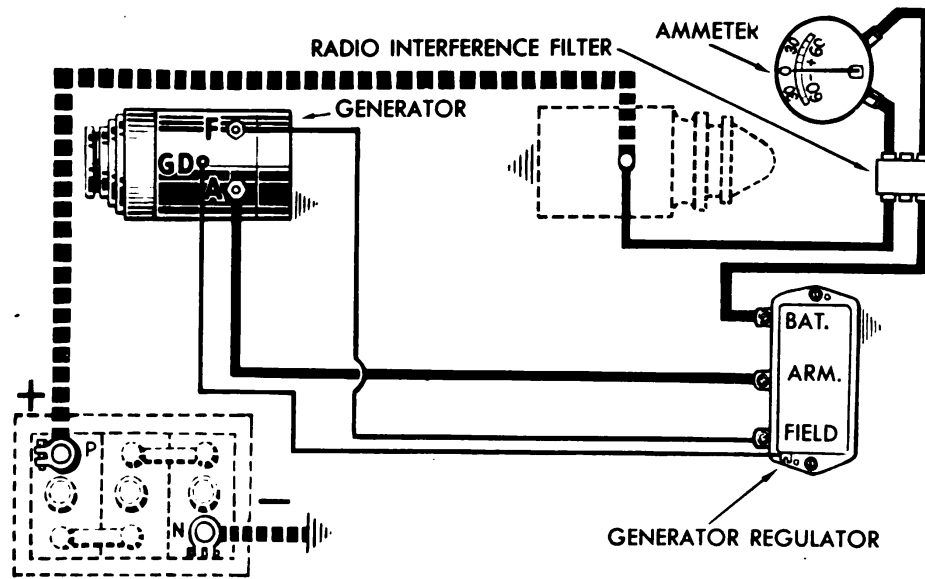

RA PD 53218

**Figure 147—Generating Circuit Diagram**

charged battery, to prevent overcharge. The regulator contains three units, each performing a distinct and independent function as follows:

(1) **CIRCUIT BREAKER.** An automatic switch between the generator and the battery. This unit of the regulator closes the charging circuit when the generator is charging and opens the circuit when it is not charging, thus preventing the battery discharging back through the generator.

(2) **CURRENT REGULATOR.** Limits the maximum current output in amperes. When the generator output reaches a predetermined maximum the regulator points are opened, cutting in a resistance in the generator field circuit and reducing the output. Immediately upon the dropping of the output, the points close, cutting out the resistance, and the output rises. These cycles occur at a sufficiently high frequency to hold the output constant at a predetermined maximum.

(3) **VOLTAGE REGULATOR.** Holds the voltage of the electrical system constant within close limits. When the voltage rises to a predetermined maximum, the voltage regulator contact points vibrate, cutting in and out a resistance in the generator field circuit.

c. **Identification of Generator and Regulator.** Generators, generator pulleys, generator fan and regulators used on trucks covered by this manual, may be identified by symbols appearing on the assemblies or parts as follows:

**GENERAL DESCRIPTION AND CONSTRUCTION**

Unit	Symbol (6-volt systems)	Symbol (12-volt systems)	Location of symbol
Generator assembly	GEG-5002-A	GDJ-4808-A	On name plate*
Generator pulley	SP-502	SP-270	Stamped on pulley
Generator fan	None used	SP-443	Stamped on fan
Generator regulator	VRY-4203-A	VRH-4104-A1	On name plate*

\*A red name plate is used on the 6-volt generator and regulator and a green plate is used on the 12-volt generator and regulator.

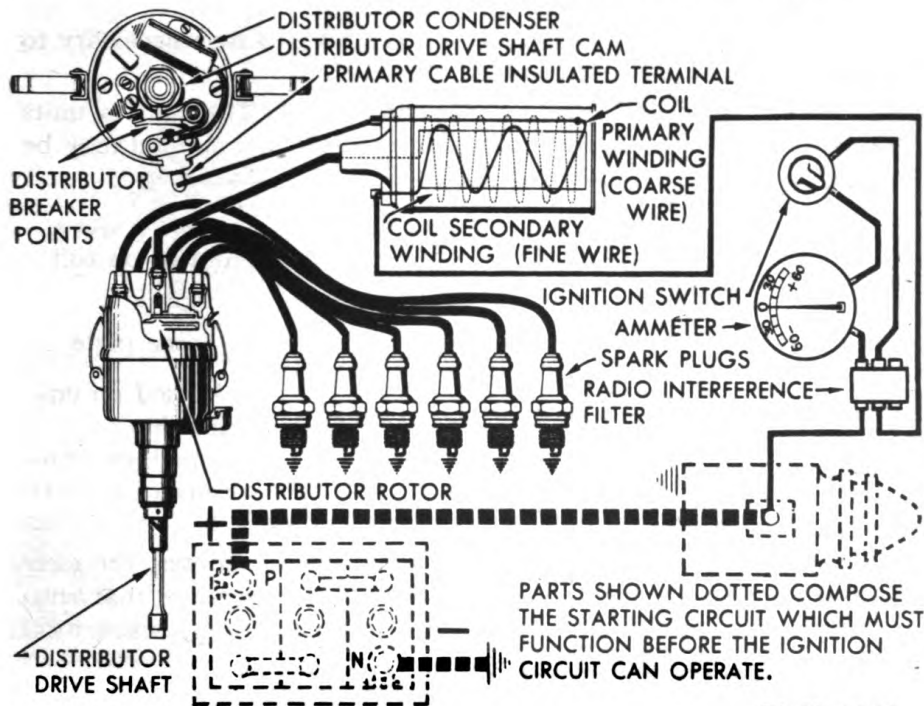

RA PD 53219

**Figure 148—Ignition Circuit Diagram**

**83. IGNITION SYSTEM.**

a. **Function** (fig. 148). The ignition system contains the battery, distributor, ignition coil, spark plugs and necessary high and low tension wires, to complete the circuit for these units of the ignition system. The complete ignition circuit consists of two separate circuits—the primary circuit and the secondary circuit. Briefly, these circuits function as follows:

(1) With the ignition switch turned on and the distributor breaker points closed, current flows through the primary winding of the ignition coil and builds up a strong magnetic field in the coil. When the breaker points open, the primary circuit is broken, collapsing the magnetic field

**ORDNANCE MAINTENANCE—POWER PLANT, CLUTCH, AND ELECTRICAL SYSTEM—<sup>3</sup>/<sub>4</sub> AND 1<sup>1</sup>/<sub>2</sub> TON VEHICLES (DODGE)**

and inducing a high voltage in the secondary winding of the coil. This induced high voltage is distributed to the spark plugs by the distributor cap and rotor and the high tension wiring between the distributor cap and spark plugs.

(2) To prevent arcing across the distributor breaker points as they open, a condenser is connected in parallel with the points. The purpose of the condenser is to provide a place for the primary current to flow until the points have separated far enough to prevent an arc across the points. The condenser brings the flow of current through the primary circuit to a quick stop. The quick stop of the current flow collapses the magnetic field and induces the high voltage necessary to produce a spark at the spark plug.

**b. Identification of Ignition System Units.** The various units of the ignition system used on trucks covered by this manual may be identified by symbols appearing on the units as follows:

Unit	Symbol (6-volt systems)	Symbol (12-volt systems)	Location of symbol
Ignition coil	IG-4070-P	CF-4013-A	Stamped on coil bracket
Distributor	{IGC-4707-1} {IGC-4703-1}	{IGC-4707-1} {IGC-4703-1}	On name plate
Distributor cap	IGC-1107S	IGC-1107S	Embossed on under side
Condenser	IGW-3139	IGW-3139	Stamped on condenser

**84. RADIO INTERFERENCE SUPPRESSION.**

**a. General.** When the engine of a vehicle is running, the electrical system of that vehicle is a source of radio interference; it is actually broadcasting radio waves in various frequencies and wave form that interfere with the radio receiving equipment in that vehicle as well as in nearby radio equipped vehicles or signal apparatus. In order to reduce such interference, the trucks covered by this manual are equipped with a suppression system consisting of various types of suppression units incorporated throughout the vehicle. These units are described in the following paragraphs:

(1) **RESISTOR-SUPPRESSORS** (fig. 149). The resistor-suppressor is a high resistant element designed to suppress ignition noise. It is mounted securely in an insulated housing having accessible electrical connections in both ends. Seven resistor-suppressors are installed in the ignition circuit. Six are installed on the spark plug wires (one at each plug) and one is installed in the high tension wire (center terminal) two inches from the distributor cap.

(2) **FILTERS AND CONDENSERS** (fig. 149). The purpose of the filter or condenser is to decrease interferences set up by the ignition and electrical systems. Three filters are mounted in a metal housing, located

**GENERAL DESCRIPTION AND CONSTRUCTION**

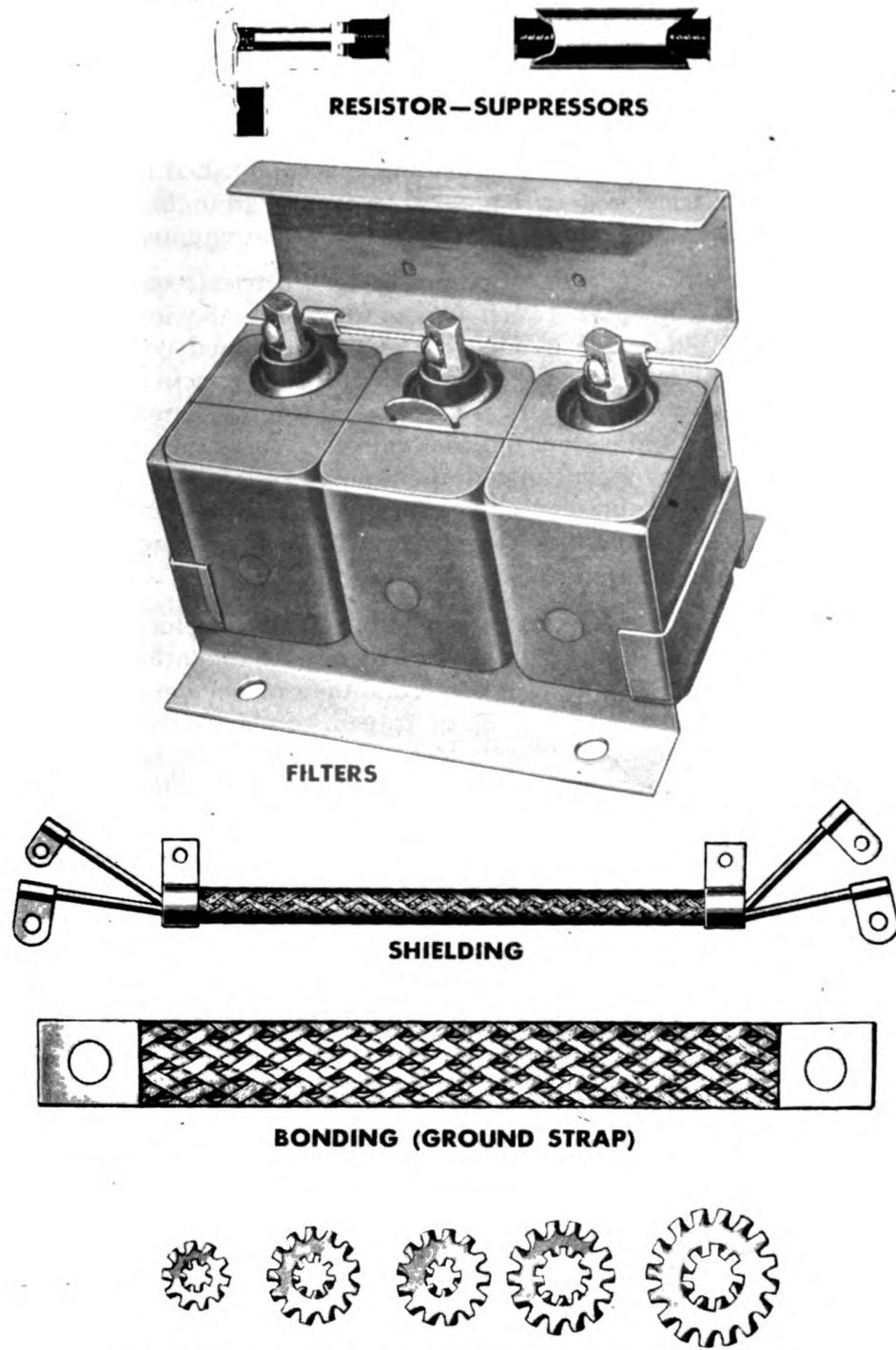

RA PD 53296

**Figure 149—Radio Interference Suppression**

**ORDNANCE MAINTENANCE—POWER PLANT, CLUTCH, AND ELECTRICAL SYSTEM—¾ AND 1½ TON VEHICLES (DODGE)**

on the left side of the dash above the clutch and brake pedals. The housing is mounted with cadmium plated bolts and nuts and internal-external shakeproof lock washers in direct contact with the metal of the dash.

(3) **SHIELDING** (fig. 149). Shielding is accomplished by encasing wires of the electrical system in a metal braid, and grounding the braid at both ends to keep the wires and braid from radiating interference.

(4) **BONDING** (fig. 149). Bonding is an electrical contact of extremely low resistance, between two or more metal parts. Various points of the vehicle are bonded by means of tinned copper braid ground straps. These straps are fastened to their respective points by cadmium-plated bolts and nuts or screws and internal-external shakeproof lock washers. Fenders, shields and other sheet metal parts are fastened together by means of cadmium-plated fastening bolts and internal-external shakeproof lock washers; these lock washers when drawn up tight bite into the metal surfaces which they contact and form a good ground.

(5) **SERVICING AND REPLACING BONDED PARTS.** Before replacing bonded parts, clean off all paint and dirt from the mounting surfaces, tops and bottoms of both ends of bonds and their placement position on the vehicle. Replace any broken or frayed bonds. Exercise special care when replacing bonded parts to be sure they are installed in exactly the same manner as they were before removal. Install shakeproof lock washers in their original sequence.

**85. DATA AND SPECIFICATIONS.**

a. Battery:	6-volt	12-volt
Make and model . . . . .	Willard SW-2-116	Willard WH-25-6
Number of cells . . . . .	3	6
Number of plates . . . . .	15	25
Voltage . . . . .	6 to 6.5	12 to 13.5
Capacity in ampere hours . . . .	116—20-hr rate	204—20-hr rate
Terminal grounded . . . . .	Negative	Negative
Electrolyte (above plates) . . .	Automatic Safety Fill	¾-in.
b. Starter:		
Make and model . . . . .	Auto-Lite MAW-4029	Auto-Lite MAY-4132
Drive . . . . .	Positive, manual shift	Positive, manual shift

**GENERAL DESCRIPTION AND CONSTRUCTION**

	6-volt	12-volt
Number teeth in flywheel ring gear.....	146	146
Number teeth in starter.....	9	9
Starter switch:		
Make and model.....	Auto-Lite SW-2813	Auto-Lite SW-2813
Location .....	On starter	On starter
<b>c. Generator:</b>		
Make and model.....	Auto-Lite GEG-5002-A	Auto-Lite GDJ-4808-A
Drive .....	Fan belt	Fan belt
Pulley diameter.....	4 in.	5 in.
Charging control.....	Voltage control	Voltage control
Voltage .....	6	12
<b>d. Ammeter:</b>		
Make and number.....	Auto-Lite K-10018	Auto-Lite K-10018
<b>e. Regulator Assembly:</b>		
Make and model.....	Auto-Lite VRY-4203-A	Auto-Lite VRH-4104-A1
Location .....	Engine side of dash	Engine side of dash
<b>f. Ignition system:</b>		
Coil—make and model.....	Auto-Lite IG-4070-P	Auto-Lite CF-4013-A
Distributor		
Make and model.....	Auto-Lite IGC-4707-1 and IGC-4703-1	Auto-Lite IGC-4707-1 and IGC-4703-1
Type .....	Automatic advance	Automatic advance
Firing order .....	1-5-3-6-2-4	1-5-3-6-2-4
Distributor cap		
Make and model.....	Auto-Lite IGC-1107S	Auto-Lite IGC-1107S
Condenser		
Make and model.....	Auto-Lite IGW-3139	Auto-Lite IGW-3139
Spark plugs		
Make and model.....	Auto-Lite A7 and A5	Auto-Lite A7 and A5
Size .....	14 mm	14 mm



**ORDNANCE MAINTENANCE—POWER PLANT, CLUTCH, AND ELECTRICAL SYSTEM— $\frac{3}{4}$  AND 1 $\frac{1}{2}$  TON VEHICLES (DODGE)**

**g. Sealed beam units and bulbs:**

Location	6-volt		12-volt	
	C.P. (Watts)	Mazda No.	C.P. (Watts)	Mazda No.
Head lamp . . . . .	35-45	CB8494*	35-45	CB11089
Blackout parking lamp . . .	3	63	3	67
Blackout driving lamp . . .	10	CB11267*	10	CB11267*
Head lamp beam indicator	1	51	1	53
Instrument lamps . . . . .	1	51	1	53
Tail and signal lamps . . .	21-3	CB9218*	21-3	CB9442*
Blackout tail lamp . . . . .	3	CB9225*	3	CB9445*
Blackout signal lamp . . .	3	CB9234*	3	CB9448*
Spotlight (ambulance) . . .	32	1323		
Dome lamp (ambulance and carryall) . . . . .	15	87	15	93

\*Corcoran-Brown

**h. Miscellaneous Electrical Equipment:**

Horn	6-volt	12-volt
	Make and model . . . . .	Delco K15-2002 or Auto-Lite HA-4032A
Type . . . . .	Vibrator	Vibrator
Fuel Gage		
Panel unit . . . . .	Auto-Lite NG10020-D	Auto-Lite NG10020-D
Tank unit . . . . .	Auto-Lite NG9967-T	Auto-Lite NG9967-T
Type . . . . .	Magnetic	Magnetic

## CHAPTER 3

## ELECTRICAL SYSTEM (Cont'd)

## Section II

## ELECTRICAL TROUBLE SHOOTING

	Paragraph
Starting and generating system trouble shooting . . . . .	86
Ignition system trouble shooting . . . . .	87

### 86. STARTING AND GENERATING SYSTEM TROUBLE SHOOTING.

#### a. General Information.

(1) **LOW VOLTAGE TESTS** (fig. 150). The probable cause of trouble in the starting and generating systems can be diagnosed with the aid of the low voltage circuit tester (17-T-5575). This tester contains a voltmeter and ammeter with control switches for making the various tests described in this paragraph. The same tester may also be used to test the primary circuit of the ignition system (par. 87) and voltage output at the head lamps as described in TM 9-808 and TM 9-810.

(2) **TESTER CONNECTIONS** (fig. 151). A diagram of the connections for the low voltage circuit tester is shown on a plate attached to the cover of the tester. Make all connections shown except those for the field rheostat. Use this hookup only when making test described in paragraph 86 j.

(3) **ENGINE TEMPERATURE**. In order to make accurate tests of generator output and battery voltage, run the engine long enough to establish normal operating temperature (about 145 F) especially in cold climates, because all test specifications given are based on normal engine operating temperatures.

**b. Connect Tester** (figs. 150, 151 and 152). Place knob of voltage selector switch at six or twelve volts, depending on the electrical system voltage of the vehicle being checked. The voltage can be determined by examining the name plate attached to the generator or regulator cover. The plate for 6-volt systems is red; for 12-volt systems, green. Turn utility switch to "Regulator Tests" position. Turn meter polarity switch to suit ground polarity of vehicle being checked. (All vehicles covered by this manual are equipped with negative ground electrical systems.) Place regulator test selector switch in number 1 position. Connect the ammeter test leads in series with regulator B terminal (fig. 152, 1). To do this, disconnect the wires from regulator terminal marked BAT and connect the shunt clip to that terminal. Move the horn feed wire to one side. Then connect the wire just re-

TM 9-1808A  
86

**ORDNANCE MAINTENANCE—POWER PLANT, CLUTCH, AND ELECTRICAL SYSTEM— $\frac{3}{4}$  AND  $1\frac{1}{2}$  TON VEHICLES (DODGE)**

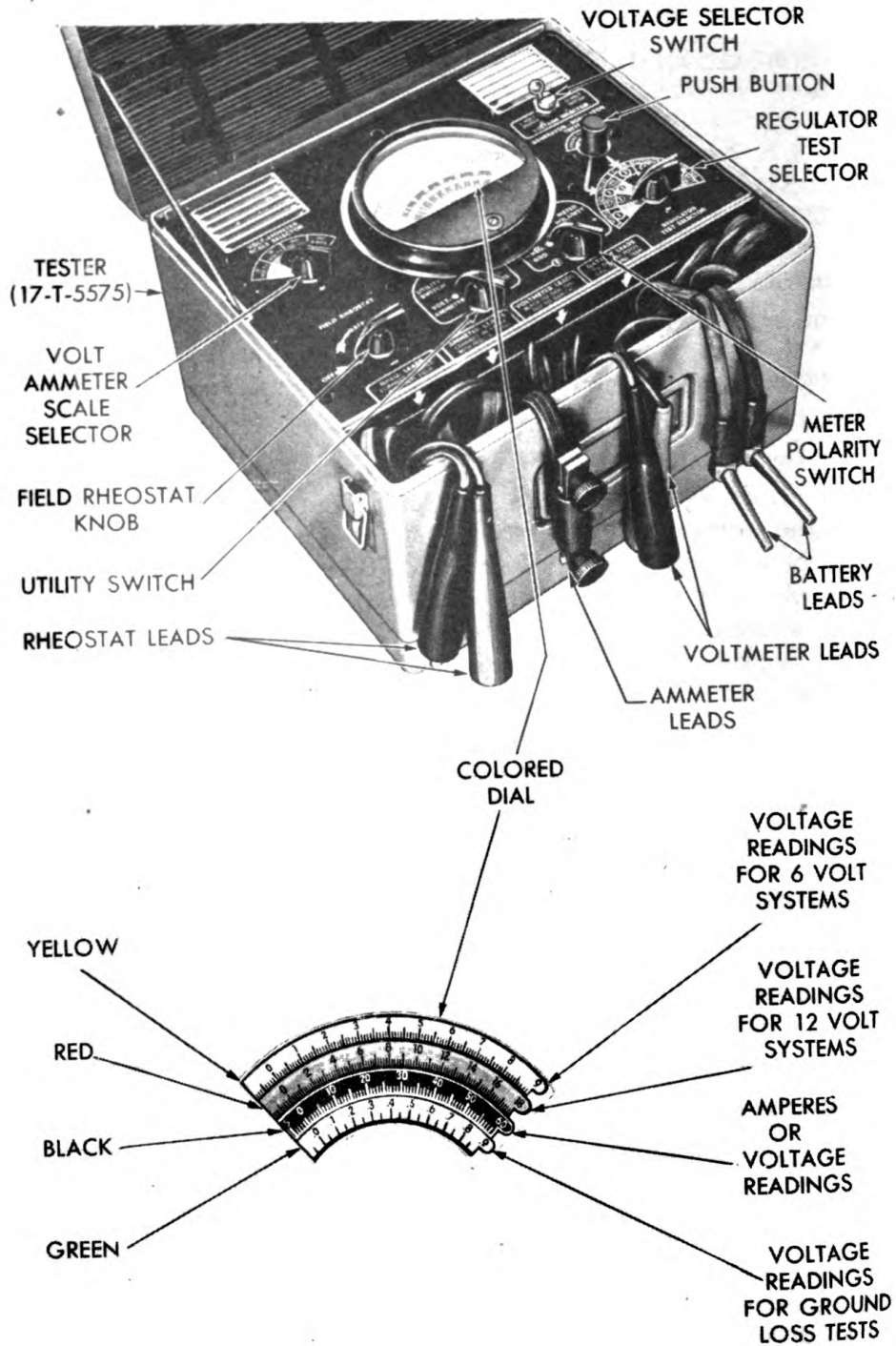

**RA PD 53395**

**Figure 150—Low Voltage Circuit Tester**

## ELECTRICAL TROUBLE SHOOTING

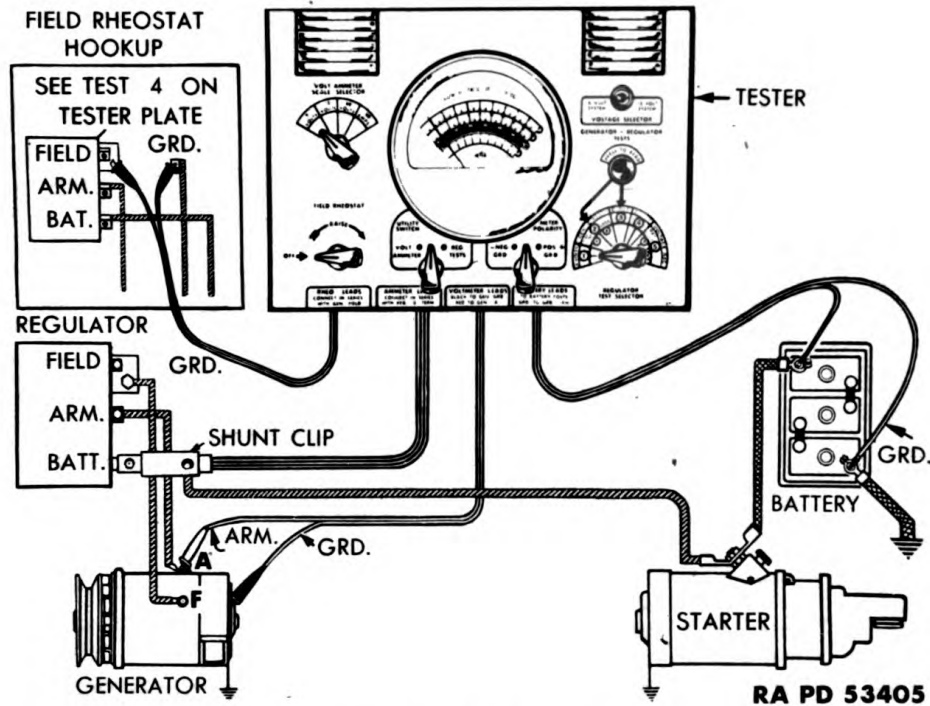

Figure 151—Test Connections for Low Voltage Circuit Tester

moved from regulator terminal market **BAT** to the end terminal of shunt clip. *This is important as the shunt clip must be in series with circuit to be tested.* The shunt clip contains a built-in meter shunt to which the tester is calibrated. Connect voltmeter test lead tagged **ARM** to armature terminal (largest terminal) of the generator and the lead tagged **GRD** to generator frame (fig. 152, 3). Connect battery lead marked **GRD** to ground (negative) post of battery and the other lead to positive battery post (fig. 152, 2). These connections must be made by driving the pins securely into the center of the battery posts in order to make a good connection. False readings will be obtained if the connections are not tight.

c. **Test Battery and Starter** (fig. 153).

(1) **NOTE:** This test is a check on the condition of the battery, using the starter as a load. A defective or undercharged battery may cause misleading readings when making voltage regulator tests which follow.

(2) **TEST PROCEDURE.** Place regulator test selector switch in number 1 position. Operate the starter with ignition off. With starter cranking the engine, the voltage should not drop below 5.25 volts on 6-volt systems (read yellow scale), or 10.5 volts on 12-volt systems (read the red scale). If the voltage drops below the above limits, check the gravity of the electrolyte in each battery cell. A variation of more than

**ORDNANCE MAINTENANCE—POWER PLANT, CLUTCH, AND ELECTRICAL SYSTEM— $\frac{3}{4}$  AND  $1\frac{1}{2}$  TON VEHICLES (DODGE)**

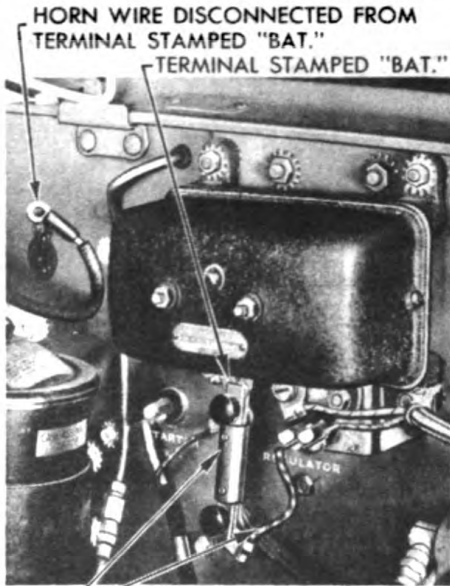

HORN WIRE DISCONNECTED FROM  
TERMINAL STAMPED "BAT."  
TERMINAL STAMPED "BAT."  
WIRE DISCONNECTED FROM  
TERMINAL STAMPED "BAT."  
TESTER SHUNT CLIP  
**1—TESTER CONNECTIONS AT  
GENERATOR REGULATOR**  
VOLTMETER LEAD TAGGED "ARM"

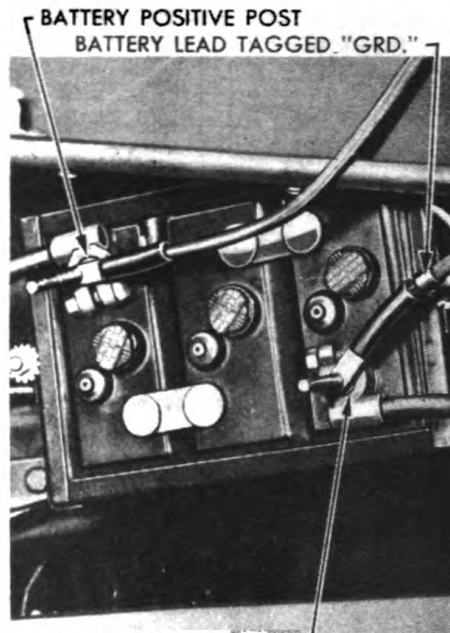

BATTERY POSITIVE POST  
BATTERY LEAD TAGGED "GRD."  
BATTERY NEGATIVE POST  
**2—TESTER CONNECTIONS  
AT BATTERY**  
VOLTMETER LEAD TAGGED "GRD."

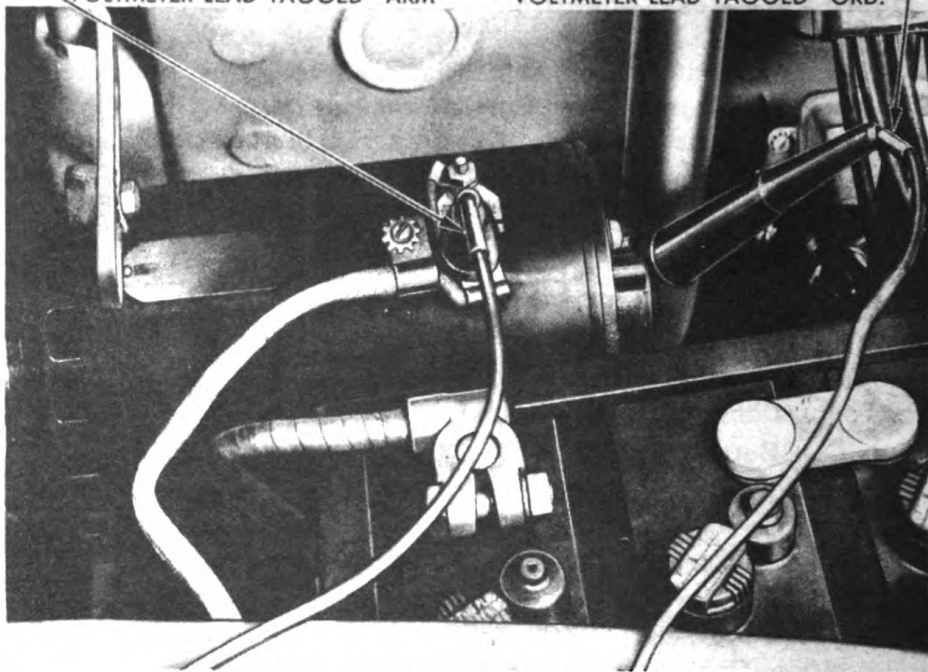

**3—TESTER CONNECTIONS AT GENERATOR**

RA PD 53392

**Figure 152—Tester Connections at Regulator, Battery and Generator**

**ELECTRICAL TROUBLE SHOOTING**

20 points between cells indicates a defective battery. If the gravity of all cells is alike, but below 1.270, recharge the battery. Battery condition affects generating system operation. An old battery, one partially charged or one subjected to excessive heat, will cause a high charging rate; while one subjected to excessive cold, hard plates, high resistance separators and sulphation will cause a low charging rate. If there is any doubt about the condition of the battery, substitute temporarily for test purposes, a battery of the same size and capacity known to be fully

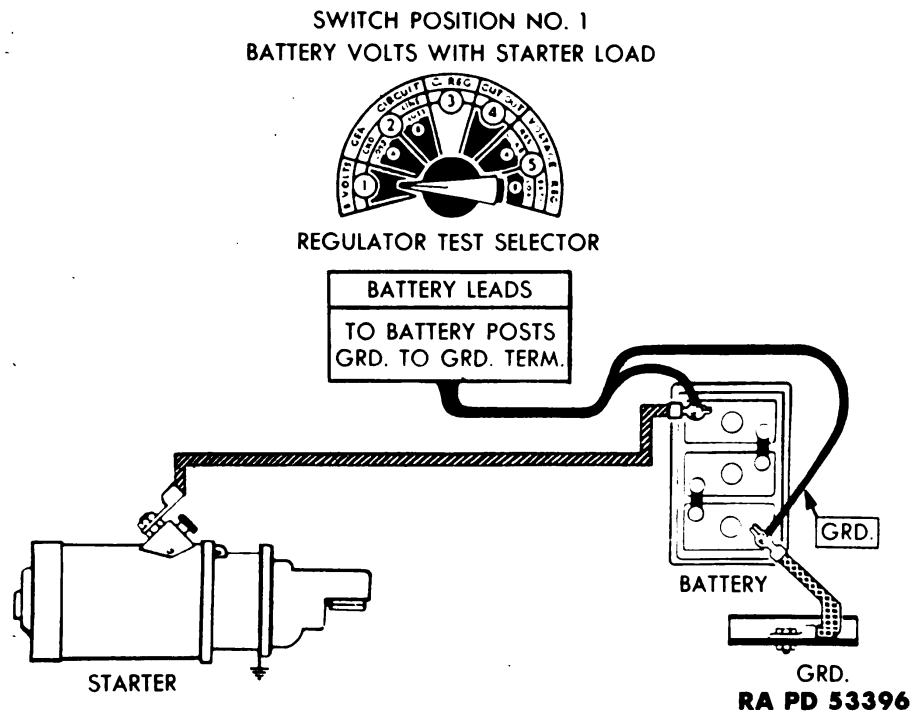

**Figure 153—Battery and Starter Test**

charged and in good condition. A voltage reading below 4.5 volts on 6-volt systems, or 8.5 volts on 12-volt systems with the starter cranking the engine indicates a discharged or defective battery or slow operation of starter.

(3) **NOTE:** In hot climates (95 F and above), a lower specific gravity electrolyte (1.245) is recommended to avoid excessive deterioration of plates and separators. When transferring batteries to a tropical climate that have previously been in service in a temperate climate, first make sure the battery is fully charged. Then remove electrolyte to top of plates and fill with pure water. Charge the battery for two hours at 10 to 15 amperes and repeat procedure until a specific gravity of 1.245 is obtained. Refer to paragraph 97 d for voltage regulator setting.

**ORDNANCE MAINTENANCE—POWER PLANT, CLUTCH, AND ELECTRICAL SYSTEM—¾ AND 1½ TON VEHICLES (DODGE)**

**(4) BATTERY DISCHARGED.**

Possible Cause	Possible Remedy
Switch or switches left on when not in use.	Turn all switches off when not in use.
Excessive use of starter or electrical accessories.	Recharge or replace battery.
Broken or loose fan belt.	Tighten or replace fan belt.
Short circuits or voltage loss in generating or starting system circuits.	To be determined in test which follows (par. 86 d, e and f).
Improper operation of regulator assembly.	To be determined in tests which follow (par. 86 d through k).
Generator not charging.	To be determined in test which follows (par. 86 h).
Battery shorted or damaged.	Replace battery.

**(5) STARTER OPERATES SLOWLY.**

Engine oil too heavy (too heavy oil retards cranking speed and causes voltage drop).	Use proper grade of lubricant for temperature encountered.
Engine not at normal operating temperature (retards cranking speeds and causes voltage drop).	Run engine long enough to establish normal operating temperature (approximately 145 F).
Battery cable terminals loose or corroded.	Clean battery posts and terminals and tighten terminals at battery and ground to frame or engine.
Starter commutator or brushes burned or dirty.	Repair starter (par. 88, 89, and 90).
Starter switch contacts burned or dirty.	Repair or replace switch (par. 89 i).
Starter armature dragging on pole pieces (bearings worn).	Rebuild starter (par. 88, 89, and 90).

**d. Test for Voltage Loss in Generator and Battery Ground Circuit (fig. 154).**

(1) **TEST PROCEDURE.** Place regulator test selector switch in number 2A position. Run engine at about 2,000 revolutions per minute (approximately half speed), then press black push button marked "Press to Read." The meter reading should not exceed 0.05-volt (one division) on the green scale if the ground circuit is in good condition. A reading higher than this indicates a loss of voltage due to poor ground connections.

**ELECTRICAL TROUBLE SHOOTING**

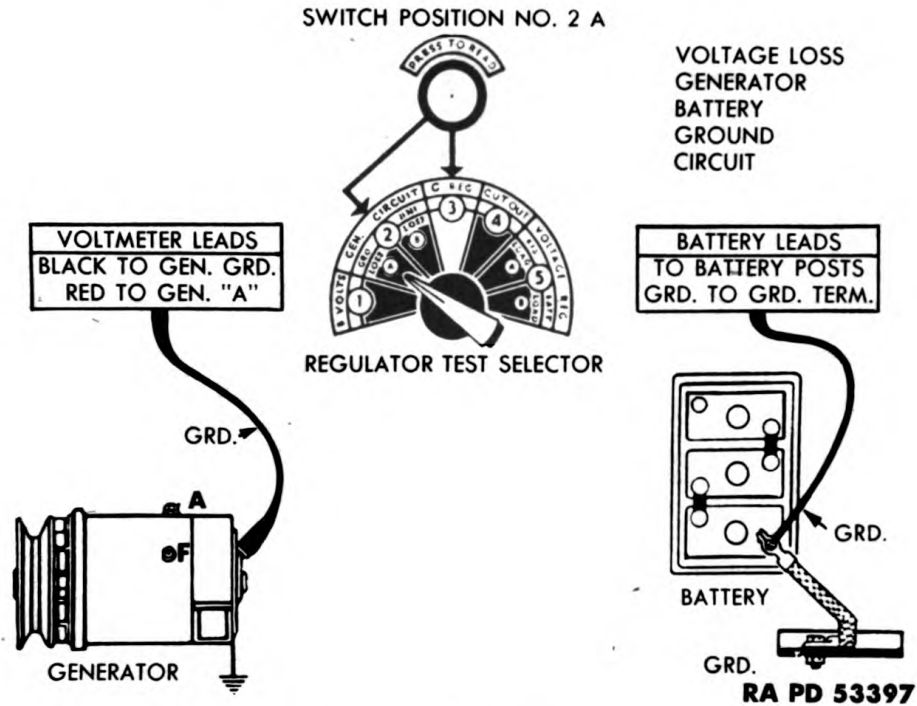

**Figure 154—Voltage Loss Test (Generator and Battery Ground Circuit)**

(2) **VOLTAGE LOSS IN GENERATOR BATTERY GROUND CIRCUIT.**

Possible Cause	Possible Remedy
Loose or defective terminal connections on battery ground cable.	Tighten cable at both ends or replace cable.
Generator housing poorly grounded to engine.	Remove generator, clean mounting bolts and bracket and reinstall generator.
Charging rate too high.	To be determined in test which follows (par. 86 g).

e. **Test for Voltage Loss in Regulator Ground Circuit (fig. 155).** Leave regulator test selector switch in number 2A position with the engine running. Disconnect the voltmeter GRD test cable which was connected to the generator frame and connect it to the regulator base and again press the black button. Reading should not exceed 0.05-volt (one division) on the green scale. A higher reading indicates voltage loss in the regulator ground circuit. Voltage losses in this circuit are caused by a poor ground at either end of the wire shielding at the regulator and generator. Tighten the wire shielding at the regulator base and generator ground connection securely and repeat test.



ORDNANCE MAINTENANCE—POWER PLANT, CLUTCH, AND ELECTRICAL SYSTEM— $\frac{3}{4}$  AND  $1\frac{1}{2}$  TON VEHICLES (DODGE)

SWITCH POSITION NO. 2 A

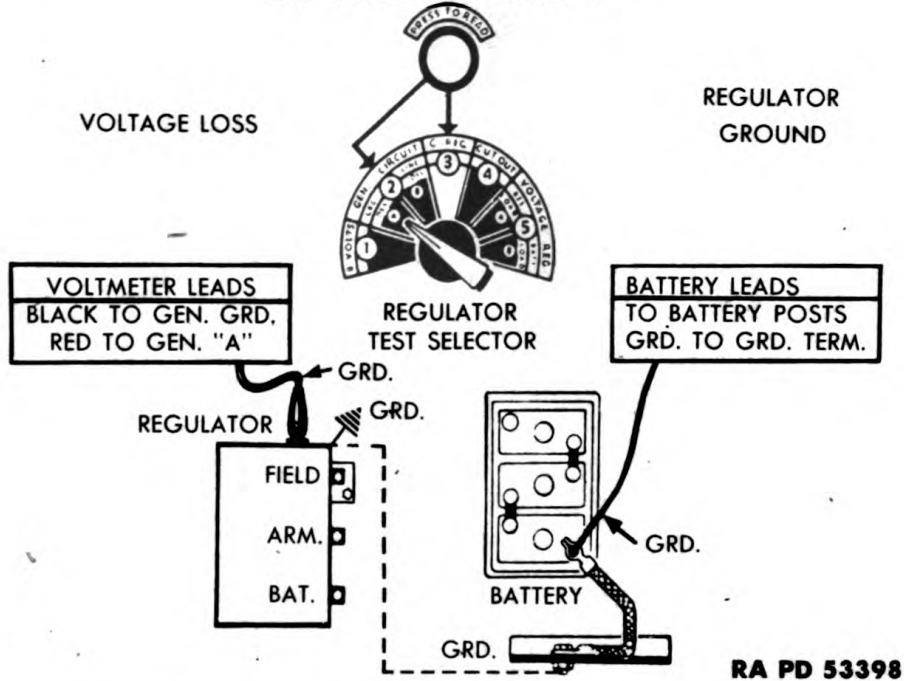

Figure 155—Voltage Loss Test (Regulator Ground Circuit)

SWITCH POSITION NO. 2 B

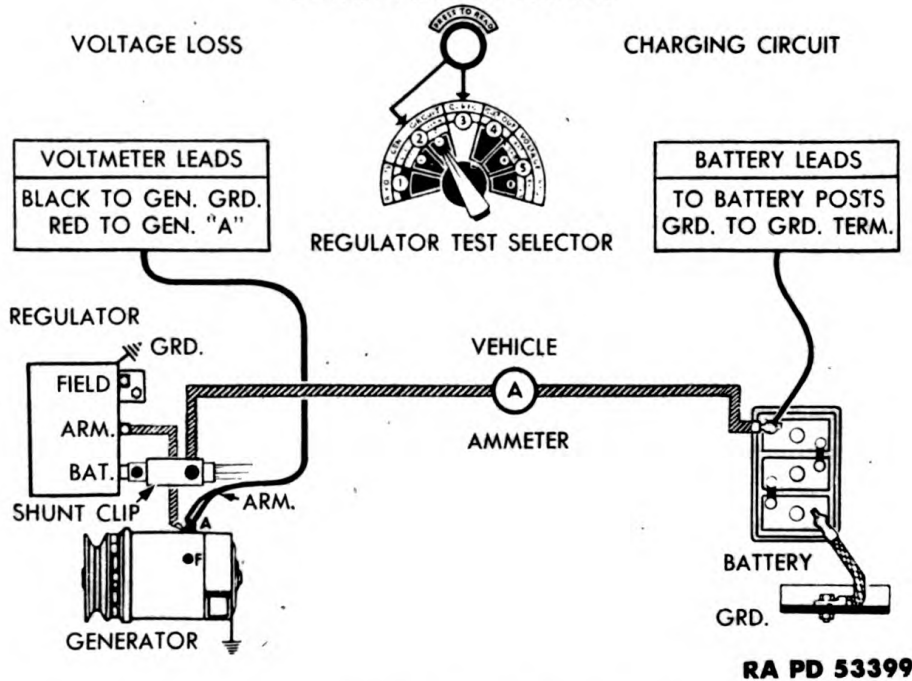

Figure 156—Voltage Loss Test (Charging Circuit)

**ELECTRICAL TROUBLE SHOOTING**

After completing this test leave GRD cable in this position for all following tests.

**f. Test for Voltage Loss in Charging Circuit (fig. 156).**

(1) **TEST PROCEDURE.** Determine charging rate (par. 86 g). Place regulator test selector switch in number 2B position with the engine running. Press the black button and note voltage loss on the yellow scale. Maximum loss should not exceed 0.35-volt for each 10 amperes of current flowing in the circuit.

(2) **VOLTAGE LOSS IN CHARGING CIRCUIT.**

Possible Cause	Possible Remedy
Battery to starter cable terminals loose or corroded.	Tighten or replace cable.
Terminals or connections of wiring between generator and regulator loose or corroded.	Clean and tighten all connections.
Ammeter connections loose or corroded.	Clean and tighten all connections.
Ammeter defective-test with jumper wire across ammeter and repeat test (par. 86 f)	Replace ammeter.
Contact points in circuit breaker burned; poor internal connections within generator regulator.	Adjust or rebuild generator regulator (par. 97 and 98).
Use of undersize replacement cables between battery, generator and regulator.	Install correct size cables (par. 80).
Charging rate too high, causing increased voltage loss in proportion to excessive charging rate.	To be determined in test which follows (par. 86 g).

**g. Test Current Regulator (fig. 157).** Set regulator test selector switch to number 3 position. Run engine at about 2,000 revolutions per minute and press the black push button. Note charging rate (amperes) on black scale. Charging current should approximately coincide with the rated capacity of the generator as shown on rating plate on regulator. If charging current is higher or lower than capacity of generator, the fan belt is loose (par. 30 s) or the current regulator is incorrectly set. Adjust the generator regulator (par. 97). If no charge is indicated in this test, the generator or generator regulator is at fault.

**h. Test to Determine Whether Generator or Regulator Is at Fault.**

(1) Connect a jumper test lead between *A* and *F* terminal of regulator and operate the engine at slow speed. *Under this condition the generator may produce a dangerously high output if the speed is car-*

ORDNANCE MAINTENANCE—POWER PLANT, CLUTCH, AND ELECTRICAL SYSTEM— $\frac{3}{4}$  AND  $1\frac{1}{2}$  TON VEHICLES (DODGE)

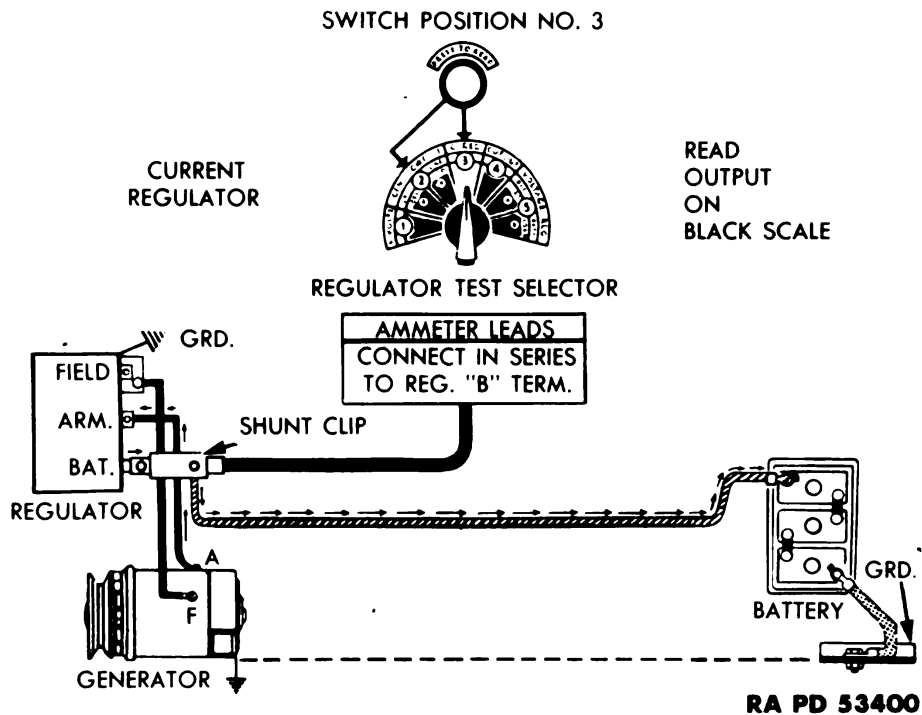

Figure 157—Current Regulator Test

ried too high and if run for too long a period of time, may result in burned armature or field. If the ammeter (black scale) indicates no amperage is flowing in the circuit, it will be necessary to take a voltage reading to determine whether the generator or the regulator is at fault.

(2) To take a voltage reading, place the utility switch in the volt-ammeter position. Turn the volt-ammeter scale selector to 18-volts range. Operate the engine at slow speed only long enough to take a voltage reading. If the engine is operated at too high a speed or for too long a period of time, the generator armature or field may be damaged. If the red scale of the voltmeter indicates a voltage in excess of 8.0 volts for 6-volt systems or 15.0 volts for 12-volt systems, the generator is functioning properly and the fault is in the generator regulator (pars. 97 and 98). With no voltage indication or with a voltage reading below 6.4 volts for 6-volt systems or 13.0 volts for 12-volt systems, the generator is at fault (par. 91 through 96).

(3) After making this test, remove jumper wire across A and F terminals and change utility switch and volt-ammeter scale selector back to original setting for all succeeding tests.

i. **Test Reverse Current in Circuit Breaker.** Leave regulator test selector switch in number 3 position. Gradually reduce engine speed

**ELECTRICAL TROUBLE SHOOTING**

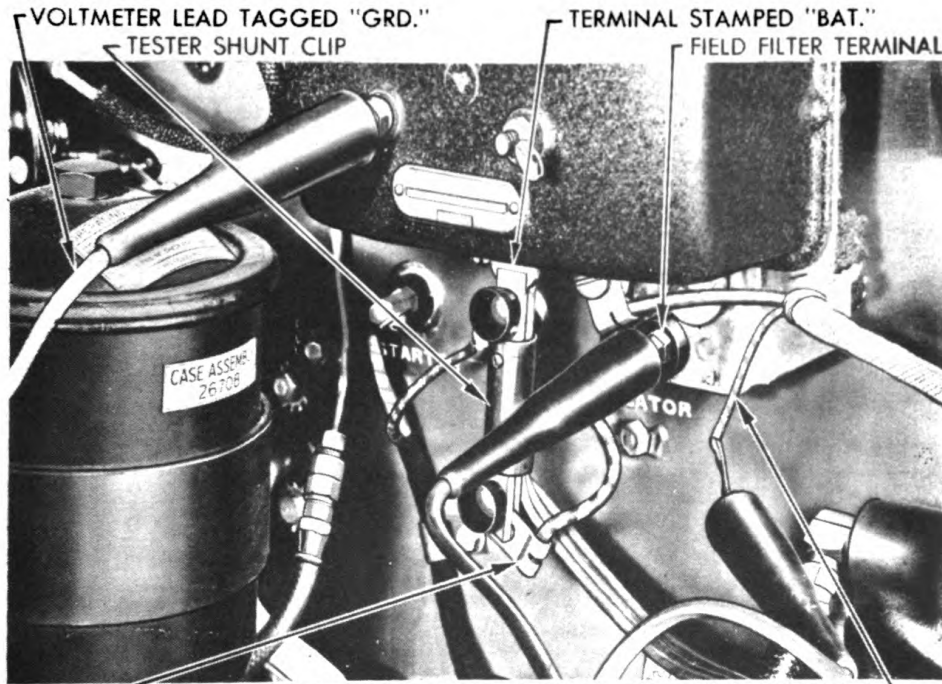

← WIRE DISCONNECTED FROM FIELD FILTER TERMINAL  
← WIRE DISCONNECTED FROM TERMINAL STAMPED "BAT."

FIELD RHEOSTAT HOOKUP

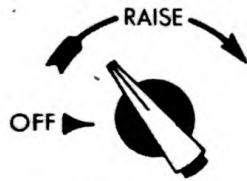

RHEO. LEADS  
CONNECT IN SERIES  
WITH GEN. FIELD

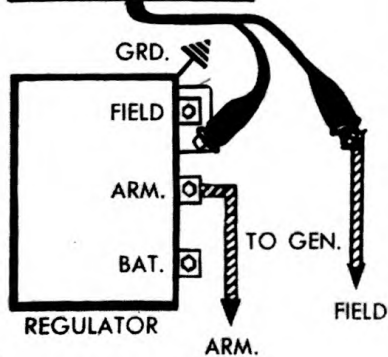

SWITCH POSITION  
NO. 4

CUTOUT CLOSING  
VOLTAGE

REGULATOR TEST SELECTOR

VOLTMETER LEADS  
BLACK TO GEN. GRD.  
RED TO GEN. "A"

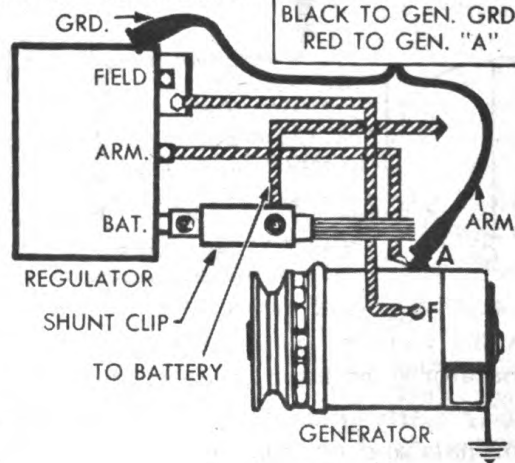

RA PD 53401

**Figure 158—Circuit Breaker Closing Voltage Test**

**ORDNANCE MAINTENANCE—POWER PLANT, CLUTCH, AND ELECTRICAL SYSTEM— $\frac{3}{4}$  AND  $1\frac{1}{2}$  TON VEHICLES (DODGE)**

SWITCH POSITION NO. 5 B  
VOLTAGE REGULATOR BATTERY LOAD

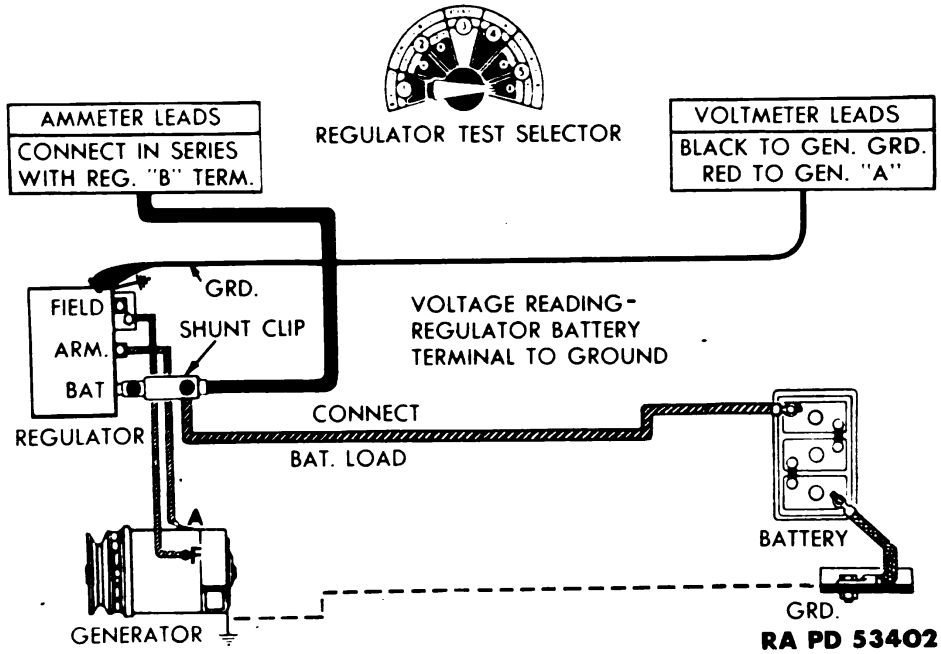

**Figure 159—Voltage Regulator Test**

AMMETER ALWAYS CONNECTED IN SERIES WITH LOAD

VOLTMETER ALWAYS CONNECTED IN PARALLEL WITH LOAD

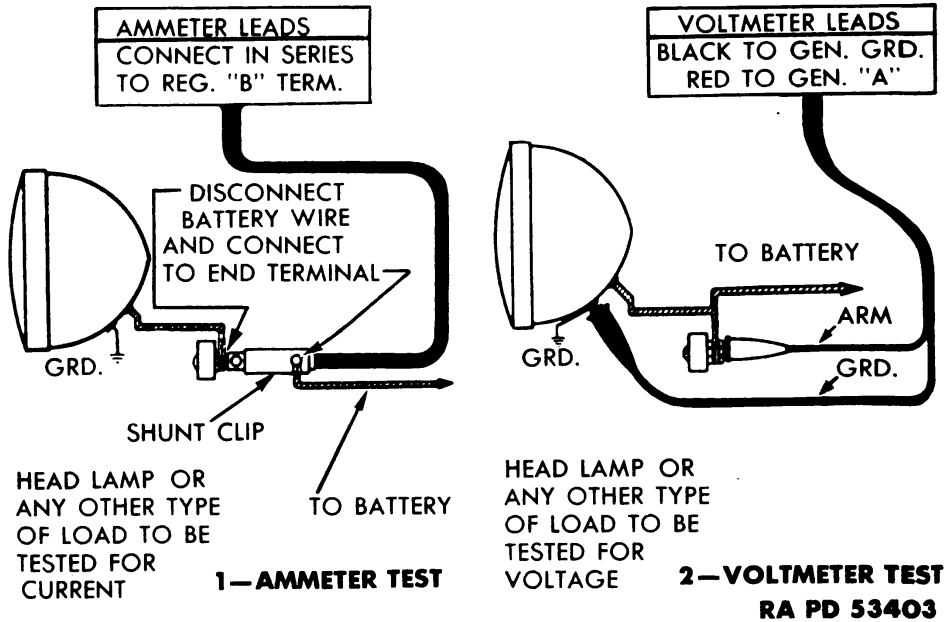

**Figure 160—Volt-Ammeter Tests**

**ELECTRICAL TROUBLE SHOOTING**

and note reverse current on the black scale. If the circuit breaker is opening properly, the reverse current should not exceed 0.5 to 6.0 amperes for both 6-volt and 12-volt systems, before the points open and reverse current stops. It may be necessary to stop the engine and read the discharge current as the engine slows down to a stop. If it is known that the circuit breaker is not functioning properly, repair the generator regulator (par. 98).

**j. Test Closing Voltage of Circuit Breaker (fig. 158).** Place regulator test selector switch in number 4 position. Connect field rheostat in series with the field terminal of the generator at the regulator as shown in figure 158. The field rheostat is provided for controlling the voltage of generators at idling speed to check the circuit breaker closing voltage. Maintain engine speed at fast idle. Then gradually increase generator output with field rheostat by rotating knob in the direction of arrow until meter pointer kicks back slightly. This indicates closing voltage which should be 6.4 to 6.6 volts for 6-volt systems (read yellow scale), or 13.0 to 13.5 volts for 12-volt systems (read red scale). *Circuit breaker closing voltage should always be above that of the battery and at least 0.5 volt under voltage setting of generator regulator (par. 86 k).* If the setting is incorrect, adjust the regulator (par. 97).

**k. Test Voltage Regulator (fig. 159).** Disconnect the field rheostat used in previous test and reconnect the field terminal at the regulator. Set regulator test selector switch in number 5B position. With engine operating at normal temperature, run it at about 2,000 revolutions per minute for approximately five minutes to permit the voltage to stabilize. Read the yellow scale for 6-volt systems or the red scale for 12-volt systems. If the voltmeter readings check within 7.2 to 7.5 volts at room temperature for 6-volt systems or 14.0 to 14.5 volts for 12-volt systems, the voltage regulator unit can be passed as operating correctly. However, if the voltmeter reading does not check within these limits, adjust or rebuild the voltage regulator (pars. 97 and 98).

**l. Volt-Ammeter Tests (fig. 160).** The low voltage circuit tester may be used to make various low voltage and amperage tests within the range of the meter. To use the instrument as a plain volt-ammeter, place voltage selector to suit voltage of vehicle system. Place utility switch at volt-ammeter position. Set meter polarity switch to suit ground polarity of vehicle. Place volt-ammeter scale selector at desired meter range. Use ammeter leads to measure amperage (read black scale) placing the shunt clip in series with the circuit to be tested (not to exceed 60 amperes) (fig. 160, 1). Use voltmeter leads to measure voltage, making connections parallel to the circuit to be tested (fig. 160, 2). Read yellow scale for 6-volt systems and red scale for 12-volt systems. Read black scale for higher voltages.

**ORDNANCE MAINTENANCE—POWER PLANT, CLUTCH, AND ELECTRICAL SYSTEM— $\frac{3}{4}$  AND 1 $\frac{1}{2}$  TON VEHICLES (DODGE)**

**87. IGNITION SYSTEM TROUBLE SHOOTING.**

a. **General Information.** The probable cause of trouble in the ignition system can be diagnosed with the aid of the low voltage circuit tester (17-T-5575) and the ignition (high-voltage) circuit tester (17-T-5520). The low-voltage circuit tester can be used to test the ignition primary circuit connections for voltage loss and the high tension tester can be used to test the ignition coil, condenser, distributor breaker points and high tension cables for proper operation.

CONNECT THE BLACK (NEGATIVE) LEAD TO A DEFINITE CHASSIS GROUND.

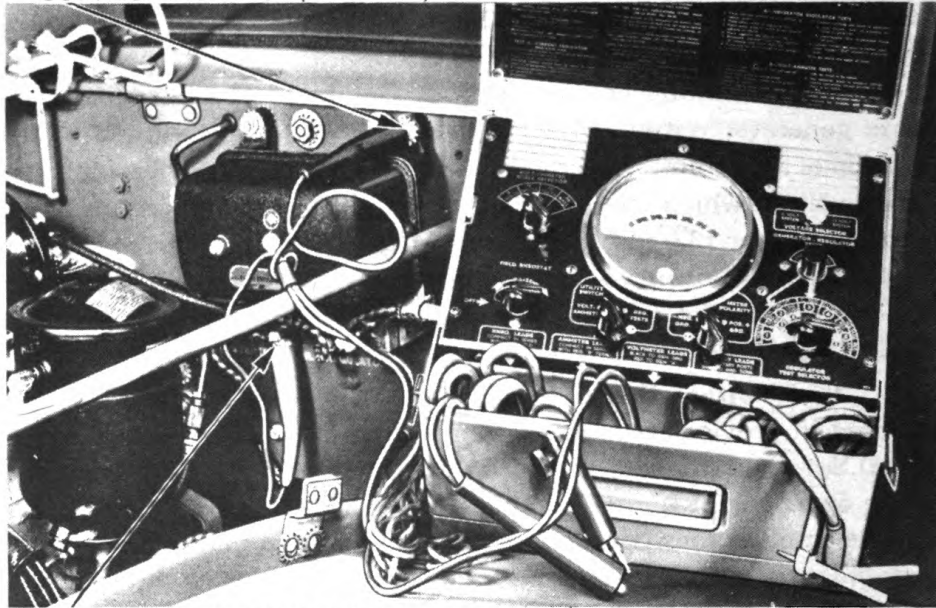

CONNECT THE RED (POSITIVE) LEAD TO OUTLET TERMINAL OF CIRCUIT OR PART OF CIRCUIT TO BE CHECKED

**RA PD 53410**

**Figure 161—Ignition Primary Circuit Tests**

b. **Test Primary (Low Tension) Circuit (fig. 161).** If the head lamps do not burn but the starter will crank the engine, ignition system trouble will be found in the wires or connections between the starter switch and the ammeter. If the head lamps burn fairly bright there will be ample current in the ignition circuit at least as far as the ammeter. To test primary circuit from ammeter through coil and distributor, remove the distributor cap and rotor and turn the engine until the distributor breaker points are definitely closed. Turn on the ignition switch and push the breaker points apart with finger. If there is a slight arc of current as the points open, the primary circuit is complete and will function if the contact points make and break properly when the engine is cranked. If no current is indicated by making and breaking contact of the breaker points when the ignition switch is on, turn the

**ELECTRICAL TROUBLE SHOOTING**

engine until the breaker points are open and test ignition primary circuit, using low-voltage tester (17-T-5575) as voltmeter (par. 86 l). Connect the black negative lead from the voltmeter of low-voltage tester (fig. 161) to any part of the chassis that will provide a definite ground and make the following tests:

(1) Test the wire and connections between the ammeter and the ignition switch by holding the red (positive) lead from the voltmeter against the left post of the ignition switch. If the approximate battery voltage is shown on the voltmeter, the circuit is complete to the switch.

(2) Test the switch by moving the voltmeter positive lead to the right post of the switch. If about the same voltage is shown, current is passing through the switch.

(3) Test primary wires and connections from ignition switch through radio filter to the coil by moving the voltmeter positive lead to the lower left post of the coil. If battery voltage is again shown, current is reaching that post.

(4) Test primary circuit from coil to distributor breaker points by moving the voltmeter positive lead to the lower right post of the coil, to each side of the distributor filter (if so equipped) and finally to the distributor breaker arm. If battery voltage is shown at any of these points of test but not at the next point, the trouble will be located between the two points. If very little or no voltage is shown at any point between the coil and breaker arm, disconnect the condenser lead wire from the distributor body and connect the voltmeter positive lead to the breaker arm. A normal battery voltage reading then would show a shorted condenser. No voltage reading at any of the points between the coil and breaker arm with the breaker points open and the condenser lead disconnected would indicate a broken primary circuit in the coil.

**c. Ignition (High Tension) Circuit Tests.**

(1) **GENERAL.** When testing high tension ignition units with the ignition (high tension) circuit tester (17-T-5520) for the purpose of locating the cause of faulty performance or engine failure, the following must also be considered:

(a) *Battery.* The battery supplies the current to the ignition primary circuit and constitutes the coil input. Before any attempt is made to check coil output check battery capacity and condition as it must be fully charged and in good condition.

(b) *Resistance in Ignition Primary Circuit.* Resistance in the primary circuit, such as loose connections or poor ground at the condenser, causes loss of energy. Clean and tighten connections at the battery, ammeter, coil and ignition switch. Test all ignition primary circuit connections (par. 87 b).

(c) *Arcing Across the Coil Terminals.* Excessive moisture collecting on the coil top may cause the high tension spark to jump across to



**ORDNANCE MAINTENANCE—POWER PLANT, CLUTCH, AND ELECTRICAL SYSTEM—¾ AND 1½ TON VEHICLES (DODGE)**

the low-tension terminals, causing the engine to miss. Continued arcing will eventually burn a path across the surface of the coil top and render the coil inoperative. Wipe all dirt and moisture off coil top.

(d) *Ignition Timing.* Ignition timing will affect performance materially. The timing of the distributor to the engine is disturbed whenever the breaker points are adjusted or replaced. Check ignition timing (par. 25 g and h).

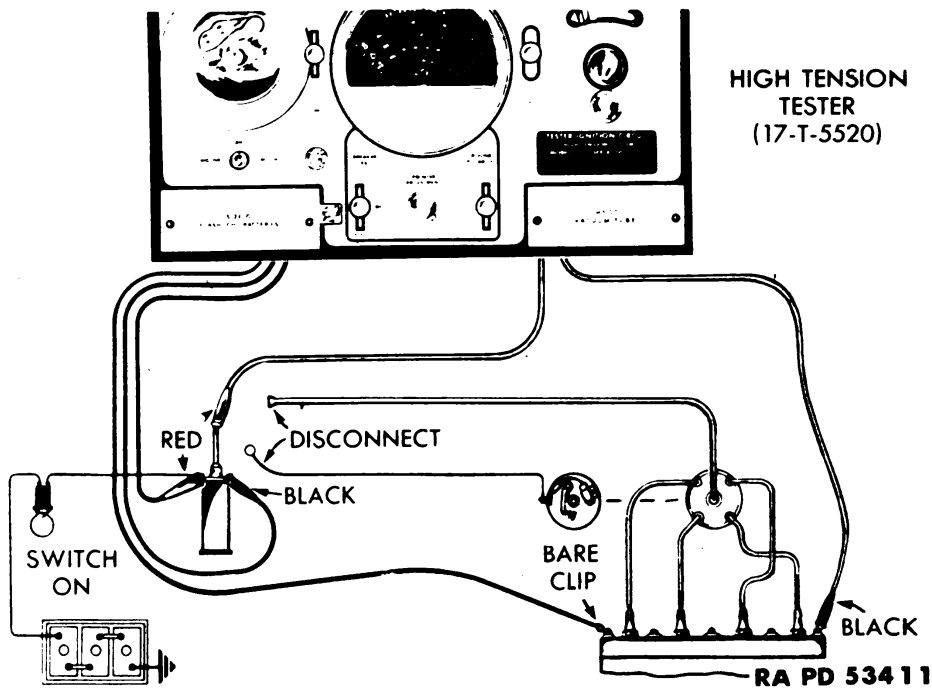

**Figure 162—Ignition Coil Test**

(e) *Spark Advance.* Faulty operation of the centrifugal governor weights in the distributor will result in sluggish engine performance or excessive pinging due to improper spark advance (par. 101 j).

(f) *Spark Plugs.* Cracked, dirty or improperly spaced spark plugs will prevent satisfactory engine performance. Clean and space spark plugs (par. 25 i).

(g) *Low Voltage Tests.* To be conclusive, any tests of the ignition system must be preceded by a complete check of the low voltage system, including the battery, generator and regulator as outlined in paragraph 86.

(2) **TEST IGNITION COIL** (fig. 162). To determine whether the coil high tension output is adequate to fire the engine under all operating conditions, compare the coil on the vehicle with the standard coil in

**ELECTRICAL TROUBLE SHOOTING**

the tester. Both coils are operated by the standard test breaker and primary current is supplied by the vehicle battery. Do not operate the engine at any time during this test. See that the temperature of tester is approximately equal to that of the vehicle when making coil test. Disconnect coil to distributor low tension lead at coil. Connect *low tension* test leads of tester to vehicle as follows:

(a) Black clip (labeled DIST) to distributor terminal of vehicle coil.

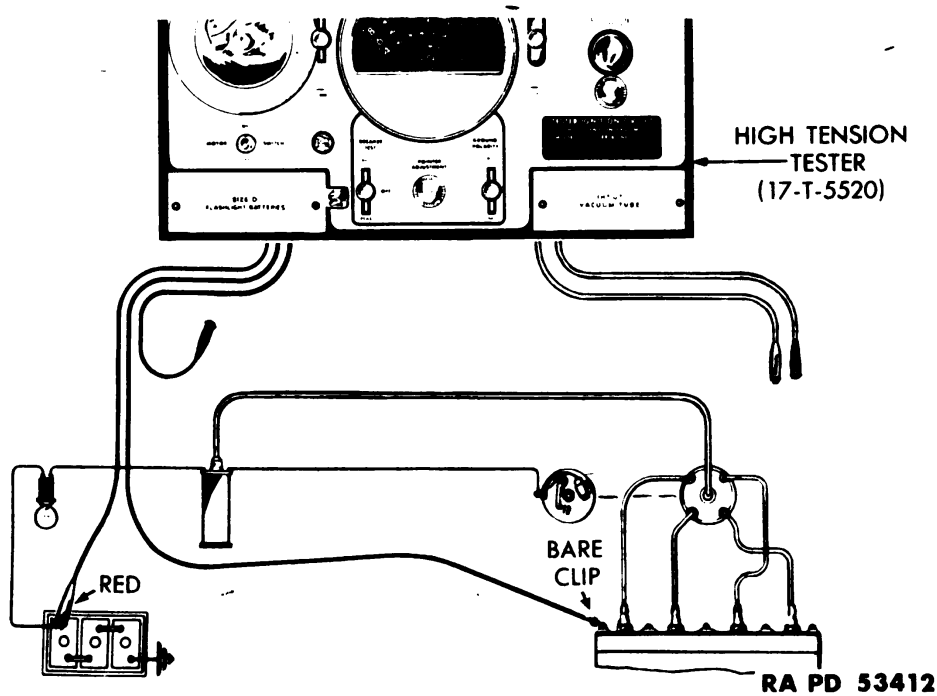

**Figure 163—Condenser Test**

(b) Bare clip (labeled GRD) to a good ground on engine.

(c) Red clip (labeled BAT) to battery terminal of vehicle coil. Disconnect vehicle high tension lead from coil terminal and substitute short test cable. Connect *high tension* test leads of tester to vehicle as follows:

(d) Red clip to short test cable inserted in vehicle coil high tension terminal.

(e) Black clip to good ground on engine.

Turn vehicle ignition switch on and place coil test switch at **TEST COIL**. Turn motor switch on and adjust variable spark gap to highest setting obtainable without missing. Move coil test switch to **VEHICLE COIL** and observe continuity of spark as well as maximum millimeter reading obtained with variable spark gap. If no missing occurs, vehicle

**ORDNANCE MAINTENANCE—POWER PLANT, CLUTCH, AND  
ELECTRICAL SYSTEM— $\frac{3}{4}$  AND 1 $\frac{1}{2}$  TON VEHICLES (DODGE)**

coil is satisfactory. If spark misses, although standard test coil fires steadily, replace the vehicle coil. After making this test, connect the high- and low-tension wires at vehicle coil.

(3) **TEST CONDENSER** (fig. 163). To obtain a reliable comparison, remove the condenser to be tested from the vehicle and compare the vehicle condenser with the standard condenser in the tester by observing the effect upon coil output and arcing at the breaker contacts of the tester, when switching from vehicle condenser to the tester condenser. Insert vehicle condenser in supporting clip on tester and attach the short test lead of the tester to pigtail terminal of vehicle condenser. Connect *low-tension* test leads of tester to vehicle as follows:

- (a) Bare clip (label GRD) to good ground on engine.
- (b) Red clip (labeled BAT) to battery or starter switch.

Place the high-tension test leads in a position where they will not ground on vehicle and place coil test switch at **TEST COIL**. Turn motor switch on and adjust variable spark gap to highest setting obtainable without missing. Move condenser test switch to **VEHICLE COND** and observe effect on high-tension output and arcing at tester breaker contacts. Repeat test several times. If switching to **VEHICLE COND** does not result in arcing and spark does not miss, vehicle condenser is satisfactory. If arcing does occur or spark misses, replace the condenser, as it is not functioning normally. When installing condenser in vehicle, clean and tighten ground and pigtail connections securely.

(4) **TEST AND ADJUST BREAKER POINTS** (fig. 164).

(a) *Test Adjustment and Condition of Breaker Points*. This test reveals the condition of the breaker contacts and shows whether they are properly adjusted. Contact resistance and contact spacing are measured electrically and indicated on the breaker contact meter. The shaded section at the right of the meter scale represents the permissible tolerance of contact resistance. Contact spacing is indicated in degrees of cam angle (angle of rotation through which the breaker contacts remain closed). Insufficient contact opening causes a high reading; excessive contact opening a low reading. Faulty operation of the breaker mechanism causes the meter pointer to fluctuate and, when aggravated by high-speed operation, causes a reduction in cam angle reading. The coil test switch must remain in the **TEST COIL** position throughout this test. Connect low tension test leads of tester to vehicle as follows:

1. Black clip (labeled DIST) to primary terminal of distributor.
2. Bare clip (labeled GRD) to good ground on engine.

Set ground polarity switch to match ground polarity of vehicle system. (All vehicles covered by this manual have negative ground electrical systems.) Have vehicle breaker contacts fully closed. Turn vehicle ignition switch "ON". Hold breaker test switch at **ADJ** and with

**ELECTRICAL TROUBLE SHOOTING**

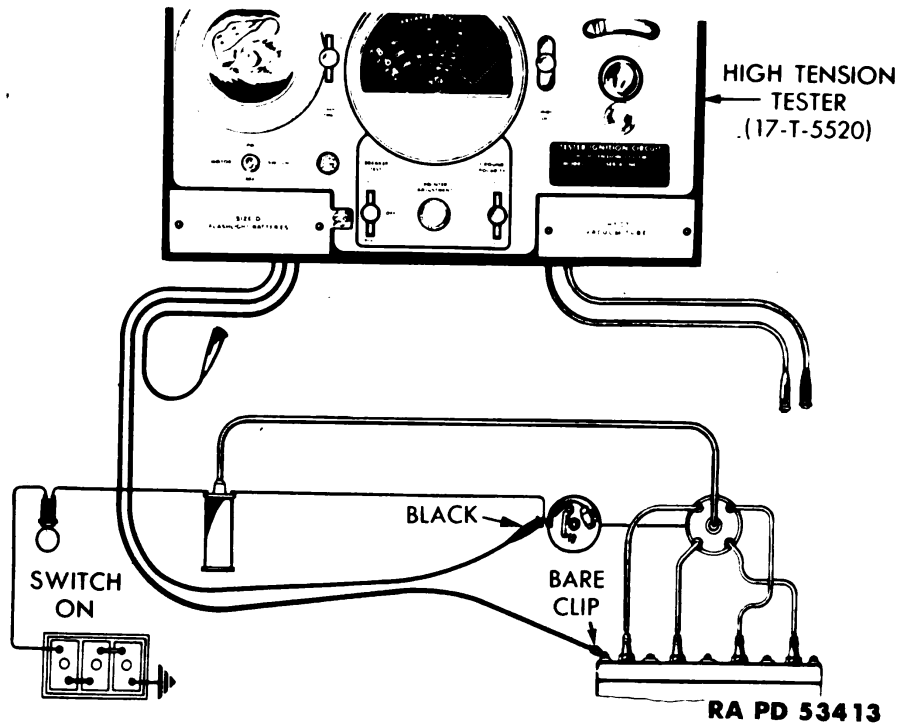

**Figure 164—Vehicle Breaker Test**

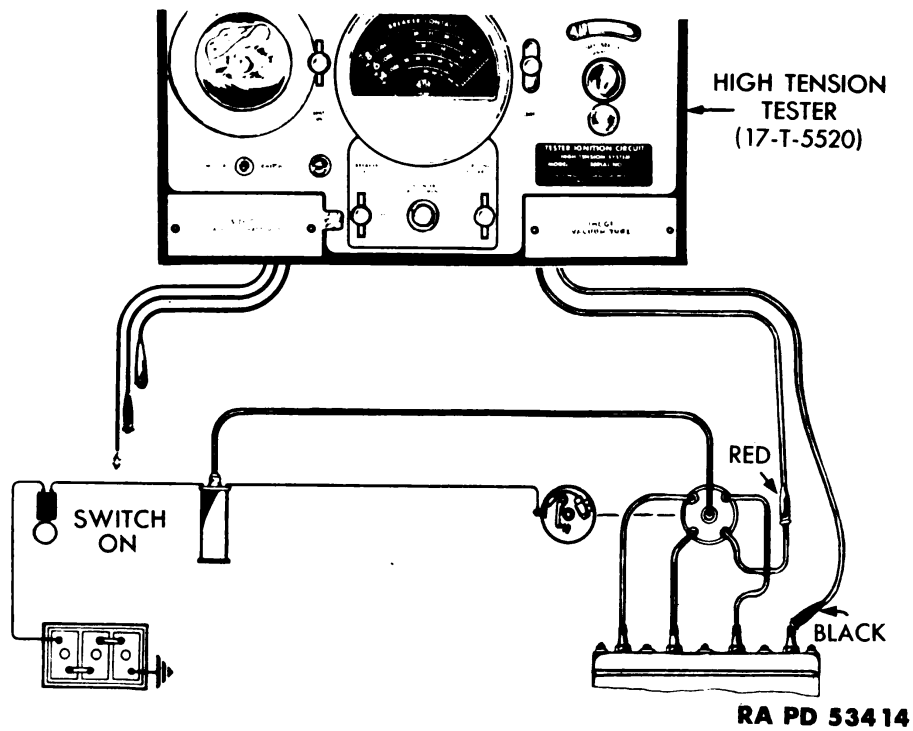

**Figure 165—High Tension Cable Test**

**ORDNANCE MAINTENANCE—POWER PLANT, CLUTCH, AND ELECTRICAL SYSTEM— $\frac{3}{4}$  AND  $1\frac{1}{2}$  TON VEHICLES (DODGE)**

pointer adjustment, set meter pointer to line indicated by arrow. Move breaker test switch to READ. Pointer should remain within shaded section. If below this, contact resistance is excessive. Clean or replace the breaker points before proceeding with breaker point test. Then operate engine at "fast idle" (500 rpm). Hold breaker test switch at ADJ and with pointer adjustment, set meter pointer to line indicated by arrow. Hold breaker test switch at READ and observe cam angle of breaker contacts. The cam angle (point dwell) reading should be  $37\frac{1}{2}$  to 40 degrees. Raise engine speed to approximately 2500 revolutions per minute and note any reduction in cam angle. High speed reading should be within 10 per cent of that obtained at "fast idle."

(b) *Adjust Breaker Points.* To adjust the distributor breaker points with the high tension tester, remove vehicle distributor cap and rotor. Turn vehicle ignition switch on, hold breaker test switch at READ and, while cranking engine with starter, adjust breaker contacts until the correct cam angle (point dwell) reading ( $37\frac{1}{2}$  to 40 degrees) is obtained. Replace distributor cap and rotor.

(5) **TEST HIGH TENSION CABLES** (fig. 165). After satisfactory coil output has been established, faulty high tension cables can be detected by placing the variable spark gap in series with each spark plug cable and observing the spark output and continuity. The coil test switch must remain in VEHICLE COIL position during the test. Disconnect spark plug cable and connect *high-tension* test lead with red clip to the end of the cable. Connect *high-tension* test lead with black clip to top of spark plug. Operate engine at "fast idle" (500 rpm) and place variable spark gap at maximum setting obtainable without missing. Spark length should be within 2 mm. of that obtained in ignition coil test (par. 87 c (2)). If maximum setting obtainable without missing is less than this, connect the red clip directly to corresponding distributor cap terminal. If satisfactory spark is then obtained, the cable is at fault. If spark still misses, the fault lies in the distributor cap or motor.

**CHAPTER 3**

**ELECTRICAL SYSTEM (Cont'd)**

**Section III**

**STARTER REBUILDING**

	Paragraph
Disassembly of starter.....	88
Tests and repair of starter parts.....	89
Assembly of starter.....	90

**88. DISASSEMBLY OF STARTER.**

**a. Remove Commutator End Plate** (fig. 166). Loosen the starter inspection cover bolt nut and slide the cover off the motor. Pry up on the brush springs and pull the two brushes connected to the motor frame out of their holders. Then remove the screws which attach the brush terminals to the frame and remove the brushes. Pry up on the brush springs and pull the two brushes connected to the field coils out of their holders. Remove the long frame screws and the end plate, tapping the end plate lightly to loosen it if it sticks. Remove the leather and the composition thrust washers from the end of the armature shaft. Pry the brush springs out of the brush holder supports. File off the riveted ends of the brush holders and remove the rivets. Pry the front bushing felt out of the housing.

**b. Remove Frame and Field Coil Assembly.** Loosen and remove the frame and field coil assembly from the pinion housing. Remove the screws attaching the starter switch to the frame and remove the switch. Remove the nut from the terminal post and remove the starter switch lower contact and the insulating block. Do not remove field coils from frame until they have been tested (par. 89 a).

**c. Remove Armature** (fig. 166). Pull armature splined end out of the starting pinion and clutch assembly. Remove the thrust washer between the starting clutch and pinion housing.

**d. Remove Clutch Assembly.** Remove the nut from the shift yoke pivot screw and remove the screw from the pinion housing. Remove the shift yoke, then the starting clutch assembly. Press the bearing out of the pinion housing.

**e. Disassemble Clutch Assembly.** Compress the shift spring by pressing down on the shift collar and remove the lock ring. Remove the shift collar and shift spring from the clutch. Do not disassemble the clutch assembly because it cannot be satisfactorily repaired.

**ORDNANCE MAINTENANCE—POWER PLANT, CLUTCH, AND ELECTRICAL SYSTEM— $\frac{3}{4}$  AND  $1\frac{1}{2}$  TON VEHICLES (DODGE)**

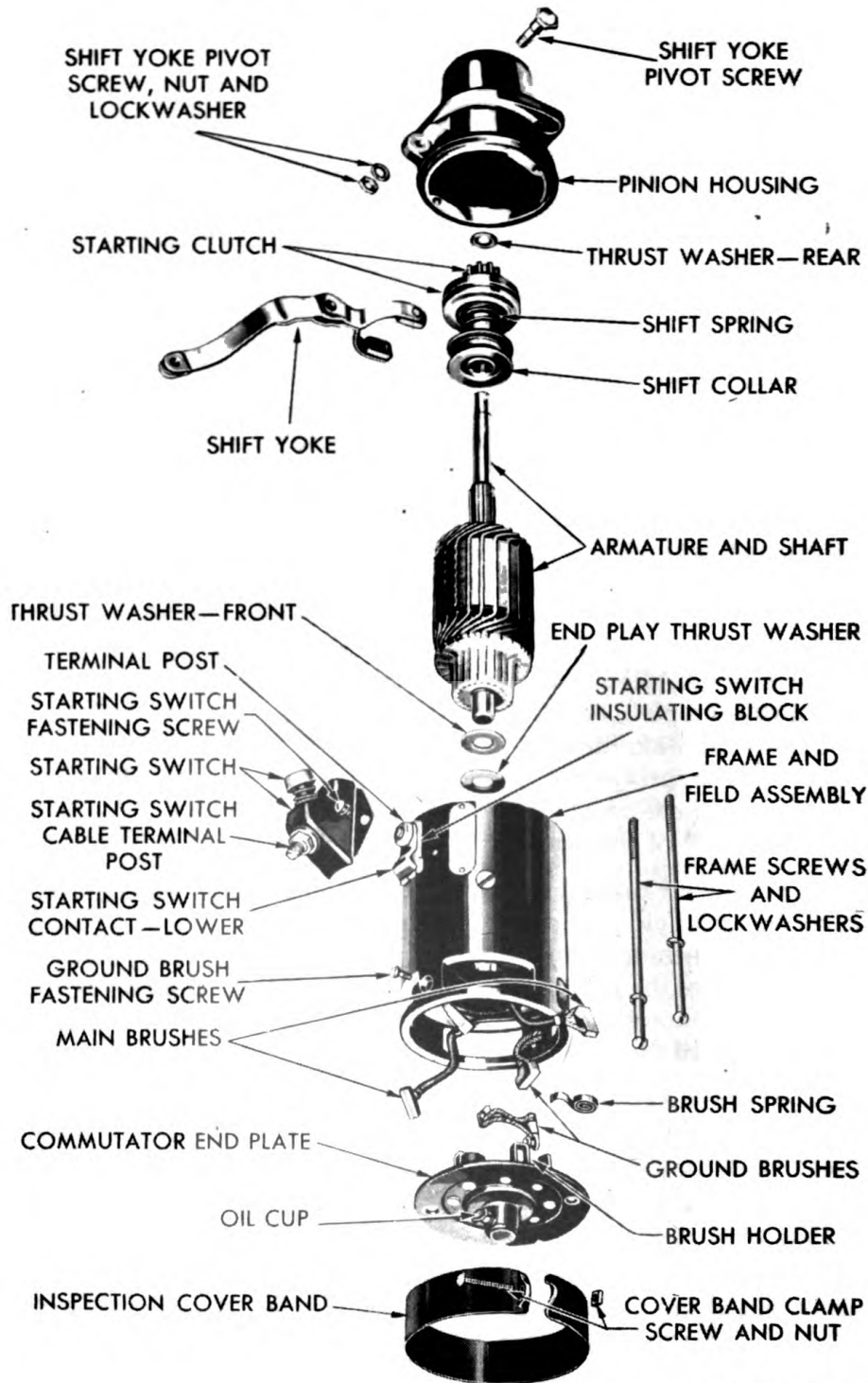

RA PD 53341

**Figure 166—Starter Disassembled**

**STARTER REBUILDING**

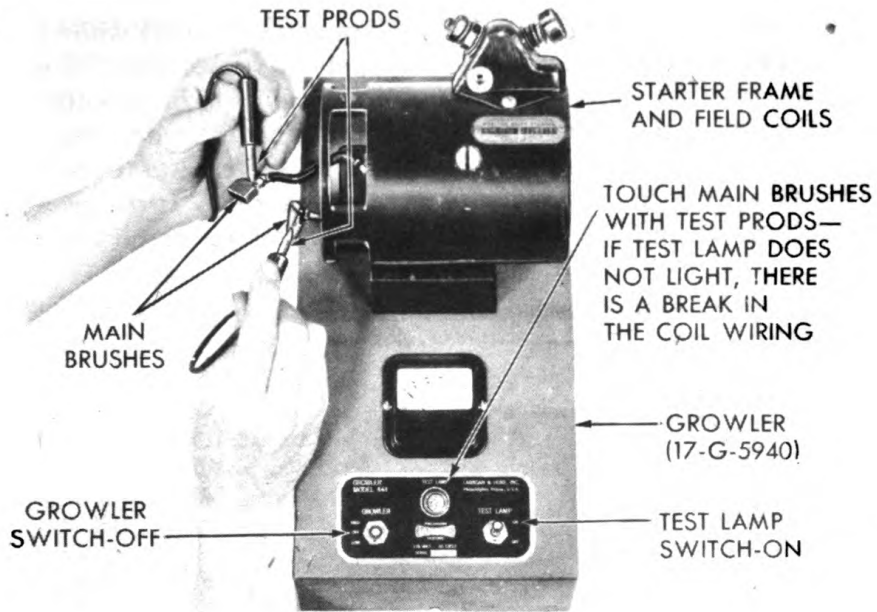

**TESTING STARTER FIELD COILS FOR OPEN CIRCUIT**

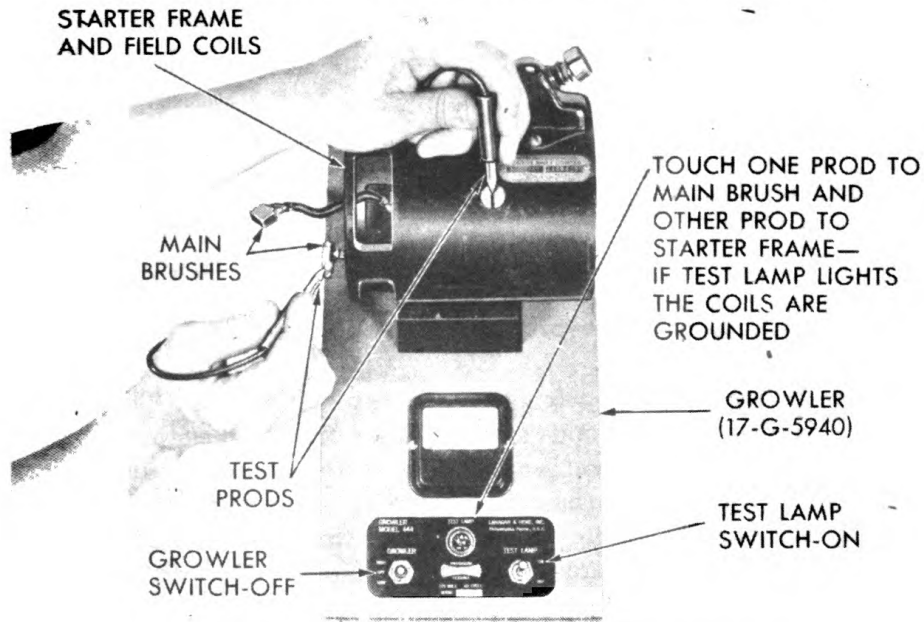

**TESTING STARTER FIELD COILS FOR GROUND**

RA PD 53377

**Figure 167—Starter Field Coil Test**



**ORDNANCE MAINTENANCE—POWER PLANT, CLUTCH, AND ELECTRICAL SYSTEM—¾ AND 1½ TON VEHICLES (DODGE)**

**89. TESTS AND REPAIR OF STARTER PARTS.**

a. **Test Field Coils** (fig. 167). Test the field coils while they are in the frame, to determine whether repair or replacement is required. Test the coils for an open circuit or grounded condition with the test lamp circuit of the growler. Turn off the growler switch and connect the growler. Turn on the growler test lamp switch and touch the ends of the test prods to the ends of each coil separately. If the growler test lamp does not light, there is a break in the coil wiring. If the break in

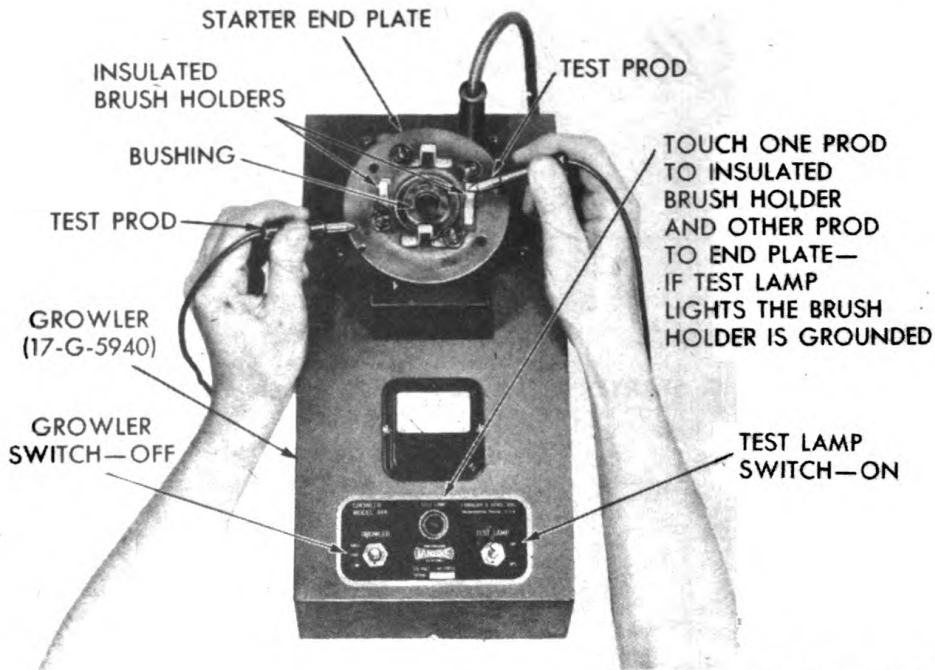

RA PD 53378

**Figure 168—Starter Brush Holder Test**

wiring can be located, repair it; otherwise replace the coil. Then touch one of the prods to the coil ends and the other prod to the starter frame. If the test lamp lights, the coil is grounded. If the ground can be located, repair it; otherwise replace the coil. To remove coils, remove the screws attaching the field coil pole pieces to the frame. Unsolder the field coil connector from the terminal post and remove the coils. Unsolder the brush terminals at the connections to the coils and remove them.

b. **Clean Metal Parts.** Wash all metal parts in dry cleaning solvent and dry with compressed air. Do not wash the wiring or brushes in the cleaner but wipe these parts clean with a rag.

c. **Inspect End Plate Assembly** (fig. 168). Examine the end plate for visible damage or irregular conditions, such as distorted brush

**STARTER REBUILDING**

holders, excessively worn, scored or burned shaft bushing, cracked or warped end plate stamping. Repair or replace the end plate assembly if it is found unsatisfactory. Test the two brush holders which are insulated from the end plate for short circuit. Use the test lamp of the growler. Connect the growler and turn on the test lamp switch. Then touch one prod to brush holder and the other prod to the end plate stamping. If the test lamp lights, the insulated brush holder is short circuited. Test both insulated brush holders in the same manner. If the ground can be located, repair it; otherwise replace the end plate assembly.

**d. Inspect Brushes.** Inspect the brushes for wear by comparing them with a new brush. If they are worn more than one-half of their original length or excessively worn on the sides where they slide in the holder or the contacting surfaces are scored or oil soaked, replace them.

**e. Inspect and Test Brush Springs.** Clamp the armature in a vise and fit the end plate assembled with brushes and springs in position over the commutator. Connect a spring scale to one of the brushes at the curve near the spring end. Insert a strip of paper about the width of the brush, between the brush and commutator. Hold the armature steady and pull on the spring scale while withdrawing the paper. Note the reading on the spring scale at the point where the paper is released enough to withdraw it easily. Test all springs in the same manner. If the springs have a tension of less than 42 ounces or greater than 53 ounces, replace the springs or bend the spring anchor as required to secure the desired tension.

**f. Inspect and Test Armature (fig. 169).**

(1) **TEST ARMATURE FOR GROUNDED CONDITION.** Connect the growler and turn on the test lamp. Touch one prod of the test lamp to the armature shaft at any point except the bearing surfaces or brush surfaces, and touch the other prod to the commutator segments. Repair or replace the armature if the test lamp lights, as the armature is grounded.

(2) **TEST ARMATURE FOR SHORT CIRCUIT.** Place the armature in the growler. Connect growler and open the growler switch to the point marked high. Hold a thin steel strip parallel with and against the armature core segments. Rotate the armature slowly by hand in the growler while holding the steel strip stationary. If the steel strip vibrates at any point, the armature is short circuited.

(3) **CHECK ARMATURE FOR ECCENTRICITY.** Test the commutator for eccentricity by placing the button of a dial gage against the commutator while turning the armature slowly in the V-blocks or a lathe. Replace the armature or true up the commutator if the eccentricity exceeds 0.003 inch. Replace the armature if the armature shaft is bent or the bearing surfaces are worn, scored or otherwise damaged.

**ORDNANCE MAINTENANCE—POWER PLANT, CLUTCH, AND ELECTRICAL SYSTEM— $\frac{3}{4}$  AND  $1\frac{1}{2}$  TON VEHICLES (DODGE)**

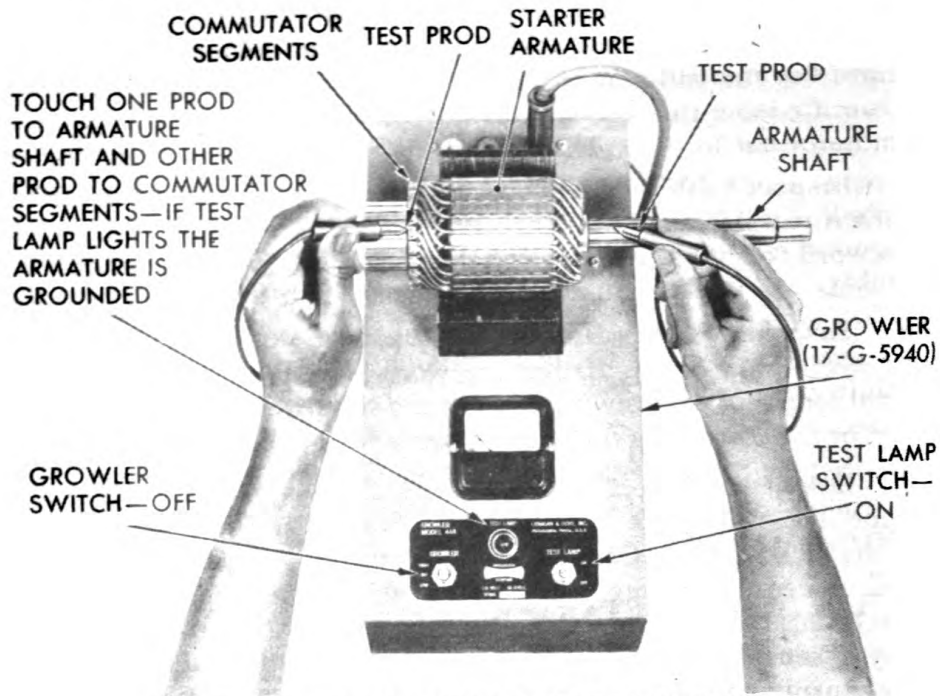

**TESTING STARTER ARMATURE FOR GROUND**

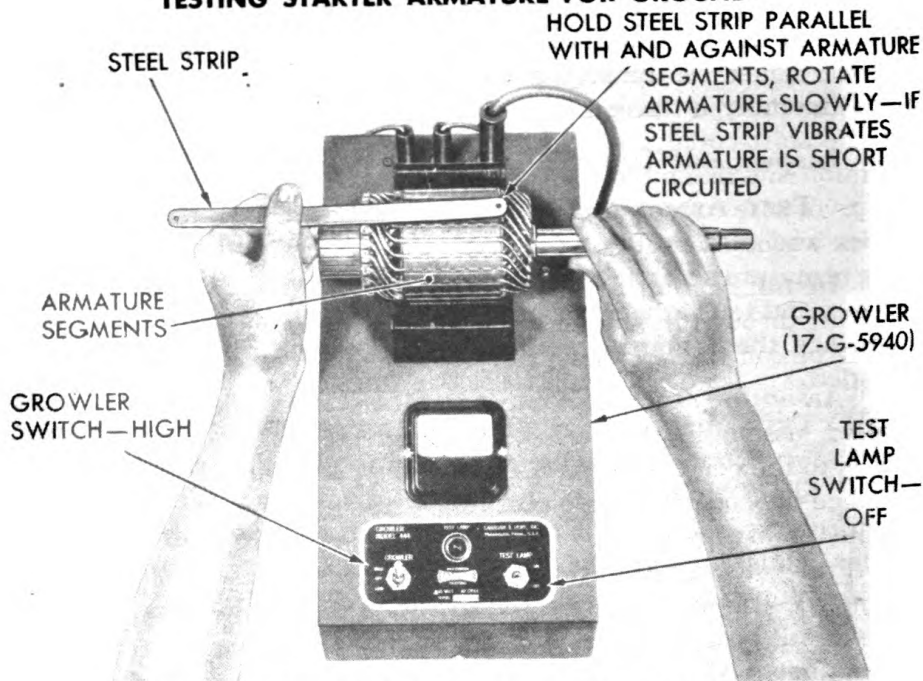

**TESTING STARTER ARMATURE FOR SHORT CIRCUIT**

RA PD 53379

**Figure 169—Starter Armature Test**

## STARTER REBUILDING

**g. Repair Armature.** If an open circuit condition can be located visually, repair the break by soldering the parts together. If the segments of the commutator are worn or scored, or if the commutator is eccentric beyond 0.003 inch, turn down the commutator in the armature turning lathe (40-T-225). *Do not undercut the mica between the commutator bars.*

**h. Inspect Clutch Assembly and Housing.** Replace the pinion housing if it is damaged or cracked. Replace the bushing if it is excessively worn or scored. Replace the shift yoke if the shifting pads or the pivot hole are worn excessively. Replace the clutch assembly if the parts are worn or noisy. Replace the shift spring if distorted or otherwise damaged. Replace the shift collar if excessively worn. Replace the shift yoke pivot screw if excessively worn or the threads are damaged.

**i. Inspect Switch.** Inspect the switch contacts. If the contact blade is only slightly burned, recondition contacts by filing. If burning is excessive, however, replace the switch with a new part.

## 90. ASSEMBLY OF STARTER.

**a. Assemble Clutch Assembly and Install in Pinion Housing.** If a new housing bushing is to be installed, soak the new bushing in engine oil about 15 minutes, and then press the bushing into place. Assemble the shift spring to the clutch assembly and install the shift collar. Compress the collar on the spring and install a new lock ring. Place the clutch assembly in the pinion housing. Fit the shoes of the shift lever over the shift collar with the curved side of the shoes facing toward the pinion and assemble the shift yoke to the housing. Install the shift yoke pivot screw through the yoke and the boss on the housing. Install the lock washer and nut on the pivot screw and tighten the nut.

**b. Install Armature in Housing.** Push the splined end of armature shaft through the clutch assembly and through the thrust washer and the pinion housing bearing.

**c. Assemble Starter Frame Assembly.** If new field coils are to be installed, assemble the coils to the coil connector and solder new brushes to the coil connections. Install the pole pieces in the field coils and place the coil and pole pieces in the frame so the screw holes of the pole pieces line up with the holes in the frame. Then insert the screws to hold the coils in place while installing the terminal post. Install the terminal post fiber washer on the threaded end of the post and install the terminal post insulator. Then install the terminal post insulating bushing and push the post up through the hole in the frame. Fit the field connector into the groove provided for it in the post and solder the connector tightly to the post. Then finish tightening the pole piece screws. Install the starter switch insulating block and switch lower contact over the terminal post and install and tighten the lock washer

**ORDNANCE MAINTENANCE—POWER PLANT, CLUTCH, AND ELECTRICAL SYSTEM— $\frac{3}{4}$  AND  $1\frac{1}{2}$  TON VEHICLES (DODGE)**

and nut on the post to hold the contact securely in position. Stake the nut in place by center punching the nut close to the terminal post.

d. **Install Switch.** Install the switch on the frame over the switch lower contact and fasten in place with the screws and lock washers.

e. **Assemble Frame to Pinion Housing, and Install End Plate.** Slide the frame assembly over the armature and guide the locating pins in the frame flange into the pin hole of the pinion housing. The shift yoke arm will then line up with the switch operating button. If the end plate bearing felt pad was removed, push a new pad through

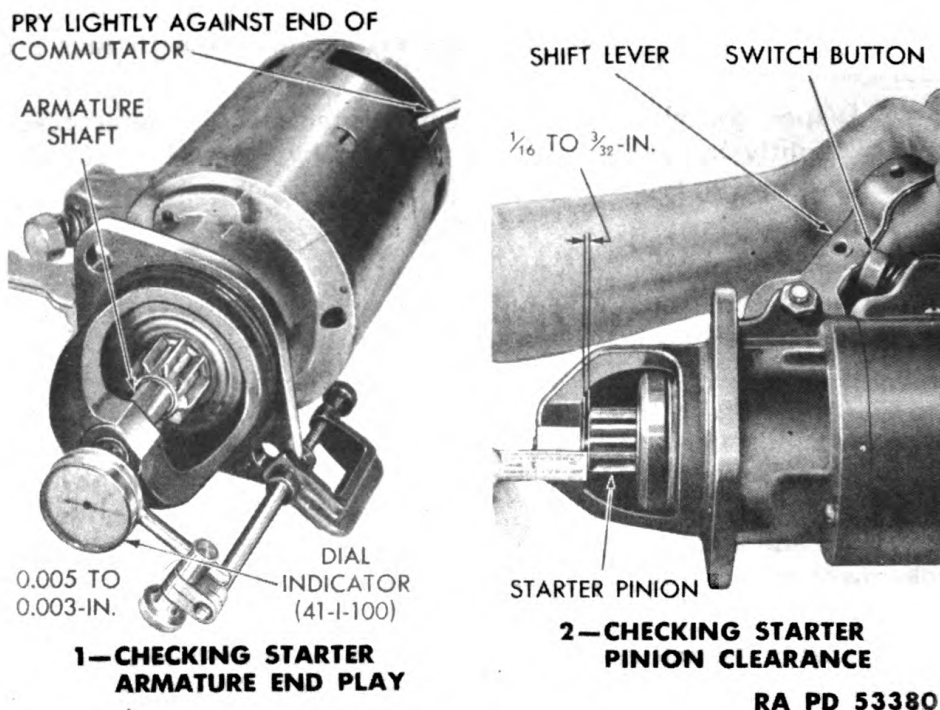

**Figure 170—Checking Starter Armature End Play and Pinion Clearance**

to the back of the bearing. Install the leather washer and then the fiber washer over the commutator end of the armature shaft. Install the commutator end plate and locate the notch of the end plate over the locating pin in the frame flange. Install and tighten the frame through screws with lock washers.

f. **Adjust Armature End Play** (fig. 170, 1). The armature end play is controlled by the end play thrust washer assembled at the commutator end of the armature. These washers are available in 0.015, 0.031 and 0.047-inch thicknesses. Determine the amount of end play with a dial indicator attached to the starter flange. Set the gage button

**STARTER REBUILDING**

against the end of the armature shaft through the pinion housing bearing. Push the armature into the starter as far as it will go and set the dial of the indicator to zero. Then pry lightly against the end of the commutator to force the armature shaft end against the gage as far as it will go, indicating the amount of end play on the dial. If the end play is less than 0.005 inch or more than 0.030 inch, install a new spacer of the proper thickness to obtain proper end play.

**g. Install and Assemble Brushes in Brush Holders.** Lift the two brushes attached to the field coils and slide them into the insulated brush holders. Lift the springs and install the two remaining brushes in their holders and attach the brush terminals to the frame with the attaching screws. Then release the brush springs. Check operation of the brushes in their guides to make sure they slide freely.

**h. Adjust Pinion Clearance (fig. 170, 2).** The amount of forward movement of the starter pinion and clutch assembly is controlled by the switch button which is threaded on the button shaft and locked in the position by means of the tension spring. Push the shift lever against the switch button as far as it will go and measure the clearance between the end of the pinion and the thrust washer. To adjust, screw the starting button in or out to provide a clearance of  $\frac{1}{16}$  inch to  $\frac{3}{32}$  inch. *Do not attempt to make this adjustment unless the starter is removed from the engine so the clearance can be actually measured.* When adjustments are completed, lubricate the bearings with engine oil.

**i. Test Starter on Test Bench.**

(1) **FREE RUNNING TEST.** With starter connected to test bench (17-B-13990), adjust the voltage to 5.5 volts for the 6-volt starter and 11.0 volts for the 12-volt starter. Use the figures in the following chart as a guide to determine whether starter operation is satisfactory.

Free Running Test			
	Volts	Maximum Amperes	Minimum RPM
6-volt System	5.5	65	4900
12-volt System	11.00	30	5300

If the ampere reading is higher than shown in the chart, too much end play exists in the armature shaft or the shaft is binding in the bushings.

(2) **STALL TEST.** With the starter connected to test bench (17-B-13990), adjust the voltage to 2.0 volts for the 6-volt starter or 4.0 volts for the 12-volt starter. Use the figures in the following chart as a guide to determine whether starter operation is satisfactory.

**TM 9-1808A**

90

**ORDNANCE MAINTENANCE—POWER PLANT, CLUTCH, AND ELECTRICAL SYSTEM— $\frac{3}{4}$  AND  $1\frac{1}{2}$  TON VEHICLES (DODGE)**

Stall Test			
	Volts	Maximum Amperes	Minimum Ft-lbs
6-volt System	2	335	6.0
12-volt System	4	175	6.7

There is either a poor contact of the brushes on the commutator or poor connections in the starter if the foot-pounds of torque is too low.

j. **Seat Starter Brushes.** Connect the starter to a battery and run the starter for approximately two minutes to seat the brushes. Then install the head band and tighten the clamp screw.

**CHAPTER 3**  
**ELECTRICAL SYSTEM (Cont'd)**

**Section IV**

**GENERATOR AND REGULATOR REBUILDING**

	Paragraph
Disassembly of generator (6-volt) . . . . .	91
Tests and repair of generator parts (6-volt) . . . . .	92
Assembly of generator (6-volt) . . . . .	93
Disassembly of generator (12-volt) . . . . .	94
Tests and repair of generator parts (12-volt) . . . . .	95
Assembly of generator (12-volt) . . . . .	96
Testing and adjusting generator regulator . . . . .	97
Generator regulator bench repairs . . . . .	98

**91. DISASSEMBLY OF GENERATOR (6-VOLT).**

a. **Remove Head Band and Brushes** (fig. 171). Remove the inspection cover band from the generator. Remove the terminal screws that attach the brush pigtailed to the brush holders. Pull the brush arms away from the brushes and pull the brushes out of the holders.

b. **Remove and Disassemble Commutator End Plate** (fig. 171). Remove the commutator end cover and gasket. Remove the armature bearing retainer screw and retainer. Then remove the frame through screws and drive on the end plate to remove it from the armature shaft. Push the armature shaft ball bearing out of the end plate and remove the felt washer. Pry the loop of the spring out of the notch in the brush holder and slide the brush arm and spring off the brush holder pin.

c. **Remove and Disassemble Drive End Plate** (fig. 171). Pull the armature and end plate assembly out of the frame and field coil assembly. Remove the generator pulley mounting nut cotter pin, nut and washer, and pull the pulley off the armature shaft with puller (41-P-2912). Remove the pulley key from the armature shaft and drive the end plate off the shaft. Remove the felt guard and the felt washer. Then push the bearing out of the end plate and remove the outer felt washer.

d. **Disassemble Frame Assembly.** Remove the nut and lock washer from the terminal post marked ARM. Then remove the plain washer, the large and small fiber washers and pull the post and brush wire together with the post bottom insulation and the insulating bushing. Remove the nut and lock washer from the terminal post marked FLD. Then remove the plain washer, the red warning tag, the fiber



**ORDNANCE MAINTENANCE—POWER PLANT, CLUTCH, AND ELECTRICAL SYSTEM— $\frac{3}{4}$  AND 1 $\frac{1}{2}$  TON VEHICLES (DODGE)**

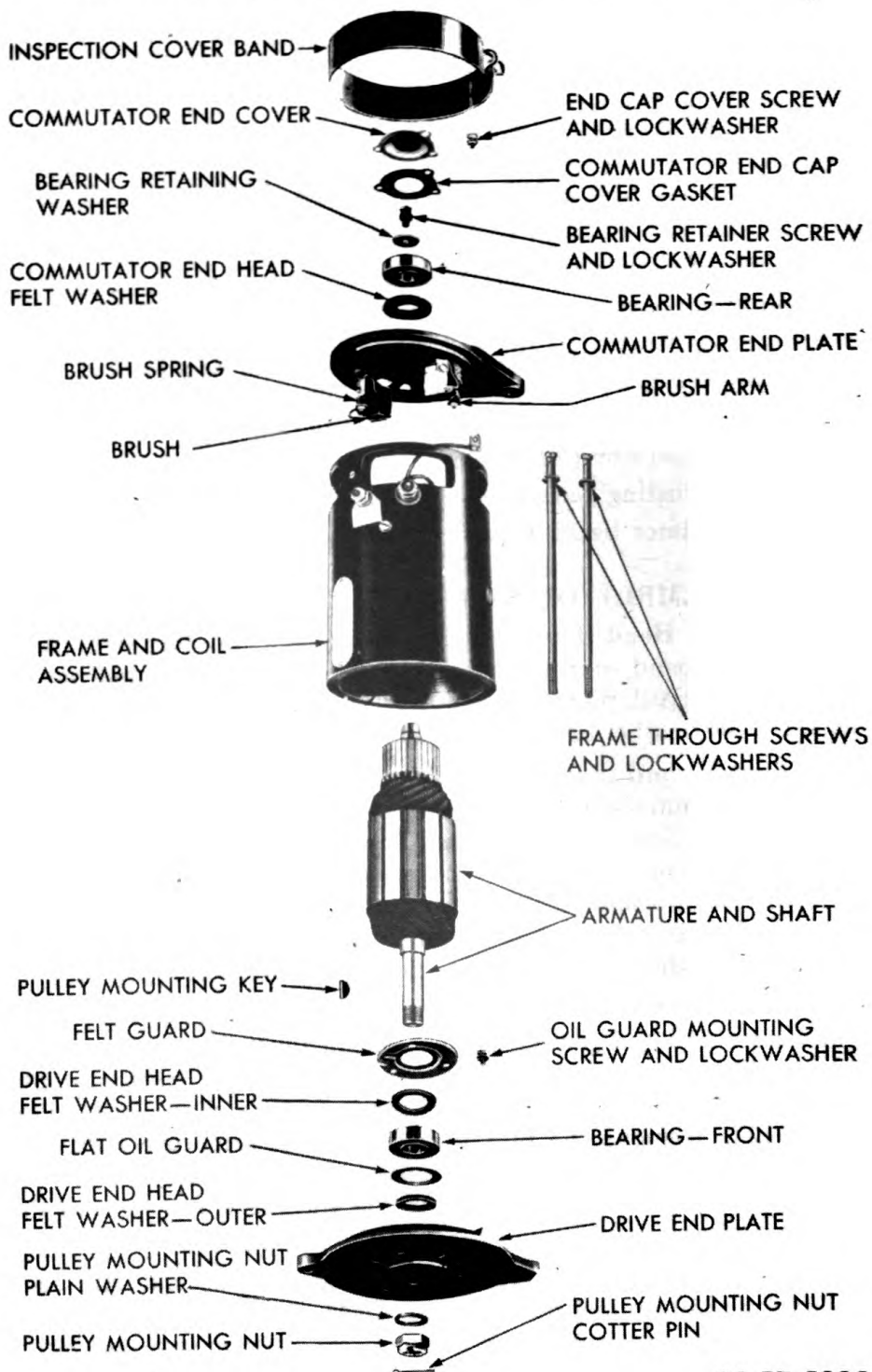

RA PD 53342

**Figure 171—Generator Disassembled (6-Volt)**

### GENERATOR AND REGULATOR REBUILDING

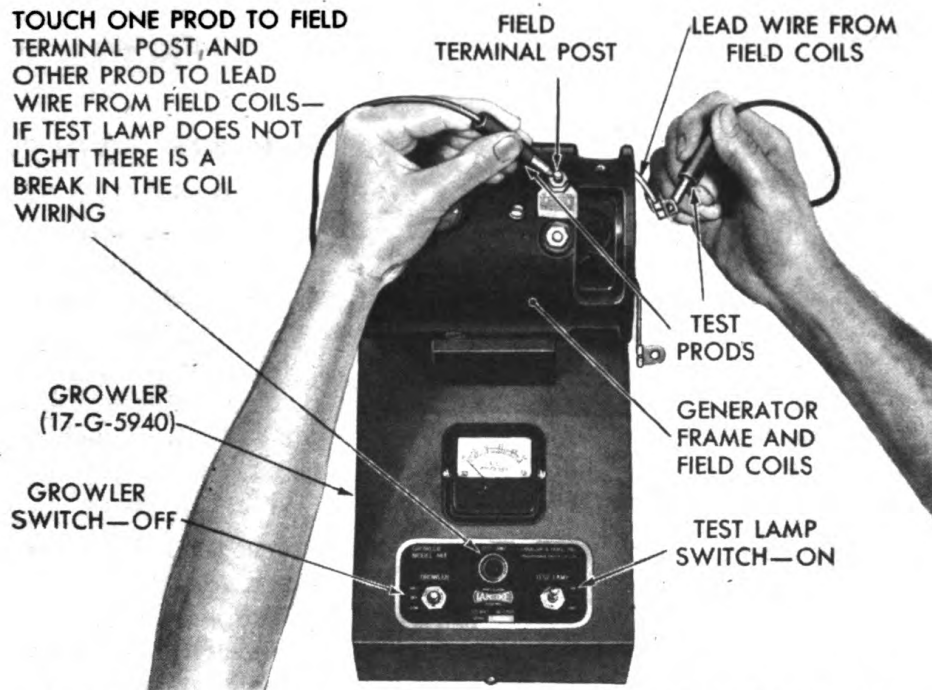

#### 1—TESTING 6-VOLT GENERATOR FIELD COILS FOR OPEN CIRCUIT

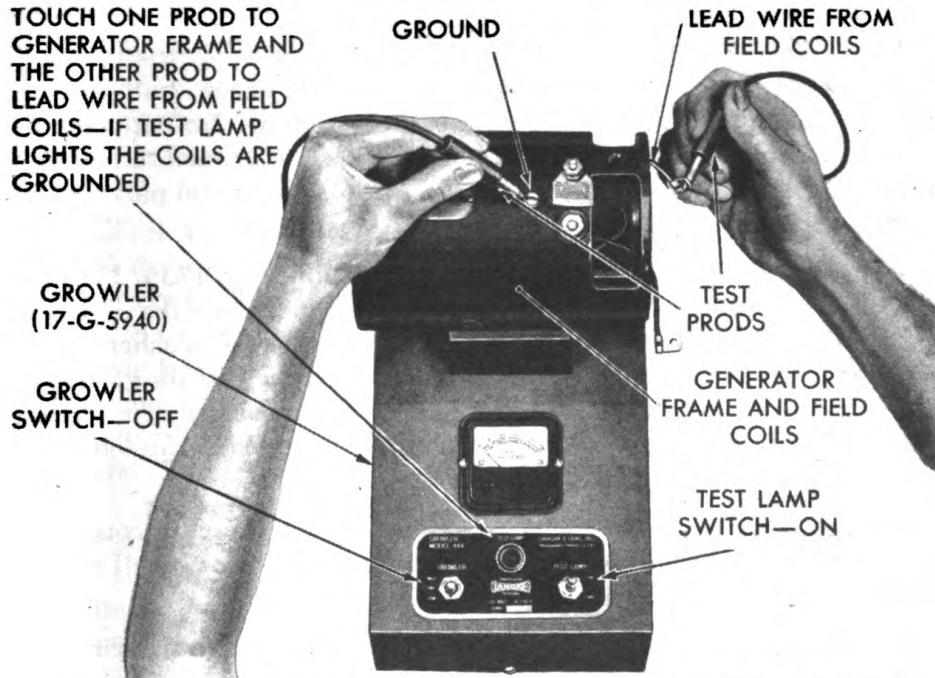

#### 2—TESTING 6-VOLT GENERATOR FIELD COILS FOR GROUND

RA PD 53388

Figure 172—Generator Field Coil Test (6-Volt)

**ORDNANCE MAINTENANCE—POWER PLANT, CLUTCH, AND ELECTRICAL SYSTEM—¾ AND 1½ TON VEHICLES (DODGE)**

washer and remove the post together with the bottom insulation and the insulating bushing. Do not remove field coils until they have been tested (pars. 92 a and b).

**92. TESTS AND REPAIR OF GENERATOR PARTS (6-VOLT).**

a. **Test Field Coils for Open Circuit and Ground (fig. 172).** Test the field coils while they are in the generator frame, to determine whether repair or replacement is required. Disconnect the field ground connection. Touch one prod of a test lamp to this wire and the other to the full terminal post. If the test lamp does not light, test the circuit of each coil separately to determine if there is a poor connection where the coils are joined together. Replace or repair the coil if the test lamp does not light under either test as the coil circuit is open. Touch one prod to the end of the field coil and one end to the generator frame. If the test lamp lights, the coils are grounded.

b. **Test Field Coils for Amperage Draw.** Test the field coils for amperage draw on test bench (17-B-13990). Adjust voltage to 6-volts. If the ammeter reading is not within 1.60 to 1.78 amperes, replace the coils, as they are not satisfactory. To remove field coils, remove the nut from the bolt that attaches and grounds the end of the field coil to the frame and remove the bolt. Remove the screws from the pole pieces and remove the pole pieces. Then remove the field coil connection insulation and slide the coils out of the frame.

c. **Clean Metal Parts.** Wash all metal parts except ball bearings in dry cleaning solvent and dry with compressed air. *Do not wash the bearings, as they are prelubricated with sufficient lubricant to last their normal life.* Do not wash the field coils or other non-metal parts or wiring, but wipe these parts clean with a clean dry rag.

d. **Inspect and Test Commutator End Plate (fig. 173).** Examine the brush holders for misalignment or damage. Replace the end plate assembly if the brush holders are distorted, causing the brushes to bind in the holders, or if the brush holders are grounded. Test for ground by touching one prod of the growler test lamp to the insulated brush holder and the other prod to the end plate casting. If the test lamp lights, the insulated brush holder is grounded to the end plate.

e. **Inspect Brushes.** Inspect the brushes for wear by comparing them with a new brush. If they are worn to less than one-half of their original length, or are oil soaked, replace them.

f. **Inspect Bearings and Seals.** Inspect the ball bearings for roughness or noise, and replace them if they are not satisfactory. *Do not wash the bearings in solvent or similar cleaning fluid, as the bearings are pre-packed with lubricant when manufactured and require no further lubrication.* Replace worn or damaged seals.

**GENERATOR AND REGULATOR REBUILDING**

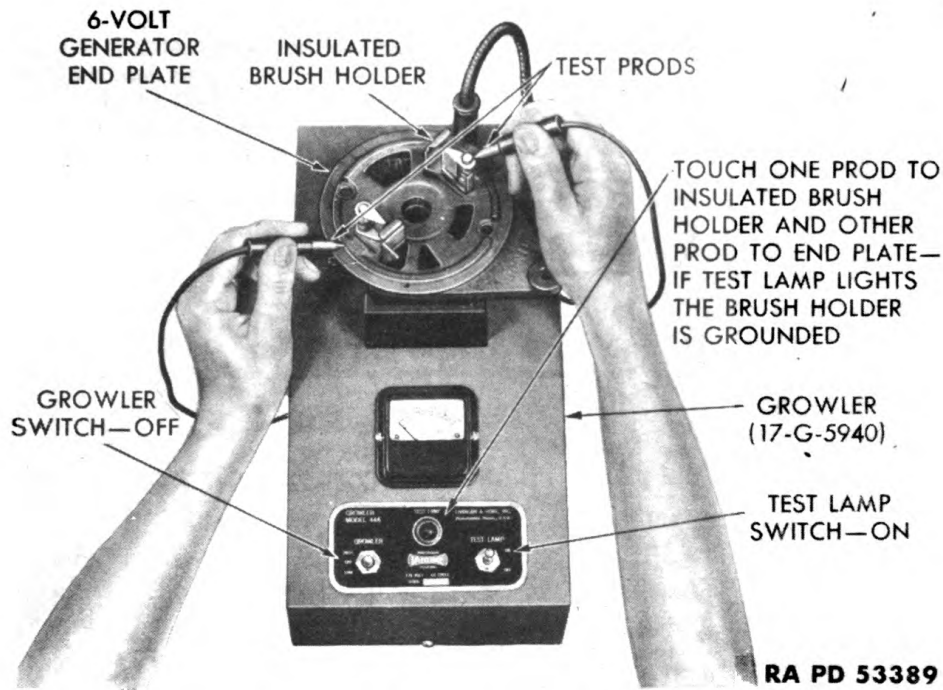

**Figure 173—Insulated Brush Holder Test (6-Volt)**

**g. Inspect Metal Parts.** Examine the frame and end plates for cracks or damage to the machined surface. Replace any parts that are not satisfactory. Examine the fan pulley for cracks in the casting, broken fan blades and irregular conditions in the hub shaft hole or keyway.

**h. Test Armature (fig. 174).** Test the armature for grounded circuit with the test lamp of the growler. Turn off the growler switches and plug the connection into a 110-volt circuit. Turn on the test lamp switch and touch one of the test prods to any part of the armature shaft except the bearing surface. Touch the other test prod to the commutator segments and the core segments. If the test lamp lights, the armature is grounded. If the ground is accessible, repair it; otherwise replace armature. Place the armature in the growler and turn the growler switch to the low position. Hold a thin strip of steel parallel to and against the armature core. Rotate the armature slowly by hand and test all the armature core segments. If the steel strip vibrates at any point, the armature coils are shorted. If the short is accessible, repair it; otherwise replace the armature.

**i. Inspect Armature.** Examine the armature and commutator for visible damage. Repair or replace the armature if the wires of the armature coils are loose at the commutator segments or if the commutator is excessively worn, scored or burned. Suspend the armature on

**ORDNANCE MAINTENANCE—POWER PLANT, CLUTCH, AND ELECTRICAL SYSTEM— $\frac{3}{4}$  AND 1  $\frac{1}{2}$  TON VEHICLES (DODGE)**

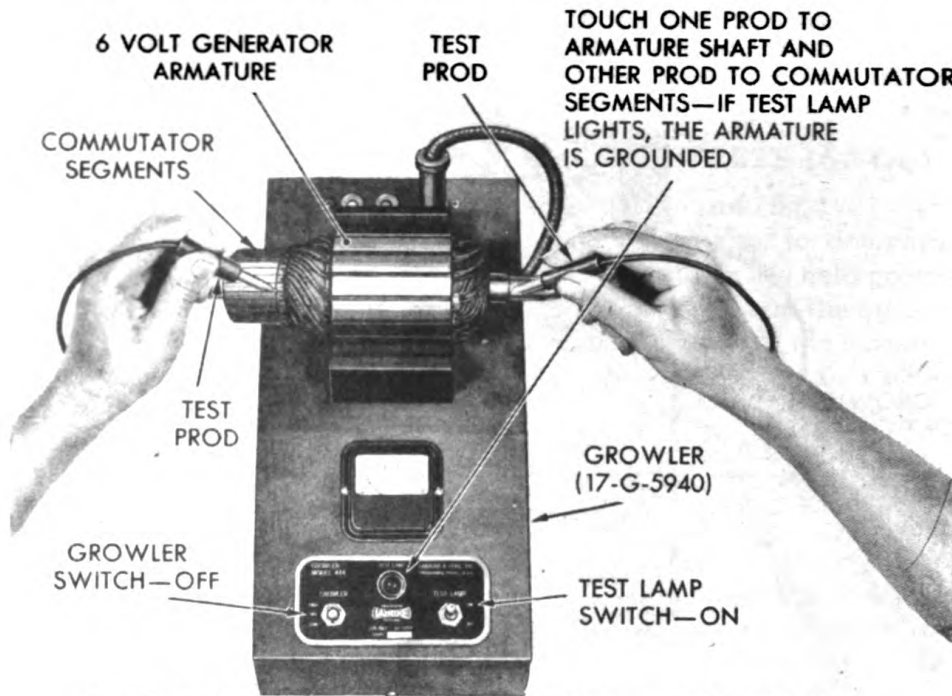

**1—TESTING 6-VOLT GENERATOR ARMATURE FOR GROUND**

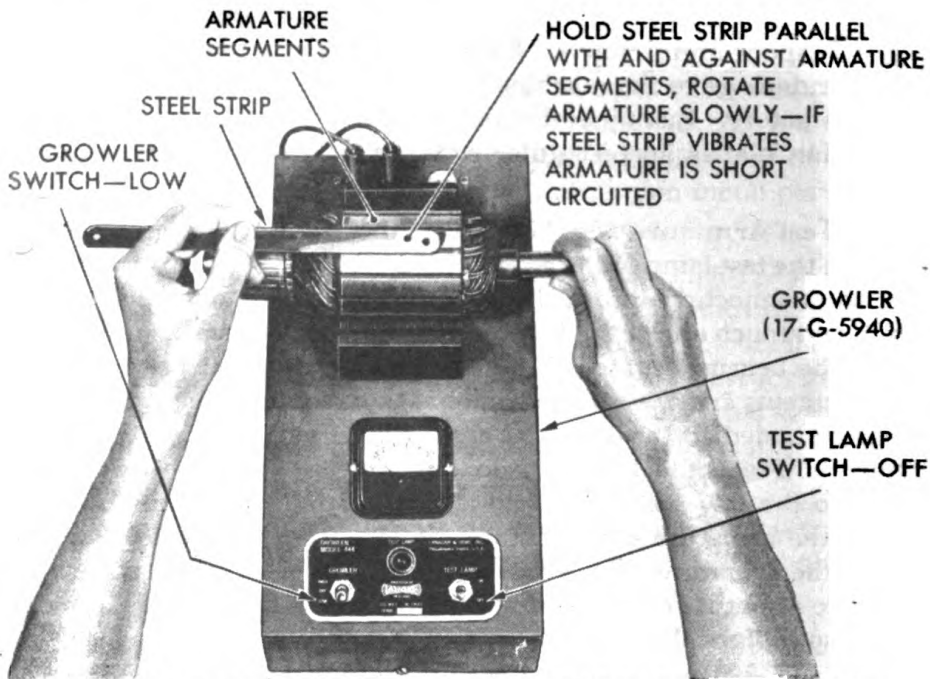

**2—TESTING 6-VOLT GENERATOR ARMATURE FOR SHORT CIRCUIT  
RA PD 53383**

**Figure 174—Generator Armature Test (6-Volt)**

**GENERATOR AND REGULATOR REBUILDING**

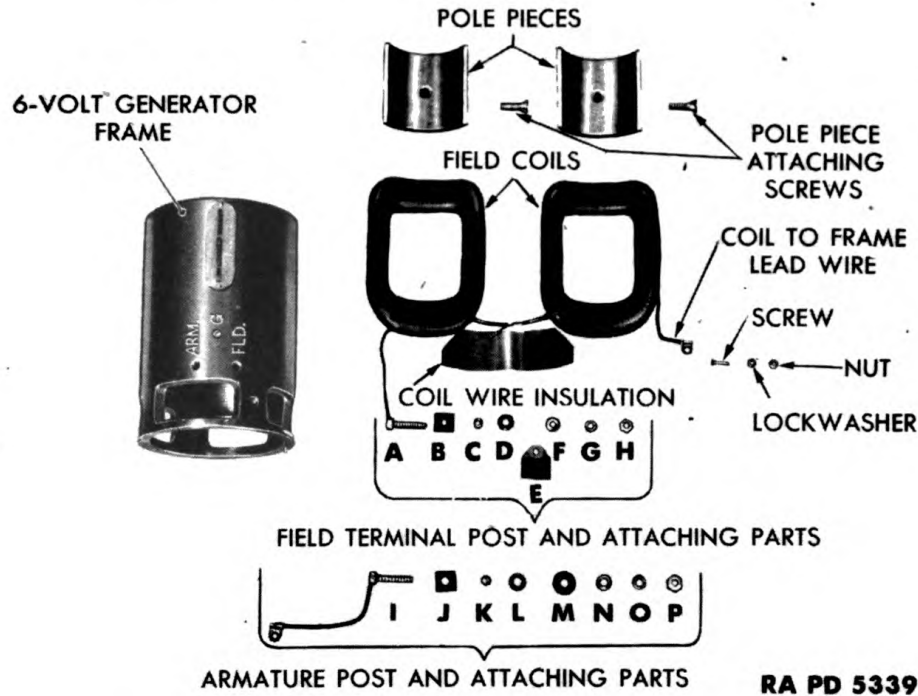

**Figure 175—Generator Frame and Coils (6-Volt)**

its shaft between V-blocks and turn the commutator against the button of a dial indicator to determine the amount of eccentricity in the commutator. Turn down the commutator in a lathe if the eccentricity exceeds 0.0005 inch, or if the segment surfaces are rough or otherwise unsatisfactory. Undercut the mica between the segments of the commutator 1/32 inch below the commutator surface.

**93. ASSEMBLY OF GENERATOR (6-VOLT).**

a. **Assemble Frame Assembly** (fig. 175). Place the pole pieces in the field coils. Then slide the coils into the frame with the terminal wires located at the commutator end of the frame. Line up the screw holes in the pole pieces with the holes in the frame. Insert the screws to hold the pole pieces in position and slide the field connection insulation under the wire that connects the two coils together. As the insulating paper must fit over the frame through screw to insulate the screw from the wire, make the necessary loop in the paper for the screw. Then tighten the pole piece screws securely to hold the insulation in place. Attach the short lead of the field coils to the frame with the screw, lock washer and nut. Install the field terminal post bottom insulation (B) on the field post (A), and install the fiber bushing (C) on the post. Insert the post in the hole marked FLD and install top insulation washer (D), the red warning tag (E), plain washer (F), lock washer

**ORDNANCE MAINTENANCE—POWER PLANT, CLUTCH, AND ELECTRICAL SYSTEM— $\frac{3}{4}$  AND  $1\frac{1}{2}$  TON VEHICLES (DODGE)**

(G) and nut (H). Install the armature terminal post bottom insulation (J) on the armature post (I) and install the fiber bushing (K) on the post. Insert the post and brush connection lead assembly into the frame hole marked ARM. Then install the small insulating washer (L), the large insulating washer (M), the plain washer (N), lock washer (O) and nut (P) on the post.

b. **Assemble Commutator End Plate.** Assemble the brush springs and arms together and slide the assemblies on the pins of the brush holders, seating the spring loops in the notch of the brush holders. Install a new felt washer in the ball bearing recess and push the bearing into the recess. Install the commutator end plate assembly on the commutator end of the armature shaft. Drive the end plate bearing in flush with the end of the armature shaft and install the ball bearing retainer, lock washer and retainer screw. Tighten the screw.

c. **Seat Brushes.** If the armature commutator has been turned down and new brushes installed, seat the brushes to the commutator with sandpaper. Install both brushes in the end plate so the angle of the brush fits the curve of the commutator. Then draw a strip of No. 00 sandpaper between each brush and the commutator to sand the brushes to the curve of the commutator. Sand off just enough of the brushes to secure fitting over their entire bearing surface. Blow all sand out of the assembly thoroughly when the brushes are seated.

d. **Check Brush Spring Tension.** Insert a strip of medium weight paper between one of the brushes and the commutator and attach a spring scale to the brush arm. Pull on the scale at right angles to the arm and note the spring scale reading at the instant the paper can be pulled out. If the reading on the scale is less than 64 ounces or more than 68 ounces, replace the spring or recoil it to secure tension within the specifications. Check the tension of the other spring in the same way. If the tension is less than 64 ounces, remove the spring, clamp the free end in a vise and pull on the spring loop to uncoil the spring slightly. Install the spring and retest. If the tension is too great, pull on the spring loop and spring arm to compress the spring.

e. **Assemble Armature and Commutator End Plate to Frame.** Fit the armature and commutator end plate assembly to the frame so the dowel pin of the frame fits into the dowel pin hole in the end plate casting. Attach the brush pigtail and the long lead wire from the field coil to the insulated brush holder of the end plate. Attach the pigtail of the other brush to its brush holder.

f. **Assemble Drive End Plate and Install on Frame.** Install a new felt washer in the recess for the drive end plate ball bearing. Install the ball bearing, the small felt washer and fasten the oil guard with the three screws assembled with lock washers. Fit the ball bearing over the armature shaft and drive the end plate on the shaft until the dowel pin in the frame fits into the hole in the end plate casting.

**GENERATOR AND REGULATOR REBUILDING**

**g. Install Through Screws and Commutator End Cap Cover.** Install the frame through screws to fasten the end plates on the frame. Make sure the one through screw passes between the insulation and the frame, and that the other screw passes between the field connection wire and the frame. Install the commutator end cap cover with a new end cap cover gasket on the end plate and tighten in place with the screws assembled with lock washers.

**h. Install Generator Pulley.** Install the generator pulley key in the armature shaft and drive the pulley on the shaft. Install the pulley washer and mounting nut, and tighten the nut until the cotter pin can be installed.

**i. Bench Test Generator.** Bench test the generator after it is assembled to insure satisfactory operation. When testing the generator on a test bench (17-B-13990), connect the armature to the field. Run the generator up to the approximate "cut-in" speed of 440 revolutions per minute and connect the battery in the circuit. Adjust the speed so as to obtain 40 to 42 amperes output at 8 volts and then compare the speed which should be within the limits indicated in the accompanying chart. *When operating the generator on the test bench, do not run it at speeds giving a higher output than the maximum 42 amperes for any length of time, as this would cause overheating and possible damage to the armature or the field coils.* After making check of generator output, reduce generator speed to 440 revolutions per minute and disconnect battery connection to prevent heavy discharge of current through the generator. Then reduce the speed to zero.

**6-VOLT GENERATOR OUTPUT (without regulator)**

Amps.	Volts	Maximum rpm
40-42	8	1500-1600 (cold)
40-42	8	1650-1750 (hot)

**94. DISASSEMBLY OF GENERATOR (12-VOLT).**

**a. Remove Inspection Band and Brushes (fig. 176).** Remove the inspection band. Remove the screws that attach the post and field terminals and the brush pigtailed to the brush holders. Pull the brush arms away from the brushes and remove the brushes from the holders.

**b. Remove Commutator End Plate Assembly (fig. 176).** Punch mark the frame and commutator end plate so the parts can be assembled correctly. Remove the commutator end cap cover and gasket. Remove the armature bearing retainer screw and retainer. Then remove the screws that attach the commutator end plate to the frame assembly. Drive on the end plate to remove it from the frame assembly. Remove the armature shaft spacer from the armature shaft.

**c. Disassemble Commutator End Plate (fig. 176).** Push the ball bearing out of the recess in the commutator end plate. Then remove the plain felt washer retainer, the felt washer and the other plain washer



**ORDNANCE MAINTENANCE—POWER PLANT, CLUTCH, AND ELECTRICAL SYSTEM— $\frac{3}{4}$  AND  $1\frac{1}{2}$  TON VEHICLES (DODGE)**

retainer and spring washer. Pry the loop of the spring out of the notch in the brush holder and slide the arm and spring off the brush holder pin.

d. **Remove Drive End Plate** (fig. 176). Punch mark the frame and drive end plate assemblies to aid in correct assembly of the parts. Remove the pulley nut, the lock washer and plain washer. Pull the pulley off the armature shaft with a puller (41-P-2912) and remove the pulley key. Remove the armature snap ring with the snap ring pliers (41-P-1572) and pry the ventilating fan off of the armature shaft. Remove the ventilating fan key from the armature shaft. Remove the screws that attach the drive end plate to the frame and drive the plate off the armature shaft. Remove the armature shaft spacer from the armature shaft.

e. **Disassemble Drive End Plate** (fig. 176). Remove the screws attaching the bearing retainer to the drive end plate and remove the retainer and gasket. Remove the felt washer from the bearing retainer by prying the felt washer retainer out of the bearing retainer. Push the ball bearing out of the end plate recess and remove the felt washer by prying the felt retainer out of the recess.

f. **Disassemble Frame Assembly.** Remove the nut from the terminal post marked A and tap the post out of the frame. Then remove the terminal with the lead wires. Remove the nut from the terminal post marked F, and tap the post out of the frame. Then remove the terminal post insulation. Remove the terminal post insulator bushings from the frame. Do not remove field coils until they have been tested (par. 95 a and b).

**95. TESTS AND REPAIR OF GENERATOR PARTS (12-VOLT)**

a. **Test Field Coils for Open Circuit and Ground** (fig. 177). Test the field coils while they are in the generator frame to determine whether repair or replacement is required. Turn off the switches of the growler and connect the growler to a 110-volt circuit. Turn on the test lamp switch and touch one of the prods to the post marked FLD and touch the other prod to the end of the field coil. If the test lamp does not light, test the circuit of each coil separately to determine if there is a poor connection where each pair of coils is joined together. Repair or replace the coils if the test lamp does not light, as this indicates an open circuit. Touch one prod to the end of the field coil and one prod to the frame. If the test lamp lights, the coils are grounded to the frame.

b. **Test Coils for Amperage Draw.** Test the field coils for amperage draw on test bench (17-B-13990). Adjust the voltage to 13 volts. If the ammeter reading is not within 1.48 amperes to 1.64 amperes, replace the coils as they are not satisfactory. To remove coils, remove the screws from the pole pieces and remove the pole pieces. Then remove the field connection insulation and slide the field coils out of the frame.

c. **Clean Parts.** Wash all metal parts in dry cleaning solvent and dry with compressed air. Do not wash the field coils or other non-metal parts or wiring, but wipe them off with a clean, dry rag.

**GENERATOR AND REGULATOR REBUILDING**

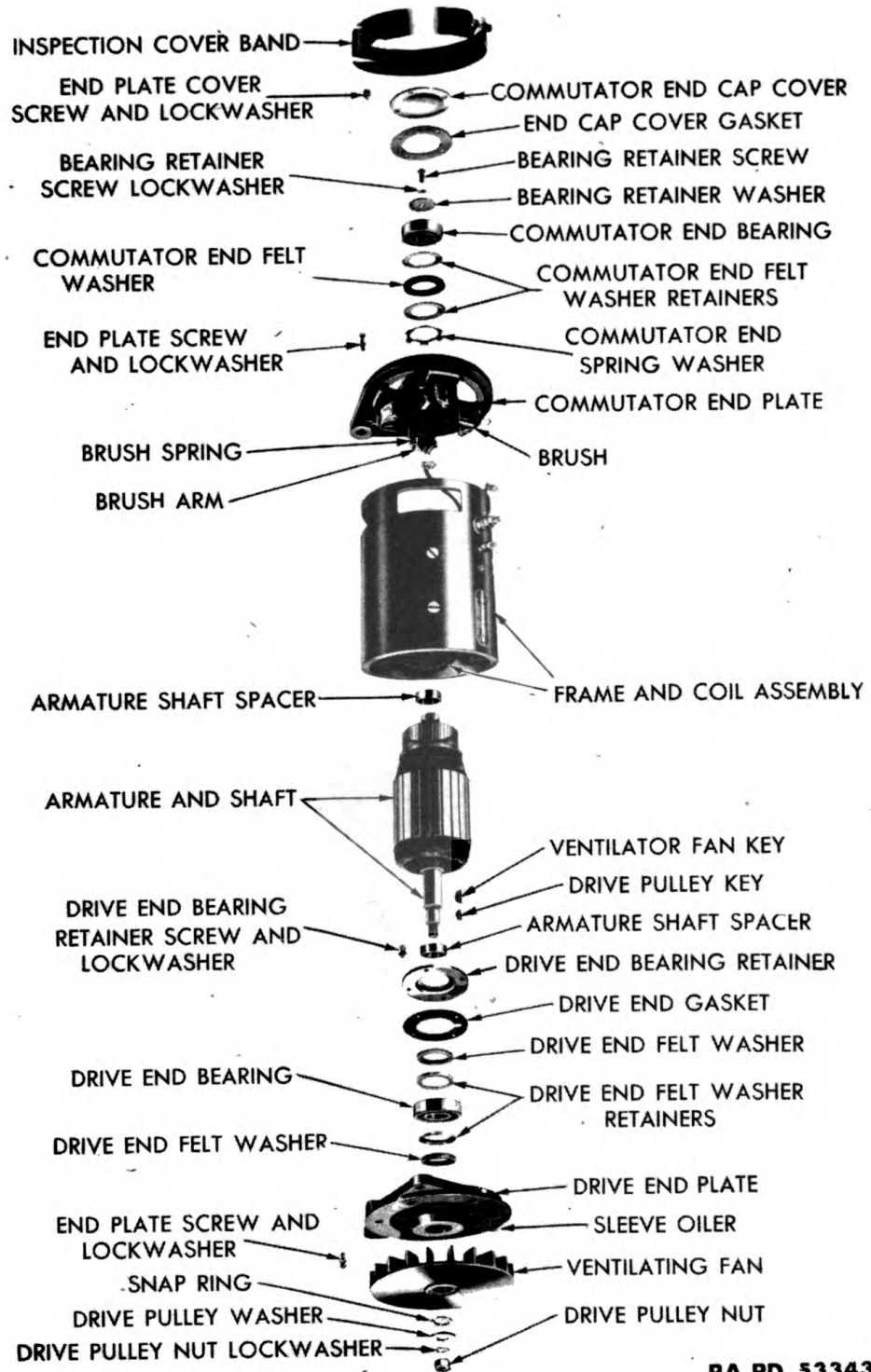

RA PD 53343

**Figure 176—Generator Disassembled (12-Volt)**

**ORDNANCE MAINTENANCE—POWER PLANT, CLUTCH, AND ELECTRICAL SYSTEM— $\frac{3}{4}$  AND 1  $\frac{1}{2}$  TON VEHICLES (DODGE)**

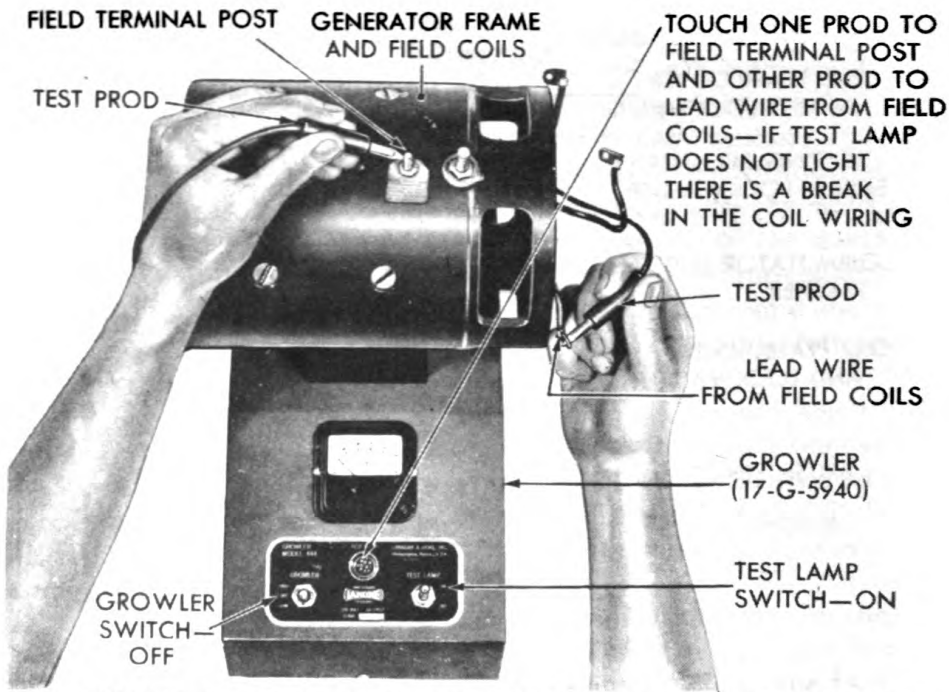

**1—TESTING 12-VOLT GENERATOR FIELD COILS FOR OPEN CIRCUIT**

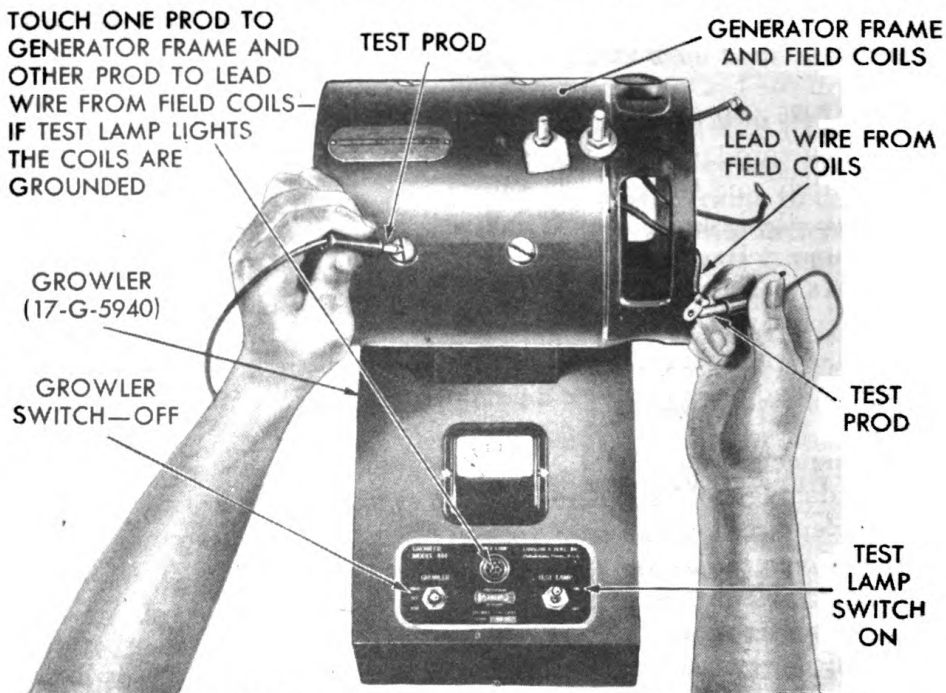

**2—TESTING 12-VOLT GENERATOR FIELD COILS FOR GROUND**

RA PD 53384

**Figure 177—Generator Field Coil Test (12-Volt)**

**GENERATOR AND REGULATOR REBUILDING**

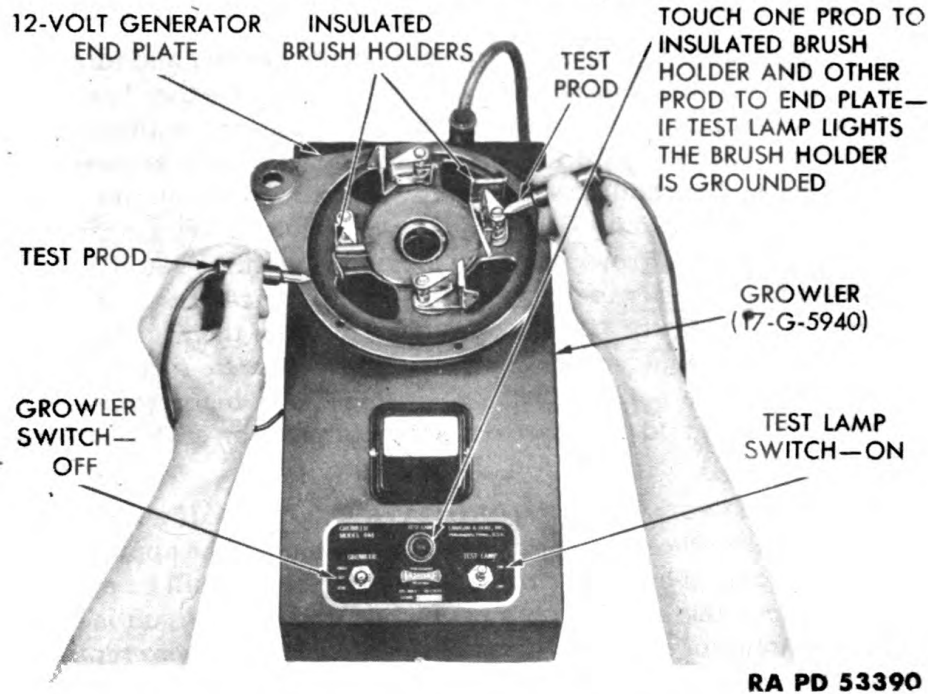

**Figure 178—Insulated Brush Holder Test (12-Volt)**

**d. Test and Inspect Commutator End Plate (fig. 178).** Examine the brush holders for misalignment or damage. Replace the end plate assembly if the brush holders are distorted causing the brushes to bind in the holders or if the brush holders are grounded. Test for ground by touching one prod of the growler test lamp to the insulated brush holders separately and the other prod to the end plate casting. If the test lamp lights, the insulated brush holder is grounded to the end plate.

**e. Inspect Brushes.** Inspect the brushes for wear by comparing them with a new brush. If they are worn to less than one-half of their original length, or are oil soaked, replace them.

**f. Inspect Bearings and Seals.** Inspect the ball bearings for roughness or noise and replace them if they are not satisfactory. Replace all worn or damaged seals.

**g. Inspect Metal Parts.** Examine the frame and end plates for cracks or damage to the machined surfaces and any other irregular conditions. Replace any parts that are not satisfactory. Examine the fan pulley and ventilating fan for cracks in the castings, broken fan blades and irregular conditions in the hub shaft hole or keyway.

**h. Test Armature.**

(1) **EQUIPMENT REQUIRED.** To test the 12-volt generator armature, a growler and an AC voltmeter are required. The voltmeter should have a full scale reading of 2 or 3 volts, and have the leads connected to test prods. *In testing these types of armatures, do not use a steel strip or hack saw blade as in testing other types of armatures.*

**ORDNANCE MAINTENANCE—POWER PLANT, CLUTCH, AND ELECTRICAL SYSTEM— $\frac{3}{4}$  AND 1  $\frac{1}{2}$  TON VEHICLES (DODGE)**

(2) **PROCEDURE.** Place the armature in the growler and turn on the switch. If the growler has a two-position switch for either low or high current value, place the switch in the low position. Adjust the test prods connected to the voltmeter so that they will touch adjacent commutator bars. Touch all the segments around the commutator surface until the highest reading is obtained on the voltmeter. Do not move the armature in the growler while making this test. When the highest voltmeter reading is obtained, note the position of the test prods to the growler. Hold the prods in this position and rotate the armature in the growler. Read the meter for each pair of segments. *Be sure to hold the prods in the same position while the armature is being rotated.* The meter reading should be approximately uniform for each pair of segments tested.

(3) **INTERPRETATION OF VOLTMETER READINGS.** If a short circuit exists in the armature winding, the meter reading will be approximately zero. In the case of an open circuit, the meter reading will be extremely high at the commutator bars between which the open circuit is located. If a short circuit or ground is accessible, repair it; otherwise replace the armature.

i. **Inspect Armature.** Examine the armature and commutator for visible damage. Repair or replace the armature if the wires of the armature coils are loose at the commutator segments or if the commutator is badly worn, scored or burned. Suspend the armature on its shaft between V-blocks and turn the commutator against the button of the dial indicator to determine the amount of the commutator eccentricity. Turn the commutator in a lathe if the eccentricity exceeds 0.0005 inch or if the segment surface is rough or otherwise unsatisfactory. Undercut the mica between the segments of the commutator of the generator armature  $\frac{1}{32}$  inch below the commutator surface.

**96. ASSEMBLY OF GENERATOR (12-VOLT).**

a. **Assemble Frame Assembly** (fig. 179). Place the pole pieces in the field coils. Then slide the coils into the frame with the terminal wires located at the commutator end of the frame. Line up the screw holes in the pole pieces with the holes in the frame. Insert the screws to hold the pole pieces in position and slide the field connection insulation under the wires that connect the field coils together. Then tighten the pole piece screws securely. Place bottom insulation (B) on field terminal post (A), attach the short field coil to terminal post lead to the field terminal post and push the post through the other two bottom insulating pieces (C) and (D). Install the insulating bushing (E) on the post and push post through the hole in the generator frame marked F. Then install the insulating washer (F), the red warning tag (G), the plain washer (H), lock washer (I) and nut (J). Install the lead

**GENERATOR AND REGULATOR REBUILDING**

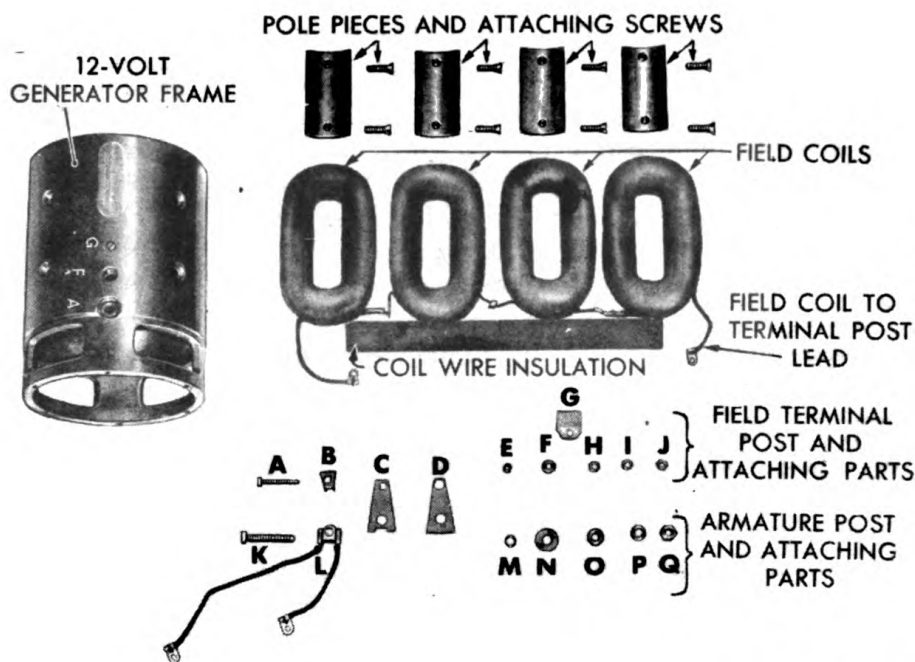

RA PD 53393

**Figure 179—Generator Frame and Coils (12-Volt)**

wires (L) on the armature terminal post (K) and install the insulating bushing (M) on the post. Then insert the post through the terminal post insulations and through the post hole in the frame marked A. Install the insulating washer (N), the plain washer (O), lock washer (P) and nut (Q).

**b. Assemble Commutator End Plate.** Assemble the brush springs and arms together and slide the assemblies on the pins of the brush holders, seating the spring loops in the notch of the brush holders. Install the spring washer and plain retainer with a new felt and plain retainer in the end plate bearing recess. Lubricate the bearing and push it into place in the recess. Install the armature shaft spacer on the armature shaft. Install the commutator end plate assembly on the commutator end of the armature shaft. Drive the end plate bearing in flush with the end of the armature shaft and install the ball bearing retainer, lock washer and retainer screw. Tighten the screw.

**c. Seat Brushes.** If new brushes are to be installed and the armature commutator turned down, seat the brushes to the commutator with sandpaper. Install all of the brushes in the end head so the angle of the brushes fits the curve of the commutator. Then draw a strip of No. 00 sandpaper between each brush and the commutator to sand the brushes to the curve of the commutator. Sand off just enough of the

**ORDNANCE MAINTENANCE—POWER PLANT, CLUTCH, AND ELECTRICAL SYSTEM— $\frac{3}{4}$  AND 1½ TON VEHICLES (DODGE)**

brushes to secure fitting over their entire bearing surface. Blow all sand out of the assembly thoroughly when the brushes are seated.

d. **Check Brush Spring Tension.** Insert a strip of medium weight paper between one of the brushes and the commutator and attach a spring scale to the brush arm. Pull on the scale at right angles to the arm and note the spring scale reading at the instant the paper can be pulled out. If the reading on the scale is less than 71 ounces or more than 76 ounces, replace the spring or recoil it to secure tension within the specifications. If the tension is less than 71 ounces, remove the spring and clamp the free end in a vise, and pull on the spring loop to uncoil the spring slightly. Reinstall the spring and retest. If the tension is too great, pull on the spring loop and the spring arm to compress the spring.

e. **Assemble Armature and Commutator End Plate to Frame.** Fit the armature and commutator end plate assembly to the frame so the punch marks of the frame and head line up. Then install and tighten the screws and lock washers to fasten the end plate to the frame. Connect the long lead from the A terminal post together with the pigtail of the brush, to the insulated brush holder located farthest from the post. Connect the short A post lead together with the brush pigtail to the other insulated brush holder. Connect the lead from the open end of the field coil to the nearest brush holder that is not insulated from the commutator end plate.

f. **Assemble Drive End Plate and Install on Frame.** Install a new felt washer and retainer in the recess of the ball bearing in the drive end plate. Lubricate the ball bearing and tap it into place in the recess. Then assemble a new retainer gasket to the end plate and line up the oilhole relief with the oilhole relief in end plate. Install a new felt and retainer in the bearing retainer and attach the bearing retainer to the end plate. Fit the ball bearing over the armature shaft and drive the end plate assembly on the shaft until the punch marks of the frame lines up with the mark on the end plate. Then install the end plate screws and lock washers.

g. **Install Ventilating Fan and Pulley.** Install the ventilating fan key in the armature shaft keyway and install the fan. Place a new armature snap ring over the end of the armature shaft and drive it on the shaft until it fits into the slot in the armature shaft. Install the fan pulley key in the armature shaft keyway and drive the fan pulley on the shaft. Install the mounting nut plain washer, the lock washer and nut. Tighten the nut securely.

h. **Install Commutator End Cap Cover.** Install the commutator end cap cover with a new gasket, and tighten in place with the screws assembled with lock washers.

i. **Bench Test Generator.** Bench test the generator after it is

**GENERATOR AND REGULATOR REBUILDING**

assembled to insure satisfactory operation. When testing the generator on a test bench (17-B-13990), connect the armature to the field. Run the generator up to the approximate cut in speed of 760 revolutions per minute and connect the battery in the circuit. Adjust the speed so as to obtain 50 to 55 amperes output at 15 volts, and then compare the speed which should be within the limits indicated in the accompanying chart. *When operating the generator on the test bench, do not run it at speeds having a higher output than the maximum 55 amperes for any length of time, as this would cause overheating and possible damage to the armature or the field coils.* After making check of generator output, reduce generator speed to 760 revolutions per minute and disconnect battery to prevent heavy discharge of current through the generator. Then reduce the speed to zero.

**12-VOLT GENERATOR OUTPUT (without regulator)**

Amps.	Volts	Maximum rpm
50-55	15	1050-1150 (cold)
50-55	15	1150-1250 (hot)

**97. TESTING AND ADJUSTING GENERATOR REGULATOR.**

**a. General.**

(1) **REGULATOR SEALS.** The regulator assembly is sealed to indicate that it has had the original factory setting, and to prevent disassembling of the unit except by mechanics authorized to adjust or repair it, because precision gages and meters are required to make accurate adjustments and repairs to the regulator. Do not attempt to adjust the regulator unless the necessary equipment required for electrical tests and measurement of the contact point gaps in the regulator are available.

(2) **PREHEATING REGULATOR.** Before attempting to make adjustments, heat the regulator by operating it for 15 minutes with the generator charging approximately one-half the maximum amperes shown on the name plate of the regulator or generator. While heating the regulator, leave the cover on the unit, because the cover helps to retain the heat.

(3) **REMOVAL AND INSTALLATION OF REGULATOR COVER.** When removing and installing the cover to make the various tests, exercise care to prevent touching the cover on the circuit breaker, causing a short circuit and damaging the regulator assembly. Always install the regulator cover with the name plate down (nearest to regulator terminals). If the cover is installed upside down, the cover may touch the circuit breaker.

(4) **MOUNTING REGULATOR ON TEST BENCH (fig. 180).** When testing or adjusting the regulator, mount it firmly, and in a place where there is no excessive vibration. Test the regulator on a test bench



**ORDNANCE MAINTENANCE—POWER PLANT, CLUTCH, AND ELECTRICAL SYSTEM— $\frac{3}{4}$  AND  $1\frac{1}{2}$  TON VEHICLES (DODGE)**

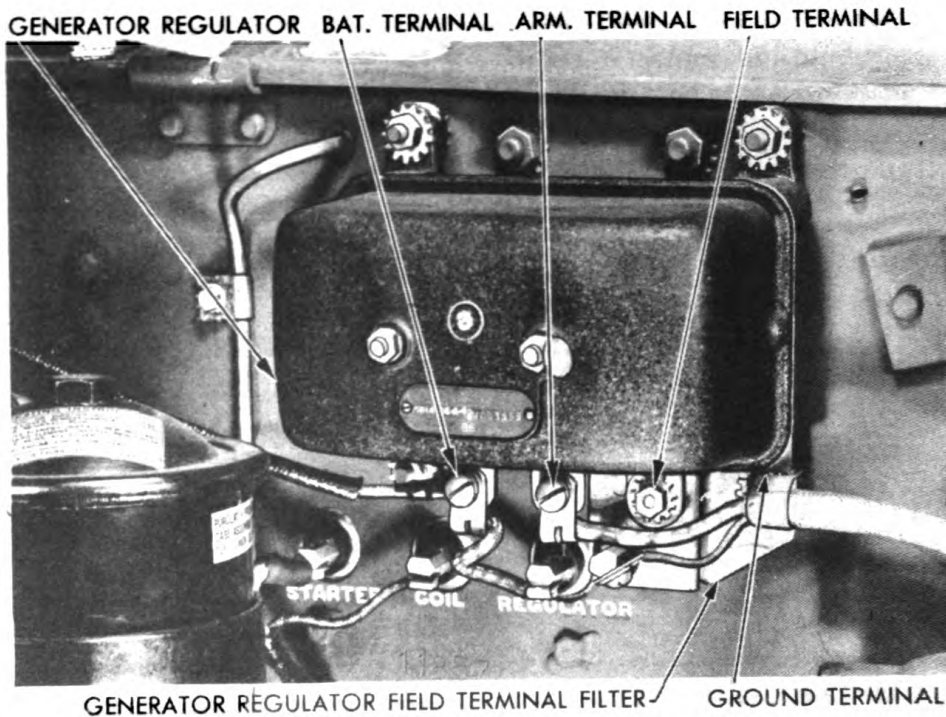

**GENERATOR REGULATOR ON THE VEHICLE**

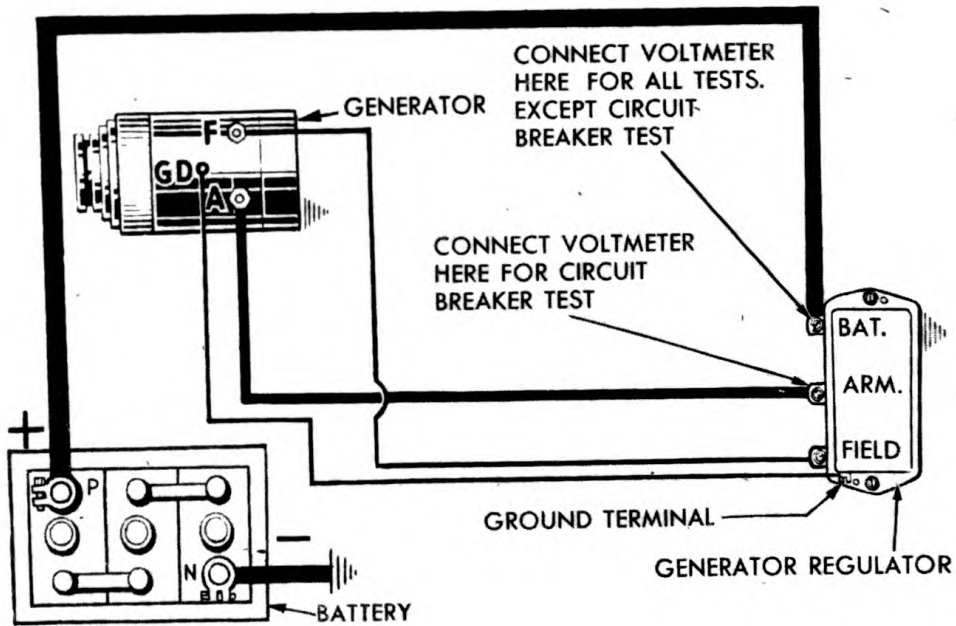

RA PD 53387

**Figure 180—Regulator Test Connections**

**GENERATOR AND REGULATOR REBUILDING**

(17-B-13990) equipped with a motor-driven generator, and a fully charged battery duplicating the operation of the regulator when mounted on the truck. Mount it on the test bench in the same position as it is mounted on the truck. Make connections between generator and regulator as shown in figure 180. When testing the circuit breaker, connect the voltmeter between regulator armature terminal (A) and ground. For all other tests, connect voltmeter between regulator battery terminal (B) and ground.

**b. Clean Contact Points.** As dirty contact points in the regulator constitutes one of the most frequent causes of improper regulator operation, first clean the regulator contact points. Do not use sandpaper or emery cloth to clean the points. Such materials may imbed sand or emery into the point surfaces and prevent normal operation of the regulator. File them parallel with the length of the armature. After filing, clean with a piece of 3/8 inch lintless linen tape wet with carbon tetrachloride. Then draw a piece of clean, dry, lintless linen tape between the contacts to remove any residue that may be on the contact surfaces. After cleaning the points, test and adjust the regulator. If the tests indicate improper functioning of the regulator, make repairs outlined in paragraph 98.

**c. Test and Adjust Circuit Breaker (fig. 181).** The circuit breaker unit must operate within the following limits:

	6-volt	12-volt
Contact closing voltage . . . . .	6.4 to 6.6	13.0 to 13.5
Contact opening amperage (amperes discharge) . . . . .	0.5 to 6.0	0.5 to 6.0

To adjust the contact closing voltage, remove the cover and adjust the armature spring tension by adjusting the screw which holds the lower end of the spring. To adjust the contact opening amperage, adjust the contact point gap by raising or lowering the stationary contacts. After adjusting, install the regulator cover and again test the circuit breaker operation. There should always be at least 0.5 volts less voltage at which the circuit breaker closes than the voltage at which the voltage regulator operates.

**d. Test and Adjust Voltage Regulator (fig. 181).** At normal room temperature, the voltage regulator unit must operate within the following limits:

	6-volt	12-volt
Operating voltage . . . . .	7.2 to 7.5	14.0 to 14.5

In hot climates (consistently above 95 F), the voltage regulator may be set at a lower limit. For example, at a temperature of 120 F, the regulator may be set at 7.1 volts (6-volt systems) or 13.9 volts (12-volt systems). Refer to paragraph 86 c (3) for battery electrolyte specifications. However, there must always be at least 0.5 volt more voltage at which the regulator unit operates than the voltage at which the circuit

**ORDNANCE MAINTENANCE—POWER PLANT, CLUTCH, AND ELECTRICAL SYSTEM— $\frac{3}{4}$  AND 1 $\frac{1}{2}$  TON VEHICLES (DODGE)**

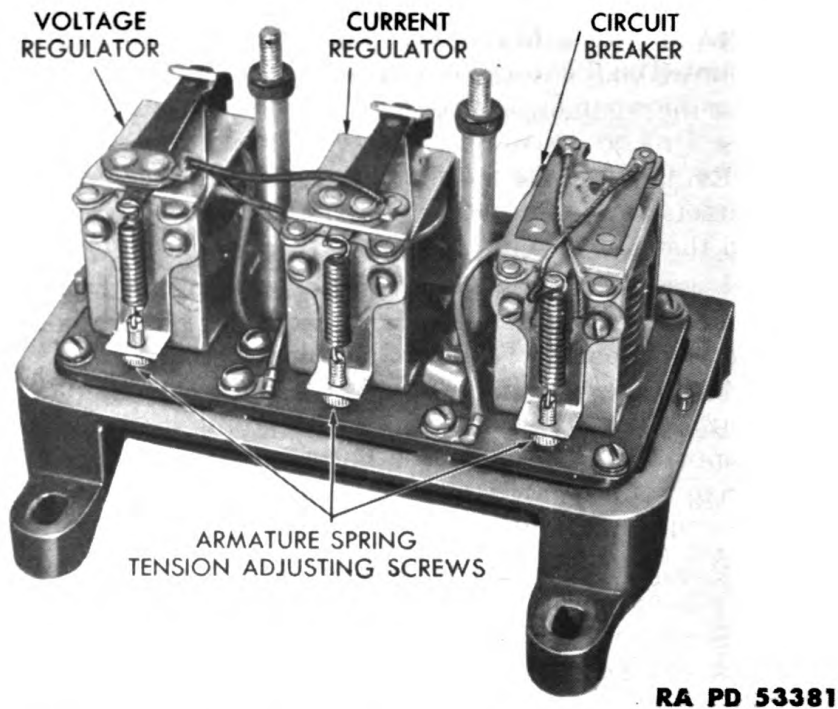

**Figure 181—Generator Regulator Adjusting Screws**

breaker closes (par. 97 c). To adjust the voltage regulator, increase or decrease armature spring tension. Increasing the spring tension increases the voltage at which the unit will operate, while decreasing the tension decreases its operating voltage. This is done by adjusting the screw which holds the lower end of the spring. Replace the cover after making each adjustment to maintain heat and take a final reading.

e. **Test and Adjust Current Regulator** (fig. 181). The current regulator must operate within the following limits:

	6-volt	12-volt
Operating amperage . . . . .	40 to 42	54 to 56

The operation of the current regulator is adjusted by varying the armature spring tension. This is done by turning the adjustment screw which holds the lower end of the spring. After all adjustments are made, make a final test of all three units of the regulator to make sure that the adjustments are within specifications.

**98. GENERATOR REGULATOR BENCH REPAIRS.**

a. **General.** The regulator may be tested and repaired by mechanics thoroughly trained in the servicing of electrical equipment with precision meters and gages. Do not attempt to repair the regulator unless the proper tool equipment is available, because accurate

**GENERATOR AND REGULATOR REBUILDING**

adjustments of regulator air gaps, contact point gap and spring tension are very important.

**b. Visual Inspection.** After removing the cover of the regulator and before making any tests or adjustments, make a close visual inspection of the regulator, with special emphasis being paid to the following points:

- (1) Evidence of burning or abnormal high temperature at the coils, contacts, insulation, external terminals or any other point. It is suggested that this test be made with a magnifying glass.
- (2) Loose connections which result from poor soldering.
- (3) Loose nuts on the bottom of the magnet cores, loose rivets or screws. All nuts and screws must have lock washers.
- (4) Misalignment of contacts.
- (5) Bent armature either at the contact or hinge end. (The armature should be perfectly straight from one end to the other.)
- (6) Magnet yoke bent.
- (7) Bent armature hinges.
- (8) Reversed bimetal hinges on the circuit breaker unit. (When correctly installed the brass side is up.)
- (9) Stripped or crossed threads on any screw or nut.
- (10) Corrosion due to salt or acids.
- (11) Evidence of water having been inside of cover.
- (12) Incorrect, bent or distorted armature spring. If in doubt, replace the spring.
- (13) Broken or altered carbon resistors.
- (14) Broken gaskets.
- (15) Incorrect wiring connections between units.
- (16) Shunt leads and terminal on circuit breaker armature must be free and not interfere with armature movement or touch tension spring.
- (17) **IMPORTANT:** When disassembling a regulator, watch closely the locations of all insulators and assemble them in their proper position.

**c. Clean Contact Points** (par. 97 b).

**d. Check Carbon Resistors** (fig. 182). Test the resistance of the carbon resistors with an accurate ohmmeter. These resistors are located on the under side of the regulator base. Remove the resistors one at a time, and tag or mark each one to avoid any interchanging. The resistance of each carbon resistor is as follows:

	6-volt	12-volt
Resistor marked 80 . . . . .	76 to 84 ohms	76 to 84 ohms
Resistor marked 7 . . . . .	6.5 to 7.5 ohms	. . . . .
Resistor marked 15 . . . . .	. . . . .	13.5 to 16.5 ohms
Resistor marked 30 . . . . .	. . . . .	28 to 32 ohms
Resistor marked 1 . . . . .	. . . . .	0.9 to 1.1 ohms

Generated on 2016-06-23 18:37 GMT / http://hdl.handle.net/2027/uc1.b3243992  
Public Domain, Google-digitized / http://www.hathitrust.org/access\_use#pd-google

ORDNANCE MAINTENANCE—POWER PLANT, CLUTCH, AND ELECTRICAL SYSTEM— $\frac{3}{4}$  AND 1 $\frac{1}{2}$  TON VEHICLES (DODGE)

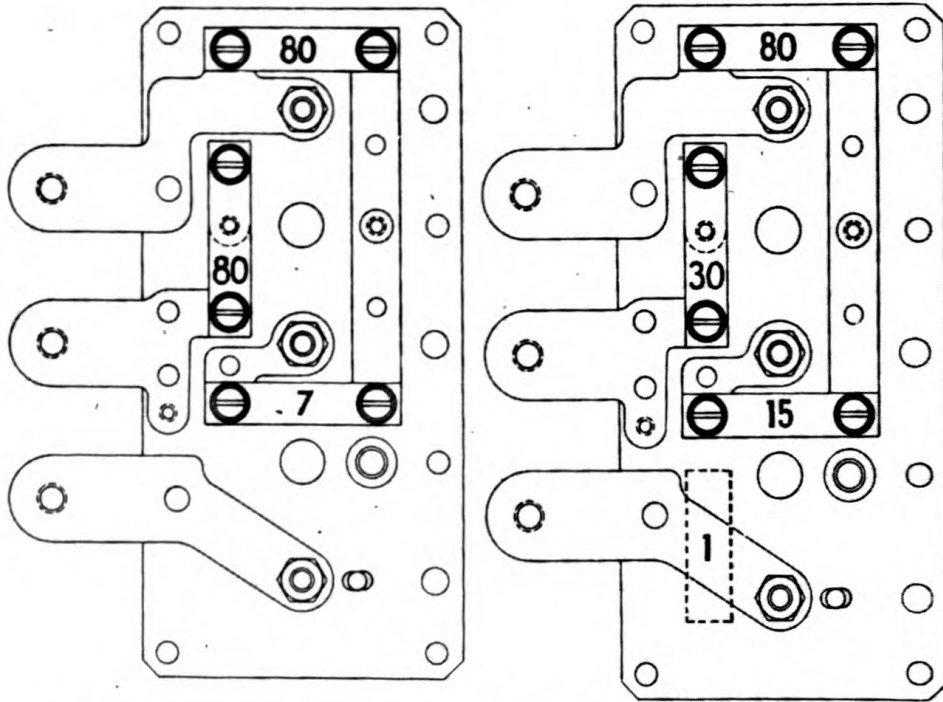

CARBON RESISTORS (6-VOLT)

CARBON RESISTORS (12-VOLT)

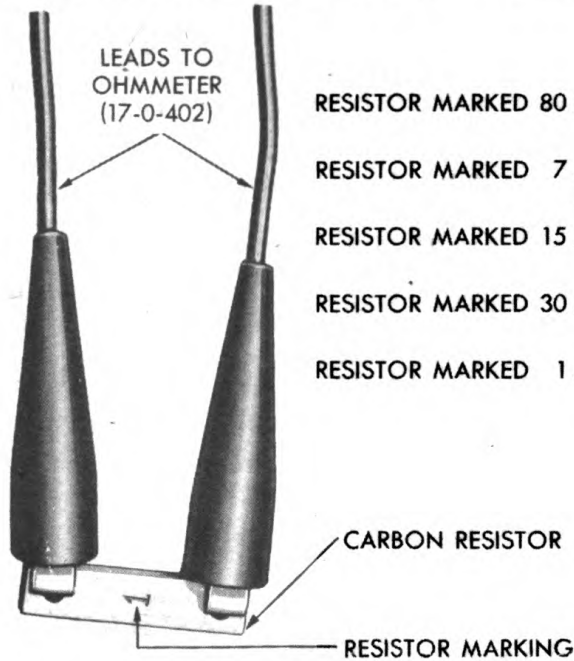

- RESISTOR MARKED 80 . . . . . 76 TO 84 OHMS.
- RESISTOR MARKED 7 . . . . . 6.5 TO 7.5 OHMS.
- RESISTOR MARKED 15 . . . . . 13.5 TO 16.5 OHMS.
- RESISTOR MARKED 30 . . . . . 28 TO 32 OHMS.
- RESISTOR MARKED 1 . . . . . 0.9 TO 1.1 OHMS.

RA PD 53394

Figure 182—Carbon Resistor Test

**GENERATOR AND REGULATOR REBUILDING**

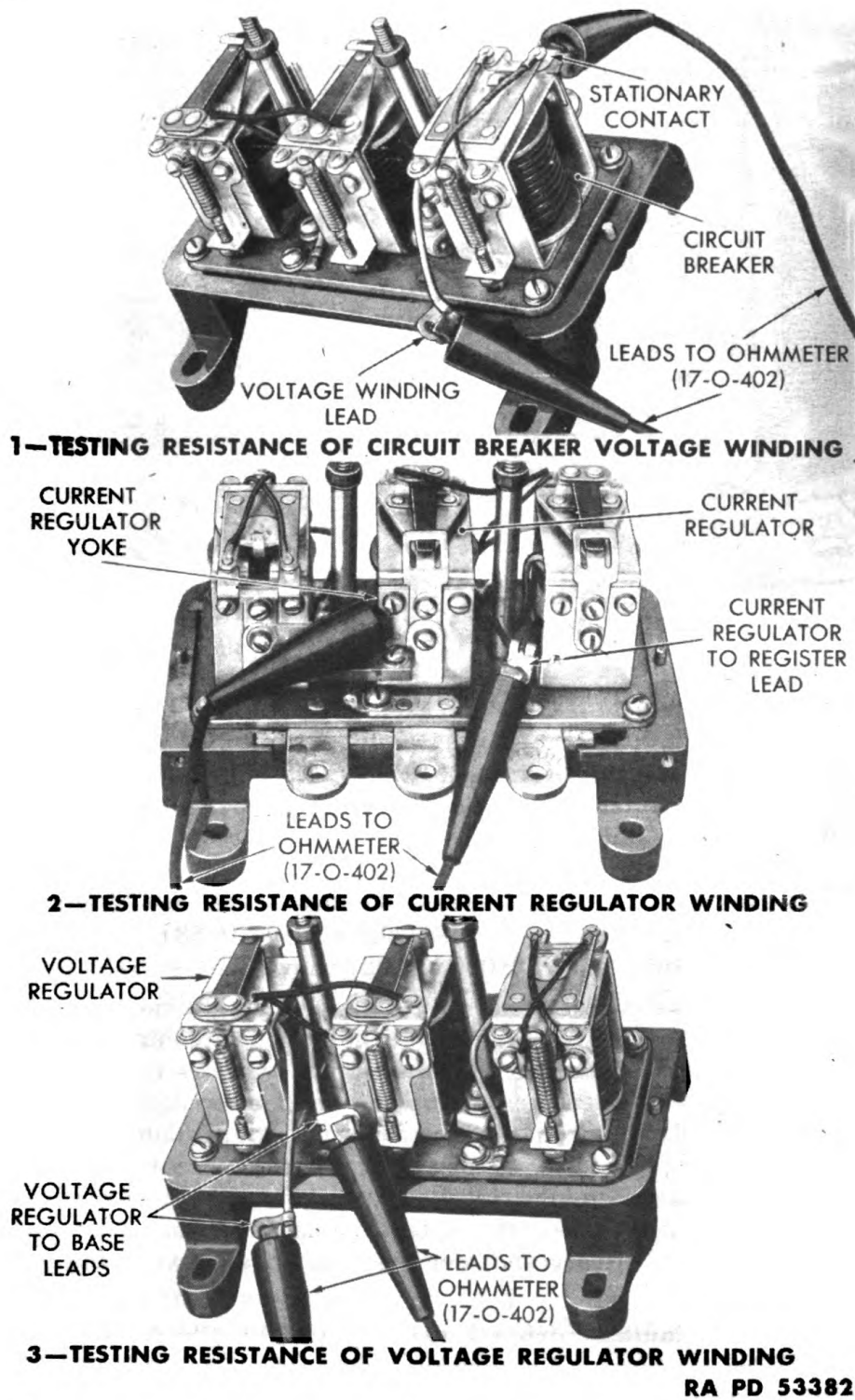

**Figure 183—Voltage Winding Test**

**ORDNANCE MAINTENANCE—POWER PLANT, CLUTCH, AND ELECTRICAL SYSTEM— $\frac{3}{4}$  AND  $1\frac{1}{2}$  TON VEHICLES (DODGE)**

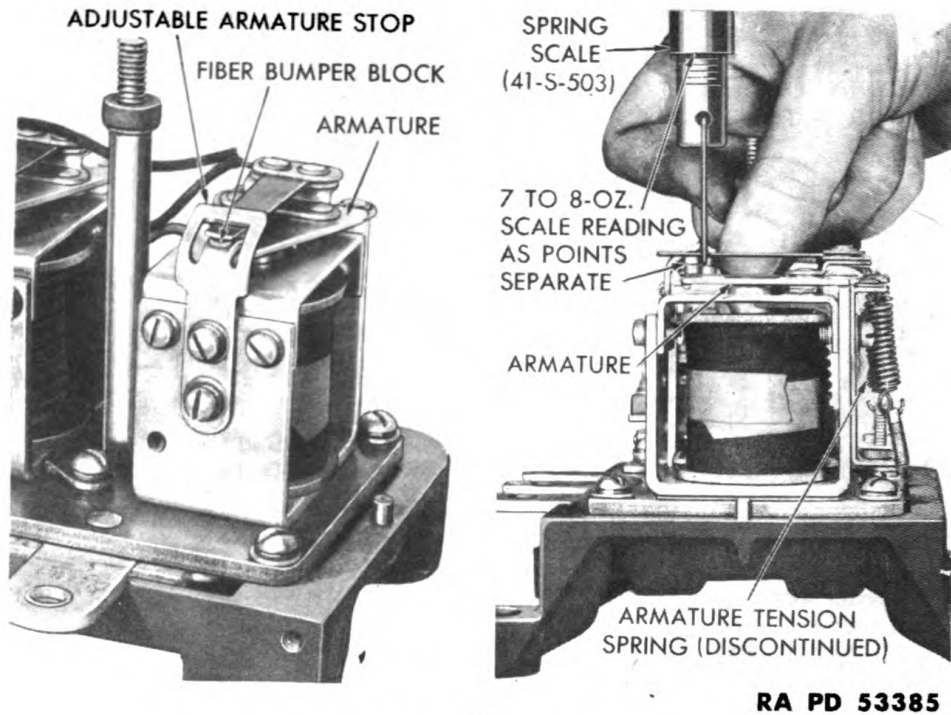

**Figure 184—Checking Contact Spring Tension**

e. **Test Voltage Windings** (fig. 183). Test for resistance in the windings of the circuit breaker, current regulator and voltage regulator. Tolerances are as follows:

	6-volt	12-volt
Circuit breaker.....	15.8 to 17.4 ohms	43.7 to 48.3 ohms
Voltage regulator.....	4.3 to 4.7 ohms	15.68 to 17.32 ohms
Current regulator.....	0.033 to 0.037 ohms	....

Disconnect the circuit breaker voltage winding ground connection and measure resistance from the lead to the stationary contact (fig. 183, 1). Next, disconnect the lead from the current regulator to the resistor in the sub-base between the current and voltage regulator units and measure the resistance from this lead to the current regulator yoke (fig. 183, 2). (Only one coarse winding is used in the current regulator of the 12-volt regulator and the resistance does not need to be measured). Then check the resistance of the voltage regulator winding. Disconnect both leads from the base and measure resistance between the leads (fig. 183, 3).

f. **Check Contact Spring Tension** (fig. 184). Check the current and voltage regulator contact spring tension to see that it is within specifications (7 to 8 oz for both 6- and 12-volt regulators). Disconnect the spiral spring from the armature and remove the adjustable

**GENERATOR AND REGULATOR REBUILDING**

CIRCUIT BREAKER ARMATURE  
 AIR-GAP—0.0595 TO 0.0625-IN.  
 VOLTAGE REGULATOR ARMATURE  
 AIR GAP—0.040 TO 0.042-IN.  
 CURRENT REGULATOR ARMATURE  
 AIR GAP—0.047 TO 0.049-IN.

CONTACT POINT GAP  
 CIRCUIT BREAKER—0.025-IN. (MIN.)  
 CURRENT AND VOLTAGE  
 REGULATOR—0.010-IN. (MIN.)  
 CONTACT POINTS ARMATURE—

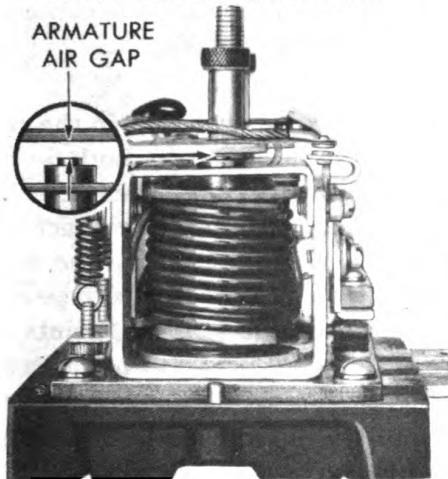

**1—CHECKING ARMATURE AIR GAP**

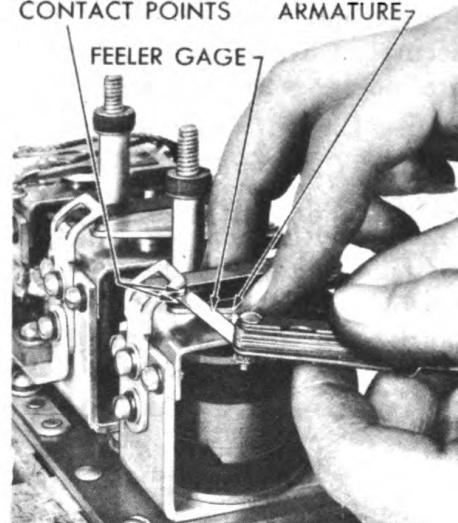

**2—CHECKING CONTACT POINT GAPS RA PD 53386**

**Figure 185—Checking Regulator Air Gaps and Contact Points**

armature stop. Hold the armature firmly and take a reading with spring scale just as the points separate. When assembling the armature stop, make sure that the fiber bumper block is in place.

g. **Check Armature Air Gaps** (fig. 185, 1). Check the armature air gap of all three units of the regulator assembly. Air gap specifications are as follows:

	6-volt and 12-volt
Circuit breaker . . . . .	0.0595 to 0.0625 in.
Voltage regulator . . . . .	0.040 to 0.042 in.
Current regulator . . . . .	0.047 to 0.049 in.

(1) **CIRCUIT BREAKER** (fig. 185, 1). Check the circuit breaker armature air gap with the points open. Use pin gage (41-G-507) inserted on the point side of the brass pin in the core. Adjust by raising or lowering the stop at the point end of the armature.

(2) **CURRENT AND VOLTAGE REGULATOR** (fig. 185, 1). Use pin gage to check armature air gap of both the current and voltage regulator with the points just breaking. Take the measurement on the point side of the brass armature stop pin.

(3) **TEST ADJUSTMENT.** To test, connect a test lamp in series with A and F terminals and a battery. With the low limit pin gage (41-G-507) in place, depress the armature, and the light should go out or be noticeably dimmed. With the high limit pin in place the lamp should



**ORDNANCE MAINTENANCE—POWER PLANT, CLUTCH, AND ELECTRICAL SYSTEM— $\frac{3}{4}$  AND 1 $\frac{1}{2}$  TON VEHICLES (DODGE)**

stay lighted. Use two fingers to depress the armature, one on either side of the contact spring, so that the contact spring is not touched. Do not apply pressure near the center of the armature. To adjust, loosen the screws and raise or lower the armature stop. Tighten the screws securely. Check to see that the springs upon which the movable contacts are mounted are straight and parallel with the armature.

**h. Check Contact Point Gap (fig. 185, 2).**

(1) **CIRCUIT BREAKER.** Check gap of the contact points in the circuit breaker. This gap should be 0.025 inch (minimum) for both 6-volt and 12-volt regulators. The gap will possibly be more than this in actual adjustment, but should not be wide enough to fail to contact before armature reaches its limit of travel. Adjust by bending the supporting arms of the stationary contact point, being sure that both points are in perfect alinement, and that contact is made on both points at the same time. Use a straightedge across the top of the point brackets to check their alinement.

(2) **CURRENT AND VOLTAGE REGULATOR.** Check point gap of both the current and voltage regulator with the armature against the stop pin. The gap should be 0.010 inch (minimum) for both 6- and 12-volt regulators. Hold the armature down with two fingers as shown in figure 185, and do not touch the contact spring. If the voltage regulator contact point gap is too small, see that the bridge carrying the nickel-iron shunt has been pushed down in assembly. The tolerance of 0.010 inch (minimum) is approximate only; too much variation indicates wrong length to armature stop pin, and a new unit will be needed.

**i. Reassemble Regulator.** When all the preceding checks and adjustments have been completed, reconnect all leads which have been disconnected either by the removal of a screw or by unsoldering. Where resoldering is necessary, see that a good clean contact is made. Do not use acid for soldering flux. When completely assembled test and adjust the regulator (par. 97).

**CHAPTER 3**  
**ELECTRICAL SYSTEM (Cont'd)**

**Section V**

**IGNITION DISTRIBUTOR REBUILDING**

	Paragraph
Disassembly of distributor . . . . .	99
Inspection and repair of distributor parts . . . . .	100
Assembly of distributor . . . . .	101

**99. DISASSEMBLY OF DISTRIBUTOR.**

a. **Remove Distributor Cap, Rotor and Breaker Plate (fig. 187).** Remove the cap and pull the rotor straight off the drive shaft. If distributor is equipped with radio filter, disconnect the filter strap from the breaker plate. Remove two screws which hold the breaker plate to the distributor base and lift the breaker plate assembly out of the distributor base.

b. **Remove Breaker Points and Condenser (fig. 187).** Remove the screw and clip which connects the condenser lead wire and the breaker arm spring to the breaker plate and lift the breaker arm off its pivot post. Remove the lock screw from the breaker point bracket and lift the bracket off the pivot post. Remove the condenser mounting screw and the condenser.

c. **Remove Breaker and Stop Plate Cam and Check Drive Shaft Bushing Wear (figs. 186 and 187).** Remove felt wick from top of cam, spread and remove lock spring ring which holds the stop plate cam to the drive shaft and lift the stop plate cam and thrust washer off the shaft. Clamp the distributor in the holding jig and clamp the jig in a vise. Do not clamp the distributor base in a vise as this might distort the bushings and make it impossible to check bushing wear. Attach a dial indicator to the distributor base opposite the oiler (fig. 186) and adjust the plunger of the indicator against the top of the drive shaft. Move the top of the shaft to and from the indicator with just enough force to indicate the clearance of the shaft in the bushings. Too much force will cause the shaft to spring, and show a false reading. If the clearance exceeds 0.008 inch, replace the bushings.

d. **Remove Drive Shaft and Bushings (fig. 187).** Drive the rivet out of the drive shaft collar at the lower end of the distributor base and push the drive shaft up through the collar and distributor base. Unhook the governor weight springs and remove the governor weights. Remove the lower thrust washer from the shaft or distributor base. Press the bushings out of the distributor base.

**ORDNANCE MAINTENANCE—POWER PLANT, CLUTCH, AND ELECTRICAL SYSTEM— $\frac{3}{4}$  AND 1 $\frac{1}{2}$  TON VEHICLES (DODGE)**

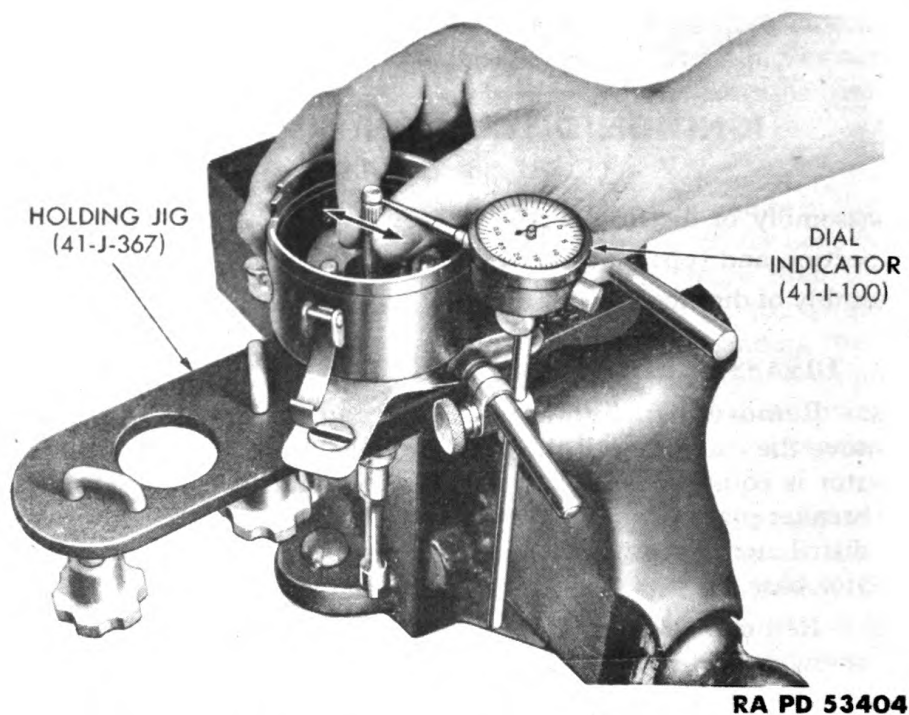

RA PD 53404

**Figure 186—Checking Drive Shaft Bushing Wear**

**100. INSPECTION AND REPAIR OF DISTRIBUTOR PARTS.**

**a. Inspect Breaker Points and Condenser.** If the breaker points have a grayish color and are only slightly pitted, they will be satisfactory for further use. However, if they are excessively pitted or burned, replace the points. Test the condenser (par. 87 c (3) ) and replace it if faulty. See figure 188 for effects of use of incorrect capacity condenser.

**b. Inspect Distributor Cap and Rotor.** Clean the distributor cap and examine for cracks, carbon runners or corroded terminals. If any of these conditions are present, replace the cap. If the vertical faces of the inserts are excessively burned, replace the cap. If the horizontal faces of the inserts are burned, replace the cap and rotor, as this condition indicates that the rotor is too short. Inspect the contact plunger and spring. If the plunger is excessively worn or stuck or the spring is worn or damaged, replace the spring and plunger. Inspect the rotor for cracks or damage. A slight burning at the end of the rotor metal strip is a normal condition and will not affect the operation of the distributor. If the top of the metal strip is burned, replace the rotor, because it is too short.

### IGNITION DISTRIBUTOR REBUILDING

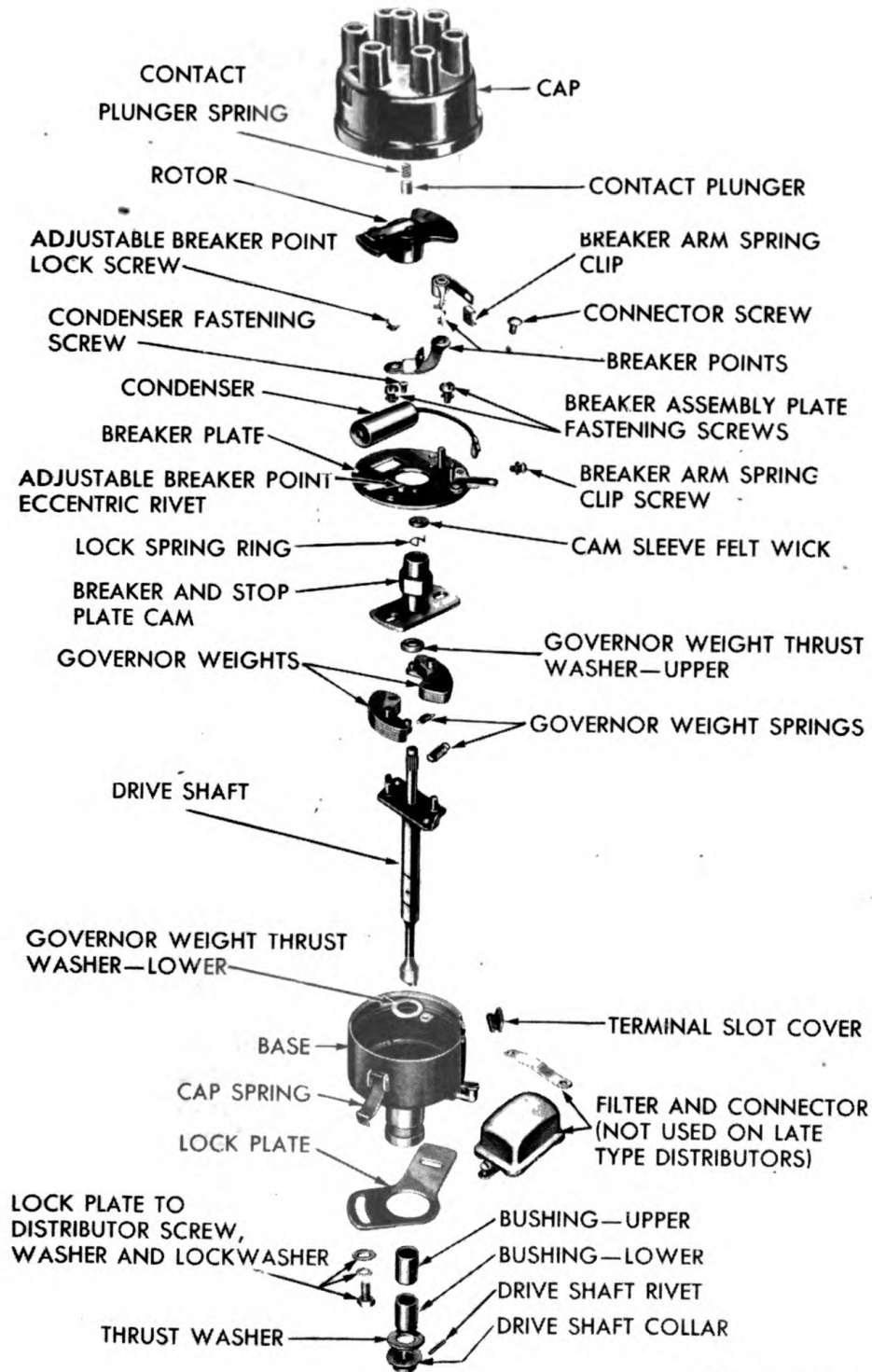

RA PD 53344

Figure 187—Ignition Distributor Disassembled

**ORDNANCE MAINTENANCE—POWER PLANT, CLUTCH, AND ELECTRICAL SYSTEM— $\frac{3}{4}$  AND  $1\frac{1}{2}$  TON VEHICLES (DODGE)**

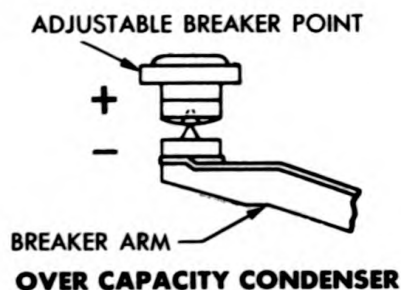

**OVER CAPACITY CONDENSER**

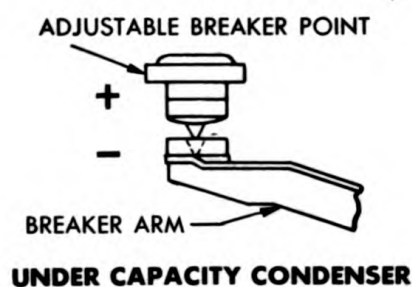

**UNDER CAPACITY CONDENSER**

RA PD 53409

**Figure 188—Breaker Point Failure**

PACK LUBRICANT CHAMBER WITH GREASE BEFORE INSTALLING WEIGHTS

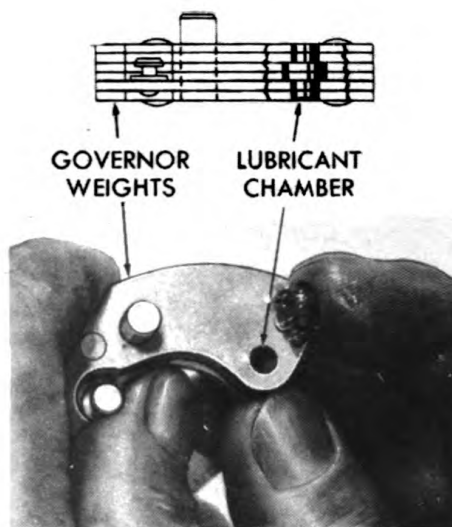

RA PD 53406

**Figure 189—Lubricating Governor Weights**

**101. ASSEMBLY OF DISTRIBUTOR.**

a. **Install Drive Shaft Bushings.** Soak new bushings in engine oil for about fifteen minutes. Press the upper bushing into the distributor base from the top, making sure the oilhole in the bushing lines up with the oiler in the base. Press the lower bushing into the base from the bottom.

b. **Assemble Governor Weights to Drive Shaft (fig. 189).** About midway of the pivot hole in each governor weight is a lubrication groove. To be sure the grooves are filled with lubricant before the weights are assembled, press the pivot holes full of grease. Install the governor weights over the pivot pins and wipe away the surplus grease which will be forced out the pivot pin holes. Connect the governor weight springs to the weights and the spring brackets.

c. **Install Drive Shaft in Distributor Base.** If bushings have not been replaced and have been washed in dry-cleaning solvent, lubricate the bushings thoroughly. Slide the cup-shaped thrust washer on the drive shaft, concave side first. Install the shaft through the distributor base, slide the drive shaft thrust washer and thrust collar on the shaft and install a new pin. If a new shaft is installed, use a new thrust collar,

**IGNITION DISTRIBUTOR REBUILDING**

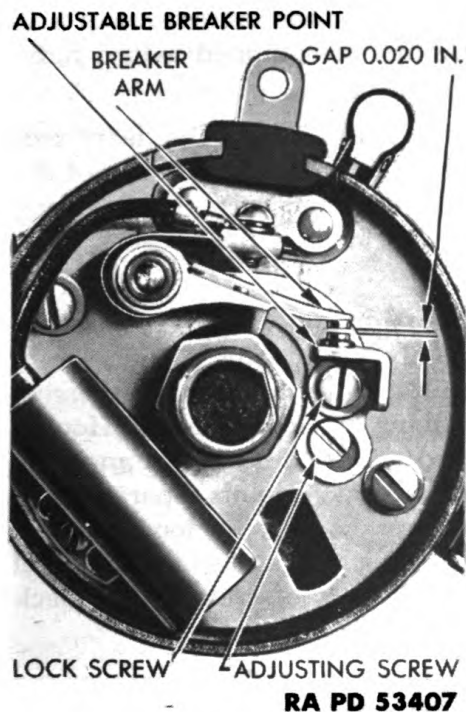

**Figure 190—Breaker Point Adjustment**

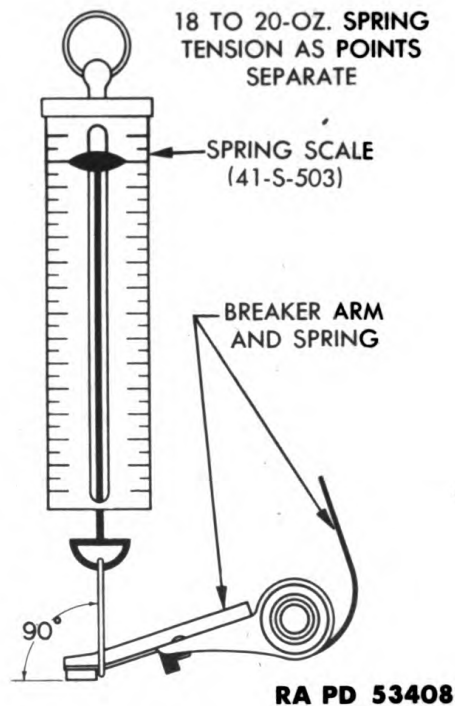

**Figure 191—Breaker Point Spring Tension**

and when drilling the pin hole, hold the shaft down and the collar up against the base so there will be no end play in the shaft when the pin has been installed.

d. **Install Stop Plate Cam.** Place thrust washer over the top end of the drive shaft. Place the stop plate cam over the end of the shaft, and the lugs on the governor weights. Put a drop of oil on each lug. Install the spring lock ring and felt wick at the top of the drive shaft. Put three to five drops of light oil on the felt wick.

e. **Install Breaker Points and Condenser.** Place the adjustable breaker point bracket over the breaker arm pivot post and the adjusting screw, and install the lock screw. Slide the breaker arm over its pivot post with the tension spring against the inside of its attaching bracket. Put the condenser in position, and install its mounting screw with lock washer. Connect the condenser lead and the breaker arm tension spring to the breaker plate by placing a lock washer, then a plain washer and condenser lead terminal, over the attaching screw and the spring clip, which acts as a nut, against the spring with the flanged side up and over the spring insert the screw through the bracket on the breaker plate.

**ORDNANCE MAINTENANCE—POWER PLANT, CLUTCH, AND ELECTRICAL SYSTEM— $\frac{3}{4}$  AND  $1\frac{1}{2}$  TON VEHICLES (DODGE)**

f. **Install Breaker Plate Assembly.** Place the breaker plate assembly in the distributor base and install two mounting screws with shakeproof lock washers. If the distributor is equipped with a radio filter, connect the filter strap to the breaker plate.

g. **Adjust Breaker Point Gap** (fig. 190). Rotate the distributor shaft so that the breaker arm rubbing block is on a high point of the cam. Loosen the breaker point lock screw, and turn the adjusting screw until the point gap is 0.020 inch. Tighten the breaker point lock screw.

h. **Adjust Breaker Arm Spring Tension** (fig. 191). If the breaker arm spring tension is too weak the points will chatter at high speed, giving poor performance, while if the tension is too strong excessive wear of the cam and breaker arm rubbing block will result. Hook a spring scale on the arm at the point end, and hold it at right angles to the point surfaces. Take a reading as the breaker points separate. The spring tension should be 17 to 20 ounces. Adjust by loosening the screw holding the end of the breaker point spring, and slide the end of the spring in or out as necessary. Retighten the screw and recheck the pressure.

i. **Install Distributor Rotor and Cap.** Place the rotor over the distributor cam so that the flat in the rotor hub registers with the flat on the cam, and push the rotor straight into position. Place the cap on the distributor base so that the lip on the counterbore of the cap registers with the notch in the distributor base, then press the two cap springs into the depressions in the cap.

j. **Test Automatic Advance of Distributor.** Place the distributor assembly in test fixture (17-T-5540) and check the automatic advance against the following test figures:

**DISTRIBUTOR GOVERNOR ADVANCE**

	Engine rpm		Distributor rpm	
	Degrees Advance*	rpm	Degrees Advance**	rpm
Start	0°	700	0°	350
Intermediate	6°	800	3°	400
Intermediate	10°	1240	5°	620
Intermediate	16°	1880	8°	940
Full Advance	20°	2300	10°	1150

\*Tolerance  $\pm 1$  degree

\*\*Tolerance  $\pm 2$  degrees

### IGNITION DISTRIBUTOR REBUILDING

(1) **NOTE:** Some distributor test fixture tachometers indicate crankshaft (engine) revolutions per minute while others indicate distributor revolutions per minute. Make certain this is determined before proceeding with tests.

(2) Run the distributor at 350 revolutions per minute and set the advance indicator at zero degrees. Increase the speed to that required for maximum advance, and note whether or not this figure is within specifications. If maximum advance is not within specifications, reduce speed to below that required for zero degrees. Note whether or not the degrees indication drops below zero. If an indication below zero is shown, bend the outer spring bracket, on which the weak spring is hooked, slightly and again check the distributor at the maximum revolutions per minute. If there is no indication below zero, relieve the tension slightly on the strong spring. Then recheck at the maximum revolutions per minute. Check the advance at the intermediate points shown in the chart.



**ORDNANCE MAINTENANCE—POWER PLANT, CLUTCH, AND  
ELECTRICAL SYSTEM— $\frac{3}{4}$  AND  $1\frac{1}{2}$  TON VEHICLES (DODGE)**

**CHAPTER 3**

**ELECTRICAL SYSTEM (Cont'd)**

**Section VI**

**ELECTRICAL SYSTEM FITS AND TOLERANCES**

	<b>Paragraph</b>
General .....	102
Fits and tolerances.....	103

**102. GENERAL.**

a. The following tabulation of fits and tolerances is based on engineering and service experience, and provides information which is important when rebuilding electrical units (pars. 88 through 101). Refer to paragraph 78 for fits and tolerances on the engine and components.

**103. FITS AND TOLERANCES.**

	6-volt	12-volt
<b>a. Battery.</b>		
SPECIFIC GRAVITY:		
Fully charged.....	1.275 to 1.300*	1.275 to 1.300*
Half charged.....	1.225	1.225
Dangerously low.....	1.150	1.150
*A lower specific gravity is recommended for hot tropical climates (consistently above 95 F) to avoid excessive depreciation of plates and separators. Refer to paragraph 86 c (3).		
<b>b. Starter.</b>		
Armature shaft end-play.	0.005 to 0.030 in.	0.005 to 0.030 in.
Maximum allowable		
armature eccentricity.	0.003 in.	0.003 in.
Pinion clearance.....	$\frac{1}{16}$ to $\frac{3}{32}$ in.	$\frac{1}{16}$ to $\frac{3}{32}$ in.
Brush spring tension....	42 to 53 oz	42 to 53 oz
TEST METER READINGS (NO-LOAD TEST):		
At minimum rpm of....	4900	5300
Voltage .....	5.5 volts	11.0 volts
Maximum amperage..	65 amps	30 amps
TEST METER READINGS (STALL TEST):		
At minimum foot-pounds	6.0	6.7
Voltage .....	2.0 volts	4.0 volts
Maximum amperage..	335 amp	175 amp

**ELECTRICAL SYSTEM FITS AND TOLERANCES**

	6-volt	12-volt
<b>c. Generator.</b>		
Maximum allowable voltage loss in battery—generator ground circuit . . . . .	0.05 volt	0.05 volt
Maximum allowable voltage loss in generator charging circuit for each 10 amperes current flowing in circuit.	0.35 volt	0.35 volt
Brush spring tension . . . . .	64 to 68 oz	71 to 76 oz
Maximum allowable armature eccentricity at commutator . . . . .	0.0005 in.	0.0005 in.
<b>OUTPUT (WITHOUT REGULATOR):</b>		
At 1500-1600 rpm—maximum (cold) . . . . .	8 volts, 40-42 amp	. . . .
At 1650-1750 rpm—maximum (hot) . . . . .	8 volts, 40-42 amp	. . . .
At 1050-1150 rpm—maximum (cold) . . . . .	. . . .	15 volts, 50-55 amp
At 1150-1250 rpm—maximum (hot) . . . . .	. . . .	15 volts, 50-55 amp
<b>FIELD COIL AMPERAGE DRAW:</b>		
Voltage . . . . .	6.0 volts	13.0
Amperage . . . . .	1.60 to 1.78 amp	1.48 to 1.64 amp
<b>d. Generator Regulator.</b>		
Ground polarity . . . . .	Negative	Negative
<b>CARBON RESISTORS:</b>		
Resistor marked 80 . . . . .	76 to 84 ohms	76 to 84 ohms
Resistor marked 7 . . . . .	6.6 to 7.5 ohms	. . . .
Resistor marked 15 . . . . .	. . . .	13.5 to 16.5 ohms
Resistor marked 30 . . . . .	. . . .	28 to 32 ohms
Resistor marked 1 . . . . .	. . . .	0.9 to 1.1 ohms
<b>CIRCUIT BREAKER:</b>		
Resistance of winding . . . . .	15.8 to 17.4 ohms	43.7 to 48.3 ohms
Armature air gap . . . . .	0.0595 to 0.0625 in.	0.0595 to 0.0625 in.
Minimum contact point gap . . . . .	0.025 in.	0.025 in.
Points close at . . . . .	6.4 to 6.6 volts	13.0 to 13.5 volts
Points open at (amperes discharge) . . . . .	0.5 to 6.0 amp	0.5 to 6.0 amp
<b>VOLTAGE REGULATOR:</b>		
Resistance of winding . . . . .	4.3 to 4.7 ohms	15.68 to 17.32 ohms

**ORDNANCE MAINTENANCE—POWER PLANT, CLUTCH, AND ELECTRICAL SYSTEM—¾ AND 1½ TON VEHICLES (DODGE)**

	6-volt	12-volt
Armature air gap . . . . .	0.040 to 0.042 in.	0.040 to 0.042 in.
Minimum contact point gap . . . . .	0.010 in.	0.010 in.
Contact point pressure . .	7 to 8 oz	7 to 8 oz
Operating voltage at room temperature (70 F) . .	7.2 to 7.5 volts	14.0 to 14.5 volts
<b>CURRENT REGULATOR:</b>		
Resistance of winding . . .	0.033 to 0.037 ohms	. . . .
Armature air gap . . . . .	0.047 to 0.049 in.	0.047 to 0.049 in.
Minimum contact point gap . . . . .	0.010 in.	0.010 in.
Contact point pressure . .	7 to 8 oz	7 to 8 oz
Operating amperage . . . .	40 to 42 amp	54 to 56 amp
<b>CONDENSER:</b>		
Capacity . . . . .	. . . .	.15 to .19 mfd.
<b>e. Spark Plugs.</b>		
Gap . . . . .	0.025 in.	0.025 in.
Torque wrench pull . . . .	26 to 32 ft-lb	26 to 32 ft-lb
<b>f. Distributor.</b>		
Breaker point gap . . . . .	0.020 in.	0.020 in.
Ignition timing (see par. 25 g) . . . . .	2 degrees atdc	2 degrees atdc
Breaker arm spring tension . . . . .	17 to 20 oz	17 to 20 oz
Cam angle (point dwell)	37½ to 40 degrees	37½ to 40 degrees
Maximum allowable drive shaft bushing wear . . .	0.008 in.	0.008 in.
<b>GOVERNOR ADVANCE:</b>		
At 350 distributor rpm . .	0 degrees*	0 degrees*
At 400 distributor rpm . .	3 degrees*	3 degrees*
At 620 distributor rpm . .	5 degrees*	5 degrees*
At 940 distributor rpm . .	8 degrees*	8 degrees*
At 1150 distributor rpm (max) . . . . .	10 degrees*	10 degrees*
At 700 engine rpm . . . . .	0 degrees**	0 degrees**
At 800 engine rpm . . . . .	6 degrees**	6 degrees**
At 1240 engine rpm . . . .	10 degrees**	10 degrees**
At 1880 engine rpm . . . .	16 degrees**	16 degrees**
At 2300 engine rpm (max) . . . . .	20 degrees**	20 degrees**

\*Tolerance—plus or minus one degree.  
 \*\*Tolerance—plus or minus two degrees.

Generated on 2016-06-23 18:48 GMT / http://hdl.handle.net/2027/uc1.b3243992  
 Public Domain, Google-digitized / http://www.hathitrust.org/access\_use#pd-google

CHAPTER 4

TOOL EQUIPMENT

Tool equipment ..... Paragraph 104

104. TOOL EQUIPMENT.

a. Following is a listing of tools specified in this manual for disassembly, repair and assembly of the engine and components of the Dodge 3/4-ton, 4 x 4 and 1 1/2-ton, 6 x 6 basic vehicle models.

Description	Federal Stock Number
Aliner, connecting rod . . . . .	41-A-135
Arbor, bushing installing, water pump . . . . .	41-A-334
Applier, piston ring . . . . .	41-A-329-500
Bench, test, for generators and starters . . . . .	17-B-13990
Calipers, micrometer, inside, range 2 to 8 in. . . . .	41-C-304
Calipers, micrometer, outside, range 0 to 6 in. . . . .	41-C-307
Cleaner and tester, spark plug, compressed air, abrasive type, 110-volt, 60-cycle . . . . .	41-C-1013
Cleaners, piston ring groove, set . . . . .	41-C-2155
Clutch rebuilder . . . . .	41-C-2480
Compressor, piston ring . . . . .	41-C-2550
Drift, metering well . . . . .	41-D-1537
Drift, valve guide . . . . .	41-D-1547-350
Extractor, plug . . . . .	41-E-555-15
Filer, piston ring . . . . .	41-F-2950
Gage, cylinder, compression . . . . .	41-G-124
Gage, cylinder, dial type, 2 3/16 to 6 in. . . . .	41-G-122
Gage, float level . . . . .	41-G-188
Gage, generator regulator, armature core gap . . . . .	41-G-507
Gage, pressure and vacuum . . . . .	41-G-500
Grinder, electric, cam grinding and general purpose . . . . .	40-G-149
Grinder, for connecting rods, piston pin holes, etc. . . . .	41-G-103
Grinder, crankshaft, portable type . . . . .	40-G-107
Grinder, cylinder hone, capacity 2 1/16 in. to 5 5/8 in. . . . .	40-G-151
Growler, generator and starter armatures . . . . .	17-G-5940
Gun, flushing . . . . .	40-G-540
Hydrometer, storage battery testing . . . . .	18-H-1240
Indicator, test, dial type . . . . .	41-I-100
Jig, holding device, for carburetor, fuel pump, oil pump, distributor . . . . .	41-J-367
Kit, fuel pump repair . . . . .	41-K-79
Lifter, valve . . . . .	41-L-1410
Light, timing . . . . .	41-L-1440
Machine, cylinder boring, 2 5/8 in. to 5 1/4 in. capacity . . . . .	40-M-4
Machine, relining (clutch disk) . . . . .	40-M-3

**ORDNANCE MAINTENANCE—POWER PLANT, CLUTCH, AND ELECTRICAL SYSTEM— $\frac{3}{4}$  AND  $1\frac{1}{2}$  TON VEHICLES (DODGE)**

Description	Federal Stock Number
Ohmmeter, double scale . . . . .	17-O-402
Pliers, brake key and snap ring . . . . .	41-P-1572
Pliers, brake spring . . . . .	41-P-1579
Press, hydraulic, connecting rod . . . . .	41-P-2730
Puller, gear, reversible jaw, 8-in. capacity (fan pulley or sprocket) . . . . .	41-P-2911
Puller, gear, reversible jaw, 0 to 6-in. capacity (fan hub and generator pulley) . . . . .	41-P-2912
Puller, governor, flywheel . . . . .	41-P-2908-200
Reamer, cylinder ridge, $2\frac{11}{16}$ -in. to 5-in. capacity . . . . .	41-R-2275
Reamer, valve tappet . . . . .	41-R-1400
Reamers, adjustable, floating pilot, set . . . . .	41-R-2300
Refacer and line burnisher, water pump housing seat . . . . .	41-R-2332
Remover, bearing race . . . . .	41-R-2370-7
Remover and inserter, bushing set . . . . .	41-R-2385
Remover and installer, camshaft bearing . . . . .	41-R-2386
Remover and replacer, main bearing upper shell . . . . .	41-R-2389-10
Replacer, clutch shaft pilot bushing . . . . .	41-R-2391-40
Replacer, valve lock key . . . . .	41-R-2398
Replacer, water pump shaft seal . . . . .	41-R-2405
Scale, piston fitting and feeling . . . . .	41-S-498
Scale, spring tension (4 lb) . . . . .	41-S-503
Scale, spring tension (15 lb) . . . . .	41-S-507
Straightedge, steel, 2 in. wide, 36 in. long . . . . .	41-S-5858
Tester, distributor . . . . .	17-T-5540
Tester, high-tension circuit . . . . .	17-T-5520
Tester, low-voltage circuit . . . . .	17-T-5575
Tester, valve spring . . . . .	17-T-1600
Tool, armature turning and undercutting . . . . .	41-T-225
Tool, ball scoop . . . . .	41-T-3173
Tool, bearing race retainer . . . . .	41-T-3333
Tool, check valve . . . . .	41-T-3081-60
Tool, clutch plate alining . . . . .	41-T-3085
Tool, piloted driver . . . . .	41-T-3304
Tool, pump check valve . . . . .	41-T-3307-30
Valve refacer, electric, $\frac{3}{16}$ -in. to $\frac{5}{8}$ -in capacity, 110-volt, universal current . . . . .	40-V-505
Valve reseating outfit, set . . . . .	40-V-535
Vise, piston, $5\frac{1}{2}$ -in. capacity . . . . .	41-V-425
Wrench, fuel valve seat . . . . .	41-W-1496
Wrench, power jet valve . . . . .	41-W-1868
Wrench, socket (for governor flywheel) . . . . .	41-W-715
Wrench, socket, $1\frac{13}{16}$ in. . . . .	41-W-2620
Wrench, tappet . . . . .	41-W-3573

**TOOL EQUIPMENT**

Description	Federal Stock Number
Wrench, torque indicating, foot-pound . . . . .	41-W-3630
Wrench, well vent . . . . .	41-W-3820
Wrench, wheel lug nut . . . . .	41-W-3830

**REFERENCES**

**STANDARD NOMENCLATURE LISTS.**

Basic vehicles, 3/4-ton, 4 x 4 (Dodge) . . . . .	SNL G-502
Ambulance	
Carryall	
Command reconnaissance	
Command field sedan	
Command with winch	
Emergency repair chassis	
Radio	
Telephone maintenance (L.I.U. body)	
Telephone maintenance (body model 4551)	
Weapon carrier	
Weapon carrier with winch	
Basic vehicles, 1 1/2-ton, 6 x 6 (Dodge) . . . . .	SNL G-507
Personnel and cargo	
Personnel and cargo with winch	
37-mm gun motor carriage M6 . . . . .	SNL G-121
Cleaning, preserving and lubricating materials, re- coil fluids, special oils, and miscellaneous re- lated items . . . . .	SNL K-1
Soldering, brazing, and welding materials, gases, and related items . . . . .	SNL K-2
Tools, maintenance for repair of automotive vehicles . . . . .	SNL G-27
Tool sets—motor transport . . . . .	SNL N-19
Tool sets for ordnance service command, automo- tive shops . . . . .	SNL N-30
Current Standard Nomenclature Lists are listed above. An up-to-date list of SNL's is maintained as the "Ordnance Publications for Supply Index" . . . . .	OPSI

**EXPLANATORY PUBLICATIONS.**

Related Technical Manuals	
3/4-ton truck, 4 x 4 (Dodge) . . . . .	TM 9-808
1 1/2-ton truck, 6 x 6 (Dodge) . . . . .	TM 9-810
37-mm gun motor carriage M6 . . . . .	TM-9-750A

**TM 9-1808A**

104

**ORDNANCE MAINTENANCE—POWER PLANT, CLUTCH, AND ELECTRICAL SYSTEM— $\frac{3}{4}$  AND 1 $\frac{1}{2}$  TON VEHICLES (DODGE)**

Ordnance maintenance:

Power train, chassis, and electrical system for basic vehicles,  $\frac{3}{4}$ -ton, 4 x 4 and 1 $\frac{1}{2}$ -ton, 6 x 6 (Dodge) . . . . . **TM 9-1808B**

**Automotive Materiel**

Automotive electricity . . . . . **TM 10-580**

Electric fundamentals . . . . . **TM 1-455**

Fuels and carburetion . . . . . **TM 10-550**

The internal combustion engine . . . . . **TM 10-570**

The motor vehicle . . . . . **TM 10-510**

**Maintenance and Repair**

Echelon system of maintenance . . . . . **TM 10-525**

Maintenance and repair . . . . . **TM 10-520**

Ordnance maintenance procedures . . . . . **TM 9-1100**

Automotive lubrication . . . . . **TM 10-540**

Motor transport inspections . . . . . **TM 10-545**

Tune-up and adjustments . . . . . **TM 10-530**

Tire repair and retread . . . . . **TM 9-1868**

Cleaning, preserving, lubricating and welding materials and similar items issued by the Ordnance Department . . . . . **TM 9-850**

Detailed lubrication instructions for ordnance materiel . . . . . **OFSB 6-series**

**Protection of Materiel**

Fire prevention, safety precautions, accidents . . **TM 10-360**

Explosives and demolitions . . . . . **FM 5-25**

Defense against chemical attack . . . . . **FM 21-40**

Decontamination of armored force vehicles . . . **FM 17-59**

Chemical decontamination, materials and equipment . . . . . **TM 3-220**

List of Publications for Training . . . . . **FM 21-6**

**Storage and Shipment**

Registration of motor vehicles . . . . . **AR 850-10**

Storage of motor vehicle equipment . . . . . **AR 850-18**

Ordnance field service storage and shipment chart—G-group major items . . . . . **OSSC-G**

Rules governing the loading of mechanized and motorized army equipment, also, major caliber guns, for the United States Army and Navy, on open top equipment published by Operations and Maintenance Department of Association of American Railroads.





**TM 9-1808A**

**ORDNANCE MAINTENANCE—POWER PLANT, CLUTCH, AND ELECTRICAL SYSTEM— $\frac{3}{4}$  AND  $1\frac{1}{2}$  TON VEHICLES (DODGE)**

<b>C—Cont'd</b>	<b>Page No.</b>		<b>Page No.</b>
Clutch—Cont'd:		clutch .....	32
description .....	27	cooling system.....	31
disassembling .....	163	distributor .....	197
inspection .....	163-165	electrical system.....	196-198
installation .....	120	engine .....	28-32
maintenance duties by echelons.	8	fits and tolerances—	
rebuilding .....	163-167	electrical .....	262-264
replacement in vehicle.....	67	fits and tolerances—engine..	178-181
trouble shooting.....	41-42	fuel system.....	31
Compression, testing.....	46-47	generator (6-volt).....	197
Condenser, testing.....	216	generator (12-volt).....	197
Connecting rod bearings:		ignition system .....	197
clearance .....	56	oiling system.....	31
installation .....	113	sealed beam units and bulbs...	198
removal .....	82	starter .....	196-197
replacement in vehicle.....	55-57	valve timing.....	31
Connecting rods and pistons:		Description:	
assembling .....	111	camshaft and bearings.....	12-13
inspection .....	94-98	carburetor (Carter):	
installation .....	111-113	(See supplement in back of	
Cooling system:		manual)	
data .....	31	carburetor (Zenith) .....	16-19
description .....	27	clutch .....	27
fan belt adjustment.....	231-232	connecting rods.....	13
flushing .....	50	cooling system.....	27
maintenance duties by echelons.	9	crankshaft and main bearings..	12
thermostat .....	52, 61-62	electrical system .....	182-198
trouble shooting.....	40-41	engine .....	12-32
Core hole plugs, replacement.....	89	exhaust system.....	19
Crankshaft:		fuel filter .....	19
end play.....	110	fuel system.....	16-19
inspection .....	90	generating system.....	191-193
pilot bushing .....	90	governor (Carter):	
Crankshaft (main) bearings:		(See supplement in back of	
clearance .....	66	manual)	
installation .....	110-111	governor (Zenith).....	19
removal .....	83	ignition system .....	193-194
replacement in vehicle.....	64-66	oiling system .....	19-25
Current regulator, testing.....	207, 248	pistons .....	13
Cylinder block, inspection.....	87-89	starting system .....	191
Cylinder head:		valves .....	13-14
inspection .....	87-88	Disk, clutch, refacing.....	165
removal .....	80	Distributor:	
installation .....	113-114	assembling .....	258-261
		data .....	197
<b>D</b>		description .....	193-194
Data:		disassembling .....	255
battery .....	196	inspection and repair.....	256
		installation .....	118
		rebuilding .....	255-261

INDEX

D—Cont'd	Page No.	Page No.	
Distributor breaker points:		Fender and radiator assembly:	
adjustment . . . . .	216-218, 260	installation . . . . .	173-174
inspection . . . . .	256	removal . . . . .	68-70
Distributor cap inspection . . . . .	256	Field coils:	
Distributor condenser, testing . . . . .	216	generator (6-volt) . . . . .	232
Distributor rotor, inspection . . . . .	256	generator (12-volt) . . . . .	238-240
		starter . . . . .	222
		Fits and tolerances:	
<b>E</b>		electrical . . . . .	262-264
Electrical system:		engine . . . . .	178-181
data . . . . .	196-198	Flushing cooling system . . . . .	50
description . . . . .	182-198	Flywheel:	
electrical interference and		inspection . . . . .	105
suppression . . . . .	194-196	replacement in vehicle . . . . .	67
fits and tolerances . . . . .	262-264	Fuel filter, description . . . . .	19
high voltage circuit tests . . . . .	213-218	Fuel gage, data . . . . .	198
low voltage circuit tests . . . . .	199-213	Fuel pump:	
maintenance duties by echelons . . . . .	9	assembling . . . . .	146-148
trouble shooting . . . . .	199-218	data . . . . .	31
Engine (assembly):		description . . . . .	16
assembling . . . . .	106-120	disassembling . . . . .	141-144
data . . . . .	28-32	inspection . . . . .	144-146
description . . . . .	12-32	installation . . . . .	117
disassembling . . . . .	76-85	rebuilding . . . . .	141-148
fits and tolerances . . . . .	178-181	removal . . . . .	76
inspection . . . . .	86-105	Fuel system:	
installation . . . . .	168-177	adjustments:	
maintenance duties by echelons . . . . .	9-10	float . . . . .	131
manifold heat control valve		idling . . . . .	176-177
setting . . . . .	49	carburetor rebuilding (Carter):	
removal . . . . .	72-75	(See supplement in back of	
replacements without removing		manual)	
engine:		carburetor rebuilding	
chain case cover oil seal . . . . .	58-61	(Zenith) . . . . .	121-141
connecting rod bearings . . . . .	55-57	data . . . . .	31
crankshaft bearings . . . . .	64-66	description . . . . .	16-19
flywheel . . . . .	67	fuel pump rebuilding . . . . .	141-148
pistons and rings . . . . .	57-58	governor rebuilding (Carter):	
timing chain and sprockets . . . . .	58-61	(See supplement in back of	
supports . . . . .	74	manual)	
tests and adjustments . . . . .	43-49	governor rebuilding	
trouble shooting . . . . .	33-41	(Zenith) . . . . .	134-140
Equipment and special tools . . . . .	265-267	maintenance duties by echelons . . . . .	11
Exhaust system:		trouble shooting . . . . .	33-40
description . . . . .	19		
maintenance duties by echelons . . . . .	11	<b>G</b>	
		Generator:	
<b>F</b>		assembling (6-volt) . . . . .	235-237
Fan belt, adjustment . . . . .	61	assembling (12-volt) . . . . .	242-245
Fan pulley (lower), removal . . . . .	82		

**TM 9-1808A**

**ORDNANCE MAINTENANCE—POWER PLANT, CLUTCH, AND ELECTRICAL SYSTEM—¾ AND 1½ TON VEHICLES (DODGE)**

<b>G-Cont'd</b>	<b>Page No.</b>	<b>Page No.</b>
<b>Generator—Cont'd:</b>		electrical interference and suppression . . . . . 194-196
data . . . . .	197	ignition circuit tests . . . . . 212-218
description . . . . .	192	trouble shooting . . . . . 212-218
disassembling (6-volt) . . . . .	229-232	<b>Inspection:</b>
disassembling (12-volt) . . . . .	237-238	camshaft and bearings . . . . . 93
polarizing . . . . .	174	carburetor . . . . . 126-128, 134-136
rebuilding (6-volt) . . . . .	229-237	chain case cover . . . . . 105
rebuilding (12-volt) . . . . .	237-245	clutch . . . . . 163-165
tests and repairs (6-volt) . . . . .	232-235	clutch housing . . . . . 105
tests and repairs (12-volt) . . . . .	238-242	connecting rod bearings and journals . . . . . 56, 90
<b>Generator regulator:</b>		connecting rods . . . . . 94-98
data . . . . .	197	core hole plugs . . . . . 89
description . . . . .	191-193	crankshaft bearings and journals . . . . . 66, 90
tests, adjustments and repairs . . . . .	245-254	cylinder block . . . . . 87-89
<b>Generating system:</b>		cylinder head . . . . . 87
description . . . . .	191-193	engine components . . . . . 86-105
low voltage circuit tests . . . . .	199-213	fan pulley . . . . . 105
polarizing generator . . . . .	174	flywheel . . . . . 105
trouble shooting . . . . .	199-211	generator (6-volt) . . . . . 232-235
<b>Governor (Carter):</b>		generator (12-volt) . . . . . 238-242
(See supplement in back of manual)		manifolds . . . . . 103
<b>Governor (Zenith):</b>		oil pan . . . . . 105
adjustments . . . . .	177	oil pump . . . . . 160-161
assembling . . . . .	137-140	oil strainer . . . . . 105
data . . . . .	31	pilot bushing, crankshaft . . . . . 90
description . . . . .	19	pistons . . . . . 94-98
disassembling . . . . .	134-136	piston pins . . . . . 94-98
inspection . . . . .	136-137	piston rings . . . . . 94-98
rebuilding . . . . .	134-140	pre-installation, engine assembly . . . . . 168
<b>Ground circuit, test for voltage loss . . . . .</b>	<b>204-207</b>	starter . . . . . 222-225
<b>H</b>		tappets . . . . . 93
<b>High tension circuit tester . . . . .</b>	<b>213-218</b>	valves and springs . . . . . 98-100
<b>Horn, data . . . . .</b>	<b>198</b>	valve seats . . . . . 100
<b>I</b>		valve stem guides . . . . . 100
<b>Identification of models . . . . .</b>	<b>5-7</b>	water pump . . . . . 150-152
<b>Ignition circuit tester . . . . .</b>	<b>213-218</b>	<b>L</b>
<b>Ignition system:</b>		<b>Low voltage circuit tests . . . . . 199-213</b>
adjustment:		<b>M</b>
distributor breaker points . . . . .	216-218, 260	<b>Maintenance duties by echelons . . 7-11</b>
ignition timing . . . . .	47-48	<b>Manifold assembly and gasket:</b>
spark plugs . . . . .	48-49	assembling . . . . . 103
data . . . . .	197	disassembling . . . . . 103
description . . . . .	193-194	inspection . . . . . 103
		<b>Manifold heat control, setting . . . . 49</b>

INDEX

<b>N</b>	<b>Page No.</b>	<b>Page No.</b>	
Noises:			
bearing .....	38	guard mounting..... 63-64	
ping or spark knock.....	37	Radiator and fender assembly:	
piston .....	37-38	installation .....	173-174
unusual .....	38-39	removal .....	68-70
valves .....	37	Radio interference suppression. 194-196	
Numbers, engine and serial.....	12	Rebuild defined..... 8	
		References .....	267-268
		Registration numbers, U. S. A. ...	6-7
		Regulator, generator:	
<b>O</b>		data .....	197
Oiling system:		description .....	191-193
data .....	31	tests, adjustments and	
description .....	19-25	repairs .....	245-254
trouble shooting.....	39-40	Regulator ground circuit, test	
Oil pan:		for voltage loss.....	205-207
inspection .....	105	Repair defined..... 8	
installation .....	116	Repairs (engine in vehicle).....	43-67
Oil pump:		Replace defined..... 8	
assembling .....	161-162	Rings, piston:	
data .....	31	inspection .....	94-98
description .....	19	replacement in vehicle.....	57-58
disassembling .....	156-160		
inspection.....	160-161	<b>S</b>	
installation .....	117-118	Serial numbers, engine.....	12
rebuilding .....	156-162	Service defined .....	7
removal .....	80	Slipping clutch .....	42
Oil seal, chain case cover, re-		Spark plugs:	
placement in vehicle.....	58-61	adjustment .....	48-49
Oil strainer:		data .....	197
cleaning and inspection.....	105	Specific gravity of battery....	201-204
installation .....	116	Sprocket, crankshaft, removal....	82
Overheating .....	40-41	Sprockets, timing chain, replace-	
		ment in vehicle.....	58-61
<b>P</b>		Starter assembly:	
Performance, improper engine... 35-37		assembling .....	225-228
Pilot bushing, crankshaft.....	90	data .....	196-197
Pins, piston, inspection.....	98	description .....	191
Pistons and connecting rods:		disassembling .....	219
assembling .....	111	inspection .....	222-228
installation .....	111-113	rebuilding .....	219-228
Pistons and rings:		tests and repairs.....	222-228
inspection .....	94-98	Starting system:	
installation .....	111	data .....	196-197
replacement in vehicle.....	57-58	description .....	191
Polarizing generator .....	174	maintenance duties by echelons.	9
Power. loss of.....	37	tests .....	199-211
		trouble shooting.....	199-211
<b>R</b>			
Radiator:			
flushing .....	50		

**TM 9-1808A**

**ORDNANCE MAINTENANCE—POWER PLANT, CLUTCH, AND ELECTRICAL SYSTEM— $\frac{3}{4}$  AND  $1\frac{1}{2}$  TON VEHICLES (DODGE)**

<b>T</b>	<b>Page No.</b>	<b>T</b>	<b>Page No.</b>
Tappets, valve:		fuel system . . . . .	33-40
adjustment . . . . .	44-46	generating system . . . . .	199-211
inspection . . . . .	93	ignition system . . . . .	212-218
Tests:		oiling system . . . . .	39-40
battery . . . . .	201-203	starting system . . . . .	199-211
breaker points . . . . .	216-218		
carburetor . . . . .	176-177	<b>V</b>	
compression . . . . .	46-47	Vacuum test . . . . .	49
distributor . . . . .	260-261	Valves:	
engine . . . . .	43-50	refacing . . . . .	102
fuel pump . . . . .	148, 176	replacement and	
fuel system . . . . .	35	grinding . . . . .	52-55, 102-103
generator (6-volt) . . . . .	237	replacement of seats . . . . .	102
generator (12-volt) . . . . .	244-245	Valve guides:	
ignition circuit . . . . .	212-218	inspection . . . . .	100
low voltage circuit . . . . .	199-213	replacement in vehicle . . . . .	53, 100-101
starter . . . . .	199-211	Valve springs:	
thermostat . . . . .	52	installation . . . . .	108-109
timing chain slack . . . . .	82	removal . . . . .	53, 80-82
vacuum . . . . .	49	Valve tappets:	
Thermostat:		adjustment . . . . .	44-46
installation . . . . .	61-62	inspection . . . . .	93
testing . . . . .	52	Valve tappet adjusting screw,	
Timing chain:		replacement in vehicle . . . . .	66-67
installation . . . . .	113	Ventilator, crankcase . . . . .	44
replacement in vehicle . . . . .	58-61	Voltage regulator, testing . . . . .	211, 247
Timing:			
ignition . . . . .	47-48	<b>W</b>	
valves . . . . .	31	Water distributor tube, installation	117
Tool equipment . . . . .	11, 265-267	Water pump:	
Transmission:		assembling . . . . .	152-155
installation . . . . .	171-172	data . . . . .	31
removal . . . . .	70-72	description . . . . .	12
Trouble shooting:		disassembling . . . . .	149-150
battery . . . . .	201-204	inspection . . . . .	150-152
clutch . . . . .	41-42	installation . . . . .	117
cooling system . . . . .	40-41	rebuilding . . . . .	149-155
electrical equipment . . . . .	199-218	Wiring:	
engine . . . . .	33-41	description . . . . .	183-191
		diagrams . . . . .	184-189

[A.G. 300.7 (29 July 43)]

**BY ORDER OF THE SECRETARY OF WAR:**

**G. C. MARSHALL,**  
*Chief of Staff.*

**OFFICIAL:**

**J. A. ULIO,**  
*Major General,*  
*The Adjutant General.*

**DISTRIBUTION: R9 (4); Bn9 (2); C9 (8).**

**(For explanation of symbols, see FM 21-6)**

**SUPPLEMENT**

**CARTER CARBURETOR**

**MODEL ETW1**

---

This supplement contains maintenance information on the Carter carburetor and governor which became effective on vehicles covered by this manual as follows:

**Weapon Carrier without Winch** ( $\frac{3}{4}$  ton, 4 x 4). Serial numbers 81667006, 81668149 and 81668309 through 81674100 and after 81675080.

**Weapon Carrier with Winch** ( $\frac{3}{4}$  ton, 4 x 4). Serial numbers 81668388 through 81674100 and after 81675080.

**Command** ( $\frac{3}{4}$  ton, 4 x 4). Serial numbers 81668612 through 81674100 and after 81675080.

**Ambulance** ( $\frac{3}{4}$  ton, 4 x 4). Serial numbers 81668308 through 81674100 and after 81675080.

**Personnel and Cargo Carrier without Winch** ( $1\frac{1}{2}$  ton, 6 x 6). After serial number 82023143.

**Personnel and Cargo Carrier with Winch** ( $1\frac{1}{2}$  ton, 6 x 6). After serial number 82023203.

**CARTER CARBURETOR MODEL ETW1**

**CARTER CARBURETOR AND GOVERNOR REBUILDING**

	Paragraph
General description and construction.....	1
Data and specifications.....	2
Disassembly of carburetor.....	3
Inspection of carburetor parts.....	4
Assembly of carburetor.....	5
Disassembly of governor.....	6
Inspection and repair of governor parts.....	7
Assembly of governor.....	8

**1. GENERAL DESCRIPTION AND CONSTRUCTION.**

a. The Carter carburetor (model ETW1) is of the downdraft type with governor attached. The carburetor consists of five functional circuits which are described below.

(1) **FLOAT CIRCUIT** (fig. 1). The float circuit maintains the fuel level in the carburetor. A correct fuel level is very important as the fuel mixture supplied by the different circuits is dependent upon the level of the fuel in the carburetor. The float circuit is essentially the same as other float circuits. However, it uses a bakelite needle and the float is divided into two separate sections, although both are used in the same bowl. The bowl has a center section which acts as a baffle plate to eliminate the splashing of gasoline in the bowl. The inside bowl vent leads not only to the bowl, but also to the pump jet in order to supply relief air to the pump jet. This prevents fuel from being syphoned at constant throttle.

(2) **LOW SPEED CIRCUIT** (fig. 2). The low speed circuit supplies the fuel mixture during the idling range. An adjustable screw controls the idling mixture ratio. The low speed jet gets its supply of gasoline from the high speed passage and this metered fuel is carried to the idle passage air bleed through a cross passage which can be clearly seen when the bowl cover is removed. The central part of the bowl cover gasket forms one side of this passage. Therefore it must be air tight at all times or a lean low speed condition will result. The idle passage air bleed is a small brass bushing pressed into the air horn, directly above the economizer. It measures the air for the low speed circuit which mixes with the gasoline at this point and is carried through the economizer and downward through the passage to the idle port.



**CARTER CARBURETOR AND GOVERNOR REBUILDING**

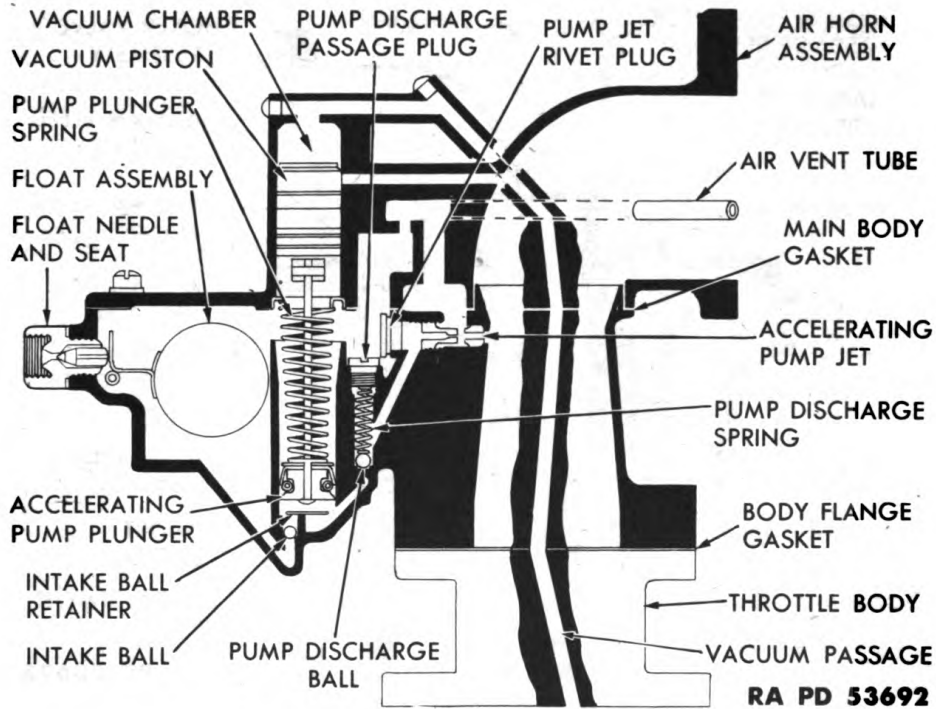

**Figure 1—Carburetor**

(3) **HIGH SPEED CIRCUIT** (fig. 2). The high speed circuit meters the fuel used above the idling range. The main metering jet and main vent tube control the fuel mixture during the normal speed range. A step-up jet supplies additional fuel for high speed running or heavy pulling. The high speed circuit consists of two parts: the usual fixed jet and air bleed system and the vacuum step-up system. The high speed passage travels upward and across the upper part of the body casting to the diffuser ports of the air foil. The main vent tube assembly is installed in the vertical portion of this passage and the plug seals at the upper surface of the bowl cover. It is very necessary that no leak is allowed at this point (in the center of the bowl cover) as it will act as an outside vent to the bowl and at the same time allow air to bleed through the threads to the high speed passage. This will affect the entire high speed range. Air from the bowl is bled through a small hole inside the bowl cover to the main vent tube assembly, where it is bled downward through the tube and out through side holes into the vertical column of gasoline which has been metered by the main metering jet. The usual vacuum step-up system is used for acceleration or load mix-

**CARTER CARBURETOR MODEL ETW1**

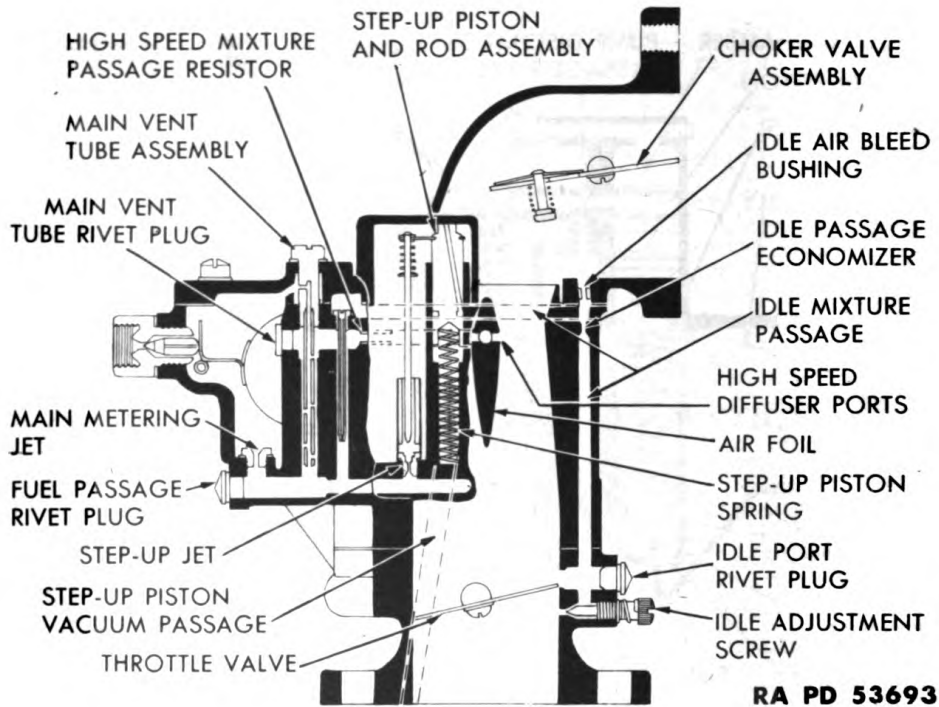

**Figure 2—Carburetor**

ture requirements. It is actuated by the intake manifold vacuum which is connected to the passage by means of the slotted type gasket.

(4) **PUMP CIRCUIT** (fig. 1). The accelerating pump supplies additional fuel for acceleration. The pump plunger is controlled by a vacuum piston and spring. When the manifold vacuum is high due to constant revolutions of the engine the vacuum piston draws the pump plunger up and fuel enters the pump. When the manifold vacuum drops on acceleration the spring forces the plunger down and additional fuel is discharged into the air stream in the carburetor throat.

(5) **CHOKE CIRCUIT** (fig. 2). The choke consists of a valve in the throat of the air horn and provides a means of restricting the air supply to enrich the fuel mixture for starting and warming up the engine.

(6) **GOVERNOR** (fig. 3). The governor is connected directly to the carburetor throttle shaft and governs the maximum engine speed by controlling the position of the carburetor throttle valve. The governor works on the principal of air velocity against an eccentric throttle valve. The cam on the throttle shaft revolves in a clockwise direction and stretches the spring as the throttle closes. The plunger, located in the

**CARTER CARBURETOR AND GOVERNOR REBUILDING**

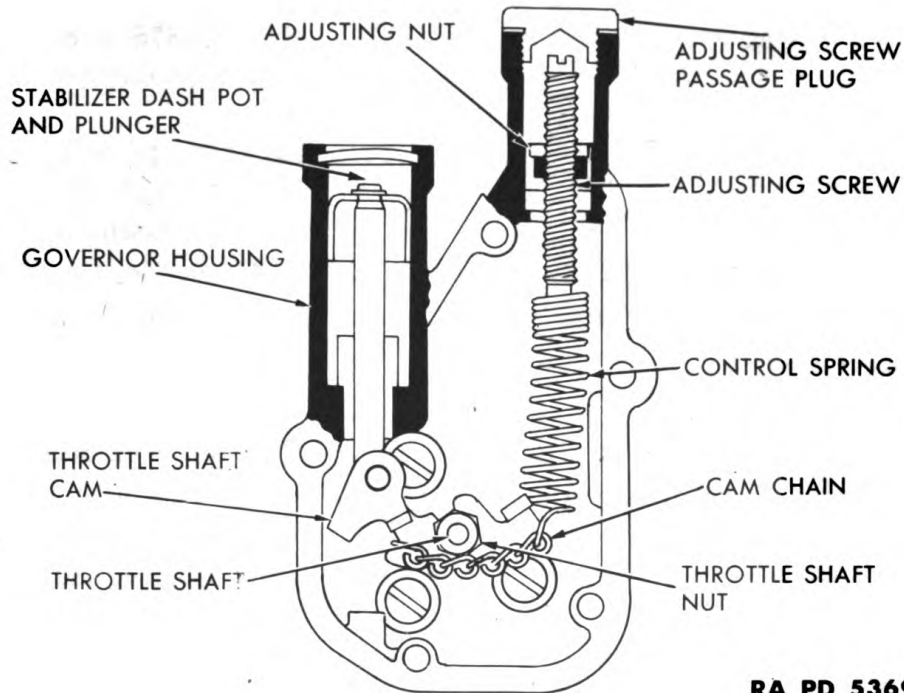

RA PD 53694

**Figure 3—Governor**

opposite side of governor housing, acts as a dashpot. The air trapped above the plunger serves as a stabilizer to prevent throttle flutter. The balancing effect between the air velocity (against the OFF center valve) and the adjustable spring (working against the cam action) allows the governor to become effective at almost any predetermined speed.

**2. DATA AND SPECIFICATIONS.**

**a. Carburetor.**

Make .....	Carter
Type .....	Downdraft
Model .....	ETW1
Float setting .....	$\frac{3}{64}$ in. below top surface of carburetor body casting.
Float needle seat hole size .....	0.0760 in. seat No. 25-116S

**CARTER CARBURETOR MODEL ETW1**

Idle orifice tube jet size.....	0.0276 in. jet No. 123-47S
Idle adjustment screw setting.....	1/2 to 1 1/2 turns
Main metering jet.....	No. 159-87S if orifice is questionable, replace jet.
Main vent tube.....	No. 145-51S if ques- tionable replace tube and plug assembly.
Step-up jet size.....	0.0413 in. No. 149-82S
Accelerating pump discharge jet size.....	0.0315 in. No. 48-73
<b>b. Governor.</b>	
Type .....	Velocity
Location .....	Attached to carburetor
Active coils of control spring.....	10
Location of adjusting screw.....	1 1/2 in. between end of screw in spring and cyl- indrical boss on hous- ing.

**3. DISASSEMBLY OF CARBURETOR.**

a. **Remove Air Horn Assembly (1, fig. 4).** Remove the main vent tube and plug assembly. Remove the air horn attaching screws using screwdriver and 1 1/2-inch end wrench from midget wrench set (federal stock number 41-W-900). Lift off the air horn and gasket. Remove the accelerating pump plunger, rod and piston assembly. Remove the step-up piston plate and rod assembly. Turn the carburetor over and catch the step-up piston spring and gasket.

b. **Remove Float, Needle and Seat Assembly (2, fig. 4).** Lift the float pin retainer out of the slot and remove the float and lever assembly. Screw out the float needle and seat assembly.

c. **Remove Body Flange and Governor Assembly (3, fig. 4).** Remove the lock wires and screws and separate the assembly from the carburetor body. Remove the idle adjustment screw.

d. **Remove Accelerating Pump Ball Checks (fig. 4).** Remove the intake check ball retaining ring with remover (federal stock number 41-R-2370-10) (4, fig. 4). Turn the carburetor body over and catch the check ball. Screw out the pump discharge passage plug (5, fig. 4). Turn the carburetor over and catch the discharge check ball and spring.

**CARTER CARBURETOR AND GOVERNOR REBUILDING**

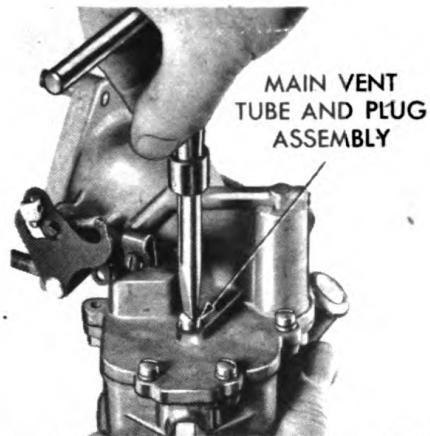

**1—REMOVING MAIN VENT TUBE AND PLUG ASSEMBLY**

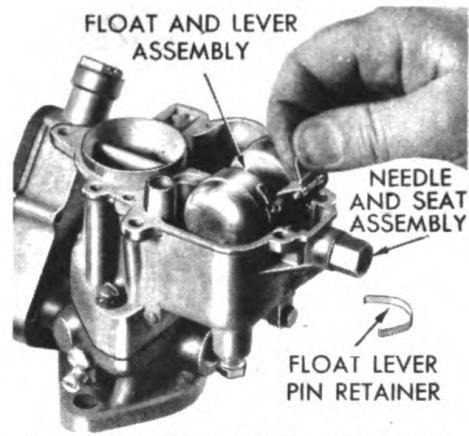

**2—REMOVING OR INSTALLING FLOAT AND LEVER ASSEMBLY**

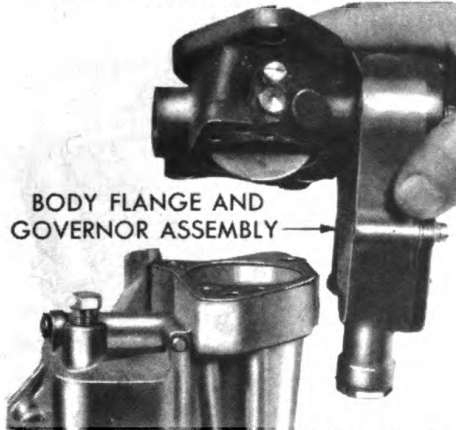

**3—REMOVING OR INSTALLING BODY FLANGE AND GOVERNOR**

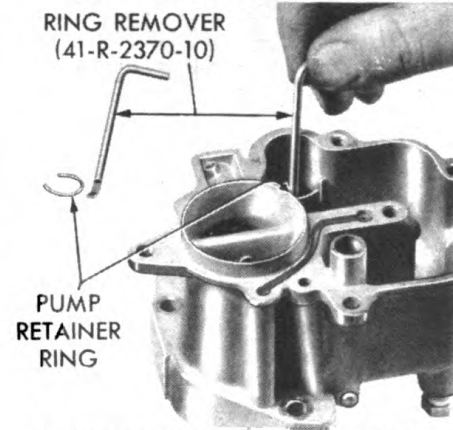

**4—REMOVING ACCELERATING PUMP INLET CHECK BALL**

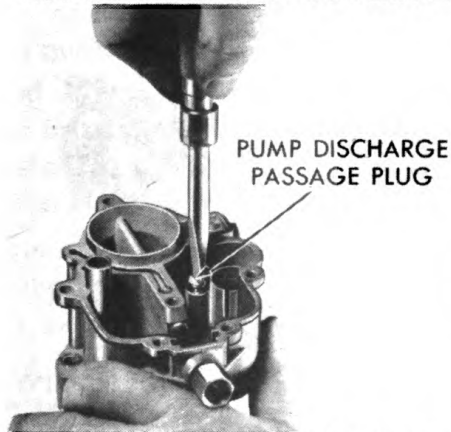

**5—REMOVING OR INSTALLING ACCELERATING PUMP DISCHARGE PASSAGE PLUG**

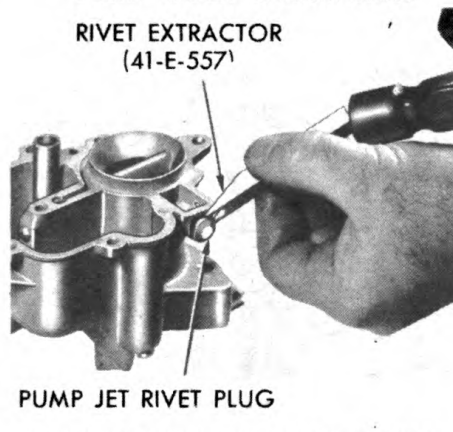

**6—REMOVING ACCELERATING PUMP JET RIVET PLUG**

RA PD 53695

**Figure 4—Carburetor Rebuilding**

CARTER CARBURETOR MODEL ETW1



1—REMOVING OR INSTALLING STEP-UP JET

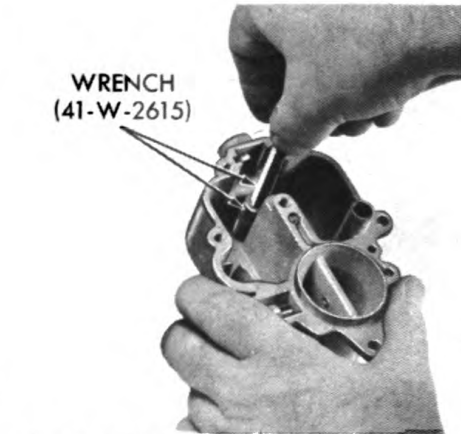

2—REMOVING OR INSTALLING MAIN METERING JET

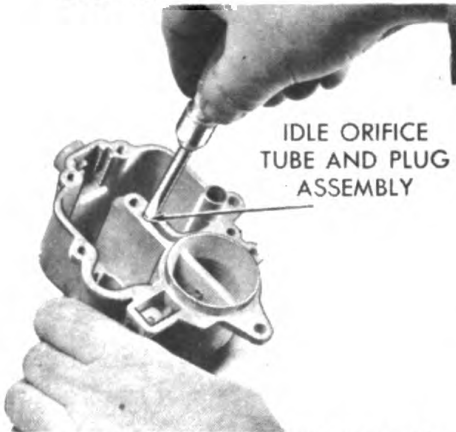

3—REMOVING OR INSTALLING IDLE ORIFICE TUBE

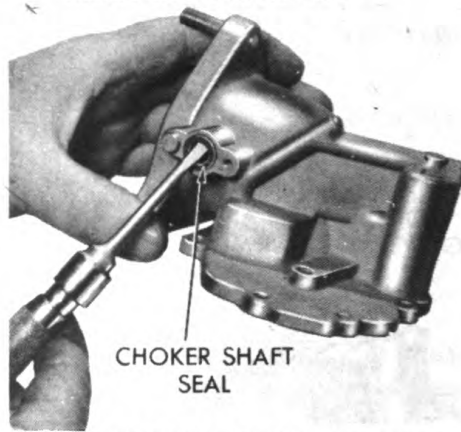

4—REMOVING CHOKER SHAFT SEAL

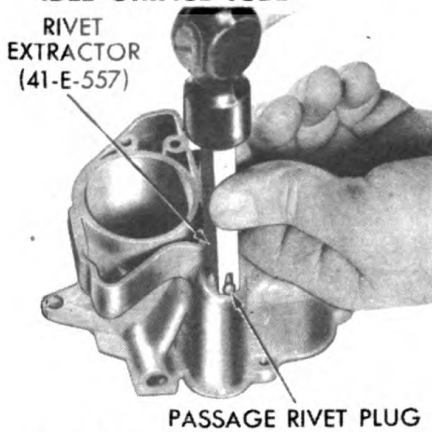

5—REMOVING PASSAGE RIVET PLUG



6—CHOKER VALVE INSTALLED

RA PD 53696

Figure 5—Carburetor Rebuilding

**CARTER CARBURETOR AND GOVERNOR REBUILDING**

e. **Remove Accelerating Pump Jet** (6, fig. 4). Use rivet extractor (federal stock number 41-E-557) and remove the rivet plug. Screw out the discharge jet.

f. **Remove Step-up Jet and Gasket Assembly** (1, fig. 5). Screw the step-up jet and gasket assembly from the float bowl.

g. **Remove Main Metering Jet** (2, fig. 5). Remove the main metering jet from the bottom of the float bowl, using socket and handle from midget wrench set (federal stock number 41-W-2615).

h. **Remove Idle Orifice Tube** (3, fig. 5). Screw the idle orifice tube and plug assembly from the top of the float bowl.

i. **Remove Choker Valve and Shaft** (4, fig. 5). Remove the screws which hold the choker valve to the shaft and lift out the valve. Remove the screw which holds the choker tube bracket to the air horn and pull out the shaft and lever assembly. Pry the shaft seal retaining washer from the air horn and remove the seal.

**4. INSPECTION OF CARBURETOR PARTS.**

a. **Clean All Parts and Passages** (5, fig. 5). Remove all passage rivet plugs with rivet extractor (federal stock number 41-E-557). Wash all parts in dry-cleaning solvent, dry and blow out passages with compressed air.

b. **Inspect Floats, Float Needle and Seat Assembly.** Shake the floats and listen for gasoline inside the floats. If either float contains gasoline indicating a leak, replace the float and lever assembly. Examine the needle and seat assembly and if the seating surfaces are scored or the needle is otherwise damaged, replace the assembly.

c. **Inspect Main Metering Jet and Main Vent Tube.** Examine the metering jet and main vent tube and if size of the orifices in either are questionable, replace the part.

d. **Inspect the Idle Orifice Tube and Adjustment Screw.** Check the orifice in the idle orifice tube jet and if larger than 0.0276 inch, replace the tube. Examine the adjustment screw. Replace the screw if the seating surface is scored or damaged.

e. **Inspect Accelerating Pump.** Inspect the accelerating pump plunger and piston assembly and replace the assembly if any parts are worn or damaged.

f. **Inspect Accelerating Pump Jet and Check Balls.** Inspect the jet and if the orifice is larger than 0.0315 inch, replace the jet. Examine the intake and discharge check balls and if either are corroded or damaged, replace the part. Replace the discharge check ball spring if rusted or distorted.

**CARTER CARBURETOR MODEL ETW1**

**g. Inspect Step-up Piston and Jet.** Inspect the step-up piston and rod assembly and if damaged, replace the assembly. Replace the spring if rusted or distorted. Check the step-up jet and if the orifice is larger than 0.0413 inch, replace the jet.

**h. Inspect Choker Valve and Shaft.** Make certain the small poppet valve and spring in the choker valve are not damaged. Inspect the shaft seal and replace if worn or damaged. Inspect the lever spring and replace if stretched or distorted.

**i. Inspect Body Flange Assembly.** Inspect the idle adjustment screw seat and threads. If the seat is scored or the threads are damaged, replace the body flange assembly. Inspect the throttle valve to make certain it is tight on the shaft and does not rub the body flange causing resistance to the movement of the throttle shaft. Test the movement of the shaft and if there is any friction in the shaft bearings, replace the body flange assembly. Do not attempt to remove the shaft or bearings.

**j. Inspect Carburetor Body and Air Horn.** Inspect the castings for cracks or damage. Check the gasket and flange surfaces to make sure they are not warped or damaged. Make certain all passages are clean and install the new passage rivet plugs.

**5. ASSEMBLY OF CARBURETOR.**

**a. Install Choker Shaft and Valve (6, fig. 5).** Place the seal and retainer washer in the recess in the air horn and slide the shaft through the air horn. Place the choker tube bracket in position and install the mounting screw. Install the choker valve with the small poppet valve down.

**b. Install Idle Orifice Tube and Main Metering Jet (fig. 5).** Screw the idle orifice tube and plug assembly into the top of the float bowl (3, fig. 5). Place a new gasket on the main metering jet and screw the jet into the bottom of the float bowl directly under the float valve (2, fig. 5).

**c. Install Step-up Jet (1, fig. 5).** Place a new gasket on the step-up jet and screw the jet into the hole at the bottom of the float bowl and adjacent to the step-up cylinder.

**d. Install Accelerating Pump Jet (1, fig. 6).** Screw the accelerating pump jet into place and install the rivet plug.

**e. Install Accelerating Pump Discharge Check Ball (5, fig. 4).** Place the larger of the two balls in the opening adjacent to the pump cylinder. Install the check spring and the pump discharge passage plug.



**CARTER CARBURETOR AND GOVERNOR REBUILDING**

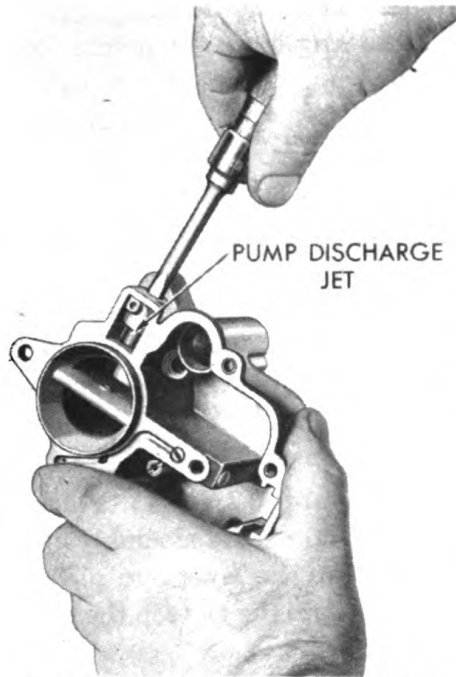

**1—INSTALLING ACCELERATING PUMP JET**

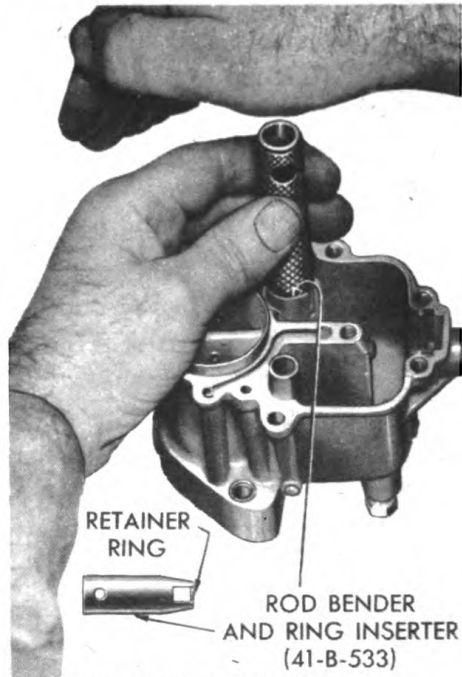

**2—INSTALLING PUMP INTAKE CHECK BALL RETAINING RING**

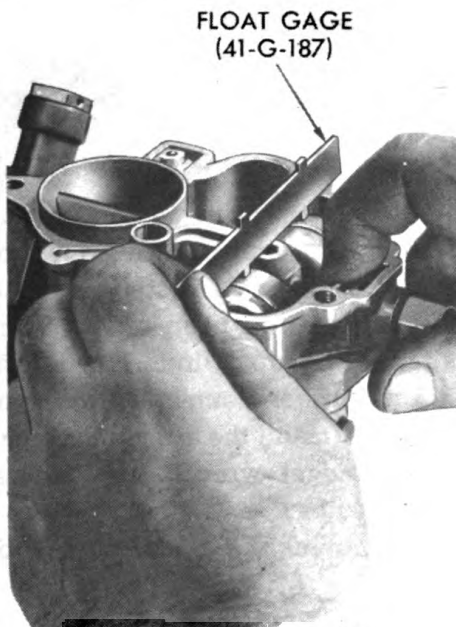

**3—CHECKING FLOAT SETTING**

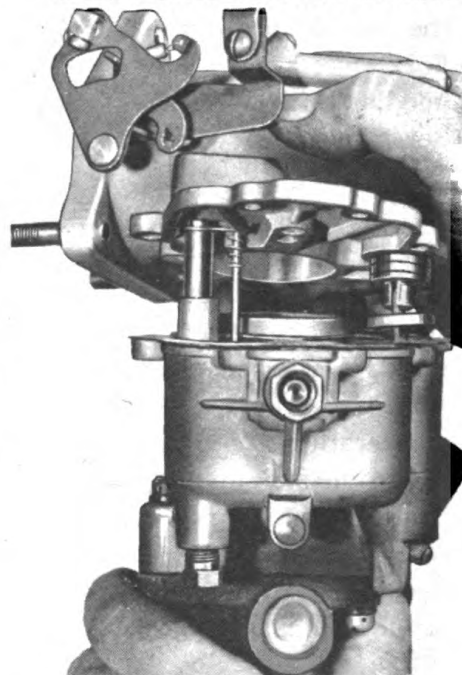

RA PD 53697

**Figure 6—Carburetor Rebuilding**

**CARTER CARBURETOR MODEL ETW1**

f. **Install Accelerating Pump Intake Check Ball (2, fig. 6).** Drop the smaller check ball into the seat in the bottom of the pump cylinder. Place the check ball retaining ring in the ring inserter (federal stock number 41-B-533). Insert the tool and ring into the pump cylinder with the opening in the ring opposite the ball seat. Turn the tool slightly to register the slots in the tool with the lugs in the cylinder, then strike the tool handle with the hand to force the ring into place.

g. **Install Body Flange and Governor Assembly.** Place the idle adjustment spring over the idle adjustment screw and turn the screw in against its seat in the body flange. *Use fingers only.* Use of screwdriver or other means of forcing the screw on the seat will damage the seat and screw. Back the screw off the seat approximately one turn. Use a new gasket and install the flange assembly to the carburetor body (3, fig. 4). Install lock wires through screw heads.

h. **Install Float, Seat and Needle Assembly (2, fig. 4).** Place the float needle in the seat and install the seat and needle assembly with a new gasket. Insert the float lever pin through the lever and place the float in position. Slide the lever pin retainer into the slots in the casting with the open ends down.

i. **Check Float Setting (3, fig. 6).** Place the float setting gage (federal stock number 41-G-187) across the carburetor body with the  $\frac{5}{64}$ -inch projection down and directly over the floats. Hold the float lever tightly against the needle to raise the floats and seat the needle. Both floats should just touch the projections on the gage. If not, lift the float out and bend the float lever slightly to get the correct float setting.

j. **Install Air Horn Assembly (4, fig. 6).** Place a new gasket on the carburetor body. Drop the step-up piston spring in the step-up cylinder and install the piston, plate and rod assembly. Press down on step-up piston and plate to determine if rod is seating in step-up jet. If slight clearance does not exist between plate and head of rod, more than one gasket may have been installed in step-up cylinder. Install the accelerating pump assembly. Place the air horn assembly over the pump and step-up pistons and into position. Install the attaching screws using  $1\frac{1}{32}$ -inch open end wrench from midget wrench set (federal stock number 41-W-900) to install the two hex head screws. Place a new gasket over the main tube and plug assembly and screw the tube into the float bowl cover.

**6. DISASSEMBLY OF GOVERNOR.**

a. **Remove Governor Assembly (1, fig. 7).** Remove seal and cover attaching screws. Bend the lock away from the cam retaining

CARTER CARBURETOR AND GOVERNOR REBUILDING

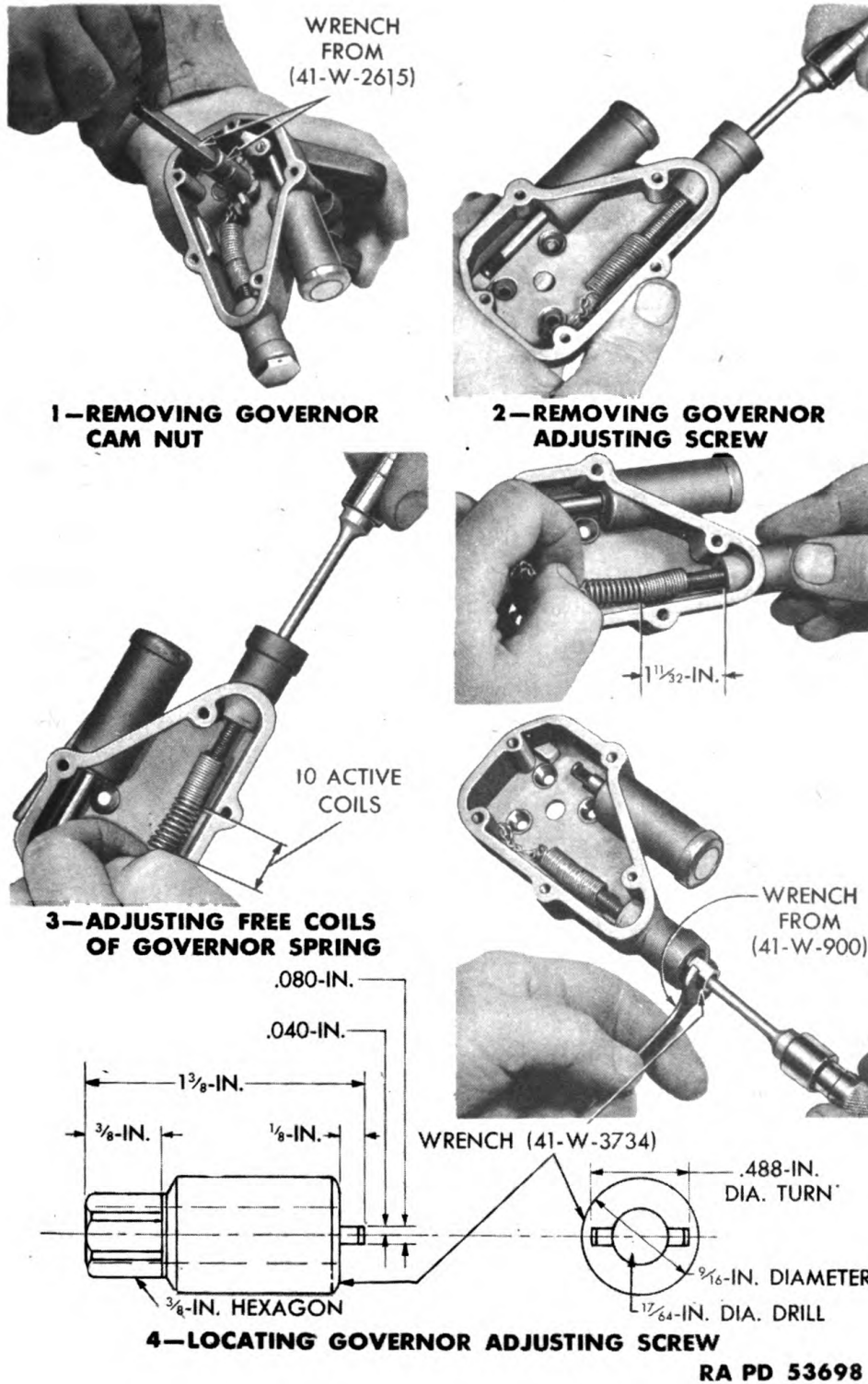

Figure 7—Governor Rebuilding

**CARTER CARBURETOR MODEL ETW1**

nut and remove the nut and cam. Remove the countersunk screws which hold the housing to the body flange and slide the governor off the throttle shaft. Remove the spring washer and plain washer from the throttle shaft.

b. **Remove Governor Spring and Adjusting Screw (2, fig. 7).** Remove the adjustment passage plug and turn the adjusting screw clockwise until it is out of the adjusting nut. Then hold the spring and turn the screw counterclockwise to remove the spring.

**7. INSPECTION AND REPAIR OF GOVERNOR PARTS.**

a. **Clean Parts.** Wash the housing and all parts in dry-cleaning solvent and dry with compressed air.

b. **Inspect Housing and Cover.** Inspect the gasket surfaces of the housing and cover and if damaged or warped so that the gasket will not form a good seal or if threads are stripped in screw holes, replace the damaged part.

c. **Inspect Piston.** Move the piston rod in and out of the cylinder. If the piston is not perfectly free to move in the cylinder, replace the governor housing and piston assembly.

d. **Inspect Spring and Adjusting Screw.** Inspect the spring and if it is distorted or does not close squarely when released, replace the spring. If the chain links show wear replace the chain. Inspect the adjusting screw for being straight and examine the threads. Replace the screw if it is damaged in any way.

**8. ASSEMBLY OF GOVERNOR.**

a. **Install Adjusting Screw and Spring (fig. 7).** Screw the adjusting screw through the spring until the head of the screw is flush with the chain end of the spring. Hook the chain to the spring and engage the extended end of the spring in the slot in the housing. Insert a screwdriver through the adjusting nut and turn the adjusting screw counterclockwise through the nut until 10 coils of the spring are free from the head of the adjusting screw (3, fig. 7). Hold the spring open and measure the distance from the end of the screw in the spring to the cylindrical boss on the housing. This measurement should be  $1\frac{11}{32}$  inch (4, fig. 7). If not, hold the adjusting screw and turn the adjusting nut with special wrench (federal stock number 41-W-3734) in the direction required to correct the measurement (4, fig. 7). Install the adjustment passage plug and gasket.

b. **Install Governor Assembly.** Install the plain washer then the spring washer on the throttle shaft. Place the governor housing in position with the small lug in the slot in the body flange and install

**CARTER CARBURETOR AND GOVERNOR REBUILDING**

attaching screws. Lay the assembly so that the piston rod is on a horizontal plane and slide the rod out until the end of the rod is about  $\frac{1}{4}$  inch from the housing. Hook the chain to the cam and while holding the throttle open, install the cam over the flats on the shaft and enter the roller in the slot of the piston rod. Install the cam retaining nut and lock. Hold the throttle lever in the open position and install the housing cover gasket.

**c. Adjustment of Governor on Engine.**

(1) **WARM UP ENGINE AND TEST MANIFOLD VACUUM.** Run the engine until normal operating temperature is reached. The manifold vacuum must be at least 16 inches with the engine operating at full throttle and at least 17 inches at idling speed with an allowable reduction of approximately  $3\frac{1}{2}$  inches at 5000 feet above sea level. If vacuum is low, eliminate deficiencies responsible before changing governor adjustments.

(2) **ADJUSTMENT OF ENGINE SPEED.** The adjusting screw which is attached to the spring controls the maximum engine speed. Remove the adjustment passage plug and turn the screw clockwise to decrease and counterclockwise to increase the maximum engine speed. Adjust the governor to a maximum engine speed of 3200 revolutions per minute or a road speed of nine miles per hour in low gear with no load.

(3) **ADJUSTMENT FOR SURGE.** The adjusting nut through which the screw is threaded provides an adjustment to eliminate surge. If surge (continued rapid rise and fall of engine speed) is experienced at full throttle and no engine deficiencies are responsible, adjust the governor for surge. Insert a screwdriver through the adjusting nut wrench and engage the screwdriver in the adjusting screw slot. Hold the screwdriver to prevent the screw from turning and move the adjusting nut clockwise  $\frac{1}{4}$ -turn at a time, correcting the engine speed with the adjusting screw until the surge is eliminated. If the governor has been disassembled and no surge is apparent, move the adjusting nut counterclockwise a quarter of a turn at a time correcting the engine speed with the adjusting screw until the engine surges at full throttle. Then just eliminate the surge as outlined above, as the engine operates most efficiently when the governor is adjusted just beyond the joint where surge occurs at full throttle. Install adjustment passage plug and seal.

