

**ELECTRICAL
COMMUNICATION SYSTEMS
EQUIPMENT**



WAR DEPARTMENT

2 OCTOBER 1944

RESTRICTED. *DISSEMINATION OF RESTRICTED MATTER.*
The information contained in restricted documents and the essential characteristics of restricted materiel may be given to any person known to be in the service of the United States and to persons of undoubted loyalty and discretion who are cooperating in Government work, but will not be communicated to the public or to the press except by authorized military public relations agencies. (See also par. 28, AR 380-5, 15 Mar 1944.)

SC
3585
A

WAR DEPARTMENT,
WASHINGTON 25, D.C., 2 OCTOBER 1944.

TM 11-487, Electrical Communication Systems Equipment, is published for the information and guidance of all concerned.

[A. G. 300.7 (12 Sep 44).]

BY ORDER OF THE SECRETARY OF WAR:

G. C. MARSHALL,
Chief of Staff.

OFFICIAL:

J. A. ULIO,
Major General,
The Adjutant General.

DISTRIBUTION:

IBn 1, 11 (3); IC 5, 11, 55 (6).
(For explanation of symbols, see FM 21-6.)

TABLE OF CONTENTS

	<u>Paragraph</u>	<u>Page</u>
<u>CHAPTER 1 - PURPOSE AND SCOPE</u>		
Purpose	101	1
Scope	102	1
References to Other Manuals	103	1
Ordering of War Department Publications	104	1
<u>CHAPTER 2 - ILLUSTRATIVE PROBLEMS</u>		
Section I	General	
	Introduction	201
Section II	Problems Illustrating Systems Planning	
	General	202
	Problem 1 - Spiral-four System	203
	Diagram of Communication System Employing Spiral-four Cable, Carrier Telephone, Telegraph and Associated Equipment	204
	Summary of Equipment for Telephone and Telegraph Systems Illustrated in Paragraph 204	205
	Problem 2 - Four-channel Radio Relay Carrier Communication System	206
	Diagram of Four-channel Radio Relay Carrier Communication System	207
	Summary of Equipment for Four-channel Radio System Illustrated in Paragraph 207	208
	Problem 3 - Tactical Open Wire Carrier Tele- phone and Telegraph System	209
	Diagram of Open Wire Carrier Telephone and Telegraph System	210
	Summary of Equipment for Open Wire Carrier Telephone and Telegraph System Illustrated in Paragraph 210	211
	Problem 4 - Fixed Plant Open Wire Communication System	212
	Diagram of Fixed Plant Open Wire Communication System	213
	Summary of Packaged Equipment for Fixed Plant Open-Wire Communication System Illustrated in Paragraph 213	214
	Problem 5 - Interconnection of D-C Telegraph Circuits at Junction of Fixed Plant and Tactical Carrier Systems	215
	Diagram of Interconnection of D-C Telegraph Circuits at Junction of Fixed Plant and Tactical Carrier System	216
	Summary of Telegraph Equipment for Problem Illustrated in Paragraph 216 (See paragraphs 1011, 1028 and 1315)	217
	Problem 6 - Fixed Plant Multiple Switchboard Plan for Fixed Plant Common Battery, Multiple Switchboard	218
	Sample Switchboard Order	219
	Estimate of Weights and Volumes of Central Office Equipment	220
Section III	Telephone System Comparisons	221
	General	222
	Comparison of Means of Obtaining Four, or Sixteen, Telephone Circuits	223
	Comparison of Means of Obtaining Four Tele- phone Circuits - 100 Miles	224
	Comparison of Means of Obtaining 16 Telephone Circuits - 100 Miles	225
	Equipment for 100-Mile Four-channel Radio System Assumed in Paragraph 224	226

TABLE OF CONTENTS (Cont'd.)

		<u>Paragraph</u>	<u>Page</u>
	Wire Systems	227	25
	Summary of Material Requirements for 100-Mile Tactical Carrier Systems Using Telephone Terminal Set TC-21-()	228	26
	Summary of Material Requirements for 300-Mile Systems Using Fixed Plant Open Wire Lines and Equipment	229	27
<u>CHAPTER 3 - TELEPHONE STATION EQUIPMENT</u>			
Section I	General		
	Scope	301	29
Section II	Microphones and Receivers		
	General	302	29
	Microphones (Telephone Transmitters)	303	29
	Microphones - Description and Stock Numbers	304	30
	Microphone Response Frequency Characteristics	305	35
	Telephone Receivers	306	36
	Receivers - Description and Stock Numbers	307	36
	Telephone Receiver Response Frequency Characteristics	308	37
Section III	Telephone Sets		
	General	309	37
	Headsets - Description and Stock Numbers	310	38
	Head and Chest Sets - Description and Stock Numbers	311	44
	Chest Sets - Description and Stock Numbers	312	45
	Handsets - Description and Stock Numbers	313	46
Section IV	Telephones		
	General	314	47
	Telephones - Description and Stock Numbers	315	47
Section V	Loudspeakers		
	General	316	49
	Loudspeakers - Description and Stock Numbers	317	49
<u>CHAPTER 4 - TELEPHONE CENTRALS</u>			
Section I	General Description		
	General	401	51
	Telephone Switchboard Fundamental Features	402	51
	Switchboard Working Limits	403	51
	Testboards and Test Cabinets	404	51
	Monitoring, Observing and Recording Facilities	405	51
Section II	Tactical Telephone Switchboards and Central Office Sets		
	Adapter Plug U-4/GT	406	52
	Magneto Switchboards	407	52
	Combined Magneto and Common Battery Switchboards	408	52
	Lengths of Station Line Wire and Cable for Various Switchboard Transmission and Working Limits	409	53
	Tactical Telephone Switchboards and Central Office Sets - Equipment Data	410	54
	Tactical Telephone Switchboards and Central Office Sets - Description	411	62
	Tactical Telephone Switchboards and Central Office Sets - Working Limits in Ohms	412	65
	Tactical Telephone Switchboards and Central Office Sets - Transmission Losses in DB at 1000 Cycles	413	66
	Tactical Telephone Switchboard and Central Office Sets - Stock Numbers and Logistical Data	414	66

TABLE OF CONTENTS (Cont'd.)

		<u>Paragraph</u>	<u>Page</u>
Section III	Fixed Plant Telephone Switchboards		
	General	415	67
	Single Position Switchboards	416	67
	Multiple Switchboards	417	67
	Fixed Plant Single Position Telephone Switchboards - Equipment Data	418	69
	Fixed Plant Single Position Telephone Switchboards - Description	419	74
	Fixed Plant, Single Position Telephone Switchboards - Working Limits in Ohms	420	77
	Fixed Plant, Single Position Telephone Switchboards - Transmission Losses in DB at 1000 Cycles	421	78
	Fixed Plant, Single Position Telephone Switchboards and Associated Equipment - Stock Numbers and Logistical Data	422	78
	Fixed Plant Multiple Telephone Switchboards - Equipment Data	423	79
	Fixed Plant Multiple Telephone Switchboards - Description	424	89
	Fixed Plant Multiple Telephone Switchboards - Working Limits in Ohms	425	91
	Fixed Plant Multiple Telephone Switchboards - Transmission Losses in DB at 1000 Cycles	426	91
	Fixed Plant Multiple Telephone Switchboards and Associated Equipment - Logistical Data	427	92
Section IV	Test Cabinets and Testboards		
	General	428	92
	Test Cabinets and Testboards - Description	429	93
	Test Cabinets, and Testboards - Stock Numbers and Logistical Data	430	96
Section V	Monitoring, Observing and Recording Facilities		
	General	431	97
	Monitoring, Observing, and Recording Facilities - Description	432	98
	Monitoring, Observing, and Recording Facilities - Stock Numbers and Logistical Data	433	102
<u>CHAPTER 5 - PORTABLE AWS INFORMATION CENTERS</u>			
	General	501	103
	Types of Equipment	502	103
	AWS Information Centers - Description	503	103
	AWS Information Centers - Stock Numbers and Logistical Data	504	108
<u>CHAPTER 6 - WIRE AND CABLE AND CONSTRUCTION INFORMATION</u>			
Section I	General		
	Introduction	601	109
Section II	Open Wire Lines		
	General	602	109
	Storm Loading	603	109
	Bare Wires and Wire Messenger - Physical Data and Stock Numbers	604	110
	Transmission Data on Open Wire Lines	605	111
	Materials for Construction of Tactical Open Wire Lines with 4 x 4 Lumber Supports, 150-foot Spans, Light Storm Loading Areas	606	112
	Materials for Construction of Tactical Open Wire Lines with Round Poles, 150-foot Spans, Heavy Storm Loading Areas	607	113

TABLE OF CONTENTS (Cont'd.)

		<u>Paragraph</u>	<u>Page</u>
	Materials for Construction of Tactical Open Wire Lines with Round Poles, 200-foot Spans, Medium Storm Loading Areas	608	114
	Materials for Construction of Open Wire Lines for Fixed Plant, 150-foot Spans, All Storm Loading Areas	609	115
	Open Wire Lines - Shipping Data	610	116
Section III	Field Wires and Field Cables		
	General	611	117
	Spiral Four with Messenger Support	612	117
	Long Range Tactical Wire W-143	613	117
	Field Wires and Cables - Physical Data and Stock Numbers	614	118
	Transmission Data on Rubber-insulated Wire and Cables	615	121
	Materials for Construction of Spiral-four Cable Lines	616	122
	Spiral-four Cable Lines - Shipping Data	617	123
Section IV	Lead-covered Cables and Loading		
	General	618	123
	Lead-covered Cables - Physical Data and Stock Numbers	619	123
	Voice Frequency Lead-covered Cable Loading Equipment - Description	620	125
	Loading Equipment for Voice-Frequency Cable Circuits - Stock Numbers and Logistical Data	621	127
	Mounting Hardware for Loading Coil Cases	622	127
	Transmission Data on Lead-covered Cables	623	127
	Materials for Construction of Aerial Cable Lines - 150-foot Spans - All Storm Loading Areas	624	128
	Lead Sleeves for Straight Splices	625	130
	Lead Sleeves for Bridge Splices	626	131
	Materials for Splicing Lead-covered Cables	627	132
Section V	Construction Time and Information on Poles		
	General	628	133
	Estimated Time Required for Work Operations	629	133
	Rates of Field Wire Construction	630	134
	Dimensions of Round Poles (American Standard)	631	135
	Weights of Round Poles (American Standard)	632	136
	Dimensions and Weights of 2 x 4 and 4 x 4 Lumber Supports (American Standard)	633	136
Section VI	Construction Equipment, Vehicles and Tools		
	General	634	136
	Wire and Cable Placing and Recovering Equipment - Description and Stock Numbers	635	137
	Special Purpose Trucks and Trailers for Line Construction and Maintenance	636	141
	Line Construction Tool Equipment	637	144
	Lead-covered Cable Splicer's Tool Equipment	638	145
	Vulcanizing Equipment for Rubber-covered Cables	639	145
	Line Survey Tools and Materials	640	145
Section VII	Submarine Cable		
	Submarine Cable for Tactical Use	641	145
	Submarine Cable for Fixed Plant	642	146
	Submarine Cables - Physical Data and Stock Numbers	643	146

TABLE OF CONTENTS (Cont'd.)

		<u>Paragraph</u>	<u>Page</u>
CHAPTER 7 - EUROPEAN AND UNITED STATES CABLES AND LOADING SYSTEMS			
Section I	Coil Loaded Lead-covered Cables		
	Introduction	701	147
	European Cable Loading Systems - Scope	702	147
	European Cable Loading Systems - Data	703	147
	Typical European Loaded Cables - Approximate 1000-cycle Loss per Mile (1608 Meters) vs Nominal Impedance	704	148
	Type of Coil Loaded Cable Circuits in International Telephone Facilities	705	149
	C.C.I.F. Standard Loading Systems	706	155
	Loading Systems for Repeater Sections in International Telephone Circuits	707	155
	United States Loading Systems	708	156
	Loading Systems Commonly used in the United States of America	709	157
	Lead-covered Entrance and Intermediate Cables in Open Wire Lines Commonly Used in the United States of America	710	158
Section II	Existing Submarine (Undersea) Cables		
	General	711	159
	Paper-insulated Telephone Cables	712	159
	Paper-insulated Quadded Submarine Cables - British Isles	713	159
	Loaded Paper-insulated Spiral-four Submarine Cables - German-made	714	160
	Gutta-Percha, Balata, Paragutta and Rubber- insulated Telephone Cables	715	161
	Loaded Multicore Gutta-Percha Submarine Cables	716	163
	Telegraph Cables	717	163
	European Cable Map	718	163
CHAPTER 8 - ELECTRICAL PROTECTIVE EQUIPMENT			
	General	801	165
	Protector Blocks - Description and Stock Numbers	802	165
	Fuses for Telephone Lines - Description and Stock Numbers	803	166
	Heat Coils - Description and Stock Numbers	804	167
	Telephone Protectors for One Pair of Wire - Description and Stock Numbers	805	167
	Terminals for Protecting Small Switchboards and Telephones Served by Lead-covered Cables - Description	806	170
	Terminals for Protecting Small Switchboards and Telephones Served by Lead-covered Cables - Stock Numbers and Logistical Data	807	171
	Cable Protectors - Description and Stock Numbers	808	172
	Cable Terminals with Protection - Pole Mounted - Description	809	173
	Cable Terminals with Protection - Pole Mounted - Stock Numbers and Logistical Data	810	174
	Main Frame Protection for Larger Switchboards - Description	811	175
	Main Frame Protection for Larger Switchboards - Stock Numbers and Logistical Data	812	176

TABLE OF CONTENTS (Cont'd.)

		<u>Paragraph</u>	<u>Page</u>
<u>CHAPTER 9 - TELEPHONE LINE TRANSMISSION EQUIPMENT</u>			
Section I	General		
	Scope and Use	901	177
Section II	Tactical Equipment		
	General	902	177
	Descriptive Information	903	177
	Stock Numbers and Logistical Data	904	177
	Summary of Equipment Requirements	905	177
	Voice Frequency Repeaters and Misc. Equipment - Tactical - Description	906	178
	Voice Frequency Ringing Equipment - Tactical - Description	907	181
	Carrier Telephone Equipment - Tactical - Description	908	183
	Telephone Line Transmission Sets - Tactical - Component Parts	909	188
	Telephone Line Transmission Equipment - Tactical - Stock Numbers and Logistical Data	910	189
	Summary of Equipment Required for 4-Wire Carrier Operation over Spiral-four Cable or Open Wire	911	190
	Summary of Equipment Required for 2-Wire Carrier Operation over Open Wire Using Converter CF-4-()	912	190
	Summary of Equipment Required for 2-Wire Carrier Operation over Open Wire Using Carrier Hybrid CF-7	913	190
Section III	Fixed Plant Equipment		
	General	914	191
	Descriptive Information	915	191
	Stock Numbers and Logistical Data	916	191
	Voice Frequency Telephone Equipment - Fixed Plant - Description	917	192
	Voice Frequency Ringing Equipment - Fixed Plant - Description	918	195
	Carrier Telephone Equipment - Fixed Plant - Description	919	197
	Apparatus Cabinets for Telephone Line Trans- mission Equipment - Fixed Plant - Description	920	202
	Telephone Line Transmission Equipment - Fixed Plant - Stock Numbers and Logistical Data	921	203
	Selection of Equipment	922	204
	Selection of Packaged Telephone Transmission Equipment - Fixed Plant - Equipment Required per Circuit	923	205
	Selection of Telephone Line Transmission Equipment - Fixed Plant - Common Equipment Required per Office	924	207
	Examples of Use of Packaged Equipment	925	209
	H Carrier Packaged Equipment on a Single Open Wire Pair	926	210
	C Carrier Packaged Equipment on a Single Open Wire Pair	927	211
	C and H Carrier Packaged Equipment on Two Open Wire Pairs	928	212
<u>CHAPTER 10 - TELEGRAPH EQUIPMENT</u>			
Section I	General		
	Introduction	1001	215
Section II	Telegraph and Teletypewriter Tactical Equipment		
	General	1002	215
	Descriptive Information	1003	215
	Stock Numbers and Logistical Data	1004	215
	Illustrations	1005	215
	D-c Wire Telegraph Equipment - Tactical - Description	1006	216

TABLE OF CONTENTS (Cont'd.)

	<u>Paragraph</u>	<u>Page</u>
	Carrier Telegraph Equipment - Tactical - Description	1007 220
	Teletypewriter Equipment - Tactical - Description	1008 222
	Teletypewriter Sets - Tactical - Component Parts	1009 224
	Telegraph and Teletypewriter Equipment - Tactical - Stock Numbers and Logistical Data	1010 227
	Telegraph and Teletypewriter Sets - Tactical - Stock Numbers and Logistical Data	1011 228
	Point-to-Point Teletypewriter Circuit (Neutral Line Transmission)-Tactical Equipment	1012 230
	Diagram of a Point-to-Point Tactical Teletypewriter Circuit (Neutral Line Transmission)	1013 230
	Point-to-Point Teletypewriter Circuit (Polarential and Two-Path Polar Line Transmission) - Tactical Equipment	1014 230
	Diagram of a Point-to-Point Tactical Teletypewriter Circuit (Polarential and Two-Path Polar Line Transmission) - Tactical Equipment	1015 231
	Teletypewriter Switching Network - Tactical Equipment	1016 231
	Diagram of a Teletypewriter Switching Network - Tactical Equipment	1017 232
	D-c Loop Connections for Telegraph Terminal CF-2-B (Carrier) - Tactical Equipment	1018 232
	Diagram of Connections for D-c Loops of Telegraph Terminal CF-2-B (Carrier) - Tactical Equipment	1019 233
Section III	Telegraph and Teletypewriter Fixed Plant Equipment	
	General	1020 233
	Descriptive Information	1021 233
	Stock Numbers and Logistical Data	1022 233
	Illustrations	1023 233
	D-c Wire Telegraph Equipment - Fixed Plant - Description	1024 234
	Carrier Telegraph Equipment - Fixed Plant - Description	1025 236
	Teletypewriter and Automatic Morse Code Equipment - Fixed Plant - Description	1026 238
	Radioteletype Terminal and Associated Signal Center Teletypewriter Equipment - Fixed Plant - Description	1027 242
	Telegraph, Teletypewriter and Automatic Morse Code Equipment - Fixed Plant - Stock Numbers and Logistical Data	1028 245
	Packaged Telegraph Equipment on Open Wire Lines - Fixed Plant	1029 246
	Diagram of Packaged Telegraph Equipment on Open Wire Lines	1030 247
	Radioteletype Terminal and Signal Center	1031 248
	Diagram of a Radioteletype Terminal and Signal Center	1032 248
Section IV	Telegraph and Teletypewriter Testing Equipment, Tool Equipment and Teletypewriter Supplies	
	General	1033 248
	Teletypewriter Supplies - Tactical and Fixed Plant - Description and Stock Numbers	1034 248

TABLE OF CONTENTS (Cont'd.)

		<u>Paragraph</u>	<u>Page</u>
<u>CHAPTER 11 - FACSIMILE EQUIPMENT</u>			
	General	1101	251
	Tape Facsimile Equipment RC-58-B	1102	251
	Facsimile Equipment RC-120	1103	251
	Facsimile Set AN/TXC-1	1104	251
	Facsimile Equipment - Description	1105	252
	Facsimile Equipment - Stock Numbers and Logistical Data	1106	257
	Expendable Supplies	1107	257
<u>CHAPTER 12 - POWER EQUIPMENT</u>			
Section I	General		
	Scope and Use	1201	259
Section II	Engine Driven Generator Sets		
	General	1202	259
	Description of Tactical Engine Generator Sets	1203	259
	Stock Numbers and Logistical Data for Tactical Engine Generator Sets	1204	259
	Description of Fixed Plant Engine Generator Sets	1205	259
	Stock Numbers and Logistical Data for Fixed Plant Engine Generator Sets	1206	259
	Engine Generator Sets - Tactical - Description	1207	260
	Engine Generator Sets - Tactical - Arranged by Capacities	1208	264
	Engine Generator Sets - Tactical - Stock Numbers and Logistical Data	1209	265
	Engine Generator Sets - Fixed Plant - Description	1210	266
	Engine Generator Sets - Fixed Plant - Arranged by Capacities	1211	273
	Engine Generator Sets - Fixed Plant - Stock Numbers and Logistical Data	1212	273
Section III	Rectifiers		
	General	1213	274
	Rectifiers - Description	1214	275
	Rectifiers - Stock Numbers and Logistical Data	1215	281
Section IV	Power Ringing Units		
	General	1216	284
	Ringing Equipment - Description	1217	284
	Ringing Equipment - Stock Numbers and Logistical Data	1218	287
Section V	Batteries		
	Lead Storage Batteries	1219	287
	Dry Batteries	1220	287
	Lead Storage Batteries - Description	1221	289
	Lead Storage Batteries - Stock Numbers and Logistical Data	1222	294
	Electrolyte (Sulphuric Acid)	1223	294
	Battery Terminal Adapter	1224	294
	Dry Batteries - Description - Single Unit Types	1225	295
	Dry Batteries - Description - Multiple Unit Types	1226	297
	Dry Batteries - Stock Numbers and Commercial Equivalents	1227	300

TABLE OF CONTENTS (Cont'd.)

		<u>Paragraph</u>	<u>Page</u>
Section VI	Commercial Power Services		
	General	1228	304
	Distribution	1229	304
	Power Distribution Data - Foreign Countries and Cities	1230	304
	Power Distribution Data for Canada - Breakdown by Provinces (McGraw Central Station Directory - 1938)	1231	311
	Power Distribution Data for Alaska - Breakdown by Cities	1232	311
 <u>CHAPTER 13 - MAINTENANCE SUPPLIES</u> 			
Section I	General		
	Scope	1301	313
Section II	Maintenance		
	System of Maintenance	1302	313
	Maintenance Parts - Supply Plan	1303	315
	Signal Supply Catalogs	1304	315
	Relationship of Signal Supply Catalog to Supply Plan	1305	316
Section III	Maintenance Equipments		
	General	1306	318
	Description and Stock Numbers	1307	318
	Maintenance Equipments - Description	1308	319
	Maintenance Equipments - Stock Numbers and Logistical Data	1309	329
Section IV	Tool Equipments		
	General	1310	330
	Tool Equipments and Tool Sets - Description	1311	331
	Tool Equipments - Stock Numbers and Logistical Data	1312	337
Section V	Test Equipments		
	General	1313	337
	Test Equipments and Test Packages - Description	1314	338
	Test Equipments - Stock Numbers and Logistical Data	1315	341
Section VI	Test Sets		
	General	1316	341
	Test Sets and Test Instruments - Description	1317	342
	Test Sets - Stock Numbers and Logistical Data	1318	361
Section VII	Cross Reference Data		
	General	1319	362
	Cross Reference Table of Maintenance, Tool and Test Equipments, and Test Sets	1320	362
 <u>CHAPTER 14 - RADIO EQUIPMENT</u> 			
Section I	General		
	Introduction	1401	369
	Photographs	1402	369
Section II	Tactical Radio Sets for Ground Use		
	General	1403	369
	Radio Sets - Description	1404	369
	Frequency Range Chart	1405	370
	Radio Sets - Stock Numbers and Logistical Data	1406	370
	Remote Control Equipment	1407	370
	Radio Sets for Ground Use - Tactical - Descriptive and Technical Data	1408	372
	Frequency Coverage of Tactical Radio Sets for Ground Use	1409	428
	Ground, Transportable Radio Sets - Stock Numbers and Logistical Data - Tactical	1410	430
	Vehicular Radio Sets - Stock Numbers and Logistical Data - Tactical	1411	430
	Pack Radio Sets - Stock Numbers and Logistical Data - Tactical	1412	431

TABLE OF CONTENTS (Cont'd.)

	<u>Paragraph</u>	<u>Page</u>
	Air Transportable Radio Sets - Stock Numbers and Logistical Data - Tactical	1413 431
	Ground, Mobile Radio Sets - Stock Numbers and Logistical Data - Tactical	1414 431
	Remote Control Equipment for Radio Sets - Tactical - Description	1415 432
	Remote Control Equipment - Tactical - Stock Numbers and Logistical Data	1416 440
Section III	Fixed Plant Radio Equipment	
	General	1417 440
	Command Radio Sets - Description	1418 440
	Command Radio Sets - Stock Numbers and Logistical Data	1419 441
	Airways Section Radio Sets - Description	1420 441
	Airways Section Radio Sets - Stock Numbers and Logistical Data	1421 441
	Transmitting Equipment Commonly Used by Command Radio - Army Communication Service - Description	1422 442
	Receiving Equipment Commonly Used by Command Radio - Army Communication Service - Description	1423 450
	Transmitting Equipment Commonly Used by Command Radio - Army Communications Service - Stock Numbers and Logistical Data	1424 452
	Receiving Equipment Commonly Used by Command Radio - Army Communications Service - Stock Numbers and Logistical Data	1425 452
	Transmitting Equipment Commonly Used by Airways Section - Army Communications Service - Description	1426 453
	Receiving Equipment Commonly Used by Airways Section - Army Communications Service - Description	1427 470
	Combined Transmitting and Receiving Equipment Commonly Used by Airways Section - Army Communications Service - Description	1428 476
	Transmitting Equipment Commonly Used by Airways Section - Army Communications Service - Stock Numbers and Logistical Data	1429 486
	Receiving Equipment Commonly Used by Airways Section - Army Communications Service - Stock Numbers and Logistical Data	1430 488
	Combined Transmitting and Receiving Equipment Commonly Used by Airways Section - Army Communications Service - Stock Numbers and Logistical Data	1431 489
Section IV	Antennas and Associated Equipment	
	General	1432 489
	Antenna Kits - Tactical	1433 490
	Wire Used for Antenna Equipment - Tactical	1434 491
	Coaxial Cables for Radio Frequency Transmission Lines	1435 492
	Mast Assemblies for Supporting Antennas - Tactical	1436 494
	Mast Sections for Antenna Supports	1437 494
	Metallic Mast Sections for Vertical Radiators for Ground Use	1438 494
	Metallic Mast Sections for Vehicular Radiators	1439 495
	Accessories Used in Constructing Tactical Antennas	1440 495
	Antenna Kits - Fixed Plant	1441 496
	Antenna Coupling Unit	1442 497
	Base Insulated Towers Used as Vertical Radiators - Fixed Plant	1443 497
	Towers for Supporting Antennas - Fixed Plant	1444 498
	Ground System for Radio Towers - Fixed Plant	1445 499
	Tower Lighting Equipment - Fixed Plant	1446 500
Index		501

LIST OF ILLUSTRATIONS

<u>Figure</u>		<u>Page</u>
301	Handset TS-9-()	30
302	Microphone T-17	32
303	Microphone T-30-()	32
304	Microphone T-34-A	32
305	Microphone T-44-()	33
306	Microphone T-45	33
307	Microphone T-50-()	33
308	Microphone ANB-M-C1	33
309	Handset TS-10	34
310	Headset P-11	40
311	Headset P-16	40
312	Headset HS-20	40
313	Headset HS-23-()	41
314	Headset HS-24	41
315	Headset HS-30-()	41
316	Headset HS-30-()	42
317	Headset HS-33-()	43
318	Headset HS-38	43
319	Head and Chest Set HS-17-A	44
320	Head and Chest Set HS-19	44
321	Chest Set TD-1	45
322	Chest Set TD-3	45
323	Chest Set TD-4	45
324	Telephone EE-8-()	48
325	Telephone Box EE-91	48
326	Telephone TP-6	48
327	Loudspeaker LS-3	49
328	Loudspeaker LS-7	49
401	Adapter Plug U-4/GT	52
402	Switchboard BD-9	55
403	Switchboard BD-11	55
404	Switchboard BD-14	55
405	Switchboard BD-71	55
406	Switchboard BD-72	55
407	Switchboard SB-5()/PT	56
408	Two Telephone Central Office Sets TC-2 (Assembled)	56
409	Telephone Central Office Set TC-4	57
410	Telephone Central Office Set TC-12	58
411	Telephone Central Office Set TC-1 (Assembled)	59
412	Telephone Central Office Set TC-10 (Assembled)	60
413	Telephone Central Office Set TC-20	61
414	No. 508B Switchboard (Western Electric Co.)	70
415	No. 5508C Switchboard (Modified) (Western Electric Co.)	70
416	No. 551B (Special per X-66070) Switchboard (Western Electric Co.)	70
417	No. 551B Switchboard (Modified) (Western Electric Co.)	71
418	G1 Switchboard (Western Electric Co.)	71
419	No. 45JR Switchboard (Kellogg Switchboard & Supply Co.)	71
420	K100 Switchboard (Kellogg Switchboard & Supply Co.)	72
421	No. 150E Switchboard (Kellogg Switchboard & Supply Co.)	72
422	Magneto Switchboard (Stromberg-Carlson Co.)	73
423	No. 106 Switchboard (Stromberg-Carlson Co.)	73
424	No. 1000 Switchboard - Floor Plan (North Electric Manufacturing Co.)	81
425	No. 6-800 Switchboard (Kellogg Switchboard & Supply Co.)	81
426	No. 119 Switchboard - Floor Plan (Automatic Electric Co.)	82
427	No. 12 Switchboard (Western Electric Co.)	83
428	No. 12 Switchboard - Floor Plan (Western Electric Co.)	83
429	No. 605A Switchboard (Western Electric Co.)	84
430	No. 605A Switchboard - Floor Plan (Western Electric Co.)	84
431	No. 15 Switchboard (Stromberg-Carlson Co.)	85
432	No. 1600 Switchboard (Kellogg Switchboard & Supply Co.)	85

LIST OF ILLUSTRATIONS (Cont'd.)

<u>Figure</u>		<u>Page</u>
433	No. 12-1600 Switchboard (Kellogg Switchboard & Supply Co.)	86
434	No. 18 Switchboard (Stromberg-Carlson Co.)	86
435	No. 2800 Switchboard - Floor Plan (Kellogg Switchboard & Supply Co.)	87
436	No. 11 Switchboard (Western Electric Co.)	88
437	No. 11 Switchboard - Floor Plan (Western Electric Co.)	88
438	Cabinet BE-70-()	95
439	Mobile Test Unit X-68699A	95
440	Test and Control Board per X-66034A or X-66034B	95
441	Toll Line Observing Cabinet ADW-BM-100	100
442	Toll Line Patching Cabinet ADW-BM-100	100
443	Multiline Observing Cabinet ADW-BM-100	101
444	Five-Line Observing Cabinet ADW-BM-100	101
445	Recorder (Amertype Recordgraph Co. "Commando" Model A)	101
501	Information Center System SCS-5	105
502	Information Center System SCS-5-(). (Typical Frames)	106
503	Operations Center AN/TPQ-1	106
504	Operations Center AN/TPQ-1. Equipment Packed in Truck	107
505	Operations Center AN/TPQ-1. Equipment Mounted in Trucks as Mobile Tactical Control Center	107
506	Control Set SCR-572-A	107
601	Cable Assembly CC-345 on Reel DR-7	120
602	Cable Assembly CC-358 (Spiral-four Aerial Construction)	120
603	Coil C-114-A (Loading Coil)	120
604	Loading Coil Case 204CG (Western Electric Co.)	126
605	Loading Coil Case 208A (Western Electric Co.)	126
606	Loading Coil Case 124C (Western Electric Co.)	126
607	Loading Coil Case 125A (Western Electric Co.)	126
608	Reel Equipment CE-11	136
609	Reel Cart RL-35 with 3 Reels DR-4	138
610	Reel DR-5	138
611	Reel DR-15	138
612	Reel Cart RL-16 with 2 Reels DR-4	139
613	Reel Unit RL-17	139
614	Reel Unit RL-26-A with Reels DR-5	139
615	Reel Unit RL-31-B	140
616	Plow LC-61	140
617	Trailer K-36	141
618	Trailer K-37	141
619	Trailer K-38 with Cable Splicer's Tool Equipment TB-56	142
620	Truck K-43	143
621	Truck K-44-B	143
701	European Cable Map	164
801	Telephone Protector Blocks (Cook)	165
802	Telephone Protector Blocks (Reliable)	165
803	Telephone Protector Blocks (Western Electric Co. 26 and 27)	165
804	Fuses (Cook A-9 and A-12)	166
805	Fuses (Reliable 55 and 106)	166
806	Fuses (Western Electric Co. 11C, 7A, and 7T)	166
807	Fuses (Western Electric Co. 60D or 60E)	166
808	Heat Coil (Western Electric Co. 76A)	167
809	Telephone Protector (Cook B-13)	167
810	Telephone Protector (Cook C-9)	168
811	Telephone Protector (Reliable 955)	168
812	Telephone Protector (Reliable 1000)	168
813	Telephone Protector (Western Electric Co. 95A)	168
814	Telephone Protector (Western Electric Co. 1093A)	169
815	Terminals for Protecting Small Switchboards (Western Electric Co. LC-26)	171
816	Terminal for Protecting Small Switchboards (Western Electric Co. LA-26)	171

LIST OF ILLUSTRATIONS (Cont'd.)

<u>Figure</u>		<u>Page</u>
817	Cable Protector (Cook 7)	172
818	Cable Protector (Reliable 222)	172
819	Cable Protector (Western Electric Co. 83A)	172
820	Cable Terminal with Protection (Western Electric Co. EA26)	173
821	Cable Terminal with Protection (Western Electric Co. B Type)	174
822	Protected Main Distributing Frame (Wall Mounted) (Western Electric Co.)	176
823	Protected Main Distributing Frame (Floor Mounted) (Western Electric Co.)	176
901	Telephone Repeater EE-89-A	179
902	Telephone Repeater EE-99-A	179
903	Telephone TP-9	180
904	Repeating Coil C-161	180
905	Ringling Equipment EE-100-()	182
906	Ringling Equipment EE-101-()	182
907	Telephone Terminal CF-1-A	185
908	Repeater CF-3-A	185
909	Converter CF-4-()	186
910	Repeater CF-5-()	186
911	Carrier Hybrid CF-7	187
912	Telephone Unit EE-105	187
913	Panel; Line Terminating and Simplex; Telephone X-61823H	193
914	Panel; Line Terminating and Composite; Telephone X-61823C	193
915	Repeater Package; Telephone; V.F. (Single) X-61821J	194
916	Repeater Package; Telephone; V.F. (Triple) X-61821K	194
917	Ringer Package; Voice Frequency; 4 Circuit X-61820A	196
918	Ringer Package; Telephone; Voice Frequency TA-3/FT	196
919	Terminal Package; Telephone; H Carrier X-66217A	199
920	Repeater Package; Telephone; H Carrier X-66217B	200
921	Panel; Line Filter and Balancing; Telephone X-66217C	200
922	Terminal Package; Telephone; C Carrier X-61819P or R	201
923	Repeater Package; Telephone; C Carrier X-61819S	201
1001	Line Unit EE-77-A or EE-77-B	217
1002	Repeater TG-30 (Terminal)	218
1003	Repeater TG-31 (Intermediate)	218
1004	Switchboard BD-100	219
1005	Telegraph Set TG-5-B	219
1006	Telegraph Terminal CF-2-A	221
1007	Telegraph Terminal CF-2-B	221
1008	Telegraph Terminal CF-6-A	221
1009	Teletypewriter TG-7A	223
1010	Reperforator Transmitter TG-26-()	223
1011	Telegraph Central Office Set TC-3	226
1012	Teletypewriter Set EE-97-A	226
1013	Repeater Package; Telegraph; D.C. X-61824A	235
1014	Repeater Package; Telegraph; Regenerative X-66031A	235
1015	Telegraph Switchboard SB-6-()/GG	235
1016	Telegraph Carrier Package; X-61822A or B	237
1017	Telegraph Terminal TH-1/TCC-1	237
1018	Teletypewriter Set Model 15	240
1019	Teletypewriter Set Model 19	240
1020	Teletypewriter Set AN/TGC-1	240
1021	Boehme Automatic Keying and Recording Equipment	241
1022	Radioteletype Terminal Equipment AN/FGC-1	243
1023	Teletypewriter Subscriber Set 132A2	243
1024	Transmitter-Distributor XD91	243
1025	Oscillator Exciter O-5/FR (Press Wireless FS12A Keyer)	244
1101	Tape Facsimile Equipment RC-56-B	255
1102	Facsimile Equipment RC-120	256
1103	Facsimile Transceiver FX-1-B	256
1104	Converter CV-2/TX	256

LIST OF ILLUSTRATIONS (Cont'd.)

<u>Figure</u>		<u>Page</u>
1201	Power Unit PE-75-D	262
1202	Power Unit PE-77-B	262
1203	Power Unit PE-95-() Part of Trailer K-52	262
1204	Power Unit PE-99-E	263
1205	Power Unit PE-108-A	263
1206	Power Unit PE-197	263
1207	Power Unit PE-201-B	263
1208	Power Unit PE-214-A	264
1209	Power Unit PE-214-B	264
1210	Power Unit PE-78-F	268
1211	Power Unit PE-79-F	268
1212	Power Unit PE-81-E	268
1213	Power Unit PE-85-F	268
1214	Power Unit PE-85-L	268
1215	Power Unit PE-85-M	268
1216	Power Unit PE-95-F	269
1217	Power Unit PE-142-C	269
1218	Power Unit PE-142-D	269
1219	Power Unit PE-142-E	269
1220	Power Unit PE-148-A	269
1221	Power Unit PE-167-A	269
1222	Power Unit PE-205-A or PE-207-A	270
1223	Power Unit PE-205-B	270
1224	Power Unit PE-215-A	270
1225	Power Unit PE-220-A or B	271
1226	Power Unit PE-235-A	271
1227	Power Unit PE-236-A	272
1228	Power Unit PU-19/FRC	272
1229	Engine Generator (Onan WSM-13)	272
1230	Engine Generator (Kohler 1M21A)	272
1231	Tungar Rectifier (G.E.Co. 3049455)	277
1232	Tungar Rectifier (G.E.Co. 6RB4B7)	277
1233	Tungar Rectifier (G.E.Co. 6RB33B2)	277
1234	Tungar Rectifier (G.E.Co. 6RB6B17)	278
1235	Tungar Rectifier (G.E.Co. 9X649)	278
1236	Rectifier RA-36-()	278
1237	Grid Controlled Rectifier RA-43-()	279
1238	Copper Oxide Rectifier (Raytheon Mfg. Co. W-3155, W-1067, and W-2168A)	279
1239	Rectifier RA-37	280
1240	Rectifier RA-87	280
1241	Rectifier RA-83-()	280
1242	Interrupter (Western Electric Co. Types 84F or G)	285
1243	Telering (Telkor Model H)	285
1244	Converter M-222	286
1245	Subcycle Static Frequency Converter	286
1246	Battery BB-54	291
1247	Battery BB-29	291
1248	Battery BB-51	291
1249	Battery BB-55	292
1250	Battery BB-46	292
1251	Battery BB-50	293
1252	Battery BB-53	293
1253	Battery Terminal Adapter	294
1254	Dry Battery Terminal Arrangements	299
1301	Echelons of Signal Repair - Theatre of Operations	313
1302	Flow of Supplies - Thru Depot Supply Channels - and Thru Maintenance Repair	314
1303	Test Set I-49	350
1304	Test Set I-51	350
1305	Test Set I-61-A	351
1306	Volt ohmmeter I-166	351
1307	Tube Tester I-177	351
1308	Test Set I-181	352

LIST OF ILLUSTRATIONS (Cont'd.)

<u>Figure</u>		<u>Page</u>
1309	Test Set I-193-A	352
1310	Test Set KE-65-C, D, or E	353
1311	Test Set TS-2/TC	353
1312	Test Set TS-26/TSM	354
1313	Test Set TS-27/TSM	354
1314	Attenuator (Western Electric Co. 5A)	355
1315	Transmission Measuring Set (Western Electric Co. 13A)	355
1316	Cable Fault Locating Equipment (Part of Tool Equipment TS-36-A)	356
1317	Oscillator (Western Electric Co. 19C)	357
1318	Transmission Measuring Set (Western Electric Co. 32A)	357
1319	Oscillator (Western Electric Co. 51A)	358
1320	Test Set (Western Electric Co. 1017E)	358
1321	Volt-ohm-milliammeter (Western Electric Co. D-166252)	359
1322	Volt-ohm-milliammeter (Western Electric Co. D-169370)	359
1323	Test Set (Teletype Corp. No. DED-1)	360
1401	Radio Set SCR-131 or SCR-161	398
1402	Radio Set SCR-171	398
1403	Radio Set SCR-177-A	399
1404	Radio Set SCR-177-B	399
1405	Radio Set SCR-178 or SCR-179	400
1406	Radio Set SCR-188	400
1407	Radio Set SCR-188-A	401
1408	Radio Set SCR-193-()	401
1409	Radio Set SCR-194	402
1410	Radio Set SCR-195	402
1411	Radio Set SCR-197	402
1412	Radio Set SCR-203	402
1413	Radio Set SCR-209	403
1414	Radio Set SCR-210	403
1415	Radio Set SCR-245	404
1416	Radio Set SCR-284	404
1417	Radio Set SCR-288	405
1418	Radio Set SCR-293	405
1419	Radio Set SCR-294	405
1420	Radio Set SCR-298-C	406
1421	Radio Set SCR-299	406
1422	Radio Set SCR-300	407
1423	Radio Set SCR-399	407
1424	Radio Set SCR-499	408
1425	Radio Set SCR-506	408
1426	Radio Set SCR-508	408
1427	Radio Set SCR-509	409
1428	Radio Set SCR-510	409
1429	Radio Set SCR-511	410
1430	Radio Set SCR-528	410
1431	Radio Set SCR-536	410
1432	Radio Set SCR-538	410
1433	Radio Set SCR-543	411
1434	Radio Set SCR-593	411
1435	Radio Set SCR-606	411
1436	Radio Set SCR-609	412
1437	Radio Set SCR-610	412
1438	Radio Set SCR-619	413
1439	Radio Set SCR-624	413
1440	Radio Set SCR-628	413
1441	Radio Set SCR-694-AW (Receiver Removed from case)	414
1442	Radio Set SCR-694-C	414
1443	Radio Set SCR-808	414
1444	Radio Set SCR-828	414
1445	Receiving Equipment RC-256	415
1446	Radio Transmitter RC-257	415
1447	Radio Set AN/CRC-3	415
1448	Amplifier Equipment AN/TRA-1	416
1449	Radio Set AN/TRC-1	416
1450	Radio Set AN/TRC-2	417
1451	Radio Terminal Set AN/TRC-3	417
1452	Radio Relay Set AN/TRC-4	418

LIST OF ILLUSTRATIONS (Cont'd.)

<u>Figure</u>		<u>Page</u>
1453	Radio Set AN/TRC-7	418
1454	Radio Set AN/TRC-8	419
1455	Radio Terminal Set AN/TRC-11	420
1456	Radio Set AN/TRC-12	420
1457	Radio Set AN/VRC-1	421
1458	Inverted L Antenna	421
1459	Crowfoot Antenna	422
1460	Whip Antenna and Counterpoise	423
1461	Whip Antennas	423
1462	Short Whip Antenna	423
1463	Center-fed Horizontal Dipole Antenna	424
1464	Single Wire-fed Half-wave Antenna	424
1465	Half-Wave J Antenna	424
1466	Sloping Wire Antenna	425
1467	Balanced Half Wave Dipole Antenna	425
1468	Adjustable Coaxial Antenna	425
1469	Vertical Half Rhombic Antenna	425
1470	Three Element Directional Array	426
1471	Vertical Conical Dipole Antenna	426
1472	Ground Plane Antenna	426
1473	Half-wave Corner Reflector Antenna	427
1474	Remote Control Equipment AN/TRA-2	436
1475	Remote Control Equipment RC-47-()	436
1476	Remote Control Equipment RC-261 with Radio Set SCR-619	437
1477	Remote Control Unit RM-39-()	437
1478	Remote Control Unit RM-7-() with Radio Transmitter BC-325-()	438
1479	Remote Control Unit RM-14	439
1480	Remote Control Unit RM-21	439
1481	Remote Control Unit RM-29-()	439
1482	Radio Transmitter BC-339-()	444
1483	Radio Transmitter BC-365-()	444
1484	Radio Transmitter BC-447-() and Remote Control Unit RM-7	444
1485	Radio Set SCR-281	444
1486	10KW Transmitting Equipment	445
1487	Radio Amplifying Equipment (Dunnell 6 KW)	446
1488	Radio Transmitter (Press Wireless PW-15-())	447
1489	Radio Transmitter (Press Wireless PW-40-())	448
1490	Radio Transmitter (Press Wireless 981-())	449
1491	Single Side Band Transmitter (Western Electric Co. D-156000)	449
1492	Diversity Receiver AN/PRR-3	451
1493	Radio Receiver BC-779-() (Hammarlund Super Pro)	451
1494	Diversity (Schuttig) Mixing Unit	451
1495	Single Side Band Receiver (Western Electric Co. D-99945)	451
1496	Radio Transmitter BC-315	458
1497	Radio Transmitter BC-325-()	458
1498	Power Amplifier BC-340-()	459
1499	Radio Transmitter BC-401	459
1500	Radio Transmitter BC-460	459
1501	Radio Transmitter BC-610	460
1502	Radio Transmitter BC-642	460
1503	Radio Transmitter BC-1100-()	461
1504	Radio Transmitting Equipment RC-52-()	461
1505	Radio Transmitter T-4/PRC & T-5/PRC Installation	462
1506	Radio Transmitter (Aircraft Accessories Corp. 500B)	463
1507	Radio Transmitter (Collins 3ERA)	463
1508	Radio Transmitter (Federal FT-300)	464
1509	Radio Transmitter (Pan American Airways 12ACK-2)	464
1510	Radio Transmitter (Pan American Airways)	465
1511	Power Amplifier (Pan American Airways RFA-50)	466
1512	Radio Transmitter (Press Wireless PW-10LF)	466
1513	Radio Transmitter (Temco 250-GSC)	467
1514	Radio Transmitter (Temco 1000-AG-CW)	467
1515	Radio Transmitter (Western Electric Co. D-151249 or Pan American Airways 4WTFA)	467

LIST OF ILLUSTRATIONS (Cont'd.)

<u>Figure</u>		<u>Page</u>
1516	Radio Transmitter (Wilcox 96-A)	468
1517	Four Radio Transmitters (Wilcox 96C) (With Modulator 50A and Rectifier 36A)	468
1518	Radio Transmitter (Wilcox 96-200-())	469
1519	Radio Receiver (Federal 128AY)	473
1520	Radio Receiver (Hallicrafters S-22-R)	473
1521	Radio Receiver (Hallicrafters S-27)	473
1522	Radio Receiver AN/GRR-3 (Hallicrafters SX-28)	473
1523	Radio Receiver (Hallicrafters S-29)	474
1524	Radio Receiver (Hallicrafters S-36)	474
1525	Radio Receiver AN/GRR-2 (National NC-100-ASC)	474
1526	Radio Receiver (National HRO)	475
1527	Radio Receiver (Wilcox CW3)	475
1528	Radio Receiver (Wilcox CW3-D)	475
1529	Radio Receiver (Wilcox F3)	475
1530	Radio Receiver and Transmitter (Collins 18-Q) (Navy TCS)	477
1531	Radio Receiver and Transmitter (Jefferson 350A)	478
1532	Radio Receiver and Transmitter (Link 50UFS)	478
1533	Radio Set Type 1498 (Link)	479
1534	Radio Set Type 1505 (Link)	479
1535	Radio Receiver and Transmitter (Motorola FMTR-25WM and FMTR-50BW)	480
1536	Transmitting Horizontal Rhombic Antenna	480
1537	Transmitting Doublet Antenna	481
1538	Intermediate Frequency Flat Top Antenna	482
1539	Receiving Horizontal Rhombic Antenna	483
1540	Double Doublet Receiving Antenna	483
1541	Double Cage Antenna	484
1542	Insulated Tower Antenna	485
1543	T Cage Antenna	485
1544	Wave Antenna	485

CHAPTER 1
PURPOSE AND SCOPE

101. PURPOSE. This manual provides descriptive matter and data on the electrical and physical characteristics of communication systems equipment, together with Signal Corps stock numbers and logistical data, which will be of value in planning complete communication systems. The material contained herein is intended for use primarily by staff signal officers and communication organizations under their technical control.

102. SCOPE.

a. The Manual is divided into 14 chapters as follows:

1. Purpose and Scope
2. Illustrative Problems
3. Telephone Station Equipment
4. Telephone Centrals
5. Portable AWS Information Centers
6. Wire and Cable and Construction Information
7. European and United States Cables and Loading Systems
8. Electrical Protective Equipment
9. Telephone Line Transmission Equipment
10. Telegraph Equipment
11. Facsimile Equipment
12. Power Equipment
13. Maintenance Supplies
14. Radio Equipment

b. (1) In general the data in each chapter have been arranged in tabular form, each table being listed as a paragraph. Most of the chapters are divided into sections, wherein are grouped the same general classes of equipment.

(2) For each class of equipment tables are given which contain descriptive matter, references to photographs which follow the tables, field of use, maintenance equipment, physical characteristics, electrical characteristics, references to Technical Manuals, and other pertinent information.

(3) Other tables contain the stock numbers of the equipment and the logistical data. The logistical data include the weight of the heaviest package, the total weight, the total cubical content and the total ship tons of the equipment packed for export. Data are also given for the weight and cubical content of the equipment removed from its export packing case. These data may be of value in determining depot storage requirements and transport needed to move the equipment.

(4) In some chapters additional tables and illustrative drawings are given. These are provided as a guide to assure that the proper equipment and an adequate amount will be requisitioned for the particular communication system which it is planned to establish.

c. In general the equipment has been classified either as tactical equipment

or as fixed plant equipment. This has been done for convenience and is not intended to give a sharp line of demarcation between tactical and fixed plant since some equipment may serve well in both forward and rear areas. In the case of the more complicated communication systems, it may be necessary to obtain engineering advice and assistance from the Army Communications Service of the Office of the Chief Signal Officer.

d. Typical problems are given which outline a method for determining the equipment required for complete systems. In addition, representative radio and wire telephone transmission systems are compared from the standpoint of the quantities of material required.

e. Some information is also given concerning commercial cable facilities which may be found in the United States and in European countries, since a general knowledge of the characteristics of these cable systems may be found useful in case plans are made to utilize them.

f. This manual provides information only on electrical communication equipment used for ground communication systems. It does not give information on equipment such as direction finders and radar, except for the ground communication equipment associated with them.

103. REFERENCES TO OTHER MANUALS.

a. The use of this manual for planning presupposes a knowledge of systems engineering and of the general types and quantities of communication equipment required for a particular job. Information concerning these matters may be found in the following Army publications:

- (1) TM 11-486, Electrical Communication Systems Engineering
- (2) TM 11-2022, Application of Fixed Plant Telephone and Telegraph Packaged Equipment to Open Wire Lines
- (3) M409, Logistical Planning and Reference Data
- (4) FM 101-10, Staff Officers Field Manual - Organization, Technical and Logistical Data
- (5) FM 11-5, Mission, Functions, and Signal Communications in General
- (6) FM 11-20, Organizations and Operations in the Corps, Army, Theater of Operations, and GHQ
- (7) FM 24-5 Signal Communication
- (8) FM 24-18 Radio Communication

b. Reference is also made in the various chapters to other technical manuals and instruction books which apply to specific systems or equipments.

104. ORDERING OF WAR DEPARTMENT PUBLICATIONS. Technical Manuals and other War Department publications may be requisitioned from the various headquarters which are listed as distributing agencies. This information is covered in FM 21-6, "List of Publications for Training".

This Page Intentionally Blank

CHAPTER 2
ILLUSTRATIVE PROBLEMS

Section I
General

201. INTRODUCTION.

a. This chapter provides illustrations of the use of the material given in this manual in planning ground communication systems.

b. Problems illustrating the use of the data in ordering equipment for wire and radio ground communication systems are given in section II. In these problems it is assumed that the officer doing the planning has completed the engineering work and has reached certain conclusions as to the general type of communication equipment required.

c. Comparative illustrations of logistical factors involved in representative radio and wire telephone transmission systems are given in section III. Other comparisons may be made by employing the material given in subsequent chapters of the manual.

Section II
Problems Illustrating Systems Planning

202. GENERAL.

a. In the following paragraphs problems are given which illustrate some of the uses of the material given in the manual. In all of these examples it is assumed that the circuits have been engineered and that the problem to be solved is one of ordering the proper equipment and estimating the shipping space requirements.

b. Problems are included which employ the following facilities.

- (1) Spiral four cable with carrier telephone and telegraph terminals.
- (2) Four channel radio with carrier telephone and telegraph terminals.
- (3) Open wire with tactical carrier telephone and telegraph terminals.
- (4) Open wire with packaged telephone and telegraph equipment.
- (5) Interconnection of d-c telegraph circuits at junction of tactical and fixed plant carrier systems.
- (6) Telephone switchboards.

203. PROBLEM 1 - SPIRAL-FOUR SYSTEM.

a. Telephone and telegraph facilities are required between the two main offices A and B and certain outlying points. From engineering considerations it has been determined that these will be provided as shown in paragraph 204. This figure shows a spiral-four carrier telephone system between Offices A and B with repeaters at Offices C, D and E. A voice frequency carrier telegraph system is operated over one channel of the carrier

telephone system with terminals at Offices A and B. At these offices certain of the telegraph channels are extended to outlying points over the simplex circuit of existing telephone facilities. It is assumed that the spiral-four cable between Offices A and B, a distance of 100 miles, is to be buried with an average of one aerial road crossing per mile strung on a messenger.

b. The circuits provided by the layout shown in paragraph 204 are as follows.

	Circuit No.	Circuit Terminals	Facilities Used
Telephone	1	A-B	Carrier Telephone Channel
	2	A-B	Carrier Telephone Channel
	3	A-B	Carrier Telephone Channel
Telegraph	1	A-B	Carrier Telegraph Channel
	2	A-F	Carrier Telegraph Channel A-B, and Simplex on Existing Telephone Circuit B-F
	3	A-G	Carrier Telegraph Channel A-B, and Simplex on Existing Telephone Circuit B-G
	4	B-I	Carrier Telegraph Channel B-A, and Simplex on Existing Telephone Circuit A-I
	5	A-C	Spiral-Four Simplex
	6	B-H	Spiral-Four Simplex B-E, Simplex on Existing Telephone Circuit E-H

c. The equipment required to obtain these facilities, with the exception of that required for the outside plant, is itemized in paragraph 204. The equipment is listed for each office under the headings of Telephone Equipment and Telegraph Equipment. Certain spare equipment is assumed for this particular layout is also listed. In addition to the equipment shown, Cable Assemblies CC-35B, and other outside plant for 100 miles of line are required. The material required includes poles, messenger wire, etc. for one aerial road crossing per mile.

d. Data on the carrier telephone and telegraph equipments including spares

are obtained from chapters 9 and 10. Monitoring teletypewriters are not included because it is assumed that these are available with existing telegraph equipment. In addition to the carrier equipment, repeating coils for simplex-ing the existing telephone circuits are required (chapter 9). The power equipment, included under the list of spare equipment, is covered in chapter 12 and the outside plant equipment in chapter 6.

e. Paragraph 205 summarizes the equipment required for the entire project. This summary gives the stock numbers of the various items for ordering purposes

together with essential logistical information. The equipment, weights, volumes, etc. shown in paragraph 205 should not be confused with similar data contained in TM 11-2001, which covers the equipment and cable for a 100-mile spiral-four system, including depot spares (100% spare cable). The problem discussed in this paragraph covers a communication system involving circuits to outlying offices and telegraph facilities as well as a 100-mile spiral-four system; 25% spare cable is assumed to be ordered for the installation and no depot spares are included.

204. DIAGRAM OF COMMUNICATION SYSTEM EMPLOYING SPIRAL-FOUR CABLE, CARRIER TELEPHONE, TELEGRAPH AND ASSOCIATED EQUIPMENT.

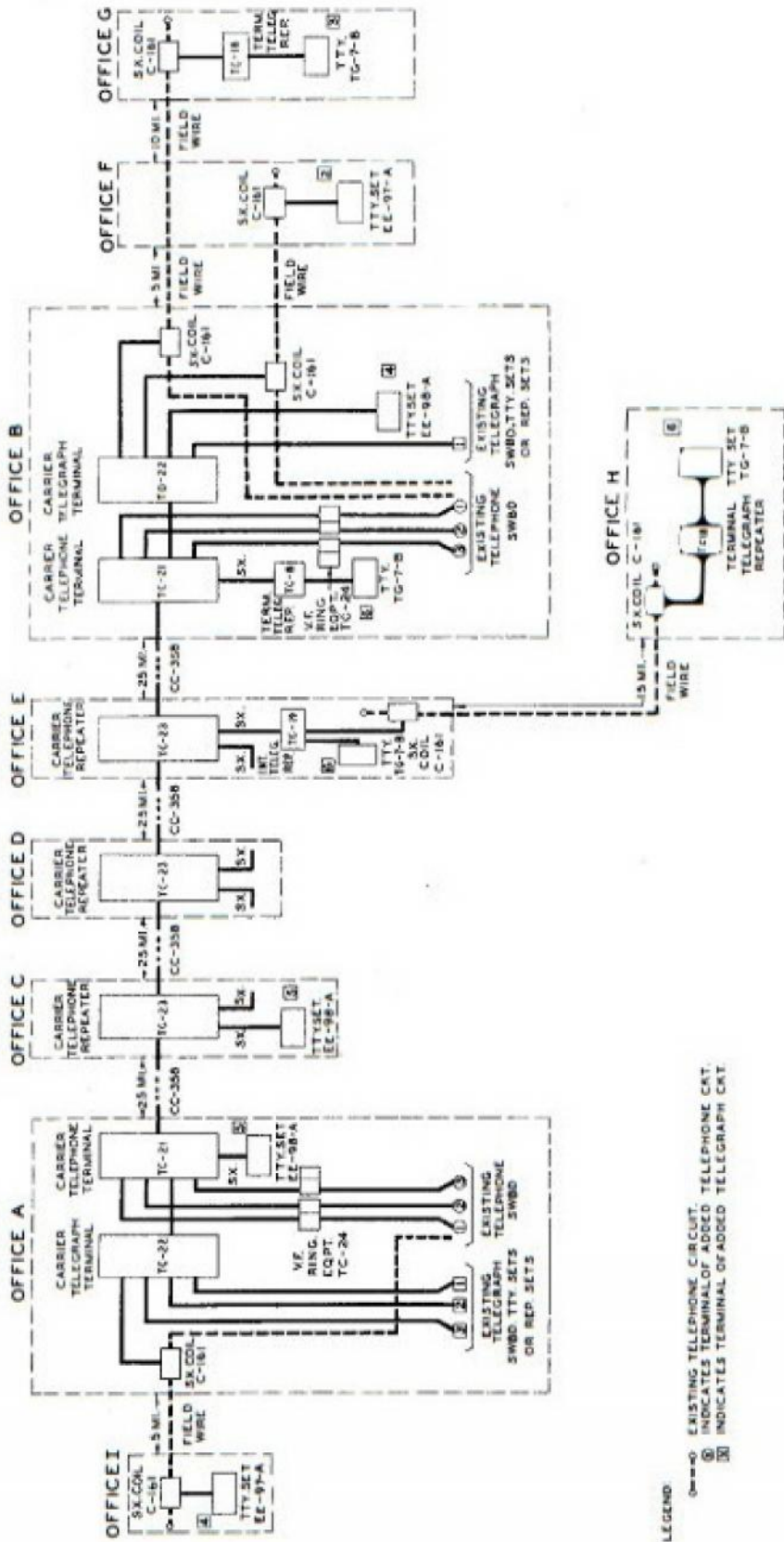

OFFICE I	OFFICE A	OFFICE C	OFFICE D	OFFICE E	OFFICE H	OFFICE B	OFFICE F	OFFICE G
TELEPHONE EQPT. 1, C-181	TELEPHONE EQPT. 1, TC-23(-)	TELEPHONE EQPT. 1, TC-23(-)	TELEPHONE EQPT. 1, TC-23(-)	TELEPHONE EQPT. 1, TC-23(-)	TELEPHONE EQPT. 1, C-181	TELEPHONE EQPT. 1, TC-21(-)	TELEPHONE EQPT. 1, C-181	TELEPHONE EQPT. 1, C-181
TELEGRAPH EQPT. 1, EE-97-A	TELEGRAPH EQPT. 1, EE-98-A 1, PE-214(-)	TELEGRAPH EQPT. 1, EE-98-A 1, PE-214(-)	TELEGRAPH EQPT. NONE	TELEGRAPH EQPT. 1, TC-19 1, TS-7-B 1, 1-193-A SPARE EQPT. 2, PE-214(-)	TELEGRAPH EQPT. 1, TC-18 1, TG-7-B	TELEGRAPH EQPT. 2, TC-24(-) 2, C-181	TELEGRAPH EQPT. 1, EE-97-A	TELEGRAPH EQPT. 1, TC-18 1, TG-7-B
	TELEGRAPH EQPT. 1, TC-22(-) 1, EE-98-A 1, 1-193-A SPARE EQPT. 1, CF-7-A 1, CF-7-B 1, EE-98-A 1, EE-98-A 1, PE-75(-) 1, BA-93(-)							

OUTSIDE PLANT EQPT.
EQUIPMENT FOR 100 MI. OF BURIED
SPIRAL-4 CABLE

205. SUMMARY OF EQUIPMENT FOR TELEPHONE AND TELEGRAPH SYSTEM ILLUSTRATED IN PARAGRAPH 204.

Quantity	Description	Stock No.	Weight - lbs.		Volume - Cu.Ft.		Ship Tons
			Export	Net	Export	Net	
a. Line Transmission Equipment							
(1) Telephone Equipment (See paragraph 210)							
2	Telephone Terminal Set TC-21-()	480360-21()	2940	2380	124	80	3.0
3	Repeater Set TC-23-()	483223()	3450	2058	128	84	3.3
4	Buzzer Set TC-24-()	472124	1750	1360	56	40	1.6
8	Repeating Coil C-151	3C151	40	24	-	-	-
(2) Telegraph Equipment (See paragraphs 1010, 1011, 1013 and 1312)							
2	Telegraph Terminal Set TC-22-()	4A2222B	3080	2260	170	90	4.4
3	Repeater Set TC-18	4A2118	585	438	20	10	0.6
1	Repeater Set TC-19	4A2119	188	136	7	3	0.2
2	Teletypewriter Set EE-97-A	472297A	1400	910	75	34	2.0
3	Teletypewriter Set EE-98-A	472298A	1641	939	96	36	2.2
4	Teletypewriter TG-7-B	472207A-1	1600	900	108	35	2.8
2	Test Set TS-2/TG	47220700	320	140	24	5	0.6
2	Test Set I-193-A	3F4193	190	150	9	4	0.3
(3) Spare Equipment (See chapters 9, 10 and 18)							
1	Telephone Terminal CP-1-A	482361	735	475	44	20	1.1
1	Repeater CP-3-A	483203	340	225	18	8	0.5
1	Ringing Equipment EE-101-()	472101	140	95	4	2	0.1
1	Telegraph Terminal CP-2-B	4A2222B	750	575	42	20	1.0
2	Teletypewriter Set EE-98-A	472298A	1094	625	64	24	1.6
2	Power Unit PE-75-()	324275()	890	660	28	22	0.7
				(No Case)		(No Case)	
6	Power Unit PE-214-()	324600-214	480	322	21	25	0.5
1	Rectifier RA-22-()	324699-22	54	50	2	1	-
Total Equipment			21,594	14,900	1039	543	26.7
b. Outside Plant - Buried Spiral-Four Cable 100 Miles Long; 1 Road Crossing Per Mile with Messenger Wire (See Paragraphs 616 and 633)							
500	Lumber, Treated 4" x4" x18'	5A2718	32,500	32,500	1000	1800	25
500	Cable Assembly CC-358, 1/4 mi. per Reel CC-15	1B1458					
50	Cable Assembly CC-368	1B1458	88,400	88,400	2440	2440	61
15	Cable Stub CC-358	1B1458					
500	Bolt, Machine 5/8" x 10" GS	5B1510-10					
1100	Clamp, Deadend - Kearny Lay-Cit. or equal	5B3094					
250	Hook, PF-61, drive	5B5061					
25 lbs	Marlin WF-2	5Z6961					
6 lbs	Nail, common wire, 12-d	6L1412					
300	Sleeve, GS, for 109 Guy Wire (S-109-2)	6N5709-2	2,200	2,200	35	35	1
100 lbs	Talc, 200 mesh, Grade A, white Mehnick-Tumpewer, Inc., New York, N.Y. or equal						
1000	Washer, square, GI, 2-1/4" with 11/16" hole	5B2029-11					
2000 ft.	Wire W-110-B	1B110B					
1000 lbs	Wire W-145, 109GS	1A145					
30,000 ft.	Wire, Messenger, E.E. W Utilities Grade, 3/16" dia. (W.E.Co. Spec. AT-7035)	1A503					
1000	Clamp, PF-61, two bolt	5B3061	2,900	2,900	180	150	3.8
3500	Hanger, cable for CC-358 per SCL Spec. 694	5B3459					
300	Clamp, Deadend; for CC-358 Kearny Lay-Cit. or equal	5B3094					
Total Outside Plant			186,000	186,000	3625	3625	91
Total Entire Project			147,750	147,900	4568	4168	110

*Required in connection with spiral-four installation. The field wire shown in paragraph 204 to outlying offices is not included in this table, as it is assumed already in place.

206. PROBLEM 2 - FOUR CHANNEL RADIO RELAY CARRIER COMMUNICATION SYSTEM.

a. This problem illustrates the use of a radio link in setting up a communication system. Telephone and telegraph facilities are required between the two main Offices A and B and certain outlying points. From engineering considerations it has been determined that these will be provided as shown in paragraph 207. This figure shows a 4-channel system using spiral-four carrier telephone equipment, AN/TRC-3 radio terminal equipment and AN/TRC-4 radio relay equipment operating over a distance of approximately 100 miles between Office A and Office B. Radio terminals are located close to Offices A and B, and connected to the offices by Cable Assemblies CC-358. Radio relay sets are indicated at 3 points along the route between the radio terminal sets, that is at intervals of about 25 miles. (As discussed in TM 11-496 the distance over which AN/TRC-3 and 4 equipment will operate satisfactorily depends primarily upon the character of the terrain between the radio transmitters and receivers and the choice of antenna locations. A distance of 25 miles is used here merely as an example.) It is assumed that for one of the links (between 2 radio relay sets) the situation requires that amplifier equipment be used to increase the transmitted power. A voice-frequency carrier telegraph system is operated over one channel of the carrier telephone system with terminals at Offices A and B. At these offices certain of the telegraph channels are extended to outlying points over the simplex circuits of existing telephone facilities.

b. The circuits provided by the layout shown in paragraph 207 are as follows.

	Circuit No.	Terminal	Facilities Used
Telephone	1	A-B	Carrier Telephone Channel
	2	A-B	Carrier Telephone Channel
	3	A-B	Carrier Telephone Channel
Telegraph	1	A-B	Carrier Telegraph Channel
	2	A-C	A-B, Simplex on Existing Telephone Circuit B-C
	3	A-D	Carrier Telegraph Channel A-B, Simplex on Existing Telephone Circuit B-D
	4	B-E	Carrier Telegraph Channel B-A, Simplex on Existing Telephone Circuit A-E

c. The equipment required to obtain these facilities, with the exception of that required for the outside plant from Offices A and B to outlying offices, is itemized in paragraph 207. The equipment is listed for each office under the headings of Telephone Equipment and Telegraph Equipment and for each radio link terminal or repeater. Certain spare equipment as assumed for this particular layout is also listed. This is in addition to the spare equipment furnished as components of AN/TRC-3 and AN/TRC-4.

d. The radio equipment information is obtained from chapter 14. Data on the carrier telephone and telegraph equipments are obtained from chapters 9 and 10 respectively, which also give suggested spare equipment. In addition to the carrier equipment repeating coils for simplexing the existing telephone circuits are required (chapter 9). The spare power equipment is covered in chapter 12.

e. Paragraph 208 summarizes the equipment required for the entire project. This summary gives the stock numbers of the various items for ordering purposes, together with essential logistical information. The spare equipment listed is in addition to the spare equipment furnished as components of AN/TRC-3 and AN/TRC-4. The data required in preparing this table are obtained from chapters 6, 9, 10, 12 and 14.

207. DIAGRAM OF FOUR-CHANNEL RADIO RELAY CARRIER COMMUNICATION SYSTEM.

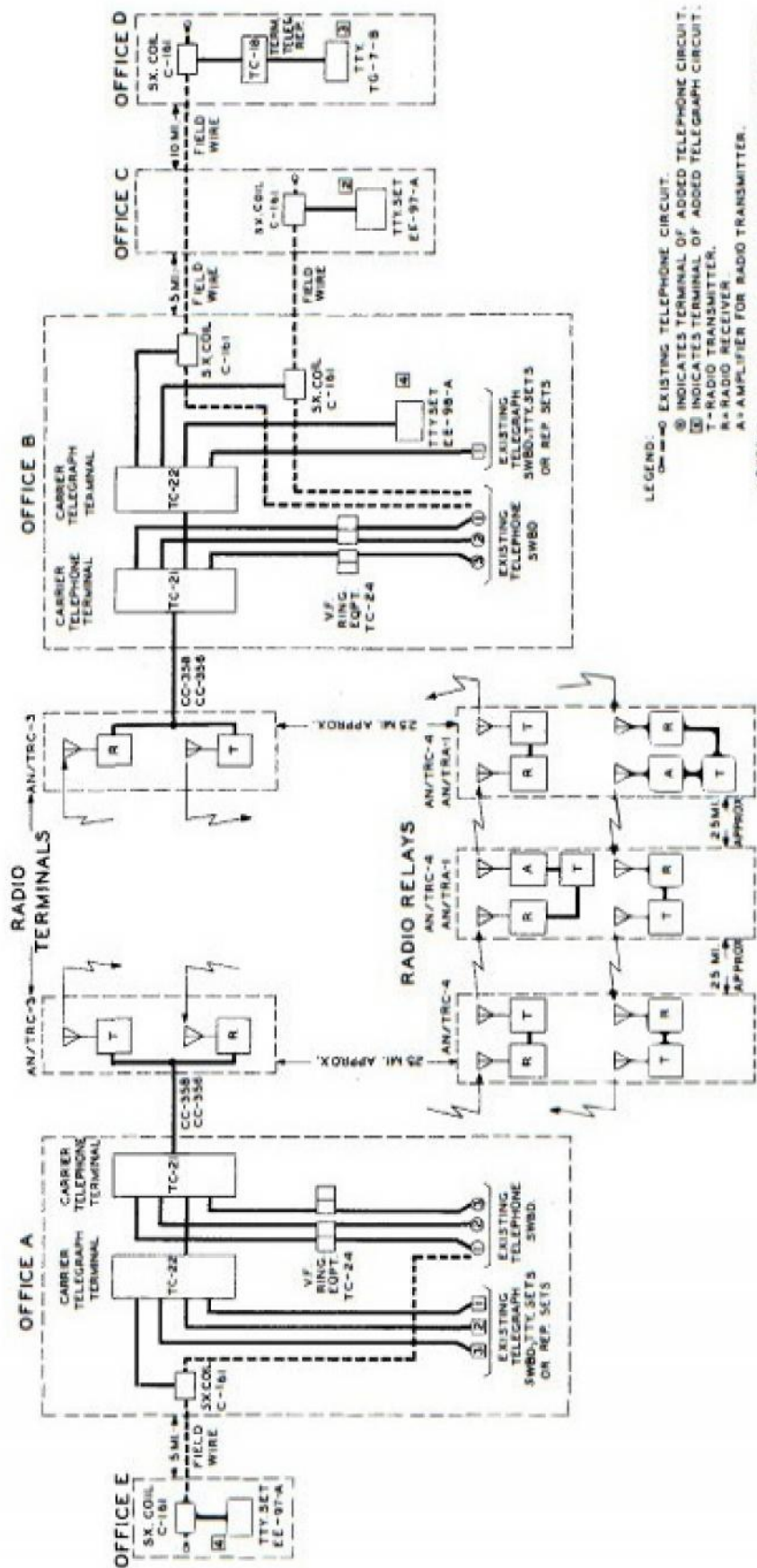

LEGEND:
 (---) EXISTING TELEPHONE CIRCUIT.
 (---) INDICATES TERMINAL OF ADDED TELEPHONE CIRCUIT.
 T-RADIO TRANSMITTER.
 R-RADIO RECEIVER.
 A-AMPLIFIER FOR RADIO TRANSMITTER.
 NOTES: 1. SPARE EQUIPMENT IS INCLUDED AS COMPONENTS OF AN/TRC-3 AND AN/TRC-4 AS NOTED IN PARAGRAPH 1408.

OFFICE E	OFFICE A	RADIO RELAY WITH AMPLIFIER	RADIO RELAY WITH AMPLIFIER	OFFICE B	OFFICE C	OFFICE D
TELEPHONE EQPT. C-181	TELEPHONE EQPT. 1, TC-21-(-) 2, TC-24-(-) 1, C-181	1, AN/TRC-4 ^a 1, AN/TRA-1 SPARE EQPT. 1, AN/TRA-1	1, AN/TRC-3 ^a 10, CC-358 2, CC-356 SPARE EQPT. 10, CC-358 1, CC-356	TELEPHONE EQPT. 1, TC-21-(-) 2, TC-24-(-) 2, C-181	TELEPHONE EQPT. 1, C-181	TELEPHONE EQPT. 1, C-181
TTY SET EE-97-A	TELEGRAPH EQPT. 1, TC-22-(-) 1, TS-2/TC	1, AN/TRC-4 ^a 1, AN/TRA-1 SPARE EQPT. 1, AN/TRA-1	1, AN/TRC-3 ^a 10, CC-358 2, CC-356 SPARE EQPT. 10, CC-358 1, CC-356	TELEGRAPH EQPT. 1, TC-22-(-) 1, EE-98-A 1, TS-2/TC	TTY SET EE-97-A	TELEGRAPH EQPT. 1, TC-18 1, TC-18 1, TC-18
	SPARE EQPT. 1, CF-2-A 1, CF-2-B 1, EE-10-A (PE-75-(-) 1, RA-83-(-)			SPARE EQPT. 1, EE-98-A 1, EE-98-A		

208. SUMMARY OF EQUIPMENT FOR FOUR-CHANNEL RADIO SYSTEM ILLUSTRATED IN PARAGRAPH 207.

Quantity	Description	Stock No.	Weight - lbs		Volume - Cu.ft.		Ship Tons
			Export	Net	Export	Net	
a. Telephone Equipment (See paragraph 910)							
2	Telephone Terminal Set TC-21-()	4B8360-21	2940	2380	124	80	3.0
4	Ringer Set TC-24-()	4F2124	1760	1080	56	40	1.6
6	Repeating Coil C-161	3C161	30	18	-	-	-
b. Telegraph Equipment (See paragraphs 1010, 1011 and 1318)							
2	Telegraph Terminal Set TC-22-()	4A2822B	3080	2260	170	90	4.4
1	Repeater Set TC-18	4A2118	195	150	7	4	0.2
2	Teletypewriter Set EE-97-A	4TEE97A	1400	910	76	34	2.0
1	Teletypewriter Set EE-98-A	4TEE98A	547	313	32	12	0.8
1	Teletypewriter TC-7-B	4TE.28A-1	400	225	27	9	0.7
2	Test Sets TS-2/TC	4TSD570G	320	140	24	5	0.6
c. Radio Equipment (See paragraph 1410)							
2	Radio Terminal Set AN/TRC-3	2S5002-3	6300	5120	264	176	6.6
3	Radio Relay Set AN/TRC-4	2S5002-4	13500	10500	561	366	14.
2	Amplifier Equipment AN/TRA-1	2S5006-1	1094	804	64	28	1.4
d. Cable (See paragraph 614)							
20	Cable Assembly CC-358 (On reel DR-15 1/4 mile per reel)	1B1458	3500	3500	96	96	2.4
4	Cable Assembly CC-356	1B1456	-	-	-	-	-
e. Spare Equipment^a (See chapters 6, 9, 10, 12 and 14)							
1	Telephone Terminal CF-1-A	4B8361	735	475	44	20	1.1
1	Ringing Equipment EE-101-A	4F2101	140	95	4	2	0.1
1	Telegraph Terminal CF-2-B	4A2892B	760	575	42	20	1.1
1	Teletypewriter Set EE-98-A	4TEE98A	547	313	32	12	0.8
2	Power Unit PE-75-()	3H457511	990	660	28	22	0.7
1	Rectifier Unit RA-83-()	3H4699-83	64	50	2	1	-
2	Amplifier Equipment AN/TRA-1	2S5006-1	1094	804	64	28	1.4
20	Cable Assembly CC-358 (On reel DR-15 1/4 mile per reel)	1B1458	3500	3500	96	96	2.4
2	Cable Assembly CC-356	1B1456	-	-	-	-	-
Total			42,896	33,872	1813	1141	45.3

^aRadio Terminal Set AN/TRC-3 and Radio Relay Set AN/TRC-4, listed under g. include spare equipment components.

209. PROBLEM 3 - TACTICAL OPEN WIRE
CARRIER TELEPHONE AND TELEGRAPH
SYSTEM

a. This problem involves carrier telephone and telegraph systems operated on open wire using CF-1-A terminals with CF-4-() converters and CF-5-() repeaters. It has been assumed that engineering considerations require construction of a 150 mile, 080 copper steel (40%) line with 8-pin crossarms, class 9 round poles and 200-foot pole spacing. Two pairs of wire are to be strung initially, in this particular case. The line is to be built between Office A and Office C and will be equipped with carrier and d-c telegraph equipment as shown in the figure of paragraph 210. The figure shows carrier terminals on pair one at Office A and Office C with a carrier repeater at Office B which is 90 miles from Office A. Pair two is equipped with two carrier systems, one with terminals at Office A and Office B and the other with terminals at Office B and Office C. Each pair is composed for

DC telegraph. One composite circuit of each pair is used for d-c signaling in connection with supervision of the carrier telephone systems. The other composite circuit on each pair provides teletypewriter circuits between Office A and Office B and between Office B and Office C, respectively. Teletypewriters are connected directly to the repeaters at the ends of these circuits.

b. The equipment required for each office, including suggested spare equipment, is also indicated in paragraph 210. In addition, wire, poles, crossarms, hardware, etc., as outlined in chapter 6 will be needed for the open wire line. The telephone equipment required is selected from chapter 9, the telegraph equipment from chapter 10 and the spare power equipment from chapter 12.

c. Paragraph 211 gives a summary of the equipment required for the entire project and includes stock numbers and logistical data. The information for this table is drawn from appropriate tabular data in the above chapters.

211. SUMMARY OF EQUIPMENT FOR OPEN WIRE CARRIER TELEPHONE AND TELEGRAPH SYSTEM ILLUSTRATED IN PARAGRAPH 210.

Quantity	Description	Stock No.	Weight - lbs		Volume - Cu.Ft.		Ship Tons
			Export	Net	Export	Net	
a. Line Transmission Equipment							
(1) Telephone Equipment (See paragraph 910)							
6	Telephone Terminal Set TC-21-()	4B8360-21()	8820	7140	372	240	9.3
6	Converter Set TC-33-()		4980	3420	264	132	6.6
1	Repeater Set TC-37-()	4B3237	1180	860	53	34	1.3
12	Ringer Set TC-24-()	4F2124	5280	4080	168	121	4.3
(2) Telegraph Equipment (See paragraph 1010, 1011 and 1318)							
3	Telegraph Terminal Set TC-22-()	4A2822B	3080	2260	170	90	4.4
8	Repeater Set TC-18	4A2118	1560	1168	52	27	1.6
8	Teletypewriter TU-7-B	4T2.28A-1	3200	1800	216	70	5.6
3	Test Set TS-2/TU	4T2D57G	480	210	36	8	0.9
3	Test Set I-193-A	3F4193A	285	195	14	6	0.5
(3) Spare Equipment (See chapters 9, 10 and 12)							
3	Telephone Terminal CF-1-A	4B8361	2205	1425	131	61	3.3
3	Converter CF-4-()	4B4484	1590	840	103	35	2.7
1	Repeater CF-3-()	4B3205	690	380	40	18	1.0
3	Ringling Equipment EE-101-()	4F2101	420	285	11	6	0.3
1	Telegraph Terminal CF-2-B	4A2892B	760	575	42	20	1.0
3	Repeater Set TC-18	4A2118	585	438	20	10	0.6
3	Teletypewriter TU-7-B	4T2.28A-1	1200	675	81	26	2.1
6	Power Unit PE-75-()	3H4575()	2670	1980 (No Case)	96	65 (No Case)	2.4
2	Power Unit PE-214-()	3H4600-214	160	174	7	8	0.2
3	Rectifier RA-83-()	3H4699-83	192	150	5	3	0.1
Total - Equipment			39,337	28,055	1,883	980	48.1

Quantity	Description	Stock No.	Weight - lbs		Volume - Cu.Ft.		Ship Tons
			Export	Net	Export	Net	
b. Outside Plant (See paragraph 603)							
3000	Pole, treated, Class 9,20'	5A3220-4					
1200	Pole, treated, Class 9,22'	5A3222-1					
300	Pole, treated, Class 9,25'	5A3225-5					
150	Pole, treated, Class 9,30'	5A3234	1,096,650	1,096,650	28,605	28,605	715
36	Pole, treated, Class 7,35'	5A3235-1					
36	Pole, treated, Class 6,40'	5A3240-1					
4650	Crossarm, PF-92-A, 8-pin 7'4"	5A1592					
18,000	Pin, PF-59, Locust 8"	5A3069					
18,000	Insulator IN-15, Toll, Glass, 8GSP	3G615	29,400	29,400	825	825	21
1200	Insulator IN-126, Trans- position, Glass	3G1815-53					
60,000 lbs	Wire W-153,080, c-s, 40%	1A153	60,000	60,000	960	960	24
1980	Anchor Rod AH-4 5/8"x6" GI	5B9704					
4800	Bolt, carriage 3/8"x4" GI	5B1106-4					
4800	Bolt, machine 3/8"-8" GI	5B1510-8					
1650	Bolt, machine 3/8"x10" GI	5B1510-10					
900	Bolt, machine 5/8"x12" GI	5B1510-12					
4800	Brace PF-4, Crossarm	5B2104					
1260	Clamp, PF-61 or Hubbard No. 7402, guy, 2-bolt	5B3061					
2520	Clamp, FT-56, guy, 3-bolt	5B3450					
240	Connector, bridging No. 3A	3Z1403					
120 lbs	Nail, common wire 6-d	6L1406					
1980	Nut, angle bolt, thimbleye for 5/8" bolt	5C1635-1	61,950	61,950	1,050	1,050	26
270	Ring PF-74, bridle, C-type 1-1/4" eye, GS	5B9320					
4800	Screw, lag, 3/8"x3-1/2" GI	5B10006-3.5					
3750	Sleeve, CU for 080 c-s (C-080-C)	6N5614.1					
14250	Washer, square, GI, 2-1/4" with 11/16" hole	5B20209-11					
15,000 ft	Wire W-110B	1B110Bx					
48,000 ft	Wire W-115B, Messenger 6M, 5/16"	1A115					
25,200 ft	Wire Messenger, 2.2M Utilities grade 3/16"	1A503					
600 lbs	Wire W-154, tie 080 CU, annealed, 19"	1A154					
	Total Outside Plant		1,248,000	1,248,000	31,440	31,440	706
	Total Entire Project		1,287,421	1,276,055	33,329	32,420	834

212. PROBLEM 4 - FIXED PLANT OPEN WIRE COMMUNICATION SYSTEMS

a. Fixed plant equipment will be used under a wide variety of conditions and no particular layout or association of equipment may be considered as typical. The following problem has been chosen to bring out the application of as many different types of packaged equipment as possible.

b. It is assumed that the route involves three offices, A, B, and C, and that the circuits required are five telephone and 14 telegraph between A and C, two telegraph between A and B, and one telegraph between B and C. Two pairs on an existing open wire line are assumed to be available for use. The circuit requirements can be met by providing the following facilities.

<u>Facility</u>	<u>Circuits Provided</u>
1 - Type C Carrier and 1 - 12-channel VF Telegraph System	2 telephone and 12 telegraph, A to C
1 - Type H Carrier System	1 telephone, A to C
2 - Repeatered Voice Frequency Circuits	2 telephone, A to C
5 - D-c Telegraph Cir- cuits	2 telegraph A to B, 1 telegraph B to C, and 2 telegraph A to C with one circuit ex- tended beyond C.

The layout of these facilities is shown in schematic form in paragraph 213a.

c. Paragraph 213b shows the items of packaged equipment required to provide the desired layout. The items of telephone equipment are determined from chapter 9. The telegraph equipment is determined from chapter 10. Test and tool equipment is determined from chapter 13. Offices A and C are treated in different manners for the same equipment requirements. This is to illustrate the various possible solutions of a given problem. It will be noted that the equipment ordered will provide some spares which could be used later for other circuits. Also, if the installation happened to be in an existing office which already had packaged equipment, certain of the testing equipment would be available and might not need to be ordered.

d. A summary of the equipment by stock numbers and type, and estimates of the shipping requirements as determined from chapters 9, 10, 12 and 13 are given in paragraph 214.

213. DIAGRAM OF FIXED PLANT OPEN WIRE COMMUNICATION SYSTEM.
 a. Circuit Arrangement

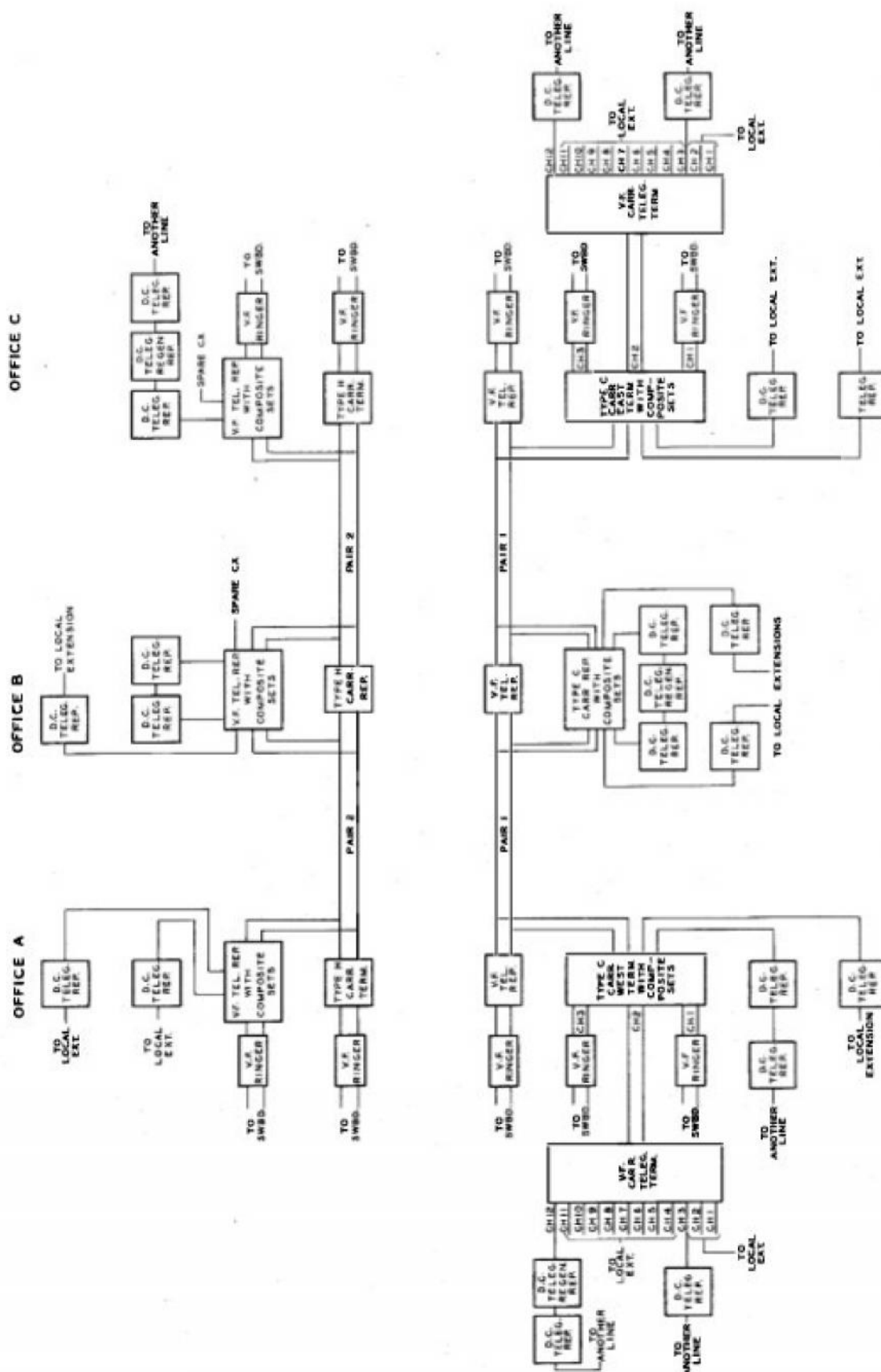

b. Packaged Equipment

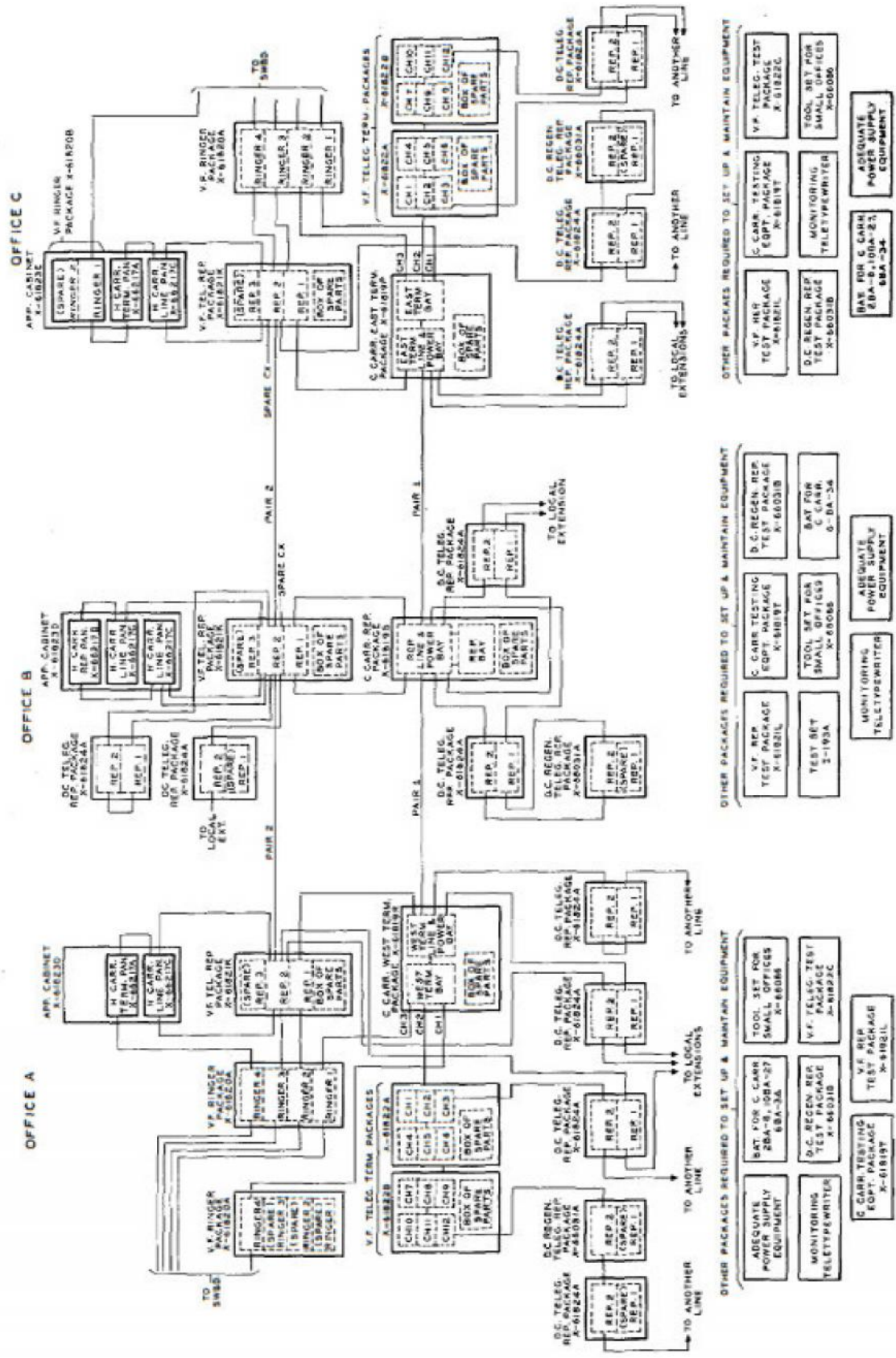

214. SUMMARY OF PACKAGED EQUIPMENT FOR FIXED PLANT OPEN WIRE COMMUNICATION SYSTEM ILLUSTRATED IN PARAGRAPH 213

a. Equipment Requirements d

Nomenclature	Office A				Office B				Office C				
	Signal Corps Stock Number ^a	Quantity	Total		Quantity	Total		Quantity	Total		Quantity	Total	
			Weight Pounds	Cu.Ft. Export		Weight Pounds	Cu.Ft. Export		Weight Pounds	Cu.Ft. Export		Weight Pounds	Cu.Ft. Export
C Carrier East Terminal Package X-61818F	488363C-1.1	1	1,680	75.0	1.9	1	1,570	75.0	1.9	1	1,680	75.0	1.9
C Carrier West Terminal Package X-61818R	488363C-2.1	1	1,680	75.0	1.9	1	1,570	75.0	1.9	1	1,680	75.0	1.9
C Carrier Repeater Package X-61819S	483302C-1	1	940	35.5	0.9	1	940	35.5	0.9	1	940	35.5	0.9
Voice Frequency Telephone Repeater Package (Triple) X-61821K	483199.1	2	652	22.0	0.6	1	265	9.2	0.4	1	480	30.0	0.8
Voice Frequency Ringer Package X-61820A	473050	1	175	11.0	0.3	1	175	11.0	0.3	1	175	11.0	0.3
Voice Frequency Ringer Package X-61820B	473050B	1	125	6.0	0.2	1	70	4.5	0.1	1	125	6.0	0.2
Apparatus Cabinet 7'0" High	4C1806-6	1	40	2.9	0.1	2	80	5.8	0.2	1	40	2.9	0.1
" " 3'6" High	4C1806-5	1	1,500	75.0	1.9	1	1,500	75.0	1.9	1	1,500	75.0	1.9
" " 2'4" High	4C1806-7	1	1,500	75.0	1.9	1	1,500	75.0	1.9	1	1,500	75.0	1.9
Type H Carrier Terminal Panel X-66217A	483302A	1	40	2.9	0.1	2	80	5.8	0.2	1	40	2.9	0.1
Type H Carrier Repeater Panel X-66217B	483302H	1	1,500	75.0	1.9	1	1,500	75.0	1.9	1	1,500	75.0	1.9
Type H Carrier Line Panel X-66217C	483302HB	1	1,500	75.0	1.9	1	1,500	75.0	1.9	1	1,500	75.0	1.9
Voice Frequency Carrier Telegraph Terminal X-61822A	4A2794	1	990	46.0	1.2	3	1,485	69.0	1.8	3	1,485	69.0	1.8
" " X-61822B	4A2794.1	2	450	23.0	0.6	1	450	23.0	0.6	1	450	23.0	0.6
DC Telegraph Repeater Package X-61824A	4A2798	1	192	15.0	0.4	1	192	15.0	0.4	1	192	15.0	0.4
DC Regenerative Telegraph Repeater Package X-66031A	473964.1	1	142	7.5	0.2	1	142	7.5	0.2	1	142	7.5	0.2
Voice Frequency Telephone Repeater Testing Package X-61821L	4F3963.1	1	188	7.2	0.2	1	188	7.2	0.2	1	188	7.2	0.2
C Carrier Testing Equipment Package X-61819T	6R36190	1	107	6.0	0.2	1	95	4.5	0.1	1	107	6.0	0.2
Tool Set for Small Offices X-66086	4A2796	1	100	5.0	0.1	1	100	5.0	0.1	1	100	5.0	0.1
Voice Frequency Telegraph Test Package X-61822C	3P4193	1	450	35.0	0.9	1	450	35.0	0.9	1	450	35.0	0.9
Test Set I-193	3A8	2	9	0.1	-	2	9	0.1	-	2	9	0.1	-
DC Regenerative Telegraph Repeater Test Package X-66031B	3A27	10	10	0.1	-	10	10	0.1	-	10	10	0.1	-
Model 15 Teletypewriter Set ^b	3A54	6	6	447.3	11.6	6	6	447.3	11.6	6	6	447.3	11.6
Battery BA-8	472.16A-1	1	450	35.0	0.9	1	450	35.0	0.9	1	450	35.0	0.9
Battery BA-27	3A8	2	9	0.1	-	2	9	0.1	-	2	9	0.1	-
Battery BA-34	3A27	10	10	0.1	-	10	10	0.1	-	10	10	0.1	-
	3A54	6	6	447.3	11.6	6	6	447.3	11.6	6	6	447.3	11.6
Total			9,254	447.3	11.6		6,031	296.2	7.8		9,813	483.6	12.5

b. Summary of Total Weight and Space Required

Office	Total Weight		Total Space	
	Export Pounds	Ship Tons	Cu.Ft. Export	Ship Tons
A	9,250	447	11.6	31.9
B	6,030	296	7.8	12.5
C	9,810	484	12.5	31.9
Total	25,090	1,227	31.9	76.3

- a Stock numbers and logistical data from paragraphs 921, 1028, 1235, 1315 and 1316.
- b Monitoring teletypewriter. Other types can be used if desired.
- c No Signal Corps stock number assigned.
- d This table does not include power generating equipment and power wiring.

215. PROBLEM 5. INTERCONNECTION OF
D-C TELEGRAPH CIRCUITS AT JUNCTION
OF FIXED PLANT AND TACTICAL CAR-
RIER SYSTEMS

a. This problem illustrates the interconnection of the d-c local extension circuits of fixed plant and tactical wire telegraph equipment. The fixed plant equipment is assumed to be operating on an open wire line and the tactical equipment on spiral-four cable as indicated in the diagram in paragraph 216. The telephone equipment and outside plant is indicated by dotted lines, for information only, and hence are not included in the equipment summary given in paragraph 217.

b. The fixed plant telegraph equipment is the packaged carrier telegraph

terminal equipment, packaged d-c telegraph and d-c regenerative telegraph repeater equipment and Model 15 teletypewriter sets. The tactical equipment is spiral-four carrier telegraph terminal equipment. The composite sets and simplex sets are located in the telephone terminal equipment. The teletypewriters are assumed to be within the office or on the same premises. Power supply equipment is not included in this problem. It is assumed that monitoring teletypewriters are available for office use and for supervising service. Monitoring teletypewriters may be commercial equipment, Model 15 Teletypewriters or Teletypewriter

TG-7-().
c. The data given in paragraph 217 were obtained from chapters 10 and 13.

216. DIAGRAM OF INTERCONNECTION OF D-C TELEGRAPH CIRCUITS AT JUNCTION OF FIXED PLANT AND TACTICAL CARRIER SYSTEMS.

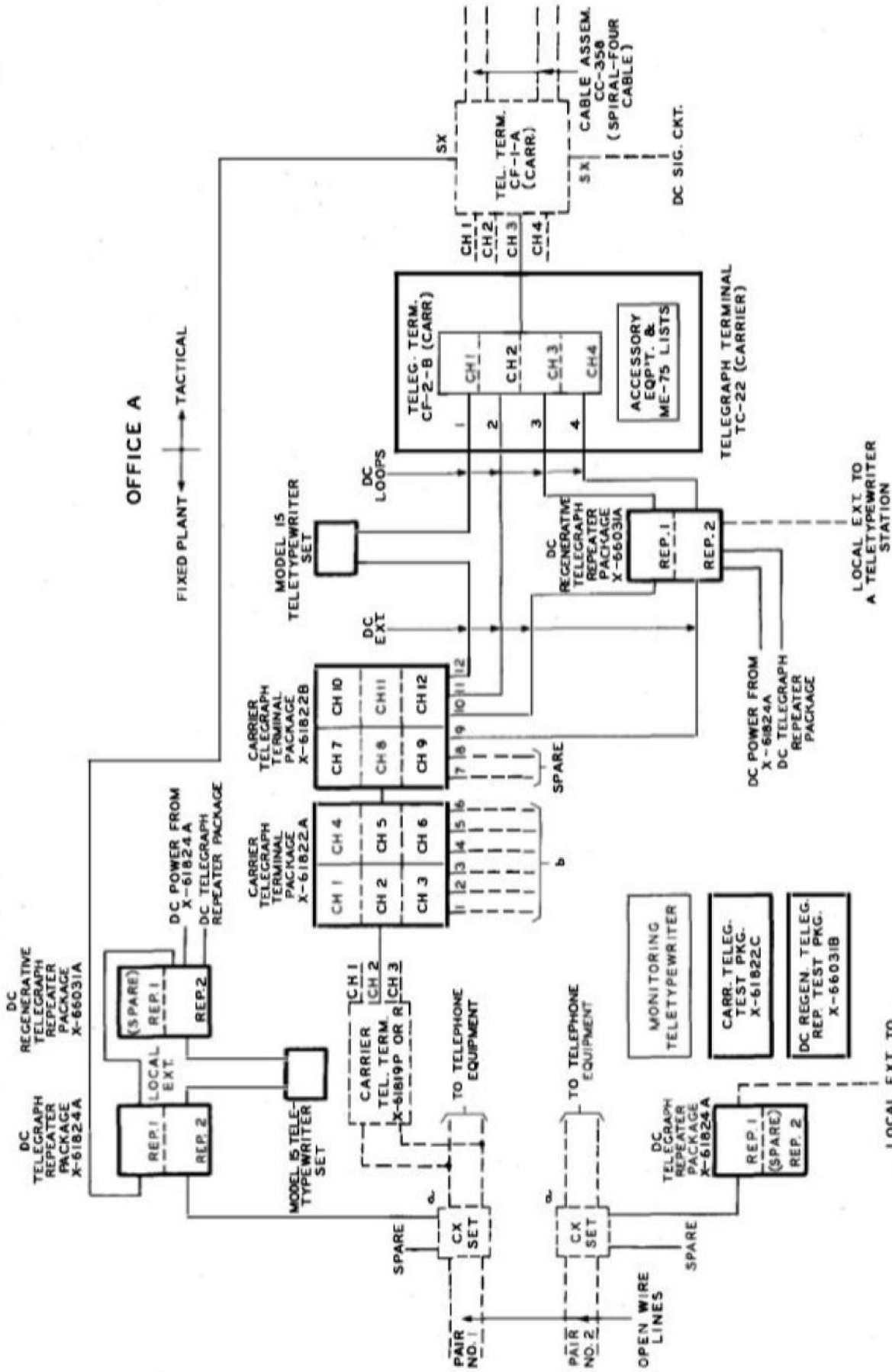

a. COMPOSITE SETS ARE FURNISHED AS PART OF THE TELEPHONE EQUIPMENT.

b. DC EXTENSIONS OUTSIDE THE OFFICE TO TELETYPEWRITER STATIONS USING A TELETYPEWRITER (LINE RELAY) OR X-61824A DC TELEGRAPH REPEATER OR REPEATER TG-30 OR LINE UNIT BE-77, BE-77-A OR BE-77-B.

217. SUMMARY OF TELEGRAPH EQUIPMENT FOR PROBLEM ILLUSTRATED IN PARAGRAPH 216.
(SEE PARAGRAPHS 1011, 1028 AND 1315)

Quantity	Nomenclature	Stock No.	Weight (pounds)		Volume (Cu. Ft.)		Ship Tons
			Export	Net	Export	Net	
1	Telegraph Carrier Package: Voice Frequency; 6 Channel. X-61822A	4A2794	1520	1175	66	36	1.7
1	Telegraph Carrier Package: Voice Frequency; 6 Channel. X-61822B	4A2794.1	1520	1175	66	36	1.7
2	Repeater Package: Telegraph; D-C X-61824A	4A2798	500	365	23	9	0.6
2	Repeater Package: Telegraph; Regenerative. X-66031A	None assigned	450	315	23	9	0.6
1	Telegraph Terminal Set TC-22-() (Carrier)	4A2822B	840	640	43	25	1.1
2	Teletypewriter Set Model 15 ^a	4T2.18A-1	450	215	35		0.9
1	Testing Package: Telegraph; V.F. Carrier. X-61822C	4A2796	114		5		0.1
1	Test Package: Telegraph; Regenerative Repeater X-66031B	None	180		14		0.4
TOTAL			5574		275		7.1

^aTeletypewriter Sets other than Model 15 might be used.

218. PROBLEM 6 - FIXED PLANT MULTIPLE SWITCHBOARD

a. The policy of supplying communications to the larger headquarters by use of commercial switchboards rather than Army portable type switchboards has proved its value. These headquarters usually have remained at one location for a sufficient length of time to justify the commercial installations. The commercial switchboards can be of greater capacity than the specialized tactical types, permitting all military requirements in a large area to be served from one switchboard. Trunk and long distance circuits are more economical and efficient when working between a few large units and with the civil system than when many small switchboards are used with a complicated network of trunks direct from each switchboard to every other one. Small satellite commercial PBX type switchboards can be used at outlying headquarters. They are specifically designed to work with a large central switchboard. The operating advantages of this system lead to better and faster service, less over-all maintenance, and less maintenance and

operating personnel. An important factor is the freeing of tactical switchboards, such as switchboard TC-1, to serve Air Force and Army headquarters where speed of installation and mobility are primary requirements.

b. A problem illustrating the use of the material given in this manual in selecting a fixed plant, multiple switchboards is worked out in paragraphs 219, 220 and 221. It is assumed in this problem that the traffic requirements have been determined and that the problem is to order the proper equipment and estimate the shipping space. Sufficient information should be supplied with the request so that a complete detail switchboard engineering job can be done without the need of further correspondence. The problem here will demonstrate the type of information necessary to accomplish this result as well as to determine shipping space requirements.

c. A typical plan for a fixed plant, common battery, multiple switchboard, serving as a telephone switching center, is used as the basis for this problem and is illustrated in paragraph 219.

219. PLAN FOR FIXED PLANT, COMMON BATTERY, MULTIPLE SWITCHBOARD.

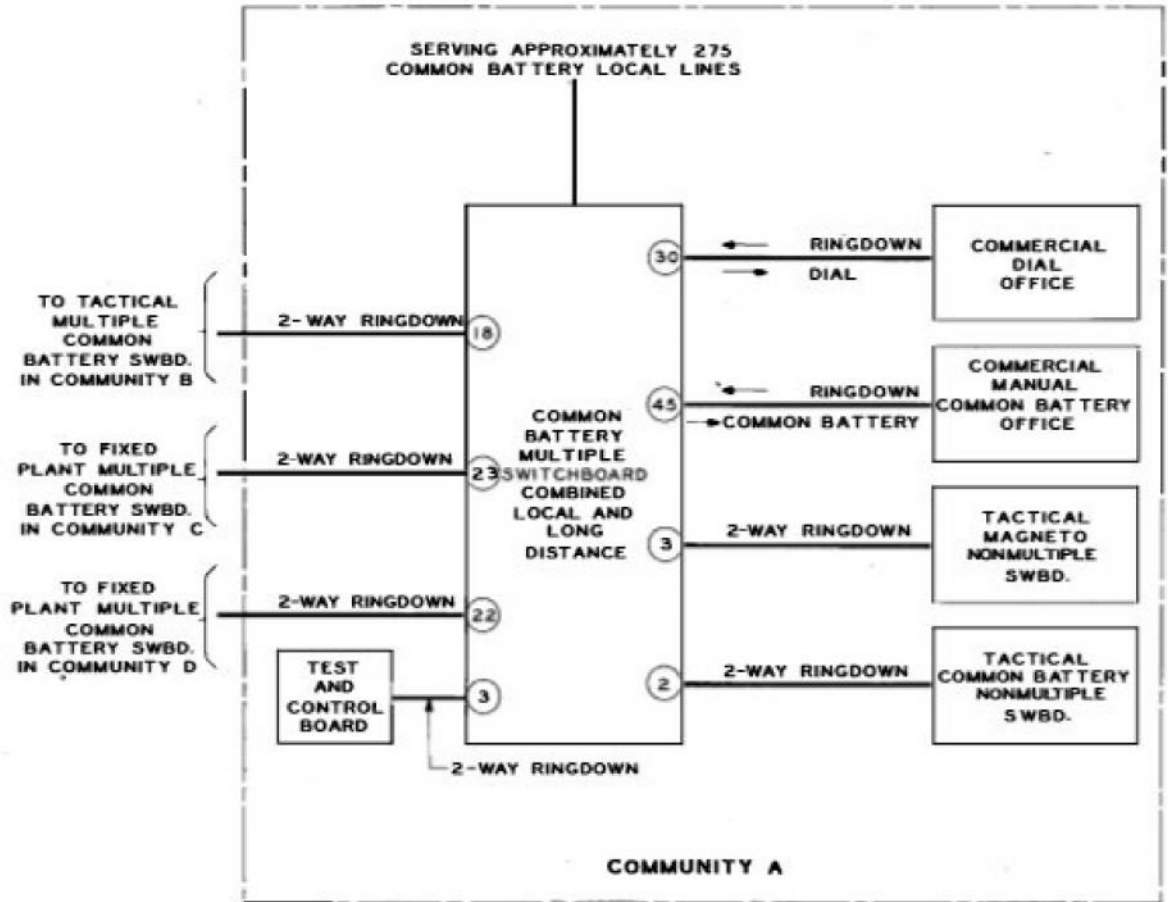

220. SAMPLE SWITCHBOARD ORDER.

a. General. A complete common battery, manually operated, multiple switchboard and all associated equipment should be furnished. This should be a 10 position combined local and long distance switchboard having 280 subscriber common battery lines, 75 magneto lines and 75 two-way trunks.

b. Engineering Data. Any one of the following commercial types of multiple switchboards, made up of single position sections, will meet these requirements:

Kellogg Switchboard and Supply Co.	No. 1600 Switchboard
------------------------------------	----------------------

Stromberg-Carlson Co.	No. 18 Switchboard
Western Electric Co.	No. 11 Switchboard

(This is determined by referring to the information contained in paragraphs 423 and 424.)

The switchboard should be in one line. The direction of growth should be left to right.

The terminal and operating room should be on one floor and the area available is 26' by 29'. The ceiling height should be 9' or more. (This information should be provided when available).

c. Summary of Equipment Required.

Combined local and long distance positions ^a	10
Common battery subscribers line equipments	280
Common battery subscribers line multiple	280
Magneto line equipments for long distance lines to operate line and busy lamps	75
Magneto line multiple for long distance lines	80
Two-way trunk equipments, local ^b	75
Two-way trunk multiple, local	80
Interposition trunk equipments	10
Interposition trunk, answering jacks	10
Office and miscellaneous trunk multiple	20
Ticket boxes	5
Vacant line signal plug	500
Lamp caps for No. 1600 board	2310
Lamp caps for No. 18 board	2570
Lamp caps for No. 11 board	2535
Emergency talking battery and cord	1
Full universal cord circuits, with locked-in rering supervision and ringing on calling cord, per position ^c	17
Supervisors' circuits	2
Switchboard test circuit	1
Stile strip number plates with hundreds designation	
Night alarm circuit	1
Wire chief's test cabinet	1
"A" type of MDF, where outside lines terminate on terminal strips, with capacity for 1010 outside pairs ^d	1
Relay racks	as required
Power plant	as required
Cable rack	as required
Operators' telephone sets	25
Operators' chairs	12
A complete set of spare parts for estimated one year's operation	
A complete set of installing tools and miscellaneous equipment	
A complete set of maintenance tools	
6 complete sets of installing and maintenance instructions	

^aThe positions should be arranged for dialing.

^bThirty of the two-way trunks should be arranged to terminate on subscribers' line circuits in the commercial dial office; these trunks should take into account the type of cord circuits provided. The remaining 45 two-way trunks should be arranged to terminate on subscribers' line circuits in the commercial manual common battery office; these trunks should take into account the type of cord circuits provided.

^cRinging on both cords is desirable, if available.

^dIf "A" type MDF's are not available, "B" type should be provided.

221. ESTIMATE OF WEIGHTS AND VOLUMES OF CENTRAL OFFICE EQUIPMENT

	Weight - lbs. Packed for Export ^a	Volume Export Cu.Ft.	Ship Tons
Switchboard			
Kellogg Switchboard and Supply Co. No. 1600 Switchboard and associated equipment	15,900	970	24.3
Stromberg-Carlson Telephone and Manufacturing Co. No. 18 Switchboard and associated equipment	15,900	970	24.3
Western Electric Co. No. 11 Switchboard and associated equipment	11,800	650	16.3

^aWeights and volumes from paragraph 427.

Section III
Telephone System Comparisons

222. GENERAL. This section gives certain general logistic comparisons between a radio relay system and various types of wire plant. It also gives comparative data on various types of wire telephone systems.

223. COMPARISON OF MEANS OF OBTAINING FOUR, OR SIXTEEN, TELEPHONE CIRCUITS.

a. Paragraphs 224 and 225 show comparisons of installation times, volumes and weights of material, and other factors for the radio system employing Radio Terminal Sets AN/TRC-3, Radio Relay Sets AN/TRC-4 and Telephone Terminal Sets TC-21-(), and for various wire line systems. They apply to 100-mile circuit lengths; paragraph 224 covering the case of four telephone channels, and paragraph 225, sixteen telephone channels. In paragraph 224 the lightest available types of wire construction are assumed. Some figures are given also for wire-system equipment alone, to apply to the case where the outside plant is assumed to be already available. Voice frequency telegraph may be used with any of the above systems, but is not included in the figures. The equipment assumed in the radio system is given in paragraph 226, and additional information on the wire systems is given in paragraphs 227, 228 and 229.

b. It will be seen that the outside plant forms the bulk of the required weight, volume and construction time for wire plant, so that for other circuit lengths than 100 miles (within the transmission capabilities of the

respective systems) the figures for the wire systems including outside plant can be approximately estimated by scaling the figures up or down from the 100-mile values. Interpolation can also be used in some cases to obtain approximate estimates for other numbers of telephone channels obtained in stated ways; care is needed here, however, since for example it takes essentially as much plant to obtain two telephone channels from a four-channel radio or wire system as it does to obtain four channels.

c. The data on weight and shipping space are based on what appear to be reasonable assumptions as to repeater spacings, working spares, etc. However, it should be noted that the systems differ in their features and capabilities, so that the assumptions used in the comparison may not hold in many cases. For example, the equipment for the radio systems is based on repeater spacings of 25 miles, which is estimated

to be what would be needed to take care of moderately unfavorable situations. However, where sites with suitable elevations can be obtained for the radio sets so that paths which are substantially line-of-sight can be obtained for longer distances, repeater spacings up to 50 miles or even more in some cases could be used. This would reduce the amount of equipment required by a considerable percentage. Similarly, wire systems may encounter terrain necessitating the use of routes much longer than the air line distance, in which case the equipment needed between two given points will be increased.

d. In an over-all comparison, the transmission aspects and terrain requirements of the particular systems, and the general features of radio vs. wire circuits, as discussed in TM 11-486, should also be considered, as well as the relative dependability of the various types of plant.

224. COMPARISON OF MEANS OF OBTAINING FOUR TELEPHONE CIRCUITS - 100 MILES

System	Radio Relay		Carrier on Spiral-four		New Light Open-Wire ^c		Existing Open-Wire Suited for 30-KC Carrier Operation ^d	
	AN/TRC-3, AN/TRC-4, TC-21-()	TC-21-()	Buried ^a	Suspended ^b	1 Pair with Carrier TC-23-()	4 pairs with packaged voice terminal repeaters	TC-33-()	TC-21-() and Voice
Estimated man-days for installation ^{e,h}	6 ^o	285 ^f	440 ^f	1130 ^f	1490 ^f	2 ^o	5 ^o	
Ship tons ^j for plant including working spares ^k	26	75	75	320	400	9	11	
Carrying weight tons ^{h,k}	10	50	50	220	290	3	5	
Carrying weight of largest package, pounds	475	475	475	475	835	475	810	
Repeater spacing, miles	25	25	25	-	-	-	-	
Power consumption, watts: per terminal	500	130	130	160	320	160	525	
per intermediate repeater	700	30	30	-	-	-	-	

^a Does not include aerial road crossings; see Paragraph 228, note b.
^b Suspended on existing pole line, without messenger wire or lance poles. With messenger wire, figures would be approximately as follows: 700 estimated man-days for installation; 95 ship tons; 60 tons carrying weight. With lance-poles half-way between successive regular poles, figures would be approximately as follows: 550 estimated man-days for installation; 135 ship tons; 85 tons carrying weight.
^c Using 4 x 4 timber supports.
^d Open-wire not included in the figures.
^e Includes set-up time only, with men and material at sites.
^f Includes surveying and staking the route, delivering material from dumps along the route, placing cable and burying connectors or erecting open wire line, d.c. testing and cleaning up. The figure for merely placing buried cable would be 60 man-days.
^g Based on commercial crews and conditions or on Signal Corps estimates from field trials in the U.S. Jungle or other difficult terrain not covered.
^h For wire circuits, man days, ship tons and carrying weight for inside plant are negligible compared to those for outside plant, and total carrying weight is practically as large as shipping weight. Carrying weight is less export packing except in case of packaged equipment, for which no other packing is provided.
ⁱ One ship ton is figured at 40 cubic feet. Export packing included.
^k Does not include all the material for "complete 100-mile systems", which include depot spares, etc.

225. COMPARISON OF MEANS OF OBTAINING 16 TELEPHONE CIRCUITS - 100 MILES

System	Radio Relay AN/TRC-3, AN/TRC-4 TC-21-()	Carrier on Spiral 4 TC-21-() on four buried spiral-4 cables ^a	Carrier on Tactical Open Wire		Carrier on Fixed Plant Open Wire
			Carrier (TC-21 & TC-33) on 4 pair 080 C-S wire Class 9 4" x 4" Timbers	Carrier Class 7 20' Poles, Spaced 200'	Package Type C Carrier and Voice on 4 pair 104 C-S wire Class 7, 30' Poles Spaced 150'
Estimated man-days for installation ^d	24 ^b	840 ^c	1470 ^c	1460 ^c	2150 ^c
Ship tons for plant including working spares ^e	104	300	425	590	1280
Carrying weight, tons ^e	40	200	300	460	1020

^aDoes not include aerial road crossings; see paragraph 228, note b.

^bIncludes set-up time only, with men and material at sites.

^cIncludes surveying and staking the route, delivering material from dumps along the route, placing cable and burying connectors or erecting open wire line, d.c. testing and cleaning up.

^dBased on commercial crews and conditions or on Signal Corps estimates.

^eShip tons and carrying weight for wire circuits are controlled primarily by outside plant. Does not include all the material for "complete 100-mile systems", which include depot spares, etc. One ship ton is figured at 40 cu. ft.

226. EQUIPMENT FOR 100-MILE FOUR-CHANNEL RADIO SYSTEM ASSUMED IN PARAGRAPH 224.

	Weight-lbs.		Volume-cu.ft.	
	Shipping	Carrying	Shipping	Net
<u>Radio Equipment (includes spares)^a</u>				
2 Radio Terminal Set AN/TRC-3	6300	5120	264	176
3 Radio Relay Set AN/TRC-4	13500	10500	561	366
<u>Telephone Terminal Equipment^a</u>				
2 Telephone Terminal Set TC-21-()	2940	2380	124	80
4 Ringer Set TC-24-()	1760	1080	56	40
1 Telephone Terminal CF-1-A (Spare)	735	475	44	20
1 Ringing Equipment KE-101-A (Spare)	140	95	4	2
Totals	25375	19650	1053	684

^aIt is assumed that no Amplifier AN/TRA-1 or associated equipment is used, and that each telephone terminal is at the same location as its associated radio terminal.

227. WIRE SYSTEMS.

a. General figures on shipping requirements for several types of wire telephone systems are given in paragraphs 228 and 229. These data may be used where it is necessary to make rough estimates without considering details of specific layouts.

b. Paragraph 228 applies to 100-mile carrier systems set up by means of tactical equipment on spiral-four cable or open-wire. Paragraph 229 covers Type C carrier and repeatered voice-frequency systems set up by packaged equipment on open wire. The summary figures do not include telegraph equipment.

c. The shipping requirements and construction times are for average conditions as defined by notes associated with the tables. If it is known that the conditions will be different from those assumed, the data will not apply without correction. Such other conditions might be jungle construction, difficult terrain, heavy storm loading areas, availability of different sizes of wire or poles, etc. An over-all comparison of the various systems should include, in addition to the information given here, the relative merits of each system from a transmission standpoint (as discussed in TM 11-486), the military conditions and other circumstances affecting specific situations.

d. A comparison of the Type C carrier and repeatered voice-frequency figures in paragraph 229 will show that there is a very large saving in material and construction effort per circuit when carrier is used. While the figures are

given for 300-mile systems, the comparison remains favorable to the use of carrier for extremely short circuits also. In general Type H carrier will be used on offshoot routes to provide an extra circuit or two; it is not covered in the table because the development of a route will seldom be based on Type H alone. However, anticipation of the requirements for Type H systems is desirable in planning.

e. Voice-frequency carrier telegraph circuits may be operated over any of the wire or radio telephone circuits. However, only the carrier telegraph systems which use different frequencies for opposite directional transmission, such as those employing Carrier Telegraph Terminals CF-2-(), should be applied to repeatered voice circuits, or carrier systems operated on a balanced two-wire basis. Carrier telegraph systems which use the same telegraph frequencies for each direction of transmission can be applied to circuits operated on a four-wire or an equivalent four-wire basis. Additional d-c channels can be obtained over the wire system as follows: two simplex circuits (one of them being restricted in length if used for telegraph) per spiral-four cable, two simplex circuits per two pairs of open wire used for four-wire carrier and two composited telegraph circuits per pair of open wire used for the balanced two-wire and equivalent four-wire systems. These d-c channels may be used for d-c telegraph and signaling circuits.

226. SUMMARY OF MATERIAL REQUIREMENTS FOR 100 MILE TACTICAL CARRIER SYSTEMS USING TELEPHONE TERMINAL SETS TC-21-().

	Spiral-Four Cable with Rep. Sets TC-53				Open wire ^a					
	Aerial on New Poles ^a		Buried ^b		4-Wire With Rep. Sets TC-23		2-Wire With Carrier Hybrids CF-7 and Rep. Sets TC-53		Equivalent 4-wire With Converter Sets TC-33-()	
	Aerial on Existing Poles	1 Quad	1 Quad	1 Quad	1 ^c	2 ^c	4	1 ^c	2 ^c	4
No. of Pairs	1 Quad	1 Quad	1 Quad	1 Quad	2	4	4	1 ^c	2 ^c	4
No. of Carrier Systems	1	1	1	1	1	2	4	1	2	4
No. of Intermediate Repeater Points	3	3	3	3	0	2	3	0	0	0
No. of Telephone Circuits	4	4	4	4	4	8	16	4	8	16
<u>Export Weight, Tons^g</u>										
Equipment ^{d,e}	5	5	5	5	3	8	8	6	11	23
Cable or Wire, Crossarms, Hardware, etc. ^{e,f}	45	45	44	44	67	126	123	51	67	123
Total without Poles	50	50	49	49	70	134	146	57	78	146
Poles, Guys, Anchors, etc.	161	-	-	-	164	162	164	164	164	164
Total with Poles	211	-	-	-	234	296	310	221	242	310
<u>Volume: Ship Tons^g (40 cu. ft. per ton)</u>										
Equipment ^{d,e}	11	11	11	11	6	16	16	11	22	45
Cable or Wire, Crossarms, Hardware, etc. ^{e,f}	63	63	61	61	76	140	140	59	76	140
Total without Poles	74	74	72	72	82	156	156	70	98	185
Poles, Guys, Anchors, etc.	244	-	-	-	250	250	250	250	250	250
Total with Poles	318	-	-	-	332	406	435	320	348	435
<u>Construction Time - Man-Days^h</u>										
Without Poles	440	440	285	285	600	810	810	490	600	810
With Poles	1030	-	-	-	1250	1460	1460	1130	1250	1460

^aPoles assumed to be 4" x 4" timbers, spaced 150 feet. See chapter 6 for information on other types of poles.

^bIf highways or roads are crossed aerially, the following allowance may be made for each crossing if messenger wire is to be used: weight of poles and accessory hardware, 330 lb., volume 12 cu. ft., construction time, 0.75 man days. With no messenger wire the corresponding figures are 350 lb., 10.5 cu. ft. and 0.65 man-days.

^cShort four-pin crossarms assumed for 1 and 2 pair lines.

^dIncludes telephone equipment only.

^eIncludes spare cable or wire and equipment as discussed in chapters 6 and 9.

^fIncludes miscellaneous material.

^gFigures rounded to the nearest ton.

^hConstruction times are estimated from Signal Corps field trials in the U.S. and are subject to wide variations. They do not apply to jungle conditions.

229. SUMMARY OF MATERIAL REQUIREMENTS FOR 300-MILE SYSTEMS USING FIXED PLANT OPEN WIRE LINES AND EQUIPMENT.

Using Voice Frequency Repeaters and Type C carrier on each pair ^a Using Voice Frequency Repeaters and no carrier ^a

No. of Open Wire Pairs	1	2	4	1	2	4
No. of Telephone Circuits	4	8	16	1	2	4

	Export Weight - Tons					
Equipment ^b	5	8	15	2	3	4
Wire, Crossarms, Hardware, etc. ^{c,d}	285	360	512	285	360	512
Total without Poles ^e	290	368	527	287	363	516
Poles, Guys, Anchors, etc. ^{e,d}	2540	2540	2540	2540	2540	2540
Total with Poles	2830	2908	3057	2827	2903	3056

Volume - Ship Tons (40 cu.ft. per ton)

Equipment ^b	10	17	32	4	5	7
Wire, Crossarms, Hardware, etc.	285	346	470	285	346	470
Total without Poles ^e	295	363	502	289	351	477
Poles, Guys, Anchors, etc. ^{c,d}	3340	3340	3340	3340	3340	3340
Total with Poles	3635	3703	3842	3629	3691	3817

Construction Time - Man Days

Without Poles ^e	1930	2290	2980	1920	2280	2970
With Poles	5410	5770	6460	5400	5760	6450

^a Assumes use of 1 intermediate repeater in each case.

^b Includes necessary testing equipment and tools, but does not include power equipment.

^c Assumes eight pin crossarms in all cases.

^d Class 7, 30 foot poles spaced 150 feet; 104CS wire. Material requirements based on paragraph 610.

^e Assumes poles in place and guyed.

This Page Intentionally Blank

CHAPTER 3
TELEPHONE STATION EQUIPMENT

Section I
General

301. SCOPE.

a. This chapter gives information on the various types of telephone equipment which are used to convert sound (voice) to electrical energy and vice versa. This equipment is generally known as "telephone station equipment" and includes microphones (telephone transmitters), receivers, headsets, head and chest sets, chest sets, handsets, telephones and loudspeakers.

b. Practically all of these items except telephones require auxiliary equipment to make them suitable for two way conversation over a telephone system. In general telephones are equipped with suitable signaling arrangements, a coil for separating the talking and listening paths, and means for obtaining d-c power for the microphone. Sound powered telephone equipment operates without coil or battery and, in the case of Handset TS-10, may be used without signaling equipment.

c. The information given in this chapter is divided as follows. Section II gives the characteristics of microphones and receivers, section III covers headsets, head and chest sets, chest sets and handsets. Sections IV and V cover telephones and loudspeakers respectively.

d. The export weights of the items listed in this chapter have not been included as the equipments are small and probably would not be packed individually.

Section II
Microphones and Receivers

302. GENERAL. The selection of the various items of telephone equipment is controlled largely by the purpose for which and the equipment with which it is to be used. Since the microphone and receiver to a great extent are the major factors in indicating the primary electrical characteristics of telephone equipment, information of this type has been included in this section.

303. MICROPHONES (Telephone Transmitters)

a. Microphones may be divided into two general categories namely, battery powered carbon type and sound powered magnetic or dynamic types. The carbon microphone such as that used in Handset TS-9 is about 25 db more sensitive than the most efficient magnetic type (TS-10), and from 40 to 50 db more sensitive than other types of magnetic microphones which are in use. Therefore the carbon microphone is more widely used than the

magnetic type microphone in spite of the fact that it may have a considerable amount of nonlinear distortion; its response frequency characteristic depends somewhat upon the level of sound pressure applied; in some cases its efficiency is affected by a change in angular position; and it generates a certain amount of "burning noise" between the carbon granules.

b. Microphones intended for use in oxygen masks are designed to have a rising response characteristic complementing that of the enclosure, wherein the low frequencies of speech are reinforced, so that the response of the mask-microphone combination is essentially flat.

c. Microphones such as the T-45 are of the differential type having both sides of the diaphragm open to the sound field. Hence, when placed in a sound field originating from a source at some distance, the diaphragm does not react and when placed close to the talker's lips the difference in pressure applied to the two sides of the diaphragm causes the instrument to operate. The performance of this instrument in high ambient noise fields is therefore dependent on wearing it in the proper position.

d. Paragraph 304 gives the stock numbers and descriptions of microphones including pertinent electrical characteristics. The performance characteristics given for microphones are based on talking levels, position of the microphone with respect to the lips, and the microphone current normally obtained in service. For example, Microphone T-17 is normally used under conditions of high ambient noise so that the user holds the microphone very close to the lips and talks louder than normal. The position of the microphone in the handset is fixed at about 1" from the lips when the receiver is held to the ear, and in general, the user talks in a normal manner. Under conditions of use, Microphone T-17 delivers approximately the same output as Handset TS-9-(), whereas with equal speech inputs the output of the T-17 would be from 10 to 15 db lower than that of the TS-9-().

e. The curves in paragraph 305 show the response frequency characteristics of the various microphones listed in paragraph 304. They indicate the relative efficiencies of the various microphones at different frequencies in the speech transmission band. These efficiencies are shown in db relative to a reference condition which is arbitrarily located in the general neighborhood of the curve for the microphone in Handset TS-9-().

304. MICROPHONES - DESCRIPTION AND STOCK NUMBER.

Type No.	Stock No.	Shown in Fig.	Resistance or Imp. Ohms	IB vs TS-9	Approx. Efficiency	Resp. Freq. Char. act.	Handset TS-9	Par. 306	Cord Length Ft.	Conductors	Plug Type No.	Remarks
Unit of Handset TS-9	4B1109()/S	301	75	0	II	II	See Handset TS-9					Cartridge type carbon microphone used in Handset TS-9. Units of various makes not interchangeable mechanically.
T-17	2B1617	302	60	0	I	I		5	3		PL-68	Hand held, non-positional, carbon type microphone with press to talk switch. Extra contacts for controlling radio circuit. Used with aircraft and vehicular radio and interphone sets.
T-21	4G1321	-	-	-	-	-		-	-	-	-	Condenser type microphone with two stage amplifier in housing with stand for shockproof suspension. Part of Sound Ranging Equipment GR-3.
T-24-()	2B1624()	-	60	-	-	-		Specify	4		PL-106	Carbon type microphone, part of Radio Sets SCR-194, 195, and 543.
T-26	4B415	-	60	0	II	II		6	3		PL-58	Carbon microphone, part of Head and Chest Sets HS-17-A and HS-19.
T-28-()	2B1628()	-	40	0	II	II		-	2		PL-109 or PL-68	Commercial telephone carbon type microphone mounted on bracket arm. Part of Radio Set SCR-197.
T-30-()	2B1630()	303	120	0	-	-		1	2		PL-291	Carbon inertia type throat microphone. 2 units in series in neckpiece with cordage attached and Neckband M-199. Used with aircraft and vehicular radio and interphone sets replaced by T-45 for ground force use.
T-32	2B1632	-	40	0	-	-		6-1/2	-	-	-	Carbon type microphone in desk stand with press-to-talk switch. Part of Radio Set SCR-188A.
T-34-A	2B1634A	304	200 ^a	-40	V	V		5	4		PL-179 JK-26	Employs magnetic type low level Microphone MC-253 for use in oxygen mask. Used with Radio Sets SCR-322 and SCR-342.
T-35	4G1335	-	75	0	II	II		10	3		PL-51	Similar to T-26. Part of Chest Set TD-1. Part of Radio Set SCR-206-B and SCR-206-C.
T-36-()	2B1636()	-	50	0	II	II		24	2		-	Carbon type microphone on handle with press-to-talk switch. Used in Public Address System PA-4.

Type No.	Stock No.	Shown Resistance in or Fig. Imp. Ohms	Approx. Efficiency DB vs Handset TS-9		Resp. Freq. Char-act. Par.305	Cord Length No. Ft.	Con-ductors	Plug Type No.	Remarks
			TS-9	Handset					
T-38-()	2B1633()	-	40	0	II	6	2	PL-58	Carbon type microphones on handle with press-to-talk switch. Part of Radio Set SCR-197. Not similar to Navy Microphone T-38.
T-42-()		Similar to ANB-M-C1							Replaced by microphones ANB-M-C1.
T-44-()	2B1644()	305	200 ^a	-40	V	5	4	PL-179 JK-26	Employs magnetic Microphone MC-253 designed for use in oxygen masks. Includes treated fabric Cover M-369 to facilitate removal of frost when used at low temperatures. Used with Radio Sets SCR-322 and SCR-542.
T-45	2B1645	306	60	-5	III	Cord part of face harness		PL-291	Carbon, antinoise lip microphones worn under a mask or in the open. Operative in very high ambient noise.
T-50-()	2B1650()	307	21000 ^a	-45	VI	9	3 & Shield	MC-3M	Moving coil type hand held or stand mounted (stand not included) microphones with press-to-talk switch. Used with Radio Sets SCR-299, SCR-300 and SCR-499.
ANB-M-C1	2B1660	308	60	0	IV	1	2	PL-291	Employs carbon type oxygen mask Microphone MC-254. Includes treated fabric Cover M-369 to facilitate removal of frost when used at low temperatures. Part of various radio sets which may also use Microphones T-17 and T-30-(). Replaces Microphone T-42.
Unit of Handset TS-10	4B1110()/3	309	700 to 1200 ^a	-25	VII	See Handset TS-10			Resonant magnetic type sound powered microphone unit used in Handset TS-10 and Navy Type I handset.
Unit of Handset TS-11	2B611()/3	-	75	0	II	See Handset TS-11			Cartridge type carbon microphone used in Handset TS-11.

^a Magnetic type microphones have inductance as well as resistance. Carbon microphones have resistance only.

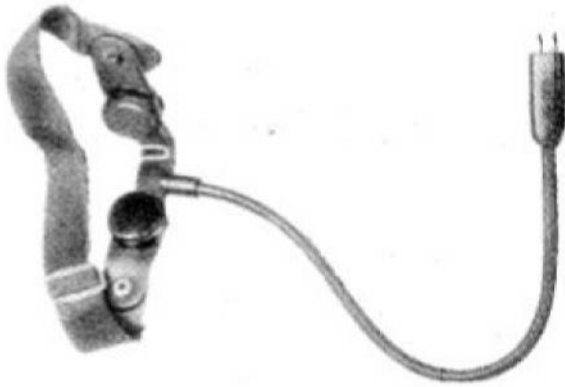

FIGURE 303. Microphone T-30-()



FIGURE 304. Microphone T-34-A

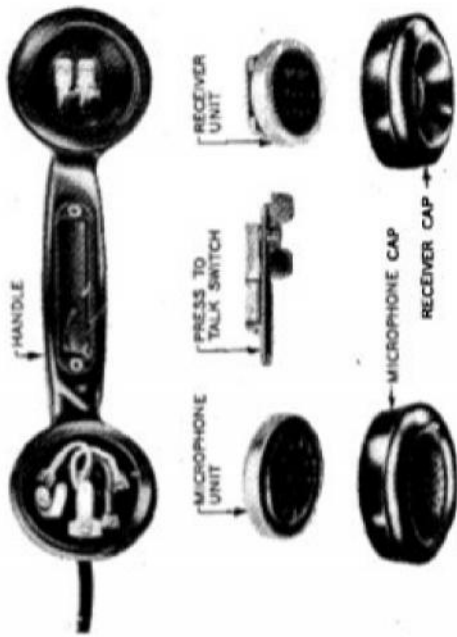

FIGURE 301. Handset TS-9-()



FIGURE 302. Microphone T-17



FIGURE 307. Microphone T-50-()



FIGURE 308. Microphone ANB-M-C1
(Cover M-369 removed)

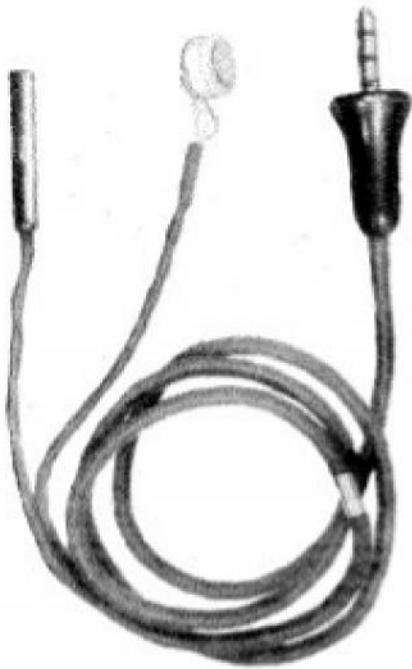

FIGURE 305. Microphone T-44-()
(With Cover M-369)

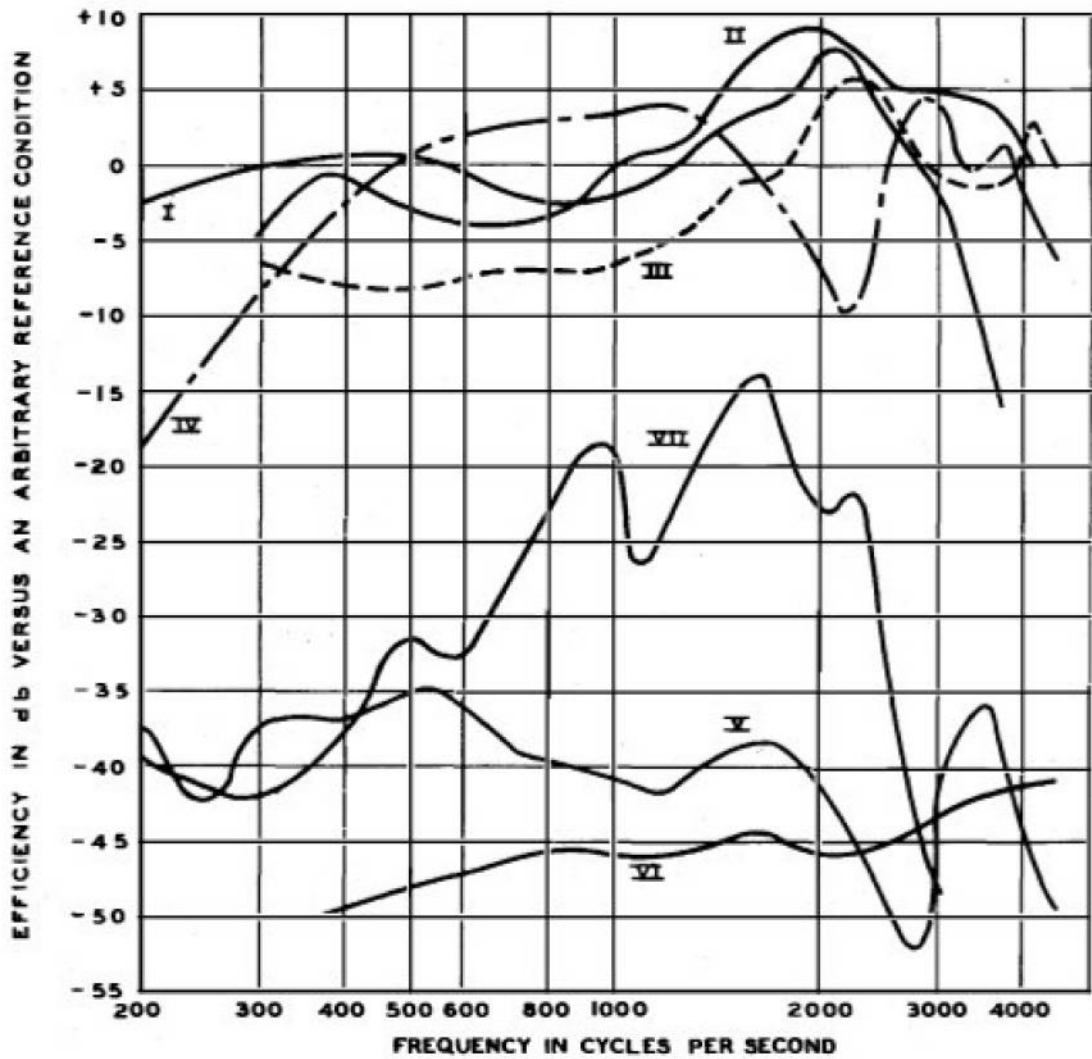

FIGURE 306. Microphone T-45



FIGURE 309. Handset TS-10

305. MICROPHONE RESPONSE FREQUENCY CHARACTERISTICS



- I T-17 (Carbon)
- II Unit of TS-9-(), also T-26, T-28-(), T-35, T-36-(), T-38-() (Carbon)
- III T-45 (Carbon, lip)
- IV ANB-M-C1 (Carbon, oxygen mask)
- V T-34-A and T-44-() (Magnetic, oxygen mask)
- VI T-50 (Moving Coil)
- VII Unit of TS-10 (Sound Powered)

306. TELEPHONE RECEIVERS.

a. The telephone receivers described in this chapter may be divided into three categories namely, the resonant magnetic type in which the diaphragm is undamped and clamped at the edge; the compensated magnetic type in which the diaphragm is damped and free to move at the edge; and the crystal type.

b. Resonant magnetic receivers are most suitable for the reception of tone telegraph signals where the resonant peak of the receiver matches the frequency of the tone. In the resonant magnetic receiver ("sound powered") where an armature drives the diaphragm, the peak in the response characteristic is much less severe than in the conventional type where there is no mechanical connection between the diaphragm and the pole pieces. With this type of receiver greater efficiency is obtained without introducing an excessive amount of frequency distortion. All sound powered units, headsets and microphones are designed to withstand the high pressures to which they are exposed during gun fire.

c. Compensated magnetic receivers are most suitable for the reception of speech

as they reproduce equally well the more important frequencies in the speech transmission band.

d. Crystal receivers while compact, light in weight, and have a wide frequency response, have limited use in military installations because the type of crystals used in them are easily damaged by high temperatures. Only one headset employing crystal receivers is available. One headset employing a crystal receiver is listed in paragraph 310.

e. The curves in paragraph 308 show the relative response frequency characteristics of the telephone receivers listed in paragraph 307. They indicate for the different receivers the variation of sound power output with frequency. They do not necessarily represent the relative overall efficiencies of the various receivers, particularly in those cases where one curve is shown as representative of two or more receivers. The efficiencies are shown in db relative to a reference condition which is arbitrarily located in the general neighborhood of the curve for the receiver in Handset TS-9-().

307. RECEIVERS - DESCRIPTION AND STOCK NUMBERS.

Type No.	Stock No.	Shown in Fig. #	Impedance Ohms	Approx. Efficiency DB vs Handset TS-9	Resp. Freq. Char-act. Par.308	Remarks
Unit of Handset TS-9	4B1109(y1	301	256	0	II	Compensated magnetic (controlled damped diaphragm) type unit. Used in Handset TS-9.
R-2	2B2002	310	12000	+5	I	Resonant magnetic (undamped clamped diaphragm) type, part of Headset P-11. Most suitable for reception of tone telegraph.
R-2-A	2B2002A	311	12000	+5	I	Similar to R-2 except for details of ear-piece. Part of Headsets P-12, P-16, P-18, P-20 and P-21.
R-3	4A1903	312	470	+5	I	Similar electrically to R-2-A except lower impedance. Part of Headset HS-20 furnished with Telegraph Set TG-5-A or TG-5-B type.
R-13	4B2513	-	256	0	I	Similar electrically to R-2-A except lower impedance. Part of Headset P-13.
R-14	2B2014	313	4000	-5	I	Similar electrically to R-2-A except lower impedance. Used with Cushion MC-162. Part of Headsets P-23, HS-18, HS-22-() and HS-23-().
R-15	2B2015	-	12000	-3	I	Similar to R-2-A except cap made for use with Cushion MC-114 furnished separately. Part of Headsets P-14, and P-19.
R-21	4B2521	319	128	0	II	Compensated magnet (controlled damped diaphragm) type unit in metal or plastic case equipped with Cushion MC-114. Part of Head and Chest Set HS-17-A. Most suitable for reception of speech.
R-22	4B2522	320	256	0	II	Similar to R-21 except for impedance and not equipped with cushion. Part of Head and Chest Set HS-19-A.

Type No.	Stock No.	Shown in Fig. ^a	Impedance Ohms	Approx. Efficiency DB vs Handset TS-9	Resp. Freq. Char-act. Par.308	Remarks
R-30-()	2B2030()	315	128	+4	III	Compensated magnetic (controlled damped diaphragm) hearing aid size plastic cased receiver with ear Insert M-300. Part of Headset HS-30-().
ANB-H-1	2B2051	318	300	-7	IV	Compensated magnetic (controlled damped diaphragm) type unit in plastic case. Usually used with Cushion MC-162. Efficiency poorer than Handset TS-9 but reproduces a 1000 cycle broader frequency band. Part of Headsets HS-33-() and HS-38.
Unit of Handset TS-10	4B1110()/1	309	700 to 1200	+10	V	Resonant magnetic, armature driven clamped diaphragm type. Receiver unit of sound powered Handset TS-10. Efficiency about 10 db better than that of Handset TS-9 but poorer speech fidelity.
Unit of Handset TS-11	2B611()/1	-	3500	0	II	Similar to unit of Handset TS-9 except for impedance.

^aAll receivers are part of headsets, head-chest sets or handsets and pictures of these receivers are shown as parts of the sets.

308. TELEPHONE RECEIVER RESPONSE FREQUENCY CHARACTERISTICS.

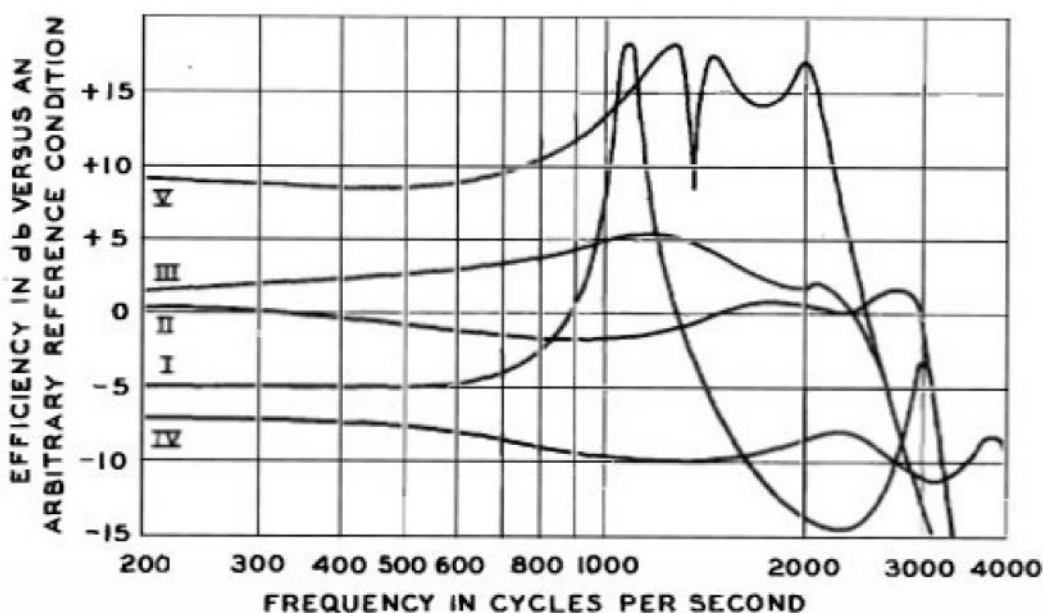

- I R-13, also R-2, R-2-A, R-3, R-14 and R-15 (resonant magnetic)
- II Unit of TS-9, also R-21, and R-22 (compensated magnetic)
- III R-30-() (compensated magnetic)
- IV ANB-H-1 (compensated magnetic)
- V Unit of TS-10 (sound powered)

Section III Telephone Sets

309. GENERAL. This section gives information on headsets, head and chest sets, chest sets, and handsets. These sets employ the microphones and receivers

described in section II, and are used with radio sets, telephones, test equipment and as operator sets at telephone switchboards. Descriptive matter and stock numbers for these headsets, head and chest sets, chest sets, and handsets are given in paragraphs 310, 311, 312 and 313, respectively.

310. HEADSETS - DESCRIPTION AND STOCK NUMBERS.

Type No.	Stock No.	Shown in Fig.	Receiver Type No.	Imp. of Set 1000 cps	Cord		Plug Type No.	Harness Band Strap		Remarks
					Length Ft.	No. ductors		No.	No.	
P-11	2B911	310	R-2	24000	7	2	PL-5	HB-1	ST-20	Double receiver headset. Furnished as part of several radio sets.
P-12	2B912	-	R-2-A	24000	4-1/2	2	PL-5	HB-4	ST-20	Double receiver headset for radio use. Headset P-16 may be used as replacement.
P-13	4B1313	-	R-13	612	10	2	PL-51	HB-5	ST-20	Double receiver headset with Cushions MC-114.
P-14	2B914	-	R-15	24000	7	2	PL-5	HB-4	ST-20	Double receiver headset with Cushions MC-114. Part of Radio Sets SCR-189, SCR-190 and SCR-199.
P-16	2B916	311	R-2-A	24000	7	2	PL-5	HB-4	ST-20	Double receiver headset. Similar to P-12 except equipped with longer and waterproof cord. Part of Radio Set SCR-163.
P-18	2B918	-	R-2-A	24000	7	2	PL-55	HB-4	ST-20	Similar to Headset P-16 except corded for Plug PL-55.
P-19	2B919	-	R-15	24000	7	2	PL-55	HB-4	ST-20	Similar to Headset P-14 except corded for Plug PL-55. Similar to headset P-18 except equipped with Cushions MC-114.
P-20	2B920	-	R-2-A	24000	7	2	PL-55	HB-1		Similar to Headset P-11 except corded for Plug PL-55.
P-21		-	R-2-A	24000	5-1/2	4	PL-55	HB-1		4 receivers on two headbands one unit of each headset connected in series to Plug PL-55. For two persons to listen simultaneously on two different circuits.
P-23	2B923	-	R-14	8000	5	2	PL-55	HB-7		Double receiver headset with Cushions MC-162. Used with radio sets.
HS-16-A	4A916A	-	-	520	4-1/2	2		HB-1		Double receiver headset. Used with code practice equipment.
HS-18	2B818	-	R-14	8000	1/2	2	PL-54	None.	Fits in Air Corps or Tank Crash Helmets	Double receiver headset with Cushions MC-162. Used with radio and interphones in aircraft and ground vehicles. Replaced by HS-30-() and Cord GD-604 (which includes a transformer) for ground use and by HS-38 for aircraft.
HS-20	4A920	312	R-3	470	3-1/2	2	PL-55	Web strap		Single receiver headset, part of Telegraph Sets TC-5-A and TC-5-B.

Type No.	Stock No.	Shown in Fig.	Receiver Type No.	Imp. of Set 1000 cps	Cord Length Ft.	No. Conductors	Plug Type No.	Harness Band No.	Strap No.	Remarks
HS-22-()	2B822()	-	R-14	8000	2-1/2	2	PL-55	None	Worn in helmet	Double receiver headset with Cushions MC-114. Part of Radio Set SCR-194.
HS-23-()	2B823()	313	R-14	8000	1	2	PL-54	HB-7		Double receiver headset with Cushions MC-162. Used with radio and interphone in ground vehicles and aircraft. Similar to P-23 except uses Cord CD-307 for bailout connection. Replaced by HS-30-() and Cord CD-604 (which includes transformer) for ground use and by HS-33-() for aircraft. Cord CD-307 is ordered separately.
HS-24	4B1304	314	Sound Powered Type	512	10	2	PL-58	HB-6		Double receiver headset with Cushions MC-114.
HS-29	-	-	R-30-()	256			PL-55	HB-30		4 receivers on two headbands with four-conductor cord terminated in two plugs. One unit of each headset connects the telephone and other connects to finder. Used in direction finding installations.
HS-30-()	2B830()	315 316	R-30-()	256	2	2	None	HB-30		Double, insert type receiver headset with ear Inserts M-300. When used with Cords CD-604 or CD-605 which include Coil C-410 impedance is 8000 ohms. These and other cording arrangements of Headset HS-30-() are shown in figure 316.
HS-33-()	2B833()	317	ANB-H-1	600	1-1/2	2	PL-354	HB-7		Double receiver headset with Cushions MC-162. Used with aircraft radio and interphone sets.
HS-36	2B838	318	ANB-H-1	600	1-1/2	2	PL-354	None		Double receiver headset for use in Air Corps helmets. Used with aircraft radio and interphone sets.
-	2B945	-	Brush Type BJ	40000	-	-	-	-	-	Double crystal type receiver headset. Part of radio Test Equipment IX-9.



FIGURE 311. Headset P-16



FIGURE 310. Headset P-11



FIGURE 312. Headset HS-20

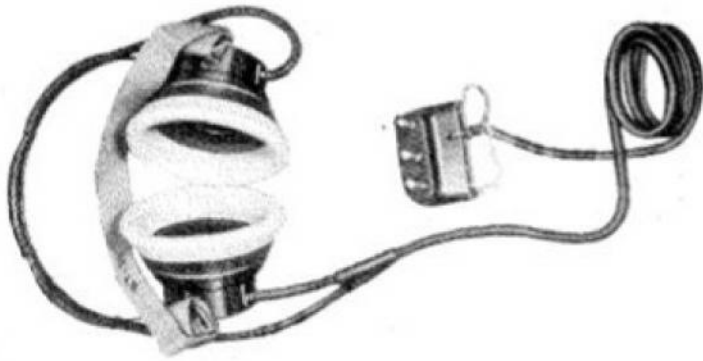

FIGURE 314. HEADSET HS-24



FIGURE 313. Headset HS-23-()

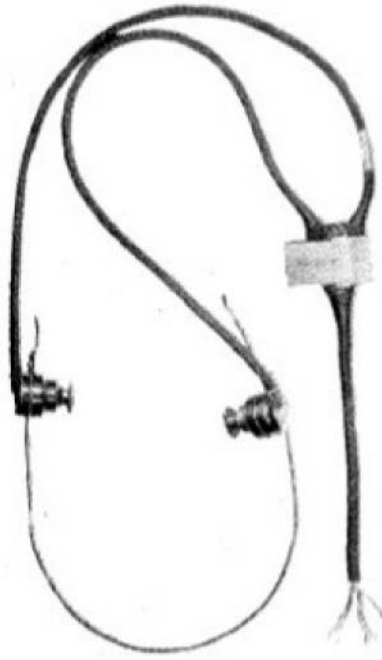

FIGURE 315. Headset HS-30-()

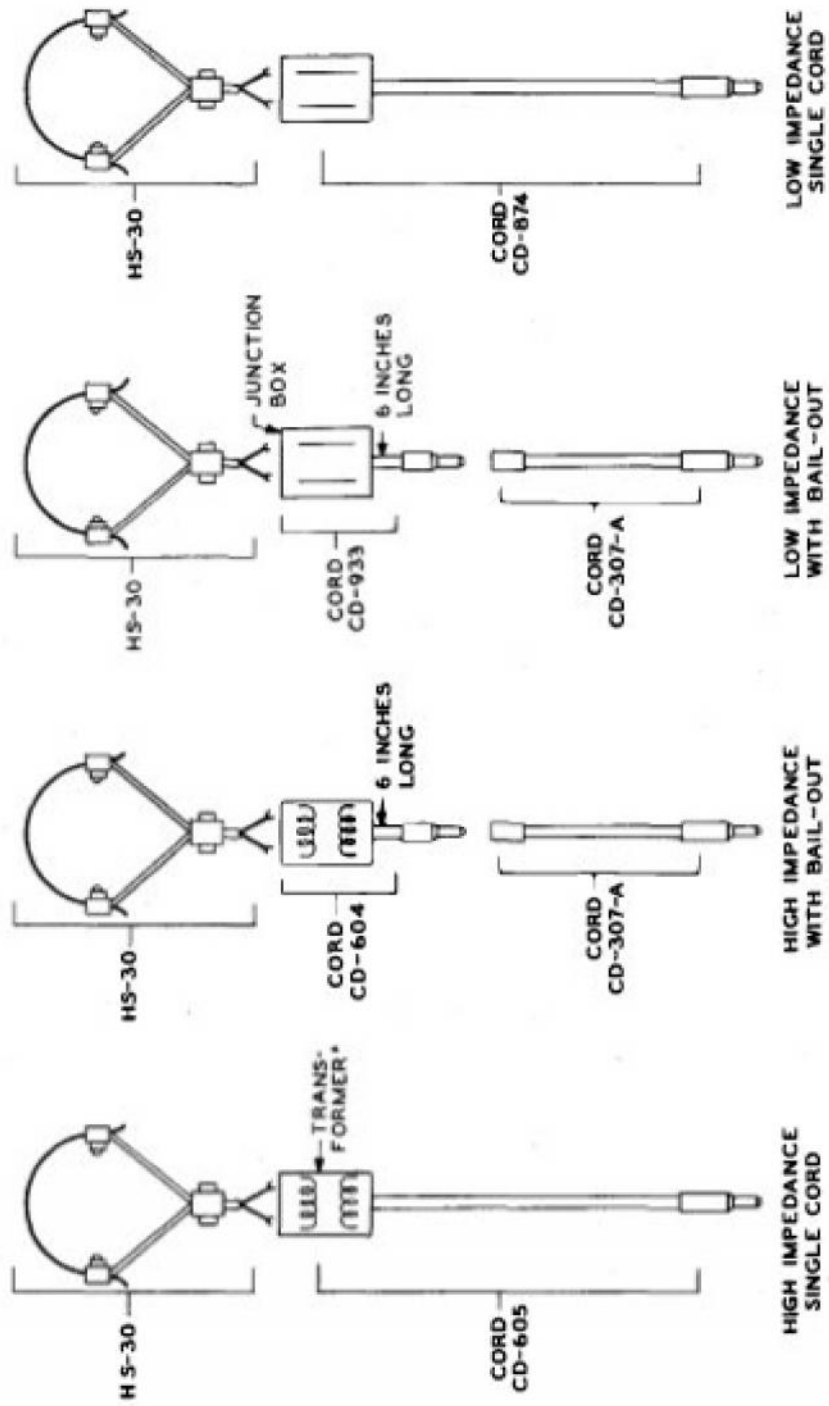

FIGURE 316. Headset HS-30-(). Cording Arrangements

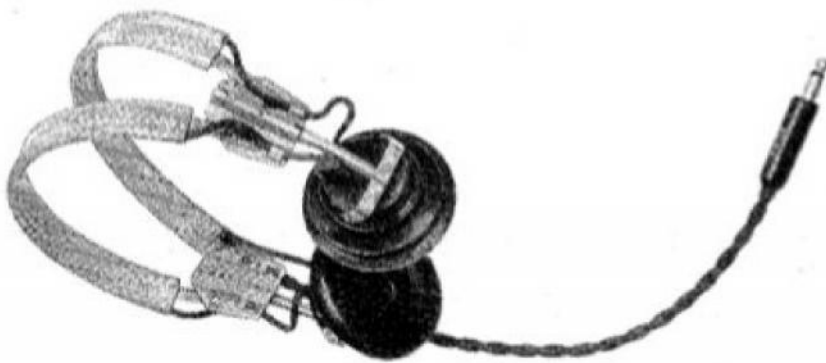

FIGURE 317. Headset HS-33- ()

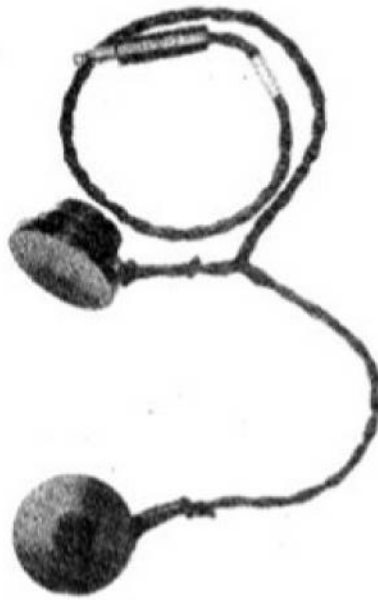

FIGURE 318. Headset HS-38

311. HEAD AND CHEST SETS - DESCRIPTION AND STOCK NUMBERS.

Type No.	Stock No.	Shown in Fig. No.	Receiver Type No.	Headset Imp.	Cord		Microphone Type No.	Res. Ohms	Remarks
					Type No.	Length Ft.			
HS-17-A	481277A	319	R-21	256	T-26	10	FL-58	75	Double receiver headset with Cushions MC-114 connected to chest unit. Press to talk switch on chest plate. Used with Telephones such as EE-8-(). Replaced by TD-2 and HS-30-().
HS-19	481279A	320	R-22	256	T-26	6	FL-58	75	Single receiver headset connected to Chest Unit. Switchboard operators telephone, also used with Telephone EE-8-(). Replaced by TD-1 and HS-30-().
HS-25-()	481285()	-	Sound Powered	700 to 1200		6	H-58	700	Single "sound powered" type receiver headset connected in parallel with sound powered microphone mounted on chest plate.
HS-27-()	481287()	-	R-21	256	T-46	6	FL-58	T-30-() 120	Double receiver headset with Cushions MC-114 connected to Chest Unit equipped with cord to accommodate Plug PL-291 of Microphone T-30-() furnished separately. Replaced by Chest Set TD-3 with Headset HS-30-().

*Magnetic microphone has inductance as well as resistance.



FIGURE 319. Head and Chest Set HS-17-A



FIGURE 320. Head and Chest Set HS-19

312. CHEST SETS - DESCRIPTION AND STOCK NUMBERS.

Type No.	Stock No.	Shown in Fig.	Chest Unit			Microphone		Remarks
			Type No.	Cord Length Ft.	Plug No.	Type No.	Res. Ohms	
TD-1	4B417	321	T-26	6	PL-58	Similar to unit of TS-9	75	Used with double receiver Headset HS-30-() with ear Inserts M-300. Press-to-talk switch on chest plate. Headset HS-30-() ordered separately. TD-1 plus HS-30-() replaces HS-19-A. Replaced by TD-1-A.
TD-1-A	-	-	T-26-A	6	PL-58	Similar to unit of TS-9	75	Similar to TD-1 except microphone is connected to switch block by a cord and plug to permit substitution of Microphone T-45. Replaces TD-1.
TD-2	4B417-2	-	T-26	10	PL-58	Similar to unit of TS-9	75	Similar to TD-1 except equipped with longer cord. TD-2 plus Headset HS-30-() which is ordered separately replaces HS-17-A. Replaced by TD-2-A.
TD-2-A	-	-	T-26-A	10	PL-58	Similar to unit of TS-9	75	Similar to TD-1-A except longer cord. Replaces TD-2.
TD-3	4B417-3	322	T-46	10	PL-58	T-45	60	For use with gas mask. Lip Microphone T-45 or throat Microphone T-30-() and Headset HS-30-() ordered separately. Press-to-talk switch on chest plate. TD-3 plus HS-30-() replaces HS-27-().
TD-4	-	323	T-51	-	PL-68-A PL-55-A	T-45	60	Chest Unit equipped with press-to-talk switch and jacks for microphone and headset. Line cord terminates in separate plugs for microphone and receiver. Headset and microphone ordered separately.
TD-5	-	-	T-52	-	PL-68-A PL-55-A	T-45	60	Similar to set TD-4 except equipped with transformer to raise impedance of headset connection to 8000 ohms. Used with vehicular and aircraft radio. Headset and microphone ordered separately.

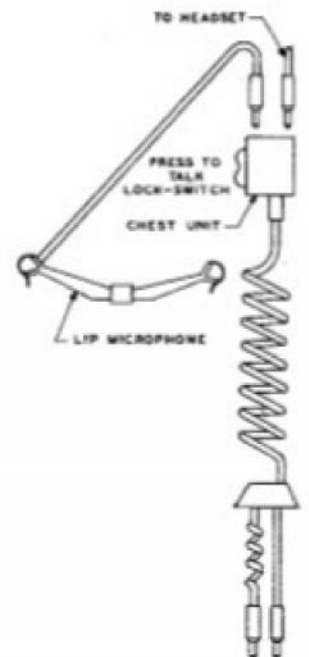
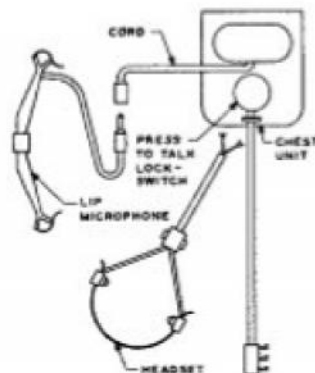
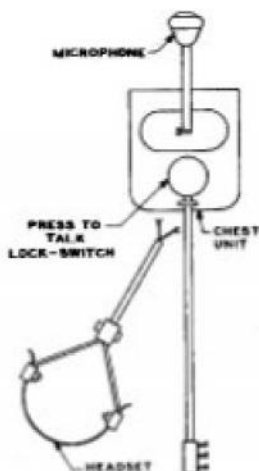

FIGURE 321. Chest Set TD-1

FIGURE 322. Chest Set TD-3

FIGURE 323. Chest Set TD-4

313. HANDSETS - DESCRIPTION AND STOCK NUMBERS.

Type ^a No.	Stock No.	Shown in Fig.	Press- to-talk Switch	Cord		Plug Type No.	Remarks
				Length Ft.	No. Con- ductor		
TS-9-()	4B1109()	301	Yes	9	3	Spade Term.	Handset for telephone use, molded handle in which are mounted switch, receiver unit, and transmitter unit. Interchangeable as assembly. Parts not all interchangeable with various makes. Part of Telephone KE-8-().
TS-10-()	4B1110()	309	No	6	2	Clips TL-37	Two sound powered units connected in parallel mounted in handle. Impedance of set 350 to 600 ohms. Part of Telephone TP-3 and Reel Equipment CE-11.
TS-11-()	2B611()	-	Yes	6	4	PL-105	Handset for radio use, molded handle in which are mounted press-to-talk switch, transmitter and receiver units. Interchangeable as assembly, parts not interchangeable with various makes. Cord equipped with built in RF coil. Part of Radio Sets SCR-195 and SCR-543.
TS-12-()	4B1112()	-	Yes	9	3	Spade Term.	Similar to TS-9-() equipped with hanger to engage switch-hook. Used with but not part of Telephone Box KE-91.
TS-13-()	2B613()	-	Yes	5	4	PL-55 & PL-68	Similar to but not interchangeable with Handset TS-11-(), has 750 ohm 1/2 W resistor assembled in handle. Part of Radio Sets SCR-509, SCR-510, SCR-609() and SCR-610().
TS-14-()	2B614()	-	No	5	4	PL-204	Similar to TS-9-() except without switch and cord to have receiver and transmitter circuits independent. Part of Radio Set SCR-561.
TS-15-()	4B1115()	-	Yes	5	4	PL-55 & PL-68	Similar to but not interchangeable with TS-13-(), uses different switch and resistor is omitted. Part of Radio Set SCR-300.
Type L Navy Code		-	Yes	4-1/2	2		Similar to TS-10-() except impedance 350 ohms and switch in handle connects both units to line cord.

^aFor electrical characteristics of microphone and receiver units of these handsets see paragraphs 304 and 307.

Section IV
Telephones314. GENERAL.

a. This section gives information concerning the various types of telephones namely, local battery, common battery, and sound powered.

b. The impedance characteristics of the sets have also been included as an aid in determining the transmission losses which are incurred when the telephones are bridged on working lines.

c. The transmission characteristics of Telephone KE-8-() also apply to the

operators telephone in many tactical switchboards as essentially the same telephone circuit is employed.

d. Where conditions make it desirable to use sound powered telephones because of failure of batteries either Telephone TP-3 may be used or Handset TS-10-() may be connected to terminals R and L1 of Telephone KE-8-(). Under emergency conditions of dry battery failure Telephone TP-3 or Handset TS-10-() may be used by magneto switchboard operators. On Switchboards BD-71 and BD-72 Handset TS-10-() should be connected to the A and B multiple binding posts in the rear of the board.

315. TELEPHONES - DESCRIPTION AND STOCK NUMBERS.

Type No.	Stock No.	Shown in Fig.	Efficiency in VS-KE-8-()		Impedance at 1000 cps ^a	Ref. Manual Number	Remarks
			Trans.	Rec.			
KE-8-()	4B5008()	324	0	0	900 / ⁶² ₃₅	TM 11-457 TM 11-333	Field telephone; weighs 9.5 lbs; local battery; leather or canvas carrying case, ringer; hand generator, ringing range 3000-ohm line with leakage resistance of 1000 ohms, 2000 ohms on lines equipped with two repeating Coils C-161; holding bridge provides signaling to common battery switchboards; antisidetone circuit; Handset TS-9-(); transmitter current supplied by two Batteries BA-30 (not included) on connections to either magneto or common battery boards.
KE-91	4B3191	325	0	0	-		Wall mounted telephone box; common battery; ringer; hand generator for signaling magneto lines; antisidetone circuit; Handset TS-12-() used with but not part of KE-91; transmitter current obtained from central office battery.
KE-92	-	-	0	0	-		Telephone Box KE-91 mounted in wooden box for outdoor use. Box ordered separately.
KE-93	-	-	0	0	-		Telephone Box KE-91 mounted in metal case for outdoor use. Box ordered separately.
TP-3	-	-	-25	+10	600 / ¹⁰	TM 11-2043	Field telephone; weighs 8 lbs; leather or canvas carrying case; sound powered handset TS-10-(); ringer; generator for signaling magneto switchboards. Used where conditions make batteryless operation necessary.
TP-6	4B5500-6	326	0	0	550 / ³⁰	TM 11-458	Combined hand telephone set; weighs 6 lbs; common battery; ringer; dial (optional); antisidetone circuit. See TM 11-486 for transmission loss on lines of appreciable resistance.
TP-9	-	-					Includes amplifiers in transmitting and receiving paths. See paragraph 906.

^aImpedance into line terminals of telephone. Where two values are given the first represents the condition where the press-to-talk switch is not operated, that is, the microphone circuit is open.

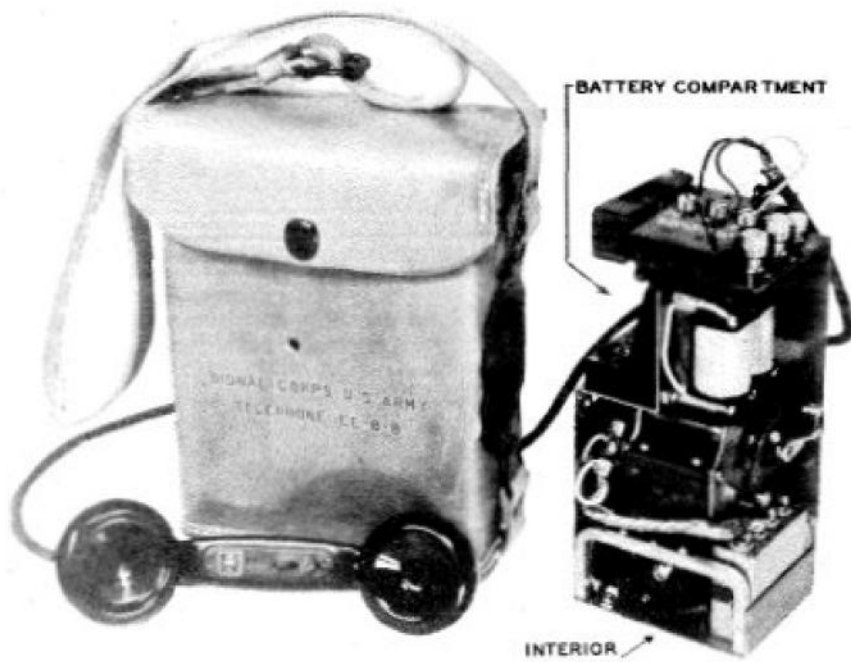

FIGURE 324. Telephone EE-8- ()



FIGURE 325. Telephone Box EE-91



FIGURE 326. Telephone TP-6

Section V
Loudspeakers

316. GENERAL.

a. The loudspeakers listed in paragraph 317 may be found useful in one way local communication circuits to individuals or to small groups of people.

b. When operated from microphones or telephones all of these loudspeakers will require speech amplifiers for satisfactory operation. Any amplifier with a reasonably good response frequency characteristic and capable of delivering 10 to 15 db above 1 milliwatt should be satisfactory.

317. LOUSPEAKERS - DESCRIPTION AND STOCK NUMBERS.

Type No.	Stock No.	Shown in Fig.	Input Impedance Ohms	Description
LS-1	6C35	-		4" electro-dynamic permanent magnet type speaker unit. Part of Radio Receiver BC-603.
LS-2	2Z6302	-	6	6" electro-dynamic permanent magnet type speaker unit in walnut cabinet. Weighs 4.5 lbs. Part of Radio Equipment RC-13.
LS-3	2Z6303.1	327	8000	6" electro-dynamic permanent magnet type speaker unit inclosed in a steel box, over-all dimensions 8-1/4" x 8-1/4" x 5-1/4", weighs 9 lbs, with an impedance matching transformer. Uses but does not include 4-foot Cord CD-267 with Radio Receiver BC-312 or 2-foot Cord CD-371 with Radio Receiver BC-189. Part of Radio Sets SCR-299-A and SCR-299-B.
LS-6	6C46C	-		4" electro-dynamic, permanent magnet type speaker unit mounted with baffle and horn. Part of Public Address System PA-4.
LS-7	2Z6310-7	328	4000	4" electro-dynamic, permanent magnet type speaker unit with input transformer mounted in rectangular steel case. 3-foot cord with Plug PL-55. Used with but not part of Radio Set SCR-284-().
LS-9	6C49	-	250	Similar to LS-3 except lower impedance input transformer.
LS-11	6051	-	250	Similar to LS-7 except lower impedance input transformer.



FIGURE 327. Loudspeaker LS-3



FIGURE 328. Loudspeaker LS-7

This Page Intentionally Blank

CHAPTER 4
TELEPHONE CENTRALS

Section 1
General Description

401. GENERAL. This chapter includes pertinent data on telephone switchboards and the associated equipment that makes up telephone centrals; test cabinets and testboards for telephone central applications; and fixed plant monitoring observing and recording facilities.

402. TELEPHONE SWITCHBOARD FUNDAMENTAL FEATURES.

a. The telephone switchboards listed are divided into two types, which are tactical and fixed plant switchboards. Both types include single position and multiple switchboards. Certain ones are for magneto lines only, others are for common battery lines only and some are for common battery lines primarily but can serve a limited number of magneto lines. No strictly long distance switchboards are included. Floor plan drawings are included for some switchboards.

403. SWITCHBOARD WORKING LIMITS.

a. The switchboard working limits shown are the maximum conductor loop resistances permissible for signaling (ringing and supervision) in the station lines and trunks connecting the telephones and the switchboards. They are approximate in some cases. These limits are based on American type telephones (such as Telephone TP-6) and central offices, assuming the resistance of each telephone to be about 100 ohms and the resistance of the central office battery supply circuits to be about 50 ohms with 24 volts and 400 ohms with 48 volts. These limits may be different for foreign types of telephones or central offices having

higher resistances in the transmitters and central office circuits, as discussed in TM 11-486 "Electrical Communication Systems, Engineering." The transmission losses due to central office equipment in a connection are listed. The working limits and transmission losses are taken from information furnished by the manufacturers. These may be used in connection with engineering studies and are for average conditions. Variations in the electrical characteristics of different pieces of apparatus such as occur in commercial production may occasionally produce losses somewhat different from those listed.

b. Paragraph 409 shows for various switchboard working limits, in ohms, the corresponding limits in allowable lengths of various types of wire and cable. Data are also given which indicate the lengths of various types of wire and cable which provide transmission losses of 2, 4, 6 and 15 db. The length of line permissible for telephones connected to a switchboard is limited by either resistance or transmission loss. The data of paragraph 409 will indicate, in any individual case, whether resistance or transmission is the limiting factor.

404. TESTBOARDS AND TEST CABINETS. Appropriate testing equipment is required in order to maintain central office equipment. Available types with their electrical and physical characteristics are listed in this chapter.

405. MONITORING, OBSERVING AND RECORDING FACILITIES. Information on monitoring observing and recording equipments is included. The issue of recording equipment is restricted and requests for it should be coordinated through ASF, OCSigO, SP3LP, indicating the use and necessity.

Section II
Tactical Telephone Switchboards
and Central Office Sets

406. ADAPTER PLUG U-4/GT. This is a newly developed individual combined plug, jack and neon glow lamp, shown in figure 401, for attachment to a magneto telephone line. It indicates ringing signals by silent visual signal. It has plugs and sockets arranged so that two or more lines can be connected by inserting the plugs of one unit into the jacks of another. The functions of a switchboard BD-9, BD-11 or SB-5()/PT including conference connections, can be performed with equipment of very much less weight by attaching the units to five or six lines that center at one point and using a Telephone KE-8-() for talking and ringing other stations. See TB SIG 61.

407. MAGNETO SWITCHBOARDS. The magneto switchboards listed in paragraph 410 include nonmultiple monocord type with a jack, a shutter type signal and a cord attached to each line circuit; and cord circuit type magneto switchboards. A second switchboard of the same type can be added to increase the capacity. They are either provided with carrying cases or are self-enclosing for quick packing. All lines and trunks are provided with electrical protectors. Switchboards BD-9 and BD-11 are obsolete but are included because some are still in use. Some of

these switchboards have simplex coils included in them for providing simplex telegraph circuits over magneto telephone station lines, and for phantom circuit use as described in Basic Field Manual FM 24-5.

408. COMBINED MAGNETO AND COMMON BATTERY SWITCHBOARDS.

a. Combined magneto and common battery switchboards are components of Telephone Central Office Sets. The common battery lines in these have lamps in series with the line, without line relays. The lamp jacks are in the multiple associated with the line multiple jacks. Ordinarily only one line lamp per line is used. Connections between components of a set are made with rubber insulated cables which have plug and jack terminals that permit connecting the units of a set without the use of soldering irons. The power required to operate these sets is about 1.75 kva at 115V a-c, 50 or 60 cycles.

b. These Telephone Central Office Sets can be installed in less than six hours by a crew of twelve men. The layout of Telephone Central Office Sets TC-1 and TC-10 should be as shown in figures 410 and 412 respectively; otherwise the cable racks will not fit and temporary racks will be required.

c. Switchboards BD-80-A, BD-89, BD-110 and some BD-120 have non-locked-in ring off and rering lamp signal supervision for magneto lines and two-way ringdown trunks which frequently results in short rering signals being overlooked.

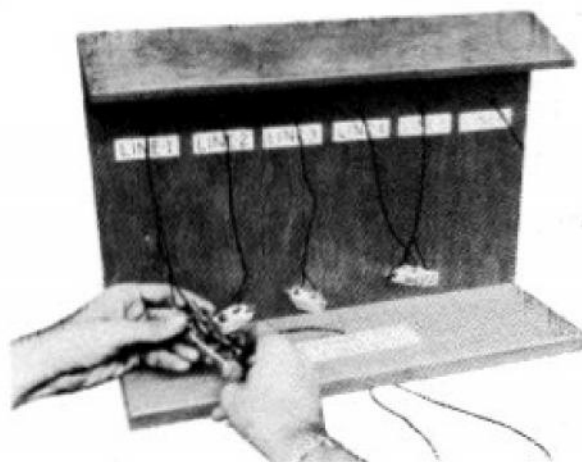
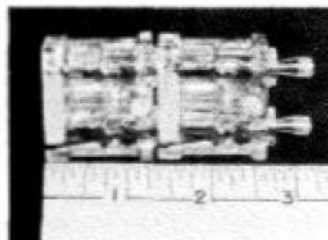
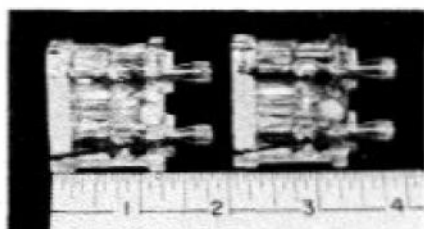

FIGURE 401. Adapter Plug U-4/GT

409. LENGTHS OF STATION LINE WIRE AND CABLE FOR VARIOUS SWITCHBOARD TRANSMISSION AND WORKING LIMITS.

		Thousand Feet										
Switchboard Working Limits Ohms	Nonloaded Wires (wet.)						Nonloaded Cables					
	083	109	080	104	W-130-A			Field (Wet.)	Paper Insulated			
	Galv. St'l.	Galv. St'l.	40% CS	40% CS	WD-3/TT	W-110-B	W-143	CC-345	16 ga.	19 ga.	22 ga.	
50	2.0	3.5	6.2	10.0	0.4	1.4	7.4	2.9	6.3	3.1	1.5	
75	3.2	5.2	9.7	15.6	0.7	2.1	11.3	4.4	10.0	4.6	2.3	
100	4.1	7.0	12.3	20.8	0.9	2.8	15.3	5.9	13.3	6.1	3.1	
125	5.1	10.5	15.4	26.0	1.1	3.5	18.9	7.3	16.7	7.7	3.8	
150	6.1	10.5	18.5	31.2	1.3	4.2	22.7	8.8	20.4	9.2	4.6	
175	7.1	12.3	21.6	36.4	1.6	5.0	26.5	10.3	23.3	10.7	5.3	
200	8.1	14.	24.7	41.6	1.8	5.7	30.3	11.8	26.7	12.3	6.2	
225	9.1	15.8	27.7	46.8	2.0	6.4	34.1	13.2	30.0	13.8	6.9	
250	10.2	17.6	30.9	52.0	2.2	7.1	37.9	14.7	33.4	15.3	7.7	
275	11.2	19.4	34.0	54.2	2.4	7.8	41.7	16.2	36.7	16.9	8.5	
300	12.2	21.1	37.2	62.5	2.7	8.5	45.5	17.6	40.1	18.4	9.2	
325	13.2	22.9	40.2	67.7	2.9	9.2	49.3	19.1	43.4	19.9	10.0	
350	14.2	24.6	43.2	72.8	3.1	9.9	53.1	20.6	46.7	21.5	10.8	
375	15.3	26.4	46.4	78.1	3.3	10.6	56.9	22.1	50.1	23.0	11.6	
400	16.3	28.2	49.4	83.2	3.6	11.3	60.7	23.5	53.4	24.5	12.4	
450	18.3	31.7	55.6	93.6	4.0	12.8	68.2	26.5	60.1	27.6	13.9	
500	20.3	35.2	61.7	104.1	4.5	14.2		29.4	66.7	30.7	15.5	
550	22.4	38.7	67.8	114.4	4.9	15.6		32.4	73.4	33.7	17.0	
600	24.4	42.2	74.1	125.8	5.3	17.0		35.3	80.1	36.8	18.5	
650	26.4	45.8	80.2	135.3	5.8	18.4		38.3	86.7	39.8	20.1	
700	27.4	49.3	86.4	145.7	6.2	19.9		41.2	93.5	42.8	21.7	
750	30.5	52.8	92.6	156.2	6.7	21.3		44.1	100.0	45.9	23.6	
800	32.5	56.3	98.7	166.4	7.1	22.7		47.1	106.6	49.1	24.7	
850	34.5	59.8	104.9	176.9	7.6	24.1			113.4	52.2	26.3	
900	36.6	63.3	111.1	187.5	8.0	25.5				55.2	27.8	
950	38.6	66.8	117.3	197.5	8.5	26.9				58.2	29.4	
1000	40.6	70.4	123.5	208.0	8.9	27.4				61.3	30.9	
1100	44.7	77.5	135.9	239.0	9.8					67.6	34.0	
1200	48.8	84.5	148.4	249.5	10.7						37.1	
1300	52.8	91.5	160.6	270.6	11.6						40.2	
1400	56.8	98.6	173.0	291.4							43.3	
1500	60.9	105.0	185.4	312.5								
2000	81.3	141.0	247.0	416.5								
2500	102.0	176.0	309.0									
3000	122.0	211.0	371.0									

		Nonloaded Wires (wet.)						Nonloaded Cables				
Data Used in Above Table	083	109	080	104	W-130-A			Field (Wet.)	Paper Insulated			
	Galv. St'l.	Galv. St'l.	40% CS	40% CS	WD-3/TT	W-110-B	W-143	CC-345	16 ga.	19 ga.	22 ga.	
Ohms/mile	130.	75.	43.8	25.	590.	186.	35.	90.	42.	86.	171.	
Ohms/M ft	24.6	14.2	8.1	4.7	111.0	35.0	6.6	17.0	8.0	16.2	32.3	
db/mile (wet)	0.37	0.31	0.25	0.18	6.50	2.80	1.20	1.70				
db/M ft (wet)	.07	.06	.05	.03	1.23	0.53	0.32	0.32				
db/mile									0.73	1.08	1.79	
db/M ft									0.14	0.19	0.34	

410. TACTICAL TELEPHONE SWITCHBOARDS AND CENTRAL OFFICE SETS - EQUIPMENT DATA.

Switchboard Type Number Technical Manual Shown in Fig. No. Classification Type	Switchboards			Central Office Sets										
	Single Position			Single Position				Multiple Position						
	HD-9	HD-11	HD-14	HD-71	HD-72	HD-75	SB-5()/PT	TO-2	TO-4	TO-12	TO-1	TO-5	TO-10	TO-20f
402 Obsolete Magnetophone	403 Obsolete Magnetophone	404 L't'd. Std. Magnetophone	405 Standard Magnetophone	406 Standard Magnetophone	406 Standard Magnetophone	TM 11-330	TM 11-2016	TM 11-340	TM 11-532	TM 11-536	TM 11-535	-	TM 11-538	RD-120
4	12	40	6	12	6	6	6	20	40	20	30	-	30	30
Mag. L. per Pos. ^a	Mag. Mult. per Pos.	CB. L. per Pos.	CB. Mult. per Pos. ^c	Man. Trks. per Pos. ^c	Dial Trks. per Pos. ^c	Univ. Trks. per Pos. ^{c,d}	Cord Ckts. per Pos.	Dial Cord per Pos.	Jks. in Conf. Ckt.	Test Cabinet	Grouping Key	Oper. Ckts. per Pos.	Simplex Coils	Dry Cells Req'd.
Monocord	Monocord	8	Monocord	Monocord	Monocord	Monocord	Monocord	5	1	1	1	1	1	1
12	2	4	6	4	6	4	6	2	2	4	8	6	2	2
BB-70-B	Yes	BB-70-F	Yes	BB-70-F	Yes	BB-70-F	Yes	BB-70-F	Yes	BB-70-F	Yes	BB-70-F	Yes	BB-70-F
RD-98	RD-90	RD-90	RD-90	RD-90	RD-90	RD-90	RD-90	RD-90	RD-90	RD-90	RD-90	RD-90	RD-90	RD-90
RD-90	RD-75	RD-75	RD-75	RD-75	RD-75	RD-75	RD-75	RD-75	RD-75	RD-75	RD-75	RD-75	RD-75	RD-75
BA-36()	BA-36-B	BA-36-B	BA-36-B	BA-36-B	BA-36-B	BA-36-B	BA-36-B	BA-36-B	BA-36-B	BA-36-B	BA-36-B	BA-36-B	BA-36-B	BA-36-B
TE-44-A	TE-44	TE-44	TE-44	TE-44	TE-44	TE-44	TE-44	TE-44	TE-44	TE-44	TE-44	TE-44	TE-44	TE-44
TE-44	TE-44	TE-44	TE-44	TE-44	TE-44	TE-44	TE-44	TE-44	TE-44	TE-44	TE-44	TE-44	TE-44	TE-44
TE-44	TE-44	TE-44	TE-44	TE-44	TE-44	TE-44	TE-44	TE-44	TE-44	TE-44	TE-44	TE-44	TE-44	TE-44
TE-44	TE-44	TE-44	TE-44	TE-44	TE-44	TE-44	TE-44	TE-44	TE-44	TE-44	TE-44	TE-44	TE-44	TE-44
TE-44	TE-44	TE-44	TE-44	TE-44	TE-44	TE-44	TE-44	TE-44	TE-44	TE-44	TE-44	TE-44	TE-44	TE-44
TE-44	TE-44	TE-44	TE-44	TE-44	TE-44	TE-44	TE-44	TE-44	TE-44	TE-44	TE-44	TE-44	TE-44	TE-44

^dUniversal* trunks can be used to connect to either manual or dial common battery central offices.

^eConverter can be used - not supplied as part of shipment (Converter M-222).

^fNot in production.

*Magnetophone line circuits can be used to terminate two-way ringdown trunks in any of the above switchboards.

^bIncludes 2 "Through" jack circuits and 5 "Line" jack circuits, additional.

^cThe manual, dial and universal trunks are designed for connection to subscriber's line circuits at the distant manual or dial common battery central office, and are ringdown incoming and automatic outgoing.

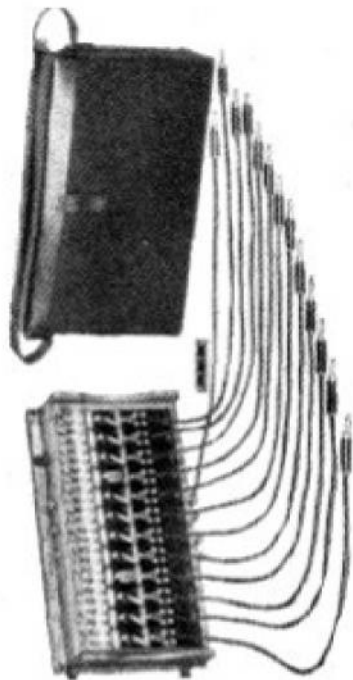

FIGURE 403. Switchboard BD-11

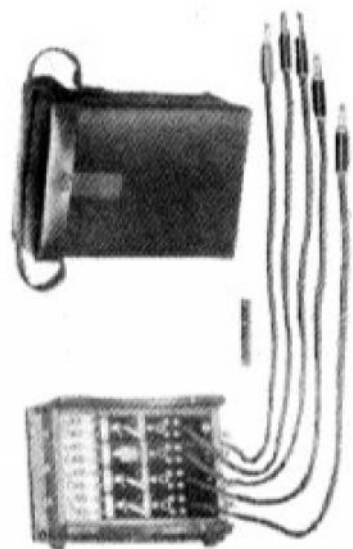

FIGURE 402. Switchboard BD-9

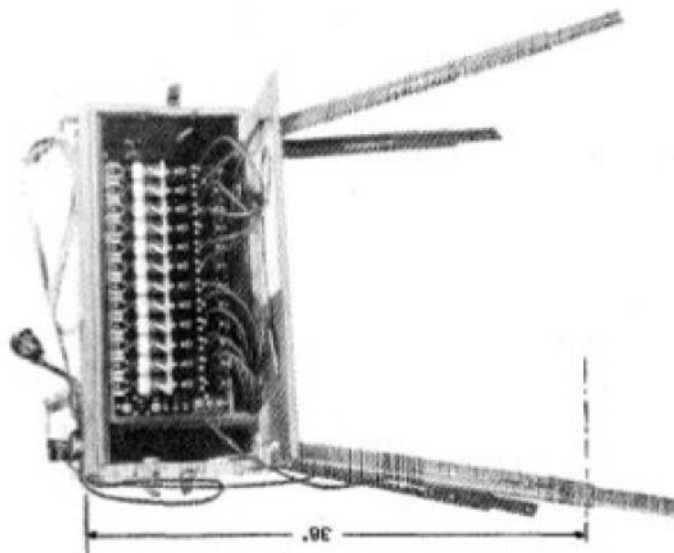

FIGURE 406. Switchboard BD-72

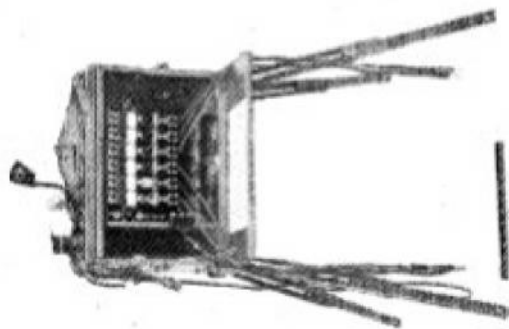

FIGURE 405. Switchboard BD-71

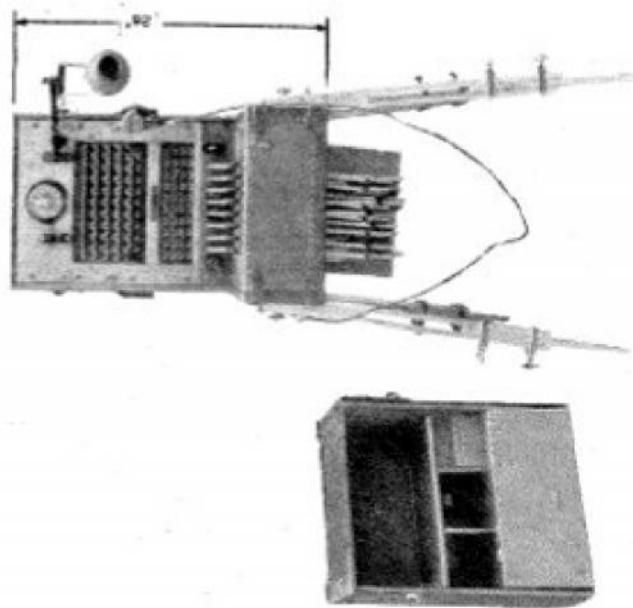

FIGURE 404. Switchboard BD-14



FIGURE 407. Switchboard SB-5()/PT

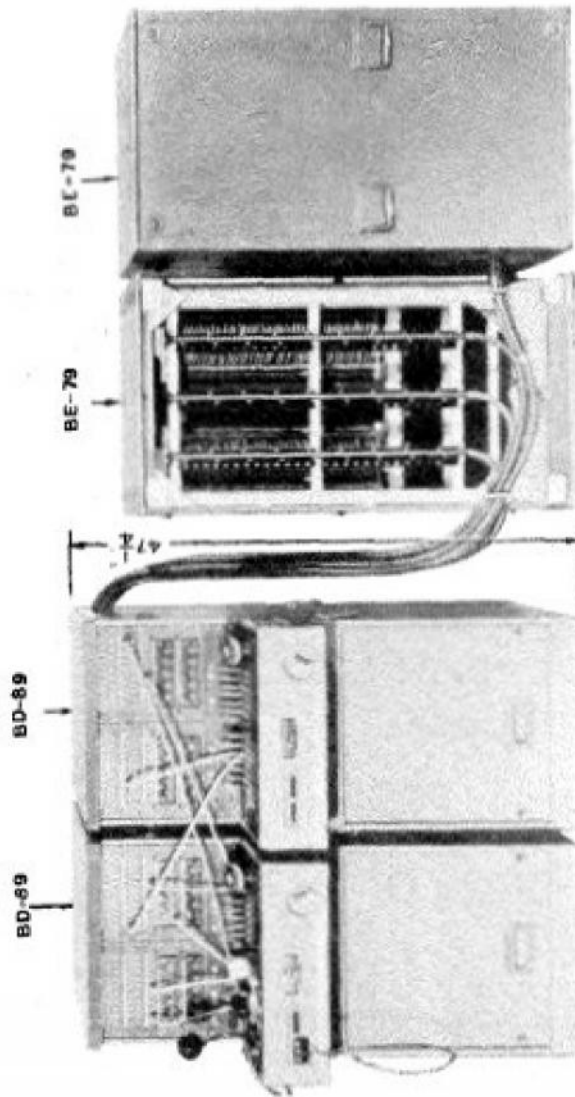

FIGURE 408. Two Telephone Central Office Sets TC-2 (Assembled)

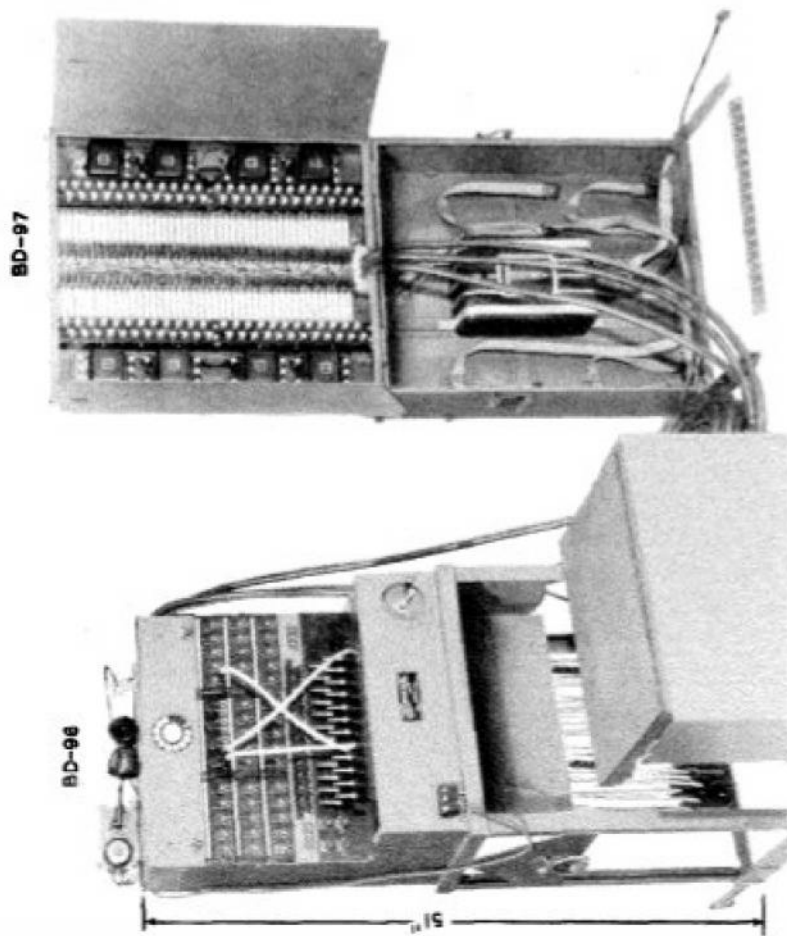

FIGURE 409. Telephone Central Office Set TC-4

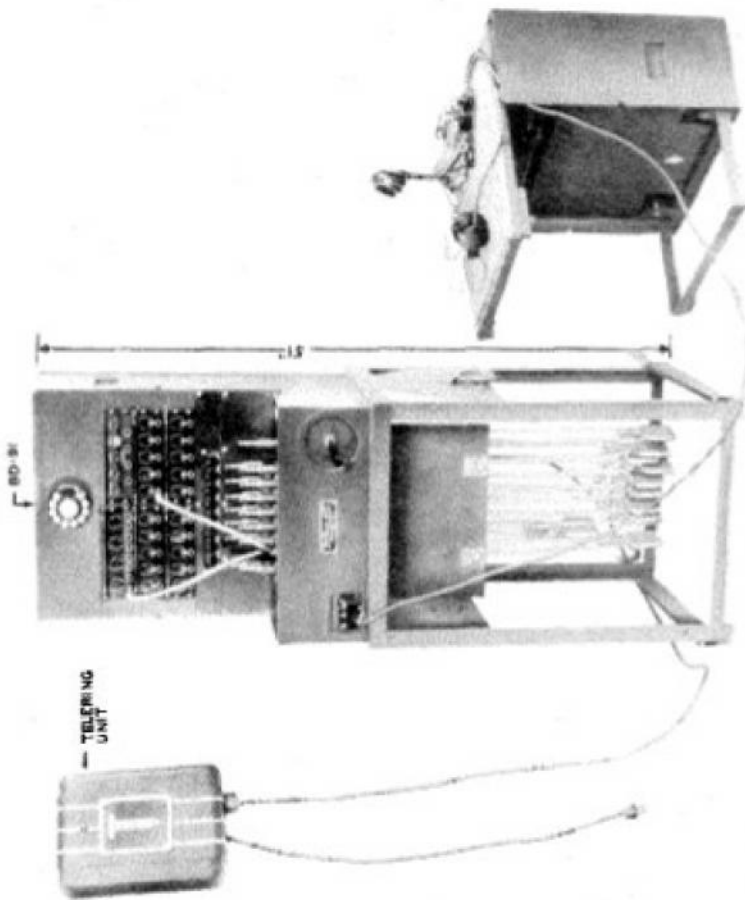

FIGURE 410. Telephone Central Office Set TC-12

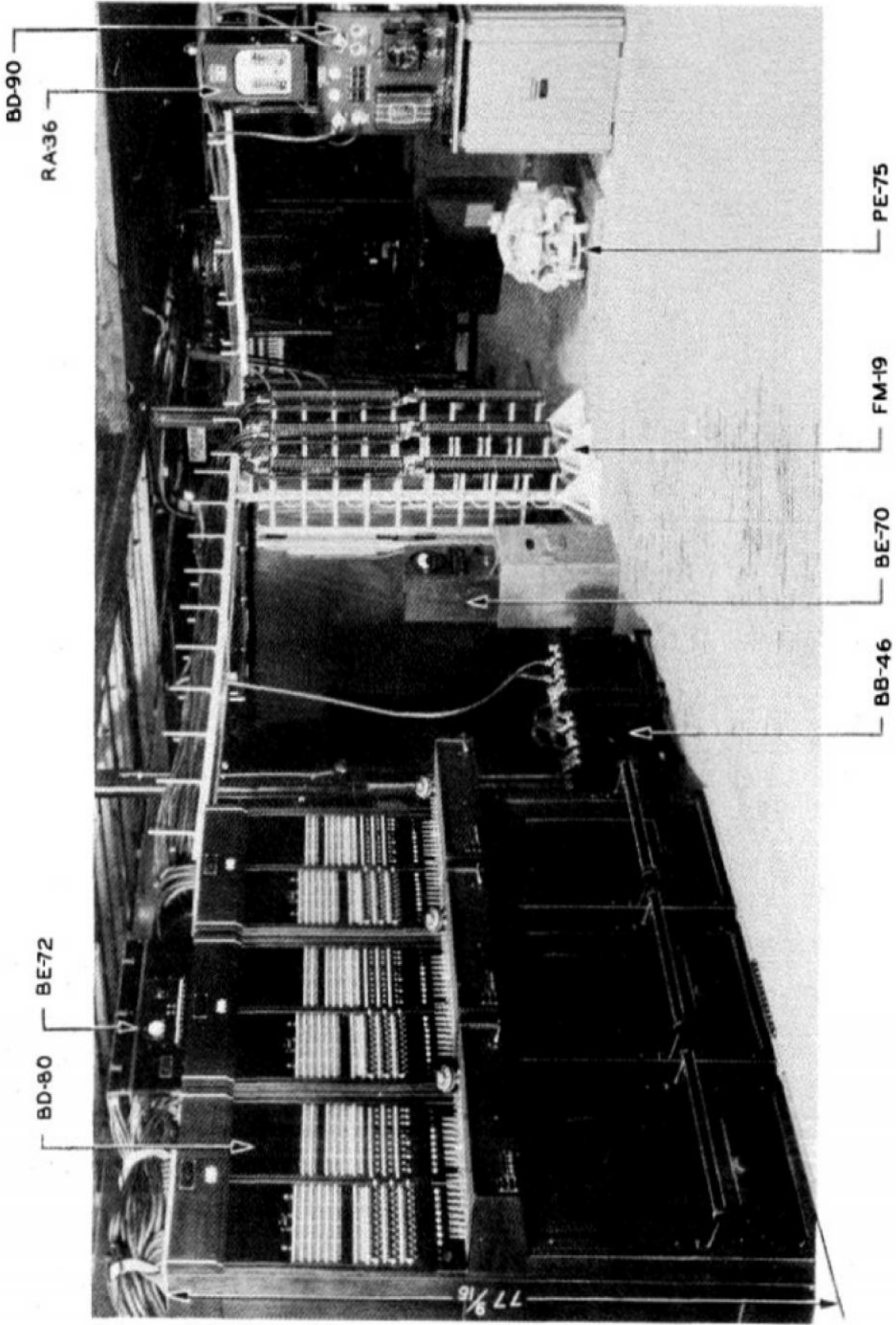

FIGURE 411. Telephone Central Office Set TC-1 (Assembled)

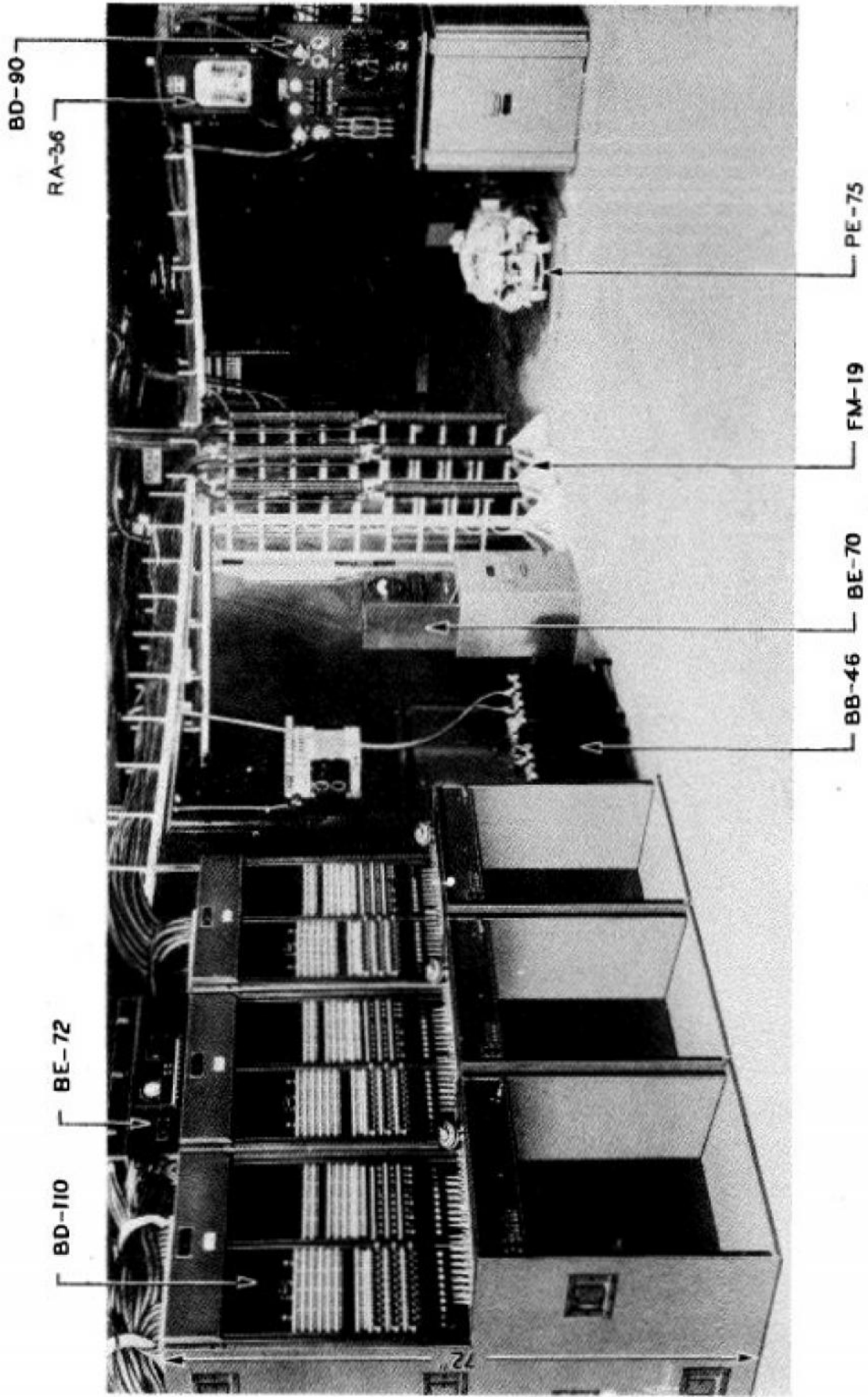

FIGURE 412. Telephone Central Office Set TC-10 (Assembled)

NO PHOTO AVAILABLE AT THIS PRINTING

FIGURE 413. Telephone Central Office Set TC-20.

411. TACTICAL TELPHONE SWITCHBOARDS AND CENTRAL OFFICE SETS - DESCRIPTION.

a. Switchboards.

(1) SWITCHBOARD BD-9. Field or camp monocord switchboard with fibre carrying case, total weight about 20 pounds, packed. Telephone KE-8-(), ordered separately, is used for operator set, and for ringing on lines. Trunks to other switchboards must be of the ringdown type. Night alarm bells WE 7BW or Buzzer 4C1707B operating on two Batteries BA-23, mounted externally and ordered separately. Two Switchboards BD-9 can be used together to double capacity. Line drop acts as ring-off or rering drop. Obsolete - no longer procured. Replaced by SB-5()/PT.

(2) SWITCHBOARD BD-11. Same as Switchboard BD-9 in general design and features except more lines provided. Total weight about 30 pounds packed. Obsolete - no longer procured, replaced by Switchboard BD-72. Two Switchboards BD-11 can be used together to double capacity.

(3) SWITCHBOARD BD-14. Field or camp magneto switchboard, portable, self enclosing trunk style, not requiring packing case. Total weight about 165 pounds, packed. Telescopic legs. Can be used for temporary or semi-permanent installation. Cord circuits are ring-thru type with one ring-off or rering drop; rings on both cords. Trunks to other switchboards must be of the ringdown type. Includes hand generator for ringing, also operator's head receiver and bracket mounted microphone. Night alarm uses two Batteries BA-23 ordered separately. Ltd. std. - no longer procured, replaced by Telephone Central Office Set TC-4.

(4) SWITCHBOARD BD-71. Field or camp monocord switchboard, cabinet style, self-enclosing, with handles and carrying strap; not requiring packing case. Telescopic legs. Total weight about 48 pounds, packed. Equipment is accessible from front, top and rear of cabinet. Line drop acts as ring-off or rering drop. A lamp on each side of switchboard furnishes illumination for night operation. Lower half of front acts as writing shelf and has a sheet of white pyrolin erasable writing surface for diagrams or other data. Trunks to other switchboards must be of the ringdown type. Simplex coils provided on two line units for telegraph or phantom use. Two Switchboards BD-71 can be used together to double capacity. Spark gaps provided on lines. Includes hand generator for ringing, also operator's head and chest set. Six Batteries BA-30 required (3 talking and 3 night alarm), ordered separately.

(5) SWITCHBOARD BD-72. Same as Switchboard BD-71 in general design and features except more lines are provided and simplex coils are provided in four line units for telegraph or phantom use. Total weight about 72 pounds, packed.

Two Switchboards BD-72 can be used together to double capacity.

(6) SWITCHBOARD SB-5()/PT. Field or camp monocord switchboard with case and moisture proof Bag BG-169. Weight about 11.5 pounds, packed. Telephone KE-8-() ordered separately, is used for operator's set and for ringing on lines. Trunks to other switchboards must be of the ringdown type. Two Switchboards SB-5()/PT can be used together to double capacity. Line drop acts as ring-off or rering drop. Replaces BD-9.

b. Central Office Sets.

(1) CENTRAL OFFICE SET TC-2. Army Corps, or other headquarters complete transportable single position magneto and common battery central office set shipped in trunk type carrying cases. Main component is Switchboard BD-89 which is a two-panel nonmultiple position. Total weight is about 2900 pounds, packed and the largest unit is 22-1/2" x 35-1/2" x 47-1/4" and weighs about 400 pounds, packed. A grouping key is provided so that two switchboards can be operated side by side by one attendant. Lamps are used as trunk signals and also in series with the line and without line relays on common battery lines. Drops are used on magneto lines. Cord circuits are "Universal" (i.e. can connect magneto lines to common battery lines), bridged impedance, series condenser type with separate supervisory lamps for front and back cords and a third lamp for magneto line and ringdown trunk supervision which does not lock in; rings on front cord only. Uses magneto lines as two-way ringdown trunks. Trunks to manual and dial common battery offices are two-way, designed to terminate on subscriber's line circuits at the distant office and are ringdown incoming and automatic outgoing. With dial offices that reverse the line when the called party answers, these trunks will extinguish the cord lamp at that time and relight it when they hang up. With some manual central offices the marginal difference between the line relay current and the cord circuit current will operate the cord supervisory lamp when operator at distant office answers or releases. Otherwise the operator must depend for supervision on the one lamp of the cord that is connected to the local line. One dial cord. Five jack conference circuit. Two "thru" circuits consisting of two jacks each, for looping a circuit thru this switchboard and provide for testing it in either direction. Three "line" circuits consisting of one jack each which are simply tip, ring and sleeve carried out to terminals, for use in any desired purpose. Rubber covered flexible cables connect component parts. Includes Main distributing frame Cabinet BE-79 which has space for but does not include simplex coils; Batteries BB-46 for 24V; Power unit PE-75-(); power Panel BD-98; a-c power distribution Cabinet BE-75; Rectifier RA-36; 1 chair;

2 operator's head and chest sets; connecting cables; Maintenance Equipment ME-6 (Misc. items but no spare parts); wire chief's test set, Cabinet BE-70-B; and Tool Equipment TE-44.

(2) CENTRAL OFFICE SET TC-4. Division or other headquarters non-multiple magneto central office of which Switchboard BD-96 is the main component and which is a portable single position housed in a steel cabinet which acts as its base when in use and as a shipping case for transportation. Weight about 590 pounds, packed, of which largest package is 15" x 22" x 27" weighing 225 pounds. Cord circuits are ring-thru type with one ringoff or rering drop; rings on both cords. Hand generator in switchboard for emergency ringing current. One dial cord. Six jack conference circuit. Simplex coils for any eight lines for telegraph or phantom use. Includes Panel BD-97 which is a main distributing frame unit, equipped with high potential and sneak current arresters wired to binding posts for incoming lines; six Batteries BA-30; operator's head and chest set; rubber covered flexible cables to connect component parts; Maintenance Equipment ME-11 which includes tools, a few miscellaneous items and some spare parts. Panel BD-97 includes Telering to furnish ringing current if 115V a-c, 50 or 60 cycle power is available. Converter M-222 operating on two Batteries BA-23 can be used if a-c is not available but must be ordered separately. Grouping key permits two adjacent switchboards to be operated by one attendant. Four drop signal trunks provide connection to manual or dial common battery control offices. Magneto lines can be used for terminating two-way ringdown trunks. Cover of switchboard serves as operator's chair.

(3) CENTRAL OFFICE SET TC-12. Army Air Force Squadron or other headquarters nonmultiple magneto central office, of which Switchboard BD-91 is the main component and which is a portable single position housed in a steel cabinet which acts as its base when in use and as a shipping case for transportation. Weight about 325 pounds packed, of which the largest package is 17" x 18" x 25" weighing about 225 pounds. Cord circuits are ring-thru type with one ringoff or rering drop. Hand generator in switchboard for emergency ringing current. One dial cord. Four jack conference circuit. Simplex coils on four lines for telegraph or phantom use. Includes operator's head and chest set, Maintenance Equipment ME-30 which includes tools, a few miscellaneous items but no spare parts; and Telering to furnish ringing current if 115V a-c 50 or 60 cycle power is available. Grouping key permits two adjacent switchboards to be operated by one attendant. Line ruses and gap arresters are mounted in rear of switchboard and binding posts on this equipment serves as main distributing

frame. Drop signal trunks provide connection to manual or dial common battery central offices designed to terminate there on subscriber's line circuits. Magneto lines can be used for terminating two-way ringdown trunks. Cover of switchboard serves as operator's chair.

(4) CENTRAL OFFICE SET TC-1. Army or other headquarters complete transportable multiple type magneto and common battery central office set shipped in carrying cases enclosing the majority of its components, of which three Switchboards BD-80-A are the main components. Total weight about 10,600 pounds, packed for export. Largest package is 86-3/4" x 33-1/4" x 43-3/8" and weighs about 900 pounds, packed for export. Two panel positions; can be used in groups of 1 to 6 in one lineup. Multiple jacks are series cut-off type which obviate cut off relays on common battery line circuits. Lamps are used as trunk signals and in series with the line and without the use of "line" relays on common battery lines. Drops are used on the magneto lines. Magneto lines may be used for terminating two-way ringdown trunks. Cord circuits are "Universal" (i.e. can connect magneto lines to common battery lines), bridged impedance, series condenser type with separate lamps on front and back cords for supervision on common battery lines and a third lamp for magneto line and ringdown trunk supervision which does not lock in; rings on front cord only. Trunks to manual and dial common battery central offices are two-way, designed to terminate on subscriber's line circuits at the distant office and are ringdown incoming and automatic outgoing. With dial offices that reverse the line when the called party answers, these trunks will extinguish the cord lamp at that time and relight it when they hang up. With some manual central offices the marginal difference between the line relay current and the cord circuit current will operate the cord supervisory lamp when operator at distant office answers or releases. Otherwise the operator must depend for supervision on the one lamp of the cord that is connected to the local line. Hand generator on each position for emergency ringing power. Special jacks are provided on each position which permit a second operator using a Telephone EE-8-() to assist in handling traffic on a position. A grouping key on each position transfers the cord circuits to an adjacent position operator's circuit. One dial cord and one 10 jack conference circuit per position. Rubber covered flexible cables connect component parts. These switchboards may be operated in multiple with Switchboards BD-110 but the trunks are different and cannot be bridged, and the Switchboards BD-110 must be on a raised platform 10 in. high to bring key shelves to same level as Switchboard BD-80-A. Includes one cross-connecting Frame FM-19 for each switchboard

position installed, (each of which terminates 100 lines with a carbon block arrester and a heat coil for each line wire and binding posts for terminating field lines; the line binding posts are connected to another set of binding posts to which cross connections can be attached to run to a third set of binding posts where the connecting cables to the switchboard position attach); Four batteries BB-46 for 48V; Power Unit PE-75-(); power Panel BD-90; Rectifier RA-36; test and power distribution Cabinet BE-72; 3 operator's chairs; 6 operator's head and chest sets; connecting cords (cables); cable racks; Maintenance Equipment ME-4 (misc. items but no spare parts); wire chief's test set, Cabinet BE-70-(); and Tool Equipment TE-44-(). Rep'l. by TC-20.

(5) CENTRAL OFFICE SET TC-5. Consists of the additional equipment necessary to make two Telephone Central Office Sets from a single Telephone Central Office Set TC-1 or TC-10, or three sets from two. Particularly useful in moving a central office set from one location to another, placing one or two positions in service at the new location while keeping the remainder working at the old location. Includes Batteries BB-56; Rectifier RA-36, power Panel BD-90; test and power distribution Cabinet BE-72; and necessary maintenance tools, cable racks, etc. Replaced by AN/GTA-1-().

(6) CENTRAL OFFICE SET TC-10. Army or other headquarters complete transportable multiple type magneto and common battery central office set in which the three Switchboards BD-110 differ from the Switchboards BD-80-A in being trunk type with handles and which require no packing cases. Trunk type carrying cases are used for the majority of the other components. Total weight about 10600 pounds, packed for export. The largest package is 36-3/4" x 26-1/2" x 72" and weighs about 900 pounds packed for export. Two panel positions can be used in groups of 1 to 6 positions in one line-up. Multiple jacks are series cut-off type which obviates cut-off relays on common battery lines. Lamps are used as trunk signals and in series with the line and without the use of "line" relays on common battery lines. Drops are used on the magneto lines. Cord circuits are "Universal" (i.e. can connect magneto lines to common battery lines), bridged impedance, series condenser type with separate lamps on front and back cords for supervision on common battery lines and a third lamp for magneto line and ringdown trunk supervision which does not lock in; gives one lamp supervision on trunk connections to manual or dial common battery offices, rings on front cord only. Uses magneto lines as two-way ringdown trunks. Trunks to manual and dial common battery central offices are two-way, designed to terminate on subscriber's line circuits at the

distant office and are ringdown incoming and automatic outgoing. These trunks do not give supervision on cords connected to them, therefore the operator must depend for supervision on the lamp of the cord that is connected to the local line. Hand generator on each position for emergency ringing power. Special jacks are provided on each position which permit a second operator, using a Telephone KE-8-() to assist in handling traffic on a position. A grouping key on each position transfers the cord circuits to an adjacent position operator's circuit. One dial cord and one 10 line conference circuit per position. Rubber covered flexible cables connect component parts. These switchboards may be operated in multiple with Switchboards BD-80-A but the trunks are different and cannot be bridged and the Switchboards BD-110 must be on a raised platform 10 in. high to bring Key shelves to same level as Switchboard BD-80-A. Includes one cross connecting Frame FM-19 for each switchboard position installed (each of which terminates 100 lines with a carbon block arrester and a heat coil for each line wire and binding posts for terminating field lines, with line binding posts connected to another set of binding posts to which cross connections can be attached to run to a third set of binding posts where the connecting cables to the switchboard position attach); cable racks; four Batteries BB-46 for 48V; Power Unit PE-75-(); power Panel BD-90; Rectifier RA-36; 3 operator's chairs; 6 operator's head and chest sets; connecting cords (cables); wire chief's test set, Cabinet BE-70-(); Maintenance Equipment ME-4 (misc. items but no spare parts); and Tool Equipment TE-44-(). Rep'l. by TC-20.

(7) CENTRAL OFFICE SET TC-20. Army or other headquarters complete transportable multiple type magneto and common battery central office set in which the three Switchboards BD-120 like Switchboard BD-110, are trunk type with handles and which require no packing cases. Trunk type carrying cases for the majority of the other components. Two panel positions to which a fourth Switchboard BD-120 can be added in one line-up. The three position complete set is designed so that each component weighs less than 750 pounds, exclusive of the power plant. Multiple jacks are series cut-off type which obviates cut-off relays on common battery lines. Lamps are used in series with the line and without the use of "line" relays on common battery lines. Drops are used on trunks and magneto lines. Magneto lines can be used in terminating two-way ringdown trunks. Cord circuits are "Universal" (i.e. can connect magneto lines to common battery lines). Separate lamps on front and back cords provide supervision on common battery lines. Some have a third lamp for nonlockin ring-off and rering for magneto line and ringdown trunk supervision, and others have a drop. Rings on front cord

only. Trunks to manual and dial common battery central offices are two-way, designed to terminate on subscriber's line circuits at the distant office and are ringdown incoming and automatic outgoing, operating the cord supervisory lamp when operator at distant office answers or releases. Hand generator on each position for emergency ringing power. A splitting key divides the cord circuits into two groups and permits two operators to work one position. A heating unit is in base of each position. A grouping key on each position transfers the cord circuits to an adjacent position operator's circuit; one dial cord and one 10 jack conference circuit per position. Rubber covered flexible cables with spade terminals connect component parts. These switchboards cannot be used in multiple with Switchboards BD-80-A of Telephone

Central Office Set TC-1 or Switchboards BD-110 of Telephone Central Office Set TC-10. Includes one cross connecting Frame FM-64-() for each switchboard position installed (each of which terminates 75 lines with a carbon block arrester and a heat coil for each line wire and binding posts for terminating field lines; the line binding posts are connected to another set of binding posts to which cross connections can be attached to run to a third set of binding posts where the connecting cords to the switchboard position attaches): Cable racks; four Batteries BE-46 for 48V; power Panel BD-132-(); power Unit PR-75-(); Rectifier RA-91-(); connecting cables, 3 operator's chairs, 6 operator's head and chest sets; Maintenance Equipment ME-63-(); and Tool Equipment TE-44-(). Replaces TC-1 and TC-10.

412. TACTICAL TELEPHONE SWITCHBOARDS AND CENTRAL OFFICE SETS - WORKING LIMITS IN OHMS.

Nomenclature		To Magneto Telephone KE-8-() (in L.B. position)			To Common Battery Telephone TP-6		Trunks to Dial Office		Trunks To Manual Office	
		Max. Cond. Loop	No With Min. Repeat Coils	Max. Cond. Res.	Min. Ins. Loop	Max. Cond. Res.	Min. Ins. Res.	Max. Cond. Loop	Min. Ins. Res.	
Name	Type No.	Repeat Coils	Repeat Coils ^a	Ins. Res.	Loop	Ins. Res.	Cond. Loop	Res.	Cond. Loop	Ins. Res.
Switchboards	BD-9, BD-11, BD-14, BD-71, BD-72, SB-5 ()/PT	3000	2000	1000						
Telephone Central Office Sets	TC-2	3000	2000	1000	200	5,000	500 less than limit of distant office ^b	15,000	500 less than limit of distant office ^b	10,000
Telephone Central Office Sets	TC-4, TC-12	3000	2000	1000			300 less than limit of distant office ^b		300 less than limit of distant office ^b	
Telephone Central Office Sets	TC-1	3000	2000	1000	500	10,000	Limit of distant office ^b	30,000	Limit of distant office ^b	10,000
Telephone Central Office Sets	TC-10	3000	2000	1000	500	10,000	Limit of distant office ^b		Limit of distant office ^b	
Telephone Central Office	TC-20									

^a One repeating coil provided at each end of loop for simplex telegraph or phantom circuit use.

^b The limits referred to are the working limits in terms of maximum conductor loop resistance to common battery telephones, of the distant office to which the tactical switchboard is to be connected.

413. TACTICAL TELEPHONE SWITCHBOARDS AND CENTRAL OFFICE SETS - TRANSMISSION LOSSES IN DB AT 1000 CYCLES.

Nomenclature		Average Losses Caused by Equipment in a Switchboard Connection						Added Losses Due to Operator Bridge		
		Mag.Line to Mag.Line	Mag.Line to CB Line	Mag.Line to Trunk	Added for Each Repeat Coil ^a	CB Line to CB Line	CB Line to Trunk	Push to Talk Key Normal	Push to Talk Key Operated	Monitoring Key Operated
Switchboards	HD-9, HD-11, HD-14, HD-71, HD-72, SB-5 ()/PT	0.5			0.7			1.5	3.0	
Telephone Central Office Set	TC-2	0.3	0.3	1.0	0.7	0.3	1.0	1.5	3.0	0.2
Telephone Central Office Sets	TC-4, TC-12	0.5			0.7			1.5	3.0	
Telephone Central Office Set	TC-1	0.2	0.4	1.1	0.7	0.5	1.2	1.0	2.5	0.2
Telephone Central Office Set	TC-10	0.2	0.4	1.6	0.7	0.5	1.7	1.0	2.5	0.2
Telephone Central Office Set	TC-20									

^aRepeat coils provided in magneto loops for simplex telegraph or phantom circuit use.

414. TACTICAL TELEPHONE SWITCHBOARDS AND CENTRAL OFFICE SETS - STOCK NUMBERS AND LOGISTICAL DATA.

Nomenclature		Stock Number	Weight of Largest Pkg.		Total Weight		Total cu.ft. Packed for Export	Ship Tons ^a
			Packed for Export lbs.	In Carrying Cases lbs.	Packed for Export lbs.	In Carrying Cases lbs.		
Switchboard	HD-9	4C9909	35	20	35	20	2	0.1
Switchboard	HD-11	4C9911	56	30	56	30	3	0.1
Switchboard	HD-14	4C9914		185		185	9	0.2
Switchboard	HD-71	4C9971	84	48	84	48	3	0.1
Switchboard	HD-72	4C9972	105	72	105	72	4	0.1
Switchboard	SB-5 ()/PT		-	11-1/2	-	11-1/2	-	--
Telephone Central Office Set	TC-2	4C27002		400	3412	2900	146	3.6
Telephone Central Office Set	TC-4	4C27004	240	200	650	590	2	0.5
Telephone Central Office Set	TC-12	4C27012		225	380	325	12	0.3
Telephone Central Office Set	TC-1	4C27001	887	740	10596	7900	543	13.6
Telephone Central Office Set	TC-5	4C27005			2531		149	3.7
Telephone Central Office Set	TC-10	4C27010	887	740	10596	7900	543	13.6
Telephone Central Office Set	TC-20	4C27020						

^aBased on 40 cu.ft. = 1 ship ton.

Section III
Fixed Plant Telephone Switchboards

415. GENERAL.

a. As stated in Chapter 2, the use of commercial switchboards rather than Army portable switchboards has proven satisfactory. Headquarters have remained at one location long enough and are large enough to justify commercial installations. PBX type switchboards can be used at the smaller outlying headquarters and connected to the larger switchboards which operate as tandem and long distance switchboards for them. Trunk circuit usage thereby is more economical and efficient. The operating advantages are faster services, less maintenance and personnel. Tactical switchboards are thus freed for use where speed of installation and mobility are required.

b. Fixed plant telephone switchboards are commercial types. They are less capable of rough handling in shipment than the tactical switchboards. Carrying cases are not provided. They are furnished through the Army Communications Service on specific order. Both single position and multiple switchboards are included in the list that can be furnished. The particular manufacture furnished will depend upon availability. The single position switchboards listed include some that will serve magneto telephone lines only; some that will serve common battery lines only; some that will serve both kinds of lines; and some that have lines that can be readily converted from magneto to common battery. The multiple switchboards primarily are for common battery lines but can provide for a small number of magneto line terminations. Equipment for dial service is also listed. Spare parts for one year's service are included with each switchboard.

416. SINGLE POSITION SWITCHBOARDS.

a. The single position commercial type switchboards are suitable for small central offices. They should be ordered by their stock number followed by the phrase "and associated equipment" because the stock number shown in the logistical data is for the switchboard position only. In general, these switchboards include or have space on the frame inside them for all the equipment they require, including trunks and tie lines. However, batteries and charging equipment are located elsewhere.

b. The associated equipment which will be furnished with the magneto single position switchboards consists of the following items: main distributing frame, wall type, with five terminal strips - 25 pair, and five protector groups - 20 pair, on fanning strips; 35 feet No. 22 gauge, 101 pair lead covered switchboard cable; and an operator's chair, 17-21 inch; and a wire chief's test cabinet

when specified. Installation equipment and tool equipment will not be furnished with the magneto switchboards. It is assumed that the installer will have available the necessary small tools required for installations of this type. Dry cell batteries for the operator's telephone, the night alarm circuit and the wire chief's test cabinet should be obtained locally.

c. The associated equipment which will be furnished with the common battery single position switchboards consists of the following items: power panel including 20-cycle ringing motor-generator, static converter or vibrator; main distributing frame; 24V. storage battery; electrolyte; operator's chair, 17 to 21 inches; operator's head and chest sets, 1000 feet No. 20 gauge cross-connecting wire; 200 feet No. 14 gauge rubber covered ground wire, two pipe ground rods; 50 feet No. 22 gauge 101 pair lead covered switchboard cable; 50 feet No. 22 gauge 26 pair lead covered switchboard cable; and a Cabinet BE-70-() (wire chief's test set) if required. Installation equipment consisting of nails, screws, nuts, bolts, wire, cable, tape twine, etc. will not be furnished except for isolated installations where in the judgment of the Army Communications Service the installation forces will not have them. This also applies to tool equipment for the installation work on one position switchboards.

417. MULTIPLE SWITCHBOARDS.

a. The commercial type multiple switchboards and associated equipment (batteries, frames, power units, test cabinets, etc.) are of the type which require considerable installation effort for placing them, and for placing and terminating the necessary wires and cables. Both manual and dial equipments are listed. The use and installation of these switchboards is engineered by the Army Communications Service. They are for service in areas comprising several hundred common battery or dial telephones and they also can serve a small number of magneto telephones. The magneto lines have drops in some switchboards and lamp signals in others. Common battery lines in the manual switchboards are the newer types with line lamps associated with the line jacks in the multiple and have no answering jacks. Common battery lines that do not have line relays to control the line lamps, have the line lamps in series with the line. In this case the current flow through the local telephone lights the line lamps when the receiver is taken off the hook and as the lamps on a line are in parallel, the use of several lamps reduces the permissible length of line. Line lamps can be placed or removed in the several appearances in the switchboard, as required to properly distribute the traffic. The switchboards have trunk circuit equipment available to meet most of the conditions

required in the switching center networks. These include ringdown and common battery trunks that terminate on subscriber's lines at the distant office. Suggested floor plans for some of these switching centers are shown, but these may be varied to meet the situations encountered in available space, for operating and terminal rooms. Detailed installing instructions are furnished with each job. They are listed approximately in the order of their capacity in number of lines.

b. Associated equipment consisting of main distributing frames, relay racks, cable racks, and power plant will be furnished unless otherwise ordered. All the multiple switchboards except the Automatic Electric Co. No. 119 type require 115V, single phase, 50-60 cycle power to operate charging and ringing equipment. The 119 type requires 220V, three phase, 50-60 cycle power.

c. The associated equipment that will be furnished consists of the following (which is for a typical 200 line, three position multiple switchboard and is in addition to the switchboard positions): rectifier; face equipment consisting of jacks; lamps; caps; designation strips; short multiple cable; cable separators for the first and second appearance of 200 lines; 500 feet 22 gauge 20 pair switchboard cable; 500 feet 22 gauge 40 pair switchboard cable; power panel equipped with pole changer and associated transformer; trunk relay rack wired and equipped for 20 common battery or dial trunks and 20 magneto trunks, 10 information trunks; cord test; fuse alarm and fuse pilot; line relay rack wired and equipped for 200 common battery lines; common equipment consisting

of a cable turning section and two end sections; 60 feet of cable rack; one lot of installation equipment (nails, screws bolts, nuts, clamps, wire, cable, tape, twine, varnish, solder, beeswax, etc.); one tool equipment (consisting of brace and bits, drills, saws, files, punches, hammers, level, plumb bob, plane, square, chisel, wrenches, scissors, knife, screwdrivers, pliers, torch, furnace, soldering coppers, paraffin, pot, dipper, thermometer, stencil kit, brush, electric soldering iron, etc.); main distributing frame, consisting of three verticals with 606 arrester pairs and terminals for 420 pairs; 6000 feet jumper wire; three pipe ground rods; storage battery; electrolyte; wire chief's test cabinet; operator's chairs, 24-28 inch; spare parts for one year's operation, together with drawings and specifications covering the installation.

d. When ordering additions to existing multiple switchboards, reference should be given in the order to the requisition number of the basic installation.

e. Estimates of time required to install multiple switchboards are as follows:

<u>No. of Positions</u>	<u>Approximate Total Hours of Work</u>	<u>Approximate Shortest Installation Interval - Days</u>
3	500	4
4	750	5
5	1200	6
10	2500	9
15	4000	11
20	6000	13
25	8000	15

418. FIXED PLANT SINGLE POSITION TELEPHONE SWITCHBOARD - EQUIPMENT DATA

Switchboard Code Number	Western Electric Co., Inc.				Kallag Switchboard & Supply Co.				Manufacturer			
	505B(PHX) (Cordless)	505Bc(PHX) (Modified)	505B(PHX) (1-66070)	505B(PHX) (Modified)	OL	45JR	K100(PHX)	150E	Universal	Magneto	Universal	106(PHX)
Shown in Figure Number	414	415	416	417	418	419	420	421	-	422	-	425
Type of Local Lines Served Suitable for Use as	CB PHX	CB PHX	CB & Mag. PHX	CB PHX	CB & Mag. Small Central Office	CB & Mag. Small Central Office	CB PHX	Mag. Small Central Office	CB & Mag. Small Central Office	Mag. Small Central Office	CB & Mag. Small Central Office	CB PHX
No. Magneto Local Lines	-	-	20 drop signals ^a	-	-	20 lamp signals ^a	-	100 drop signals ^a	-	100 drop signals ^a	-	-
No. Common Battery Local Lines with lamp signals	12 with magnetic signals	60 with line relays	20 with line relays 20 without line relays	100 with line relays	-	40	100 with line relays	-	-	-	-	100 with line relays
No. Convertible Lines, CB to Mag., with lamp signals	-	-	-	100 ^b Line relays on all lines	-	40 ^b with line relays	-	-	100 ^b Line relays on all lines	-	100 ^b Line relays on all lines	-
Total Capacity, Lines	12	80	60	100	100	100	100	100	100	100	100	100
No. Trunks Common Battery Manual or Dial, with lamp signals, terminating on subscriber's line circuits at distant central office ^b	5 drop signal	15	3	15	10	10	10	-	10	-	10	10
Trunks of other types available	Two-way ringdown Two-way automatic	Two-way ringdown Two-way automatic	Two-way ringdown Two-way automatic	Two-way ringdown Two-way automatic	-	-	-	-	-	-	-	Two-way ringdown Two-way automatic
No. Cord Circuits with lamp supervisory signals in both front and back cords, except as noted	5 One-Magnetic signal thru batt'y feed on trk.conn.	15 ^c thru batt'y feed on trunk conn.	10 ^c thru batt'y feed on trunk conn.	15 ^c thru batt'y feed on trunk conn. (Universal)	15 ^c repeating coil batt'y feed on trunk conn. (Universal)	15 ^c repeating coil batt'y feed on trunk conn. (Universal)	15 ^c thru batt'y feed on trunk conn.	15 ^c drop signal non-ring thru magneto	15 ^c repeating coil batt'y feed thru (Universal)	15 ^c Two-Magnetic signal non-ring thru magneto	15 ^c repeating coil batt'y feed thru (Universal)	15 ^c subscriber's bridged impedance series condenser
Style Operators Set	Desk stand or hand set	Head and chest set	Head and chest set	Head and chest set	Head and chest set	Head and chest set	Head and chest set	Head and chest set	Head and chest set	Head and chest set	Head and chest set	Head rec. bracket trans.
Main Battery Voltage (11 Cells)	24	24	24	24	24	24	24	24	24	24	24	24
Master Ringing Key for Party Lines	-	-	-	-	Yes	-	-	-	Yes	-	Yes	-
Dial Arrangement	In operator's Circuit	In operator's Circuit	In operator's Circuit	In operator's Dial Cord	In operator's Circuit	In operator's Circuit	In operator's Circuit	In operator's Circuit	Dial cord	Not used	Dial cord	In operator's Circuit
Weight of Switchboard Position Pounds	135	500	500	500	487	500	500	500	550	315	525	500

^a Can use magneto lines as two-way ringdown trunks.
^b For a trunk between two common battery switchboards such as those listed here, a common battery local line can be used at one end and a common battery trunk termination at the other, if the trunk loop resistance permits.
^c Wired for one two-way, ringdown trunk which if used necessitates circuit changes in switchboard.
^d Not furnished except if ordered as additional equipment.
^e Ringing on both front and back cords.
^f Ringing on both front and back cords; locked in rering on magneto lines and two-way ringdown trunks.

FIGURE 414. No. 506B Switchboard
(Western Electric Co.)

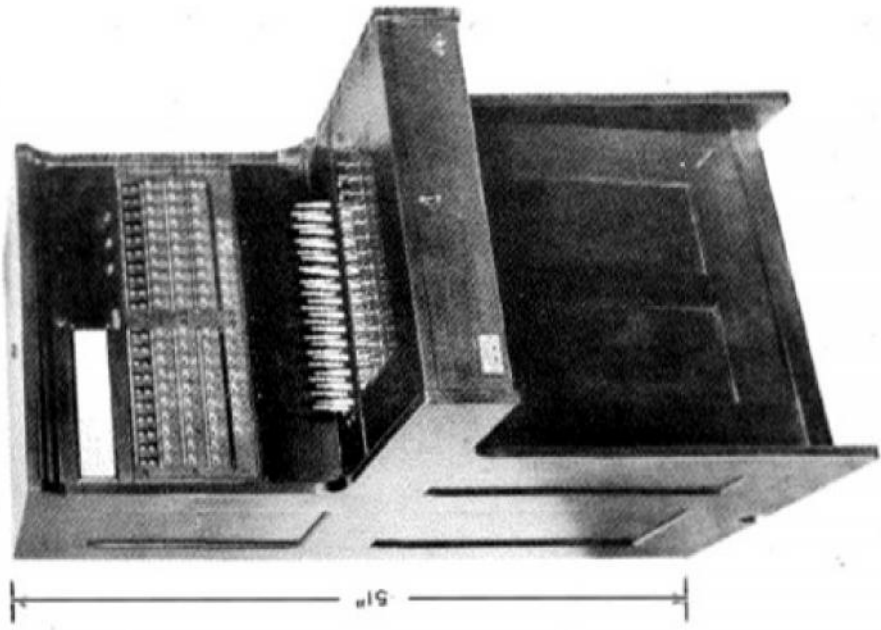
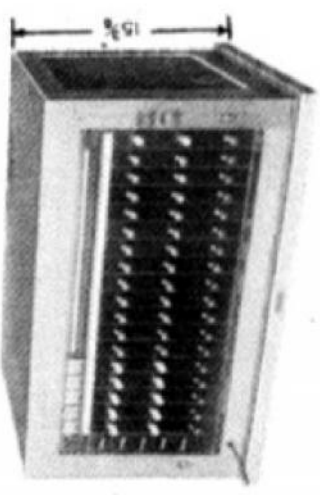

FIGURE 415. No. 550SC Switchboard
(Modified)
(Western Electric Co.)

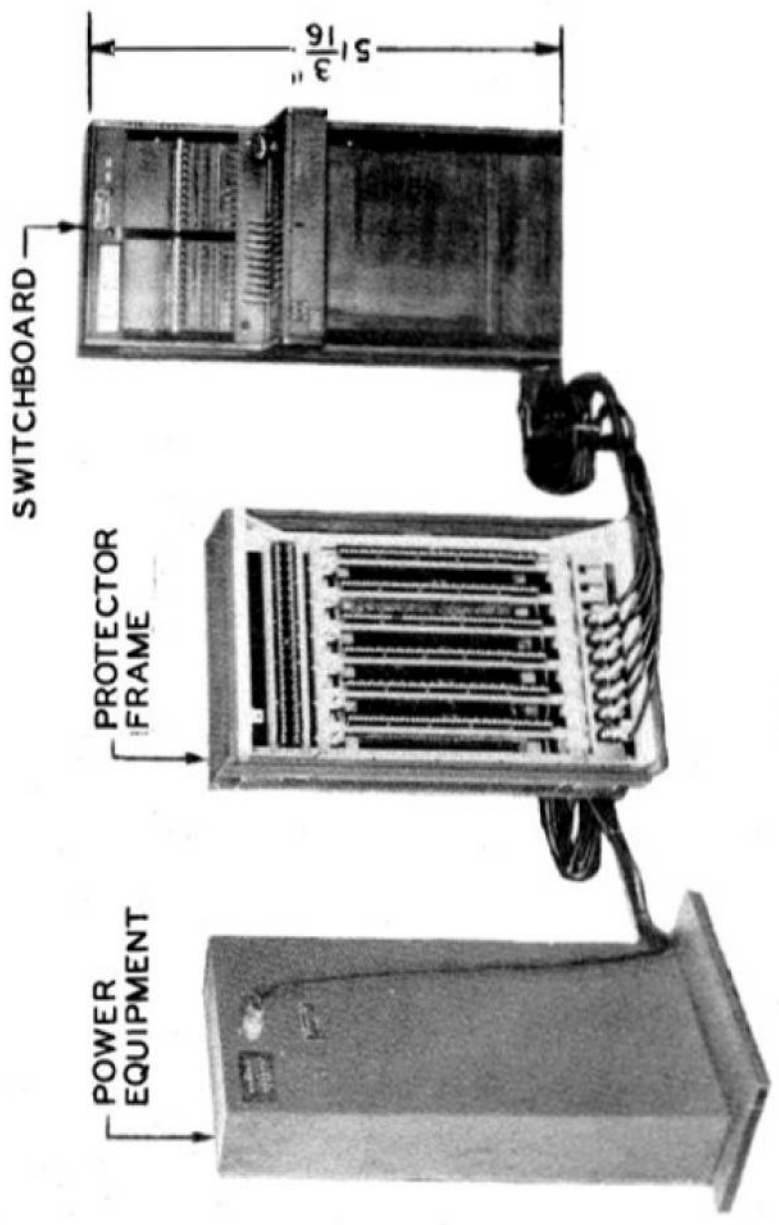

FIGURE 416. No. 551B (Special Per X-66070) Switchboard
(Western Electric Co.)

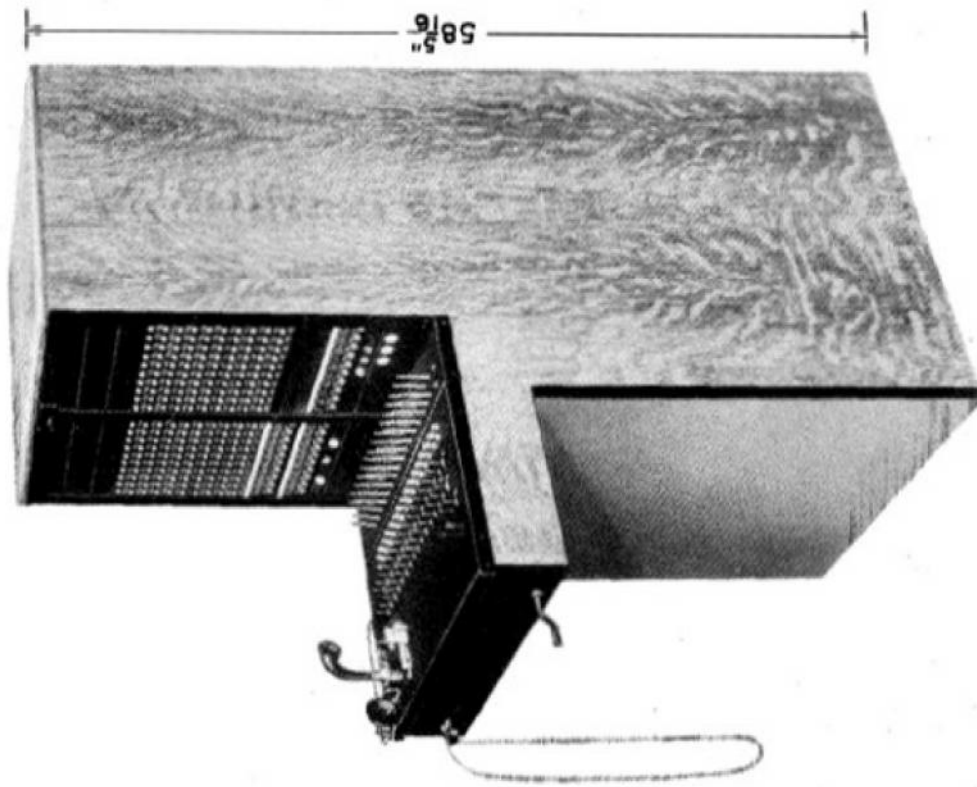

FIGURE 419. No. 45JR Switchboard
(Kellogg Switchboard & Supply Co.)

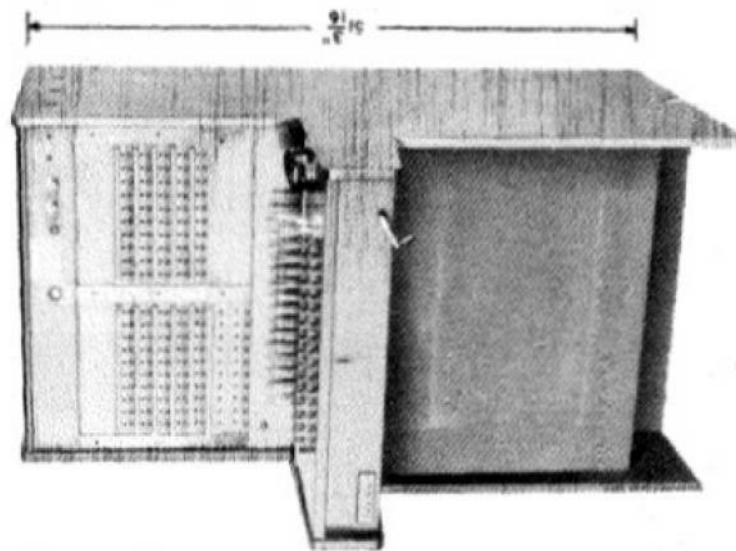

FIGURE 418. G1 Switchboard
(Western Electric Co.)

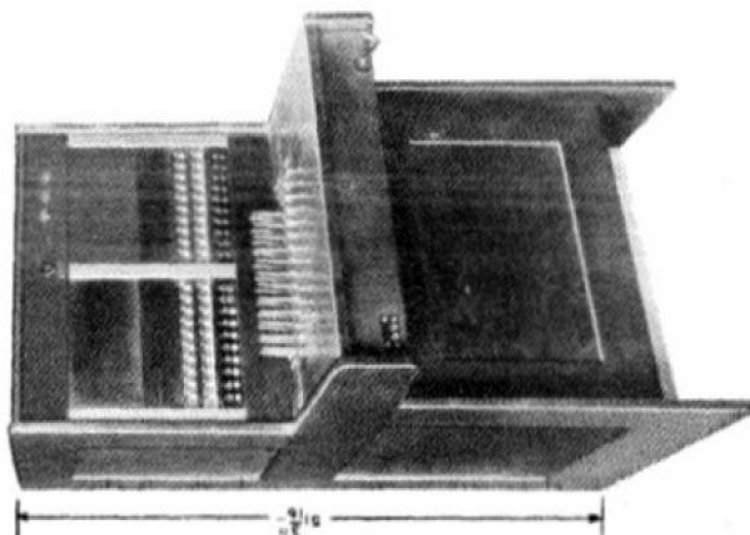

FIGURE 417. No. 551B Switchboard
(Modified)
(Western Electric Co.)

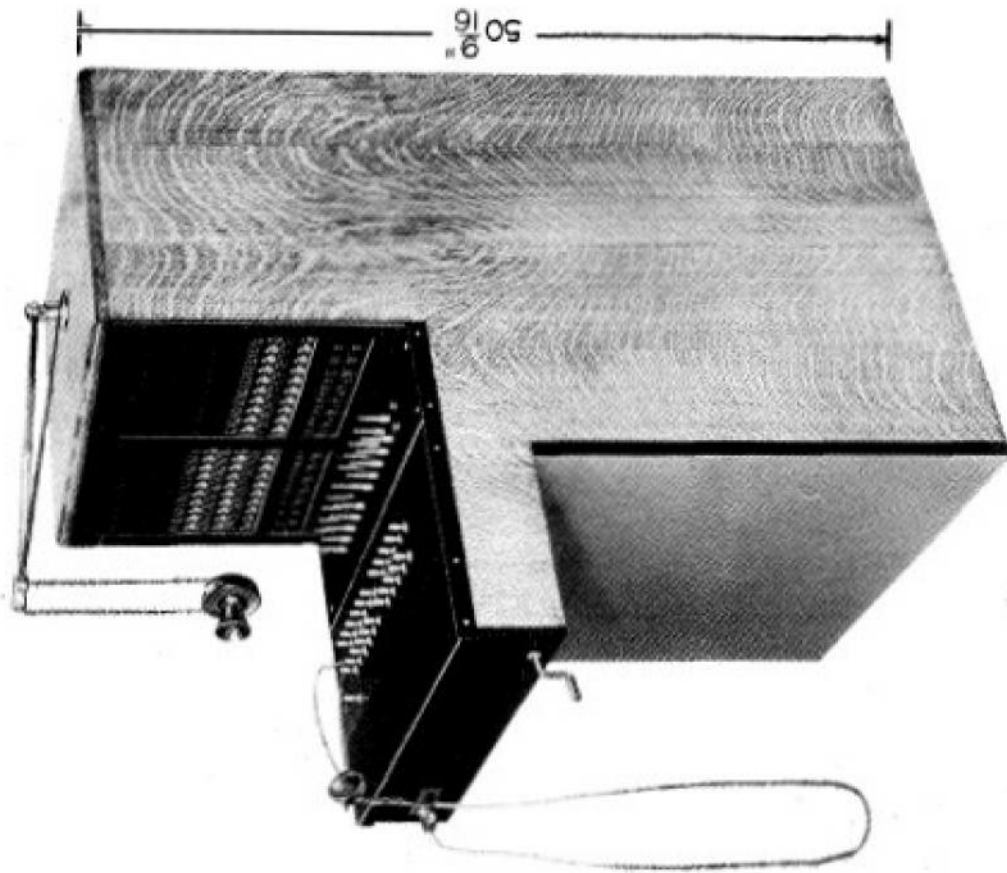

FIGURE 421. No. 150E Switchboard
(Kellogg Switchboard & Supply Co.)

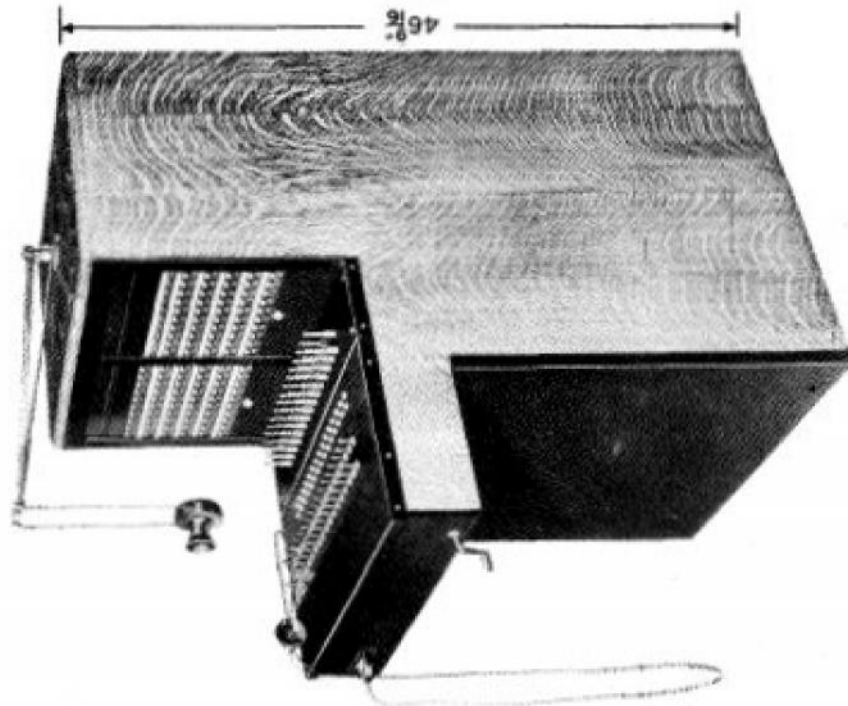

FIGURE 420. K100 Switchboard
(Kellogg Switchboard & Supply Co.)

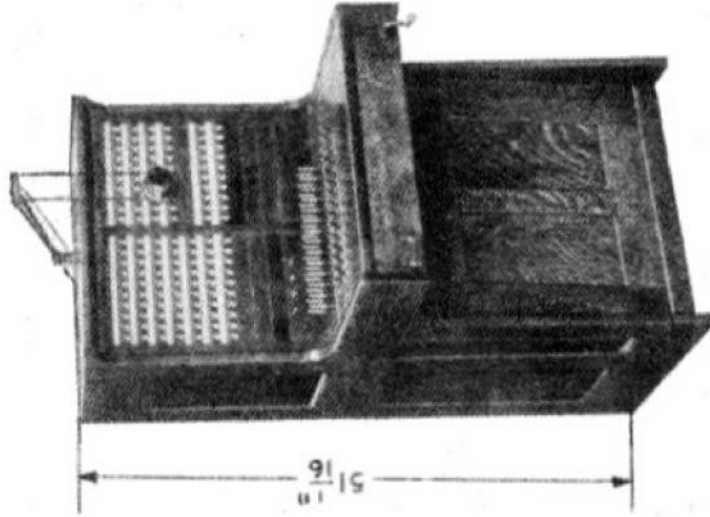

FIGURE 423. No. 106 Switchboard
(Stromberg Carlson Co.)

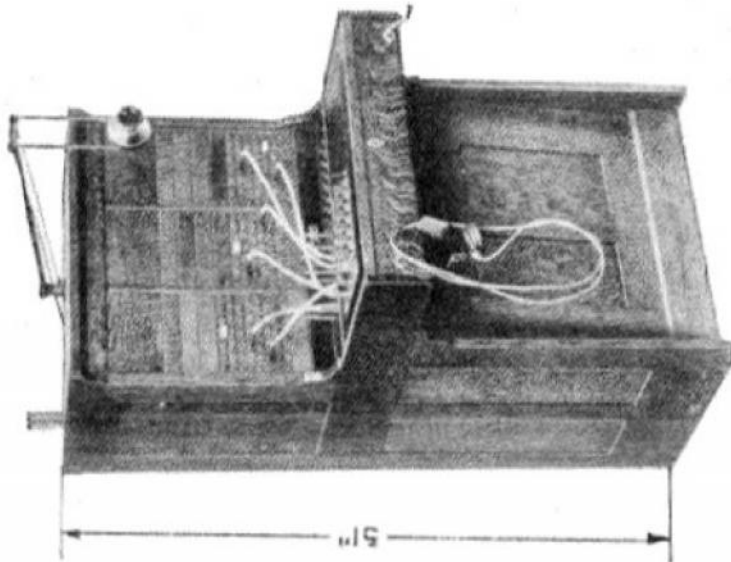

FIGURE 422. Magneto Switchboard
(Stromberg Carlson Co.)

419. FIXED PLANT SINGLE POSITION TELEPHONE SWITCHBOARDS - DESCRIPTION.

a. Switchboard 506B. This is a single position common battery turret of the cordless type. All connections are set up by key operation. Five calls simultaneously are maximum possible. The circuits are arranged for common battery local manual service. The trunks are for termination on subscriber's lines in manual or dial common battery central offices and are ringdown incoming and automatic outgoing. One two-way ringdown trunk can be provided. It is not designed to connect one trunk to another trunk for thru switching purposes. More than one line can be connected to a trunk for a conference connection. When the PHX is unattended a thru connection to the central office (manual or dial) may be left set up for any of the station lines. Magnetic signals are used on lines and trunks. Four conductor deskstand with head or hand receiver or handset used by operator must be ordered separately. Talking battery comes from central office to stations when connected to trunks. This limits the length of local telephone lines because the trunk conductor resistance is part of the station loop on trunk connections. One signal supervision is given on trunk connections. Local to local calls get battery through coils in the switchboard. Either the operator or the local telephone user may dial over the trunk when connected thereto. No distributing frames provided. Lines and trunks terminate on screw terminal connecting blocks in switchboard. Hand generator is included for emergency ringing power. Furnished in light oak or mahogany walnut finishes. All parts are readily accessible due to hinged cover and removable front.

b. Switchboard 550SC (Modified). The modification from the standard 550SC (PHX) switchboard is that line relays are provided on all lines instead of only twenty of them. It is a two panel single position manual common battery switchboard with single retard coil battery feed cord circuits which provide talking battery on local to local connections. Ringing is provided on both front and back cords. Lines and trunks have lamp signals. The dial is connected to the operator's circuit which avoids need of separate dial cord and dial jacks. Either the operator or the local telephone user may dial over the trunk when connected thereto. The trunks to manual and dial common battery central offices are for termination there on subscriber's lines. One lamp supervision is given on connections between a local telephone line and a trunk, on the lamp associated with the cord which is connected to the local line. Talking battery for the local telephone line when connected to a trunk is supplied over the trunk from the distant office. This limits the permissible length of local telephone lines

because the trunk conductor resistance is part of the station loop on trunk connections. It is not designed to permit connecting one trunk to another trunk for switching purposes. The trunks to manual or dial common battery central offices are ringdown incoming and automatic outgoing. The framework is designed with a compact hinged gate upon which the equipment for the position circuits is mounted, in the rear of the switchboard. If two-way ringdown or two-way automatic trunks are ordered as extra equipment their apparatus must be mounted externally. When the switchboard is unattended a thru connection to the central office may be left up for any of the station lines. Made in mahogany-walnut or light oak finish. Two switchboards can be used side by side if mounted on a platform and fitted with six foot cords, and a grouping key is installed in one of the switchboards. Includes a hand generator for emergency ringing supply.

c. Switchboard 551B (X-66070A). This is the 551B (PHX) switchboard, in which special circuits for magneto lines and for central office trunks have been provided. It is a two panel single position manual common battery switchboard. Single retard coil battery feed cord circuits provide battery on local to local calls and on magneto office to local calls. Ringing is provided on both front and back cords. The common battery lines have lamp signals. Half have line relays. Magneto lines terminate on a circuit such that the line drop operates to give locked in ringoff and rering signals. Ringing on magneto lines is by key on each line in face of switchboard. Magneto lines are used as two-way ringdown trunk terminations. Includes a hand generator ringing supply. Dial is in operator's circuit. Either the operator or the local telephone user may dial over a trunk when connected thereto. On local to trunk connections talking battery to the station is supplied locally by the specially arranged trunk equipment. This increases the length of local telephone line over what is permissible if local telephone line talking battery comes from the distant office over the trunk. It is not designed to connect one trunk to another trunk for thru switching purposes. The trunks are for termination on subscribers' lines in manual or dial common battery central offices and are ringdown incoming and automatic outgoing. Supervision on connections between a local telephone line and a trunk is limited to one lamp which is the one controlled by the cord in the local line. All of the equipment for the circuits of the switchboard is contained within the switchboard. If two-way ringdown or two-way automatic trunks are ordered as extra equipment their apparatus must be mounted externally. The finish is mahogany-walnut. X-66070D is same as X-66070A except it has platform and long cords for operating

two switchboards side by side; and has 5 interposition automatic trunks. Includes separate protector frames, charging equipment, battery and 20-cycle ringing for each switchboard. Connections between switchboard and distributing frame made with flexible rubber covered cable. A heater is provided in rear of the switchboard, consisting of 60 watt resistances and power supply cables. Carrying cases provided. Covered in TM 11-2002.

d. Switchboard 551B (Modified). This is the 551B (PBX) switchboard modified by providing line relays on all lines instead of only twenty of them. It is a two panel single position manual common battery switchboard. The operating features are the same as stated for the 550SC switchboard in paragraph b. The difference is in appearance and capacity. They use the same cords, plugs and jacks. The circuits are similar but the 551B uses relays of different types than the 550SC in general, which results in the working limits not being the same in both. If required, one of each can be used side by side on a platform if provided with six foot cords. A grouping key to connect the two operators circuits can be added.

e. Switchboard G1. This is a two-panel single position common battery manual switchboard suitable for use as a small central office. The framework is made of plywood, reinforced to withstand rough handling. Its cord circuits are "Universal" type (i.e. can connect magneto lines to common battery lines). The front and back cord lamps act as locked in ringoff or rering signals when connected to magneto lines or two-way ringdown trunks. The cord circuits provide talking battery to the local telephone lines on all calls. Ringing is provided on both front and back cords, with a master key for party line ringing. Dial is on separate cord. A local telephone user cannot dial over a trunk when connected thereto. A grouping key is provided which will permit two switchboards to be used side by side if placed on a platform and provided with six foot cords. The cord circuits are such that thru switching connections can be set up between two two-way ringdown trunks. Trunks are provided for termination on subscribers lines in manual or dial common battery central offices and are ringdown incoming and automatic outgoing. Two lamp supervision is given on: local to local calls; local to magneto trunk; and magneto trunk to magneto trunk. One lamp supervision on local to manual or dial common battery office trunks. Local telephone line circuits are such that by a simple wiring change any line may be converted from magneto to common battery or vice versa. All lines have lamp signals. Magneto lines can be used for

two-way ringdown trunk terminations. A hand generator is provided for emergency ringing supply.

f. Switchboard 45JR. This is a two panel single position common battery manual switchboard suitable as a small central office. Its cord circuits are repeating coil battery feed "Universal" type (i.e. can connect magneto lines to common battery lines). The cord circuits provide talking battery to the local telephone lines on all calls. Ringing is provided on both front and back cords. The dial is in the operator's circuit. A local telephone user cannot dial over a trunk when connected thereto. Trunks are provided for termination on subscribers' lines in manual or dial common battery central offices and are ringdown incoming and automatic outgoing. Magneto lines can be used as two-way ringdown trunk terminations. Calls can be switched for thru connections from a two-way ringdown trunk to another of the same kind. A hand generator is provided for emergency ringing supply.

g. Switchboard K100. This is a two panel single position common battery PBX type switchboard. Its cord circuits are bridged impedance, series condenser battery feed type which provide talking battery on local to local calls. Talking battery comes from the common battery central office to the local telephone line when the latter is connected to a central office trunk. This permits thru supervision to the main exchange and makes the trunk available at central office for other calls as soon as the local telephone line user hangs up. When connected to a dial central office either the operator or the local telephone user may dial over the trunk. The trunks are for termination on subscribers' lines in manual or dial common battery central offices and are ringdown incoming and automatic outgoing. The addition of two relays and a dial is required with dial office trunks. It is not designed for connecting one trunk to another trunk for thru switching purposes. The station lines and trunks terminate on a connecting strip in the rear of the switchboard and both operate lamp signals. A hand generator is provided for emergency ringing supply.

h. Switchboard 150E. This is a two panel single position magneto switchboard. Lines use drop signals. The cord circuits are non-ring thru repeating coil type with a ringoff or rering drop in both front and back cords, with ringing on both front and back cords. Grounded and metallic lines can be interconnected. Calls can be switched for thru connections from a two-way ringdown trunk to another of the same kind. Magneto lines are used as two-way ringdown trunk terminations. A distributing frame is not provided as the line equipments terminate in a 12 foot cable. A hand generator is provided for emergency ringing supply. Power for the operator's

telephone and night alarm is supplied by dry cells.

i. Switchboard - Kellogg "Universal". This is a two-panel single position common battery switchboard suitable as a small central office. In general design and operating features it is the same as switchboard G1 described in paragraph e, except that it has a steel framework.

j. Switchboard - Stromberg-Carlson Magneto. This is a three-panel single position magneto switchboard. Magneto lines use drop signals. The cord circuits are non-ring thru repeating coil type with a ringoff or rering magnetic signal in both front and back cords. Calls can be switched for thru connections from a two-way ringdown trunk to another of the same kind. Magneto lines are used as two-way ringdown trunk terminations. A distributing frame and power equipment are provided unless otherwise ordered. A hand generator is included for emergency ringing supply. Power for the operator's telephone and night alarm is supplied by dry cells.

k. Switchboard - Stromberg-Carlson "Universal". This is a two-panel single position common battery switchboard suitable as a small central office. In general design and operating features it is the same as switchboard G1 described in paragraph e.

l. Switchboard 106. This is a two-panel single position common battery PBX type switchboard. It is not designed

to connect one trunk to another for thru switching purposes. Lines and trunks have lamp signals. Cord circuits are single retard coil battery supply feed which provide talking battery on local to local connections. Ringing is provided on both front and back cords. The dial is connected to the operator's circuit which avoids need of separate dial cord and dial jacks. Either the operator or the local telephone user may dial over the trunk when connected thereto. The trunks to manual or dial common battery central offices are for termination there on subscribers line circuits. These are ringdown incoming and automatic outgoing. One lamp supervision is given on connections between a local telephone line and a trunk, on the lamp associated with the cord which is connected to the local line. Talking battery for the local telephone line when connected to a trunk is supplied over the trunk from the distant office. This limits the permissible length of local telephone lines because the trunk conductor resistance is part of the station loop on trunk connections. When the switchboard is unattended a thru connection to the central office may be left up for any of the station lines. Two switchboards may be operated side by side if mounted on a platform and provided with six-foot cords and a grouping key is installed in one of them. Includes a hand generator for emergency ringing supply.

420. FIXED PLANT SINGLE POSITION TELEPHONE SWITCHBOARDS - WORKING LIMITS IN OHMS

Nomenclature Manufacturer Type No.		To Magneto Telephone EE-8-() (In L.B. position)			To Common Battery Telephone TP-8			Trunks to Common Battery Office	
		Max. Cond. Loop			Max. Cond. Loop ^c			Max. Cond. Loop	Min. Ins. Resis.
		No Repeat Coils	With Repeat Coils ^a	Min. Ins. Resis.	Without Line Relay	With Line Relay	Min. Ins. Resis.		
W.E.Co.	506B Cordless PBX				500		20000 20000 ^c	d	20000
W.E.Co.	550SC PBX (Modified)					155	20000 17500 ^c	d	20000
W.E.Co.	551B (X-66070)	3000	2000	1000	300	385	7500 (man.) 30000 (dial) 17500 ^c	Limit of distant office	Limit of distant office
W.E.Co.	551B PBX (Modified)					155	20000 17500 ^c	d	20000
W.E.Co.	G1	3000	2000	1000		1400	5000	70 less than limit of distant office	Limit of distant office
Kellogg	45JR	1500		10000		500	10000	Limit of distant office	Limit of distant office
Kellogg	K100 PBX				50	475	10000	d	10000
Kellogg	150E								
Kellogg	Universal					750	10000	750	10000
Stromberg- Carlson	Magneto								
Stromberg- Carlson	Universal					1200		Limit of distant office	Limit of distant office
Stromberg- Carlson	106 PBX					125		d	

^aOne repeating coil at each end of loop for simplex telegraph or phantom circuit use.

^bThe working limits for the common battery switchboards listed are based on the assumption that 24-volt storage batteries are located at the switchboard.

^cInsulation resistance of all lines (without line relays) should exceed the figure given, for proper operation of the auxiliary signal.

^dThe maximum trunk conductor loop resistance to most American types of central offices may be considered approximately equal to the maximum conductor loop resistance of such offices allowable for common battery telephones connected to them, minus twice the conductor loop resistance of the longest local to which trunk service is to be given except for the 506B switchboard where the station loop plus the trunk loop can equal the distant office limit.

421. FIXED PLANT, SINGLE POSITION TELEPHONE SWITCHBOARDS - TRANSMISSION LOSSES IN DB AT 1000 CYCLES

Manufacturer	Type No.	Average Losses Caused by Equipment in a Switchboard Connection					Added Losses Due to		
		Mag. Line to Mag. Line	Mag. Line to CB Line	Mag. Line to Trunk	CB Line to Trunk	CB Line to Tie Trunk	Operator Talk-	Bridge Monitor-	
		Mag. Line	CB Line	Trunk	Trunk	Trunk	ing	ing	
Western Elec.	506B PBX				0.2	0.3		3.0	
Western Elec.	550SC PBX (Modified)				0.8	0.5	1.0	1.5	
Western Elec.	551B PBX (X-66070)	0.8	0.8	1.1	0.8	1.1	1.2	1.5	
Western Elec.	551B PBX (Modified)	0.8	0.8	0.5	0.8	0.5	1.0	1.5	
Western Elec.	G1	0.6	0.6	0.7	0.6	0.7		2.0	0.2
Kellogg	455R		0.6		0.7	0.7		2.3	0.2
Kellogg	K100 PBX				1.2	1.2		2.3	
Kellogg	150E				0.7			2.3	
Kellogg	Universal	0.7	0.6	0.6	0.7	0.7		2.3	0.2
Stromberg-Carlson	Magneto	0.7						3.5	
Stromberg-Carlson	Universal	0.9		0.7	0.7	0.7		3.5	
Stromberg-Carlson	106 PBX				0.8	0.5		3.5	

422. FIXED PLANT, SINGLE POSITION, TELEPHONE SWITCHBOARDS AND ASSOCIATED EQUIPMENT - STOCK NUMBERS AND LOGISTICAL DATA

Nomenclature		Stock Number ^a	Weight Largest Package Packed	Total Weight Packed	Total Cu. Ft. Packed	Ship Tons ^c
Manufacturer	Type No.		for Export lbs ^b	for Export lbs ^b	for Export	
Western Elec.	506B PBX	4C19325				
Western Elec.	550SC PBX (Modified)	4C19080-4	700	3100	117	2.9
Western Elec.	551B PBX (X-66070)		825	1525	89	2.2
Western Elec.	551B PBX (Modified)	4C19200	700	3100	117	2.9
Western Elec.	G1	4C12100-7	700	3100	117	2.9
Kellogg	45JR	4C20100	700	3100	117	2.9
Kellogg	K100 PBX	4C18100-1	700	3100	117	2.9
Kellogg	150E	4C23100	700	3100	117	2.9
Kellogg	Universal	4C20100-1	700	3100	117	2.9
Stromberg-Carlson	Magneto					
Stromberg-Carlson	Universal	4C18100-5				
Stromberg-Carlson	106 PBX	4C18100-2				

^aStock number is for the switchboard only - does not include associated equipment. An order for a complete installation should have the phrase "and associated equipment" follow the stock number of the switchboard.

^bWeights and cubic contents of switchboards and associated equipment are estimated.

^cBased on 40 cu. ft. = 1 ship ton.

423. FIXED PLANT MULTIPLE TELEPHONE SWITCHBOARDS - EQUIPMENT DATA

Switchboard Code	Manufacturer				No.	Capacity	Type	Suitable for Use as	Capacity	Type	Suitable for Use as	Capacity	Type
	North Electric Manufacturing Co.	Kellogg Switchboard and Supply Co.	Automatic Electric Co.	Western Electric Co., Inc.									
1000	No. 1000	No. 6-800	No. 119	No. 12	No. 600A	No. 10	No. 1600	No. 12-1600	No. 119	No. 18	No. 2800	No. 11	Western Electric Co., Inc.
424	424	425	426	427	428	431	432	433	434	435	436	437	
Dial	Manual	Dial	Manual	Manual	Manual	Manual	Manual	Manual	Manual	Manual	Manual	Manual	Manual
Fixed dial office	Fixed local or local and long distance center	Fixed dial office	Fixed local center or FBI	Fixed local center	Fixed local center	Fixed local center	Fixed local center	Fixed local center	Fixed local center	Fixed local center	Fixed local center	Fixed local center	Fixed local center
400 basic plus one or two 100 line units or 400 basic without addition	800 Line and cutoff relays on all lines. Convertible to mag-neto	1400 600 basic plus one or two 400 line units	1400 Line re-lays avail. but number that can be used is limited	1520 Line re-lays avail. but number that can be used is limited	1600 Line and cutoff relays on all lines	1600 300 (min) Line and cutoff relays on all lines	1600 40 common battery	1600 40 common battery	2000 1200 basic plus one or two 400 line units	2800 Line and cutoff relays on all lines	2800 Line and cutoff relays on all lines	3000 Line and cutoff relays on all lines	3000 Line and cutoff relays on all lines
See Note a	See Note a	See Note a	See Note a	See Note a	See Note a	See Note a	See Note a	See Note a	See Note a	See Note a	See Note a	See Note a	See Note a
Dial eq. has 20 common battery 30 two-way automatic. Each att. for. 10 in-formation 20 mag. lines 20 min. lines	40 common battery 40 two-way ringdown automatic.	20 two-way central office 50 two-way ringdown for levels operator level. 50 out dial to regular connectors (increase 20 for each above 600) 60 common battery lines 30 two-way automatic	As req'd. Space for 240 (max.) two-way ringdown with lamp signals. Busy lamps can be provided on toll lines	As req'd. Space for 240 (max.) manual or central office and auto-matic or two-way ringdown to other FBI type switch-boards	80 common battery and 80 two-way ringdown (maximum) 10 infor-mation (maximum)	40 common battery 40 two-way ringdown 10 infor-mation (maximum)	40 common battery 40 two-way ringdown 10 infor-mation (maximum)	40 common battery 40 two-way ringdown 10 infor-mation (maximum)	Same as 600 basic unit plus 60 additional out dial to regular connector 20 out dial to FXE con-nectors 10 out dial to operators selectors 10 out dial to line equipment	60 common battery and 120 two-way ringdown (maximum)	80 common battery 80 two-way ringdown 10 infor-mation 10 inter-position	40 common battery 40 two-way ringdown Space for 360 above type trunks (maximum)	40 common battery 40 two-way ringdown Space for 360 above type trunks (maximum)
2	2	3	3	4	2	2	2	2	3	3	3	3	3
4	4	3	4	4	4	4	4	4	3	7	7	6	6
1	1	1	1	1	1	1	1	1	1	1	1	1	1
Non-salt.	Bridged	Bridged	Series cutoff	Series cutoff	Bridged	Bridged	Bridged	Bridged	Bridged	Bridged	Bridged	Bridged	Bridged

FIXED PLANT MULTIPLE TELEPHONE SWITCHBOARDS - EQUIPMENT DATA. (Continued)

Switchboard Code	Manufacturer										
	North Electric Manufacturing Co.	Kellogg Switchboard and Supply Co.	Automatic Electric Co.	Western Electric Co.	Western Electric Co.	Stromberg-Carlson Co.	Kellogg Switchboard and Supply Co.	Automatic Electric Co.	Stromberg-Carlson Co.	Kellogg Switchboard and Supply Co.	Western Electric Co.
No. 1000	No. 6-800	No. 119	No. 12	No. 605A	No. 15	No. 1500	No. 12-1600	No. 119	No. 18	No. 2000	No. 11
Yes	Yes	No	No	Yes	Yes	Yes	Yes	No	Yes	Yes	Yes
No	No	No	No	Yes	No	Yes	No	No	Yes	Yes	No
5	5	-	1	4	5	5	5	-	5	5	5
No. of Cord Circuits per pos.	15	15	15	15	15	15	15	15	15	17	17
Type of Cord Circuits	Subscriber's Bridged impedance, series condenser	Subscriber's Bridged impedance, series condenser	Subscriber's Bridged impedance, series condenser	Subscriber's Bridged impedance, series condenser	Subscriber's Bridged impedance, series condenser	Subscriber's Bridged impedance, series condenser	Subscriber's Bridged impedance, series condenser	Subscriber's Bridged impedance, series condenser	Subscriber's Bridged impedance, series condenser	Subscriber's Bridged impedance, series condenser	Subscriber's Bridged impedance, series condenser
Cord Circuit	Locked-in	Locked-in	Locked-in on third lamp	Locked-in	Locked-in	Locked-in	Locked-in	Locked-in	Locked-in	Locked-in	Locked-in
Dial Arrangement	Dial in operator's circuit	Dial in operator's circuit	Dial in operator's circuit	Dial in operator's circuit	Dial Cord	Dial Cord	Dial Cord	Dial in operator's circuit	Dial Cord	Dial Cord	Dial in operator's circuit
Emergency Hand Generator	None	None	In each position	Both	In Position 1 only	In head section only	None	None	In Position 1 only	In head section only	None
Ringling on Both Cords or Front Cords only	Both	Both	Both	Both	Both	Front	Front	Both	Both	Front	Front
Generator Reversing Key for Party Lines	No	No	In each position	No	No	No	No	No	No	No	No
Main Battery Voltage	48 (24 cells)	46-52 (23 cells plus 3 end cells)	48 (23 cells)	48 (23 cells)	22-30 (12 cells)	24 (11 cells)	24 (11 cells)	46-52 (23 cells plus 3 end cells)	20-28 (11 cells)	24 (11 cells)	24 (11 cells)
Type Distrib. Frame and Relay Racks	Floor	Floor	Floor	Floor or enclosed	Floor	Floor	Floor	Floor	Floor	Floor	Floor

^aTwo-way ringdown trunks can be used for magneto line terminations.
^bThe common battery trunks are for termination on subscriber's lines at the distant manual or dial common battery office and are ringdown incoming and automatic outgoing. All trunks have lamp signals for incoming calls.
^cReduces capacity to 600 lines.

^dReduces capacity to 1200 lines.
^eOn lines with line relays these control the line lamps. The other lines have the lamps in service with the lines. Lamps can be placed or removed at the apparatuses to adjust loads on positions.
^fHas reversing key to permit ringing bells on lines with ground condition on ring side of line.

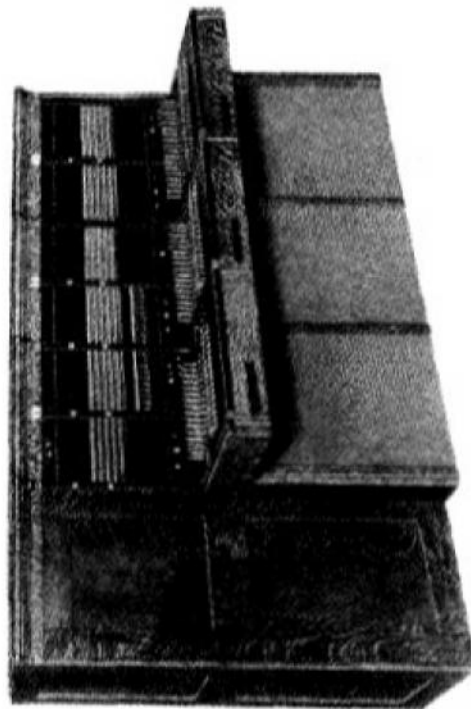

FIGURE 425. No. 6-800 Switchboard
(Kellogg Switchboard & Supply Co.)

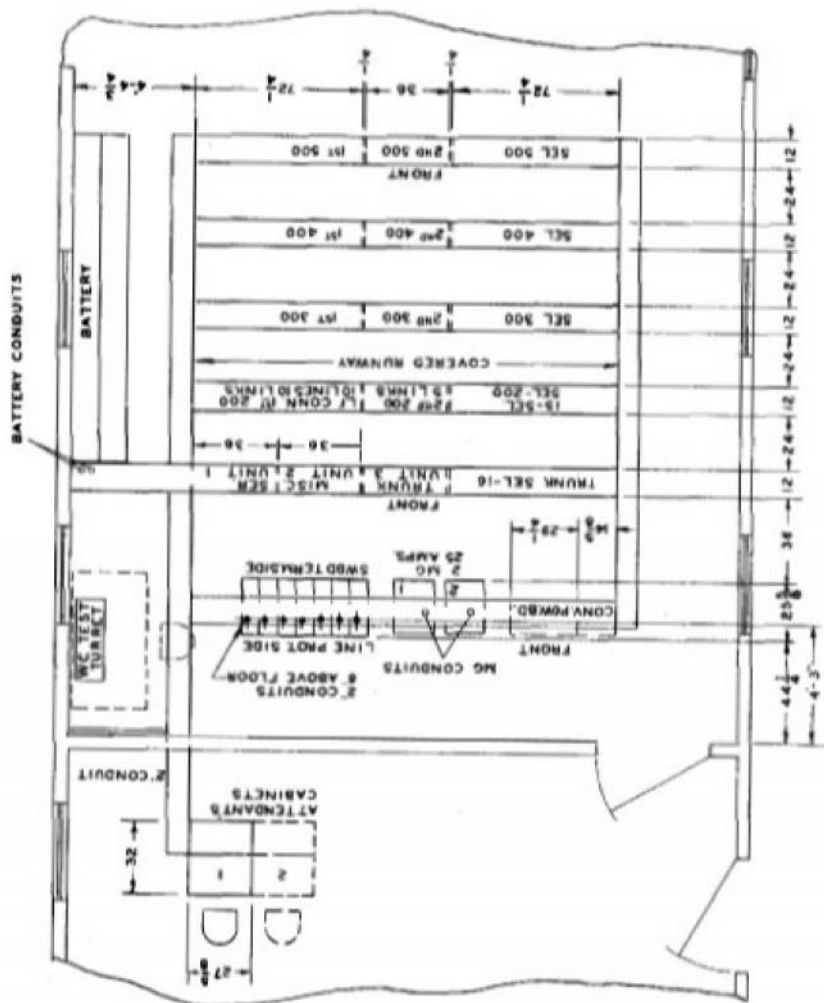

FIGURE 424. No. 1000 Switchboard - Floor Plan
(North Electric Manufacturing Co.)

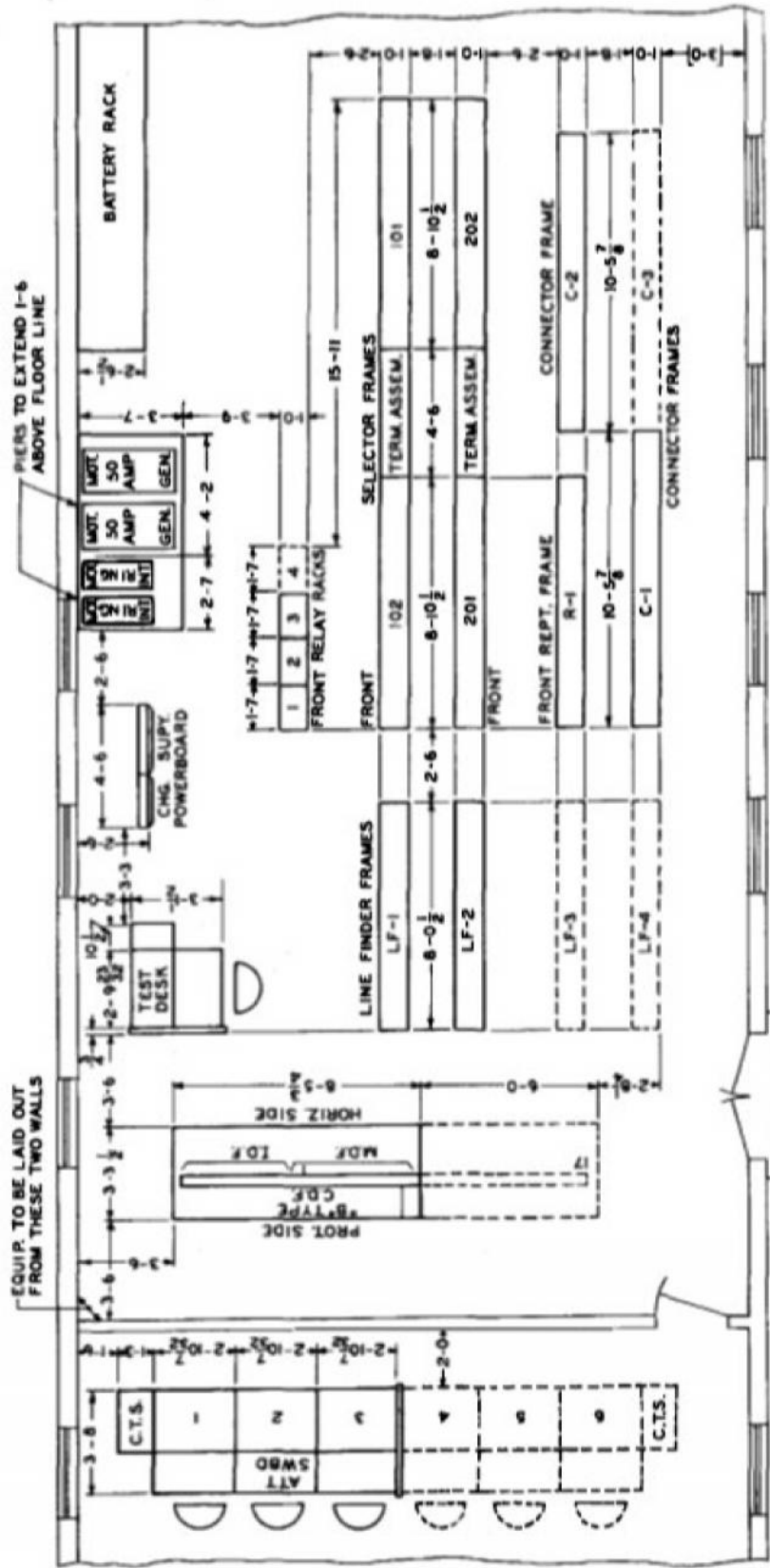
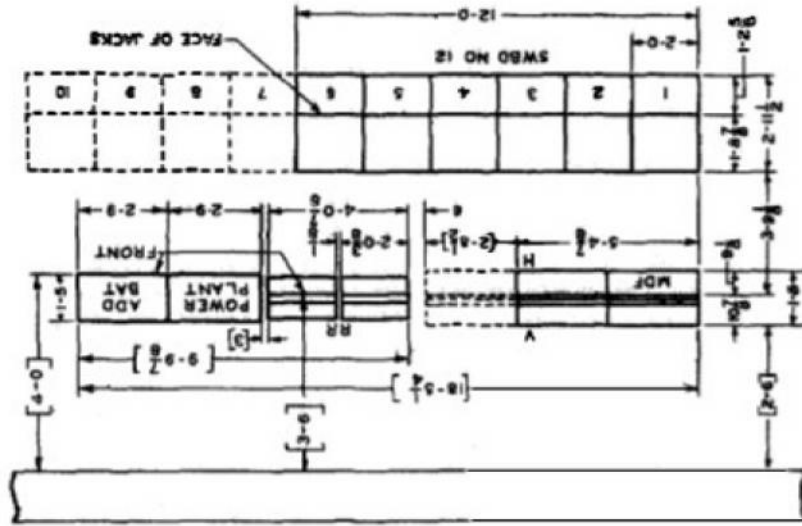

FIGURE 426. No. 119 Switchboard - Floor Plan
(Automatic Electric Co.)



1. Dimensions shown in brackets [] are approximate. All others are fixed.
2. For minimum clearances refer to floor plan data sheet for particular equipment.

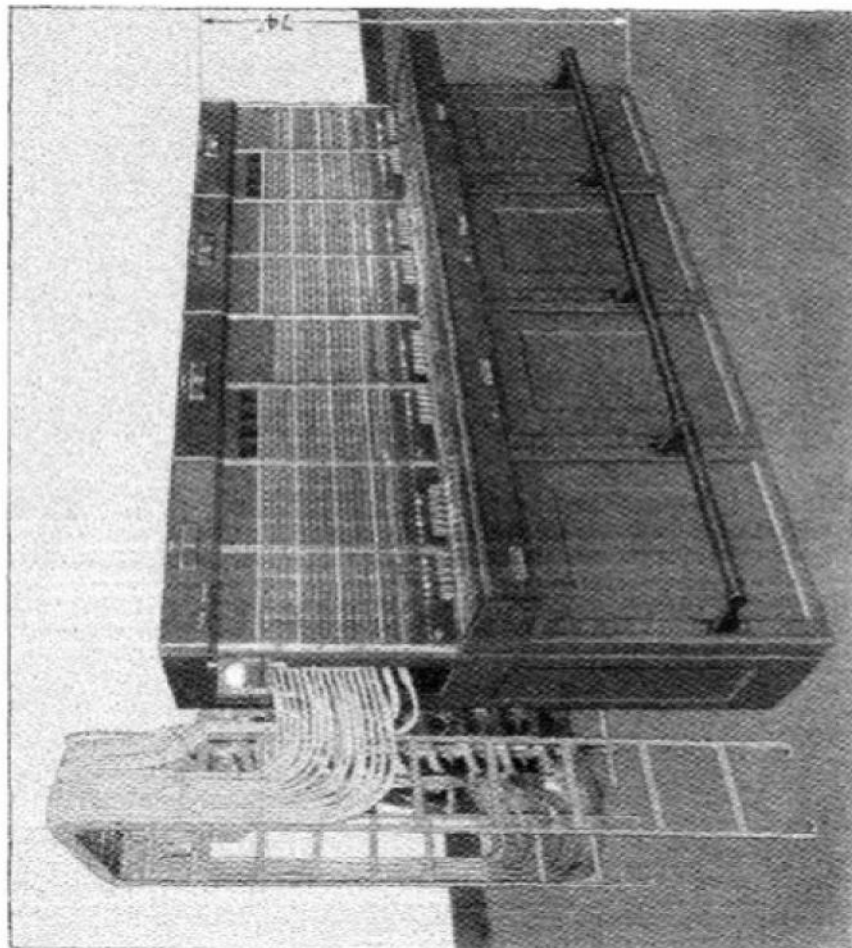

FIGURE 427. No. 12 Switchboard
(Western Electric Co.)

FIGURE 428. No. 12 Switchboard -
Floor Plan (Western Electric Co.)

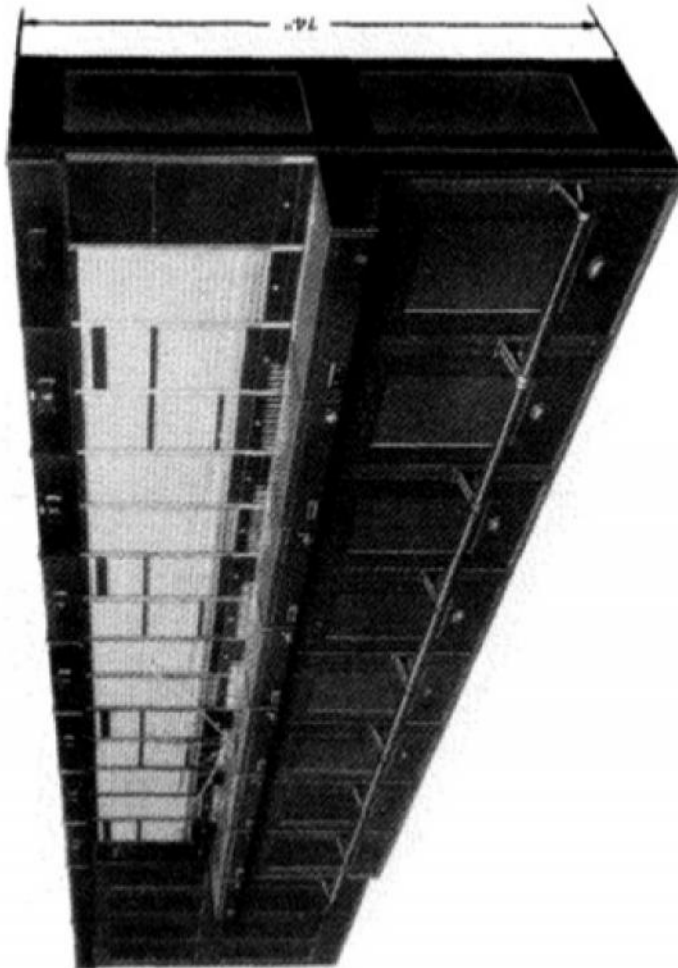

FIGURE 429. No. 605A Switchboard
(Western Electric Co.)

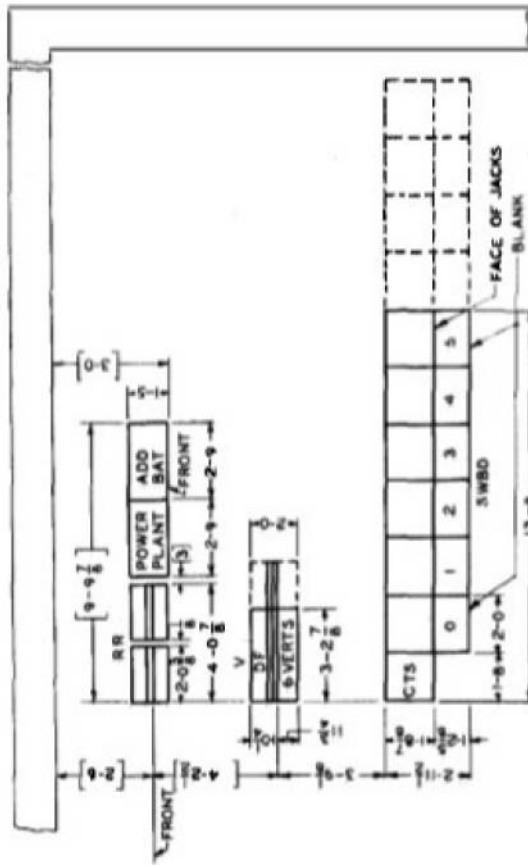

FIGURE 430. No. 605A Switchboard - Floor Plan
(Western Electric Co.)

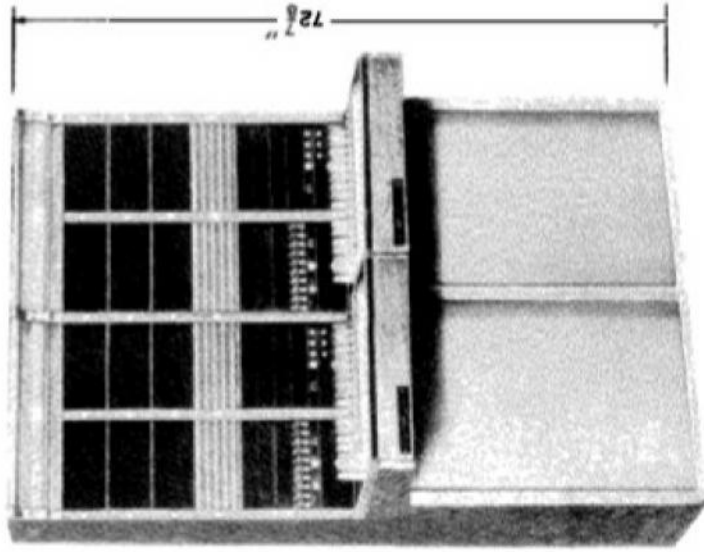

FIGURE 432. No. 1600 Switchboard
(Kellogg Switchboard & Supply Co.)

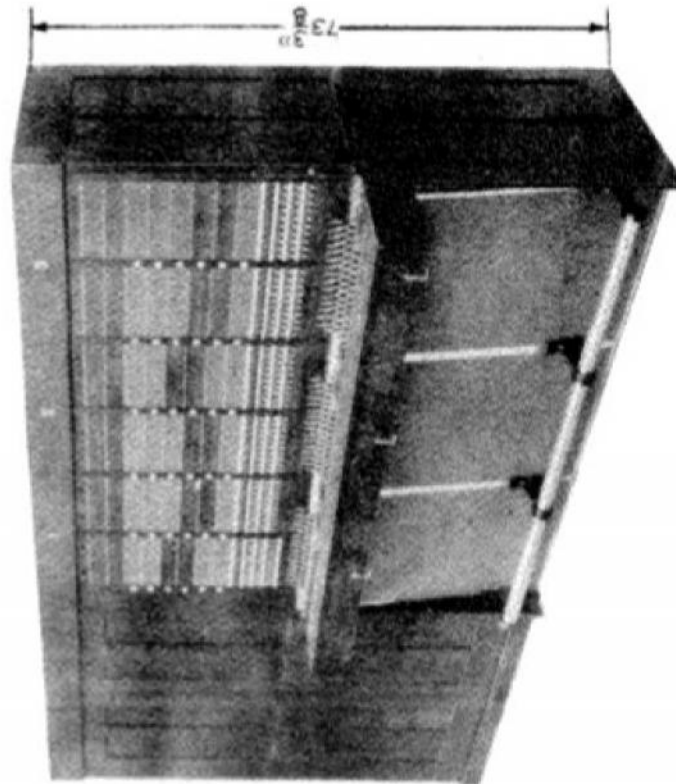

FIGURE 431. No. 15 Switchboard
(Stromberg-Carlson Co.)

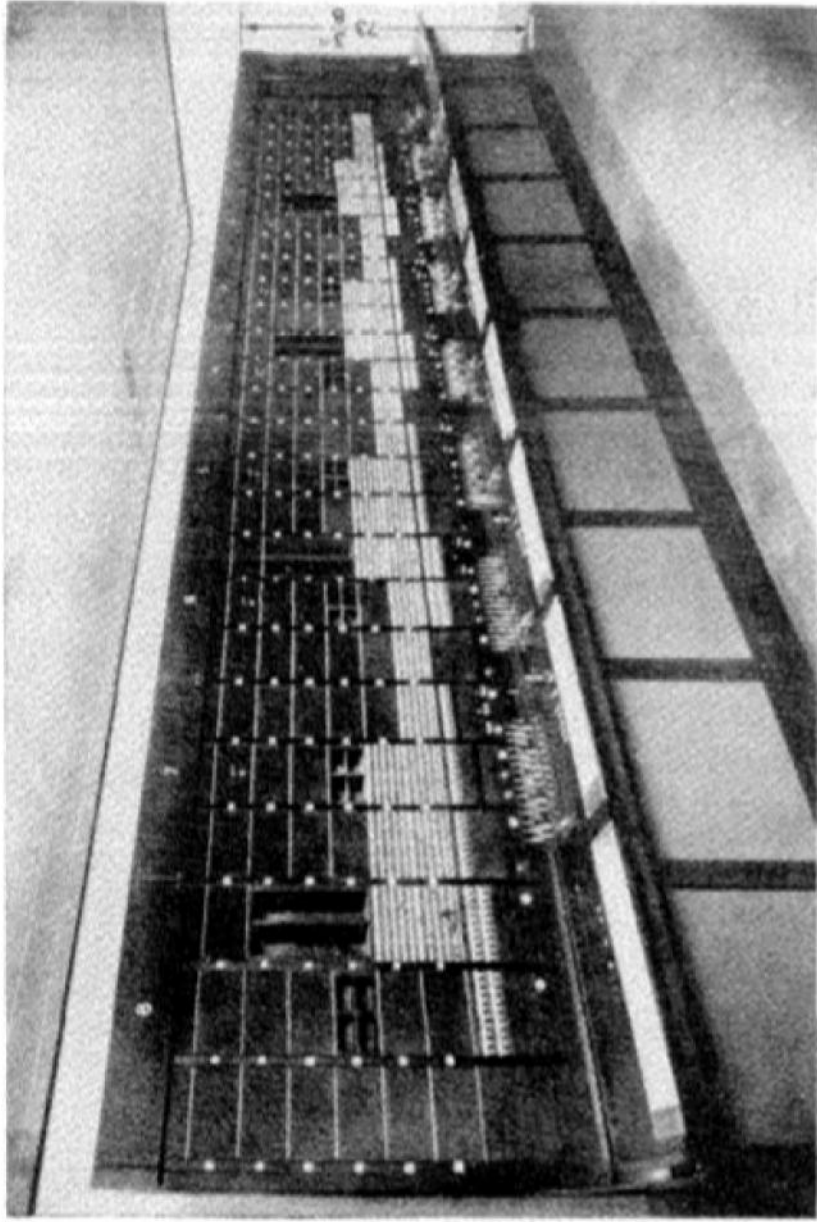

FIGURE 434. No. 18 Switchboard
(Stromberg-Carlson Co.)

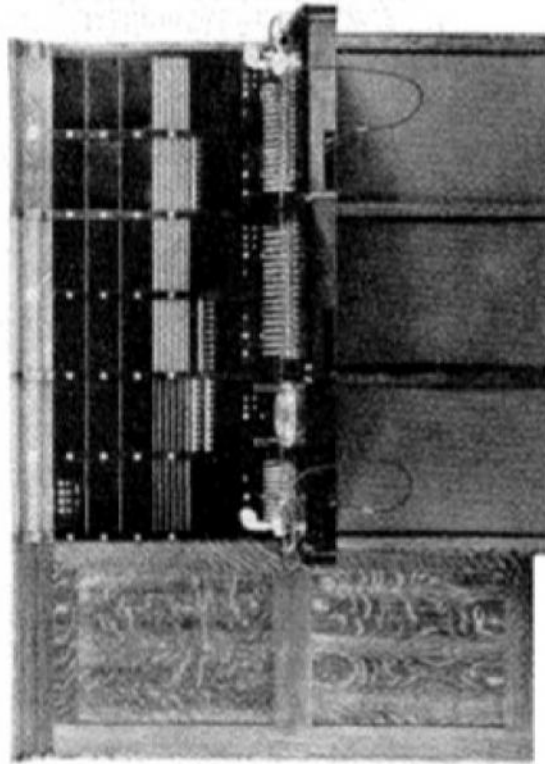

FIGURE 433. No. 12-1600 Switchboard
(Kellogg Switchboard & Supply Co.)

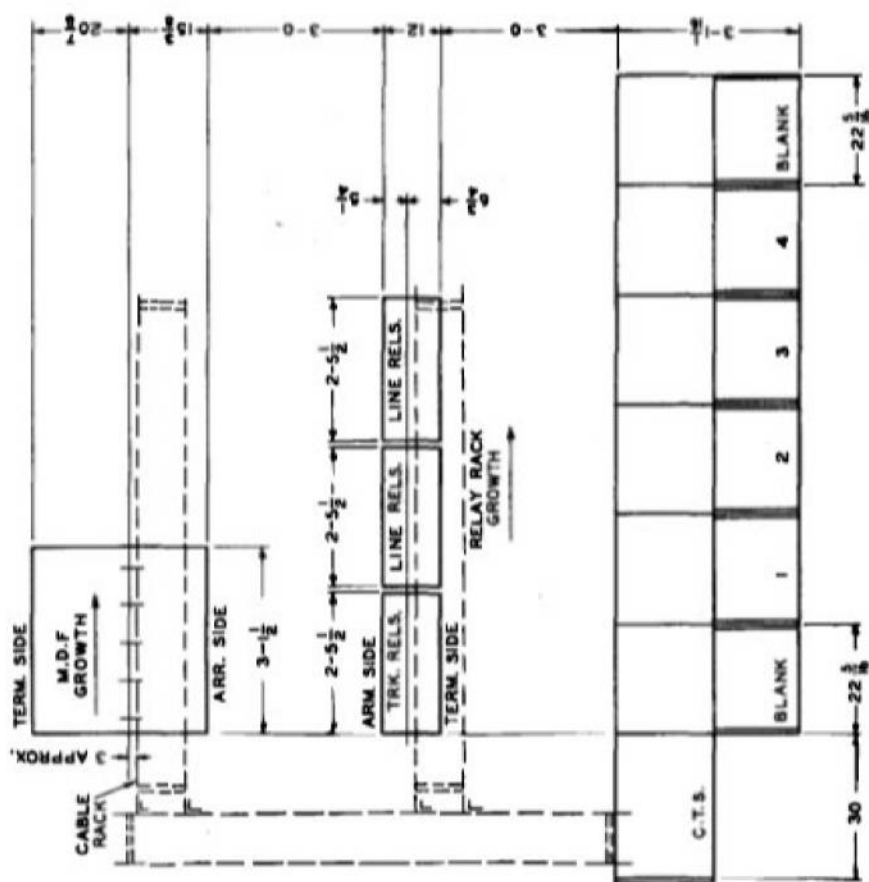

FIGURE 435. No. 2800 Switchboard -
Floor Plan
(Kellogg Switchboard & Supply Co.)

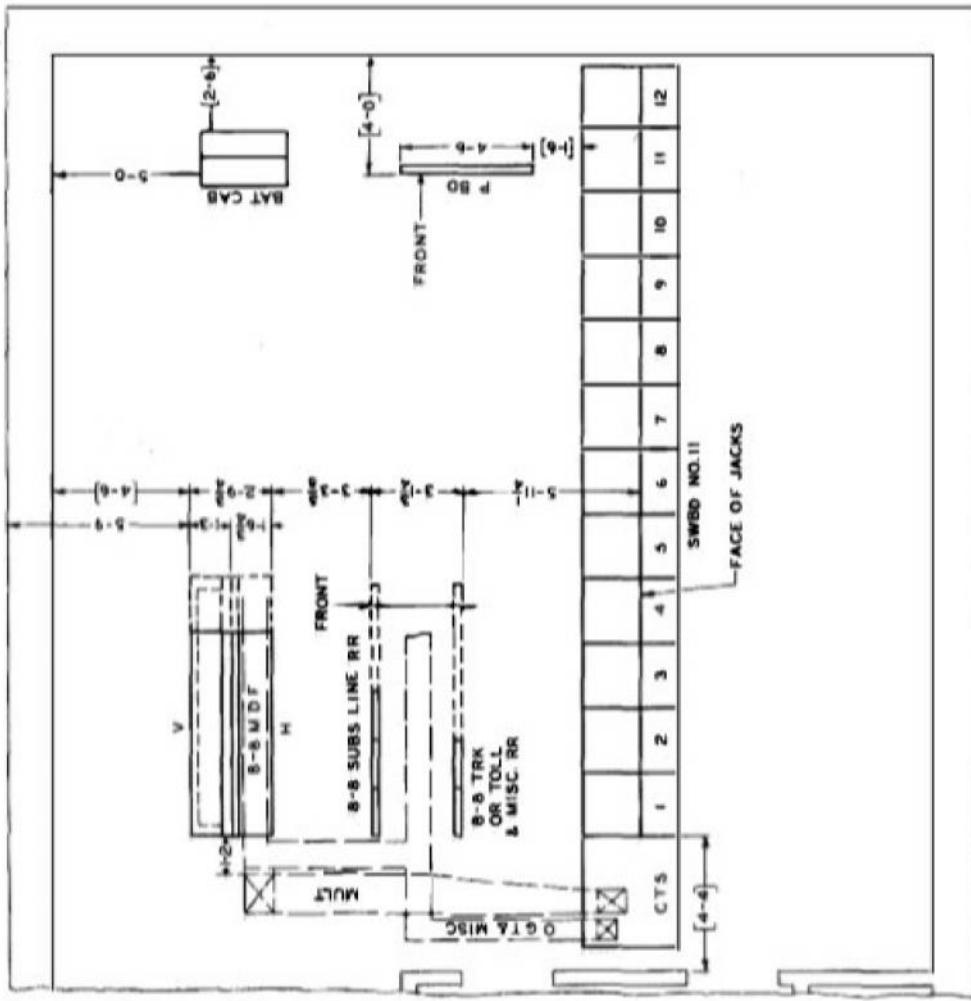

FIGURE 437. No. 11 Switchboard - Floor Plan
(Western Electric Co.)

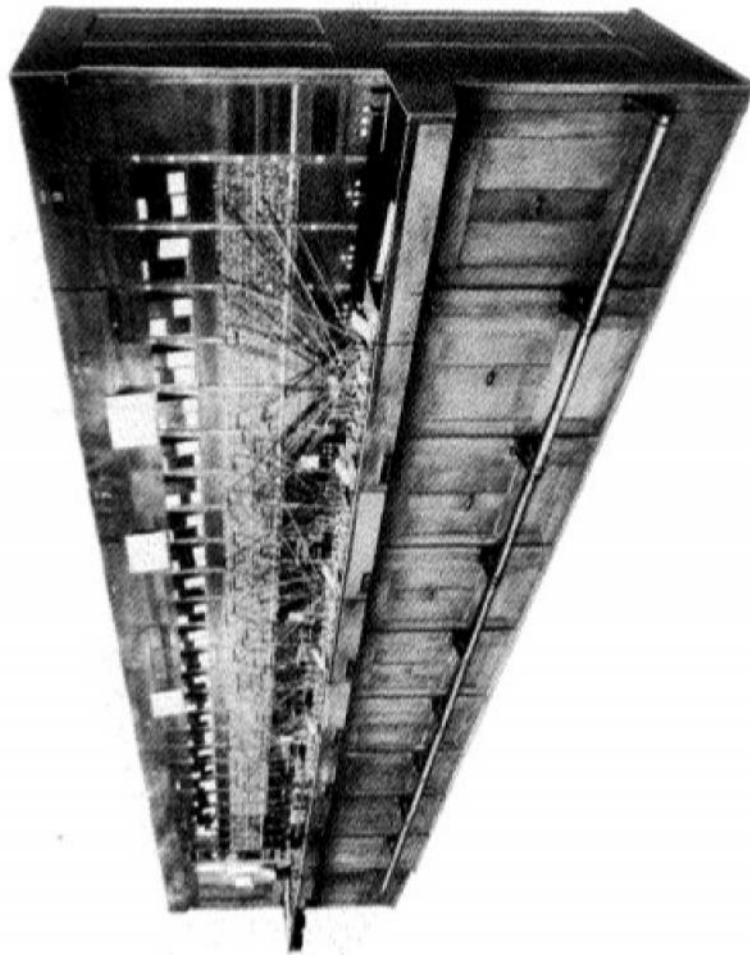

FIGURE 436. No. 11 Switchboard
(Western Electric Co.)

424. FIXED PLANT MULTIPLE TELEPHONE SWITCHBOARDS - DESCRIPTION.

a. Switchboard No. 1000. (North Electric Manufacturing Co.) This is an all relay dial switchboard with the equipment mounted on 7 ft. frames. An attendant's position is provided for each 200 lines installed. A wire chief's test cabinet is also provided. The equipment of the switchboard consists of a basic unit of 200 lines to which one or two 100 line additions can be added, which makes 400 lines the maximum line capacity. The attendant's cabinet has a jack on each dial line, for establishing connections. It is not recommended for use outside of the Zone of the Interior.

b. Switchboard No. 6-800. (Kellogg Switchboard & Supply Co.) This is a manual switchboard with subscriber's common battery cord circuits. These cord circuits give one lamp supervision on calls from local lines to two-way ringdown trunks. Switching of thru calls from one two-way ringdown trunk to another is not possible; the trunks do not give the necessary rering feature. These switchboards are no longer being procured.

c. Switchboard No. 119-600 Line. (Automatic Electric Co.) This is a step-by-step dial switchboard with the equipment mounted on 7 ft., 6 in. frames. One or two 400 line units can be added which makes 1400 lines the maximum line capacity. The attendant's cabinet has a jack on each dial line for establishing connections. Each 600 line basic unit is complete with two 50 amp. diverter-pole generators and two 30 watt dynamotors for 20 cycle ringing; three position attendant's cabinet and wire chief's test desk. It is not recommended for use outside of the Zone of the Interior.

d. Switchboard No. 12. (Western Electric Co., Inc.) This is a manual switchboard with "Universal" cord circuits. It is designed for growth of positions from left to right only. The magneto trunk circuits may be used interchangeably for magneto local lines or two-way ringdown trunks. Fifteen cord circuits per position is normal but an additional one on each end may be added making a total of 17. Two lever type keys are located in the middle of each position key shelf. These are for night alarm release, grouping, monitoring and master ringing. By means of the master ringing key, party line service can be given. Line relays if used mount in the rear of the switchboard sections in units of 14 which require form wiring to the last jack appearance of the lines. The number that can be installed is limited to six units (84 relays) per position. The "Universal" cord circuits provide nonlocked-in ringoff and rering signals for magneto lines and two-way ringdown trunks. This signal is on a third lamp in each cord circuit which is mounted in the face of the switchboard in front of

the cord pair to which it is associated. Switching of thru calls from one two-way ringdown trunk to another is possible with the Universal cord circuits.

e. Switchboard No. 605A. (Western Electric Co., Inc.) This is a manual switchboard with PBX type cord circuits. These are retardation coil and condenser type which furnish talking battery to each telephone line separately on local to local connections or on tie trunk calls and with which the talking battery comes from the distant common battery central office to the local line when connected to central office trunks. This limits the length of the local lines which are to be allowed central office connection because the conductor resistance of the trunk is part of the local line loop between the telephone and its battery supply on such trunk connections. The trunks are for termination on subscribers lines in manual or dial common battery offices and are ringdown incoming and automatic outgoing. Switching of thru calls from one trunk to another is not possible with these PBX type cord circuits. Therefore, the service is limited to local, out and in traffic. Lines and trunks have lamp signals. Line relays if used are mounted in the rear of the sections and are cabled to the end section for connection to the last jack appearance of the lines. Only one jack panel is equipped in the head and foot sections. The trunk and tie line relays mount in the sections. The distributing frames are enclosed in casings at the head of the switchboard which line up with the switchboard. Floor type self supporting distributing frames are available but if used require a cable turning section at the head of the switchboard line up.

f. Switchboard No. 15. (Stromberg-Carlson Co.) This is a manual switchboard with subscribers common battery cord circuits which give one lamp supervision on calls to ringdown trunks. Switching of thru calls from one two-way trunk to another is not possible; trunks do not give the necessary rering feature.

g. Switchboard No. 1600. (Kellogg Switchboard and Supply Co.) This is a manual switchboard with subscribers common battery cord circuits, which give one lamp supervision on connections to ringdown trunks. Switching of thru calls from one two-way trunk to another is not possible; the trunks do not give the necessary rering feature.

h. Switchboard 12-1600. (Kellogg Switchboard and Supply Co.) The description of the No. 1600 switchboard in the preceding paragraph also covers this switchboard.

i. Switchboard No. 119-1200 Line. (Automatic Electric Co.) This switchboard is the same as the one described in paragraph c, except that it is larger in local line capacity and has additional types of outdial trunks and has a six

position attendant's cabinet. Each 1200 line basic unit is complete with two 100 ampere diverter-pole generators and two 30 watt dynamotors for 20 cycle ringing, and wire chief's test cabinet. It is not recommended for use outside of the Zone of the Interior.

j. Switchboard No. 18. (Stromberg-Carlson Co.) This is a manual switchboard with subscriber's common battery type cord circuits which give one lamp supervision on connections to ringdown trunks. Switching of thru calls from one two-way ringdown trunk to another is not possible because the trunks do not give the necessary rering feature.

k. Switchboard No. 2800. (Kellogg Switchboard and Supply Co.) This is a

manual switchboard with subscriber's common battery cord circuits which give one lamp supervision on connections to ringdown trunks. Switching of thru calls from one ringdown trunk to another is not possible because the trunks do not give the necessary rering feature.

l. Switchboard No. 11. (Western Electric Co., Inc.) This is a manual switchboard with subscriber's common battery type cord circuits which require two-way ringdown trunk equipment, designed to provide rering signals. Switching of thru calls from one two-way ringdown trunk to another is possible because the trunks give the necessary rering feature.

425. FIXED PLANT MULTIPLE TELEPHONE SWITCHBOARDS - WORKING LIMITS IN OHMS.

Nomenclature Manufacturer Type No.		To Magneto Telephone KE-9-() (in L.B. position)			To Common Battery Telephone TP-6		Trunks to Common Battery Office	
		Max. Cond. Loop		Min. Ins. Res.	Max. Cond. Loop	Min. Ins. Res.	Max. Cond. Loop	Min. Ins. Res.
		No Repeat Coils	Repeat Coils ^a					
North Elec.	1000(Dial)	2,500		1,000	1,050	5,000	1,050	5,000
Kellogg	6-800				750	10,000	750	10,000
Auto. Elec.	119 (Dial)				1,000	15,000	1,000 Dial	15,000
							2,000 Max. 48V CO	
							1,500 Max. 24V CO	
Western Elec.	12	3,000	2,000	1,000	500 ^b	10,000	500 ^c	
Western Elec.	605A (PHX)				d	20,000	e	
Stromberg- Carlson	15				750		900 on 36V CO	
Kellogg	1600				750	10,000	325 on 20V CO	10,000
Kellogg	12-1600				750	10,000	750	10,000
Stromberg- Carlson	18				750		900 on 36V CO	
Kellogg	2800				750	10,000	325 on 20V CO	10,000
Western Elec.	11				835	10,000	750	10,000
							800 ^c	

^aOne repeating coil provided at each end of loop for simplex telegraph or phantom circuit use.

^bFor lines without line relays and with only two lamps per line.

^cThis figure is the minimum and may be exceeded depending on type of trunk.

^dLocal telephone lines that are not to be connected to a distant central office trunk may be operated with maximum conductor resistances, as follows:

Lines with line relays	1535 ohms
Lines without line relays, two 2C lamps	400 ohms
" " " " three 2C "	215 ohms
" " " " four 2C "	125 ohms

Local telephone lines which are to be connected to central office trunks may be operated on the above loops unless limited by the distant central office permissible maximum conductor loop resistance. The maximum conductor loop resistance through the No. 605A switchboard cord circuit to the distant central office should not exceed the permissible maximum conductor loop resistance for a Telephone TP-6 connected directly to that central office.

^eThe trunk maximum conductor loop resistance should not exceed the permissible maximum conductor loop resistance for a Telephone TP-6 connected directly to that central office, less 250 ohms.

426. FIXED PLANT MULTIPLE TELEPHONE SWITCHBOARDS - TRANSMISSION LOSSES IN DB AT 1000 CYCLES.

Nomenclature Manufacturer Type No.		Average Losses Caused by Equipment in a Switchboard Connection						Added Losses Due to Operator Bridge	
		Mag. Line to Mag. Line	Mag. Line to CB Line	Mag. Line to Trunk	CB Line to CB Line	CB Line to Trunk	CB Line to Tie Trunk	Talking	Monitoring
		Mag. Line	CB Line	Trunk	CB Line	CB Trunk	Tie Trunk		
North Elec.	1000(Dial)	2.9 ^a	1.6 ^a	2.3 ^a	0.3	1.0		3.0	2.7 ^b
Kellogg	6-800				1.2	1.8		2.3	0.2
Auto. Elec.	119(Dial)	0.8	0.8	1.6	0.7	0.8		1.5	0.5
Western Elec.	12	0.2	0.4	1.1	0.5	1.1		2.5	0.2
Western Elec.	605A (PHX)				0.7	0.5	0.9	1.5	
Stromberg- Carlson	15								
Kellogg	1600								
Kellogg	12-1600				1.2	1.8		2.3	0.2
Stromberg- Carlson	18								
Kellogg	2800				1.2	1.8		2.3	0.2
Western Elec.	11				.4	.7		2.5	

^aWith repeat coils in magneto lines, (one coil provided at each end of loop for simplex telegraph or phantom circuit use).

^bWithout monitoring coil.

427. FIXED PLANT MULTIPLE TELEPHONE SWITCHBOARDS AND ASSOCIATED EQUIPMENT - LOGISTICAL DATA.

Nomenclature		No. of Packages	Packed for Export		Ship Tons ^a
			Total Weight lbs.	Total Cu. Ft.	
Manufacturer	Type No.				
North Elec.	1000 (Dial)		22141 for 100L add	1235 for 100L add	30.9
			5651 for 100L	324 for 100L	8.1
Kellogg	6-800		7500 for 3 Pos. ^d	480 for 3 Pos. ^d	12.0
Auto.Elec.	119 ^b (Dial)	143	39200 for 600L add	2346 for 600L add	58.6
		35	11956 for 400L	718 for 400L	17.9
Western Elec.	12		7500 for 3 Pos. ^d	480 for 3 Pos. ^d	12.0
Western Elec.	605A (PBX)		8700 for 4 Pos.	550 for 4 Pos.	13.7
Stromberg Carlson	15		7500 for 3 Pos.	480 for 3 Pos.	12.0
Kellogg	1600		7500 for 3 Pos.	480 for 3 Pos. ^d	12.0
Kellogg	12-1600		7500 for 3 Pos.	480 for 3 Pos. ^d	12.0
Auto.Elec.	119 ^c	180	60000 for 1200L add	4000 for 1200L add	100.0
		35	11956 for 400L	718 for 400L	17.9
Stromberg Carlson	18		7500 for 3 Pos. ^d	480 for 3 Pos. ^d	17.0
Kellogg	2800		7500 for 3 Pos. ^d	480 for 3 Pos. ^d	12.0
Western Elec.	11		7800 for 5 Pos.	430 for 5 Pos.	11.0

^aA ship ton equals 40 cu. ft.

^bSignal Corps Contract W-287-SC-4894, DP-42-T-548 and Automatic Electric Company Sales Orders 7307-A to H, J to M, Q to V.

^cSignal Corps Contract W-287-SC-4894, DP-42-T-548 and Automatic Electric Company Sales Orders 7307-N and P, plus Q to Y.

^dWeight and cubic contents of 3 position switchboards and associated equipment are estimated. Add 1200 lbs and 70 cu. ft. for each added position and associated equipment.

Section IV Test Cabinets and Testboards

428. GENERAL.

a. Test cabinets and testboards are devices for use in telephone switching centers or in the field by testboard attendants, wire chiefs, line repairmen, and maintenance forces. These men should be provided with test equipment and telephones to enable them to test and analyze the circuits for grounds, shorts, crosses, and opens, and thereby clear

troubles on lines and in equipment units. A Wheatstone bridge is desirable to locate troubles. In the majority of cases where conditions permit, the testman will first make a talking and ringing test when a trouble is reported, to sectionalize the location of the fault. This will enable him to turn the faulty circuit over to the proper maintenance man for analyzing, locating and clearing the trouble.

b. Description of these test cabinets and testboards are given in paragraph 429 and stock numbers, shipping weights and dimensions are covered in paragraph 430.

429. TEST CABINETS AND TESTBOARDS - DESCRIPTION.

Name	Nomenclature Type No.	Shown in Fig.	Testing Features	Talking and Signaling Features	Carrying Weight Pounds ^a	Size ^b	TM or Instruction Book	Remarks
Cabinet	EE-70-()	438	100,000-ohm voltmeter measures up to 40V. d-c, 3000 ohms to 3 megohms. With VM SHUNT key operated, 7 to 5,600 ohms.	To talk to all switch- boards and to all telephones. To signal all switch- boards and all telephones.	32	12" x 9" x 18"	TM 11-345	Fixed plant wire chief's voltmeter testing equipment and telephone set, to maintain common battery and magneto office equipment, station lines, and trunks. Trunks can be maintained more conveniently with TS-26/TSM, 20-cycle hand generator or central office ringing machine, and buzzer. Has posts for adding a Wheatstone bridge for locating faults. Part of Test Equipment IE-10. Also part of Telephone Central Office Sets TC-1 and TC-2. Tests for grounds, crosses, shorts, and opens, line capacitance to ground or to other lines, and dis- tance to an open on a line.
Mobile Test Unit ^c	X-63699A	439	0-150 volts d-c, 0-150 milliamperes d-c, 50-60,000 ohms with 1000-ohm meter, 3000 ohms-6 megohms with 100,000-ohm meter 0-10 megohms with Wheatstone bridge	To talk to all switch- boards and to all telephones. No signaling features provided.	210	44-1/4" x 21-1/16" x 23-7/16"	TM 11-2033 or W.E.Co. X-66251	Wire chief's and maintenance man's mobile testboard. Includes tele- phone set, volt-milliammeter and Wheatstone bridge with self con- tained power supply (120V. 50-60 cycle, single phase power re- quired). Arranged to operate on dry cells (d-c measurements only) on emergency basis only. Suit- able for maintaining open wire, field wire and long cable circuits in large offices. No signaling features. Location of grounds, crosses, shorts, opens, resistance unbalances, split pairs and quads, and measurement of capacitances.

^aWeight shown is that of equipment unpacked.

^bSize shown is for equipment in operating condition.

^cNot available until letter part of 1944.

Table continued on next page.

TEST CABINETS AND TESTBOARDS - DESCRIPTION

(Continued)

Nomenclature Name	Type No.	Shown in Fig.	Testing Features	Talking and Signaling Features	Carrying Weight Pounds ^a	Size ^b	TM or Instruction Book	Remarks
Test and Control Board ^c	X-66034A or X-66034B (X-66034B is similar to BD-101-T2)	440	0-150 volts d-c, 0-150 milliamperes d-c, 50-60,000 ohms with 1000-ohm meter, 3000 ohms to 6 megohms with 100,000-ohm meter, 0-1 megohm with Wheatstone bridge, Capacity for 180, 3 jack telephone line circuits, 60, 2 jack telegraph line circuits, 10, local trunks, 30, miscellaneous jacks.	To talk to all switchboards and to local battery telephones. To signal magneto switchboards and all telephones. To signal common battery switchboards will require a trunk having a holding coil	525 without simplex coils, 700 with coils	67-3/4" x 28-1/2" x 28" when set up for operation	TM 11-2030 or W.S.Co. X-66259	Floor mounted testboard for fixed locations. Includes plug-ended telephone set, volt-milliammeter, and Wheatstone bridge (Test Set I-49) with self contained dry cell battery supply. Suitable for maintaining open wire, field wire and short cable circuits in large offices. X-66034B is the same as X-66034A except that 60 simplex coils are provided for making up simplex circuits as required. Signaling with 20-cycle hand generator and buzzer. Location of grounds, crosses, and shorts. Cannot be readily used for open location and capacitance measurements.

^aWeight shown is that of equipment unpacked.

^bSize shown is for equipment in operating condition.

^cNot available until letter part of 1944.

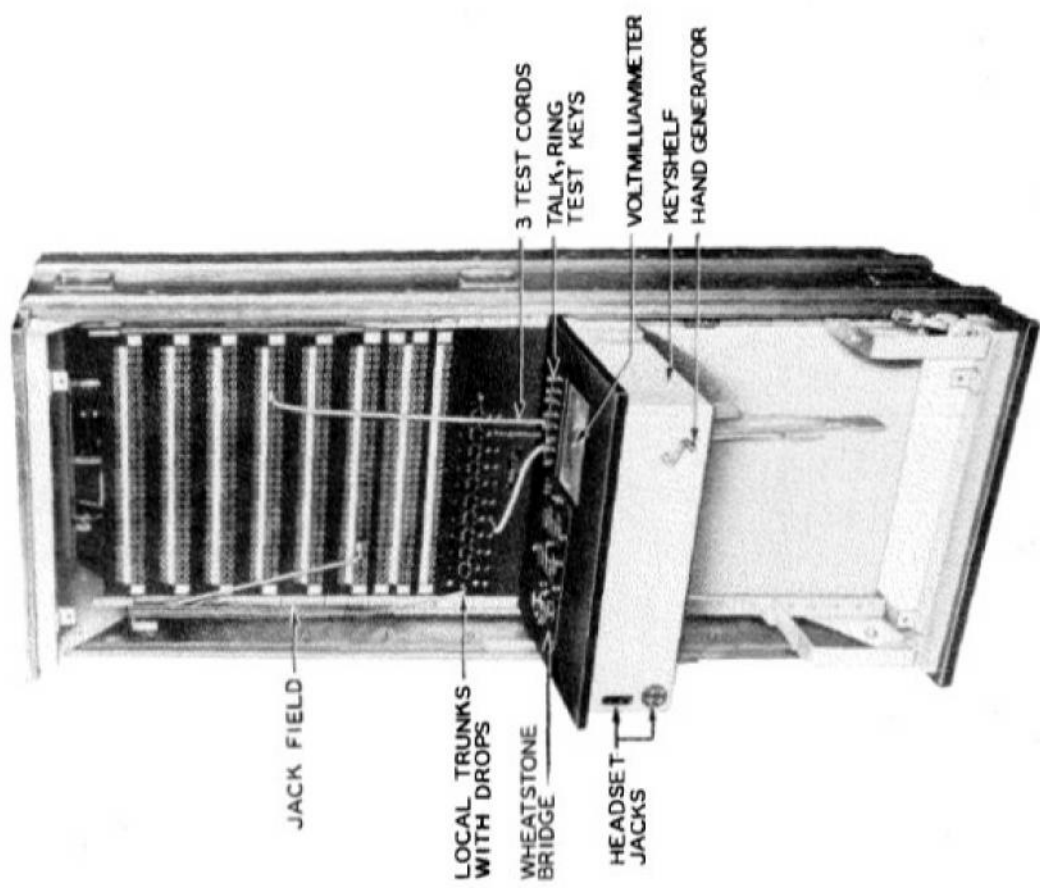

FIGURE 440. Test and Control Board X-66034A or X-66034B

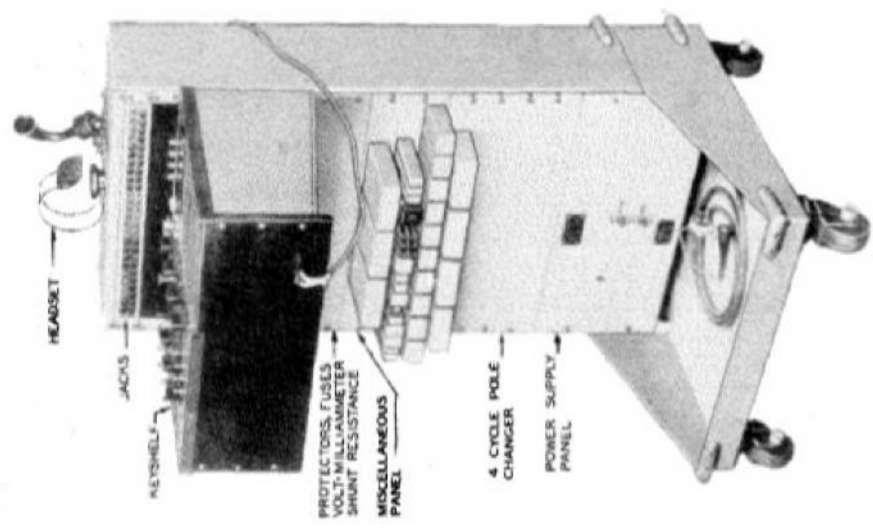

FIGURE 439. Mobile Test Unit X-63699A

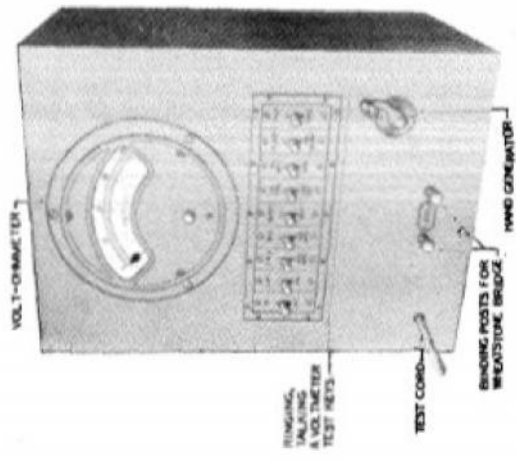

FIGURE 438. Cabinet BE-70- ()

430. TEST CABINETS, AND TESTBOARDS - STOCK NUMBERS AND LOGISTICAL DATA.

Nomenclature		Stock No.	Additional equipment required	Weight - pounds		Displacement - Cu.Ft.	
Name	Type No.			Equipment Code	Packed for export	In carrying case	Packed for export
Cabinet	BE-70-()	3F2405	20 Batteries BA-17 with suitable box (Connect to 24V. central office battery for telephone circuit). 1 Handset TS-8, or 1 Headset HS-30 1 Cord CD-605 and 1 Chest Set TD-1, or 1 Telephone EF-8-(), or equivalent with 2 Batteries BA-30 for local battery operation	119	68 Not portable	4.9	3.1
Mobile Test Unit	Western Electric Co. I-63699A	-	3 Batteries BA-36 10 Batteries BA-34, or 6 Batteries BA-34 6 Batteries BA-27	340	210 Not portable but equipped with wheels	18.8	13.3
Test and Control Board	Western Electric Co. X-66034A or X-66034B (X-66034B is similar to BD-101-72)	-	5 Batteries BA-25 6 Batteries BA-34 3 Batteries BA-36 2 Batteries BA-31	725 for X-66034A X-66034A 900 for X-66034B	525 for X-66034A 700 for X-66034B	31.6	23.5

Section V
Monitoring, Observing and
Recording Facilities

431. GENERAL. The equipment described in paragraph 432 has been provided for monitoring on commercial or Army telephone circuits. The essential features of this equipment are monitoring arrangements which introduce only a negligible transmission loss on the circuit, an ar-

range whereby the observer may interrupt conversation and talk to either of the users individually without interfering with the circuit signaling or supervision, and means for making a record of conversation over the circuit. The equipment is designed for use in telephone buildings which have commercial telephone central offices or fixed plant Army switchboards. Stock numbers, weights and volumes of these equipments are given in paragraph 433.

452. MONITORING, OBSERVING, AND RECORDING FACILITIES - DESCRIPTION.

Item	Nomenclature	Shown in Fig.	Use	Weight (lbs.)	Size	Power Requirements	Instruction Book	Remarks
(A)	Toll Line Observing Cabinet ADM-EM-100	441	At Telephone Central Office for monitoring, talking, splitting and recording (external recorder) - on single toll line	78	17-1/4" x 15-3/8" x 14-3/8"	115 Volts a-c, 50-60 cycles, 60 watts	W.E.Co. X-66208	For observing on originating long distance calls. Long distance toll line may be connected either through the patching cabinet, Item (B), or directly. The long distance line loops through the cabinet in such a way that no call can be completed unless cleared by the observer. Splitting does not interrupt the circuit for direct current. A recorder, Item (E), may be used with this cabinet. Cabinet contains a power pack. A General Electric Company, Type M, 1 KVA transformer is packaged with each cabinet for use where the available power is other than 115 volts. Instruction books, connecting cords, transformer and spare parts (sufficient for one year) are boxed with the cabinet for export shipment. The cabinet is made of wood and is suitable for use in tropical areas.
(B)	Toll Line Patching Cabinet ADM-EM-100	442	At Telephone Central Office for connecting toll observing cabinets to toll lines - 10 toll lines capacity	38	18-1/8" x 11-1/4" x 12"	Power from power pack in toll line observing cabinet, Item (A)	W.E.Co. X-66208	For connecting long distance lines to observing cabinets, Item (A). Contains talking and signaling facilities between the attendant and either toll switchboard operators or observers. Instruction books, connecting cords, spare parts (sufficient for one year) are boxed with the cabinet for export shipment. The cabinet is made of wood and is suitable for use in tropical areas.
(C)	Multiline Observing Cabinet ADM-EM-100	443	At Telephone Central Office for monitoring and recording (external recorder) - 30 local line or trunk capacity	50	19-1/2" x 11-3/4" x 10-1/4"	115 Volts a-c, 50-60 cycles and d-c potentials from central office battery, a-c 60 watts, d-c 0-2 watts	W.E.Co. X-66209	For monitoring or recording, with the aid of Item (E), on any one of 30 local common battery or magneto subscriber lines or trunks. A General Electric Co., Type M, 1 KVA transformer is packaged with each cabinet for use where the available commercial power is other than 115 volts. Instruction books, connecting block, cords, cables, spare parts (sufficient for one year), and transformer are boxed with the cabinet for export shipment. The cabinet is made of steel and is suitable for use in tropical areas.

Item	Nomenclature	Shown in Fig.	Use	Weight (lbs.)	Size	Power Requirements	Instruction Book	Remarks
(D)	Five-line Observing Cabinet ADM-BM-100	444	On Government premises at embarkation centers within the continental United States, for monitoring, talking, splitting, flashing an operator at the central office, grouping, and recording (external recorder) - five-line or trunk capacity	50	19-1/4" x 15-3/8" x 14-3/8"	20-26 Volt battery, 8 watts	W.S.Co. I-66329	For observing on a maximum of five common battery type of lines or trunks. Lamp signal indicates established call. Arrangements are included for connecting an external recorder, Item (E). Cabinets may be grouped for light load operation. Instruction books are included with set. Where 20-26 volt battery is not available, the Western Electric Company rectifier ES-15006 may be specified. This rectifier operates on 60 cycles, requires 60 watts and may be used to supply battery for three five-line observing cabinets. The cabinet is made of wood. This equipment is not moistureproofed.
(E)	Amertype Recordgraph Company's "Commando" Model A Recordgraph	445	At Telephone Central Office and government premises in conjunction with monitoring and observing cabinets. Items (A), (C) and (D)	46	18-5/8" x 9-1/2" x 13-1/2"	115 Volts a-c, 50-60 cycles, 115 watts	Amertype Recordgraph Company's Operating Instruction for "Commando" Model A Recordgraph	Film type (embossing on cellulose acetate tape), crystal or carbon microphone, start-stop either manual or voice control, automatic volume control, 115 sound tracks provide approximately 2-1/2 hrs. recording time for one loop of film. Playback on either a headset or loudspeaker. Capable of recording speech volumes at levels as low as approximately -30 vu measured on the line side of the input of the monitoring amplifier. The spare parts and operating instructions are also boxed with the recordgraph for export shipment. Suitable for use in tropical areas.

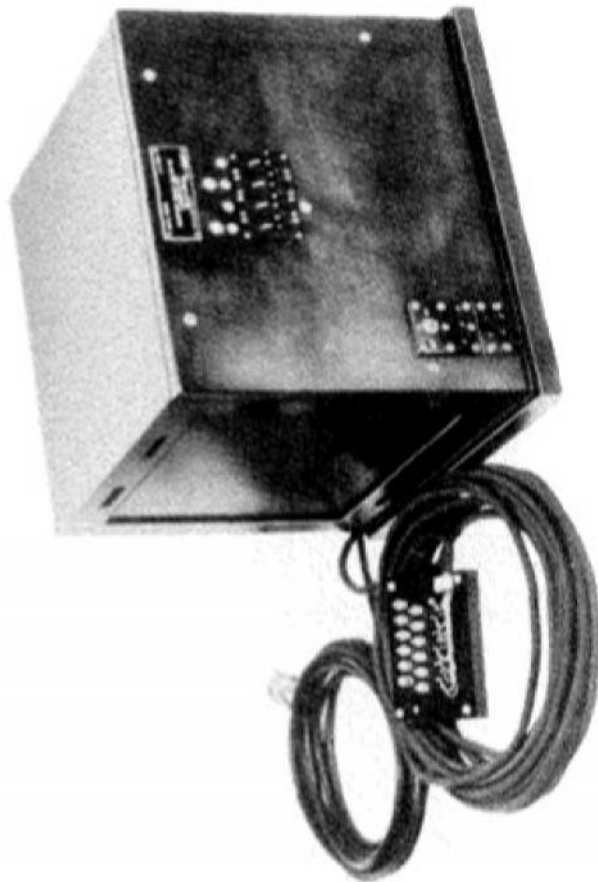

FIGURE 441. Toll Line Observing Cabinet ADW-BM-100

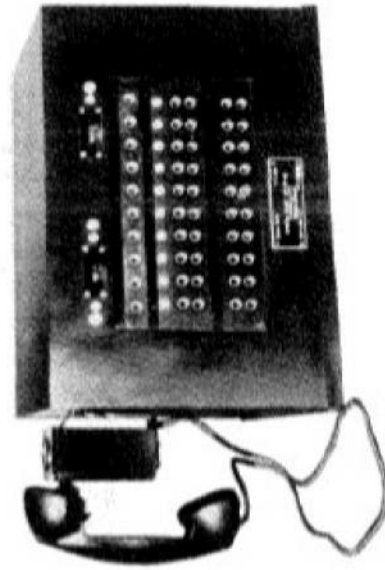

FIGURE 442. Toll Line Patching Cabinet ADW-BM-100

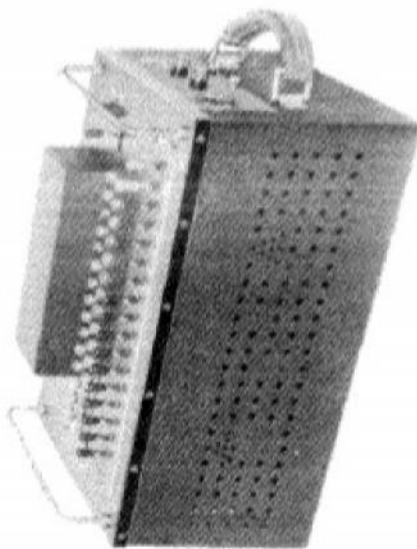

FIGURE 443. Multiline Observing Cabinet ADW-EM-100



FIGURE 444. Five-Line Observing Cabinet ADW-EM-100

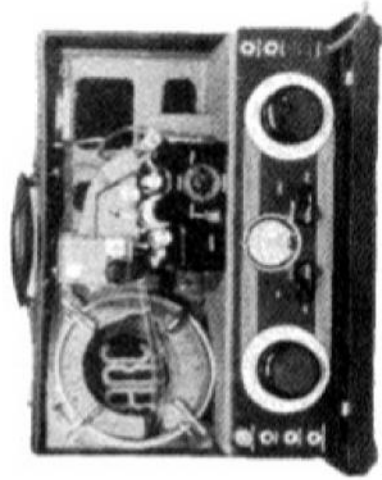

FIGURE 445. Recorder (Amertype Recordgraph Co. "Commando" Model A)

433. MONITORING, OBSERVING AND RECORDING FACILITIES - STOCK NUMBERS AND LOGISTICAL DATA.

<u>Item</u>	<u>Nomenclature</u>	<u>Stock Number</u>	<u>Approximate Weight (lbs.)</u>		<u>Approximate Displacement (Cubic Feet)</u>	
			<u>Packed For Export</u>	<u>In Carrying Case</u>	<u>Packed For Export</u>	<u>In Carrying Case</u>
(A)	Toll Line Observing Cabinet ADW-BM-100	4C1806	220	-	8.9	-
(B)	Toll Line Patching Cabinet ADW-BM-100	4C1806-1	305	-	18	-
(C)	Multiline Observing Cabinet ADW-BM-100	4C1806-2	345	-	18.2	-
(D)	Five-line Observing Cabinet ADW-BM-100	4C1806-8	a	-	-	-
(E)	Amertype Recordgraph Company's "Commando" Model A Recordgraph	6C263	115	46	7.1	1.38

^aFor use in continental United States; not moistureproof.

CHAPTER 5
PORTABLE AWS INFORMATION CENTERS

501. GENERAL. Portable and mobile information center facilities provide telephone equipment, furniture and certain auxiliaries for filter, operation and fighter control area operations room use in air warning network. This equipment is used for receiving intelligence concerning activities in an area; for displaying it for quick analysis; and for operational communications. Although these facilities are primarily intended for the use described above, this equipment can be adapted to meet other tactical requirements.

502. TYPES OF EQUIPMENT.

a. There are four types of these equipments, namely: Information Center System SCS-5, Portable Filter Center TC-15, Operations Center AN/TTQ-1 and Control Set SCR-572-A.

b. In the first three types, the components are arranged in cases for ease of transportation by trucks or planes and are moistureproofed for use in tropical areas. Sufficient tools and

spare parts for one year are provided with the equipments. All connections between equipment items in these types are made by flexible rubber covered cables, plugs and sockets. All outside wire connections are made by means of binding posts.

c. The installation time for setting up an Operations Center AN/TTQ-1 with an experienced crew of six men, assuming no change in the cross connections, is in the order of 3 to 5 hours. This does not include the time required to paint the map on the plotting board.

d. Control Set SCR-572-A is a mobile fighter control area operations room equipment for use as the central controlling point for Control Net System SCS-3. It is trailer mounted and includes a power unit, mounted in a separate trailer. The equipment is moistureproofed for use in tropical areas. Spare parts and tool equipment are included for one year's operation. All outside wire connections are made by means of binding posts.

503. AWS INFORMATION CENTERS - DESCRIPTION.

Nomenclature Name	Type No.	Shown Fig. Nos.	Operating Floor Area Required	Power	T.M. or Instr'n Book	Remarks
Information Center System	SCS-5	501 502	Operation Center with 3 Intercept Boards. 40' x 25' Above arrangement with Filt. Center. 69' x 25' Filt. Center with 1 or 2 Intercept. Bds. 20' x 25' Individual Intercept. Bd. 10' x 10'	Commercial 105-125V, 60 cycles a-c, or from 2 engine-alternators (5 KVA) provided, one for telephone facilities and for lighting, a second for emergency power. If Filter centers and Intercept Boards are remote from Operations Center, commercial or other power sources must be used. Rectifiers for 24V and 120V d-c supplies operate on 50 or 60 cycles. Static ring-generator operates on 55 to 65 cycles.	W.E.Co. X-61652	Includes: 1 Oper. center, 2 Filt. centers, 6 Intercept Boards and 6 radio terminals. One Filter center may be located with or one or both may be located remotely from the Oper. center. Of the 6 Intercept Boards a maximum of 4 may be located at the Oper. center, 3 at outlying Filt. center and 3 remotely. Telephone equipment for intercommunicating and connection to land lines and radio sets. Signaling on land lines is magneto. Position units designed with predetermined line capacity which can not be readily changed. A-c power control frame provides power switching, circuit breaker protection, and synchronizing equipment for operating both engine-alternators in parallel. One section of W.E.Co. Special 551 PBX (80 CB lines; 10 CB trunks; and 20 magneto lines) provided for use as an administration switchboard.

Table continued on next page.

AWS INFORMATION CENTERS - DESCRIPTION (Continued)

<u>Nomenclature</u> <u>Name</u>	<u>Type</u> <u>No.</u>	<u>Shown</u> <u>in</u> <u>Fig.</u> <u>Nos.</u>	<u>Operating</u> <u>Floor</u> <u>Area</u> <u>Required</u>	<u>Power</u>	<u>T.M. or</u> <u>Instr'n</u> <u>Book</u>	<u>Remarks</u>
Portable Filter Center	TC-15	-	Operations Center with 3 Intcpt. Bds. 40' x 25' Individual Intcpt. Bd. 10' x 10'	Same as SCS-5 except only one eng.-alt. is provided	W.E.Co. X61684	Components are same as those used with SCS-5 equipment except switchboard. Equipment included for one Oper. center, 3 Intcpt. Bds. and 3 radio terms. All of the 3 Intcpt. Bds. may be associated directly with or one may be located remotely from the Oper. center. Telephone equip. works with the same types of external circuits as SCS-5 equip. The AC pwr. control frame same as SCS-5. One section of W.E.Co. Special cordless 506B PBX (3 magneto and 2 common battery trks., 12 lines) provided as administration switchboard.
Operations Center	AN/TTQ-1	503 504 505	Wing Filter Room ^a Wing Operations Room Fighter Control Area operations Room ^b Combined Filter-Fighter Control Area Operations Room ^b Each require 25' x 30' Ceiling Height 9' Mobile Tactical Control Center Two 2-1/2 ton 6x6 trucks and two 1-ton cargo trailers	Commercial 105-125V 50-60 cycles a-c or from 2 eng.-alt. (3 KVA) provided.	TM 11-438 TM 11-932 (eng.-alt.)	Arranged for universal operation as a wing filter center, wing operations center, fighter-control area operations center or a combined filter-fighter control area operations center. Equipment includes telephone facilities, furniture, plotting and lighting equipment, power cabinet, storage batteries and two engine alternators. Packing cases used as platforms and benches. A mobile tactical control center employs two standard 2-1/2 ton (6x6) trucks for mounting and transporting platforms and cabinets, and two standard 1-ton cargo trailers for transporting the two eng.-alt. Details for mounting cabinets and platforms in trucks provided as part of equipment. Telephone equipment arranged for intercommunication and for connection to land lines and radio sets. Position units of two types; one a telephone unit and the other a five-line unit; permit ready transfer of lines to or from a position. Equipment included for remotely controlling sixteen of the commonly used Signal Corps radio sets. Except for common battery switchboard trunks circuits mentioned below signaling on land lines is magneto. Two Switchboards HD-72, 12 lines each, are provided for use as administration switchboard. Two common battery trunk units for connection to central offices each containing 2 circuits, are provided as supplementary equipment.

^aGround observer board may be placed in separate 9' x 9' room and remainder will require room 21' x 25'.

^bAir Ground monitor board may be placed in separate 9' x 9' room and remainder will require room 25' x 25'.

<u>Nomenclature</u> Name	<u>Type</u> No.	<u>Shown in Fig. Nos.</u>	<u>Operating Floor Area Required</u>	<u>Power</u>	<u>T.M. or Instr'n Book</u>	<u>Remarks</u>
Control Set	SCR-572-A	506	K-55 trailer - Over-all dimensions 21-1/5' long 10' high 8' wide Cargo trailer - Over-all dimensions 12' long 6' high 6' wide	Power for battery charger, station heaters and lighting equipment from Power Unit PE-99A (included) or from 115V a-c 50-60 cycles commercial pwr. line capable of supplying at least 5.5 KVA	AN-08-40 SCR-572-2	Mobile arrangement of central controlling point for Control Net System SCS-3. Control Set mounted in Trailer K-55 is divided into control room containing intercept plotting board with associated control positions and status board and operator's cabin containing radio operator's control equipment, D/F plotting board and 3, BD-72 Swbds. All lines are connected to switchboards so that any line may be connected to any other line or circuit. Includes following radio control units: 3 - RM-25-A 2 - RM-26-A 1 - RM-28-A 1 - RC-113-A and 20 Telephone Repeaters EE-99-(). Power unit PE-99-A is mounted in a one-ton cargo trailer.

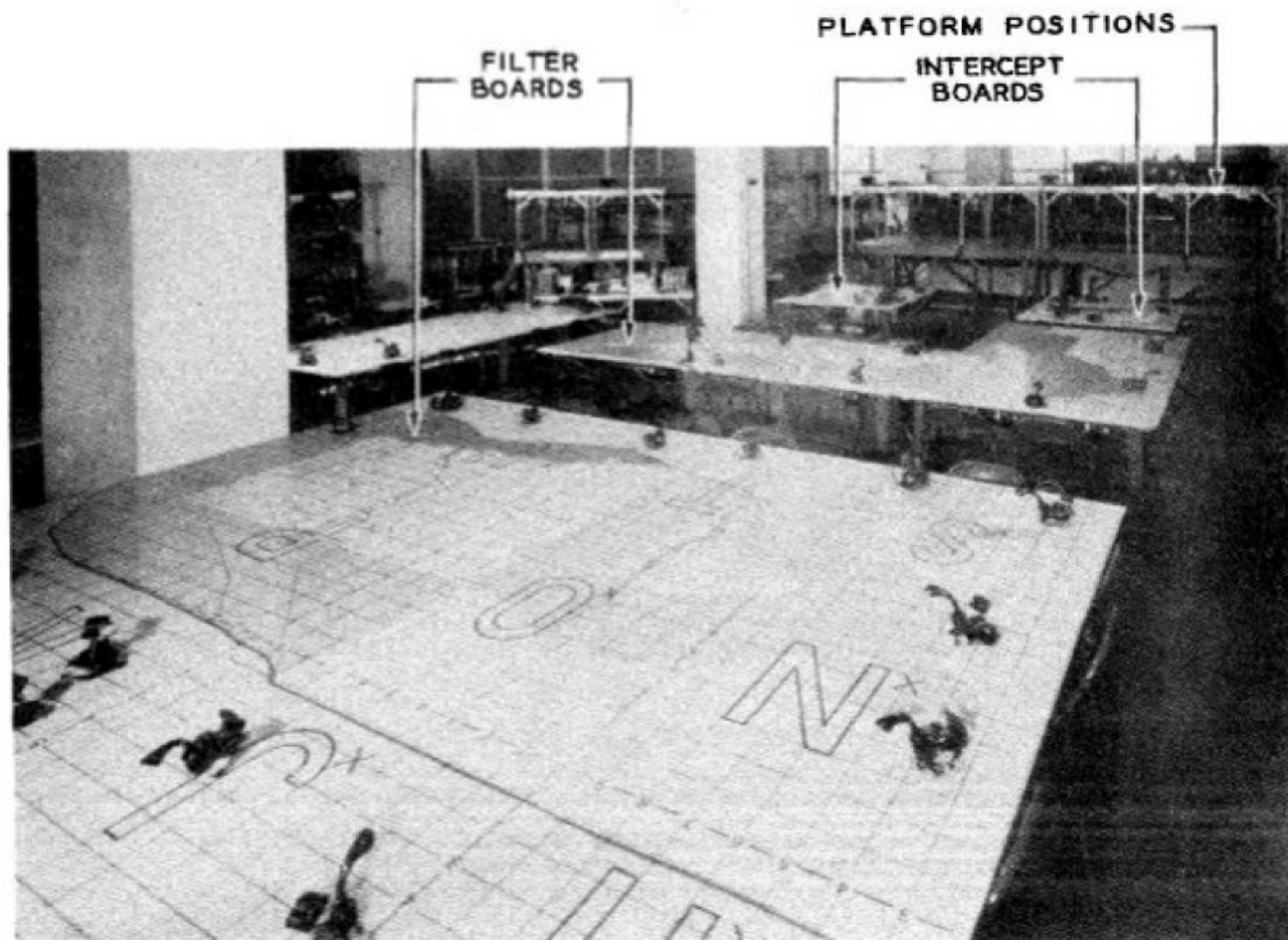

FIGURE 501. Information Center System SCS-5

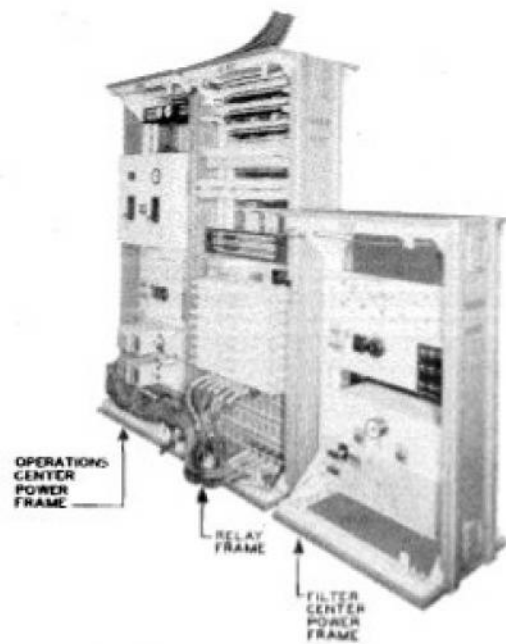

FIGURE 502. Information Center System SCS-5-1.
(Typical Frames)

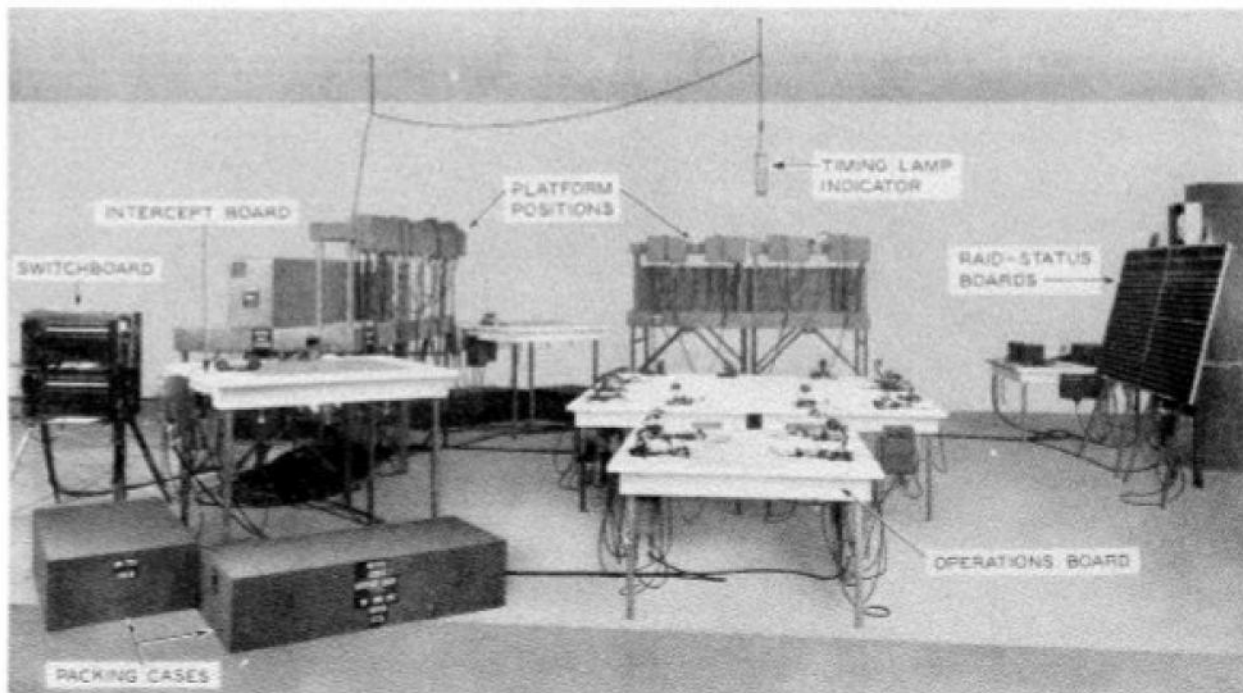

FIGURE 503. Operations Center AN/TTQ-1



FIGURE 504. Operations Center AN/TTQ-1 Equipment Packed in Truck

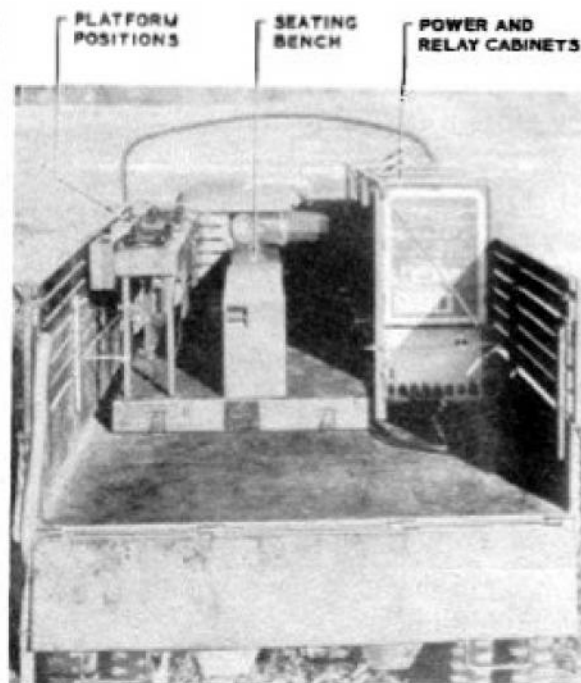

FIGURE 505. Operations Center AN/TTQ-1. Equipment Mounted in Truck as Mobile Tactical Control Center

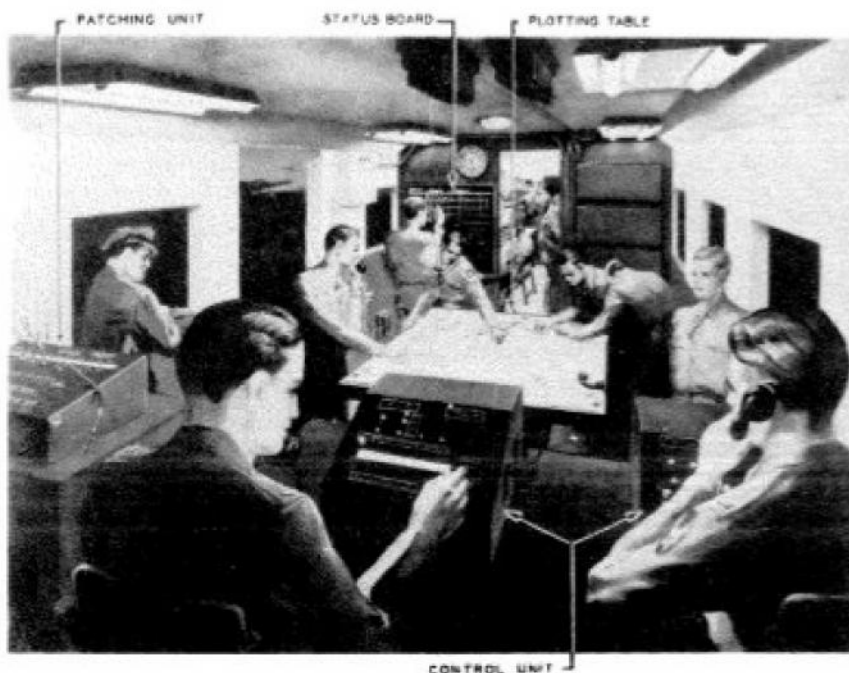

FIGURE 506. Control Set SCR-572-A

504. AWS INFORMATION CENTERS - STOCK NUMBERS AND LOGISTICAL DATA.

Signal Corps Type Number	Signal Corps Stock Number	Additional Equipment Required	No. of Packages per System	Weight of Largest Package (Pounds)		Total Weight (Pounds)		Total Cu Ft Packed		Ship Tons
				Packed for Export	Net	Packed for Export	Net	for Export	Net	
Information Center Sys- tem SC5-5	None	Necessary lighting equipment, batteries, clocks and paint.	91		1,330		28,330		1,530	
Portable Filter Center TC-15	626231	Necessary lighting equipment, clocks and paint.	41	1,420	1,330	16,163	12,758	1,044	702	26.1
Operations Center AN/TIQ-1	4C5990-1	None	24	810	650	7,660	6,500	382	260	9.6
Control Set SCR-572-A	2S572A	None	2		12,100	20,000	16,900	4,000		100

40 cu ft = 1 ship ton

CHAPTER 6
WIRE AND CABLE AND CONSTRUCTION INFORMATION

Section I
General

601. INTRODUCTION.

a. This chapter provides information on outside plant wire and cable, and the construction of wire and cable lines in the tactical and fixed plants.

b. Data on the physical and electrical characteristics of common barewire, field wire, field cables and lead-covered cables together with stock numbers and logistical data as applied to this material are given in sections II, III and IV. To aid in planning, typical tables of material requirements for building 100 mile units of various types of lines are provided. Shipping data are included to permit the provision of the required communication channels, employing the minimum shipping facilities. These tables are intended as guides only. Because of the widely varying conditions of terrain which will be encountered, individual material lists should be prepared to meet individual cases.

c. As a further aid in planning, section V provides the average time required for various types of work operations involved in line construction.

d. Section VI describes reels, reel equipment, tools and special trucks required in the handling and placing of the various types of plant.

e. Information concerning submarine cables is given in section VII.

Section II
Open Wire Lines

602. GENERAL. In addition to the electrical and physical properties of bare wires and other pertinent information this section gives examples of the material requirements necessary to make up 100-mile units of various types of open wire lines. Examples are given for both tactical and fixed plant. These examples should be used as guides only. The examples cover types of construction suitable for use under weather conditions experienced in various geographical areas. Because of the widely varying conditions to be met in the several theatres of operation, and conditions of supply, it

will be found advisable to make a list of requirements to meet each situation. In some theatres wire sizes other than those included in paragraphs 604 and 605 may be available. In those cases, approximate data may be obtained by interpolation from the tables for the stocks of wire covered in these paragraphs.

603. STORM LOADING.

a. In the United States, communication lines are designed to withstand three types of storm loading (see sleet storm map in TM 11-368), namely,

(1) Normal wind pressures of 12 pounds per square foot (about 70 mph) on the projected area of wires, at a minimum temperature of 30°F. This is termed, "light loading".

(2) Normal wind pressures of 8 pounds per square foot (about 60 mph) on the projected area of wires covered with 1/4" radial thickness of ice at a minimum temperature of 15°F. This is termed, "medium loading".

(3) Normal wind pressures of 8 pounds per square foot on the projected area of wires covered with 1/2" radial thickness of ice at a minimum temperature of 0°F. This is termed "heavy loading".

b. European and Asiatic countries have somewhat different storm loading requirements. In some foreign countries lines are designed to withstand three classes of loading and in others, two. In general the heavy loading requirements result in about the same strength of line whether in Europe, Asia or in the United States.

c. In selecting the type of line for a given area where ice and temperature conditions are not known, an attempt should be made to obtain this information from local communication or electric light people. Where this cannot be done a general rule to follow is to use heavy loading construction in latitudes higher than 40°, medium loading between latitudes 30 and 40°, and light loading in latitudes under 30°. Of course, there are exceptions to this rule. For instance, even in latitudes under 30° there are locations having elevations where ice and temperature conditions would indicate the advisability of using heavy loading area construction.

604. BARE WIRES AND WIRE MESSENGERS - PHYSICAL DATA AND STOCK NUMBERS.

Name or Material ^a	Type No.	Stock Number	Nominal Diam. Inches	Breaking Load Pounds	Net Weight Length ^b		Cu. Ft. per Wire Mile ^b	Remarks
					per Mile Pounds	per Package Feet		
080 C-S	W-153	1A153	.080	770	94	5,650	1.5	Have 40% of the conductivity of copper wire
104 C-S		1A809.104	0.104	1,170	159	6,650	1.8	
128 C-S		1A808.5	0.128	1,650	240	4,400	3.3	
104 C-S			0.104	1,275	159	6,650	1.8	30% of conductivity of copper wire
128 C-S		1A808.1	0.128	1,800	240	4,400	3.3	
080 CU			.080	330	102	4,400	1.3	Hard Drawn
104 CU	W-74	1A74	0.104	550	173	5,650	1.8	
128 CU		1A808	0.128	820	262	4,000	3.3	
165 CU		1A808.2	0.165	1,325	435	2,250	7.3	
109 G.S.	W-145	1A145	0.109	790	170	2,640	3.0	High Strength
083 G.I.	W-76	1A76	.083	250	99	2,660	2.0	
109 G.I. ^c		1A812	0.109	425	170	2,640	3.0	
134 G.I. ^c		1A810.1	0.134	645	258	2,660	4.0	
148 G.I. ^c	W-75	1A75	0.148	785	315	2,550	5.7	
165 G.I. ^c		1A75A	0.165	975	390	2,640	8.0	
203 G.I. ^c			0.203	1,475	590	1,740	12.0	
238 G.I. ^c			0.238	2,028	810	1,270	18.0	
Wire Messenger	W-503	1A503	3/16	2,400	410	2,500	17.0	2.2 ^d , G.S., 7-.065 in. strands
Wire Messenger	W-115	1A115	5/16	6,000	1,190	1,000	42.0	6M, G.S., 7-.109 in. strands
Wire Messenger	W-90	1A90	3/8	11,500	1,425	1,000	42.0	10M, G.S., 7-.120 in. strands
Wire Messenger	W-116	1A116	7/16	18,000	2,060	1,000	42.0	16M, G.S., 7-.144 in. strands

^aC-S = Copper Steel, CU = Copper, G.I. = Galvanized Iron, G.S. = Galvanized Steel

^bBare wire is furnished in coils (19" eye) wrapped with paper or fiber covering, and net weight and packed weight are approximately the same. Wire messenger may be obtained in lengths of 250, 500, 1000, 2500 and 5000 feet. Lengths of 250 and 500 feet (also 1000 feet for W-503 only) are furnished in coils. Lengths of 1000 feet (2500 feet for W-503) and greater are furnished on wooden reels weighing 40, 50, 90 and 130 pounds, (requiring shipping space of 8, 11, 16 and 28 cu. ft., respectively depending upon the quantity ordered. The shipping data given are based on the use of a 40-pound reel.

^cUsed primarily for construction purposes.

^dCommonly used designation for nominal breaking strength.

605. TRANSMISSION DATA ON OPEN WIRE LINES.

Name	D.C.Res. Type No.	100-Cycle Ohms per Loop Mile	100-Cycle Impedance Ohms	Approximate Attenuation ^a - db Per Mile					Nonrepeated Talking Range Miles for Net Loss of			
				1 Kc	8 Kc	11 Kc	20 Kc	30 Kc	6 db	18 db	30 db	
a. Bare Wires^b												
080 40% C-S	W-153	42.8	791-j481	Dry - 0.23 Wet - 0.25	0.31 0.34	0.32 0.35	0.33 0.36	0.33 0.37	24	72	120	
104 40% C-S		23.5	686-j335	Dry - 0.16 Wet - 0.18	0.20 0.22	0.20 0.23	0.21 0.24	0.21 0.24	33	100	165	
128 40% C-S		16.7	613-j227	Dry - 0.12 Wet - 0.13	0.14 0.16	0.14 0.16	0.14 0.17	0.15 0.18	46	140	230	
104 30% C-S		33.8	740-j418	Dry - 0.21 Wet - 0.22	0.28 0.30	0.28 0.31	0.29 0.32	0.29 0.33	27	82	136	
128 30% C-S		22.3	649-j291	Dry - 0.15 Wet - 0.17	0.19 0.22	0.20 0.22	0.20 0.23	0.20 0.24	35	106	176	
080 CU		17.5	680-j235	Dry - 0.11 Wet - 0.13	0.13 0.15	0.14 0.17	0.16 0.20	0.19 0.24	46	140	230	
104 CU	W-74	10.3	614-j145	Dry - .074 Wet - .083	.089 0.11	.099 0.12	0.13 0.16	0.15 0.19	72	215	360	
128 CU		6.8	580-j97	Dry - .052 Wet - .061	.071 .088	.080 0.100	0.11 0.14	0.13 0.16	100	300	500	
165 CU		4.1	545-j60	Dry - .034 Wet - .042	.056 .072	.064 .083	.084 0.11	0.10 0.13	145	435	725	
109 G.S.	W-145	75	1230-j630	Dry - 0.30 Wet - 0.31	1.1 1.1	1.3 1.3	1.7 1.7	2.0 2.0	19	57	95	
083 Galv. Iron	W-76	130	1380-j830	Dry - 0.36 Wet - 0.37	1.2 1.2	1.4 1.4	2.1 2.1	2.5 2.5	16	48	80	
b. Twin Pairs^c												
W-110-B "O.W."		93		Dry - 0.43 Wet - 0.46	0.66 0.68	0.68 0.71	0.70 0.75	0.73 0.79	13	39	65	
W-110-B "Tree"		93		Dry - 0.44 Wet - 1.1	0.68 1.6	0.70 1.7	0.75 2.1	0.80 2.6	5	16	27	
W-143 "O.W."		17.5		Dry - 0.13 Wet - 0.14	0.14 0.16	0.14 0.17	0.16 0.20	0.17 0.23	43	130	215	

^aAttenuations are for side circuits at 70°F and assume use of insulators IN-15 and IN-128 in good condition, that trees, brush, etc. do not touch wires and that recommended construction practices are followed. Pole spacing is assumed 200 feet except for 080 H.D. copper and twin pairs for which 150 feet is assumed. Pin spacing in all cases is assumed to be 8 inches.

^bC-S denotes copper-steel. Percentage is conductivity relative to copper.

^cTwo wires of one pair used in parallel form one side of the circuit and two wires of another pair form the other side. The "O.W." (open wire) twin pair is assumed to be strung like open wire on insulators and poles with 8" spacing. The "tree" twin pair is made of two W-110-B pairs tied to trees and spaced 8" to 24" apart. Attenuations apply when there are few contacts with foliage, etc.

606. MATERIALS FOR CONSTRUCTION OF TACTICAL OPEN WIRE LINES WITH 4 x 4 LUMBER SUPPORTS, 150-FOOT SPANS, LIGHT STORM LOADING AREAS.

Description	Stock Number	Quantities for 100 Miles of Line ^a				To Install 1 Additional Pair on Existing Line
		1-Pair Line ^b	2-Pair Line ^b	4-Pair Line		
Lumber, treated, 2" x 4" x 20'	5A2705	800	800	800	-	
Lumber, treated, 2" x 4" x 24'	5A2724	600	600	600	-	
Lumber, treated, 4" x 4" x 20'	5A2720	3,600	3,600	3,600	-	
Pole ^c , treated, Class 7, 35'	5A3235-1	16	16	16	-	
Crossarm ^b PF-92-A, 8-pin, 7'-4"	5A1592	2,300	2,300	4,000	-	
Pin PF-59, locust, 8"	5A3059	7,400	14,800	29,600	7,400	
Insulator IN-15, Toll, glass, SGSP	3G515	7,400	14,800	29,600	7,400	
Insulator IN-128, Transposition, glass	3G1815-53	400	800	1,560	400	
Wire W-153, 080 C-S, 40% conductivity	1A135	20,000 lbs.	40,000 lbs.	80,000 lbs.	20,000 lbs.	
Bolt, carriage; 3/8" x 4", G.I.	5B1106-4	640	640	640	-	
Bolt, carriage; 1/2" x 4-1/2", G.I.	5B1108-4.5	800	800	800	-	
Bolt, machine; 1/2" x 6", G.I.	5B1508-6	4,500	4,500	4,500	-	
Bolt, machine; 5/8" x 10", G.I.	5B1510-10	200	200	200	-	
Brace PF-4, crossarm	5B2104	640	640	640	-	
Cable lengths ^c (105') with connectors, made from Cable Assemblies CC-358		16	32	64	16	
Clamp PF-61, or Hubbard No. 7402, guy, 2-bolt	5B3061	640	640	640	-	
Connector, bridging, No. 3A	3Z1403	90	160	300	90	
Nail, common wire, 6-d	6L1406	50 lbs.	100 lbs.	200 lbs.	50 lbs.	
Nail, common wire, 12-d	6L1412	400 lbs.	400 lbs.	400 lbs.	-	
Nail, common wire, 20-d	6L1420	100 lbs.	100 lbs.	100 lbs.	-	
Protector, telephone line, 5-pair	5C2200	16	16	16	-	
Ring PF-74, bridle, C-type, 1-1/4" eye, G.S.	5B9320	100	180	300	100	
Screw, lag, 3/8" x 3-1/2", G.I.	5B10006-3.5	640	640	640	-	
Sleeve, CU, for 080 C-S (C-080-C)	6N5614.1	1,250	2,500	5,000	1,250	
Sleeve, G.S., for 109 guy wire, (S-109-Q)	6N5709.2	1,200	1,300	1,200	-	
Washer, square, G.I., 2-1/4" with 11/16" hole	5B20209-11	10,000	10,000	10,000	-	
Wire W-110-B	1B110BX	5,000 ft.	10,000 ft.	10,000 ft.	5,000 ft.	
Wire W-143	1B143	400 ft.	600 ft.	800 ft.	200 ft.	
Wire W-145, 109 G.S.	1A145	1,500 lbs.	1,500 lbs.	1,500 lbs.	-	
Wire, messenger, 2.2W, Utilities grade, 3/16"	1A503	10,000 ft.	10,000 ft.	10,000 ft.	-	
Wire W-154, tie, 080 CU, annealed, 19"	1A154	250 lbs.	500 lbs.	1,000 lbs.	250 lbs.	
Estimates for 100-mile unit:						
Weight, short tons		215	231	288	16	
Shipping space, cubic feet		12,350	13,040	15,620	660	
Ship tons ^d		309	326	390	16	
Construction time, based upon average terrain and weather conditions, man-days		1,120	1,250	1,460	390	

^aThis list includes a limited amount of spare material and is to be used as a guide only; requirements for the particular situation must be determined. Commercial experience indicates that about 20% spare material is required. Construction of tactical open wire lines is covered in TM 11-368.

^bOn one pair and two pair lines, crossarms are cut in half except at H-fittings and X-frames.

^cCable lengths (105') with connectors, made from Cable Assemblies CC-358, are used for underground railroad crossings. Open wire crossings with poles, treated, Class 7, 35', are preferable. However, if long poles are not available, underground crossings should be used.

^dShip ton assumed equal to 40 cu. ft.

607. MATERIALS FOR CONSTRUCTION OF TACTICAL OPEN WIRE LINES WITH ROUND POLES, 150-FOOT SPANS, HEAVY STORM LOADING AREAS.

Description	Stock Number	Quantities for 100 Miles of Line ^a					To Install a Complete Additional Crossarm of 4 Pairs	To Install 1 Additional Pair on Existing Line
		1-Pair Line	2-Pair Line	4-Pair Line	8-Pair Line	Additional Crossarm of 4 Pairs		
Pole, treated, Class 9, 20'	5A3220-4	2,600	2,600	2,600	-	-	-	
Pole, treated, Class 9, 22'	5A3222-1	1,000	1,000	1,000	3,600	-	-	
Pole, treated, Class 9, 25'	5A3225-5	260	260	260	260	-	-	
Pole, treated, Class 9, 30'	5A3234	120	120	120	120	-	-	
Pole, treated, Class 7, 35'	5A3235-1	24	24	24	24	-	-	
Pole, treated, Class 6, 40'	5A3240-1	24	24	24	24	-	-	
Crossarm PF-92-A, 8-pin, 7'-4"	5A1592	3,900	3,900	3,900	7,800	3,900	-	
Pin PF-59, locust, 8"	5A3059	7,400	14,800	29,000	58,000	29,000	7,400	
Insulator IN-15, Toll, glass, SGSP	3G515	7,400	14,800	29,400	56,800	28,400	7,400	
Insulator IN-128, Transposition, glass	3G1615-53	400	800	1,560	3,120	1,560	400	
Wire W-153, 060 C-S, 40% conductivity	1A153	20,000 lbs.	40,000 lbs.	80,000 lbs.	160,000 lbs.	80,000 lbs.	20,000 lbs.	
Anchor Rod AH-4, 5/8" x 6", G.I.	5B704	1,680	1,680	1,680	1,680	-	-	
Bolt, carriage, 3/8" x 4", G.I.	5B1106-4	4,000	4,000	4,000	4,000	4,000	-	
Bolt, machine, 5/8" x 8", G.I.	5B1510-8	4,000	4,000	4,000	4,000	4,000	-	
Bolt, machine, 5/8" x 10", G.I.	5B1510-10	1,400	1,400	1,400	1,400	1,400	-	
Bolt, machine, 5/8" x 12", G.I.	5B1510-12	760	760	760	1,520	760	-	
Brace PF-4, crossarm	5B2104	4,000	4,000	4,000	4,000	4,000	-	
Clamp PF-61, or Hubbard No. 7402, Guy, 2-bolt	5B3061	1,060	1,060	1,060	1,060	-	-	
Clamp PF-56, guy, 3-bolt	5B3450	2,100	2,100	2,100	2,100	-	-	
Connector, bridging, No. 3A	3Z1403	90	160	300	600	300	90	
Nail, common wire, 6-d	6L1406	50 lbs.	100 lbs.	200 lbs.	400 lbs.	200 lbs.	50 lbs.	
Thimbleye, bolt, angle, for 5/8" bolt	5B1635-1	1,680	1,680	1,680	1,680	-	-	
Ring PF-74, bridle, C-type, 1-1/4" eye, C.S.	5B9320	100	180	300	600	300	100	
Screw, lag, 3/8" x 3-1/2", G.I.	5B10006-3.5	4,000	4,000	4,000	4,000	4,000	-	
Sleeve, CU, for 060 C-S, (C-060-C)	6N5614.1	1,250	2,500	5,000	10,000	5,000	1,250	
Washer, square, G.I., 2-1/4" with 11/16" hole	5B20209-11	12,000	12,000	12,000	24,000	12,000	-	
Wire W-110-B	1B110B1	5,000 ft.	10,000 ft.	10,000 ft.	20,000 ft.	10,000 ft.	5,000 ft.	
Wire messenger, 2.2M, utilities grade, 3/16"	1A115	40,000 ft.	40,000 ft.	40,000 ft.	40,000 ft.	-	-	
Wire W-154, tie, 060 CU, annealed, 19"	1A505	21,000 ft.	21,000 ft.	21,000 ft.	21,000 ft.	-	-	
Wire W-154, tie, 060 CU, annealed, 19"	1A154	250 lbs.	500 lbs.	1,000 lbs.	2,000 lbs.	1,000 lbs.	250 lbs.	
Estimates for 100-mile unit:								
Weight, short tons	504	520	552	716	125	16	16	
Shipping space, cubic feet	25,630	26,290	27,560	35,060	5,400	660	660	
Ship tons ^c	641	657	689	876	135	16	16	
Construction time, based upon average terrain and weather conditions, man-days	1,400	1,520	1,730	2,500	910	390	390	

^aThis list includes a limited amount of spare material and is to be used as a guide only; requirements for the particular situation must be determined. Commercial experience indicates that about 20% spare material is required. Construction of tactical open wire lines is covered in TM 11-368.

^bIf a second crossarm is to be installed on an existing line, the poles must be of sufficient height to maintain clearances.

^cShip ton assumed equal to 40 cu. ft.

608. MATERIALS FOR CONSTRUCTION OF TACTICAL OPEN WIRE LINES WITH ROUND POLES, 200-FOOT SPANS, MEDIUM STORM LOADING AREAS.

Description	Stock Number	Quantities for 100-miles of Line ^a				To Install	
		1-Pair Line	2-Pair Line	4-Pair Line	8-Pair Line	a Complete Additional Crossarm of 4 Pairs	1 Additional Pair on Existing Line
Pole, treated, Class 9, 20'	5A3220-4	2,000	2,000	2,000	-	-	-
Pole, treated, Class 9, 22'	5A3222-1	800	800	800	2,800	-	-
Pole, treated, Class 9, 25'	5A3225-5	200	200	200	200	-	-
Pole, treated, Class 9, 30'	5A3234	100	100	100	100	-	-
Pole, treated, Class 7, 35'	5A3235-1	24	24	24	24	-	-
Pole, treated, Class 6, 40'	5A3240-1	24	24	24	24	-	-
Crossarm PF-92-A, 8-pin, 7'-4"	5A1592	3,100	3,100	3,100	6,200	3,100	-
Pin PF-59, locust, 8"	5A3059	6,000	12,000	23,200	46,400	23,200	6,000
Insulator IN-15, Toll, glass, SGGP	3G515	6,000	12,000	22,440	44,880	22,440	6,000
Insulator IN-128, Transposition, glass	3G1815-53	400	800	1,560	3,120	1,560	400
Wire W-153, 080 C-S, 40% conductivity	1A153	20,000 lbs.	40,000 lbs.	80,000 lbs.	160,000 lbs.	80,000 lbs.	20,000 lbs.
Anchor Rod AH-4, 5/8" x 6", G.I.	5B704	1,320	1,320	1,320	1,320	-	-
Bolt, carriage, 3/8" x 4", G.I.	5B1106-4	3,200	3,200	3,200	6,400	3,200	-
Bolt, machine, 5/8" x 8", G.I.	5B1510-8	3,200	3,200	3,200	6,400	3,200	-
Bolt, machine, 5/8" x 10", G.I.	5B1510-10	1,100	1,100	1,100	2,200	1,100	-
Bolt, machine, 5/8" x 12", G.I.	5B1510-12	600	600	600	1,200	600	-
Brace PF-4, crossarm	5B2104	3,200	3,200	3,200	6,400	3,200	-
Clamp PF-61, or Hubbard No. 7402, Guy, 2-bolt	5B3061	840	840	840	840	-	-
Clamp PF-56, guy, 3-bolt	5B3450	1,680	1,680	1,680	1,680	-	-
Connector, bridging, No. 3A	3Z1403	90	160	300	600	300	90
Nail, common wire, 6-d	6L1406	40 lbs.	80 lbs.	160 lbs.	320 lbs.	160 lbs.	40 lbs.
Thimbleye, bolt, angle, for 5/8" bolt	5B1535-1	1,320	1,320	1,320	1,320	-	-
Ring PF-74, bridle, C-type, 1-1/4" eye, C.S.	5B9320	100	180	300	600	300	100
Screw, lag, 3/8" x 3-1/2", G.I.	5B10006-3.5	3,200	3,200	3,200	6,400	3,200	-
Sleeve, CU, for 080 C-S, (C-080-C)	6W5614.1	1,250	2,500	5,000	10,000	5,000	1,250
Washer, square, G.I., 2-1/4" with 11/16" hole	5B20209-11	9,500	9,500	9,500	19,000	9,500	-
Wire W-110-B	1B110BX	5,000 ft.	10,000 ft.	10,000 ft.	20,000 ft.	10,000 ft.	5,000 ft.
Wire W-115, messenger, 6M, 5/16"	1A115	32,000 ft.	32,000 ft.	32,000 ft.	32,000 ft.	-	-
Wire, messenger, 2.2M, Utilities grade, 3/16"	1A503	16,800 ft.	16,800 ft.	16,800 ft.	16,800 ft.	-	-
Wire W-154, tie, 080 CU, annealed, 19"	1A154	200 lbs.	400 lbs.	800 lbs.	1,600 lbs.	800 lbs.	200 lbs.
Estimates for 100-mile unit:							
Weight, short tons		401	416	445	583	108	15
Shipping space, cubic feet		20,360	20,960	22,100	28,290	4,600	600
Ship tons ^c		509	524	552	707	115	15
Construction time, based upon average terrain and weather conditions, man-days		1,160	1,270	1,450	2,110	780	340

^aThis list includes a limited amount of spare material and is to be used as a guide only; requirements for the particular situation must be determined. Commercial experience indicates that about 20% spare material is required. Construction of tactical open wire lines is covered in TM 11-368.

^bIf a second crossarm is to be installed on an existing line, the poles must be of sufficient height to maintain clearances.

^cShip ton assumed equal to 40 cu. ft.

**609. MATERIALS FOR CONSTRUCTION OF OPEN WIRE LINES FOR FIXED PLANT,
150-FOOT SPANS, ALL STORM LOADING AREAS.**

Description	Stock Number	Quantities for 100-miles of Line 4 Pairs	Description	Stock Number	Quantities for 100-Miles of Line 4 Pairs
Pole, treated, Class 7, 30'	5A3230-1	3,800	Bolt, carriage, 3/8" x 4-1/2" G.I.	5B1106-4.5	250
Pole, treated, Class 7, 35'	5A3235	50	Bolt, double arming, 5/8" x 14", G.I.	5B1210-14	200
Pole, treated, Class 6, 40'	5A3240-1	40	Bolt, double arming, 5/8" x 16", G.I.	5B1210-16	400
Crossarm PF-92-A, 8-pin, 7'-4"	5A1592	4,000	Bolt, double arming, 5/8" x 18", G.I.	5B1210-18	400
Pin PF-59	5A3059	32,250	Bolt, double arming, 5/8" x 20", G.I.	5B1210-20	400
Insulator, glass, Whitall Tatum No. 1	3G1815-1	29,000	Bolt, eye, 5/8" x 10", G.I.	5B1310-10	100
Insulator IN-128, transposition glass	3G1815-53	2,200	Bolt, eye, 5/8" x 12", G.I.	5B1310-12	50
Wire, 104 C-S, 40% conductivity	1A909.104	135,000 lbs.	Bolt, eye, 5/8" x 14", G.I.	5B1310-14	20
Wire W-74	1A74	Substitute for Wire, 104 C-S	Bolt, eye, 3/4" x 10", G.I.	5B1312-10	50
Wire W-90	1A90	20,000 ft.	Bolt, eye, 3/4" x 12", G.I.	5B1312-12	25
Wire W-115	1A115	40,000 ft.	Bolt, bent eye, 5/8" x 10", G.I.	5B1410-10	400
Wire, #12 BWC G.I.	1A812	10,560 ft.	Bolt, bent eye, 5/8" x 12", G.I.	5B1410-12	100
Wire, #12 NBS, copper, S.d., 22" pieces	1A812.2	2,000 lbs.	Bolt, bent eye, 5/8" x 14", G.I.	5B1410-14	30
Wire W-50	1B50	10,000 ft.	Bolt, bent eye, 3/4" x 10", G.I.	5B1412-10	125
Wire W-110-B	1B110BX	10,000 ft.	Bolt, bent eye, 3/4" x 12", G.I.	5B1412-12	75
Wire, #6, weatherproof triple braid, solid, h.d.	1B806.1	1,000 ft.	Bolt, bent eye, 3/4" x 14", G.I.	5B1412-14	25
Wire #14, ground RC solid, 600-volt, single white braid	1B814.16	1,000 ft.	Bolt, machine, 5/8" x 6", G.I.	5B1510-6	150
Insulator, strain, porcelain Thomas #500	3G1875-500	200	Bolt, machine, 5/8" x 8", G.I.	5B1510-8	100
Insulator, strain, porcelain, Thomas #502	3G1875-502	80	Bolt, machine, 5/8" x 10", G.I.	5B1510-10	2,000
Insulator, strain, porcelain, Thomas #504	3G1875-504	50	Bolt, machine, 5/8" x 12", G.I.	5B1510-12	3,000
Connector, bridging, W.E.Co. #3A	3Z1403	200	Bolt, machine, 5/8" x 14", G.I.	5B1510-14	200
Block, protector, carbon, W.E.Co. #26	4R926	400	Bolt, machine, 5/8" x 16", G.I.	5B1510-16	100
Block, protector, W.E.Co. #30	4R930	400	Bolt, machine, 5/8" x 18", G.I.	5B1510-18	100
Bracket PF-58	5A558	200	Brace PF-83, (side arm)	5B1985	50
Bushing, locust ^a	5A905		Brace PF-4	5B2104	8,250
Step, pole, wood, 1-3/4" x 2-3/4" x 7"	5A3710	200	Brace, vertical, Hubbard #7986	5B2226	20
Anchor AH-1	5B101	100	Bracket PF-66, (drop) ^a	5B2366	
Anchor AH-2	5B102	800	Bracket PF-67, (phantom transposition) ^a	5B2367	
Anchor AH-9	5B109	300	Clamp, cable, 7/16"	5B3107	500
Anchor, guy, Matthews, Scruilix, 8" (with 6' rod)	5B308-6	300	Clamp, ground, strand; Hubbard #8956 or equal	5B3349	20
Anchor Rod AH-6-A	5B706A	825	Clamp FT-56, 3-bolt guy	5B3450	3,000
Anchor Rod AH-7-A	5B707A	310	Connector, strand	5B4210	50
Anchor Rod, 1/2" x 7'-6"	5B808-7.6	100	Eye-nut, thimbleye, G.I., for 5/8" bolt	5B4305	250
Anchor Rod, rock guy, 1" x 18", thimbleye bolt and wedge	5B816-1.5	30	Ground Rod GP-26	5B4426	60
Anchor, swamp, screw type, 12", for use with 2" pipe	NSN	50	Hook, guy, "J", 4"	5B5284	200
Bolt, carriage, 3/8" x 4", G.I.	5B1106-4	8,500	Nut, square, G.I. for 5/8" bolt	5B6510	400
			Pin PF-62, (for transposition bracket) ^a	5B8062	
			Pin, steel, Hubbard 8005 or equal	5B8320	80
			Ring PF-73, (1/2")	5B9310	400
			Ring PF-74, (bridle, 1-1/4")	5B9320	200
			Ring PF-75, (bridle, 1-5/8")	5B9326	100

^aThese items are required only when transpositions are to be made on brackets instead of on Transposition Insulators (IN-128) in the manner described in TM 11-2253 Open Wire Construction for Fixed Plant Application. Table continued on next page

**MATERIALS FOR CONSTRUCTION OF OPEN WIRE LINES FOR FIXED PLANT,
150-FOOT SPANS, ALL STORM LOADING AREAS. (Continued)**

Description	Stock Number	Quantities for 100-Miles of Line		Description	Stock Number	Quantities for 100-Miles of Line	
		4 Pairs	4 Pairs			4 Pairs	4 Pairs
Ring, drive, 5/8", G.I.	5B9536		400	Washer, round, G.I.	5B20311		200
Screw, lag, G.I., 1/4" x 2-1/2"	5B10004-2.5		50	Protector, telephone, line, 5-pair	5C2200		20
Screw, lag, G.I., 1/2" x 4-1/2"	5B10008-4.5	5,000		Paint, ready mixed orange, lead base, Signal Corps	6G1510		10 gal.
Screw, lag, G.I., 1/2" x 6"	5B10008-6		100	Nail, common wire, 6-d	6L1406		300 lbs.
Screw, wood, #14, 2", RH, G.I.	5B14014-16		120 doz.	Nail, common wire, 30-d	6L1430		100 lbs.
Servisleeve for 5/16" strand	5B15500		2,500	Nail, common wire, 60-d	6L1460		200 lbs.
Staple, G.I., 1-1/2"	5B17001.5		40 lbs.	Nail, roofing, #12, 1"	6L2001		25 lbs.
Step PF-37	5B17137		2,400	Sleeve FT-88, (copper #10 B&S, 4-3/4" long)	6N5588		
Strap, storm guy, C.S., Hubbard #6001	5B17511		250	Sleeve, splicing, SCL-696-A, Nicopress, C-104-Q	6N5610.3	5,000	
Thimble PF-44	5B18044		200	Sleeve, offset, dead-end, Nicopress, 91-102J	6N5621-2	1,000	
Washer PF-77	5B20077		200	Solder M-31	6N7531		20 lbs.
Washer PF-78	5B20078		500	Solder, wire, half and half, #10	6N7600		20 lbs.
Washer PF-79	5B20079	10,000		Tape TL-83	6N8583		100 rolls
Washer, square, G.I., 2-1/4", with 11/16" hole	5B20209-11		2,000	Tape TL-94	6N8594		25 rolls
Washer, square, G.I., Hubbard #7817 or equal	5B20212-13		100	Pipe, carbon steel, fed. Spec. WW-P-403A (2-inch, in 10-foot lengths)	6Z7557-2.2		200 ft.
Washer, curved, G.I., for 5/8" bent eye bolt	5B20310		1,400				

610. OPEN WIRE LINES - SHIPPING DATA.

Tactical Line	Quantities for 100 Miles of Line							
	1 Pair		2 Pairs		4 Pairs		8 Pairs	
	Weight	Shipping Space	Weight	Shipping Space	Weight	Shipping Space	Weight	Shipping Space
4x4 Lumber Supports, 150' Span	Lbs.	Cu. Ft.	Lbs.	Cu. Ft.	Lbs.	Cu. Ft.	Lbs.	Cu. Ft.
Poles and Crossarms	386,600	11,530	386,600	11,530	434,900	12,720	This type of construction is not used.	
Pins and Insulators	11,900	370	23,800	740	47,600	1,480		
Wire	20,000	320	40,000	640	80,000	1,280		
Accessory Materials	11,200	130	11,600	130	12,700	140		
Total	429,700	12,350	462,000	13,040	575,200	15,620		
Ship tons ^a		309		326		390		
Tactical Line								
Round Poles, 150' Span								
Poles and Crossarms	925,000	24,110	925,000	24,110	925,000	24,110	1,109,000	29,930
Pins and Insulators	11,900	330	23,800	660	45,800	1,290	91,900	2,570
Wire	20,000	320	40,000	640	80,000	1,280	160,000	2,560
Accessory Materials	51,500	870	52,000	880	52,800	880	70,700	1,000
Total	1,008,400	25,630	1,040,800	26,290	1,103,600	27,560	1,431,600	35,060
Ship tons ^a		641		657		689		876
Tactical Line								
Round Poles, 200' Span								
Poles and Crossarms	731,100	19,070	731,100	19,070	731,100	19,070	875,400	22,840
Pins and Insulators	9,800	270	19,600	550	37,200	1,040	74,400	2,080
Wire	20,000	320	40,000	640	80,000	1,280	160,000	2,560
Accessory Materials	40,900	700	41,300	700	42,100	710	56,300	810
Total	801,800	20,360	832,000	20,960	890,400	22,100	1,166,100	28,290
Ship tons ^a		509		524		552		707

^a Ship ton assumed equal to 40 Cu. Ft.

Fixed Plant Line 30' Class 7 Round Poles, 150' Spans	Quantities for 100 Miles of Line							
	1 Pair		2 Pairs		4 Pairs		8 Pairs	
	Weight	Shipping Space	Weight	Shipping Space	Weight	Shipping Space	Weight	Shipping Space
	Lbs.	Cu. Ft.	Lbs.	Cu. Ft.	Lbs.	Cu. Ft.	Lbs.	Cu. Ft.
Poles and Crossarms	1,729,000	45,530	1,729,000	45,530	1,729,000	45,530	1,859,000	48,330
Pins and Insulators	16,700	440	33,400	880	66,800	1,770	133,600	3,540
Wire	33,700	370	67,500	740	135,000	1,480	270,000	2,960
Accessory Materials ^a	98,500	1,950	99,300	1,950	100,700	1,970	129,200	2,160
Total	1,877,900	48,290	1,929,200	49,100	2,031,500	50,750	2,372,600	56,990
Ship tons ^b		1,207		1,228		1,269		1,425

^aFigures based on average requirements and do not include all of the accessory materials listed in paragraph 609.

^bShip ton assumed equal to 40 Cu. Ft.

Section III Field Wires and Field Cables

611. GENERAL. In this section are given the electrical and physical data on field wires and field cables, all of which are insulated with rubber or rubber substitutes. In addition, examples are included of the types and quantities of materials which might be required for 100-mile units of spiral-four aerial, ground surface and buried cable lines together with weights and shipping space requirements.

612. SPIRAL FOUR WITH MESSENGER SUPPORT. In an aerial installation where clearances are critical or spans unusually long, so that the amount of sag in spiral four cable cannot be tolerated, it may be supported by messenger. A method of employing messenger support, that will withstand most storm conditions, is described in TM 11-369. While the description covers only one span, intermediate supports can be handled readily by supporting the messenger loosely with drive hooks (PF-81). Where speed rather than strength is important, Wire W-145 (109 high strength steel) or other wire may be used as a messenger in place of 2.2M strand. If cable hangers per SCL Spec. No. 694 (Stock No. 5B3459) are not available as a means of attaching the

cable to the messenger, loops of marline or Wire W-110-B may be used. Placing the hangers or supports at intervals of 6 to 10 feet ordinarily will be found satisfactory.

613. LONG RANGE TACTICAL WIRE W-143.

a. The requirements for long range tactical wire (W-143) as to materials for aerial, ground surface and buried lines are similar to the respective cases for spiral-four cable given in paragraph 616. However, it should be noted that Wire W-143 has no connectors and should be spliced in the manner set forth in TB SIG 3, in which rubber tape and friction tape are specified.

b. In aerial construction, Wire W-143 may be supported from poles and trees like spiral-four cable, through the use of Drive Hook PF-81 and hanger (SCL Spec. 694). A short length of Wire W-143 is placed in the hanger along side the wire to be supported, to afford a firm grip of the hanger on the wire. At corners and terminal poles Wire W-143 may be supported by Clamp PF-84 (Stock No. 5B3084). This type of clamp may also be used in anchoring to stakes in ground surface construction. When Wire W-143 is placed aerially the span length should be not over 150 feet and the sag in a 150-foot span should be not less than about 3-1/2 feet.

614. FIELD WIRES AND CABLES - PHYSICAL DATA AND STOCK NUMBERS.

Name	Momenclature Type No.	Stock No.	Major Dimension of Cross- Section Inches	Net Weight per Mile of Wire or Cable Pounds	Load Pounds	Type of Package	Length per Package	Packed ^a Weight per Mile of Wire or Cable Pounds	Cu. Ft. per Mile of Wire or Cable	Remarks ^b
Wire	W-50	1B150	.450	320	400	Coil	1000 ft.	320	5.8	Twisted pair, drop wire; 14 ga. (.064 in.) hard drawn copper; each rubber and braid covered, nonstabilized.
Wire	W-108	1B108	.260	170	400	Coil	1000 ft.	190	4.8	Parallel pair, drop wire; 17 ga. (.045 in.) tinned copper-steel or bronze, rubber, cotton braid, weather-proofed, nonstabilized.
Wire	W-108-A	1B108A	.260	158	340	Coil	1000 ft.	158	4.8	Same as W-108 except 18 ga. (.040 in.)
Field Wire	W-110-BC	1B110B.2	.290	120	300	Reel DR-5	1 mile	154	4.0	Twisted pair; each rubber and braid covered; each composed of 4-.013 in. steel and 3-.0135 in. copper strands, nonstabilized.
		1B110B.1				Reel DR-4	1/2 mile	164	4.0	
		1B110BX				Coil	1000 ft.	120	4.8	
Assault Wire	W-130	1B130.1	.126	30	110	Reel DR-4	2 miles	41	1.0	Twisted pair; each rubber covered; no braid; each composed of 6-.0095 in. steel and 1-.010 in. copper strands, nonstabilized.
		1B130.2				Reel DR-8	1/4 mile	33	1.6	
Assault Wire	W-130-A	1B130A.1	.120	34.5	110	Reel DR-4	2 miles	45.5	1.0	Same as W-130 except plastic (vinylite) instead of rubber.
		1B130A.2				Reel DR-8	1/4 miled	42.5	1.6	
Assault Wire	W-130-C									Approximately same as W-130-A except polyethylene insulation instead of vinylite.
Assault Wire	WD-3/TF		.180	45	120	Reel DR-4	1 mile	67	2.0	Same as W-130 except that each conductor has braid over rubber.
						Reel DR-8	1/4 mile	53	1.6	
Long Range Tactical W1-8	W-143 ^c	1B143	.304	240	290	Reel DR-5	5/8 mile	294	6.4	Parallel pair; each conductor composed of 9-.0226 in. copper strands; stabilized, cotton braid, weather-proofed. TB Sig 3.
	CC-344	1B1444	.5	425			10 ft.			5-pair, consists of Cable WC-534, 10-ft. length, with plug on one end only, .036 in. copper, solid, each rubber covered; rubber overall, nonstabilized. TM 11-371 and TM 11-366.
Cable Assembly	CC-345	1B1445-2640	.5	600	425	Reel DR-7	1/2 mile ^d	690	15.8	5-pair, consists of Cable WC-534 with plug on each end; .036 in. copper, solid, each rubber covered; rubber overall, nonstabilized. TM 11-371 and TM 11-366.
	Shown in Fig. No.	1B1445-1000				Reel DR-15	1000 ft.	810	25.3	

Nomenclature Name	Type No.	Stock No.	Major Dimension of Cross-Section Inches	Breaking Load Pounds	Net Weight per Mile of Wire or Cable Pounds	Type of Package	Length of Wire per Package	Packed ^a Weight per Mile of Wire or Cable Pounds	Cu. Ft. per Mile of Wire or Cable	Remarks ^b
Cable Assembly	CC-355 or CC-355-A	1B1455-1000 or 1B1455A-1000	0.7	750	1200	Reel DR-7	1000 ft. ^d	1410	41.7	10-pair, consists of Cable WC-535 with plug on each end; .036 in. copper, solid, each rubber covered; rubber overall, non-stabilized. TM 11-371 and TM 11-366.
Cable Stub	CC-356	1B1456	0.42	500			12 ft.			Spiral-four, consists of 12-ft. length of cable WC-548, one end only equipped with connector containing 6 millihenry load coil; 2 pairs, each conductor consists of 7-.015 in. copper strands; each conductor rubber covered; stabilized; steel braid and rubber or substitute overall. TM 11-369 and TM 11-2001.
Cable Assembly	CC-358 Shown in Fig. No. 602	1B1458	0.42	500	540	Reel DR-15	1/4 mile	700	19.2	Spiral-four, consists of 1/4-mile length of Cable WC-548, each end equipped with connector containing 6 millihenry load coil; 2 pairs, each conductor consists of 7-.015 in. copper strands; each conductor rubber covered; stabilized; steel braid and rubber or substitute overall. TM 11-369 and TM 11-2001.
Cable Assembly	CC-368	1B1468	0.42	500			100 ft.			Spiral-four, consists of 100-ft. length of Cable WC-548, each end equipped with connector, but no load coil; 2 pairs, each conductor consists of 7-.015 in. copper strands; each conductor rubber covered; stabilized; steel braid and rubber or substitute overall. TM 11-369 and TM 11-2001.
Coil	C-114-A ^c Shown in Fig. No. 603	3C114A								An 88 millihenry loading coil, with d-c resistance of 8.4 ohms, weighing approximately 3 lbs, having a water-proof phenol plastic case, about 3-1/8" x 4-1/2" x 2-5/4". Binding post terminals. FM 24-5 and TB Sig 3.

^e Wire furnished in coils is generally wrapped with paper or fiber covering and net weight and packed weight are approximately the same.

^b Stabilized insulated wires and cables are designed to minimize changes in leakage and capacitance due to moisture conditions; nonstabilized insulated wires and cables do not have this design feature.

^c Coil C-114-A is used at 1-mile intervals on Wire W-110-B and at 5/8-mile intervals on Wire W-145 to extend talking range.

^d Available in other lengths; consult Signal Corps Catalog.

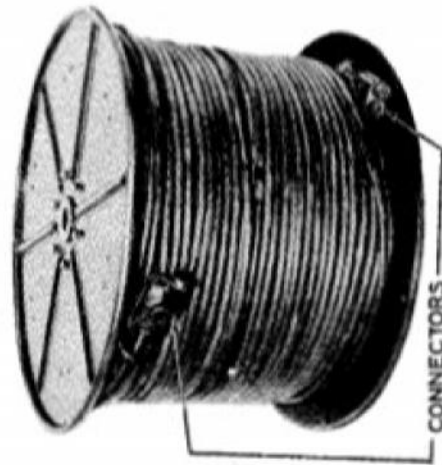

FIGURE 601. Cable Assembly
CC-345 on Reel DR-7

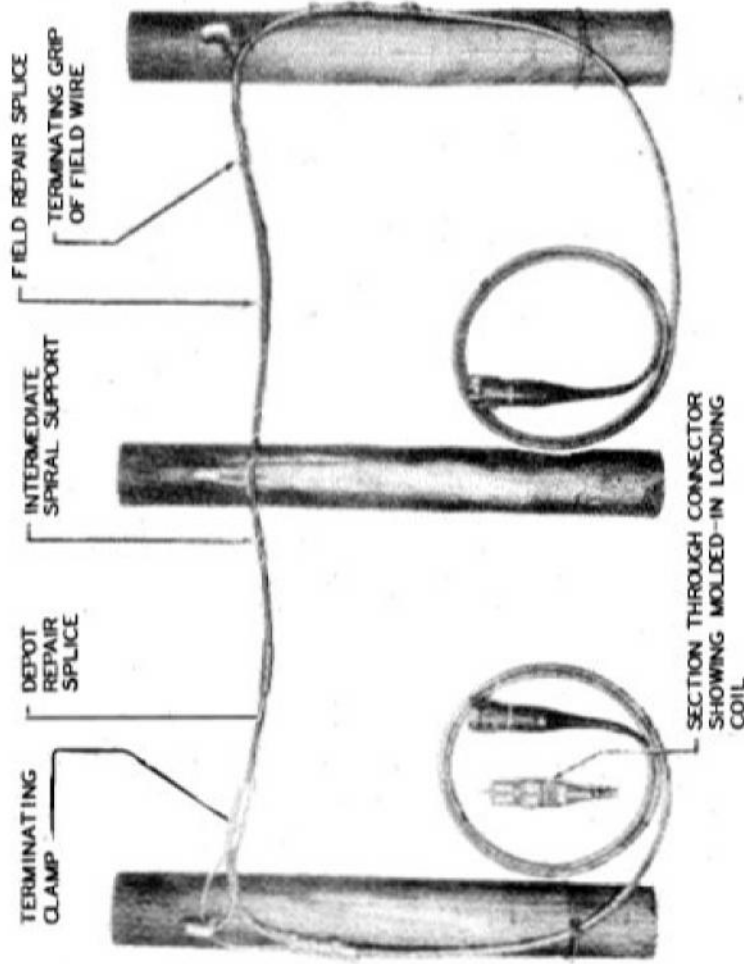

FIGURE 602. Cable Assembly CC-358
(Spiral-four Aerial Construction)



FIGURE 603. Coil
C-114-A (Loading
Coil)

615. TRANSMISSION DATA ON RUBBER INSULATED WIRES AND CABLES.

Nomenclature	Loading ^a	D.C. Resistance ^b		Capacitance mf/mi	1000-Cycle Impedance ^c Ohms	Approximate Attenuation ^b db/mi					Nonrepeated Talking Range - Miles for Net Loss of		
		Per Loop Ohms Mile	Ohms Mile			1 Kc	8 Kc	11 Kc	20 Kc	30 Kc	6 db	18 db	30 db
W-50 - Wet	Nonloaded	26	0.24	112-j81	1.0	1.9	2.1	3.0	4.2	6.	18.	30.	
W-50 - Dry	Nonloaded	26	.07	215-j147	.55	.85	.9	1.05	1.25				
W-108 - Wet	Nonloaded	180	0.24	253-j238	3.2	7.9	8.9	10.9	12.3	1.9	5.6	9.5	
W-108 - Dry	Nonloaded	180	0.13	337-j319	2.3	5.7	6.3	7.2	7.6				
W-108-A - Wet	Nonloaded	230	0.24	285-j268	3.6	9.3	10.5	13.1	15.0	1.7	5.	8.5	
W-108-A - Dry	Nonloaded	230	0.13	380-j364	2.7	6.7	7.5	8.8	9.5				
W-110-B - Wet	Nonloaded	186	0.18	300-j270	2.8	6.4	7.2	8.9	11.2	2.	6.	11.	
W-110-B - Dry	Nonloaded	186	.07	485-j440	1.7	3.7	4.0	4.6	5.2				
W-110-B - Wet	5280-88	195	0.18	775-j105	1.6	-	-	-	-	3.7	11.	19.	
W-110-B - Dry	5280-88	195	.07	1175-j180	0.8	-	-	-	-				
W-130 - Wet	Nonloaded	590	0.19	505-j475	5.0	12.5	13.5	16.0	18.5	1.2	3.6	6.0	
W-130 - Dry	Nonloaded	590	.07	890-j850	3.0	7.0	8.0	9.0	10.5				
W-130-A - Wet	Nonloaded	590	0.28	432-j372	6.5	14.5	16.5	19.0	22.0	0.9	3.	4.5	
W-130-A - Dry	Nonloaded	590	.09	775-j697	3.5	8.0	9.0	10.5	12.5				
W-130-C													
WD-3/TT	Nonloaded	590											
W-143	Nonloaded	35	0.21	130-j105	1.2	2.1	2.2	2.5	2.9	5.	15.	25.	
W-143	3300-88	48	0.21	870-j20	0.30	-	-	-	-	20.	60.	100.	
WC-548-Side	Nonloaded	71	0.12	235-j200	1.3	2.5	2.7	3.0	3.4	4.6	14.	23.	
CC-358-Side	1320-6	77	0.12	475-j105	0.75	0.85	0.95	-	-	8	24.	40.	
CC-358-Phantom	Nonloaded	39	0.27	130-j85	1.3	2.5	2.7	3.5	4.4	4.6	14.	23.	
CC-345	Nonloaded	90	0.14	240-j220	1.7	3.7	4.0	4.6	5.0	3.5	11.	18.	
CC-355-A	Nonloaded	90	0.14	240-j220	1.7	3.7	4.0	4.6	5.0	3.5	11.	18.	

Characteristics approximately the same as W-130-A

Characteristics approximately the same as W-130

^aThe type of loading is shown by a number representing the wire distance between loading coils expressed in feet, followed by a number representing the inductance of the loading coil expressed in millihenries.

^bThe data on this table apply to a temperature of about 70 F.

^cFor loaded circuits, the 1000 cycle impedance is for the mid-section point of a loading section.

616. MATERIALS FOR CONSTRUCTION OF SPIRAL-FOUR CABLE LINES.

Description	Stock Number	Quantities for 100 Miles of Line ^a					
		Aerial Line, b 4x4 Lumber Supports, 150-foot Spans, Single Cable	To Install 1 Cable on Existing Aerial Line or on Trees, 150-foot Spans	Ground Surface Line, c Single Cable	Buried Line, c Single Cable	Buried Line, c 2 Cables Placed Concurrently	
Lumber, treated, 2" x 4" x 20'	5A2705	800	-	-	-	-	
Lumber, treated, 2" x 4" x 24'	5A2724	600	-	-	-	-	
Lumber, treated, 4" x 4" x 18'	5A2718	-	-	1,000	1,000	1,000	
Lumber, treated, 4" x 4" x 20'	5A2720	3,600	-	-	-	-	
Cable Assembly ^a CC-358, 1/4 mile per Reel DR-15	1B1458	500	500	500	500	1,000	
Cable Assembly CC-368	1B1468	50	50	50	50	100	
Cable Stub CC-356	1B1456	15	15	15	15	30	
Bolt, carriage, 1/2" x 4-1/2" G.I.	5B1108-4,5	1,200	-	-	-	-	
Bolt, machine, 5/8" x 6", G.I.	5B1510-6	1,000	-	-	-	-	
Bolt, machine, 5/8" x 10", G.I.	5B1510-10	1,000	-	1,000	1,000	1,000	
Cable Hanger, per SCL Spec. No. 694	5B3459	4,400	4,400	-	-	-	
Clamp, dead end, Kearney Lay-Cit, or equal	5B3094	2,400	2,400	2,200	2,200	4,400	
Connector, bridging, W.E.Co. 2A	321402	150	150	-	-	-	
Hook PF-81, drive	5B5081	4,400	4,400	500	500	700	
Marline RP-2	626981	50 lbs.	50 lbs.	50 lbs.	50 lbs.	100 lbs.	
Nail, common wire, 12-d	811412	1,600 lbs.	-	12 lbs.	12 lbs.	12 lbs.	
Nail, common wire, 20-d	611420	300 lbs.	-	-	-	-	
Sleeve, G.S. for 109 guy wire, (S-109-Q)	6M5709-2	2,500	-	600	600	600	
Staked OP-2, rod, 3/4" x 16" x 1-1/8" head	2A3302	800	-	-	-	-	
Tale, 200 mesh, Grade A, white (Wishnick - Tuspeer, Inc., New York, N.Y., or equal)	5B20209-11	-	-	-	200 lbs.	250 lbs.	
Washer ^e , square, G.I., 2-1/4" with 11/16" hole	1B1108K	2,500	-	2,000	2,000	2,000	
Wire W-110-B	1A145	4,000 ft.	4,000 ft.	4,000 ft.	4,000 ft.	6,000 ft.	
Wire W-145, 100 GS	1A145	2,500 lbs.	-	2,000 lbs.	2,000 lbs.	2,000 lbs.	
Estimates for 100-mile unit							
Weight, short tons	206	45	79	79	125	125	
Shipping space, cubic feet	12,300	2,530	4,510	4,510	6,950	6,950	
Ship tons ^f	308	63	113	113	174	174	
Construction time, based on average terrain and weather conditions, man-days	1,030	440	315 ^c	415 ^c	550	550	

^aIncludes 25% spare Cable Assembly CC-358 and a limited amount of other spare material. Figures for aerial construction are based on cable without messenger support. Construction information covered in TM 11-359.

^bThis list includes sufficient material for 10% of structures to be of A-frame type as shown in TM 11-359.

^cAllows for 2 overhead crossings per mile without messenger support (TM 11-359) and construction time includes 130 man-days for crossings. With messenger support (paragraph 612) the following additional material is required per 200 foot crossing: 300 ft. Wire, Messenger W-503, Stock No. 1A503; 1.0 Clamps PF-61 (2 bolt), Stock No. 5B3061; 3 Clamps (dead end) for CC-358, Stock No. 5B3094. Increase in construction time is about .7 man-days per crossing.

^dWooden stakes, 2" x 4" x 30", may be substituted for Stakes GP-2.

^eWashers, round, 5B20111, may be substituted for square washers.

^fShip ton assumed equal to 40 cu. ft.

617. SPIRAL-FOUR CABLE LINES - SHIPPING DATA.

	Quantities for 100 Miles of Line (One Cable)							
	Aerial Line with 4 x 4 Lumber Supports		Aerial Installation on Existing Line		Ground Surface Line ^c		Buried Line ^c	
	Shipping		Shipping		Shipping		Shipping	
	Weight Lbs.	Space Cu. Ft.	Weight Lbs.	Space Cu. Ft.	Weight Lbs.	Space Cu. Ft.	Weight Lbs.	Space Cu. Ft.
4 x 4 Lumber Supports	314,600	9,680	-	-	-	-	-	-
Spiral-Four Cable ^a	88,400	2,440	88,400	2,440	88,400	2,440	88,400	2,440
Accessory Material	8,700	180	1,900	90	-	-	-	-
Total	411,700	12,300	90,300	2,530	88,400	2,440	88,400	2,440
Ship tons ^b	308		63		61		61	

^aThese figures include 25% spare Cable Assemblies CC-358.

^bShip ton assumed equal to 40 cu. ft.

^cAllow following for each overhead crossing (TM 11-369).
Poles and accessories; 350 lbs, 10.5 cu. ft.

Section IV
Lead-covered Cables and Loading

618. GENERAL. This section gives information concerning lead-covered cables and loading coils. It also includes placement data for aerial cable construction, examples of the materials required for 100 mile aerial cable lines and data on lead sleeves. Information concerning methods of constructing cable lines is given in TM 11-363 and in Bell System Practices. The loading coils and cases listed in this section are Western Electric Company items stocked by the Signal Corps. The mounting hardware required for installing them is included,

also. If these items do not meet the requirements for a particular job, other types may be procured. The transmission characteristics of H-88-50 and H-88-N circuits using these loading units and coils are given in chapter 7. The 204CG loading coil case and SM11 loading units have been discontinued by the manufacturer. They are replaced by the 208 type case and the MF11 loading unit, which is electrically equivalent to the SM11 unit. The case containing 12 MF11 units is the 208A, which is smaller and lighter than the 204CG case due to a more compact assembly of the loading units. When existing stocks of 204CG cases are depleted, the 208A case will be substituted.

619. LEAD-COVERED CABLES - PHYSICAL DATA AND STOCK NUMBERS.

Amer. Wire Gauge	Size	Type ^a	Stock No.	Aver. Reel Lgth. Feet	Weight Reel - Pounds	Weight of Cable Pounds	Total Weight Reel & Cable- Pounds	Shipping Space Cu.Ft.	Floor Space Sq.Ft.
<u>a. Wires Insulated with Paper</u>									
17	1 pr	T.A.	1D1017	1500	10	197	207	4	2
19	2 pr	T.A.	1D253	3000	210	2625	2835	54	12
22	2 pr	T.A.	1D1022	3000	210	2400	2610	54	12
19	10 pr	L.C.	1C401,.1	3000	304	2400	2704	51	11
		JT.	1D364.3	3000	304	2880	3184	51	11
		T.A.	1D364,.1,.2	3000	490	4500	4990	93	16
22	10 pr	L.C.	1C411,.1	3500	304	1855	2159	51	11
		JT.	1D369.2	3500	304	2205	2509	51	11
		T.A.	1D369,.1,.4	4500	418	4050	4468	73	14
19	7 qd	L.C.	1C819.6	3000	385	3000	3385	64	13
		JT.	1D719	4000	304	4800	5104	51	11
		T.A.	1D719.1	4000	522	6800	7322	104	16

^aThe first three cables (one-pair and two-pair) are insulated with rubber or substitute; all other cables are insulated with paper or paper pulp. T.A. = single tape armored (Subterranean), L.C. = lead sheath covered (aerial or subterranean with no armoring or other protection), JT. = jute protected (subterranean). Lead covered fusing cable consisting of 24 or 26 AWG conductors in the majority of sizes indicated in the above tabulation is available in short lengths as required for protection of outside plant cable as described in Section G10.340 of Bell System Practices.

Table continued on next page

LEAD-COVERED CABLES - PHYSICAL DATA AND STOCK NUMBERS. (Continued)

Amer. Wire Gauge	Size	Type ^a	Stock No.	Aver.	Weight Reel - Pounds	Weight of Cable Pounds	Total	Shipping Space Cu.Ft.	Floor Space Sq.Ft.
				Reel Lgth. Feet			Weight Reel & Cable- Pounds		
22	15 pr	L.C.	1C412,.1	3500	264	2205	2469	40	10
		JT.	1D365.3	4000	304	3024	3328	51	11
		T.A.	1D365,.1,.2	4000	418	4280	4698	73	14
19	25 pr	L.C.	1C404,.1	3000	304	3600	3904	51	11
		JT.	1D366.4	2000	304	2880	3184	51	11
		T.A.	1D366,.2,.3	2000	490	4080	4570	93	16
22	25 pr	L.C.	1C414,.2	4200	304	3150	3454	51	11
		JT.	1D371.3	3000	304	2700	3004	51	11
		T.A.	1D371,.2,.4	3000	522	3810	4332	104	16
19	13 qd	L.C.	1C819.12,-1,.11	3000	510	3600	4110	83	15
		JT.	1D366.6	3000	490	4320	4810	93	16
		T.A.	1D366,.1,.5	3000	490	6000	6490	93	16
19	50 pr	L.C.	1C407,.1	2500	385	5000	5385	64	13
		JT.	1D367.4	2000	522	4800	5322	104	16
		T.A.	1D367,.3	2000	1112	6800	7912	187	26
22	50 pr	L.C.	1C417,.2	3000	385	3300	3685	64	13
		JT.	1D355.3	2000	418	2640	3058	73	14
		T.A.	1D355,.2,.4	2000	490	6800	7290	93	16
19	27 qd	L.C.	1C819.26-1	3000	585	3000	3585	116	17
		JT.	1D367.6	2500	490	7000	7490	93	16
		T.A.	1D367.1,.5	2500	732	8500	9232	140	20
19	37 qd	L.C.	1C819.36	2000	330	5000	5330	90	15
19	100 pr	L.C.	1C409,.1	1600	418	6080	6498	73	14
		JT.	1D368.7	1000	445	4560	5005	83	15
		T.A.	1D368,.6	1000	490	5000	5490	93	16
22	100 pr	L.C.	1C419,.2	3000	445	5400	5845	83	15
		JT.	1D357,.2	3000	625	6480	7105	128	18
		T.A.	1D357,.1,.4	3000	1112	9180	10292	187	26
19	52 qd	L.C.	1C819.51-1	1500	522	5700	6222	104	16
		JT.	1D368.9	1000	304	4560	4864	51	11
		T.A.	1D368.4,.8	1500	675	7500	8775	134	19
19	200 pr	L.C.	1C452,.1	1200	418	8700	9118	73	14
		JT.	1D375.4	750	522	6525	7047	104	16
		T.A.	1D375,.3	750	585	8187	8772	116	17
22	200 pr	L.C.	1C421,.2	1600	445	4640	5085	83	15
		JT.	1D376.2	2000	732	6960	7692	140	20
		T.A.	1D376,.1,.3	2000	490	9860	10350	93	16
22	300 pr	L.C.	1C423	1400	585	4550	5135	116	17
22	400 pr	L.C.	1C425	1200	522	5100	5622	104	16
22	600 pr	L.C.	1C429	900	522	5625	6147	104	16
22	900 pr	L.C.	1C429-900	650	625	5499	6124	128	18

b. Wires Insulated with Textile

22	10 pr	L.C.	1C822.10-2	3500	120	1120	1240	22	6
22	15 pr	L.C.	1C822.25-1	3500	304	1785	2089	51	11
22	50 pr	L.C.	1C822.50-2	2500	304	2350	2654	51	11
22	100 pr	L.C.	1C822.100-2.1	2500	418	3560	3978	73	14
22	150 pr	L.C.	1C822.150	1600	418	2976	3394	73	14
22	200 pr	L.C.	1C822.200-4	1500	445	4395	4840	83	15

^aThe first three cables (one-pair and two-pair) are insulated with rubber or substitute; all other cables are insulated with paper or paper pulp. T.A. = single tape armored (Subterranean), L.C. = lead sheath covered (aerial or subterranean with no armoring or other protection), JT. = jute protected (subterranean). Lead covered fusing cable consisting of 24 or 26 AWG conductors in the majority of sizes indicated in the above tabulation is available in short lengths as required for protection of outside plant cable as described in Section G10.340 of Bell System Practices.

620. VOICE FREQUENCY LEAD-COVERED CABLE LOADING EQUIPMENT - DESCRIPTION.

Loading Coil Case No. (Western Electric Co. Code)	Number of Loading Units or Coils ^a	Weight Lbs.	Dimensions - Inches ^b	Installation Practices	Remarks ^c	
204CG	604	12 Units	370	9-1/2 x 12 x 29 high	A.T. & T. ^d Co. Specification 4860 Supplement E	Welded steel case for underground use. Installed on manhole floor. Complete with 10 ft. cable stub. Equipped with No. SML1 loading units for H-88-50 phantom group loading on quadded cables. Replaced by 206A. Loading Unit Data Inductance Resistance - Ohms <u>Millihenries</u> <u>D.C.</u> <u>1000 Cycles</u> Side Ckt. 88. 7.9 9.1 Phantom Ckt. 50. 4.0 4.5 Resistance includes coil plus 7-1/2 ft. of cable stub.
206A	605	12 Units	95	8-5/8 diam. x 12-1/4		Welded steel case for underground use. Installed on manhole floor or wall. Complete with 10 ft. cable stub. Equipped with No. SML1 loading units, electrically equivalent to SML1 loading units. Replaces 204CG.
124A	-	15 Coils	15	3-7/8 diam. x 6-7/8	A.T. & T. Co. Specification 4860 Supplement E	Lead sleeve case for aerial or underground use. Installed on cable messenger wire, on poles, or in manholes. Complete with 10 ft. cable stub. Equipped with No. 632 loading coils for H-88 loading on nonphantomed cable pairs: Loading Coil Data: Inductance 88 mh; D.C. resistance 9.0 ohms; 1000-cycle resistance 10.4 ohms. Resistance includes coil plus 7-1/2 ft. of cable stub.
124B	-	26 Coils	25	3-7/8 diam. x 10-3/8	A.T. & T. Co. Specification 4860 Supplement E	Same as 124A except larger size.
124C	606	51 Coils	40	3-7/8 diam. x 17-3/4	A.T. & T. Co. Specification 4860 Supplement E	Same as 124A except larger size.
125A	607	101 Coils	85	5-3/8 diam. x 16-1/4	Bell System Practice Section G52.160	Welded steel case for aerial use. Installed on poles. Complete with 10 ft. cable stub. Coils same as for 124A.

^aUnits are assemblies of 3 coils for loading a phantom and its two side circuits. Coils are nonphantom type. Only the loading coil cases containing complements indicated are stocked. The same cases may be procured with a fewer number of coils than those indicated. Individual coils or units are not stocked.

^bDimensions of loading pot, not including stub cable.

^cCoil codes are Western Electric Co. code numbers.

^dThe 204CG case is not shown specifically but similar cases are shown which will illustrate installation.



FIGURE 604. Loading Coil Case 204CG
(Western Electric Co.)

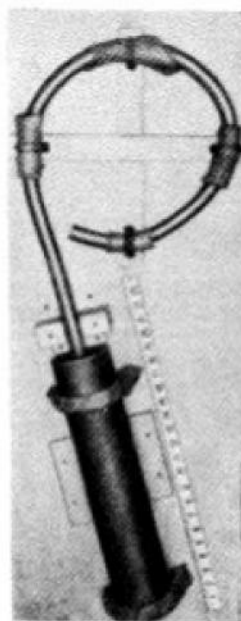

FIGURE 606. Loading Coil Case 124C
(Western Electric Co.)

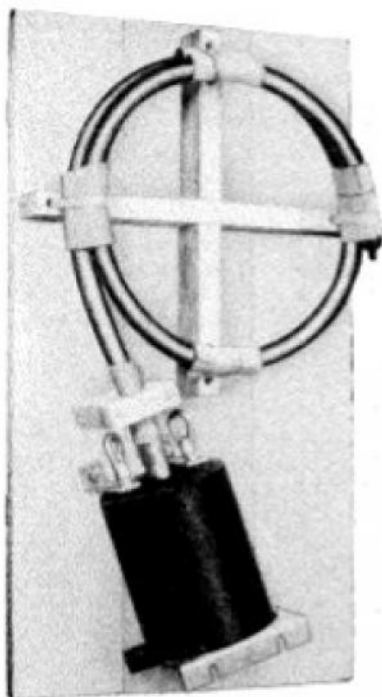

FIGURE 605. Loading Coil Case 208A
(Western Electric Co.)

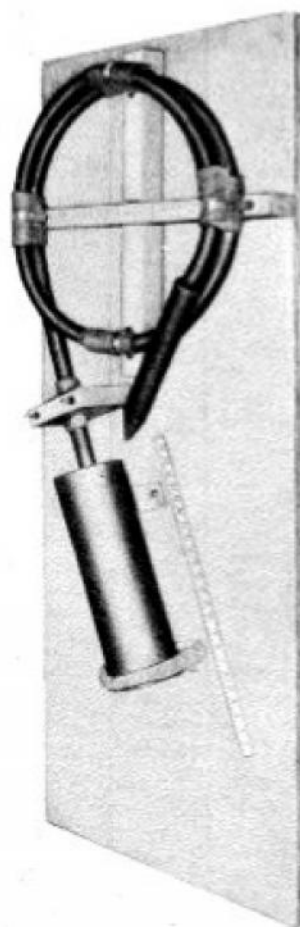

FIGURE 607. Loading Coil Case 125A
(Western Electric Co.)

621. LOADING EQUIPMENT FOR VOICE-FREQUENCY CABLE CIRCUITS - STOCK NUMBERS AND LOGISTICAL DATA.

Loading Coil Case No.		Weight - Pounds		Volume - Cubic Feet		Loading Coil Case No.		Weight - Pounds		Volume - Cubic Feet	
Western Electric Co. Code	Stock Number	Packed for Export	Packed for Export	Packed for Export	Packed for Export	Western Electric Co. Code	Stock Number	Packed for Export	Packed for Export	Packed for Export	Packed for Export
204CG	48330	450	15			124B	None	85	10		
208A	-	180	15			124C	None	100	10		
124A	None	75	10			125A	None	175	15		

622. MOUNTING HARDWARE FOR LOADING COIL CASES.

Loading Coil Case No. Western Electric Co. Code	Mounting Hardware ^a	
	Underground Installations	Aerial Installations
204CG	Place on manhole floor: None	
208A	When placed on floor: Two 1/2" x 2-1/2" expansion bolts. When attached to manhole walls: Four 1/2" x 2-1/2" expansion bolts	
124A	For attachment to manhole walls:	For attachment to cable messenger:
124B	2 No. 56 cable straps. Four 1/4" x 1" hammer drive anchors	2 Aerial cable supports.
124C		For attachment to poles: 2 No. 56 cable straps. Four 3/16" x 2" strap nails.
125A		For attachment to poles: Four 1/2" x 4-1/2" drive screws.

^aAll codes referred to are Western Electric Co. codes.

623. TRANSMISSION DATA ON LEAD-COVERED CABLES.

Amer. Wire Gauge	Type of Loading ^a	D.C. ^b Resistance		1000-Cycle Impedance ^{b,c}	Approximate Attenuation db/mi			Nonrepeated Talking Range - Miles for Net Loss of		
		Ohms per Loop Mile	Capacitance mf/mi		1 Kc	8 Kc	30 Kc	6 db	18 db	30 db
16	side NL	42	.062	255-j214	0.73	1.36	1.87	8	25	41
16	side 6000-88	50	.062	1165-j50	0.19	-	-	32	95	155
19	side NL	86	.062	345-j317	1.08	2.37	3.07	5.5	16.5	28
19	side 6000-88	94	.062	1160-j110	0.36	-	-	17.0	50	85
19	pair NL	86	.066	333-j308	1.11	-	-	5.4	16.0	27
19	pair NL	86	.084	295-j273	1.26	-	-	4.8	14.5	24
22	pair NL	171	.082	416-j399	1.79	-	-	3.4	10.2	17
24	pair NL	274	.072	558-j542	2.14	-	-	2.8	8.5	14
24	pair NL	274	.084	517-j503	2.31	-	-	2.6	7.9	13

^a NL indicates nonloaded. The type of loading is shown by a number representing the wire distance between loading coils expressed in feet followed by a number representing the inductance of the loading coil expressed in millihenries.

^b The data in this table apply at a temperature of 70°F.

^c For loaded circuits, the 1000-cycle impedance is for the midsection point of a loading section.

624. MATERIALS FOR CONSTRUCTION OF AERIAL CABLE LINES - 150-FOOT SPANS - ALL STORM LOADING AREAS.

Description	Stock Number	Quantities ^a		Description	Stock Number	Quantities ^a	
		for 100-Miles of Line				for 100-Miles of Line	
a. Diameters of Cable up to 1-3/16 inches.							
Wire W-71	1A71	50 lbs.		Brace PF-4	5B2104	50	
Wire W-90	1A90	20,000 ft.		Brace PF-7	5B2107	80	
Wire W-115	1A115	574,400 ft.		Clamp, cable; 5/16"	5B3105	1,000	
Wire W-116	1A116	2,500 ft.		Clamp, cable 7/16"	5B3107	1,000	
Wire #12 BWC, G.I.	1AB12	58,080 ft.		Clamp, cable 1/2"	5B3108	500	
Wire, #6 weatherproof triple braid, solid h.d.	1B906.1	1,000 ft.		Clamp, cable 11/16"	5B3111	500	
Insulator, porcelain; Thomas #502	3G1875-502	100		Clamp, cable 3/4"	5B3112	500	
Insulator, porcelain; Thomas #504	3G1875-504	100		Clamp, cable 1-1/4"	5B3120	500	
Block, protector, carbon; W.E.Co. #26	4E926	200		Clamp, cable 1-1/2"	5B3124	100	
Block, protector, W.E.Co. #30	4E930	200		Clamp, cable 1-3/4"	5B3128	100	
Step, pole; wood, 1-3/4 x 2-3/4 x 7"	5A3710	1 per term.		Clamp, cable, grade type B adjustable	5B3190	600	
Anchor AH-2	5B102	350	as req	Clamp, cable corner suspension #8902	5B3202	300	
Anchor AH-9	5B109	400		Clamp, cable suspension 3-bolt	5B3203	3,800	
Anchor AH-10	5B110	50		Clamp, ground; strand, Hubbard #8956 or equal	5B3349	400	
Anchor Rod AH-6-A	5B706A	425		Clamp FT-56, 3-bolt guy clamp	5B3450	2,500	
Anchor Rod AH-7-A	5B707A	375		Connector, strand	5B4210	270	
Anchor Rod AH-8-A	5B708A	60		Eye-nut, thimbleye G.I. for 5/8" bolt	5B4305	300	
Anchor bolt, Rock guy Hubbard 7547-T	5B816-15	50		Eye-nut, thimbleye G.I. for 3/4" bolt	5B4306	150	
Anchor bolt, Rock guy Type D	NSN	50		Eye-nut, thimbleye G.I. for 1" bolt	5B4308	50	
Bolt, double arming, 5/8 x 10" G.I.	5B1210-10	100		Ground Rod GP-26	5B4426	30	
Bolt, double arming, 5/8 x 12" G.I.	5B1210-12	100		Hook, guy, "J", 4"	5B5284	150	
Bolt, double arming, 5/8 x 14" G.I.	5B1210-14	25		Link, reinforcing, 8-3/8" long	5B5808.8	100	
Bolt, double arming, 5/8 x 16" G.I.	5B1210-16	25		Link, reinforcing, short	NSN	100	
Bolt, double arming, 5/8 x 18" G.I.	5B1210-18	25		Nut, square, G.I. for 5/8" Standard Machine bolt	5B6510	4,000	
Bolt, double arming, 5/8 x 20" G.I.	5B1210-20	25		Plate, strain; G.I. 4" x 8"	5B8504-8	200	
Bolt, eye; 3/8 x 6", G.I.	5B1306-6	75		Protector, guy wire 8'	5B8608	100	
Bolt, eye; 5/8 x 12", G.I.	5B1310-12	150		Ring PF-63	5B9435	345,000	
Bolt, eye; 5/8 x 14", G.I.	5B1310-14	50				4 per	
Bolt, eye; 3/4 x 10", G.I.	5B1312-10	50		Screw, lag G.I. 1/4 x 2-1/2"	5B10004-2.5	Term.	
Bolt, eye; 3/4 x 12", G.I.	5B1312-12	50		Screw, lag G.I. 1/2 x 4-1/2"	5B10008-4.5	1,300	
Bolt, eye; 1 x 12", G.I.	5B1316-12	10		Screw, wood, #14, 2" RH G.I.	5B14014-16	24 doz.	
Bolt, bent eye; 5/8 x 10" G.I.	5B1410-10	275		Serviseeve for 5/16" strand	5B15500	2,500	
Bolt, bent eye; 5/8 x 12" G.I.	5B1410-12	75		Staple, G.I. 1-1/2"	5B17001.5	1,500	
Bolt, bent eye; 3/4 x 10" G.I.	5B1412-10	150				12 per	
Bolt, bent eye; 3/4 x 14" G.I.	5B1412-14	50		Step PF-37	5B17137	Term.	
Bolt, machine; 1/2 x 4-1/2" G.I.	5B1508-4.5	75		Strap, reinforcing, Hubbard #8905 or equal	5B17505	100	
Bolt, machine; 1/2 x 6" G.I.	5B1508-6	50		Strap, storm guy, Graybar #6006	5B17508	50	
Bolt, machine 5/8 x 6" G.I.	5B1510-6	125		Strap, storm guy, Hubbard #6005	5B17508-1	50	
Bolt, machine 5/8 x 8" G.I.	5B1510-8	550		Strap, guy, flat G.I.	5B17591	250	
Bolt, machine 5/8 x 10" G.I.	5B1510-10	3300		Strap, wall, guy eye G.I.	5B17595	20	
Bolt, machine 5/8 x 12" G.I.	5B1510-12	550		Support, Aerial cable #1, 10"	5B17841	12,000	
Bolt, machine 5/8 x 14" G.I.	5B1510-14	125		Support, Aerial cable #2, 16"	5B17842	2,000	
Bolt, machine 5/8 x 16" G.I.	5B1510-16	125		Support, Aerial cable #3, 22"	5B17843	2,000	
Bolt, machine 5/8 x 18" G.I.	5B1510-18	75					

^a Poles not included. Data on round poles is given in paragraphs 631 and 632.

Description	Stock Number	Quantities ^a		Description	Stock Number	Quantities ^a	
		for 100-Miles of Line				for 100-Miles of Line	
Thimble PF-42	5B18042	50		Terminal box JB-13	5C2713	As required	
Thimble PF-43	5B18043	50		Terminal Box F10	5C35107	As required	
Thimble PF-44	5B18044	50		Nail, common wire 6-d	6L1406	100 lbs.	
Washer PF-77	5B20077	50		Nail, common wire 30-d	6L1430	100 lbs.	
Washer PF-78	5B20078	50		Nail, common wire 60-d	6L1460	100 lbs.	
Washer PF-79	5B20079	9,000		Nail, roofing, #3	6L2003	100 lbs.	
Washer, round, G.I.	5B20109	200		Ribbon, bonding, copper, 3/8" wide, #16 H&S	6N4903	1,000 ft.	
Washer, square, G.I. Hubbard #7817 or equal	5B20212-13	60		Tape, TL-83	6N8583	100 rolls	
Washer, curved, G.I., for 5/8" bent eye bolt	5B20310	750		Tape, friction; 2" wide, 36 yard roll	6N8832-36	100 rolls	
Washer, round, G.I.	5B20311	100		Tape, lead serving National Lead Co. or equal	6N8835	700	
Washer, curved, G.I., for 3/4" bent eye bolt	5B20312	700		Anchor, Hammer drive G.I. 1/4 x 1"	6Z284-4	500	
Washer, curved, G.I., for 1" bent eye bolt	5B20316	50		Anchor, Hammer drive G.I. 1/4 x 1-1/4"	6Z284-5	500	
Protector, telephone, line 5-pair	5C2200	10		Anchor, screw, iron, 3/8 x 2"	6Z306-8	100	
Terminal Cable (W.E.Co. ED-102)	5C2502	As required		Marline, 3 ply; 5 pound balls	6Z6985	60 lbs.	
Terminal Cable F26	5C2526	As required					
Terminal box JB-10	5C2710	As required					
Terminal box JB-11	5C2711	As required					

b. Diameters of Cable from 1-1/4" to 1-15/16".

Wire W-71	1A71	50 lbs.		Bolt, eye; 3/4 x 12" G.I.	5B1312-12	10	
Wire W-90	1A90	574,000 ft.		Bolt, eye; 3/4 x 14" G.I.	5B1312-14	10	
Wire W-115	1A115	2,500 ft.		Bolt, eye; 1 x 12" G.I.	5B1316-12	150	
Wire W-116	1A116	25,000 ft.		Bolt, eye; 1 x 14" G.I.	5B1316-14	50	
Wire W-145	1A145	52,800 ft.		Bolt, bent eye; 5/8 x 10" G.I.	5B1410-10	50	
Wire, #12 HWC, G.I.	1A812	5,280 ft.		Bolt, bent eye; 5/8 x 12" G.I.	5B1410-12	25	
Wire, #6, weatherproof, triple braid, solid h.d.	1B806.1	1,000 ft.		Bolt, bent eye; 3/4 x 10" G.I.	5B1412-10	275	
Insulator, porcelain; Thomas #502	3G1875-502	100		Bolt, bent eye; 3/4 x 14" G.I.	5B1412-14	75	
Insulator, porcelain; Thomas #504	3G1875-504	100		Bolt, bent eye; 1 x 10" G.I.	5B1416-10	25	
Block, protector, carbon; W.E.Co. #26	4E926	200		Bolt, bent eye; 1 x 12" G.I.	5B1416-12	150	
Block, protector, W.E.Co. #30	4E930	200		Bolt, bent eye; 1 x 14" G.I.	5B1416-14	75	
Step, pole; wood, 1-3/4 x 2-3/4 x 7"	5A3710	1 per term.	as req.	Bolt, machine; 1/2 x 4-1/2" G.I.	5B1508-4.5	75	
Anchor AH-2	5B102	50		Bolt, machine; 1/2 x 6" G.I.	5B1508-6	50	
Anchor AH-9	5B109	350		Bolt, machine; 5/8 x 6" G.I.	5B1510-6	125	
Anchor AH-10	5B110	400		Bolt, machine; 5/8 x 8" G.I.	5B1510-8	550	
Anchor Rod AH-6-A	5B706A	60		Bolt, machine; 5/8 x 10" G.I.	5B1510-10	3,300	
Anchor Rod AH-7-A	5B707A	360		Bolt, machine; 5/8 x 12" G.I.	5B1510-12	550	
Anchor Rod AH-8-A	5B708A	420		Bolt, machine; 5/8 x 14" G.I.	5B1510-14	125	
Anchor bolt, Rock guy Hubbard 7547-T	5B816-15	50		Bolt, machine; 5/8 x 16" G.I.	5B1510-16	125	
Anchor bolt, Rock guy Type D	NSN	50		Bolt, machine; 5/8 x 18" G.I.	5B1510-18	75	
Bolt, double arming, 5/8 x 10" G.I.	5B1210-10	100		Brace PF-4	5B2104	50	
Bolt, double arming, 5/8 x 12" G.I.	5B1210-12	100		Brace PF-7	5B2107	80	
Bolt, double arming, 5/8 x 14" G.I.	5B1210-14	25		Clamp, cable; 5/16"	5B3105	1,000	
Bolt, double arming, 5/8 x 16" G.I.	5B1210-16	25		Clamp, cable; 7/16"	5B3107	1,000	
Bolt, double arming, 5/8 x 18" G.I.	5B1210-18	25		Clamp, cable; 1/2"	5B3108	500	
Bolt, double arming, 5/8 x 20" G.I.	5B1210-20	25		Clamp, cable; 11/16"	5B3111	500	
Bolt, eye; 3/8 x 6" G.I.	5B1306-6	75		Clamp, cable; 3/4"	5B3112	500	
Bolt, eye; 3/4 x 10" G.I.	5B1312-10	20		Clamp, cable; 1-1/4"	5B3120	500	
				Clamp, cable; 1-1/2"	5B3124	100	
				Clamp, cable; 1-3/4"	5B3128	100	
				Clamp, cable grade, Hubbard #8986	5B3186	400	
				Clamp, cable grade, Hubbard #8987	5B3187	200	
				Clamp, cable, corner suspension #8902	5B3202	300	

^a Poles not included. Data on round poles is given in paragraphs 631 and 632.

Table continued on next page

MATERIALS FOR CONSTRUCTION OF AERIAL CABLE LINES - 150-FOOT SPANS - ALL STORM LOADING AREAS. (Continued)

Description	Stock Number	Quantities ^a		Description	Stock Number	Quantities ^a	
		for 100-Miles of Line				for 100-Miles of Line	
Clamp, cable suspension, 3-bolt	5B3203	3,000		Thimble PF-43	5B18043	50	
Clamp, ground; strand, Hubbard #8956 or equal	5B3349	400		Thimble PF-44	5B18044	50	
Clamp FT-56, 3-bolt guy	5B3450	3,500		Washer PF-77	5B20077	50	
Connector, strand	5B4210	270		Washer PF-78	5B20078	50	
Eye-nut, thimbleye G.I. for 3/4" bolt	5B4306	50		Washer PF-79	5B20079	9,000	
Eye-nut, thimbleye G.I. for 1" bolt	5B4308	300		Washer, round, G.I.	5B20109	200	
Ground Rod GP-26	5B4426	30		Washer, square, G.I., Hubbard #7817 or equal	5B20212-13	60	
Hook, guy, "J", 4"	5B5284	150		Washer, curved, G.I., for 5/8" bent eye bolt	5B20310	150	
Link, reinforcing, 8-3/8" long	5B5808.8	100		Washer, round, G.I.	5B20311	100	
Link, reinforcing, short	NSN	100		Washer, curved, G.I., for 3/4" bent eye bolt	5B20312	400	
Nut, square, G.I. for 5/8" standard machine bolt	5B6510	4,000		Washer, curved, G.I. for 1" bent eye bolt	5B20316	650	
Plate, strain; G.I. 4 x 8"	5B8504-8	200		Protector, telephone, line 5-pair	5C2200	10	
Protector, guy wire 8 foot	5B8608	100		Terminal BD-102	5C2502	As required	
Ring PF-69	5B9456	345,000		Terminal F-26	5C2526	As required	
Screw, lag G.I. 1/4 x 2-1/2"	5B10004-2.5	4 per Term.		Terminal box JB-10	5C2710	As required	
Screw, lag G.I. 1/2 x 4-1/2"	5B10008-4.5	1,300		Terminal box JB-11	5C2711	As required	
Screw, wood, #14, 2" RH G.I.	5B14014-16	24 doz.		Terminal box JB-13	5C2713	As required	
Staple, G.I. 1-1/2"	5B17001.5	1,500		Terminal F-10	5C3510F	As required	
Step PF-37	5B17137	12 per Term.		Nail, common wire 6-d	6L1406	100 lbs.	
Strap, reinforcing, Hubbard #8905 or equal	5B17505	4,000		Nail, common wire 30-d	6L1430	100 lbs.	
Strap, storm guy, Graybar #6006	5B17508	50		Nail, common wire 60-d	6L1460	100 lbs.	
Strap, storm guy, Hubbard #6005	5B17508-1	50		Nail, roofing, #3	6L2003	100 lbs.	
Strap, guy, flat G.I.	5B17591	550		Ribbon, bonding, copper, 3/8" wide, #16 B&S	6N4903	1,000 ft.	
Support, Aerial cable #3, 22"	5B17843	16,000		Tape, TL-83	6N8583	100 rolls	
Thimble PF-42	5B18042	50		Tape, friction; 2" wide 36 yard roll	6N8832-36	100 rolls	
				Anchor, Hammer drive G.I. 1/4 x 1"	6Z284-4	500	
				Anchor, Hammer drive G.I. 1/4 x 1-1/4"	6Z284-5	500	
				Anchor, screw, iron, 3/8" x 2"	6Z306-8	100	
				Marline, 3 ply; 5 pound balls	6Z6985	60 lbs.	

^a Poles not included. Data on round poles is given in paragraphs 631 and 632.

625. LEAD SLEEVES FOR STRAIGHT SPLICES.

No. of Pairs in Cable	Size of Sleeve ^a - Inches		No. of Pairs in Cable	Size of Sleeve ^a - Inches	
	19 Gauge Cable	22 Gauge Cable		19 Gauge Cable	22 Gauge Cable
16	3/4 x 15	3/4 x 15	202	2-3/4 x 20	2-1/4 x 17
26	1 x 15	1 x 15	303	3-1/2 x 20	2-3/4 x 20
51	1-1/2 x 15	1-1/4 x 15	404	4 x 20	3 x 20
76	1-3/4 x 17	1-1/2 x 15	450		3 x 20
101	2 x 17	1-1/2 x 15	606		3-1/2 x 20
152	2-1/4 x 20	2 x 17	909		4 x 20

^a Stock numbers of standard sizes of lead sleeves and sleeving are given in paragraph 627.

626. LEAD SLEEVES FOR BRIDGE SPLICES.

No. of Pairs in Main Cable	Number of Pairs in Branch Cable										
	16	26	51	76	101	152	202	303	404	606	909

a. Size of Sleeves^a (Inches) for 22 Gauge Main Cable - 22 or 24 Gauge Branch Cables.

26	1-1/4 x 15	1-1/2 x 15										
51	1-1/2 x 15	1-1/2 x 15	1-3/4 x 17									
76	1-1/2 x 15	1-1/2 x 15	1-3/4 x 17	2 x 17								
101	1-3/4 x 17	1-3/4 x 17	2 x 17	2 x 17	2 x 17							
152	2 x 17	2 x 17	2-1/4 x 17	2-1/4 x 17	2-1/4 x 17	2-1/2 x 20						
202	2-1/4 x 17	2-1/4 x 17	2-1/2 x 20	2-1/2 x 20	2-1/2 x 20	2-3/4 x 20	3 x 20					
303	2-3/4 x 20 ^b	2-3/4 x 20 ^b	3 x 20	3 x 20	3 x 20	3-1/2 x 20	3-1/2 x 20	3-1/2 x 20				
404	3 x 20 ^b	3 x 20 ^b	3-1/2 x 20	3-1/2 x 20	3-1/2 x 20	4 x 20	4 x 20	4 x 20	4 x 20			
606	3-1/2 x 20 ^b	3-1/2 x 20 ^b	4 x 20	4 x 20	4 x 20	4-1/2 x 22	4-1/2 x 22	4-1/2 x 22	4-1/2 x 22	5 x 22	5 x 22	5-1/2 x 22
909	4 x 20 ^b	4 x 20 ^b	4 x 20	4 x 20	4 x 20	4-1/2 x 22	4-1/2 x 22	4-1/2 x 22	4-1/2 x 22	5 x 22	5 x 22	5-1/2 x 22

b. Size of Sleeves^a (Inches) for 19 Gauge Main Cable - 19 or 22 Gauge Branch Cables.

26	1-1/2 x 15	1-1/2 x 15										
51	1-1/2 x 10 ^c	1-3/4 x 17 ^c	1-3/4 x 17 ^c	2 x 17	2 x 17 ^c							
76	1-3/4 x 17 ^c	1-3/4 x 17 ^c	2 x 17	2 x 17	2 x 17 ^c							
101	2 x 17	2-1/4 x 17	2-1/4 x 17	2-1/2 x 20	2-1/2 x 20							
152	2-1/2 x 20	2-1/2 x 20	2-3/4 x 20	2-3/4 x 20 ^c	3 x 20							
202	2-3/4 x 20 ^b	2-3/4 x 20 ^b	3 x 20	3 x 20 ^c	3-1/2 x 20	3-1/2 x 20						
303	3-1/2 x 20 ^b	3-1/2 x 20 ^b	4 x 20	4 x 20	4 x 20	4 x 20	4 x 20	4 x 20	4 x 20	4 x 20 ^c		
404	4 x 20 ^b	4 x 20 ^b	4 x 20	4 x 20	4 x 20	4-1/2 x 22	4-1/2 x 22	4-1/2 x 22	4-1/2 x 22	4-1/2 x 22 ^c		

c. Size of Sleeves^a (Inches) for 24 Gauge Cables - Main and Branch.

26	1-1/4 x 15	1-1/4 x 15										
51	1-1/2 x 15	1-1/2 x 15	1-1/2 x 15	1-3/4 x 17								
76	1-1/2 x 15	1-1/2 x 15	1-3/4 x 17	1-3/4 x 17	2 x 17							
101	1-1/2 x 15	1-3/4 x 17	1-3/4 x 17	1-3/4 x 17	2 x 17	2-1/4 x 17	2-1/2 x 20					
152	1-3/4 x 17	1-3/4 x 17	2 x 17	2 x 17	2 x 17	2-1/4 x 17	2-1/2 x 20	2-3/4 x 20				
202	2 x 17	2 x 17	2-1/4 x 17	2-1/4 x 17	2-1/4 x 17	2-1/2 x 20	2-3/4 x 20	3 x 20	3-1/2 x 20	3-1/2 x 20		
303	2-1/4 x 17	2-1/4 x 17	2-1/2 x 20	2-1/2 x 20	2-3/4 x 20	3 x 20	3-1/2 x 20	3-1/2 x 20	3-1/2 x 20	3-1/2 x 20	3-1/2 x 20	
404	3 x 20 ^b	3 x 20 ^b	3 x 20	3 x 20	3 x 20	4 x 20	4 x 20	4 x 20	4 x 20	4 x 20	4 x 20	4-1/2 x 22
606	3-1/2 x 20 ^b	3-1/2 x 20 ^b	4 x 20 ^b	4 x 20 ^b	4 x 20	4-1/2 x 22	4-1/2 x 22	4-1/2 x 22	4-1/2 x 22	4-1/2 x 22	4-1/2 x 22	5 x 22
909	4 x 20 ^b	4 x 20 ^b	4 x 20 ^b	4 x 20 ^b	4 x 20	4-1/2 x 22	4-1/2 x 22	4-1/2 x 22	4-1/2 x 22	4-1/2 x 22	4-1/2 x 22	5 x 22
1212												5 x 22

^aStock numbers of standard sizes of lead sleeves and sleeving are given in paragraph 627.

^bSleeve should be decreased to next smaller size when main cable is not to be cut.

^cSleeve should be increased to next larger size when branch cable is 19 gauge.

627. MATERIALS FOR SPLICING LEAD COVERED CABLES.

Description	Stock Number	Unit	Description	Stock Number	Unit
Wire W-107 (lashing wire)	1A107	Spool	Sleeve, splicing, cotton,		
Wire, #12 AWG, tie, copper			3/32 x 3-1/4", waxed punched		
080, 17" long	1A812.6	Each	and cut (900)	GN6006	Carton
Wire, lead lashing, diameter			Sleeve FT-96 (1/8")	GN6008	Carton
.063-.073"	1A890	Foot	Sleeve FT-97 (400 5/32 SW)	GN6010	Carton
Clamp, cable 7/16"	5B3107	Each	Sleeve, splicing cotton,		
Clamp, cable 1/2"			double wall, 5/32 x 3-1/4"		
(16 pr-22, 26 pr-26)	5B3108	Each	no tracer waxed punched		
Clamp, cable 5/8"			and cut (300)	GN6010.1	Carton
(26 pr-22, 26 pr-24, 51 pr-26)	5B3110	Each	Sleeve, splicing cotton,		
Clamp, cable 11/16" (26 pr-22,			double wall, 5/32 x 3-1/4",		
51 pr-24, 51 & 96 pr-26)	5B3111	Each	black tracer waxed,		
Clamp, cable, 3/4" (26-22,			punched and cut (300)	GN6010.2	Carton
51-24, 51 & 76-26)	5B3112	Each	Sleeve FT-98 (1/4 x 3-1/4"		
Clamp, cable, 1-1/4"			225)	GN6016	Carton
(101 & 152-22, 152 & 202-24,			Sleeve, splicing, cotton,		
202 & 303-26)	5B3120	Each	double wall, 1/4 x 3-1/4"		
Clamp, cable, 1-1/2"			no tracer waxed punched		
(202-22, 303-24, 404-26)	5B3124	Each	and cut (150)	GN6016.1	Carton
Clamp, cable, 1-3/4" (303-22,			Sleeve, splicing, cotton,		
404-455-24, 606-26)	5B3128	Each	double wall, 1/4 x 3-1/4",		
Clamp, ground strand,			black tracer waxed,		
Hubbard #0956 or equal	5B3349	Each	punched and cut (150)	GN6016.2	Carton
Desiccant for drying cable			Sleeve, lead; 3/4 x 15"	GN6475-15	Each
Splices	6G250	Can	Sleeve, lead; 3 x 18"	GN6503-18	Each
Desiccant, air-tight can			Sleeve, lead; 4-1/2 x 22"	GN6504.5-22	Each
silica gel.	6G250-2	Can	Sleeve, lead; 5 x 24"	GN6505-24	Each
Oil, splicing, cold stripping			Sleeving, lead; 1/2"	GN7000-5	Foot
(1 gallon)	6G1389	Gallon	Sleeving, lead; 1-3/4"	GN7001-7	Foot
Paint, asphaltum, black			Sleeving, lead; 2-1/2"	GN7002-5	Foot
(1 gallon)	6G1410	Can	Sleeving, lead; 3"	GN7003	Foot
Bandage TL-97 (3 x 10 yards)	GN597	Roll	Solder M-30 (50-50)	GN7530	Pound
Bandage, Muslin, unbleached,			Solder M-31 (resin core)		
4" wide, 10 yards long	GN604-10	Roll	(1 lb.)	GN7531	Pound
Bandage, rubber, insulating,			Solder M-33 (40-60)	GN7533	Pound
4" wide, 14 foot roll	GN634-14	Roll	Solder, wire, half and half		
Cloth, cable wrapping; cotton			#10	GN7600	Pound
waterproof approx. 24 x 18"	GN1620	Each	Stearine compound IC-3		
Cloth, cable wrapping; cotton			(1/4 lb. st.)	GN8003	Pound
waterproof approx. 25 x 40"	GN1621	Each	Tape TL-83 (3/4")	GN8583	Roll
Cloth, cotton, unbleached,			Tape TL-94 (3/4" R)	GN8594	Roll
36" wide, 6.5 ounce per sq.yd.	GN1636	Yard	Tape TL-109 (1" cot)	GN8609	Roll
Paraffin Wax IC-4	GN4004	Pound	Tape, friction; 2" wide,		
Paste, soldering, 2 ounce cans	GN4102	Can	36 yard roll	GN8832-36	Roll
Paster MC-73-A	GN4273A	Roll	Anchor, Hammer drive G.I.		
Ribbon, bonding copper 3/8"			1/4" x 1"	62284-4	Each
wide #15 B&S gauge	GN4903	Foot	Anchor, Hammer drive G.I.		
Sleeve FT-75 (1")	GN5575	Each	1/4" x 1-1/4"	62284-5	Each
Sleeve FT-76 (1-1/4")	GN5576	Each	Marline, 3-ply, 5 pound		
Sleeve FT-77 (1-1/2")	GN5577	Each	balls	GN6985	Pound
Sleeve FT-78 (1-3/4")	GN5578	Each	Wedge, lead cable, for		
Sleeve FT-79 (2")	GN5579	Each	Y joints, W.E.Co. #1	629430	Each
Sleeve FT-80 (2-1/4")	GN5580	Each	Wedge, lead cable, for		
Sleeve FT-81 (2-1/2")	GN5581	Each	Y joints, W.E.Co. #2	NSN	Each
Sleeve FT-82 (2-3/4")	GN5582	Each	Wedge, lead cable, for		
Sleeve FT-83 (3")	GN5583	Each	Y joints, W.E.Co. #3	NSN	Each
Sleeve FT-84 (3-1/2")	GN5584	Each	Wedge, lead cable, for		
Sleeve FT-85 (4")	GN5585	Each	Y joints, W.E.Co. #4	FTNP-629430-4	Each
Sleeve, splicing tinned,			Wedge, lead cable, for		
single tube copper #13 AWG,			Y joints, W.E.Co. #5	FTNP-629430-5	Each
1-1/2" long, slotted			Wedge, lead cable, for		
through 1 wall	GN5613-1.5	Each	Y joints, W.E.Co. #6	FTNP-629430-6	Each
Sleeve, splicing, tinned,			Wedge, lead cable, for		
single tube, copper #16 AWG,			Y joints, W.E.Co. #7	FTNP-629430-7	Each
1-1/2" long slotted					
through 1 wall	GN5616-1.5	Each			

Description	Stock Number	Unit	Description	Stock Number	Unit
Wedge, lead cable, for Y joints, W.E.Co. #8	FTMP-629430-8	Each	Cap, pipe, for 3" pipe Compound, #2 P&B	NSN	Each
Wedge, lead cable, for Y joints, W.E.Co. #9	FTMP-629430-9	Each	Strip, leather, 24 x 2 x 1/8"	NSN	Each
Cap, pipe, for 2" pipe	NSN	Each	Tags, cable, octagonal	NSN	Each
			Tags, cable, round	NSN	Each

Section V
Construction Time and
Information on Poles

628. GENERAL. Paragraph 629 gives the estimated time required to perform various tactical line construction operations, under non-combat conditions. These figures are based upon the experience obtained during Signal Corps field trials.

Similar data for the fixed plant given in the same paragraph are based upon average commercial practice. Paragraph 630 provides information on the rates of placing field wire circuits using various types of wire-laying equipment. Paragraphs 631 to 633 inclusive, give the American standard dimensions and weights of round poles commonly used in the United States and similar data on rectangular lumber supports.

629. ESTIMATED TIME REQUIRED FOR WORK OPERATIONS.

	Man-Hours ^a		
	Tactical Plant - Placing	Fixed Plant Placing	Removing
Laying Out and Staking Line			
Open Wire			
150' Span	6.5	10.	-
200' Span	6.0	-	-
Insulated Wire - 150' Span	5.0	-	-
Material Distribution			
4 x 4 Lumber - per pole	0.17	-	-
Round Poles - per pole	0.28	0.5	-
Wire and Accessory Materials			
150' Span - 4 pairs	4.4	6.	-
200' Span - 4 pairs	3.7	-	-
Insulated Wire and Accessory materials - 150' span	1.5	2.	-
Lead Cable and Accessory materials - per reel	-	1.8	-
Holes - Pole			
Dug by hand	0.5	2.	-
Dug by machine	0.4	0.5	-
Dug by blasting - hand drilling	3.5	5.	-
Holes - Anchor			
Dug by hand - 4 x 4 log - each	1.5	-	-
Dug by machine - log or plant - each	1.5	1.7	-
Dug by machine - patent - each	-	0.8	-
Dug by hand - 5/8" rock - each	1.0	-	-
Assembling Supporting Structure			
Open Wire - 8 Pin Crossarm			
4 x 4 Lumber Support - each	0.3	-	0.1
Round Pole - each	0.4	0.5	0.2
Setting Poles (erecting, back-filling and tamping)			
4 x 4 Lumber - each	0.5	-	0.1
20' round - each	0.8	-	0.4
30' round - each	1.2	1.5	0.8
Guying			
Placing anchor and back-filling			
4 x 4 log - each	0.7	-	-
Round pole log or plank - each	2.3	2.7	-
Patent - each	-	1.2	-
Placing and tensioning			
W-145, 109 G.S. or similar	0.3	-	.05
Wire messenger, 2.2M	0.8	-	0.1
Wire messenger, 6M or 10M	1.2	1.5	0.1

^aAll figures are on a per mile basis except where otherwise indicated.

Table continued on next page

ESTIMATED TIME REQUIRED FOR WORK OPERATIONS. (Continued)

	Man-Hours ^a		
	Tactical Plant - Placing	Fixed Plant Placing	Removing
Installing Line Wire (Placing, sagging and tying-in)			
One pair	20.	25.	5.
Four pair	42.	52.	15.
Installing Messenger Wire			
6 and 10M Messenger	-	36.	30.
16M Messenger	-	50	40.
Placing Cable Rings on Messenger	-	30.	17.
Placing Lead Covered Cable On 10M Messenger or Smaller	-	37.	40.
Placing Insulated Wire on existing pole line	35.	-	7.
Ground Surface Construction ^b			
Spiral four	2.6	-	3.
Wire W-143 or similar	3.8	-	4.
Buried Construction (Using CableFlow LC-61) ^c			
Spiral four			
One cable	4.8	-	-
Two cables, same trench	6.4	-	-
Wire W-143			
One pair	6.4	-	-
Two pairs, same trench	8.0	-	-
Constructing over-head crossing for insulated wire - each	5.2	-	-

^aAll figures are on a per mile basis except where otherwise indicated.

^bFor surveying, staking line, testing sections and policing, add 12 man-hours per mile for spiral four cable and 6 man-hours per mile for Wire W-143.

^cFor surveying, staking line, testing sections and policing, add 18 man-hours per mile for one cable and 25 man-hours per mile for two cables.

630. RATES OF FIELD WIRE CONSTRUCTION.

Wire Laying Equipment	Const. Party (men)	Miles per Hour							
		One Circuit				Two Circuits, Concurrently			
		Roads		Cross Country		Roads		Cross Country	
		Day	Night	Day	Night	Day	Night	Day	Night
Axle, RL-27-()	2	1-1/2	1	1	1/2	-	-	-	-
Carrier, RL-24-()	3	2	1-1/2	1-1/2	1	-	-	-	-
Reel, RL-17-()	3	1-1/2	1	1	1/2	-	-	-	-
Reel Cart, RL-16-()	2	1-1/2	1	1	1/2	1-1/2	1	1	1/2
Reel Equipment, CE-11-()	1	2	1-1/2	1-1/2	1	-	-	-	-
Reel Unit, RL-26-() (mtd. in truck)	6	3-5	2-4	3-5	2-4	3-5	2-4	3-5	2-4

631. DIMENSIONS OF ROUND POLES (AMERICAN STANDARD).

Class ^a		1	2	3	4	5	6	7
	Minimum top circumference (inches)	27	25	23	21	19	17	15
	Transverse breaking loads (pounds)	4500	3700	3000	2400	1900	1500	1200
Length Feet	Species ^b	Minimum circumference at 6 feet from butt						
20	Northern cedar	39.5	37.0	34.0	31.5	29.0	27.0	25.0
	Western cedar	34.5	32.0	30.0	28.0	25.5	23.5	22.0
	Lodgepole pine	32.5	30.5	28.5	26.5	24.5	22.5	21.0
	Southern pine	31.5	29.5	27.5	25.5	23.5	22.0	20.0
	Douglas fir	31.5	29.5	27.5	25.5	23.5	22.0	20.0
22	Northern cedar	41.0	38.5	36.0	33.0	30.5	28.0	26.0
	Western cedar	36.0	33.5	31.5	29.0	27.0	25.0	23.0
	Lodgepole pine	34.0	32.0	30.0	27.5	25.5	23.5	22.0
	Southern pine	33.0	31.0	29.0	26.5	24.5	23.0	21.0
	Douglas fir	33.0	31.0	29.0	26.5	24.5	23.0	21.0
25	Northern cedar	43.5	41.0	38.0	35.5	32.5	30.0	28.0
	Western cedar	38.0	35.5	33.0	30.5	28.5	26.0	24.5
	Lodgepole pine	36.0	33.5	31.0	29.0	27.0	25.0	23.0
	Southern pine	34.5	32.5	30.0	28.0	26.0	24.0	22.0
	Douglas fir	34.5	32.5	30.0	28.0	26.0	24.0	22.0
30	Northern cedar	47.5	44.5	41.5	38.5	35.5	33.0	30.5
	Western cedar	41.0	38.5	35.5	33.0	30.5	28.5	26.5
	Lodgepole pine	39.0	36.5	34.0	31.5	29.0	27.0	25.0
	Southern pine	37.5	35.0	32.5	30.0	28.0	26.0	24.0
	Douglas fir	37.5	35.0	32.5	30.0	28.0	26.0	24.0
35	Northern cedar	50.5	47.5	44.0	41.0	38.0	35.0	32.5
	Western cedar	43.5	41.0	38.0	35.5	32.5	30.5	28.0
	Lodgepole pine	41.5	38.5	36.0	33.5	31.0	28.5	26.5
	Southern pine	40.0	37.5	35.0	32.0	30.0	27.5	25.5
	Douglas fir	40.0	37.5	35.0	32.0	30.0	27.5	25.5

^aClass 8 - Top circumference 18 inches, estimated transverse breaking load 1100 pounds;
Class 9 - Top circumference 15 inches, estimated transverse breaking load 900 pounds;
Class 10 - Top circumference 12 inches, estimated transverse breaking load 600 pounds.
No butt dimensions are specified for these classes.

^bNorthern and Western cedars are furnished butt treated; other species are treated full length.

632. WEIGHTS OF ROUND POLES (AMERICAN STANDARD).

Class		1	2	3	4	5	6	7	9	10
Length Feet	Species	Weights ^a (Pounds)								
20	Northern cedar	510	440	380	320	260	210	160	140	120
	Western cedar	430	380	310	280	230	190	170	150	110
	Lodgepole pine	410	340	295	255	220	185	155	135	105
	Southern pine	640	510	420	350	300	250	210	180	140
	Douglas fir	520	410	340	280	240	200	170	140	120
22	Northern cedar	570	500	430	370	300	240	190	160	140
	Western cedar	510	450	380	330	270	240	200	170	130
	Lodgepole pine	480	400	350	300	255	215	185	150	115
	Southern pine	740	600	500	410	360	300	250	210	170
	Douglas fir	600	490	400	340	290	240	200	170	140
25	Northern cedar	680	600	520	440	360	290	240	200	170
	Western cedar	600	550	450	390	330	290	250	210	150
	Lodgepole pine	605	495	420	360	315	265	225	195	145
	Southern pine	890	730	610	510	440	380	310	260	210
	Douglas fir	720	590	490	420	360	300	250	210	170
30	Northern cedar	930	800	700	580	480	390	320	290	-
	Western cedar	820	720	620	520	450	380	330	270	-
	Lodgepole pine	810	670	580	490	415	350	295	260	-
	Southern pine	1140	970	820	700	590	490	410	330	-
	Douglas fir	930	780	670	570	480	400	330	270	-
35	Northern cedar	1170	1010	880	730	600	500	400	-	-
	Western cedar	1060	910	800	670	550	470	420	-	-
	Lodgepole pine	1035	865	715	615	520	435	365	-	-
	Southern pine	1410	1200	1040	900	770	670	580	-	-
	Douglas fir	1140	980	840	730	620	540	470	-	-

^aAn estimate of the shipping space required for poles may be obtained by the following formula:
 Weight (pounds) x constant = approx. ship space (Cu. Ft.)

The values of the constant are:

Cedars	= .052
Lodgepole pine	= .041
Pine	= .026
Douglas fir	= .032

633. DIMENSIONS AND WEIGHTS OF 2 x 4 AND 4 x 4 LUMBER SUPPORTS (AMERICAN STANDARD).

**Section VI
 Construction Equipment,
 Vehicles and Tools**

Nominal Size Inches	Dressed Size Inches	Weight ^a per Linear Foot - Pounds	
		Untreated	Treated ^b (Creosote)
2 x 4	1-5/8 x 3-5/8	1.4	1.7
4 x 4	3-5/8 x 3-5/8	2.9	3.6

^aThese weights apply to Southern Pine; weights of Douglas Fir would be 5 to 10% less.

^bSalt treatment increases the untreated weight only slightly, in the case of 2 x 4 dried material about 1 pound per 100 linear feet and in the case of 4x4 material about 2-1/4 pounds per 100 linear feet.

634. GENERAL. Descriptions and stock numbers of wire and cable placing and recovering equipment and of special purpose trucks and trailers used in line construction and maintenance are given in paragraphs 635 and 636. The tools and equipment which are required by lineman, groundmen and splicers in the construction and maintenance of communication lines are given in paragraphs 637 to 640, inclusive. Individual tool equipment which should be provided, as well as other equipment which should be carried on each truck, or should be available at central points, is included.

635. WIRE AND CABLE PLACING AND RECOVERING EQUIPMENT - DESCRIPTION AND STOCK NUMBERS.

Nomenclature Name	Type Number	Fig. No.	Signal Corps Stock Number	Weight -Pounds Packed for Export	Cu. Ft.	Remarks	
							Net
Reel Equipment	CE-11	608	6H6111	10	15	3	Consists of Reel Unit RL-39, Handset TS-10(), Straps ST-33, ST-34 and ST-35; used for laying and recovering 1/4-mile of assault wire, TM 11-2250 and FM 24-5.
Reel	DR-4	609	6H2504	22	30	2	Steel, 22" O.D. and 7" wide; used for field and assault wire; mounts on Axle RL-27-A, Reel Unit RL-31 and Reel Cart RL-35.
Reel	DR-5	610	6H2505	34	40	4	Steel, 19-1/2" O.D. and 18" wide; used for field and long range tactical wire; mounts on Reel Unit RL-26, Reel Unit RL-31 and Reel Cart RL-35.
Reel	DR-7	601	6H2507	40		8	Steel, 27-1/2" O.D. and 18" wide; used for 5- and 10-pair rubber-covered cable; mounts on Reel Unit RL-31.
Reel	IR-8		6H7108	2		0.4	Steel, 9" O.D. and 8" wide; used for assault wire; separate item and also component of RL-39.
Reel	IR-15	611	6H2515	40		4.8	Steel, same as DR-5 except with an adapter (FT-315) on the inside of one flange to hold cable connectors; used for rubber-covered cables; mounts on Reel Unit RL-26, Reel Unit RL-31 and Reel Cart RL-35. TM 11-369.
Reel Cart	RL-16	612	6H6016	205	240	25	2-wheel, hand-drawn; will carry two Reels DR-4 or one Reel DR-5; furnished with empty Reels DR-4 unless otherwise specified. FM 24-5.
Reel Unit	RL-17	613	6H3017	80	93	3.7	Portable, mounted on a barrow to be carried by two men; used for paying out wire. TM 11-368.
Reel Unit	RL-26		6H6226	350	500	50	Portable, gasoline engine driven, with two shafts; accommodates, but does not include, Reels DR-5. TM 11-360, TB 11-360-1 and FM 24-5.
Reel Unit	RL-26-A	614	6H6226A	350	500	50	Same as RL-26 except includes Cover BC-68. TM 11-360, TB 11-360-1 and FM 24-5.
Reel Unit	RL-26-B		6H6226B				Same as RL-26-A except frame strengthened and brakes improved.
Reel Unit	RL-26-C		6H6226C	450			Same as RL-26-B except tool box added.
Axle	RL-27-A	609	6H227A	5	6	.05	Steel, with two knurled handles; used for carrying by hand, but does not include, Reel DR-4. FM 24-5.
Axle	RL-27-B		6H227B	7	10	0.3	Steel, same as RL-27-A except equipped with hand crank for recovering wire.
Reel Unit	RL-31-B	615	6H6231	35	40	0.33	Collapsible frame of steel tubing, a braking unit (OC-10), a crank (CC-4-A), two hangers and four toe plates; used with cargo trucks in wire and cable laying. TM 11-362 and TB 11-362-2.
Support	FT-245		6H7245		12	0.4	Drawing SC-A-6362, for bracing Reel Unit RL-31 to inside of a cargo truck.
Reel Cart	RL-35	609	6H6235	105			Single axle, hand-drawn, with hand crank for recovering wire; has capacity of 3 Reels DR-4, 1 Reel DR-5 or 1 Reel DR-15.
Reel	RL-39		6H3039	2.6			Consists of a frame, Reel DR-8, two handles and a crank; part of CE-11. TM 11-2250.
Reel Unit	RL-45		6H6245	35	40	0.33	Similar to RL-31, with clamps to permit use in 1/4-ton truck.
Carrier	RL-24-A		6H524A	26	33	2	H-shaped iron frame, used with a Phillips Pack Saddle; uses, but does not include, Reel DR-4. Part of CE-1, CE-2 and CE-5.
Plow	IC-61	616	6H2061	1525	1815	50	Designed to be pulled by a 2-1/2 ton truck, tractor or winch line; the feeding passage is 1-1/8" wide; for burying insulated wire or small cables to a depth of from 6" to 18". Burying can be done either directly from reels mounted on plow or truck or after the facilities are on the ground in service. TM 11-369 and TM 11-370.
Axle	IC-31		6Q1531	58	65	0.5	Steel, cable reel; 2" diameter by 6' long; for use with two Jacks IC-13.

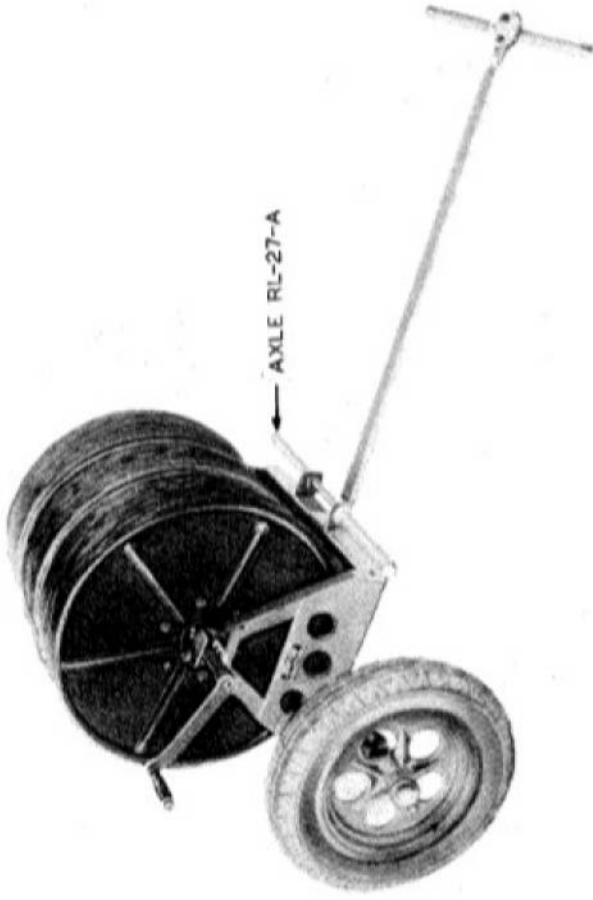

FIGURE 609. Reel Cart RL-35 and 3 Reels DR-4

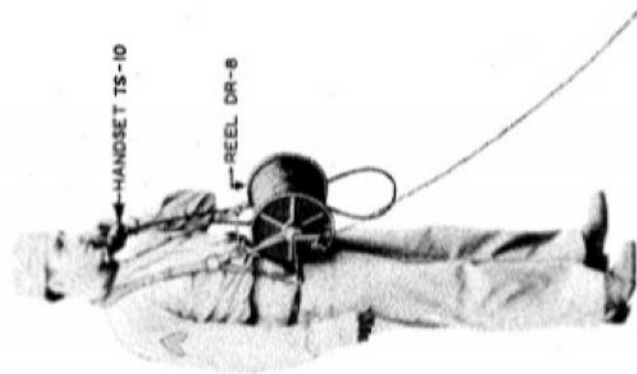

FIGURE 608. Reel Equipment
CE-11

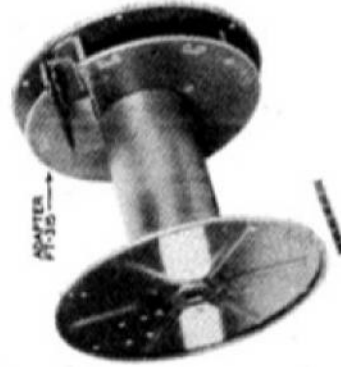

FIGURE 611. Reel DR-15



FIGURE 610. Reel DR-5

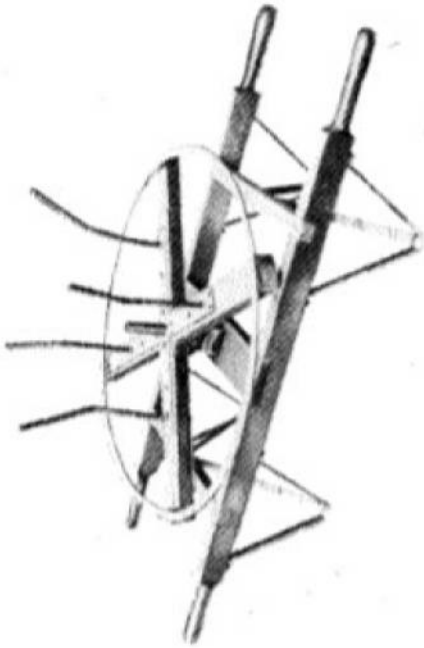
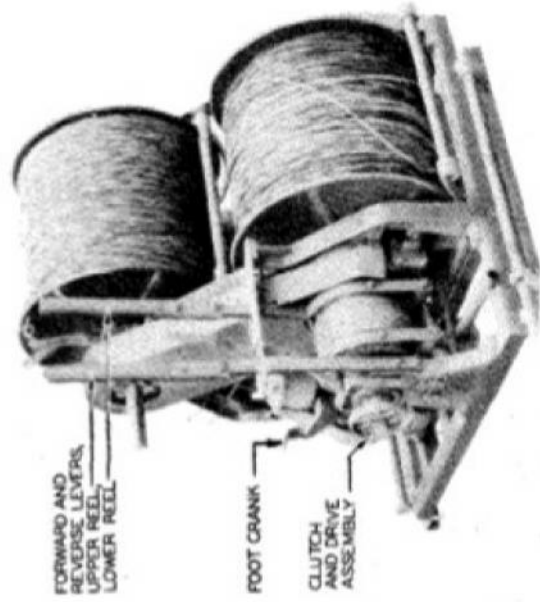

FIGURE 613. Reel Unit RL-17



FORWARD AND
REVERSE LEVERS
UPPER REEL
LOWER REEL

FOOT CRANK

CLUTCH
AND DRIVE
ASSEMBLY

FIGURE 614. Reel Unit RL-26-A
With Reels DR-5



FIGURE 612. Reel Cart RL-16
With 2 Reels DR-4



FIGURE 616. Flow LC-61



FIGURE 615. Reel Unit RL-51-B

636. SPECIAL PURPOSE TRUCKS AND TRAILERS FOR LINE CONSTRUCTION AND MAINTENANCE.

<u>Nomenclature</u>	<u>Shown</u>	<u>Net</u>	<u>Carrying</u>	<u>Shipping</u>		<u>Remarks</u>	
<u>Type</u>	<u>in</u>	<u>Weight</u>	<u>Capacity</u>	<u>Dimensions</u>			
<u>Name</u>	<u>Number</u>	<u>Fig.No.</u>	<u>Number</u>	<u>Pounds</u>	<u>Pounds</u>		<u>Cu.Ft.</u>
Trailer K-36	617	6J1036	1,815	5,000		54	2-ton, body 72" x 48" x 5-1/2"; used for pole and bulk material hauling. TM 11-368 and TM 9-2800.
Trailer K-37	618	6J1037	2,900	10,000	472	82	5-ton, used for cable reel and pole hauling. TM 9-2800.
Trailer K-38	619	6J1038	410	500	68	21	1/4-ton, body 42" x 36" x 24"; used for storage and transportation of cable splicer's Tool Equipment TE-56- (). TM 9-2800.
Truck K-43	620	6J9043	10,215	1,035	3,070	140	1-1/2 ton, 4 x 4, equipped with winch, pole derrick and power take-off; used for general line construction and maintenance. TM 10-1202, TM 10-1203, TM 10-1414 and TM 9-2800.
Truck K-44-B	621	6J9044B	7,200	3,000	1,438	164	1-1/2 ton, 4 x 4, equipped with earth-borer and pole-setter; used for general line construction and maintenance. TM 11-364, TM 10-1202, TM 10-1203, TM 10-1414 and TM 9-2800.

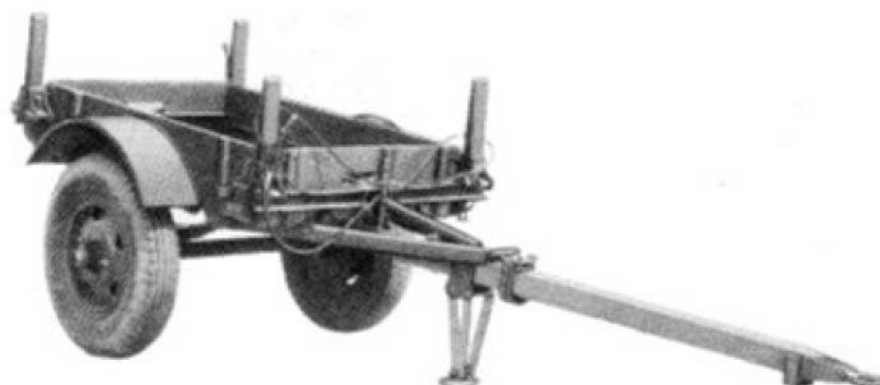

FIGURE 617. Trailer K-36

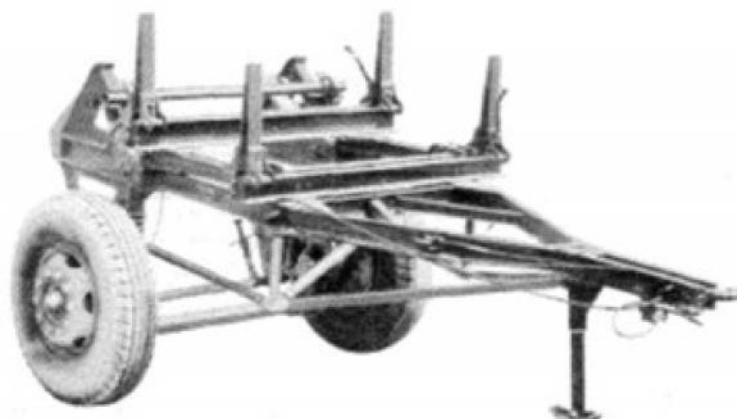

FIGURE 618. Trailer K-37

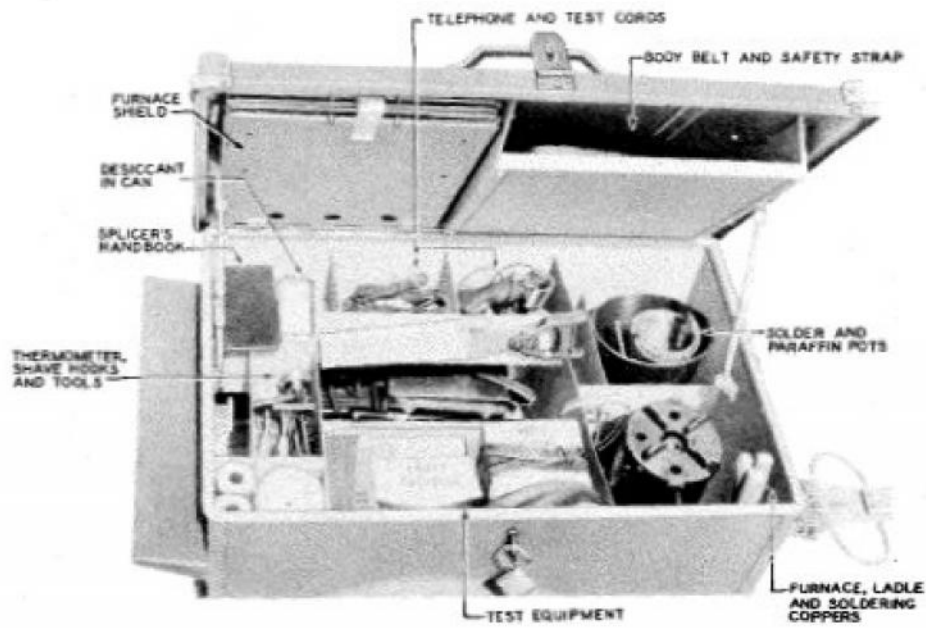
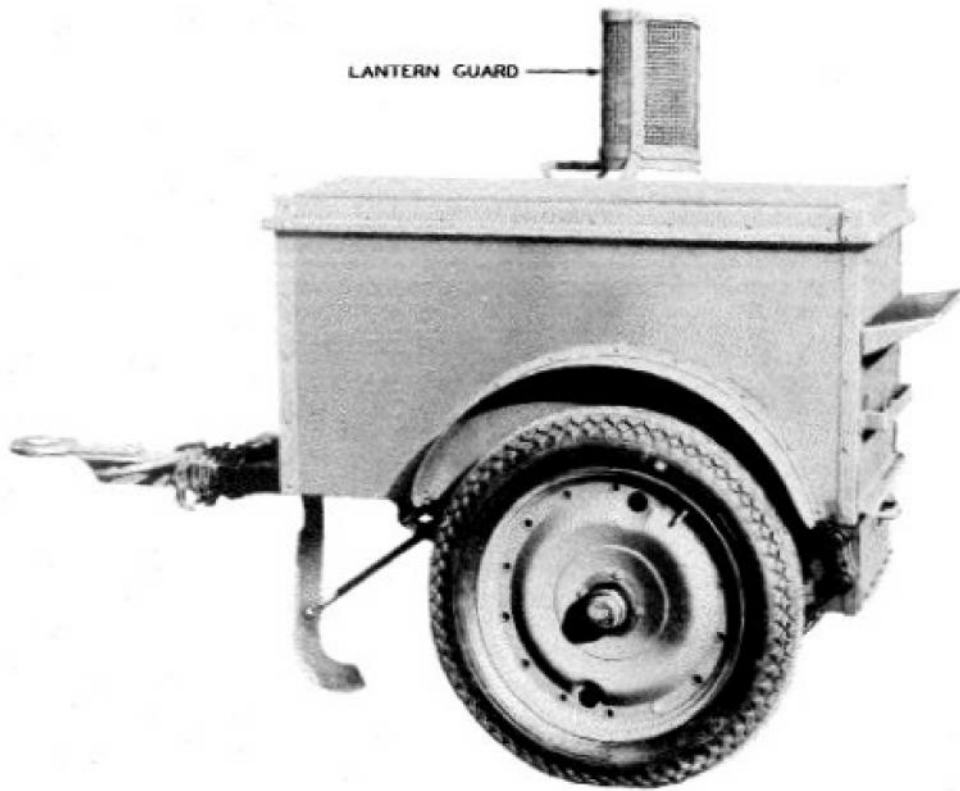

FIGURE 619. Trailer K-38 With Cable Splicer's Tool Equipment TX-56



FIGURE 620. Truck K-43

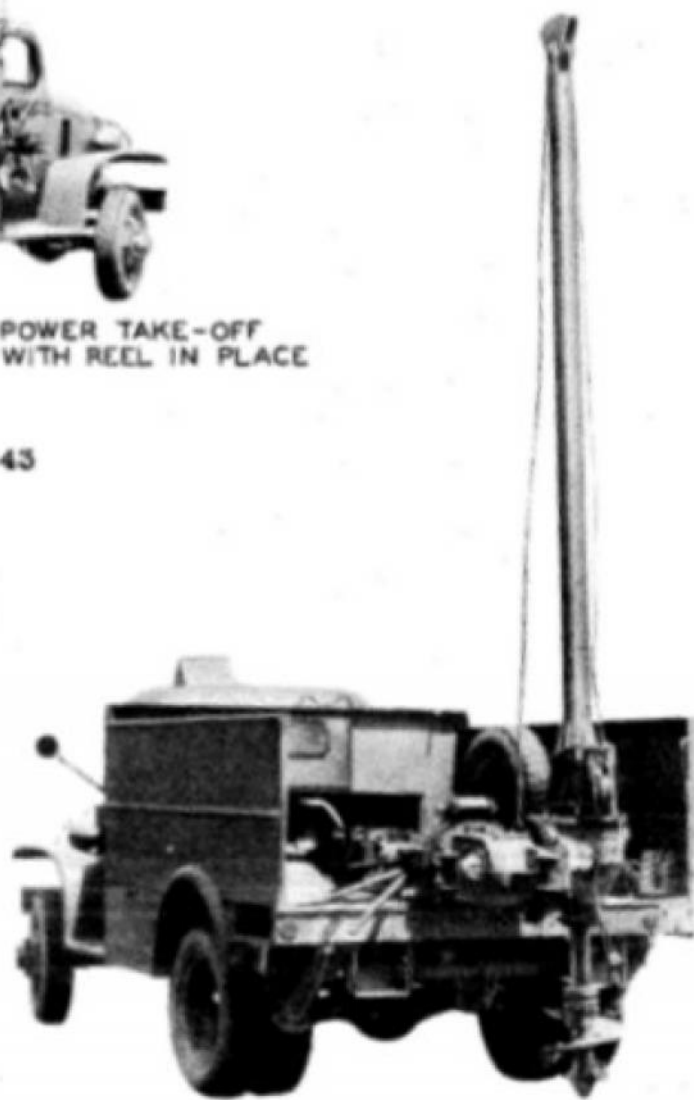

FIGURE 621. Truck K-44-B

637. LINE CONSTRUCTION TOOL EQUIPMENT.

	<u>Stock No.</u>		<u>Stock No.</u>
a. Lineman's Equipment TK-21			
	6Q63521	2 Knife, draw, 10" blade	6Q60510
		1 Mallet, 3-1/2" x 5-1/2"	6R335-55
		1 Oilstone, 8" x 2" x 1"	6R2182
1 Ax IC-1	6Q1001	1 Rule, folding 4 ft.	6R9604
1 Belt ^a IC-23-B, (Lineman's safety with safety strap)	6Q4523B	1 Tape, linen, 50 ft.	6R36053
1 Clamp ^b IC-24	6Q27024	2 Wrench, monkey, 12"	6R56512
1 pr. Climbers ^c IC-5	6Q28205	4 Scabbard, bit, 11/16"	6Q6011-18/1
1 Pliers TL-107 (8" side cutting)	6R4607	1 Scabbard, bit, 3/8"	6Q5906-19/1
1 Screwdriver TL-106	6R16810	1 Tool Roll BC-47	6R38347
1 Wrench IC-25-A	6R56013A	Packed - 43 lbs; 1-1/2 cu. ft.	
		Packed - 23 lbs; 0.7 cu. ft.	
Additional items which should be available to linemen are:			
Gloves IC-29 (Rubber)	6Z4829	Bits, auger, 1/4"	6Q5704
Gloves IC-10 (Leather)	6Z4810	Chisels, cold, 1/2" x 6"	6Q19808
Gage TL-144 (Lineman's climber)	6Q45144	Gloves ^f IC-29, rubber	6Z4829
b. Groundman's Equipment TK-23			
1 Belt ^d IC-30 (Lineman's without Safety strap), or Belt ^e IC-23-A less safety strap	6Q4530	Saw TL-104 (hand, 26")	6R10926-8
1 pr. Gloves IC-10 (Leather)	6Z4810	Flashlight ^g TL-123-()	6Z4002A.1
1 Pliers TL-107 (8" side cutting)	6R4607	Stop watch, 1 min. dial	
		Drills, rock, star point, 5/8" x 8"	6Q55210-8
d. Miscellaneous Tools			
		Brushes, paint, 5/32" dia.	6Z1597
		Pull Finder IC-45	6R7245
(Not a part of tool equipments)			
Additional items which should be available to groundman are:			
Ax IC-1	6Q1001	Ax IC-36 (with 36" handle)	6Q1236
Wrench IC-25-A	6R56013A	Bars IC-20 (Wrecking)	6Q3020
Hammer HM-1 (2 lbs.)	6Q49001	Bars IC-2 (7', digging)	6Q3002
c. Tool Equipment TK-27A			
	6R38027A	Bars IC-3 (8', tamping)	6Q3003
		Block Equipment TK-92	6Q8792
		Block set IC-4	6Q8504
		(One tackle, 4"-2 sheave block with 1/2" rope, one tackle, 7"-2 sheave block with 3/4" rope, one snatch block, 8", for manila rope).	
1 Bag BC-44 or	6Q2044	Block, 8", triple sheave, steel and reeve with	6Q8908-3
1 Bag BC-28	6Q2028	Block, 8", triple sheave, steel, reeve with	6Q8908-3.2
2 Bits, auger, 3/8"	6Q5706	Rope, 3/4" manila x 350 ft.	6Z7909
2 Bits, auger, 1/2"	6Q5708	Block, C.I., single sheave, reeve with	6Q8802-1
1 Bit, auger, 1-1/4"	6Q5720	Rope HP-1 (5/16" x 60 ft.)	6Z7904
4 Bits, car (or ship's auger) 11/16" x 18"	6Q6011-18	Grip IC-28 (Wire and 2.2M Messenger)	6Q46528
1 Bit, Bell hanger, 3/8" x 18"	6Q5906-18	Grip, messenger and guy strand	6Q47133
1 Frame, hacksaw, adjustable	6Q41000	Knife, IC-14-B (Brush cutting)	6Q60114B
2 Blades, hacksaw, 18 point	6Q8110-18	Hook, cant, 4-1/2 ft. handle	6Q52845
1 Brace, ratchet, 12" sweep	6Q13012	Hook IC-48 (pole carrying)	6Q52948
3 Chisels, wood, 2"	6Q21232	Hammer, sledge, 16 lbs.	6Q50200-16
2 Files, flat bastard, 10"	6Q38030-10	Augers, pole hole, 8"	6Q708
2 Hammers TL-39 (claw, 1 lb.)	6Q49139	Chair, lineman's safety, Chance #27	6Q18312
1 Handle TL-14 (file)	6Q51014	Ladder IC-15 (Extension, two 15-ft. sections)	6Q62015

^aFurnished in sizes 18(36), 20(38), 22(40), 24(42), 26(44), 28(46), 30(48): () indicates waist measurements.

^bSleeve Rolling Tool, TL-143 (Stock No. 6R22743A) or Compressing Tool, TL-217 (Stock No. 6R22817) should be ordered in place of Clamp, IC-24.

^cFurnished in lengths from 14" to 20" in 1/2" steps. Orders should be worded to include straps and pads when required.

^dFurnished in sizes 36, 38, 40, 42, 44, 46 and 48, (waist measurement).

^eConsult Signal Corps Catalog for stock number, which varies according to length of belt.

^fFurnished in sizes 9-1/2, 10, 10-1/2, 11, 11-1/2, and 12.

^gUses 2 Batteries BA-30, which must be ordered separately.

	<u>Stock No.</u>
Jack LC-54 (Pole pulling, 15-ton)	6Q55054
Pick, railroad type, with handle	6R3000
Pole PO-5 (Pike, 10 ft.)	6R5605
Pole PO-7 (Pike, 14 ft.)	6R5607
Pole Support LC-16 (7 ft., deadman)	5A3416
Wire Raising Hook LC-65	
Square, steel, 24" x 16"	6R25724-16
Scale LC-64	
Saw TL-129 (Cross cut)	6R10860-3
Trimmer LC-22 (Tree)	6R44322
Reel RL-17-(), payout	
Shovel LC-17 (Round point, 8 ft. handle)	6R22017
Shovel LC-19 (Round point, short D-handle)	6R22019
Shovel LC-18, (Spoon, 8 ft. handle)	6R22018
Jack LC-13 (Cable reel)	6Q55013
Bar, (Handle) for Jack LC-13	6Q55013/1
Axle LC-31 (Cable reel)	6Q1531
Grip LC-38 (Cable pulling, woven wire, split, 1" x 18")	6Q47116-18
Grip, cable pulling, woven wire, size 1-1/2" x 24"	6Q47024-24
Grip, cable pulling, woven wire, size 2" x 24"	6Q47032-24
Grip, cable pulling, woven wire, size 2-1/2"	
Guide, aerial cable	6Q48542-1

638. LEAD-COVERED CABLE SPLICER'S TOOL EQUIPMENT.

	<u>Stock No.</u>
Tool Set TE-56-A comprises tools and materials required to splice and wipe sleeves on lead-covered cable. It consists of an assortment of tools, expendable supplies, amplifier, lineman's handset and test sets, etc.; includes such items as lineman's belt, hack saw, cloth, soldering coppers, drift pins, files, insulating compound, electrician's knives, oil, pliers, tape, etc. These tools and materials are housed in Trailer K-38. Additional equipment required for splicing work on aerial cables is as follows:	6R38056A

Tent LC-37 (Cable splicer's) This assembly includes cotton duck tent, metal collapsible frame and wooden platform 38" x 54-1/2". Packed 52 lbs., 0.3 cu. ft.	6R36537
Ladder LC-15 (extension, two 15-ft. sections)	6Q62015

639. VULCANIZING EQUIPMENT FOR RUBBER-COVERED CABLES.

Vulcanizing Equipment TE-55-A	6R47255A
Vulcanizing equipment for repairing cable WC-535 (part of cable assembly CC-355-A) and cable WC-534 (part of cable Assembly CC-345 and cable stub CC-344); consists of Chest CH-75-C containing mold equipment, vulcanizer, rubber	

cement, gloves, skinning knife, pliers and miscellaneous tools and supplies. Addition of molds for cable WC-548 (part of Cable Assemblies CC-358 and CC-368 and Cable Stub CC-356) is under consideration.

640. LINE SURVEY TOOLS AND MATERIALS.

Tools and materials which are useful in line layout work are given below. The selection of the particular articles required depends upon the type of line to be constructed and the terrain.

<u>Article</u>	<u>Stock No.</u>
Note book and pencil	
Stakes, wooden, preferable 1" x 3" with orange tops	
Tags, linen or equivalent	6Z8604
Tape, steel, 100-foot measuring (Part of TE-11)	6R36026
Ax LC-1, or	6Q1001
Ax LC-36	6Q1236
Compass I-1 or equivalent	
Poles, ranging	
Crayons, lumber, or	
Chalk	7A486
Knife TL-29	6Q60229.1
Shovel LC-19	6R22019
Pliers TL-13 or similar	6R4513
Belt LC-23-B	6Q4523B
Climbers ^a LC-5, Lineman's or similar	6Q28205
Flashlight TL-122-()	6Z4002
Gloves LC-10 (Leather)	6Z4810
Rope RP-1, 5/16" diam., 60-foot length	6Z7904
Nails, roofing #12 or equivalent	6L2001
Cloth, strips of	
Field wire, measured lengths	
Rule, folding 6-foot	6R9606
Binoculars	
Bar, digging; 5-foot	6Q3505
Hook LC-21 (Brush or bush)	6Q52621

^aFurnished in lengths from 14" to 20" in 1/2" steps. Orders should be worded to include straps and pads when required.

Section VII
Submarine Cable

641. SUBMARINE CABLE FOR TACTICAL USE.

a. Cable Assembly CC-358 (spiral-four) Cable WC-534 (5 pair), and Cable WC-535 (10 pair) are suitable for use as tactical submarine cables in depths of water at least up to one-half mile, and will probably be satisfactory for much greater depths. Life expectancies of the order of one year are considered reasonable. The transmission properties of such cables, when properly laid, will be about the same as those obtained when the cables are employed normally.

b. Underwater splices should be avoided whenever feasible in short submarine cables. Except in the case of spiral-four cable connectors, standard (vulcanized) splices should be used whenever possible. The insulation of spiral-four cable connectors should be improved by means of rubber cement, DR or rubber tape, and friction tape. If it becomes necessary to utilize expedient splices, their insulation should be improved with rubber cement; and if the conductor

splices proper are made without the use of copper splicing sleeves, then they should be strengthened by means of tension bridges, (TM 11-369 and TB Sig 67).

c. Tactical submarine cables may be laid from suitable boats or amphibious vehicles by means of reels, or by paying out cable stowed in figure-eight form. It is advantageous to use a method which permits, insofar as possible, the making of all splices and preliminary tests before the actual laying starts. One of the most satisfactory methods of laying is to employ Truck, Amphibian, 2-1/2-ton 6 x 6 (Duck). Four to five miles of pre-spliced tactical cable can be stowed in this truck. The cable should be formed on the floor of the cockpit so that the crosspoint of the figure-eight is at the center, with one loop extending forward and the other aft. The cable should be paid out over the stern. A suitable device for guiding the cable over the stern is an empty reel mounted in Reel Unit RL-31, erected on the after deck.

d. The addition in the field, of armor or additional outer covers to tactical cables for submarine use is not considered to be feasible or desirable. The outer covers of the tactical cables are tough and will resist serious abrasion, as well as sheath breaks due to repeated flexure, for long intervals if motion is kept to a minimum. Therefore, cables should be laid on the bottom and additional weight should be applied as necessary in order to hold the cables in po-

sition. The best method for increasing the weight of tactical cable in the field is to leash it to Wire W-115 (6M-Messenger) at approximate three-foot intervals by means of a clove hitch or square knot ties made with short lengths of Wire W-110-B. Cables so reinforced with messenger should be used all the way across short channels with fast current (faster than about 2 or 3 miles per hour). Reinforcement with messenger is not required at all in calm water or at sheltered approaches, but is required at approaches that are exposed to breaking waves. Under the latter conditions the reinforcement should extend from a log anchor well up on shore to a rock anchor well out in deep water. Cable laid in calm water or in deep water between rock anchors needs no special reinforcement, but is simply laid with sufficient slack to permit it to conform to the contours of the bottom.

642. SUBMARINE CABLE FOR FIXED PLANT.

In fixed plant areas lead-covered armored submarine cables are usually employed and these cables require special engineering, special equipment for installing and trained crews to do the work. If such cable installations are required the matter should be discussed with the Army Communication Service. However, data on stocked sizes of these submarine cables are given in paragraph 643.

643. SUBMARINE CABLES - PHYSICAL DATA AND STOCK NUMBERS.

Type No. ^a	Stock Number	No. of Pairs	Armoring	Diameter - In.		Weight-Lbs. per Foot	Feet per Reel	Shipping Data per Reel of Cable	
				Lead Sheath	Overall			Weight	Cu.Ft.
a. Paired Cable.									
WC-321	1D321	10	Single Wire (203 mil)	0.74	1.60	4.2	3,000	13,566	190
WC-325	1D325	25	Single Wire (203 mil)	1.05	1.90	5.25	2,000	11,466	190
WC-327	1D327	50	Single Wire (203 mil)	1.32	2.17	6.67	2,000	14,306	190
WC-328	1D328	75	Single Wire (203 mil)	1.63	2.5	8.5	1,500	13,716	190
WC-329	1D329	100	Single Wire (203 mil)	1.71	2.58	10.75	1,500	17,275	233
WC-333	1D333	10	Double Wire (203/203)	0.8	2.52	9.0	3,000	31,636	651
WC-335	1D335	25	Double Wire (203/203)	1.05	2.75	10.25	2,000	23,000	496
WC-337	1D337	50	Double Wire (203/238)	1.32	3.09	11.5	1,500	18,450	258
WC-338	1D338	75	Double Wire (203/238)	1.63	3.44	13.5	1,000	14,670	245
WC-339	1D339	100	Double Wire (203/238)	1.71	3.52	15.75	1,000	16,920	245
b. Single Conductor Cable^b									
-	-	-	16 #14 BWC Galv. Steel Wires	-	1.16	0.639	c	3,885 ^d	62 ^d
-	1D1020.1	-	10 #4 BWC Galv. Steel Wires	-	1.47	1.99	c	12,099 ^d	151 ^d
-	-	-	10 #2 BWC Galv. Steel Wires	-	1.56	2.84	c	17,267 ^d	202 ^d

^aAll paired cables have No. 19 AWG conductors. All single conductor cables consist of 7 strands of No. 20 AWG wire; 150 lbs. per nautical mile.

^bCable consists of one conductor surrounded by rubber insulation, Anhydrex AA-60 rubber compound, cloth tape, two layers of jute, then armor and one layer of jute overall.

^cShipped in lengths of 20 to 50 nautical miles coiled on gondola cars.

^dFigures are per nautical mile.

CHAPTER 7
EUROPEAN AND UNITED STATES CABLES
AND LOADING SYSTEMS

Section I
Coil Loaded Lead-Covered Cables

701. INTRODUCTION. This section gives information regarding the types of coil loaded cable used in Europe and in the United States, and also includes information regarding loading standards approved by the C.C.I.F. (International Consulting Committee, Telephony) for voice-frequency telephone circuits.

702. EUROPEAN CABLE LOADING SYSTEMS - SCOPE.

a. This section summarizes all the information on loaded cable circuits given in the February 1939 edition of "Nomenclature Des Circuits Telephoniques International" published by the "Bureau De L'Union Internationale Des Telecommunications", Berne, Switzerland.

b. The data are organized in groups for individual nations. Each such group consists of the types of loaded cable circuits located wholly within the specified national boundaries, which are used as portions of international circuits, except that a small number of international submarine cables are included. It is probable that other types of loading not listed in the tables are used on cables located wholly within the boundaries of the individual countries.

c. Most of the data are for coil loaded circuits, nearly all in underground cables. Aerial cables are very seldom used in the countries listed. Occasionally, coil loaded or continuously loaded submarine cables are involved. Information regarding the most important of these submarine cables is given in section II of this chapter.

703. EUROPEAN CABLE LOADING SYSTEMS - DATA.

a. General. Coil loaded cable data are tabulated in paragraph 705 for the following countries: Belgium, Danzig, Denmark, England, Estonia, Finland, France, Germany, Holland, Hungary, Italy, Luxemburg, Norway, Poland, Roumania, Sweden, and Switzerland.

The following items given in the tables are taken from the International Union publication:

Coil spacing in meters
Coil inductance in millihenries.
Theoretical loading cut-off frequency in cycles
Conductor diameters in millimeters

The theoretical nominal impedances of the loaded circuits are computed from the listed values of coil inductance and loading cut-off, and are "rounded off" to the nearest 50 ohms. The notes to each table include a list of the A.W.G. sizes (Brown & Sharpe gauge) which are closest to the actual wire sizes. Usually the loaded phantoms are phantoms of twisted-pair quads which also have their side circuits loaded. In such instances the associated side circuit and phantom circuit loading data are tabulated side by side, these groupings being based on the loading practices recommended by the C.C.I.F. In some countries, notably Holland and to some extent Germany and Sweden, spiral-four type cable quads are used. In such cables, it is not customary to load the phantoms, and the data given for loaded pairs apply to the side circuits. In other instances the loaded pair data may apply to nonquadded cables.

b. Impedance Data. In computing the impedance data the effects of the conductor resistance and the relatively small distributed inductance of the cable circuits are ignored. They were derived by combining the formulas

$$Z = \sqrt{\frac{L}{C}} \quad \text{and} \quad f_c = \frac{1}{\pi \sqrt{LC}}$$

to obtain $Z = \pi L f_c$

where Z is the impedance, L is the loading coil inductance in henrys, C is the loading section capacitance in farads, and f_c is the loading cut-off frequency. (L and f_c were obtained from the lists in the International Union publication mentioned in paragraph 702.) The impedance data are useful in estimating the attenuation losses of the loaded circuits and the reflection losses, when various types of Army telephones and repeaters are connected to the circuits.

c. Attenuation Loss Data. Attenuation loss values for the individual loaded cable circuits may be estimated by

first determining the impedance and the wire size from the tables and then referring to the curves in paragraph 704, which show for various wire sizes, the 1000-cycle attenuation loss versus nominal impedance. Separate sets of curves are given for nonphantomed pairs and side circuits of phantom groups and for phantom circuits. Attenuation values for wire sizes not plotted can be determined by interpolation. The probable error of the curves is of the order of ± 10 per cent, or less. The degree of approximation is greatest for low impedance circuits using small-size conductors.

d. Uses of the Loaded Circuits. Most types of coil loaded circuits used as components of international circuits are operated on a physical four-wire basis. Some are also used on a two-wire basis.

Some of the low impedance, high cut-off circuits are employed for "two-band" telephony, in which a voice-frequency channel (300 to 2600 or 2700 cycles) is used for one direction of transmission, and a carrier channel for the opposite direction. Loaded pairs and loaded phantoms are used for this purpose, particularly in central Europe. The types of loading used for two-band telephony include the 5580-12, 5580-30 and 6000-20 systems on side circuits and the 6560-20 system on phantoms. (In these loading system designations, the first number is the coil spacing in feet, and the second number is the coil inductance in mh.) Low impedance types of coil loaded cable circuits used for entrance and intermediate cables in non-loaded open-wire lines are included in the tables.

704. TYPICAL EUROPEAN LOADED CABLES - APPROXIMATE 1000-CYCLE LOSS PER MILE (1609 METERS) VS NOMINAL IMPEDANCE.

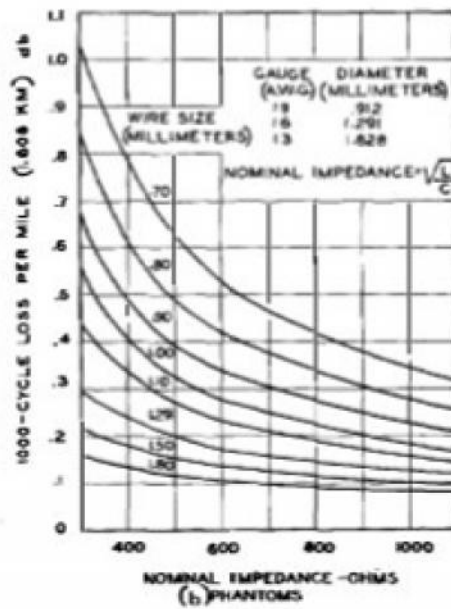
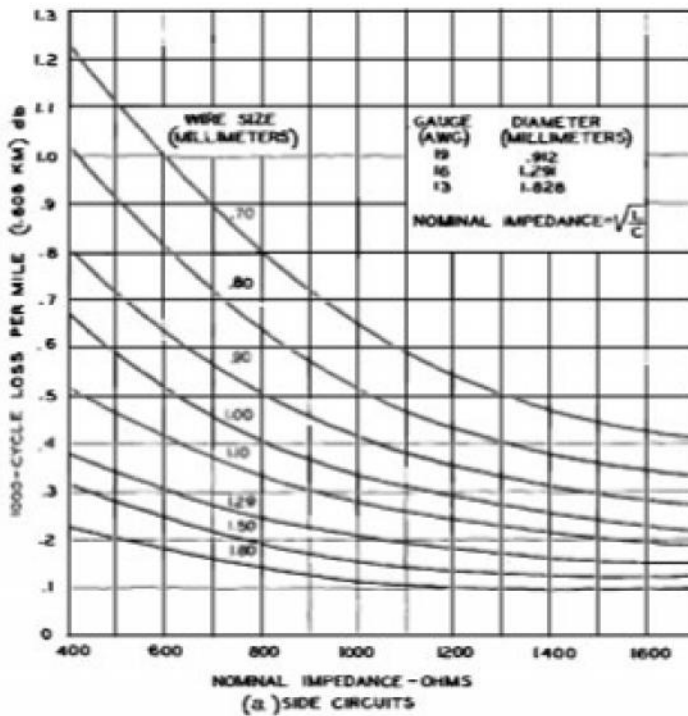

705. TYPES OF COIL LOADED CABLE CIRCUITS IN INTERNATIONAL TELEPHONE FACILITIES.

Spacing of Loading Coils (meters) (feet)		Loaded Pairs ^g			Loaded Phantoms			Wire Size ^f (diameter in mm)
		L ^c (mh)	f _c ^d (cycles)	Z ^e (ohms)	L ^c (mh)	f _c ^d (cycles)	Z ^e (ohms)	
<u>BELGIUM</u>								
1830	6000)	44 ^a	5800	800	25 ^a	6400	500	1.23;1.30;1.80
to	to)	110	3600	1250	44	4500	600	0.90
1840	6040)	177 ^a	2900	1600	63 ^a	3600	700	(0.90;1.23;1.50
		177	2800	1550				(1.00;1.30;1.80
<u>DANZIG</u>								
1660	5450	200	2800	1750				0.80
1700	5580	20 ^b	8850	550	10 ^b	9740	300	1.40
2000	6560	50 ^a	5430	850	20 ^a	6830	450	0.90
2000	6560	190 ^a	2690	1600	70 ^a	3465	750	1.40
<u>DENMARK</u>								
1696	5550)	30	7600	700				1.15
		30	7500	700				1.05
to	to)	140 ^a	3600	1600	56 ^a	4450	800	0.90;1.00
		140 ^a	3500	1550	56 ^a	4250	750	1.05;1.40
1710	5600)	140 ^a	3400	1500				1.05;1.40
2000	6560	190 ^a	2740	1630	70 ^a	3465	750	1.40
2120	6950	177	2800	1550				0.90
2208	7240	47	4900	750				1.00
2464	8080	18	7650	450				1.00
3295	10800	14.5	7000	350				1.00
3880	12700	60	3550	650				1.40

^aLoading standards approved by C.C.I.F. which are likely to be more widely used than nonstandard systems.

^bIncidental cables in open wire lines.

^cL = coil inductance, millihenries.

^df_c = theoretical loading cut-off frequency, cycles.

^eZ = nominal impedance, $\sqrt{L/C}$, estimated from coil inductance and loading cut-off frequency, where C is the capacitance in farads per loading section.

^fApproximate relations of wire diameters; figures in parentheses give the B&S gauge diameters in μ m.

mm	vs B&S Gauge
0.80	20 (0.812)
0.90	19 (0.912)
1.00	18 (1.024)
1.23	16 (1.29)
1.30	16 (1.29)
1.40	15 (1.45)
1.50	15 (1.45)
1.80	13 (1.83)

^gUnderground cables unless otherwise indicated.

Table continued on next page.

TYPES OF COIL LOADED CABLE CIRCUITS IN INTERNATIONAL TELEPHONE FACILITIES.
(Continued)

Spacing of Loading Coils		Loaded Pairs ^g			Loaded Phantoms			Wire Size ^f (diameter in mm)
(meters)	(feet)	L ^c (mh)	f _c ^d (cycles)	Z ^e (ohms)	L ^c (mh)	f _c ^d (cycles)	Z ^e (ohms)	
<u>ENGLAND</u>								
1810	5940	177 ^a	2770	1550	107 ^a	3040	1000	0.90;1.00;1.27
1830	6000	44 ^a	5570	800	25 ^a	6300	500	0.90
1830	6000	86 ^a	3920	1100				0.90
3700	12120	136	2240	950				1.27
<u>ESTONIA</u>								
2120	6950	72	2440	550	36	2440	300	2.38 (Submarine to Finland)
<u>FINLAND</u>								
1610	5280	27	8500	700				0.90
2200	7220	36	5600	650	(u.g. and submarine to Sweden)			1.0;1.27
2200	7220	129	3000	1200	(u.g. and submarine to Sweden)			1.50
3550	11640	11	8500	300	(u.g. and submarine to Sweden)			1.00
<u>FRANCE</u>								
1830	6000	22 ^b	8060	550	9 ^b	10000	300	0.80;0.90
1830	6000				18 ^b	7000	400	0.90;1.10;1.20; 1.30
1830	6000	44 ^a	5800	800	25 ^b	6000	500	0.90;1.10;1.20; 1.30
1830	6000				44	4500	600	0.90;1.20
1830	6000	86 ^a	4100	1150	36	5000	550	0.90;1.20
1630	6000	110	3600	1250	63	3600	700	0.90;1.10;1.30; 1.40
1830	6000	177 ^a	2900	1600	63 ^a	3750	750	0.90;1.20;1.30
1830	6000	177 ^a	2800	1550	107 ^a	2900	1000	0.90;1.10;1.20; 1.30
1830	6000				110	3600	1250	0.90
2000	6560	50 ^a	5430	850	20 ^a	6830	450	0.90
2000	6560	190 ^a	2690	1600	70 ^a	3465	750	1.40
2000	6560	200 ^a	2710	1700	70 ^a	3670	800	0.90

^aLoading standards approved by C.C.I.F. which are likely to be more widely used than nonstandard systems.

^fApproximate relations of wire diameters; figures in parentheses give the B&S gauge diameters in mm.

^bStandard carrier, 1 channel.

mm vs B&S Gauge

^c L = coil inductance, millihenries.	0.80	20 (0.812)
	0.90	19 (0.912)
^d f _c = theoretical loading cut-off frequency, cycles.	1.10	18 (1.024)
	1.20	17 (1.15)
	1.27	16 (1.29)
	1.30	16
^e Z = nominal impedance, $\sqrt{L/C}$, estimated from coil inductance and loading cut-off frequency, where C is the capacitance in farads per loading section.	1.40	15 (1.45)

^gUnderground cables unless otherwise indicated.

Spacing of Loading Coils		Loaded Pairs ^f			Loaded Phantoms			Wire Size ^g (diameter in mm)
(meters)	(feet)	L ^b (mh)	f ₀ ^c (cycles)	Z ^d (ohms)	L ^b (mh)	f ₀ ^c (cycles)	Z ^d (ohms)	
GERMANY								
1000	3280	105	5300	1750	(submarine to Switzerland)			2.05
1550	5090	23 ^a	8130	600	11 ^a	9400	350	2.00
1650	5410	37	7130	850				1.03
1650	5410	155	3270	1600				1.03
1650	5410	155	3200	1550				1.20
1700	5580	30 ^d	7470	700	12 ^d	9300	350	0.90;1.00;1.15; 1.40
1700	5580	140 ^a	3500	1550	56 ^a	4400	800	0.90;1.05;1.40
1700	5580	140 ^a	3400	1500	56 ^a	4270	750	1.40
1700	5580	170	3220	1700	68	4120	900	0.90;1.05;1.40
1700	5580				68	3880	850	1.40
1830	6000				18 ^a	7000	400	0.90;1.40
1830	6000	18	9300	550				0.90;1.40
1830	6000	44 ^a	5900	800	25 ^a	6000	500	0.90;1.30
1830	6000	50	5780	900	20	7000	450	1.50
1800	5910	85	4570	1250	35	5550	600	1.40
1830	6000	177 ^a	2900	1600	63 ^a	3600	700	0.90;1.30;1.40; 1.50
1860	6100	54	4800	800	(u.g. and submarine to Germany)			1.00;1.05
1880	6170	50	5510	850	35	5550	600	1.40
1900	6240	30	6500	600	(u.g. and submarine to Sweden)			1.20
2000	6560	44	5800	800				0.90;1.00
2000	6560	50 ^a	5430	850	20 ^a	6830	450	0.90;1.00
2000	6560	190 ^a	2710	1600	70 ^a	3660	800	1.40;1.50
2000	6560	200 ^a	2710	1700	70 ^a	3660	800	0.90
2200	7220	36	5400	600	(u.g. and submarine to Sweden)			1.50
2208	7250	47	4900	700	(u.g. and submarine to Denmark)			1.00
3295	10500	14.5	7000	300	(u.g. and submarine to Denmark)			1.00
4680	15400	46.8	3200	450	(u.g. and submarine to Germany)			1.50

^aLoading standards approved by C.C.I.F. which are likely to be more widely used than nonstandard systems.

^b L = coil inductance, millihenries.

^c f₀ = theoretical loading cut-off frequency, cycles.

^d Z = nominal impedance, $\sqrt{L/C}$, estimated from coil inductance and loading cut-off frequency, where C is the capacitance in farads per loading section.

^gApproximate relations of wire diameters; figures in parentheses give the B&S gauge diameters in mm.

mm	vs B&S Gauge
0.90	19 (0.912)
1.00	18
1.03	18 (1.024)
1.05	18
1.15	17 (1.15)
1.30	16 (1.29)
1.40	15 (1.45)
1.50	15 (1.45)

^fUnderground cables unless otherwise indicated.

Table continued on next page.

TYPES OF COIL LOADED CABLE CIRCUITS IN INTERNATIONAL TELEPHONE FACILITIES.
(Continued)

Spacing of Loading Coils		Loaded Pairs ^f			Loaded Phantoms			Wire Size ^g (diameter in mm)
(meters)	(feet)	L ^b (mh)	f _c ^c (cycles)	Z ^d (ohms)	L ^b (mh)	f _c ^c (cycles)	Z ^d (ohms)	
<u>HOLLAND</u>								
1634	5350	30	7800	750				0.80;1.24;1.59
1630	5350	50	5500	850				1.20;1.29
1630	5350	60	5200	1000				0.87
1630	5350	75	5000	1200				1.12
1630	5350	155	3200	1550				1.29;1.59;1.60
1630	5350	160	3200	1600				0.87;1.11;1.60
1630	5350	200	2900	1800				1.12;1.24;1.60;
								1.69
1647	5350	32	7130	750				1.03
1650	5350	155	3200	1550				1.03;1.20;1.60
1700	5580	30 ^a	7470	700	12 ^a	9300	350	0.90
1700	5580	140 ^a	3410	1500	56 ^a	4300	750	0.90;1.40
1700	5580	140 ^a	3500	1550	56 ^a	4400	800	0.90;1.40
1700	5580	170	3120	1650				0.90;1.40
1700	5580	177 ^a	3220	1800				0.90;1.40
1700	5580	190	2740	1650	70 ^a	3880	850	0.90;1.40
1757	5760	44	5900	800	25	6100	500	1.23
1757	5760	177	3000	1700	63	4000	800	1.23;1.80
1757	5760	177	3000	1700	107	2900	1000	1.80
1840	6040	44 ^a	5500	760	25 ^a	6000	500	1.20;1.23
1840	6040	177 ^a	2800	1550	63 ^a	3600	700	1.23;1.80
1840	6040	177 ^a	2800	1550	107 ^a	3000	1000	1.20;1.23;1.80
2788	9150	80	3600	900				0.80
3268	10720	55	3500	600				0.70
3268	10720	65	3500	700				0.80
3268	10720	85	3200	850				0.80
3680	12080	65	3400	700				0.80
4500	14700	55	3400	600				0.70

^aLoading standards approved by C.C.I.F. which are likely to be more widely used than nonstandard systems.

^bL = coil inductance, millihenries.

^cf_c = theoretical loading cut-off frequency, cycles.

^dZ = nominal impedance, $\sqrt{L/C}$, estimated from coil inductance and loading cut-off frequency, where C is the capacitance in farads per loading section.

^eApproximate relations of wire diameters; figures in parentheses give the B&S gauge diameters in mm.

mm	vs	B&S Gauge
0.70		21 (0.723)
0.80		20 (0.812)
0.87		19
0.90		19 (0.912)
1.03		18 (1.024)
1.12		17 (1.15)
1.20		17
1.24		16 (1.29)
1.40		15 (1.45)
1.60		14 (1.63)
1.69		14

^fUnderground cables unless otherwise indicated.

Spacing of Loading Coils		Loaded Pairs ^g			Loaded Phantoms			Wire Size ^f (diameter in mm)
(meters)	(feet)	L ^c (mh)	f _c ^d (cycles)	Z ^e (ohms)	L ^c (mh)	f _c ^d (cycles)	Z ^e (ohms)	
<u>HUNGARY</u>								
1830	6000	44 ^a	5800	800	25 ^a	6000	500	0.90;1.30
1830	6000	177 ^a	2900	1600	63 ^a	3600	700	0.90;1.30
3000	9850	90	3000	850				2.0
<u>ITALY</u>								
1830	6000	44 ^a	5800	800	18 ^a	7000	400	0.90;1.10
1830	6000	44 ^a	5800	800	25 ^a	6000	500	0.90;1.10
1830	6000	177 ^a	2900	1600	63 ^a	3600	700	0.90;1.30
1830	6000	177 ^a	2900	1600	107 ^a	2900	1000	0.90
<u>LUXEMBURG</u>								
1830	6000	177	2900	1600	63	3750	750	1.30
<u>NORWAY</u>								
1600	5230	27 ^b	7800	650	11 ^b	9600	350	0.90;1.00
1600	5230	132	3500	1450				1.40
2800	9150	100	3000	950				1.00
<u>POLAND</u>								
1000	3280	13	15000	600				1.30
1830	6000	44 ^a	5800	800	25 ^a	6000	500	0.90
1830	6000	177 ^a	2900	1600	63 ^a	3600	700	0.90;1.30
2000	6560	50 ^a	5430	850	20 ^a	6840	450	0.90
2000	6560	170	2710	1450				0.90
2000	6560	190 ^a	2740	1650	70 ^a	3670	800	0.90;1.40
2000	6560	200 ^a	2750	1750	70 ^a	3520	800	0.90;1.40
<u>ROUMANIA</u>								
1830	6000	120	3500	1300				0.90

^aLoading standards approved by C.C.I.F. which are likely to be more widely used than nonstandard systems.

^fApproximate relations of wire diameters; figures in parentheses give the B&S gauge diameters in mm.

^bIncidental cables in open wire lines.

^cL = coil inductance, millihenries.

^df_c = theoretical loading cut-off frequency cycles.

^eZ = nominal impedance, $\sqrt{L/C}$, estimated from coil inductance and loading cut-off frequency, where C is the capacitance in farads per loading section.

mm vs B&S Gauge

0.90	19 (0.912)
1.00	18 (1.024)
1.10	17 (1.15)
1.30	16 (1.29)
1.40	15 (1.45)
2.00	12 (2.05)

^gUnderground cables unless otherwise indicated.

Table continued on next page.

TYPES OF COIL LOADED CABLE CIRCUITS IN INTERNATIONAL TELEPHONE FACILITIES.
(Continued)

Spacing of Loading Coils		Loaded Pairs ^g			Loaded Phantoms			Wire Sizes ^f (diameter in mm)
(meters)	(feet)	L ^c (mh)	f _c ^d (cycles)	Z ^e (ohms)	L ^c (mh)	f _c ^d (cycles)	Z ^e (ohms)	
SWEDEN								
1585	5200	132	3500	1450				0.90;1.20
1590-1610	5250	27 ^b	7800	650	11 ^b	9600	350	0.90;1.00;1.10; 1.20
1810-1820	5950	24	7800	600	10	9600	300	0.90
1810-1820	5950	44 ^a	5800	800	18 ^a	7000	400	0.90
1810-1820	5950	44 ^a	5800	800	25 ^a	6000	500	0.80;0.90;1.10; 1.30
1810-1820	5950	177 ^a	2900	1600				0.80
1900	6230	30	6500	600	(u.g. and submarine to Germany)			1.20
2200	7220	36	5600	650	(u.g. and submarine to Germany)			1.00 and 1.50
2200	7220	36	5400	600				1.50
2200	7220	129	3000	1200				1.30
2400	(7880	18	7650	450				1.00
to	{ to	36	5400	600	(Aerial)			1.30
		90	3400	950				1.30
2464	(8090	115	3200	1150	(u.g. and submarine to Denmark)			1.15
2500	8210	36	5400	600				1.30
2600	8530	18	7650	450				0.70;1.00
3550	11650	11	8500	300				1.00
3880	12700	60	3550	650				1.40
SWITZERLAND								
1830	6000				20	7000	450	0.90
1830	6000	44 ^a	5800	800	18 ^a	7000	400	0.90
1830	6000	44 ^a	5900	800	25 ^a	6000	500	0.90
1830	6000	88 ^a	4100	1150				0.90
1830	6000	177 ^a	2900	1600	63 ^a	3750	750	0.80;0.90;1.30; 1.40;1.50
1830	6000	177 ^a	2900	1600	107 ^a	2900	1000	0.80;0.90;1.30; 1.40;1.50
2000	6560	50 ^a	5430	850	20 ^a	6830	450	0.90
2000	6560	177	2950	1600				1.00
2000	6560	190 ^a	2690	1600	70 ^a	3465	750	1.40
2000	6560	200 ^a	2710	1700	70 ^a	3600	800	0.90
2000	6560				107	2950	1000	1.00

^aLoading standards approved by C.C.I.F. which are likely to be more widely used than nonstandard systems.

^bIncidental cables in open wire lines.

^cL = coil inductance, millihenries.

^df_c = theoretical loading cut-off frequency, cycles.

^eZ = nominal impedance, $\sqrt{L/C}$, estimated from coil inductance and loading cut-off frequency, where C is the capacitance in farads per loading section.

^fApproximate relations of wire diameters; figures in parentheses give the B&S gauge diameters in mm.

mm	vs	B&S Gauge
0.80		20 (0.812)
0.90		19 (0.912)
1.00		18 (1.024)
1.10		17 (1.15)
1.20		17 (1.15)
1.30		16 (1.29)
1.40		15 (1.45)
1.50		15 (1.45)

^gUnderground cables unless otherwise indicated.

706. C.C.I.F. STANDARD LOADING SYSTEMS.

a. Data regarding the loading standards for voice-frequency telephone circuits, recommended by the international consultative committee on telephony (C.C.I.F.) for use on repeater sections in international telephone circuits are given in paragraph 707. Paragraph 707a

applies to systems which were standards in 1934. The older standards which were recommended for new facilities in 1924-1934 are listed in paragraph 707b. Special facilities such as program circuits and carrier circuits which require wider frequency bands than those indicated are not included.

707. LOADING SYSTEMS FOR REPEATER SECTIONS IN INTERNATIONAL TELEPHONE CIRCUITS.**a. 1934-1939 Standard Systems, Recommended for New Facilities.**

Loading Systems Designation ^a	Circuit	Cable Data		Nominal Cut-off Frequency (cycles)	Nominal Impedance (ohms)	Nominal Velocity (mi/sec)	Max-Avg ^c Attenuation at 800 Cycles (db/mi)
		Diameter ^b Wire (mm)	Capacitance (mf/mi)				
6000-44-25	Side	0.9	.062	5800	790	20400	0.55
	Phantom	0.9	0.101	6000	470	20400	0.46
	Side	1.3	.062	5800	790	20400	0.28
	Phantom	1.3	0.101	6000	470	20400	0.23
6000-44-18	Side	0.9	.062	5800	790	20400	0.55
	Phantom	0.9	0.101	7000	400	24900	0.54
6562-50-20	Side	0.9	.054	5340	855	20850	0.43
	Phantom	0.9	.087	6840	440	26750	0.49
5577-30-12	Side	0.9	.054	7700	730	25500	0.55
	Phantom	0.9	.087	9300	370	31100	0.54
	Side	1.4	.057	7250	710	24250	0.23
	Phantom	1.4	.092	9000	360	29800	0.23
6000-88-50	Side	0.9	.062	4100	1120	14400	0.39
	Phantom	0.9	0.101	4200	670	14400	0.33
6000-88-36	Side	0.9	.062	4100	1120	14400	0.38
	Phantom	0.9	0.101	5000	560	19800	0.38
3000-88-50	Side	0.9	.062	5800	1590	10250	0.32
	Phantom	0.9	0.101	6000	940	10250	0.27
3000-88-36	Side	0.9	.062	5800	1590	12560	0.31
	Phantom	0.9	0.101	7000	800	10260	0.31

^a Loading Designations: The first number applies to the nominal standard coil spacing in feet, and the second number to the side circuit coil (or nonphantomed coil) inductance in mh. The third number, when present is the phantom coil inductance in mh.

^b Approximate relations of wire diameters; figures in parentheses give the B&S gauge diameters in mm.

mm	vs B&S Gauge
0.8	20 (0.812)
0.9	19 (0.912)
1.3	16 (1.29)
1.4	15 (1.45)

^c These figures are C.C.I.F. limits on the average attenuation constant for all circuits of one type, per repeater section, when the loading spacing conforms to C.C.I.F. rules.

Table continued on next page.

LOADING SYSTEMS FOR REPEATER SECTIONS IN INTERNATIONAL TELEPHONE CIRCUITS. (Continued)

b. Old Standard Systems, in Use 1939, but not Recommended for New Facilities.

Loading Systems Designation ^a	Circuit	Cable Data		Nominal Cut-off Frequency (cycles)	Nominal Impedance (ohms)	Nominal Velocity (mi/sec)	Max-Avg ^c Attenuation at 800 Cycles (db/mi)
		Diameter ^b Wire (mm)	Capacitance (mf/mi)				
5577-140-56	Side	0.9	.054	3500	1570	11810	0.27
	Phantom	0.9	.087	4400	760	14920	0.27
	Side	1.4	.057	3400	1520	11180	0.13
	Phantom	1.4	.092	4300	760	14300	0.13
6000-177-63	Side	0.9	.062	2900	1590	10250	0.30
	Phantom	0.9	0.101	3600	740	13370	0.32
	Side	1.3	.062	2900	1590	10250	0.17
	Phantom	1.3	0.101	3600	740	13370	0.18
6000-177-107	Side	0.9	.062	2900	1590	10250	0.30
	Phantom	0.9	0.101	2900	970	10250	0.25
	Side	1.3	.062	2900	1590	10250	0.17
	Phantom	1.3	0.101	2900	970	10250	0.14
6562-200-70	Side	0.9	.054	2750	1730	10750	0.28
	Phantom	0.9	.087	3670	805	14300	0.29
6562-190-70	Side	1.4	.057	2740	1630	10690	0.14
	Phantom	1.4	.092	3520	775	13800	0.14
6000-120	Side	0.9	.062	3340	1260	12000	0.37
	Side	1.3	.062	3340	1260	12000	0.20
10730-65	Side	0.8	.056	3500	800	22370	0.63

^a **Loading Designations:** The first number applies to the nominal standard coil spacing in feet, and the second number to the side circuit coil (or nonphantomed coil) inductance in mh. The third number, when present is the phantom coil inductance in mh.

^b Approximate relations of wire diameters; figures in parentheses give the B&S gauge diameters in mm.

mm	vs	B&S Gauge
0.8		20 (0.812)
0.9		19 (0.912)
1.3		16 (1.29)
1.4		15 (1.45)

^c These figures are C.C.I.F. limits on the average attenuation constant for all circuits of one type, per repeater section, when the loading spacing conforms to C.C.I.F. rules.

708. UNITED STATES LOADING SYSTEMS. Data on loaded quadded cables, which are usually employed in long distance circuits; and nonquadded cables, which are usually employed in exchange area circuits; are given in paragraph 709.

All of these facilities are employed on voice-frequency circuits except B-22-N which is primarily for program circuits. Paragraph 710 gives data on incidental cables commonly used for open wire lines.

709. LOADING SYSTEMS COMMONLY USED IN THE UNITED STATES OF AMERICA.a. Quadded Cables^ab. Nonquadded Cables

Loading ^{b,c}	Nominal ^d Impedance (ohms)	Cut-off Frequency (cycles)	1000-cycle Loss per Mile at 55°F. (decibels)		Gauge ^e Cable B&G	Loading ^b	Nominal ^d Impedance (ohms)	Cut-off Frequency (cycles)	1000-cycle Loss per Mile at 65°F. (decibels)
			19 Ga.	16 Ga.					
B-88-50-S	1550	5600	0.28	0.16	26	nonloaded	1010	-	2.67
B-88-50-P	950	5900	0.23	0.14		H-88	1050	3800	1.68
H-174-106-S	1550	2900	0.28	0.16	24	nonloaded	780	-	2.14
H-174-106-P	650	2900	0.22	0.13		H-44	750	5300	1.46
H-172-63-S	1550	2900	0.27	0.16	22	H-88	1050	3700	1.13
H-172-63-P	750	3700	0.28	0.16		B-88	1450	5300	0.86
H-88-50-S	1100	4000	0.35	0.19	22	nonloaded	580	-	1.79
H-88-50-P	650	4200	0.30	0.16		H-44	700	5000	1.04
H-44-25-S	800	5600	0.47	0.25	19	H-88	1000	3500	0.79
H-44-25-P	500	5900	0.39	0.21		B-88	1400	5000	0.60
B-22-N	800	11000	0.45	0.24	19	B-135	1700	4000	0.48
H-44-N	800	5600	0.47	0.25		nonloaded	400	-	1.26
H-88-N	1100	4000	0.35	0.19	H-44	700	5000	0.56	
					H-88	950	3500	0.42	
					B-88	1350	4900	0.34	
					B-135	1700	3900	0.26	

^aCapacitance of quadded cables = 0.062 mf per mile (side); 0.102 mf per mile (phantom)

^bThe first letter indicates the coil spacing (H = 5000 ft. and B = 3000 ft.); the first and second numbers indicate the inductances (millihenrys) of the side and phantom loading coils, respectively; and the last letter indicates whether it is a side circuit (S), a phantom circuit (P) or a non-phantomed pair (N).

^cThe following Western Electric Co. loading units used in loading quadded cables in the United States may be of potential interest for use in rehabilitating loaded quadded cables in invaded territory. These loading units have similar over-all potting dimensions, and are procurable on special order in three types of cases suitable for underground cable, for buried cable, and for aerial cable, in complements of 6, 12, 18, 24, and 30 units.

Code Number	Inductance - mh		Resistance - Ohms			
	Side Circuits	Phantom	Side Circuit		Phantom	
			D.C.	1000	D.C.	1000
MF-1	172	63	13.8	16.4	6.9	7.6
MF-2	44	25	4.5	5.0	2.2	2.5
MF-4	31	18	3.1	3.4	1.5	1.7
MF-11	88	50	7.9	9.1	4.0	4.6

^dFor loaded cable $Z = \sqrt{\frac{L}{C}}$; where L is loading coil inductance and C is loading section capacitance.

For nonloaded cable $Z = \sqrt{\frac{R}{2\pi f C}}$; where R and C are the resistance and capacitance per unit length and f is the frequency (1000 cycles assumed).

^eTransmission data apply to nonquadded cables having the following capacitance:

26 gauge = 0.069 mf per mile
 24 gauge = 0.072 mf per mile
 22 gauge = 0.082 mf per mile
 19 gauge = 0.084 mf per mile

710. LEAD-COVERED ENTRANCE AND INTERMEDIATE CABLES IN OPEN WIRE LINES COMMONLY USED IN THE UNITED STATES OF AMERICA.

a. Sides or Phantoms, Paper-Insulated, Twisted Pair Quads.

R&S Gauge	Description Loading ^a	Nominal Impedance (ohms) ^b	Cut-off Frequency (kc)	Attenuation per Mile at 55°F - db		
				1 Kc	8 Kc	30 Kc
19	Nonloaded Side	140	-	1.06	2.31	3.02
16	Nonloaded Side	130	-	0.71	1.32	1.87
13	Nonloaded Side	125	-	0.47	0.96	1.32
19	Nonloaded Phantom	195-1175	-	0.95	-	-
16	Nonloaded Phantom	140-1115	-	0.63	-	-
13	Nonloaded Phantom	115-173	-	0.41	-	-
19	H-31-18-Side	666	6.7	0.55	-	-
16	H-31-18-Side	666	6.7	0.28	-	-
13	H-31-18-Side	666	6.7	0.15	-	-
19	H-31-18-Phantom	403	7.0	0.46	-	-
16	H-31-18-Phantom	403	7.0	0.24	-	-
13	H-31-18-Phantom	403	7.0	0.13	-	-
19	BH-15-15-Side	640	13.5	0.63	0.74	-
16	BH-15-15-Side	640	13.5	0.36	0.47	-
19	BH-15-15-Phantom	387	7.3	0.53	-	-
16	BH-15-15-Phantom	387	7.3	0.30	-	-
19	CE-4.8-12.8 Side ^c	640	41.5	0.68	0.76	1.34
16	CE-4.8-12.8 Side ^c	640	41.5	0.41	0.49	1.09
16	CE-4.1-12.8 Side ^c	600	45	0.43	0.50	1.01
13	CE-4.1-12.8 Side ^c	600	45	0.28	0.36	0.89
19	CE-4.8-12.8 Phantom	373	8.5	0.60	-	-
16	CE-4.8-12.8 Phantom	373	8.5	0.36	-	-
13	CE-4.1-12.8 Phantom	373	8.5	0.23	-	-
19	C-4.8 Modified	625	40.5	0.67	0.76	1.37
13	C-4.1 Modified	558	42.5	0.28	0.37	0.96

b. Sides of Disc-Insulated (Low Capacitance)^d Spiral-Four Quads.

16	Nonloaded	240	-	0.44	0.81	1.11
16	J-0.72	542	208	0.41	0.5	0.64
16	J-0.85	575	190	0.41	0.5	0.64
16	J-0.94	600	181	0.41	0.5	0.64

^aIn the loading designations, such as H-31-18, the letter designates the loading spacing, the first number is the inductance of the side circuit loading coil and the second, the inductance of the phantom loading coil, both expressed in millihenries. Where two letters are used, the first is the spacing of the side circuit loading coils and the second is the spacing of the phantom circuit coils. Where only one letter and one number is in the designation, it indicates the phantom is nonloaded. The theoretical loading spacings are as follows:

Letter Designation	Spacing in Feet
H	6000
E	5575
B	3000
C	930
J	640 Approx.

Loading coils are spaced at the theoretical spacing or at a shorter spacing, and the circuits built out to the equivalent of the theoretical spacing by means of building-out cable or capacitance units. On C- or J-spaced loading it is customary to shorten the spacing to allow for capacitance deviations in the cable pairs, and for unavoidable geographical irregularities. Building-out capacitance is then applied to obtain the ideal loading section capacitance on all carrier loaded pairs. The attenuation data on this table apply to the following coil spacings:

Designation	Spacing (feet)	Building-out
H-31-18 Side and Phantom	6000	None
BH-15-15 Side	3000	None
BH-15-15 Phantom	6000	None
CE-4.8-12.8 Side	800	Built out to equivalent of 930 feet
CE-4.8-12.8 Phantom	4800	Built out to equivalent of 5575 feet
CE-4.1-12.8 Side and Phantom	Same as CE-4.8-12.8 Side and Phantom	
C-4.1 Modified	800	Built out to get 558 ohm nominal impedance
C-4.8 Modified	800	Built out to get 625 ohm nominal impedance
J-0.72	528	Built out to equivalent of 633 feet
J-0.85 and J-0.94	528	Built out to equivalent of 648 feet

^bThe impedance given for nonloaded side circuits is approximately the impedance at carrier frequencies; for the phantom, it is the 1000-cycle characteristic impedance.

^cThe attenuations of standard C-4.1 and C-4.8 (non-phantomed) pairs are about .02 db less than for CE-4.1-12.8 and CE-4.8-12.8 (phantomed) pairs.

^d.025 mf per mile.

Section II
Existing Submarine (Undersea) Cables

711. GENERAL. This section describes some existing undersea cables which may be of military value in future operations.

712. PAPER-INSULATED TELEPHONE CABLES

a. The paper-insulated, lead-sheathed type of cable is usually found where the water is of moderate depth, large numbers of circuits are required, and the length of cable is not great, usually under 100 miles. Most of these cables have double-lead sheaths and in some instances a rubber jacket is used over the sheath.

b. Paragraph 713 describes some paper-insulated cables having one terminal in Great Britain, all of which are made up of spiral-four type quads. All except cables 5 and 7 were made in England. These two are German made cables.

c. Some cables, typified by item 1 paragraph 713, provided 16 voice-frequency and four carrier-frequency circuits on eight pairs of wires. Super-phantoms are worked at voice frequencies. The cable indicated by item 9 is a unique application of intermittent continuous loading. Each 1/8 nautical mile length of cable has 15 quads of nonloaded conductors separated by a transverse shield

of metallized paper from 15 quads of continuously loaded conductors, which have the same diameter over the loading as the nonloaded conductors. The (1/8 mi) lengths are systematically spliced together so that each through circuit consists of alternate sections of loaded and nonloaded conductors, with an average inductance of the order of .024 henry per nautical mile, and a theoretical cut-off frequency of about 30 kc. A voice and carrier channel are used on each pair, giving a total of 60 four-wire type circuits on the side circuits of the quads. Each quad of the nonloaded cable, item 6, is individually shielded with metallized paper and operated four-wire, with a carrier circuit in addition to the voice.

d. Paragraph 714 describes a number of German-made submarine cables installed in the Baltic Area, or North Sea. Although the phantoms of these cables may be used, loading is restricted to the side circuits where coil loading is employed. The cut-off frequencies of most of these cables are sufficiently high to permit two-band telephony. This allows equivalent four-wire operation, by means of voice-frequency channels for one direction of transmission and a carrier channel just above the voice for the opposite direction. Some of these cables are laid in water that is deeper than is considered safe for cables of ordinary structure, and a steel reinforcing band is used under the lead sheath.

713. PAPER-INSULATED QUADDED SUBMARINE CABLES - BRITISH ISLES

Item No.	Cable	Year	Type of Loading	Length Naut. (Miles)	Conductors (No.)	Diam. (inches)	Loss db per Naut. Mile at 800 Cycles		Nominal Impedance (ohms)	
							Sides	Phantoms	Sides	Phantoms
<u>Anglo-Dutch</u>										
1	Aldeburgh-Domburg	1924	Continuous	82.3	16	.096	0.18	0.20	422	172
2	Aldeburgh-Domburg	1926	Continuous	86	16	.092	0.16	0.18	443	185
<u>Anglo-French</u>										
3	Seabrook-Andrecelles	1926	Continuous	23.9	28	.081	0.24	0.28	375	155
4	Seabrook-Andrecelles	1927	Continuous	25.2	28	.081	0.23	0.28	385	153
5	Seabrook-Le Portal	1930	Continuous	32	28	.071	0.23		470	
6	St. Margarete-Calais	1933	Nonloaded	26	76	.064	0.75		250	
<u>Anglo-Belgian</u>										
7	Dumpton Gap-La Panne	1926	Continuous	49.5	28	.08	0.24	0.29	392	160
8	Dumpton Gap-La Panne	1930	Continuous	50.5	28	.08	0.23	0.29	390	150
9	Dover-La Panne	1932	Intermittent-Continuous	49.5	60	.052 ^a	0.55		550	
					60	.036 ^b				
10	Mainland-Isle of Man	1929	Continuous	58.6	16	.081	0.25	0.30	367	151

^aNonloaded

^bLoaded

714. LOADED PAPER-INSULATED SPIRAL-FOUR SUBMARINE CABLES - GERMAN MADE

Item No.	Cable	Year	Type of Loading ^b	Length Neut. (miles)	Telephone Conductors (pairs) ^a	Diam. (inches)	Nominal Impedance (ohms)	Loss db per Neut. Mile 800 Cycles
1	Germany-Denmark	1902	Continuous	10.8	4	.055 ^c	220	0.14
2	Germany-Denmark	1907	Continuous	11.3	4	0.117	485	0.11
3	Germany-Denmark	1926	Coil	25	56 ^f	.039	750	0.42
4	Germany-Denmark	1931	Coil	25.1	88 ^f	.039	355	0.76
5	Festland-Borkum	1903	Continuous	17.2	4	.031 ^c	470	0.20
6	Festland-Sylt	1925	Coil	9.4	28	0.105	570	.07
7	Festland-Sylt	1925	Coil	8.7	28	.093	615	.07
8	Cuxhaven-Helgoland	1903	Continuous	40.9	2 ^d	0.164	310	0.10
9	Germany-Sweden	1919	Continuous	64.5	4	.082	380	0.20
10	(Zemvedin-Kampinge)	1921	Continuous	64.5	12	.080	470	0.21
11	Germany-Sweden	1927	Coil	63	48	.059	600	0.25
12	Germany-Sweden	1930	Coil	64	168	.047	600	0.36
13	<u>Pommern-East Prussia</u>							
14	(Leba-Tenkitten)	1920	Continuous	0.95	12	.086	470	0.20
15	(Leba-Pillau)	1922	Continuous	0.95	12	.075	470	0.20
15	Leba-Pillau	1930	Coil	100	68	.039	835	0.43
16	Leba-Dansig	1922	Continuous	80.2	16	.075	500	0.19
17	<u>Sweden-Finland</u>							
18	(West)Norrtaälje-Mariehamn	1928	Coil	34	32 ^e	.039	650	0.50
18	(East)Mariehamn-Åbo	1928	Coil	75	32 ^e	.059	650	0.34
19	Sweden-Gotlandland	1930	Coil	85	28	.047	600	0.35

^aSome cables have additional conductors for telegraph.

^bFor continuously loaded cables the impedance of phantom is about 1/2 that of side and loss of phantom is about equal to loss of side. In the coil cables the phantoms are not loaded. The side circuit loading coils are spaced approximately 1 neut. mi. apart giving cut-off frequencies in the range 4800-7000 cycles.

^c7 strands each having diameter indicated.

^dSingle pair - not spiral-four.

^e4 of the 32 conductors are coarser gauge than the other 28, for which size and loss data are given.

^fCables have a coarse-gauge shielded pair at their center for special facilities.

715. GUTTA-PERCHA, BALATA, PARAGUTTA AND RUBBER-INSULATED TELEPHONE CABLES

a. General. In most undersea cable projects, the paper-insulated lead-sheathed type of cable is not satisfactory because of the depth of the water or the presence of tidal currents. These factors have led to an extensive use of gutta-percha type cables, in European waters and elsewhere.

b. Multicore Cables. (1) In general, the multicore cables shown in paragraph 716 have four conductors, in spiral-four configuration. Three of the cables, items 15, 16, and 17, have only two continuously loaded conductors. Another exception is the cable indicated in item 14 which has four pairs of conductors arranged in a spiral-four configuration.

(2) In general, the cables that have four (or eight) conductors, are used for phantom working. The attenuation of the loaded phantoms is approximately equal to that in the loaded side circuits. In the coil loaded cables the loading coils are usually spaced at intervals of about 1 nautical mile, giving theoretical cut-off frequencies of the order of 2500 cycles.

(3) Some of the early multicore undersea cables, not listed in paragraph 716, were picked up to permit the installation along the same route of improved cable designs providing more facilities, particularly in the English Channel area. Since the available information on picked-up cables is incomplete, some of the cables listed in paragraph 716 may no longer exist.

(4) A rubber-insulated four-conductor (spiral-four) cable has been extensively used by the U. S. Coast Guard. The attenuation is about 0.35 db per nautical mile at 1000 cycles, and about 0.8 db at 10,000 cycles. This general type of cable is available with continuously loaded conductors. Although this loading reduces the lower frequency attenuation by about 40 per cent, the increased losses in the loading material, at high frequencies, more than offset the beneficial effect of the added inductance, so that the carrier-frequency attenuation of the loaded cable is greater than that of the nonloaded cable.

(5) Multicore cables are not suitable for use in water of depth greater than a few hundred fathoms.

c. Single Core Telephone Cables. (1) A cable containing a single conductor insulated with gutta-percha, paragutta, or rubber, can be employed for telephony. For a single relatively short circuit the armor and sea water can be used as a return conductor. The Coast Guard use a rubber-insulated core like that in their four-core cable. The single-core cable has an attenuation of about 0.5 db per nautical mile at 1,000 cycles per second.

(2) Between England and Guernsey (80 nautical miles) there was placed a length of the German Emden-Azores nonloaded single core telegraph cable captured in the

last war. The attenuation was 36 db at 1000 cycles and operation was by voice switching.

(3) Permalloy loaded telegraph cables are not satisfactory at telephone frequencies.

d. Concentric Return Type of Cable.

(1) For good telephone and carrier frequency transmission, a low resistance conductor inside the armor wire is needed for the return current. This conductor consists usually of copper tapes or wires laid on the surface of the insulation so as to form a complete cylindrical sheath. With this type of cable a number of channels can be used over considerable distances. The sea shields against static so that very low levels of reception can be employed. Cables of this type have been laid in the following places:

Australia to New Zealand
Tasmania, Cooks Strait
Japan, Hokkaido - Sakhalin
England to Holland, 2 cables
(Aldeburgh-Domburg) 81 nautical miles
Ireland to Scotland, 2 cables
(Donaghadee-Port Patrick) 21 nautical miles
Ireland to Wales, 2 cables
(Howth, near Dublin, to Nevin) 62 nautical miles
England to the Channel Islands

(2) With a single cable, different frequency bands are used for operation in the two directions, the permissible top-channel attenuation being around 100 db, or greater if man-made noise can be eliminated. Where two cables are available between two points they may be used to provide a four-wire circuit, one cable being used for one direction of transmission and the other cable for the opposite direction. The limiting attenuation is about the same as in the previous case. The impedance of this type of cable is about 50 ohms.

(3) Another cable of this type is Coast Guard No. 114P cable. The attenuation constant is 0.64 db per nautical mile at 10 kc and 1.08 db at 30 kc. The impedance is about 50 ohms.

(4) There is a concentric return cable with gutta-percha insulation between Teneriffe and the Canary Islands (40 nautical miles). The attenuation is 48 db at 38 kc. A smaller cable of this type has been laid between Algeciras and Ceuta, Morocco (20 nautical miles).

(5) There are a few concentric return cables with continuous loading. Such a cable between Italy and Sardinia has a central conductor 0.144" in diameter, insulated with gutta-percha 0.46" diameter, and provided with a return conductor consisting of 52 wires, each .032" in diameter. It is 146 nautical miles in length and has an attenuation at 2,000 cycles of 30 db. It was operated with one two-wire voice channel and a carrier channel with voice-operated switching.

716. LOADED MULTICORE GUTTA-PERCHA SUBMARINE CABLES

Item No.	Cable	Year	Type of Loading	Length Naut. Miles	No. Conductors	Weights		Nominal Impedance-Ohms Sides Phantoms	Loss db per Naut. Mile at 800 Cycles Sides and Phantoms
						Pounds per Naut. Mile Each	Conductor Dielectric		
<u>Anglo-French</u>									
1	Abbotts Cliffe-Cap Gris Nes	1910	Coil	20.2	4	160	300	860	0.14 ^a
2	Abbotts Cliffe-Cap Gris Nes	1912	Continuous	21	4	300	300	880	0.16 ^a
3	Dover-Sangatte	1917	Coil	21	4	310	200	340	0.10
4	Dover-Dunkirk	1917	Coil	41.6	4	310	200	340	0.10
5	Dover-Sangatte	1918	Coil	20.5	4	160	150	395	0.13
6	Dungeness-Audrecelles	1918	Coil	27.6	4	160	150	395	0.13
7	Dungeness-Audrecelles	1918	Coil	26.4	4	310	200	340	0.10
8	Abbotts Cliffe-Cap Gris Nes	1919	Coil	20	4	160	300	860	0.11
<u>Anglo-Irish</u>									
9	(Temple Patrick-Port Mores)	1922	Continuous	22	4	170	195	370	0.21
10	(Nevin, Wales-Howth)	1913	Coil	64	4	160	150	690	0.13
<u>Anglo-Dutch</u>									
11	Aldeburgh-Domburg	1922	Coil	82.5	4	160	150	780	0.13
<u>Denmark (Saelvig)</u>									
12	Denmark	1904	Continuous	21.6	4	160	150	270	0.11 ^a
13	Denmark	1915	Coil	21.5	4	110	100	755	0.18
14	Denmark	1919	Coil	59.3	8	155	180	345	0.80
15	Norway	1919	Continuous	80.8	2	155	180	365	0.20
16	Norway	1919	Continuous	161.7	2	155	180	365	0.19
17	Norway	1927	Continuous	27	2	155	180	365	.09
18	Sweden-Gotland	1919	Coil	72	4	350	210	650	0.370
19	British Government	1917	Coil	66	4	350	210	695	0.350
20	Nova Scotia	1928	Continuous	10	4	43	100	600	0.44
21	British Columbia (Georgia Strait)	1926	Continuous	26	4	165	196	310	0.23
<u>New Zealand</u>									
22	New Zealand	1925	Continuous	49	4	195	150	255	0.24
<u>Japan (Tsugaru Channel)</u>									
23	Japan (Tsugaru Channel)	1925	Continuous	45	4	160	195	375	0.20
24	Japan	1927	Continuous	71	4	170	200	375	0.20

^a Nonphantomed

717. TELEGRAPH CABLES.

a. A long telegraph cable consists mainly of a single-core deep-sea section, with steel-armor wires about .09" in diameter, each wire being covered with fabric tape in most cables. As shallow water is approached an intermediate armor of 0.2" diameter iron wires is employed and finally a heavy armor of 0.3" diameter wires. The shore section is usually a twin-core structure, the purpose of the second conductor being to obtain a ground for the receiving apparatus at a point well out from shore where there is less chance of picking up noise. On permalloy loaded telegraph cables this "sea earth" is extended to a depth of 100 fathoms and is terminated in a resistance which simulates the cable impedance so that any noise picked up is thereby reduced by about 20 db. In some cases a third core cable is used at the shore end, the third conductor being used as a ground for the sending battery in order to reduce the disturbing effect on other cables. The central conductor ranges from 107^m to 0.21" in diameter and is usually composed of a central wire surrounded by a layer of five or six copper tapes flattened against the wire. The thickness of insulation ranges from .09" to 0.13".

b. No loading was used in telegraph cables laid prior to 1924. The potential operating frequency of a nonloaded cable is about $f = 700(d/L)^2$ where d is the diameter of the central conductor in mils and L is the length of the cable in nautical miles. The speed in letters per minute is equal to 32f for siphon recorders and cable code or 25f for printers.

c. Most long telegraph cables laid since 1924 have been continuously loaded with permalloy tape or wire. A cable of this type has a traffic capacity about five times that of the corresponding non-loaded cable of the same dimensions. Such cables include the Azores-Emden cable, which reaches Germany via the English Channel and North Sea, the Belgian-Portugal cable belonging to the Italians, and cables in the Pacific and Indian oceans. They are designed to operate at frequencies of the order of 50 to 100 cycles per second. Multiplex operation is employed, with vacuum-tube amplifiers. Such equipment has been installed at Penzance, England; Emden, Germany; and Horta, in the Azores. A few permalloy cables have been designed for duplex operation but most of them operate in only one direction at a time, the direction of operation being controlled by automatic means at both terminals.

d. The attenuation constant of a long telegraph cable varies considerably with frequency so that the received signals are badly distorted. For nonloaded cables the means for correcting this distortion can be rather simple - a capacitor in series with the cable at each terminal, and an inductance shunted across the receiving instrument.

718. EUROPEAN CABLE MAP. A map of European submarine and land wire-communication circuits is shown in figure 701. This map was taken from a publication by Siemens and Halske "25 Jahre Fernkabel in Europa 1913-1938".

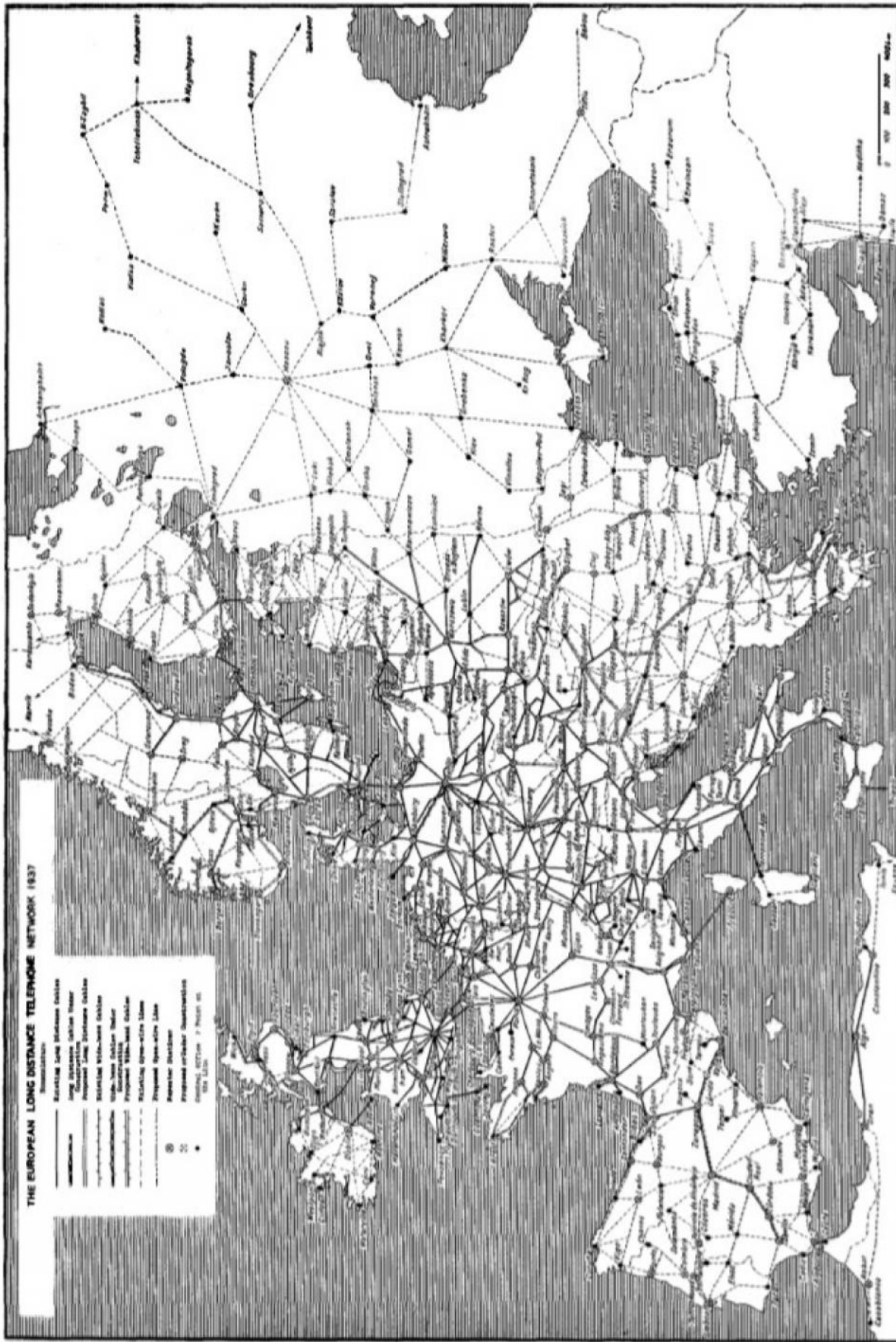

FIGURE 701. European Cable Map

**CHAPTER 8
ELECTRICAL PROTECTIVE EQUIPMENT**

801. GENERAL. The protective equipment listed in this chapter is available for use on electrical communications circuits to prevent damage from excessive voltages and currents which may be impressed on these circuits by lightning or accidental contact with or induction from power lines. The equipment herein listed is not intended to cover all protective equipment now manufactured; however, the various types which are listed are adequate for all ordinary requirements. Protector blocks, fuses,

and heat coils of one manufacturer are not necessarily suitable for use in protectors or protector mountings of another manufacturer and, in general, should be used only in protectors or protector mountings for which they are specifically recommended. Dimensions and shipping weights for such items as protector blocks, fuses, heat coils, and protectors for five pairs or less are not given, as they are small. Engineering information relative to the use of protective equipment on communication circuits may be found in **TM 11-483**.

802. PROTECTOR BLOCKS - DESCRIPTION AND STOCK NUMBERS.

<u>Manufacturer and Mfr.'s Code No.</u>	<u>Shown in Figure No.</u>	<u>Stock No.</u>	<u>Where Used</u>
Cook 41-190	801	None	41-190 and 41-3001 used in combination in Cook B-13 and O-9 Telephone Protectors and in Cook 7 Cable Protector.
Cook 41-3001	801	None	
Reliable P-495	802	4E695 or FTNP4E495	P-495 and P-197 used in combination in Reliable 955 and 1000 Telephone Protectors.
Reliable P-197	802		
Reliable P-663	802	--	P-495 and P-663 used in combination in Reliable 222 Cable Protector.
Western Electric Co. 26	803	4E926	26 and 27 used in combination in W. E. Co. 98A and 1093A Telephone Protectors and 1268 and 1269 Type Switchboard Protectors.
Western Electric Co. 27	803	4E927	
Western Electric Co. 30	803	4E930	26 and 30 used in combination in W. E. Co. 83A Cable Protector and in W. E. Co. EA26 and EA51 Cable Terminals.

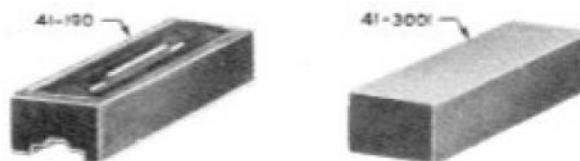

FIGURE 801. Telephone Protector Blocks (Cook)

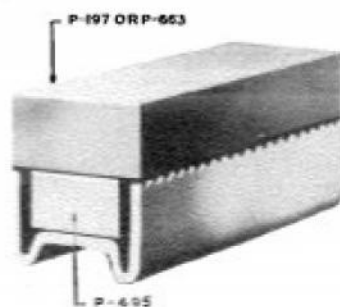

FIGURE 802. Telephone Protector Blocks (Reliable)

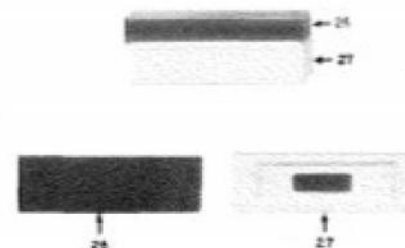

FIGURE 803. Protector Blocks (Western Electric Co. 26 & 27)

803. FUSES FOR TELKPHONE LINES - DESCRIPTION AND STOCK NUMBERS.

<u>Manufacturer and Mfr.'s Code No.</u>	<u>Shown in Figure No.</u>	<u>Stock No.</u>	<u>Ampere Rating</u>	<u>Where Used</u>
Cook A-9	804	3Z2433	5	Cook B-13 Telephone Protector. Cook O-9 Telephone Protector.
Cook A-12	804	3Z1910	5	
Reliable 55	805	3Z2607.2	7	Reliable 955 and 1000 Telephone Protectors. Reliable 303-F Switchboard Protector.
Reliable 106	805	3Z2495-1	7	
Western Electric Co. 11C	806	3Z2111C	7	W.E. Co. 98A and 1093A Telephone Protectors. W.E. Co. LA and LC Type Cable Terminals. W.E. Co. B51 and B101 Cable Terminals.
Western Electric Co. 7A	806	3Z2107A7	7	
Western Electric Co. 7T	806	3Z2107T	7	
Western Electric Co. 60D	807	3Z2160D	0.35	W.E. Co. LA and LC Type Cable Terminals where sneak current protection is required.
Western Electric Co. 60E	807	3Z2160E	1.25	



FIGURE 804. Fuse (Cook A-9 and A-12)

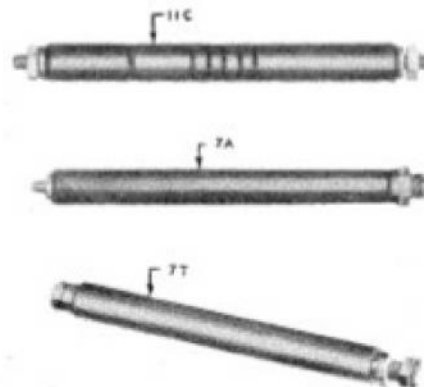

FIGURE 806. Fuse (Western Electric Co. 11C, 7A and 7T)

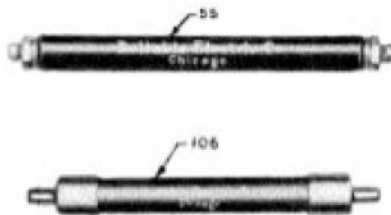

FIGURE 805. Fuse (Reliable 55 and 106)



FIGURE 807. Fuse (Western Electric Co. 60D or 60E)

804. HEAT COILS - DESCRIPTION AND STOCK NUMBERS.

<u>Manufacturer and Mfr.'s Code No.</u>	<u>Shown in Figure No.</u>	<u>Stock No.</u>	<u>Ampere Rating</u>	<u>Where Used</u>
Western Electric Co. 76A	808	5C476A	0.35	W. E. Co. 1268 and 1269 Type Switchboard Protectors.



FIGURE 808. Heat Coil (Western Electric Co. 76A)

805. TELEPHONE PROTECTORS FOR ONE PAIR OF WIRES - DESCRIPTION AND STOCK NUMBERS.

<u>Manufacturer and Mfr.'s Code No.</u>	<u>Shown in Figure No.</u>	<u>Stock No.</u>	<u>Location</u>	<u>Equipped with</u>
Cook B-15	809	4E4415	Indoors	41-190 and 41-3001 Protector Blocks in combination and A-9 Fuses.
Cook O-9	810	5C2209	Outdoors	Same as Cook B-15 except A-12 Fuses.
Reliable 955	811	None	Indoors	P-495 and P-197 Protector Blocks in combination and 55 Fuses.
Reliable 1000	812	2Z2855	Outdoors	Same as Reliable 955.
Western Electric Co. 98A	813	4E5098A	Indoors	26 and 27 Protector Blocks in combination and 11C Fuses.
Western Electric Co. 1093A	814	4E5193A	Outdoors	Same as W. E. Co. 98A.

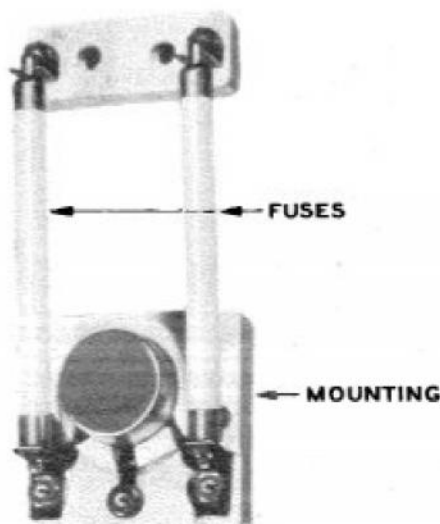

FIGURE 809. Telephone Protector (Cook B-15)

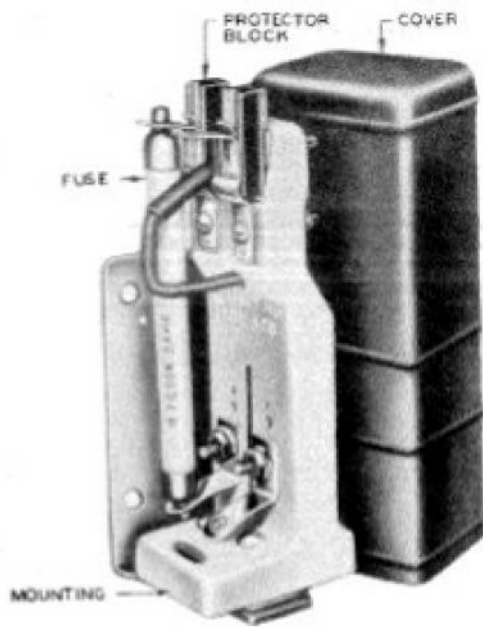

FIGURE 810. Telephone Protector (Cook 0-9)

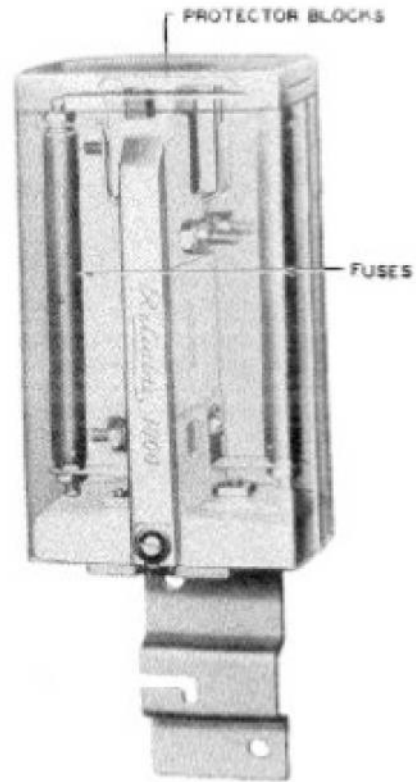

FIGURE 812. Telephone Protector (Reliable 1000)

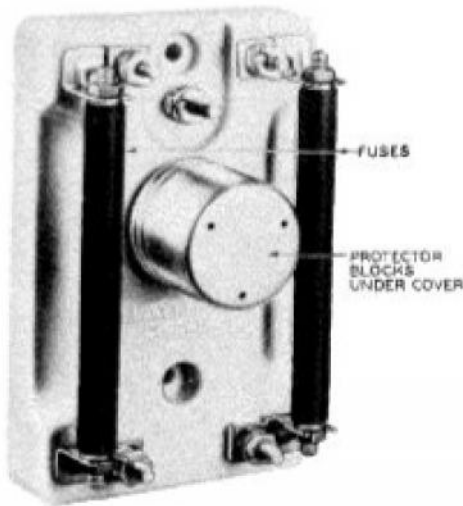

FIGURE 811. Telephone Protector (Reliable 955)

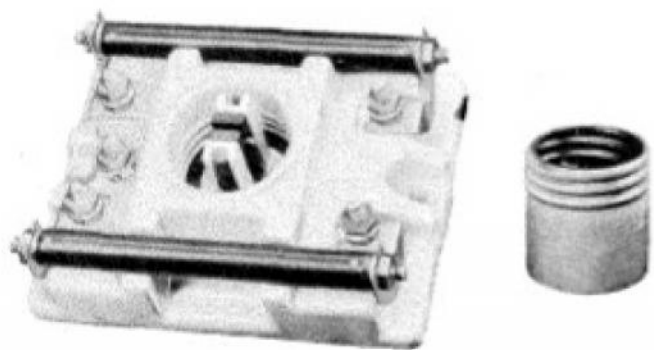

FIGURE 813. Telephone Protector (Western Electric Co. 98A)

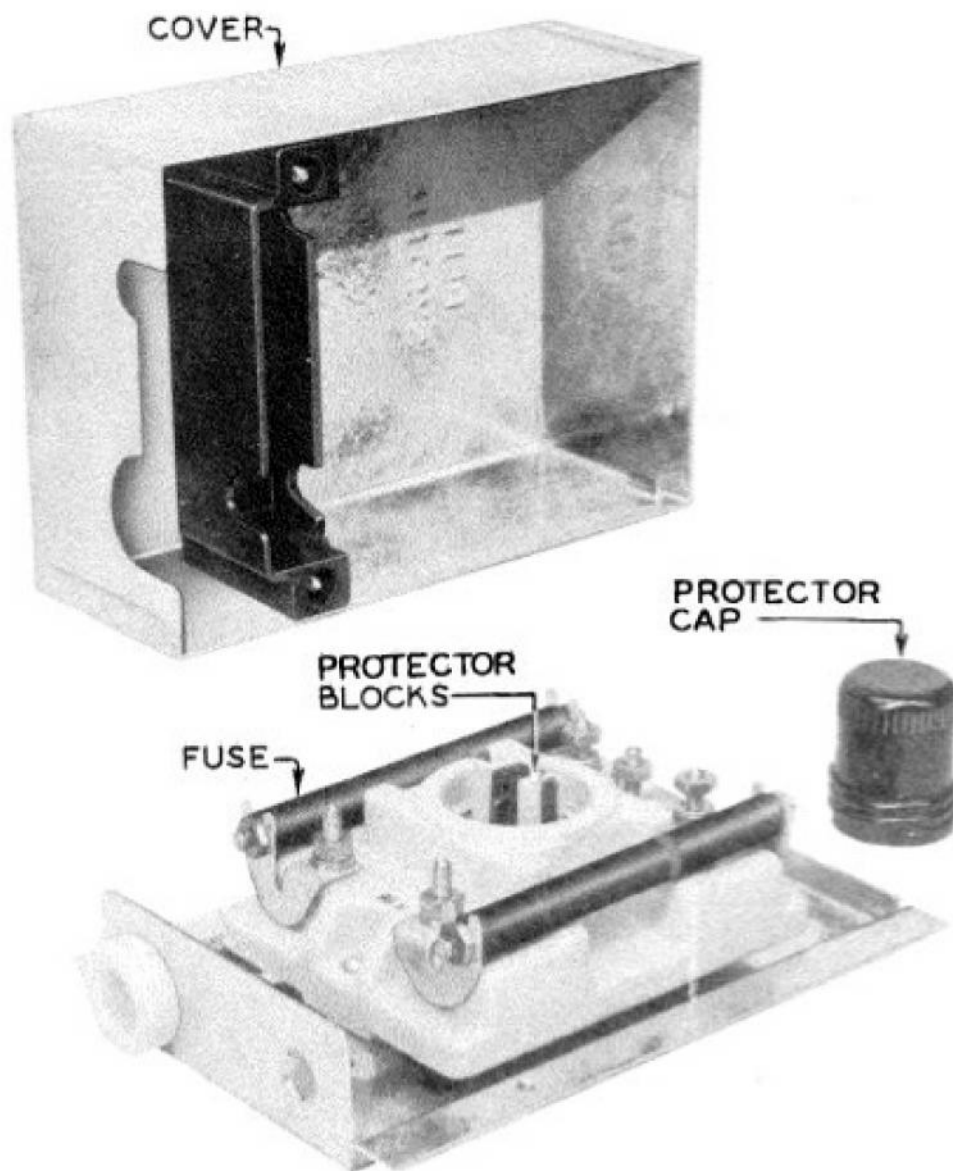

FIGURE 814. Telephone Protector (Western Electric Co. 1093A)

806. TERMINALS FOR PROTECTING SMALL SWITCHBOARDS AND TELEPHONES SERVED BY LEAD-COVERED CABLES - DESCRIPTION

Manufacturer and Mfr.'s Code No.	Shown in Figure No.	Size - Inches			Remarks ^a
		H	W	D	
Western Electric Co. LC-11	815	19	14-3/8	8-9/16	Provides means for applying protection and cross connecting inside cable and wire to outside cable. 11 pairs. Not equipped with fuses or protector blocks.
Western Electric Co. LC-16	815	22	14-3/8	8-9/16	Same as LC-11 except 16 pairs.
Western Electric Co. LC-26 ^b	815	29-1/2	14-3/8	8-9/16	Same as LC-11 except 26 pairs.
Western Electric Co. LC-26 ^b	815	29-1/2	14-3/8	8-9/16	Same as LC-11 except 26 pairs and equipped with fuses and protector blocks.
Western Electric Co. LC-51	815	49-1/8	14-3/8	8-9/16	Same as LC-11 except 51 pairs and equipped with fuses and protector blocks.
Western Electric Co. LA-26 ^b	816	29-1/2	29-1/2	8-9/16	Provides means for applying protection at junction of inside cable or wire and outside cable. Not arranged for cross connections. 26 pairs. Not equipped with fuses and protector blocks.
Western Electric Co. LA-51 ^b	816	49-1/8	29-1/2	8-9/16	Same as LA-26 except 51 pairs.
Western Electric Co. LA-16	816	22	26-1/2	8-9/16	Same as LA-26 except 16 pairs and equipped with fuses and protector blocks.
Western Electric Co. LA-26 ^b	816	29-1/2	29-1/2	8-9/16	Same as LA-26 except equipped with fuses and protector blocks.
Western Electric Co. LA-51 ^b	816	49-1/8	29-1/2	8-9/16	Same as LA-26 except 51 pairs and equipped with fuses and protector blocks.

^a Terminals listed are for wall-mounting indoors and use W. E. Co. 26 and 27 protector blocks in combination and W. E. Co. 7A fuses. If sneak current protection is required on pairs not used as battery feeders, use W. E. Co. 60D sneak current fuses in addition to the W. E. Co. 7A fuses. If battery feeders are used, W. E. Co. 60E fuses are required for such pairs, in addition to the W. E. Co. 7A fuses.

^b Terminals with the same number of pairs, which are equipped with fuses and protector blocks have same manufacturers code as those not equipped. Stock numbers are different, see paragraph 807.

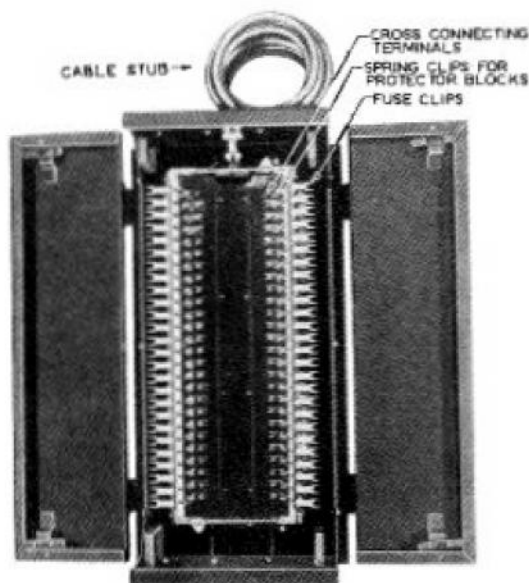

FIGURE 815. Terminals For Protecting Small Switchboards (Western Electric Co. LC-26)

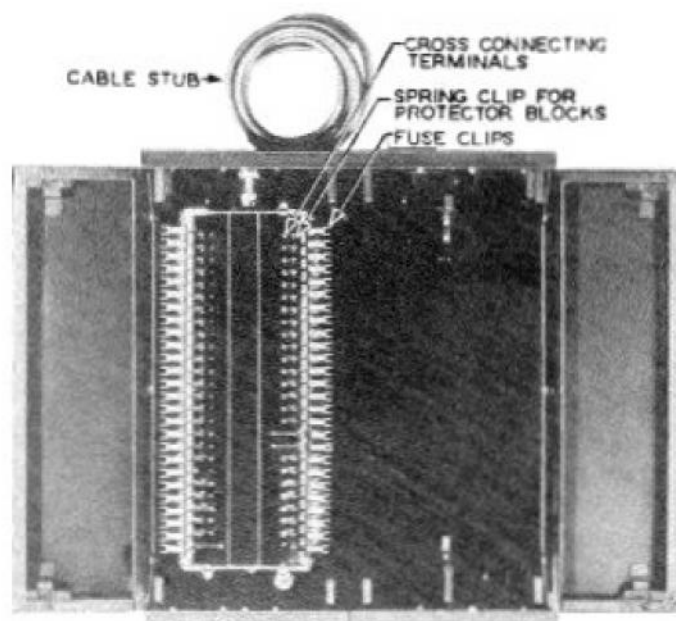

FIGURE 816. Terminals For Protecting Small Switchboards (Western Electric Co. LA-26)

807. TERMINALS FOR PROTECTING SMALL SWITCHBOARDS AND TELEPHONES SERVED BY LEAD-COVERED CABLES - STOCK NUMBERS AND LOGISTICAL DATA.

Manufacturer and Mfr.'s Code No.	Stock No.	Weight (Lbs.)		Cubic Feet	
		Packed for Export	Net	Packed for Export	Net
Western Electric Co. LC-11	4E7911	56	45	2.7	2
Western Electric Co. LC-16	4E7816	75	63	3	2.4
Western Electric Co. LC-26	4E7826	85	71	3.7	2.9
Western Electric Co. LC-26 ^a	5C2426	85	71	3.7	2.9
Western Electric Co. LC-51 ^a	4E7851	130	112	5.7	4.5
Western Electric Co. LA-26	4E7926	118	94	7.4	6
Western Electric Co. LA-51	4E7951	188	160	11.1	9.3
Western Electric Co. LA-16 ^a	4E7916	90	68	5.2	4.3
Western Electric Co. LA-26 ^a	4E7926.1	118	94	7.4	6
Western Electric Co. LA-51 ^a	4E7951.2	188	160	11.1	9.3

^a Equipped with fuses and protector blocks, others are not so equipped.

808. CABLE PROTECTORS - DESCRIPTION AND STOCK NUMBERS.

<u>Manufacturer and Mfr.'s Code No.</u>	<u>Shown in Figure No.</u>	<u>Stock No.</u>	<u>Type of Protector Block Used</u>	<u>Remarks</u>
Cook 7	817	5C2200	41-190 & 41-3001	For mounting on pole. Provides protection for five pairs at junction of cable and open wire.
Reliable 222	818	5C2200	P-495 & P-663	
Western Electric Co. 83A	819	5C2200	26 & 30 Prot. Blocks	



FIGURE 817. Cable Protector (Cook 7)

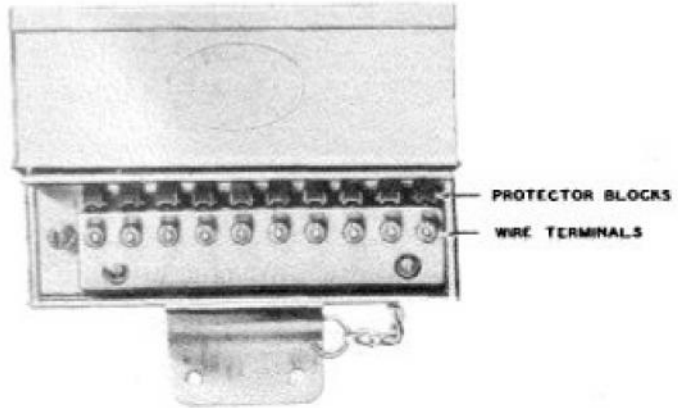

FIGURE 818. Cable Protector (Reliable 222)

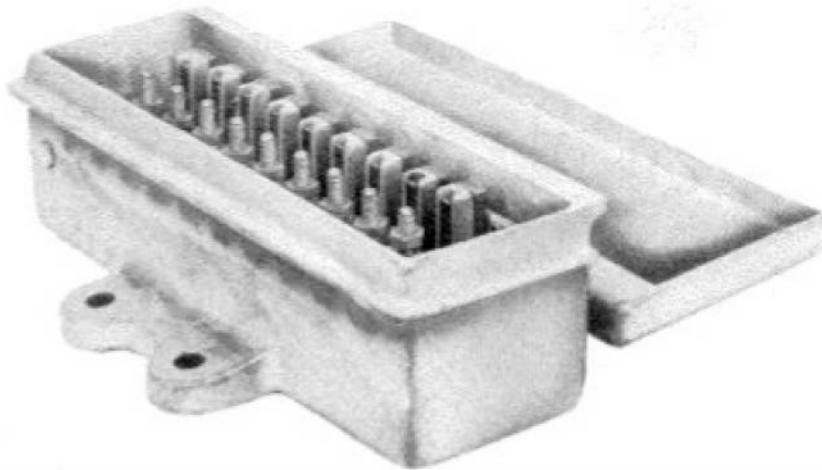

FIGURE 819. Cable Protector (Western Electric Co. 83A)

809. CABLE TERMINALS WITH PROTECTION - POLE MOUNTED - DESCRIPTION.

Manufacturer and Mfr.'s Code No.	Shown in Figure No.	Size - Inches			Type of Prot. Block or Fuse Used	Remarks
		H	W	D		
Western Elec- tric Co. EA26	820	50-1/2	20-1/2	17-1/16	W.E. Co. 26-30 Protector Blocks	Provides protec- tion for 26 pairs at junc- tion of cable and open wire.
Western Elec- tric Co. EA51		55-5/32	36-3/4	15-5/16	W.E. Co. 26-30 Protector Blocks	Same as EA26 except 51 pairs.
Western Elec- tric Co. B51	821	36-31/32	22-3/4	15-5/16	W.E. Co. 7T Fuses	Provides fuse protection for 51 pairs at junction of aerial and underground cable. (See TM 11-486 for use of 24 ga. cable in place of fused terminal.)
Western Elec- tric Co. B101	821	54-15/32	22-3/4	15-5/16	W.E. Co. 7T Fuses	Same as B51 except 101 pairs.

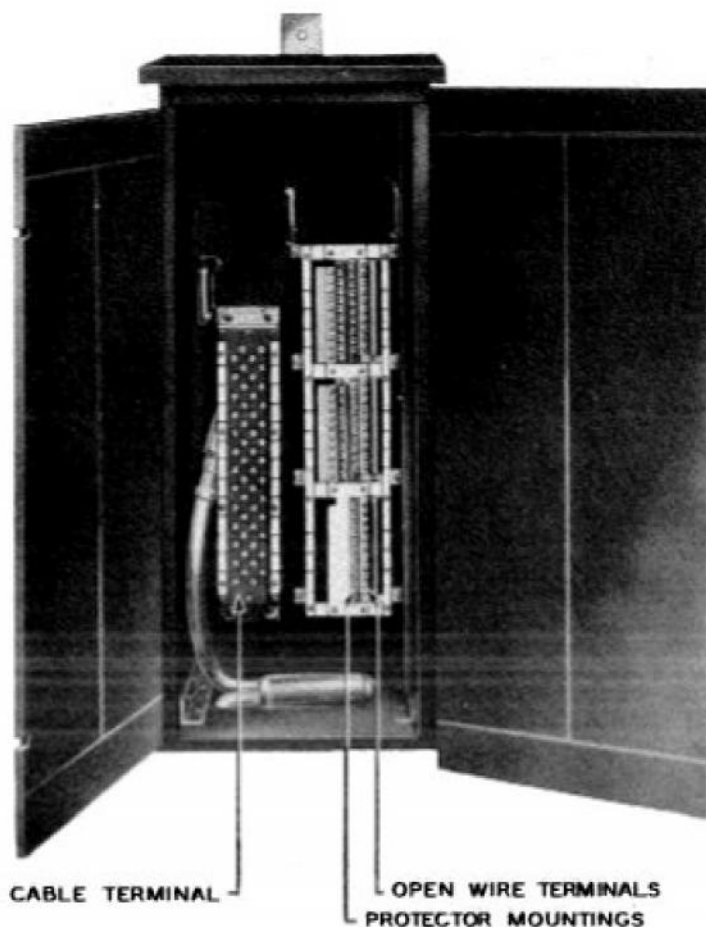

FIGURE 820. Cable Terminals With Protection (Western Electric Co. EA26)

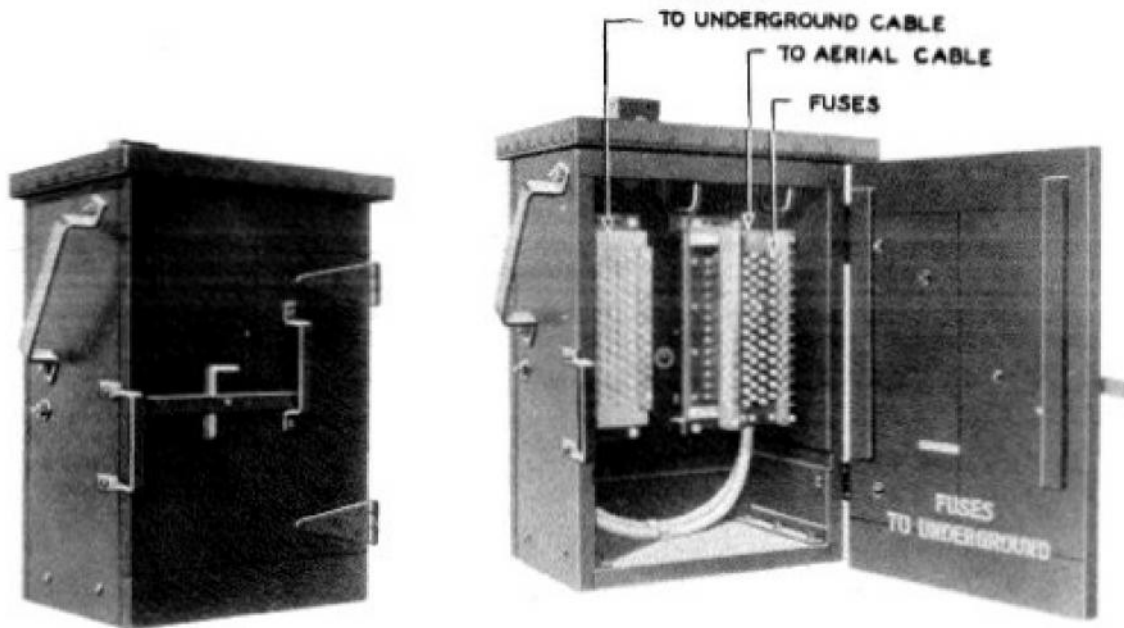

FIGURE 821. Cable Terminal With Protection (Western Electric Co. B Type)

810. CABLE TERMINALS WITH PROTECTION - POLE MOUNTED - STOCK NUMBERS AND LOGISTICAL DATA.

<u>Manufacturer and Mfr.'s Code No.</u>	<u>Stock No.</u>	<u>Weight (Lbs.)</u>		<u>Cubic Feet</u>	
		<u>Packed for Export</u>	<u>Net</u>	<u>Packed for Export</u>	<u>Net</u>
Western Electric Co. KA26	None	170	140	11.9	10.1
Western Electric Co. EA51	5C3051-1	265	225	18.3	15.9
Western Electric Co. B51	4K7951.2 or FTN-10961	144	119	7.9	6.5
Western Electric Co. B101	5C2501.2	210	180	11.5	9.9

811. MAIN FRAME PROTECTION FOR LARGER SWITCHBOARDS - DESCRIPTION.

Manufacturer	Stock No.	Shown in Figure No.	Size			Type of Prot. Blocks Fuses and Heat Coils	Frame Consists of	Remarks
			H	W	D			
Western Electric Co.	4E2520B	822	6'-9-5/8"	1'-5-13/16"	1'-2-1/4"	W.E.Co. 26-27 Prot. Block W.E.Co. 76A Heat Coils	W.E. Co. 1420B wall frame - "A" type; 5 - W.E. Co. 1432R Prot. Groups (25 pr. terminal strips mtd. on a fanning strip); 5 - W.E. Co. 1435W Prot. Groups (20 1269A Protectors mounted on a fanning strip)	Wall-mounted main frame protection for 100 prs.
Western Electric Co.	4E2525C	823	8'-4-3/4"	a	2'-6"	W.E.Co. 26-27 Prot. Block W.E.Co. 76A Heat Coils	W.E. Co. 1425C Main Frame - "B" type equipped with 103X fanning strips. Each vertical will accommodate 4 - W.E. Co. 1268A Protectors, 20 prs. each and 1 - W.E. Co. 1268B Protector, 23 prs. Each vertical will also accommodate 8 horizontal rows of W.E. Co. 65 - (20 prs. each) terminal strips.	Floor-mounted main frame protection - 100 prs. per vertical. Protector groups and terminal strips should be ordered separately. Two verticals of frame required for initial installation.
Reliable and General Electric	4E2401					Reliable P-663 and P-495 Protector Blocks and Reliable 106 Fuses	12 Reliable 303F Protectors 1 - G. E. copper oxide rectifier	Combination main frame and power panel Provides protection for 220 prs.

^a Spacing between verticals is 8".

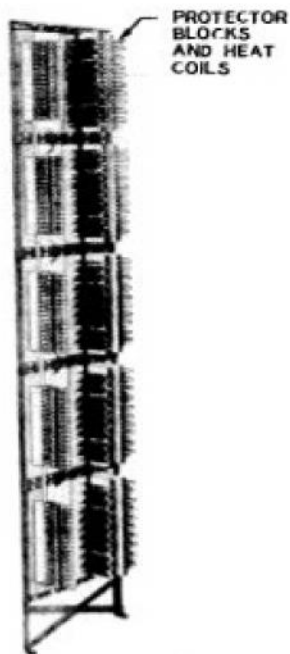

FIGURE 822. Protected Main Distributing Frame (Wall Mounted) (Western Electric Co.)

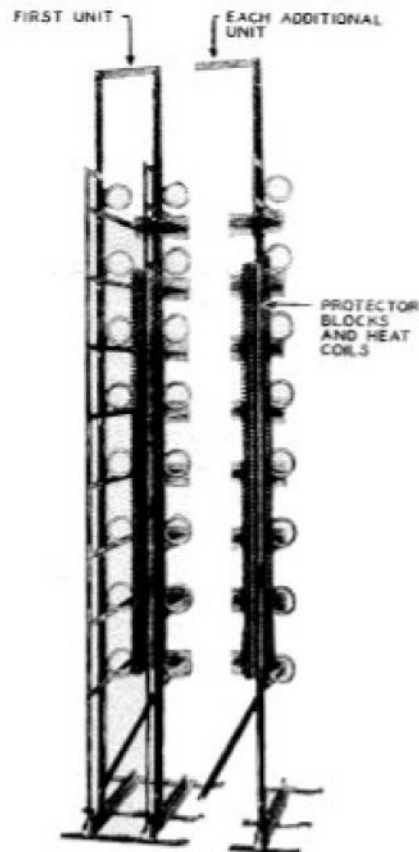

FIGURE 823. Protected Main Distributing Frame (Floor Mounted) (Western Electric Co.)

812. MAIN FRAME PROTECTION FOR LARGER SWITCHBOARDS - STOCK NUMBERS AND LOGISTICAL DATA.

<u>Manufacturer</u>	<u>Stock No.</u>	<u>Weight (Lbs.)</u>		<u>Cubic Feet</u>	
		<u>Packed for Export</u>	<u>Net</u>	<u>Packed for Export</u>	<u>Net</u>
Western Electric Co.	4E2520B				
Western Electric Co.	4E2525C				
Reliable and General Electric	4E2401				

CHAPTER 9
TELEPHONE LINE TRANSMISSION EQUIPMENT

Section I
General

901. SCOPE AND USE.

a. This chapter gives information on telephone line transmission equipment, required to establish telephone circuits by voice frequency or carrier means. It does not include the switchboard equipment or telephones at the ends of the circuits and it does not include power plant or telegraph equipment. Reference should be made to other chapters in this manual for these items.

b. Composite sets and simplex coils for deriving telegraph legs for d-c telegraph circuits are considered part of the telephone line transmission equipment. The remainder of the telegraph equipment, including voice-frequency carrier telegraph terminals is treated in chapter 10.

c. The information is divided into two parts for convenience in use. Section II applies to the equipment normally in tactical communications systems. Section III applies to "packaged" equipment designed primarily for fixed plant service. This division of the information is not intended to limit the field of use of either type of equipment. The tactical plant equipment may be used in fixed plant communication systems, or vice versa, when it will give the service desired.

Section II
Tactical Equipment

902. GENERAL. Tactical telephone line transmission equipment is intended for use with rubber-covered wires and cables, and open wire lines. Radio links may also form a part of the system. In general, the equipment includes built-in testing means and has controls and adjustments which are simple and easy to operate.

903. DESCRIPTIVE INFORMATION.

a. The principal items of tactical telephone equipment include voice frequency repeaters, voice frequency ringers, and carrier equipment. The voice frequency repeaters include two-wire (21-type) and four-wire repeaters and are mainly for use with field wire. The ringing equipment consists of voice frequency ringers for

use when 20-cycle signaling cannot be used over the line. The carrier equipment consists of carrier telephone terminals and repeaters which may be used to provide four telephone channels over a line composed of spiral-four cable or two-open wire pairs, or a multichannel radio link. Supplementary equipment is also available which will permit the same carrier terminals to be operated in conjunction with a single open wire pair either on an equivalent four-wire or balanced two-wire basis. Descriptions of these items are given in paragraph 906 to 908 inclusive. The various groupings of these items to provide telephone line transmission sets is given in paragraph 909.

904. STOCK NUMBERS AND LOGISTICAL DATA.

Paragraph 910 gives stock numbers and logistical data for the tactical telephone equipment listed in paragraphs 906 to 910 inclusive.

905. SUMMARY OF EQUIPMENT REQUIREMENTS.

a. Paragraphs 911, 912 and 913 summarize the equipment required for three tactical carrier telephone transmission systems. Information regarding outside plant and any associated telegraph equipment which are not included are given in Chapter 6 and 10, respectively. Paragraph 911 is for the four-wire spiral-four or open wire system. The transmission frequency band is 0 to 12 kc over each pair of wires. Paragraph 912 is for an equivalent four wire system, sometimes referred to as the "open wire converter system," operated over a single open wire pair. The transmission frequency band in one direction of transmission is 0 to 12 kc and in the other direction 20 to 32 kc. Paragraph 913 is for a balanced two-wire carrier hybrid system. The transmission frequency band is 0 to 12 kc in both directions of transmission. For each type of system given the equipment required at each terminal and repeater point is listed.

b. A list of spare equipment is included in paragraphs 911, 912 and 913. The amount of spare equipment to be provided will vary widely depending upon conditions and must be determined for each specific application. The number of spare units indicated is suggested as applying in a typical case.

c. Reference should be made to chapter 13 for information on test sets required in maintenance of this equipment.

906. VOICE FREQUENCY REPEATERS AND MISC. EQUIPMENT - TACTICAL - DESCRIPTION.

Nomenclature		Shown in Fig. No.	Weight in Pounds ^a	Dimensions in Operation Inches ^b	12 Volt Storage Battery Operation ^c	Dry Battery Operation Life ^d	TM	Remarks
Name	Type No.							
Telephone Repeater	XE-89-A	901	14 with Battery	7x8-1/2x9	-	2 weeks	TM 11-2006	Two-wire (21 type) voice-frequency intermediate repeater for use on lines with 20 or 1000-cycle signaling. Provides thru simplex telegraph operation. Includes one spare tube. Uses one Battery BA-40.
Telephone Repeater Part of TC-29-A	XE-99-A	902	40	12x8x14	0.5 amp. 12 days	7 Days Continuous Use	TM 11-549	Four-wire voice-frequency telephone repeater for use on wire and cable facilities with 20- or 1000-cycle signaling. Contains hybrid coil equipment for providing a two-wire termination on one side of repeater when used at a terminal or at a junction with a two-wire line. With simplex telegraph operation 1000-cycle signaling required. Uses vibrator type Power Unit PE-204 or three Batteries BA-23 and four BA-36.
Telephone	TP-9	903	24 with Batteries	9-1/4x8x12	-	2 to 4 Weeks	TM 11-2059	Portable telephone equipped with transmitting and receiving amplifier for increasing operating range. Transmission is in one direction at a time controlled by a push to talk switch in handset handle. Uses following Batteries one BA-27, one BA-65, three BA-2.
Repeating Coil	C-161	904	3	5x5 1/4x 2-1/2	-	-	-	1:1 ratio ring-thru coil for use between line and switchboard. Simplex tap provided on line winding.
Telegraph Terminal	TH-1/T00-1	-	-	-	-	-	-	Known as S + DX. See chapter 10.

^aRepeaters in wooden carrying case.
^bFirst two dimensions indicate floor space required.
^cAssumes use of two Batteries BB-55, 150 ampere-hours fully charged condition and under normal weather conditions. Batteries normally used for standby power and not furnished with equipment.
^dAssumes batteries in good condition under normal weather conditions. Batteries not furnished with equipment.

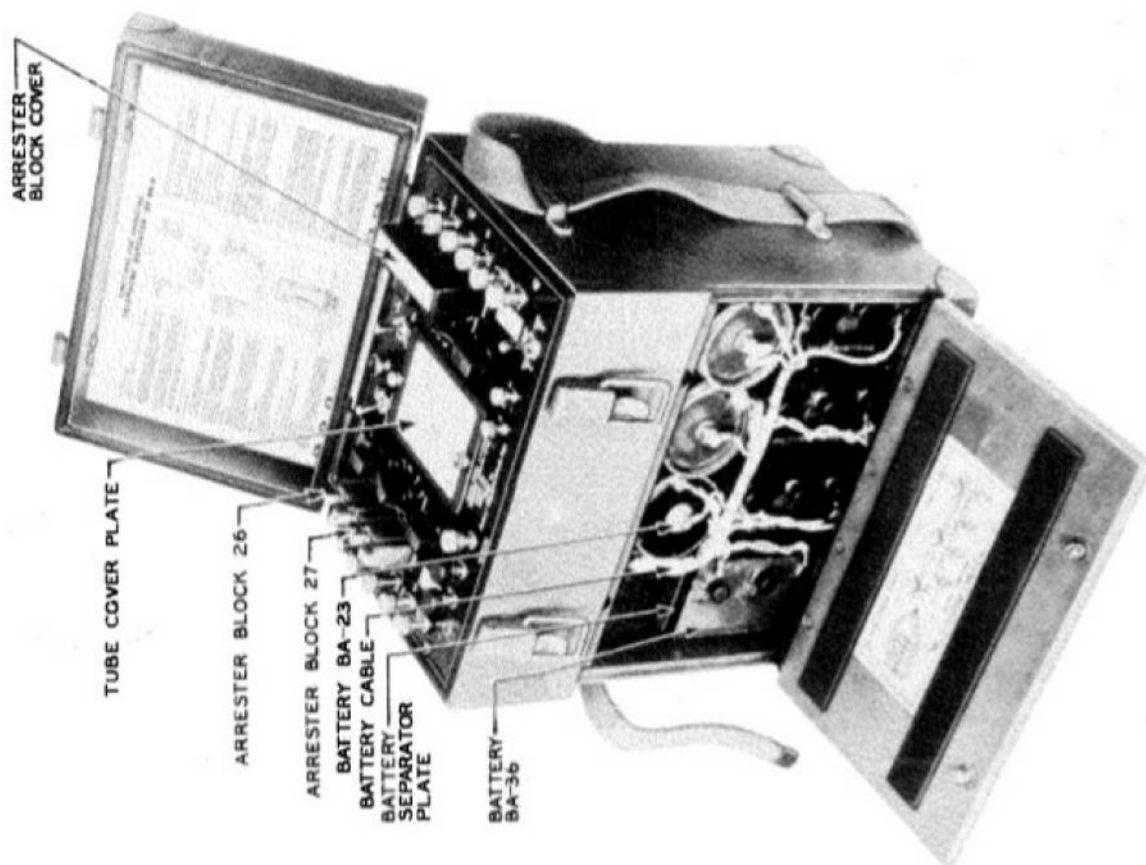

FIGURE 902. Telephone Repeater EE-99-A

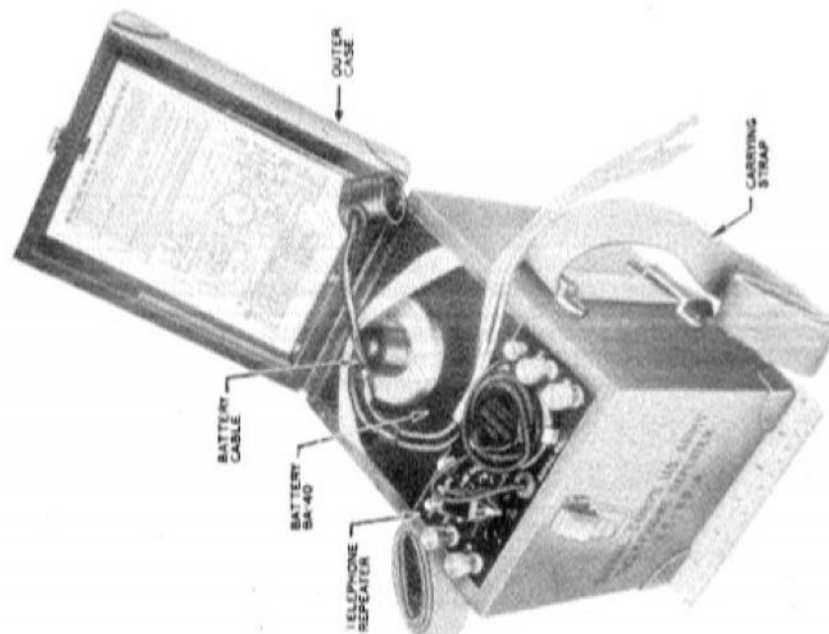

FIGURE 901. Telephone Repeater EE-89-A

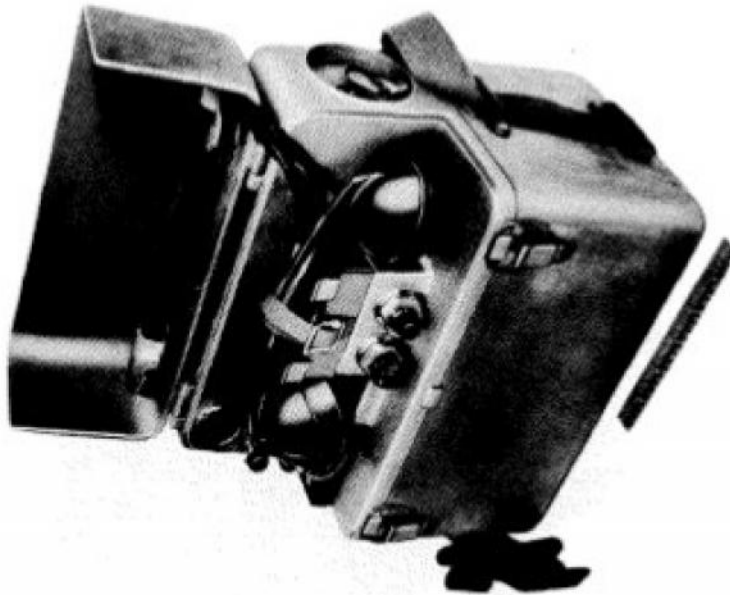

FIGURE 903. Telephone TP-9



FIGURE 904. Repeating
Coil C-161

907. VOICE FREQUENCY RINGING EQUIPMENT - TACTICAL - DESCRIPTION.

Name	Type No.	Shown in Fig. No.	Weight in Pounds ^a	Dimensions in Operation Inches ^b	110V AC Operation VAC	12 Volt Storage Battery Operation	Remarks
Ringling Equipment	KE-100-()	905	110	21-1/4 x 16-1/4 x 11-5/8	36	2.5 amps 60 hours	Same as KE-101() except only one 1000-20 cycle ringer. Replaced by KE-101-() .
Ringling Equipment Part of TC-24-()	KE-101-()	906	95	21-1/4 x 14-3/4 x 11-5/8	36	3.2 amps 45 hours	Two 1000-20 cycle ringers for use where 20 cycle signaling cannot be used over line. Operates normally from 110V a-c supply. Has automatic transfer from a-c supply to storage batteries. One KE-101-() required at each end of two circuits. Includes 100% spare tubes, fuses and vibrator.

^a Ringling equipment in wooden carrying case.

^b First two dimensions indicate floor space required.

^c May also be operated from 220 volt, 50-60 cycle source. To obtain power in watts multiply VA by 0.85.

^d Assumes use of two Batteries EB-55, 150 ampere-hours fully charged condition and under normal weather conditions.

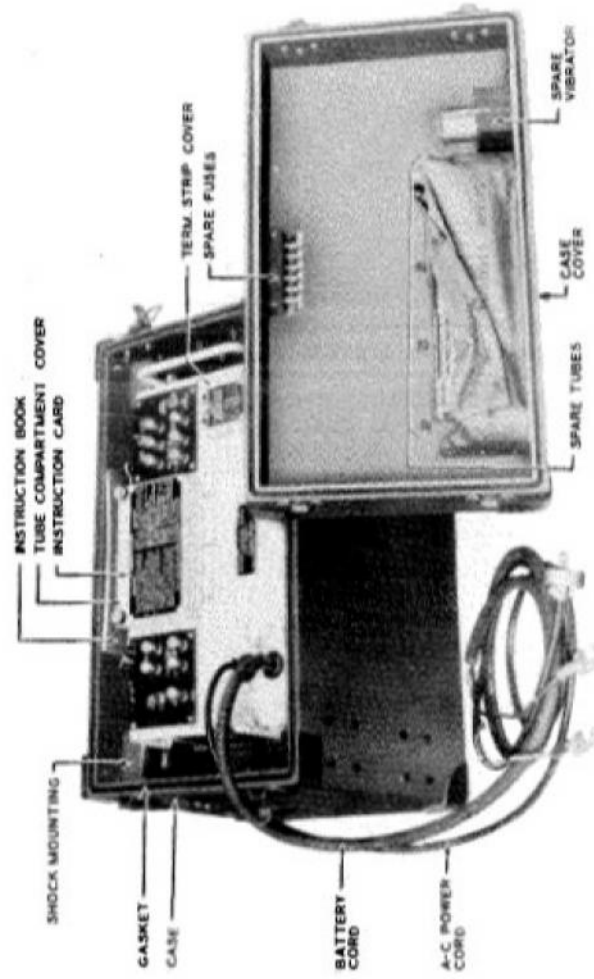

FIGURE 906. Ringing Equipment EE-101- ()

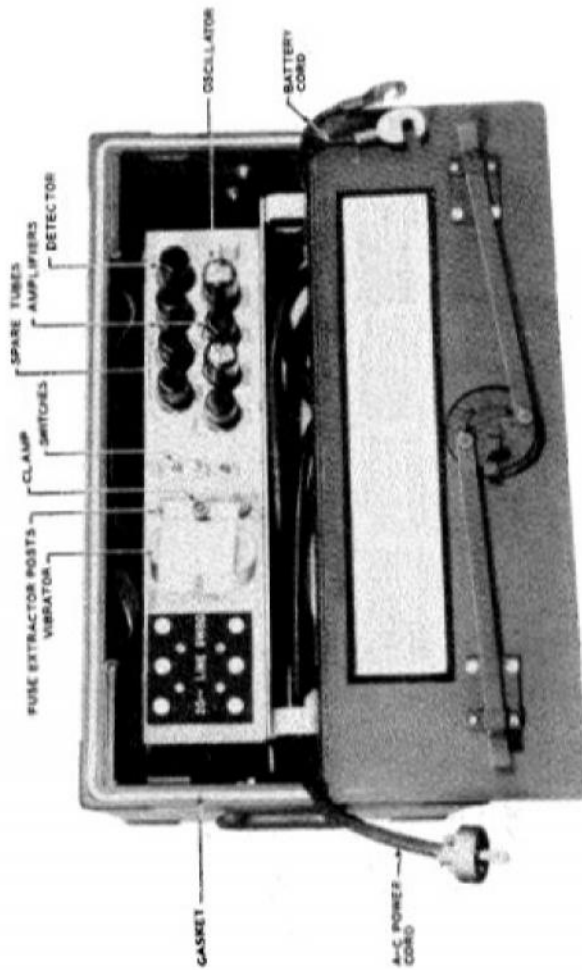

FIGURE 905. Ringing Equipment EE-100- ()

908. CARRIER TELEPHONE EQUIPMENT - TACTICAL - DESCRIPTION.

Nomenclature		Shown in Fig. No.	Weight in Pounds ^a	Dimensions in Operation Inches ^b	110V AC Operation VAC	12 Volt Storage Battery Operational ^c	TM or Instruction Book	Remarks
Name	Type No.							
Telephone Terminal Part of TC-21-()	CF-1-A	907	475	28x19x66	72	7.5 amps 20 hours	TM 11-341	Four-channel carrier telephone terminal. Part of spiral-four carrier system using Cable Assemblies CC-398. Provides one voice and three carrier channels using frequencies up to 12 kc. Provides one d-c signaling circuit and one d-c telegraph circuit on the two simplexers. Signaling circuit used in system maintenance. One or more telephone channels may be used for voice-frequency telegraph CF-2-(); channel 3 is first choice. Each telephone channel requires 1000-20 cycle signaling. Has built in transmission testing equipment and automatic transfer from a-c power source to storage battery. Includes 100% spare tubes, protectors, fuses, and vibrator.
Repeater Part of TC-23-()	CF-3-A	908	225	28x14x34	36	3.75 amps 40 hours	TM 11-341	Four-channel carrier intermediate repeater used in spiral-four carrier system. Arranged for d-c signaling and d-c telegraph operation over the two simplexers. Has built in transmission testing equipment, talking and monitoring arrangement for the voice channel, and automatic transfer from the a-c supply to storage batteries. Includes 100% spare tubes, protectors, fuses, and vibrator.
Converter Part of TC-33-()	CF-4-()	909	280	24x17x49	36	3.5 amps 45 hours	TM 11-2008	Carrier converter for use with Telephone Terminal CF-1-A or Repeater CF-3-A to provide 4 circuits over a single open wire pair. Operation is on an equivalent four-wire basis, one direction of transmission being 0-12 kc and the other direction 20.8 to 32.2 kc. Provides two composited d-c telegraph paths. Includes amplifying, modulating, and demodulating equipment, composite set, built-in testing equipment, and automatic transfer from a-c supply to storage battery. Includes 100% spare tubes, fuses, protectors, and vibrator.

^aIn wooden case except Telephone Unit KB-105 which is in canvas case.
^bFirst two dimensions indicate floor space required.
^cMay also be operated from 220-volt, 50-60 cycle source. To obtain power in watts multiply VA by 0.85.
^dAssumes use of two Batteries BB-55, 150 ampere hour, fully charged and under normal weather conditions.
 Batteries used for standby power.

Table continued on next page

CARRIER TELEPHONE EQUIPMENT - TACTICAL - DESCRIPTION (Continued)

Nomenclature		Shown in Fig. No.	Weight in Pounds ^a	Dimensions in Inches ^b	110V AC Opera- tion	12 Volt Storage Battery Operation ^d	TM or Instruction Book	Remarks
Name	Type No.							
Repeater Part of TC-37-()	CF-5-()	910	380	24x19x65	54	4.5 amps 35 hours	TM 11-2008	Carrier repeater for use at intermediate offices on equivalent four-wire systems using Converter CF-4-(). Arranged for compositing telegraph. Has built-in transmission testing equipment, talking and monitoring arrangements on Channel 1, and automatic transfer from the a-c supply to storage batteries. Includes 100% spare tubes, protectors, fuses and vibrator.
Carrier Hybrid	CF-7	911	54	19x10x6	-	-	TM 11-2003	Four wire-2 wire equipment used with Telephone Terminal CF-1-A and Repeater CF-3-A to provide 1 voice and three carrier circuits over a single pair. Operation is on a balanced two-wire basis using frequencies up to 12 kc in each direction of transmission. Used principally on open wire pairs. Provides two compositing d-c telegraph paths. Includes a repeating coil hybrid, adjustable balancing network, and a composite set. Requires no power. Includes 100% spare protectors.
Telephone Unit	EX-105	912	16	7-3/4 x 5 x 9-7/8	-	-	TM 11-2014	Telephone for use primarily by lineman to connect to voice frequency channel on lines used for carrier operation. Contains EX-8-B telephone unit, also filter to prevent mutual interference between voice and carrier channels. May be used to provide an intermediate bridged station on voice or carrier lines. Requires two Batteries BA-30, suitable for 48 hrs continuous use.

^aIn wooden case except Telephone Unit EX-105, which is in canvas case.

^bFirst two dimensions indicate floor space required.

^cMay also be operated from 220-volt, 50-60 cycle source. To obtain power in watts multiply VA by 0.85.

^dAssumes use of two Batteries BB-55, 150 ampere hour, fully charged and under normal weather conditions. Batteries used for standby power.

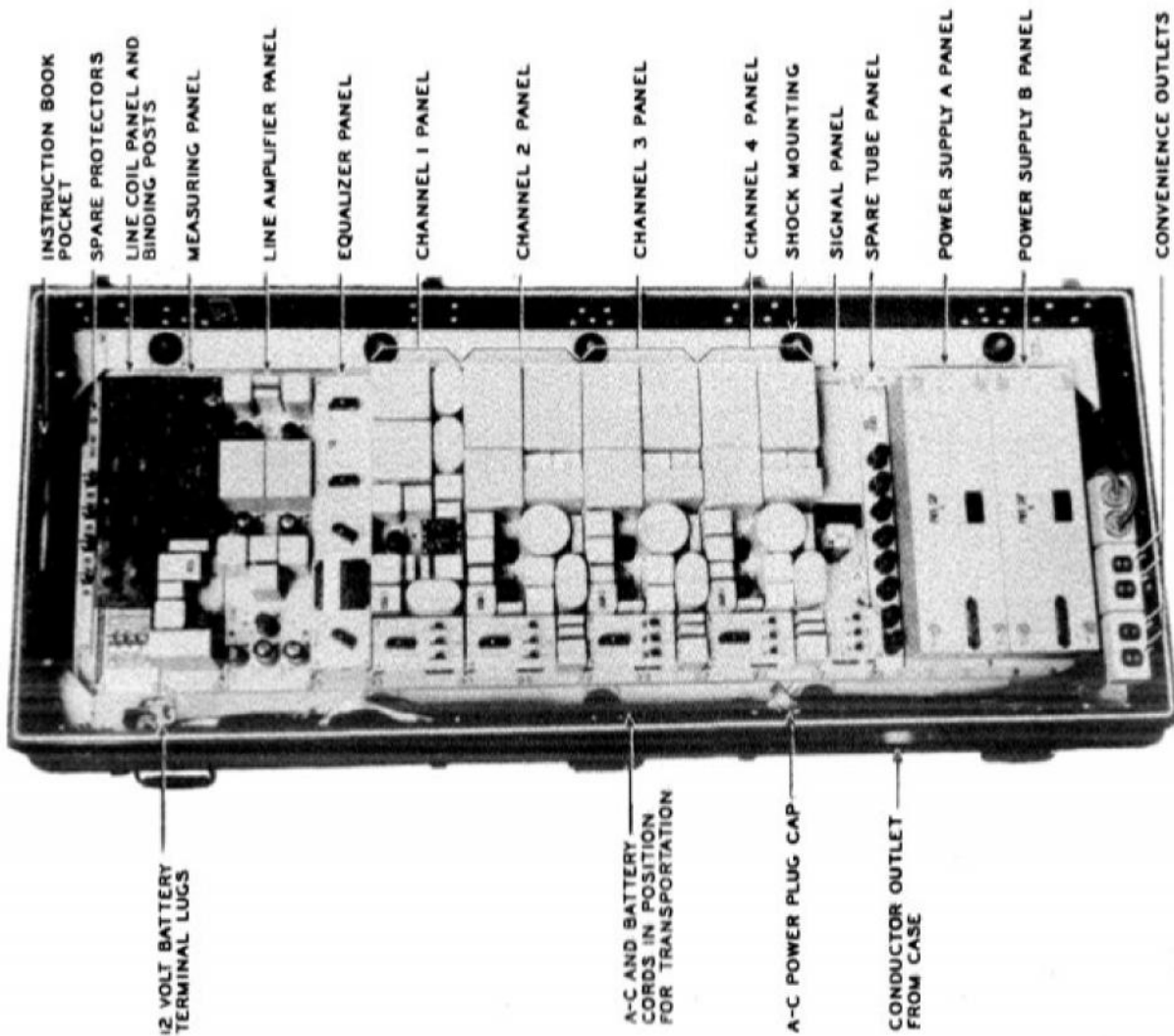

FIGURE 907. Telephone Terminal CF-1-A

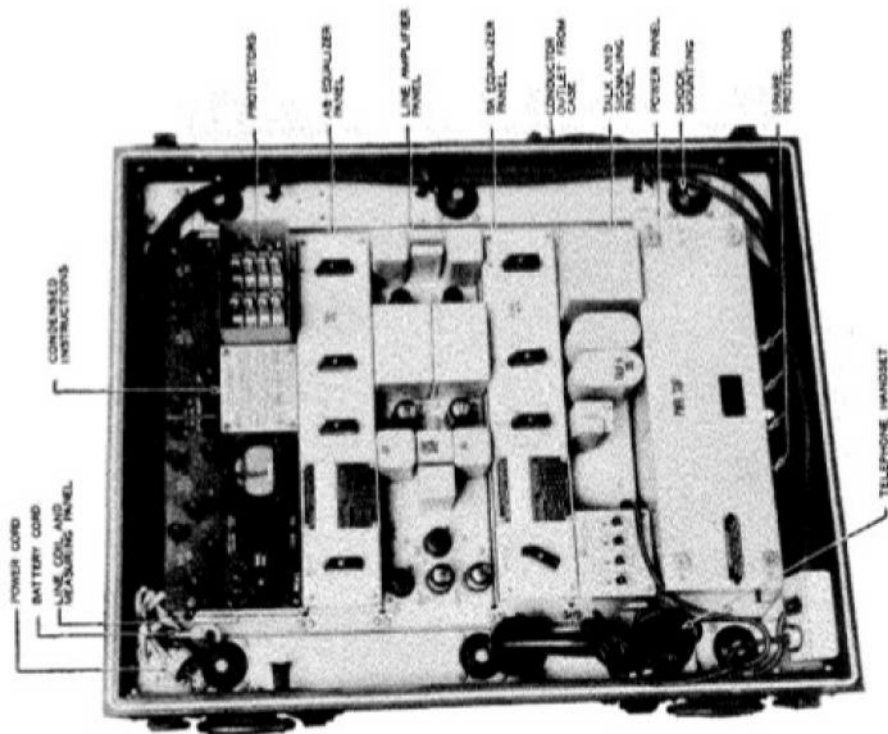

FIGURE 908. Repeater CF-3-A

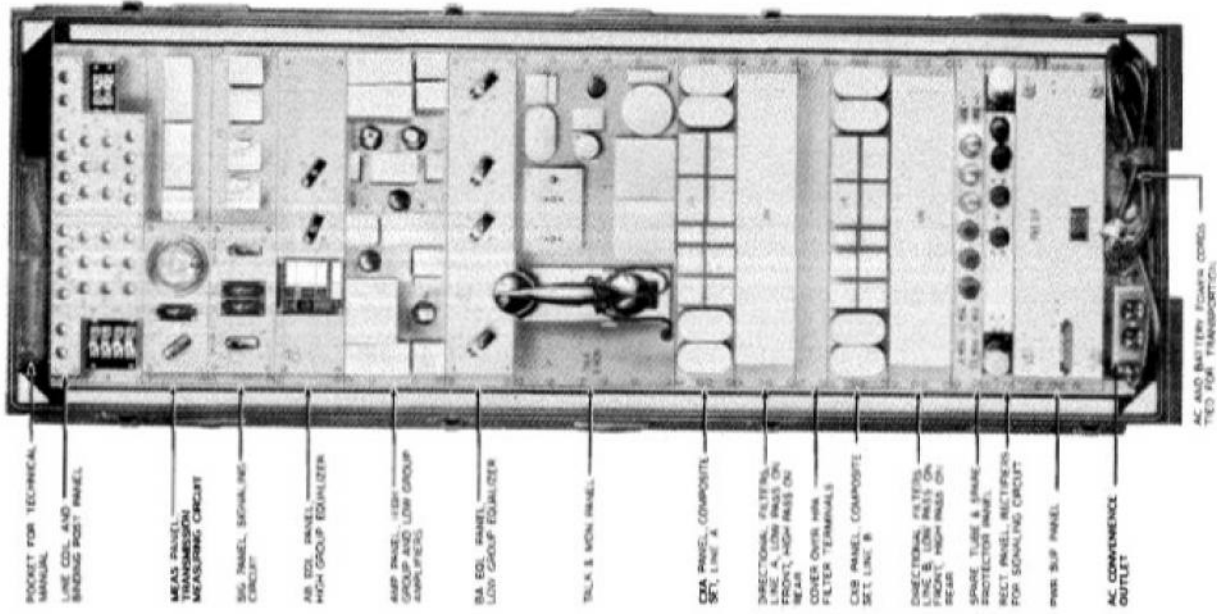

FIGURE 910. Repeater CF-5-()

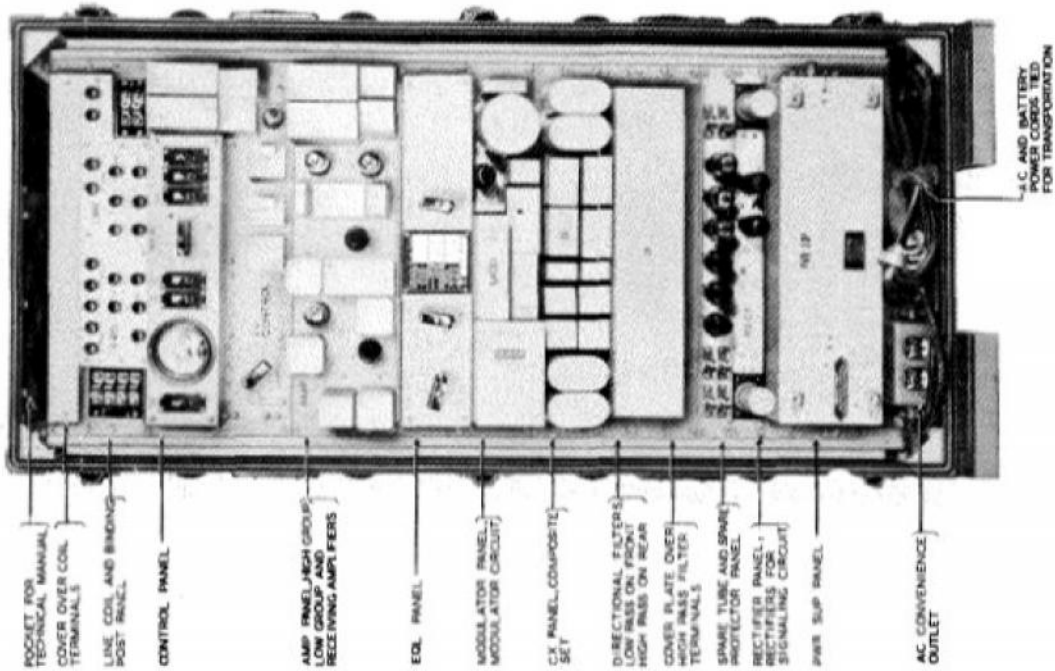

FIGURE 909. Converter CF-4-()

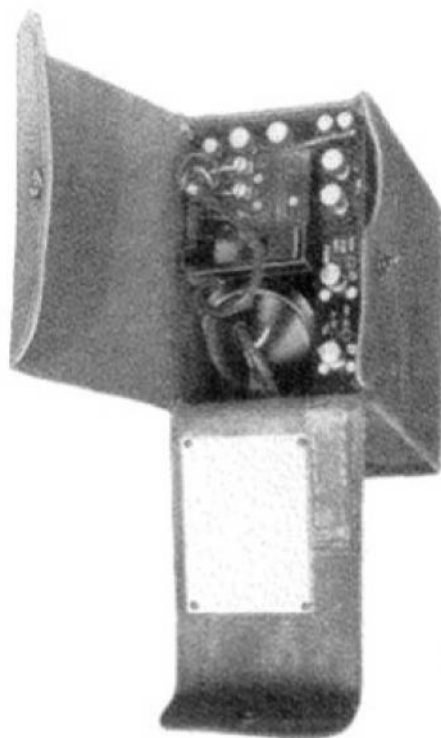

FIGURE 912. Telephone Unit EE-105

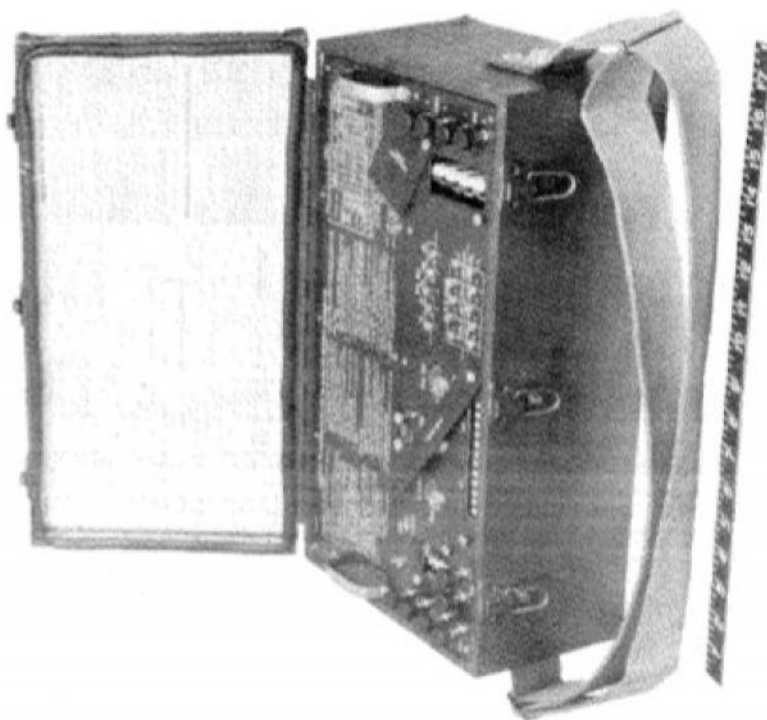

FIGURE 911. Carrier Hybrid CF-7

909. TELEPHONE LINE TRANSMISSION SETS - TACTICAL - COMPONENT PARTS.

Nomenclature Name	Type No.	Quan.	Principal Component Parts	Dimensions ^a		Weight in Operation lbs.
				Inches	Inches	
Telephone Terminal Set	TC-21-()	1	Telephone Terminal CF-1-A	28 x 19 x 66	475	
		1	Power Unit PE-75-()	36 x 19-1/2 x 26-1/2	330	
		2	Batteries BB-55	26 x 14 x 19	110	
		1	Rectifier RA-83-()	14 x 10 x 16	50	
		1	Test Equipment IE-53-()	7 x 6 x 5-1/2	8	
		1	Tool Equipment TE-123-()	7 x 16 x 7	20	
		1	Telephone EE-8-()	4 x 8 x 10	10	
			Accessory Equipment and Spare Parts		187	
			Total		1190	
Repeater Set	TC-23-()	1	Repeater CF-3-A	28 x 14 x 34	225	
		1	Power Unit PE-214-()	14 x 18-1/2 x 10	40	
		2	Batteries BB-55	26 x 14 x 19	110	
		1	Rectifier RA-83-()	14 x 10 x 6	50	
		1	Test Equipment IE-53-()	7 x 6 x 5-1/2	8	
		1	Tool Equipment TE-123-()	7 x 16 x 7	20	
			Accessory Equipment and Spare Parts		132	
			Total		685	
Ringer Set ^b	TC-24-()	1	Ringng Equipment EE-101-()	21 x 15 x 11-1/2	95	
		2	Batteries BB-55	26 x 14 x 19	110	
			Accessory Equipment and Spare Parts		135	
			Total		340	
Telephone Repeater Set ^c	TC-29-A	1	Telephone Repeater EE-99-A	12 x 8 x 14	40	
		1	Power Supply PG-204	5-3/4 x 6-3/4 x 5-1/2	10	
		1	Telephone EE-8-()	4 x 8 x 10	10	
			Accessory Equipment and Spare Parts		20	
			Total		80	
Converter Set	TC-33-()	1	Converter CF-4-()	24 x 17 x 49	280	
		2	Batteries BB-55	26 x 14 x 19	110	
			Accessory Equipment and Spare Parts		180	
			Total		570	
Repeater Set	TC-37-()	1	Repeater CF-5-()	24 x 19 x 65	380	
		1	Power Unit PE-214-()	14 x 18-1/2 x 10	40	
		2	Batteries BB-55	26 x 14 x 19	110	
		1	Rectifier RA-83-()	14 x 10 x 6	50	
		1	Test Equipment IE-53	7 x 6 x 5-1/2	8	
		1	Tool Equipment TE-123	7 x 16 x 7	20	
		1	Telephone EE-8-()	4 x 8 x 10	10	
			Accessory Equipment and Spare Parts		87	
			Total		860	

^aFirst two dimensions indicate floor space required. Three foot clearance front and rear is desirable for maintenance.
^bA source of a-c power is required if ringer is not associated with equipment having a source of a-c power.
^cTwo Batteries BA-30 and three Batteries BA-23 or four Batteries BA-36 or two Batteries BB-55 are required but not provided as part of the set.

910. TELEPHONE LINE TRANSMISSION EQUIPMENT - TACTICAL - STOCK NUMBERS AND LOGISTICAL DATA.

Nomenclature	Type No.	Stock No.	Weight - lbs.		Total		Volume - Cu.Ft.		Ship Tons ^a
			Packed For Export	In Carrying Case	Packed For Export	In Carrying Case	Packed For Export	In Carrying Case	
a VOICE FREQUENCY REPEATERS AND MISC. EQUIPMENT									
Telephone Repeater ^b	EE-89-A	4B3289A	20	14	20	14	.4	.3	-
Telephone Repeater ^c	EE-99-A	4B3299A	47	40	47	40	2.5	0.8	.1
Telephone Repeater Set ^c	TC-23-A	4B3229	47	40	277	80	10	1.5	.3
Telephone	TP-9	None Assigned	-	24	-	24	-	0.5	-
Repeating Coil	C-161	3C161	4.7	3	-	3	-	-	-
b VOICE FREQUENCY RINGING EQUIPMENT									
Ringling Equipment	EE-100-()	4F2100	150	110	150	100	3.9	2.3	.1
Ringling Equipment	EE-101-()	4F2101	140	95	140	95	3.6	2.1	.1
Ringling Set	TC-24-()	4F2124	140	95	440	340	14	10.1	.4
c CARRIER TELEPHONE EQUIPMENT									
Telephone Terminal	CF-1-A	4B3361	735	475	735	475	43.8	20.3	1.1
Repeater	CF-3-A	4B3303	540	225	340	225	17.9	7.7	.5
Converter	CF-4-()	4B4484	530	280	530	280	35.0	11.6	.9
Repeater	CF-5-()	4B3205	690	380	690	380	40.0	17.7	1.0
Carrier Hybrid	CF-7	4E1467	75	54	75	54	2.2	.8	.1
Telephone Terminal Set	TC-21-()	4B3360-21	735	475	1470	1190	62.0	40	1.5
Repeater Set	TC-23-()	4B3223	340	225	1150	685	42.0	28	1.1
Converter Set	TC-33-()	4B449-33	530	280	830	570	44	22	1.1
Repeater Set	TC-37-()	4B3237	690	380	1180	860	53	34	1.3
Telephone Unit	EE-105	4B3405	-	16	-	16	-	.4	-

^a40 cu. ft. assumed equal to 1 ship ton.

^bRequires in addition:
One Battery BA-40

^cRequires in addition:
For storage battery operation - two Batteries BB-55
For dry cell operation - three Batteries BA-23 or four Batteries BA-35 and two Batteries BA-30 for Telephone EE-8-().

911. SUMMARY OF EQUIPMENT REQUIRED FOR 4-WIRE CARRIER OPERATION OVER SPIRAL-FOUR CABLE OR OPEN WIRE.

Nomenclature			Number Required ^a
Name	Type No.		
a	PER TERMINAL		
	Telephone Terminal Set	TC-21-()	1
	Ringer Set	TC-24-()	2
b	PER REPEATER		
	Repeater Set	TC-23-()	1
c	SPARE EQUIPMENT^b		
	Telephone Terminal	CF-1-A	1 per system
	Repeater	CF-3-A	1 per 3 or less repeaters
	Ringling Equipment	EE-101-()	1 per system
	Power Unit	PE-75-()	2 per system
	Power Unit	PE-214-()	2 per repeater
	Rectifier	RA-83-()	1 per system

^aFor stock numbers, weights, and volumes see paragraphs 910, 1207 and 1217.

^bAmount of spare equipment will vary widely and must be estimated for each specific application. The number required is suggested as typical.

912. SUMMARY OF EQUIPMENT REQUIRED FOR 2-WIRE CARRIER OPERATION OVER OPEN WIRE USING CONVERTER CF-4-().

Nomenclature			Number Required ^a
Name	Type No.		
a	PER TERMINAL		
	Telephone Terminal Set	TC-21-()	1
	Converter Set	TC-33-()	1
	Ringer Set	TC-24-()	2
b	PER REPEATER		
	Repeater Set	TC-37-()	1
c	SPARE EQUIPMENT^b		
	Telephone Terminal	CF-1-A	1 per system
	Converter	CF-4-()	1 per system
	Repeater	CF-5-()	1 per 3 or less repeaters
	Ringling Equipment	EE-101-()	1 per system
	Power Unit	PE-75-()	2 per system
	Power Unit	PE-214-()	2 per repeater
	Rectifier	RA-83-()	1 per system

^aFor stock numbers, weights, and volumes see paragraphs 910, 1207 and 1217.

^bAmount of spare equipment will vary widely and must be estimated for each specific application. The number required is suggested as typical.

913. SUMMARY OF EQUIPMENT REQUIRED FOR 2-WIRE CARRIER OPERATION OVER OPEN WIRE USING CARRIER HYBRID CF-7.

Nomenclature			Number Required ^a
Name	Type No.		
a	PER TERMINAL		
	Telephone Terminal Set	TC-21-()	1
	Carrier Hybrid	CF-7	1
	Ringer Set	TC-24-()	2
b	PER REPEATER		
	Repeater Set	TC-23-()	1
	Carrier Hybrid	CF-7	2
c	SPARE EQUIPMENT^b		
	Telephone Terminal	CF-1-A	1 per system
	Repeater	CF-3-A	1 per 3 or less repeaters
	Carrier Hybrid	CF-7	1 per sys. + 1 per 3 or less rep.
	Ringling Equipment	EE-101-()	1 per system
	Power Unit	PE-75-()	2 per system
	Power Unit	PE-214-()	2 per repeater
	Rectifier	RA-83-()	1 per system

^aFor stock numbers, weights, and volumes see paragraphs 910, 1207 and 1217.

^bAmount of spare equipment will vary widely and must be estimated for each specific application. The number required is suggested as typical.

**Section III
Fixed Plant Equipment**

914. GENERAL.

a. Fixed plant telephone circuits will generally be set up by means of a group of equipment, known as "packaged" equipment, which has been designed especially for this purpose. Packaged equipment will furnish high grade telephone circuits comparable to that secured by use of conventional commercial equipment required for fixed plant service. It is so arranged that engineering, installation and maintenance is simplified. Some types of packaged equipment may be used in tactical telephone systems where conditions warrant.

b. Packaged equipment is not designed for outdoor use and should be located in a building where temperature variations over short periods of time may be held to a minimum. If the equipment is to be housed in a theatre type of building, it is recommended that the frigid (fully enclosed wooden) type of building be used.

c. In addition to the instruction books on the individual packages, TM 11-2022

"Application of Fixed Plant Telephone and Telegraph Packaged Equipment to Open Wire Lines" may be referred to when detailed information on engineering of packaged equipment is required.

915. DESCRIPTIVE INFORMATION. Packaged telephone equipment is available for establishing nonrepeated voice circuits, repeated voice circuits, three-channel type C carrier and single channel type H carrier open-wire systems. In addition other packaged units include voice-frequency ringers, testing equipment, apparatus cabinets for housing panel mounted equipment, and office tool sets. Test and tool equipment required for setting up and maintaining packaged offices is described in chapter 13. Packaged telegraph systems are described in chapter 10. Descriptive information for packaged telephone equipment is given in paragraphs 917 to 920 inclusive.

916. STOCK NUMBERS AND LOGISTICAL DATA.

Paragraph 921 lists the stock numbers and logistical data for packaged telephone equipment.

917. VOICE FREQUENCY TELEPHONE EQUIPMENT - FIXED PLANT - DESCRIPTION.

Type	Nomenclature Name	Type No. ^a	Shown in Fig. No.	Weight Installed	Height Installed	115V		TM or Instruction Books	Remarks
						50-60 AC VA	b, c		
a	Panel; Line Terminating and Simplex; Telephone	X-61823H	913	10	3-1/2" ^c			TM 11-2020 or X-66247	For terminating noncomposited open wire and cable circuits. Can be used with 20-cycle or 1000-cycle signaling. Provides simplex telegraph leg. Furnished in one shipping case. Includes protector drainage 1:1 ratio repeating coil, test jacks, instruction books, drawings, spare protector blocks. Paired cross connecting wire not included.
b	Panel; Line Terminating and Composite; Telephone	X-61823C	914	43	8-3/4" ^c			TM 11-2031 or X-66150	For terminating composited open wire and cable circuits. Used only on circuits with 1000-cycle signaling. Provides 2 composited d-c telegraph legs. Furnished in one shipping case. Includes protector drainage, 1:1 ratio repeating coil, composite set, test jacks, instruction book, drawings, spare protector blocks. Paired cross connecting wire not included.
c	Repeater Package; Telephone; V.F. (single)	X-61821J	915	455	4' 1" ^{a, d}	70		TM 11-2021 or X-63641 TM 11-2027 or X-66231 TM 11-2028 or X-66230 TM 11-2042 or X-66260 TM 11-2046 or X-61806	A single 22 type repeater used on physical, side or phantom, cable or open wire circuits. Can also be used as a four-wire repeater. 1000-20 cycle ringers included. Ringer cross-connectable to any 2 telephone circuits. Bridging circuit for bridged extension included. Provides 2 composited d-c telegraph legs on each side of repeater. Furnished in one shipping case. Includes protector drainage, d-c composite sets, line and composite balancing networks adjustable for almost any type of line, test jacks, telephone, a-c convenience outlets, cross-connecting wire, instruction books, drawings, approx. 200% spare vacuum tubes, spare protector blocks, voltmeter, test receiver, spare fuses, plugs, test cords, maintenance tools.
d	Repeater Package; Telephone; V.F. (triple)	X-61821K	916	565	7' 0" ^{a, d}	70		TM 11-2027 or X-66231 TM 11-2028 or X-66230	Three 22-type repeaters used on physical, side or phantom, cable or open wire circuits. Can also be used as four-wire repeaters. Provides two composited telegraph legs, on each side of each repeater. Cross connectable bridging circuit for use on bridged extensions included. Furnished in two shipping cases. Includes protector drainage, d-c composite sets, line and composite balancing networks adjustable for almost any type of line, test jacks, telephone set. A-c convenience outlets, cross connecting wire, instruction books, drawings, approx. 200% spare vacuum tubes, spare protector blocks, spare fuses, test cords, plugs, maintenance tools.

^aWestern Electric Co. code.

^b115 volts, 50-60 cycle VA figures. To obtain power in watts multiply VA figure by 0.86.

^cEquipment is on a 19" panel which must be mounted in apparatus cabinet, paragraph 920.

^dEquipment is in a steel cabinet requiring floor space 1' 10-1/4" wide x 1' 5" deep. Four feet clearance front and rear desirable for access to equipment.

^eAll equipment must have adequate power supply based on requirements of each office taken as a whole.

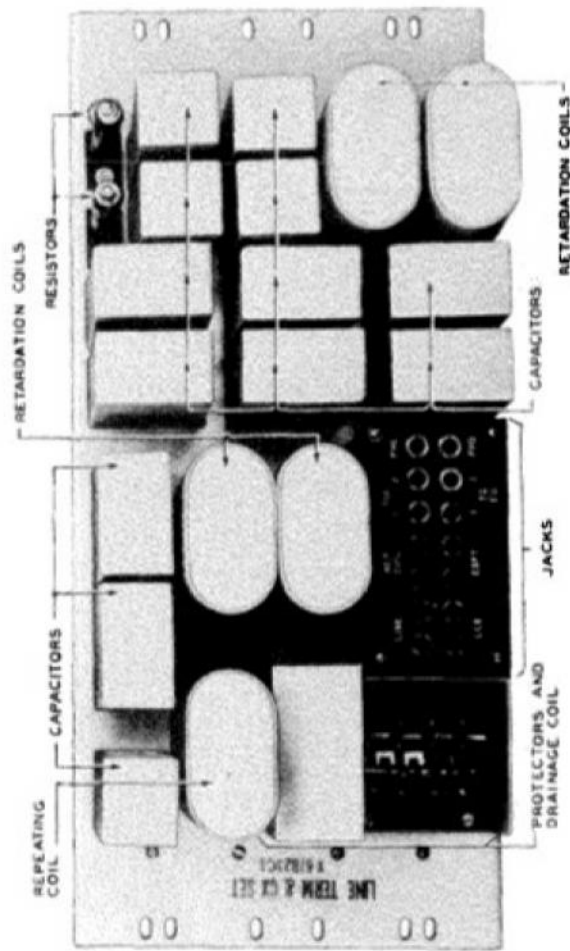

FIGURE 914. Panel; Line Terminating and Composite; Telephone X-61823C

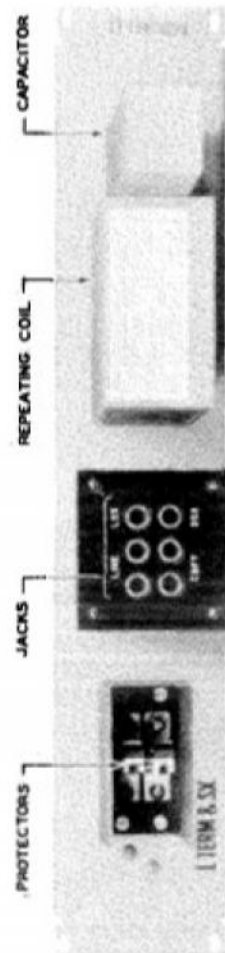

FIGURE 913. Panel; Line Terminating and Simplex; Telephone X-61823H

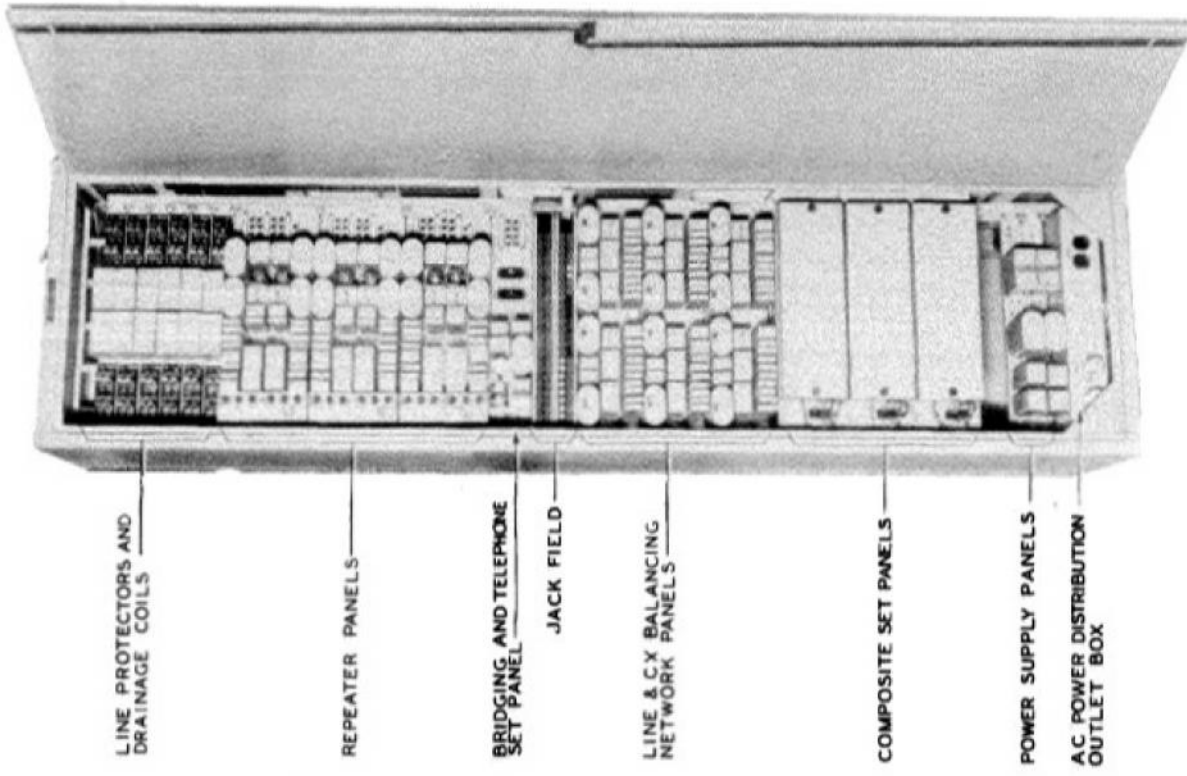

FIGURE 916. Repeater Package; Telephone; V.F. (Triple) X-61821K

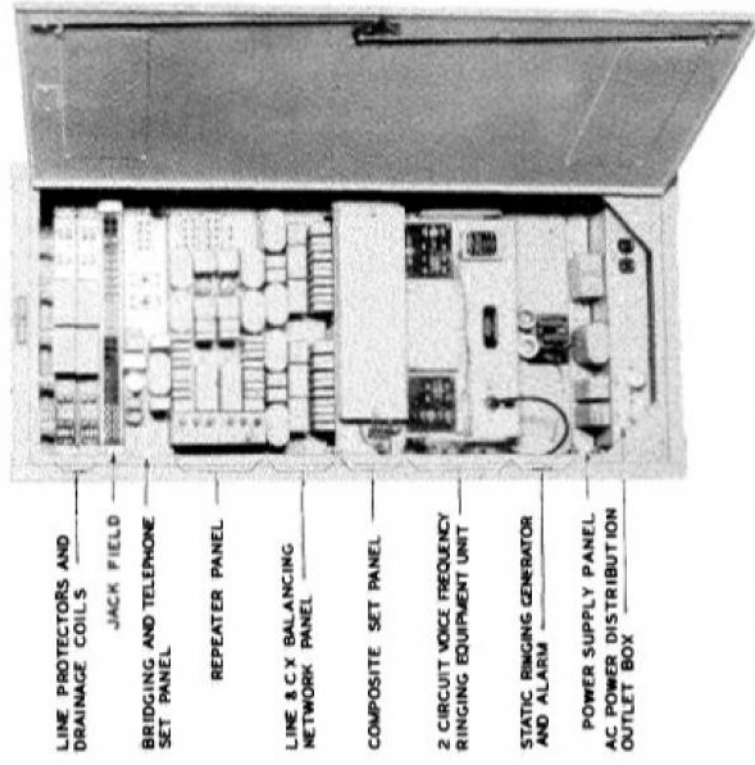

FIGURE 915. Repeater Package; Telephone; V.F. (Single) X-61821J

918. VOICE FREQUENCY RINGING EQUIPMENT - FIXED PLANT - DESCRIPTION.

Item	Nomenclature		Shown in Fig. No.	Weight Installed	Height Installed	50-60 AC VA ^{b,e}	115V	TM or Instruction Book	Remarks
	Name	Type No.							
a	Ringer Package: Voice Frequency; 4 Circuit	X-61820A ^a	917	245	2' 4" ^c	85		TM 11-2021 or X-63641 ^a	Four 1000-20 cycle ringers for equipping four telephone circuits at one terminal point. Includes 20-cycle generator to signal switchboard or telephone. Furnished in one shipping case: Includes instruction books, drawings, approx. 200% spare vacuum tubes, spare fuses.
b	Ringer Package: Voice Frequency; 2 Circuit	X-61820B ^a	Same as 1 Unit of fig. 917	90	14" ^d	45		TM 11-2021 or X-63641 ^a	Two 1000-20 cycle ringers for equipping two telephone circuits at one terminal point. Otherwise same as item a.
c	Ringer Package: Telephone; Voice Frequency	TA-3/FT	918	26	7" ^d	11		TM 11-2011	One ringer arranged for either 1000-20 or 500-20 cycle ringing. Includes 20-cycle generator to signal switchboard or telephone. Also may be operated from 12 volt battery using 1.1 amperes.

^aWestern Electric Co. code numbers.

^b115-volt, 50-60-cycle VA figures. To obtain power in watts multiply VA figure by 0.85.

^cEquipment is in a steel cabinet requiring floor space 1' 10-1/4" wide x 1' 5" deep. Cabinets can be stacked. Four feet clearance front and rear desirable for access to equipment.

^dEquipment is on a 19" panel which must be mounted in apparatus cabinet, paragraph 920.

^eAll equipment must have adequate power supply based on requirements of each office taken as a whole.

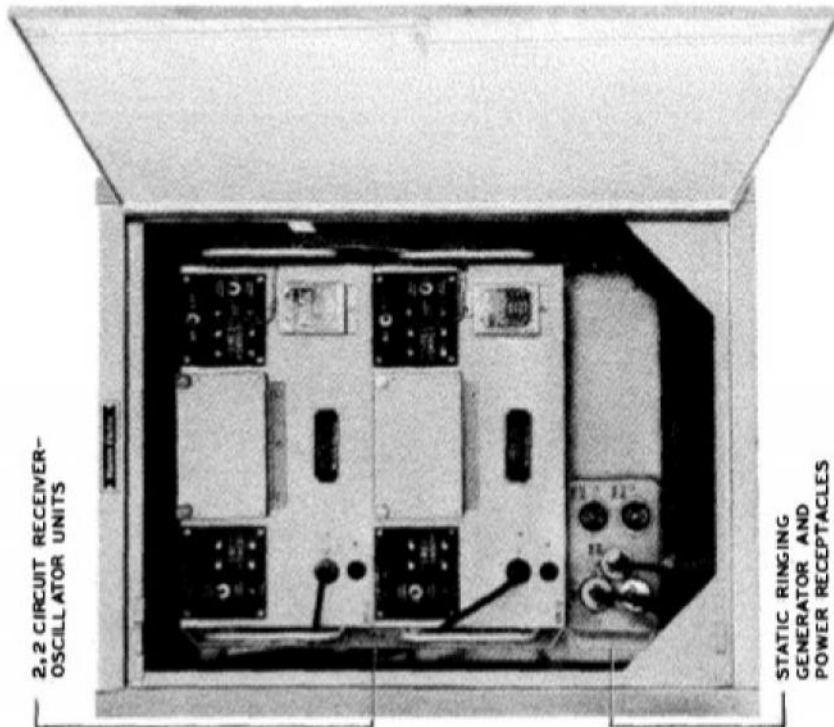

FIGURE 917. Ringer Package; Voice Frequency; 4 Circuit X-61820A

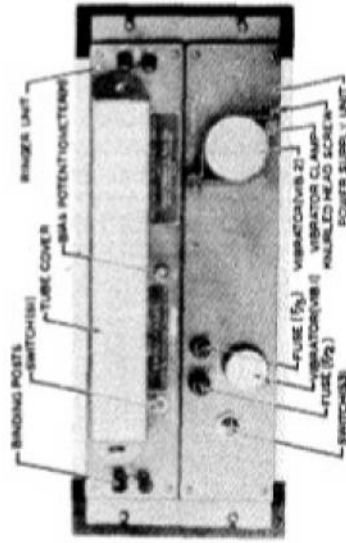

FIGURE 918. Ringer Package; Telephone; Voice Frequency TA-S/FT

919. CARRIER TELEPHONE EQUIPMENT - FIXED PLANT - DESCRIPTION.

Item	Nomenclature		Shown in Fig. No.	Weight Installed	Height Installed	115V AC		TM or Instruction Book	Remarks
	Name	Type No.				50-60 VA	b, d		
a	Terminal Package; Telephone; H Carrier	X-66217A ^a	919	55	12-1/4" ^c	60		TM 11-2025 TM 11-2038	Panel may be used as an East or West terminal. Provides one additional equivalent four-wire circuit above voice range on open wire physical or side circuit. Frequency band 4 kc to 10 kc. Must be used with one item c to form complete terminal. May be used for 12-channel voice frequency telegraph. Manual regulation. Two-wire or four-wire voice termination. Furnished in one shipping case. Includes test jacks, drawings, approx. 200% spare vacuum tubes and instruction books
b	Repeater Package; Telephone; H Carrier	X-66217B ^a	920	40 (est.)	8-3/4" ^c	40		TM 11-2025 TM 11-2038	Used to extend length of type H carrier systems. Must be used with 2 items c to form complete repeater. Manual regulation. Furnished in one shipping case. Includes test jacks, drawings, approx. 200% spare vacuum tubes. Instruction books included with item c.
c	Panel: Line Filter and Balancing Telephone	X-66217C ^a	921	20 (est.)	5-1/2" ^c	-		TM 11-2025 TM 11-2038	Used at type H terminals and repeaters items a and b, to separate type H carrier and voice circuits. Must operate with par. 918 items a, b, c or d to provide protector drainage. Two panels may be connected to transfer H carrier to another line or to terminate a voice circuit when carrier continues. Furnished in one shipping case. Includes H carrier line filter, carrier balancing equipment for balancing voice repeaters and phantom circuits, cross connecting wire, instruction books, drawings.

^aWestern Electric Co. code numbers.

^b115-volt, 50-60-cycle VA figures. To obtain power in watts multiply VA figure by 0.85.

^cEquipment is on a 19" panel which must be mounted in apparatus cabinet, paragraph 920.

^dAll equipment must have adequate power supply based on requirements of each office taken as a whole.

CARRIER TELEPHONE EQUIPMENT - FIXED PLANT - DESCRIPTION (Continued)

Item	Nomenclature		Shown in Fig. No.	Weight Installed	Height Installed	115V		TM or Instruction Book
	Name	Type No.				50-60 AC VA	b,d	

d Terminal Package; Telephone; C Carrier; East

X-61819P^a 922 1190 c 300

TM 11-2023 or X-66229^a
TM 11-2026 or X-66228^a

Used at East end of C carrier system. Used with item e to form complete system. Provides three additional equivalent four-wire circuits above voice range on open wire physical or side circuit and two composited telegraph legs. Frequency band 5.3 to 15.7 kc East to West and 17.7 to 28.4 kc West to East. Each channel may be used for 12-channel voice frequency telegraph. Automatic regulation. External grid batteries must be furnished as follows: two BA-8, ten BA-27, six BA-39. Furnished in three shipping cases.

Includes protector drainage; composite set; line filter; carrier balancing equipment for balancing voice repeaters and phantom circuits; equipped for CS and CU frequency allocation, wired for CS allocation; four-wire terminating sets to provide two-wire terminations. Volume limiters, pads for four-wire termination on any channel. Test jacks, telephone, a-c convenience outlets. Also includes cross-connecting wire, instruction books, drawings, approx. 200% spare vacuum tubes, spare fuses, spare protector blocks, patch cords and plugs, 0, 3, 6, 9 db pads for four-wire terminating sets.

e Terminal Package; Telephone; C Carrier; West

X-61819P^a 922 1190 c 300

TM 11-2023 or X-66229^a
TM 11-2026 or X-66228^a

Used at West end of C Carrier system. Used with item d to form complete system. Otherwise same as item d.

f Repeater Package; Telephone; C Carrier

X-61819S^a 923 1080 c 240

TM 11-2023 or X-66229^a
TM 11-2026 or X-66228^a

Used to extend length of type C Carrier systems. Provides 2 composited telegraph legs in each direction. Automatic regulation. Following batteries must be furnished; six BA-34. Furnished in three shipping cases.

Includes protector drainage, composite sets on each side of repeater, line filters, carrier balancing equipment for balancing voice repeaters and phantom circuits. Equipped for CS and CU frequency allocation. Wired for CS allocation. Test jacks, a-c convenience outlets. Also includes cross-connecting wire, instruction books, drawings, approx. 200% spare vacuum tubes, spare fuses, spare protector blocks, patch cords and plugs.

^aWestern Electric Co. code numbers.
^b115-volt, 50-60-cycle VA figures. To obtain power in watts multiply VA figure by 0.85.
^cEquipment is furnished in two steel cabinets each 7' high, each requiring floor space 1' 10-1/4" wide by 1' 5" deep. Four foot clearance front and rear desirable for access to equipment.
^dAll equipment must have adequate power supply based on requirements of each office taken as a whole.

Item	Nomenclature		Shown in Fig. No.	Weight Installed	Height Installed	50-60° AG VA	TM or Instruction Book	Remarks
	Items	Type No.						
g	Panel; Transfer; C Carrier; Packaged	X-61823P ^a	-	90	17-1/2" ^b	-	TM 11-2031 or X-66150 ^a	Used at non-C Carrier Repeater points to transfer C Carrier system to another line pair, or to terminate a voice circuit when C system continues. Must operate with paragraph 917 items a, b, c, or d. Used for CS or CU frequency allocations. Furnished in one shipping case. Includes two C Carrier line filters, carrier balancing equipment for balancing voice repeaters and phantom circuits, instruction books, drawings, Cross connecting wire not included.
h	Telephone Unit	EE-105	-	-	-	-	-	See paragraph 908.

^a Western Electric Co. code numbers.

^b Equipment is on a 19" panel which must be mounted in apparatus cabinet, paragraph 920.

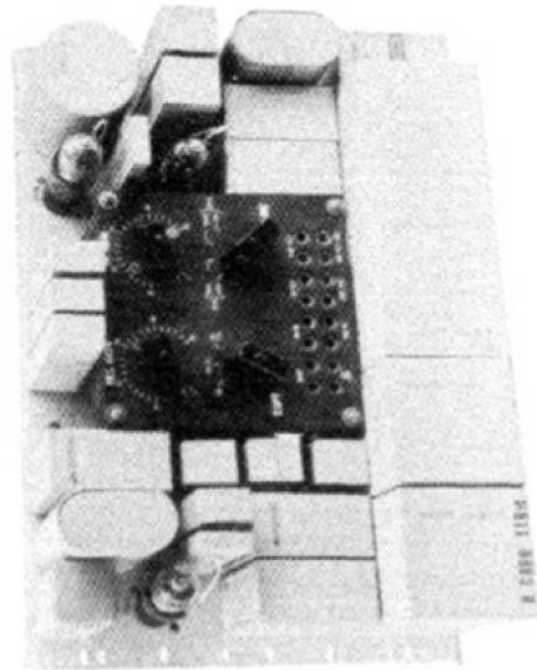

FIGURE 919. Terminal Package; Telephone; H Carrier X-66217A

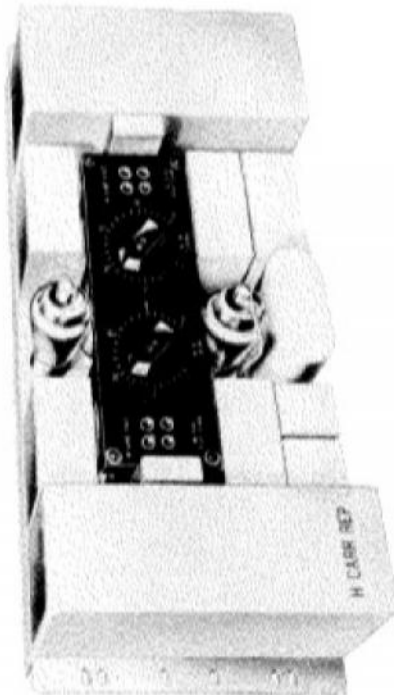

FIGURE 920. Repeater Package: Telephone;
H Carrier X-66217B

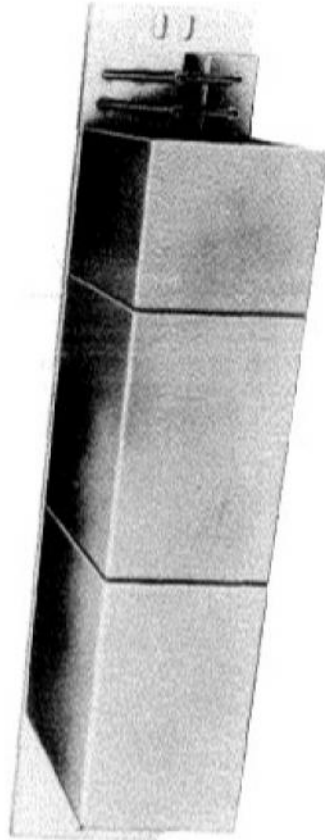

FIGURE 921. Panel: Line Filter and Balancing;
Telephone X-66217C

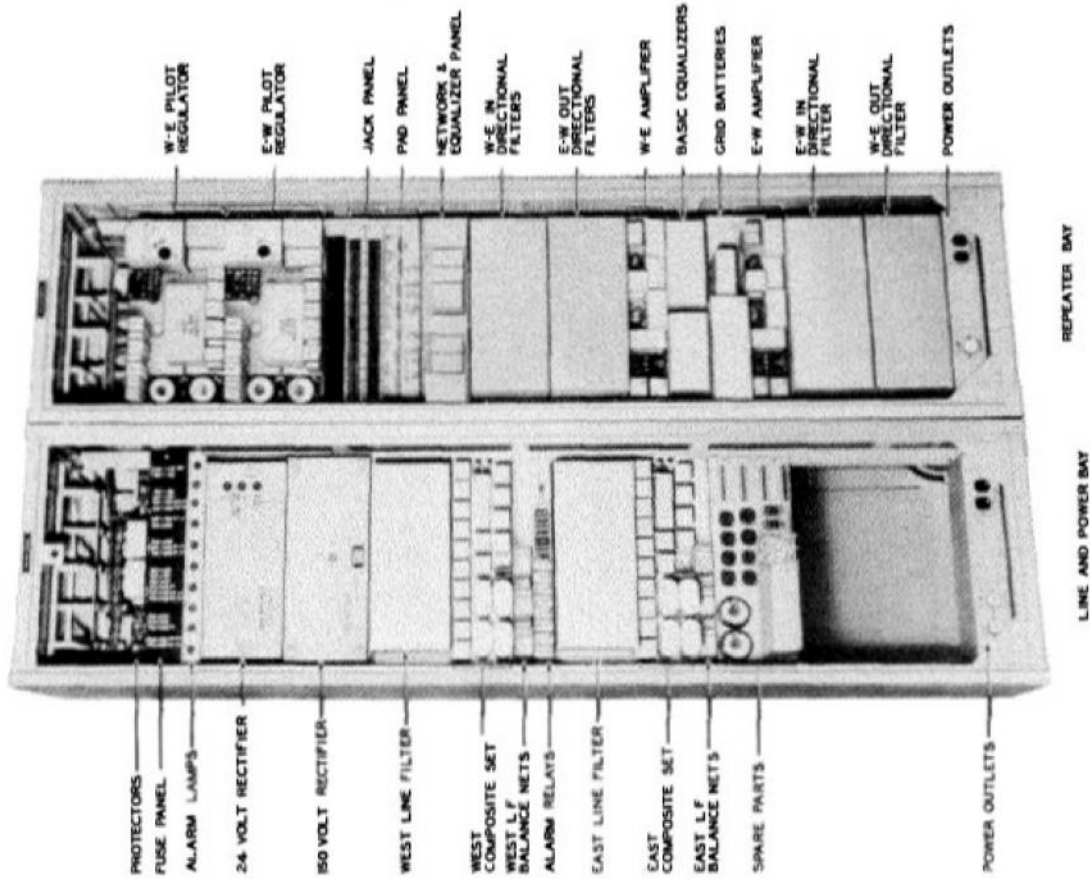

FIGURE 923. Repeater Package: Telephone; C Carrier X-61819S

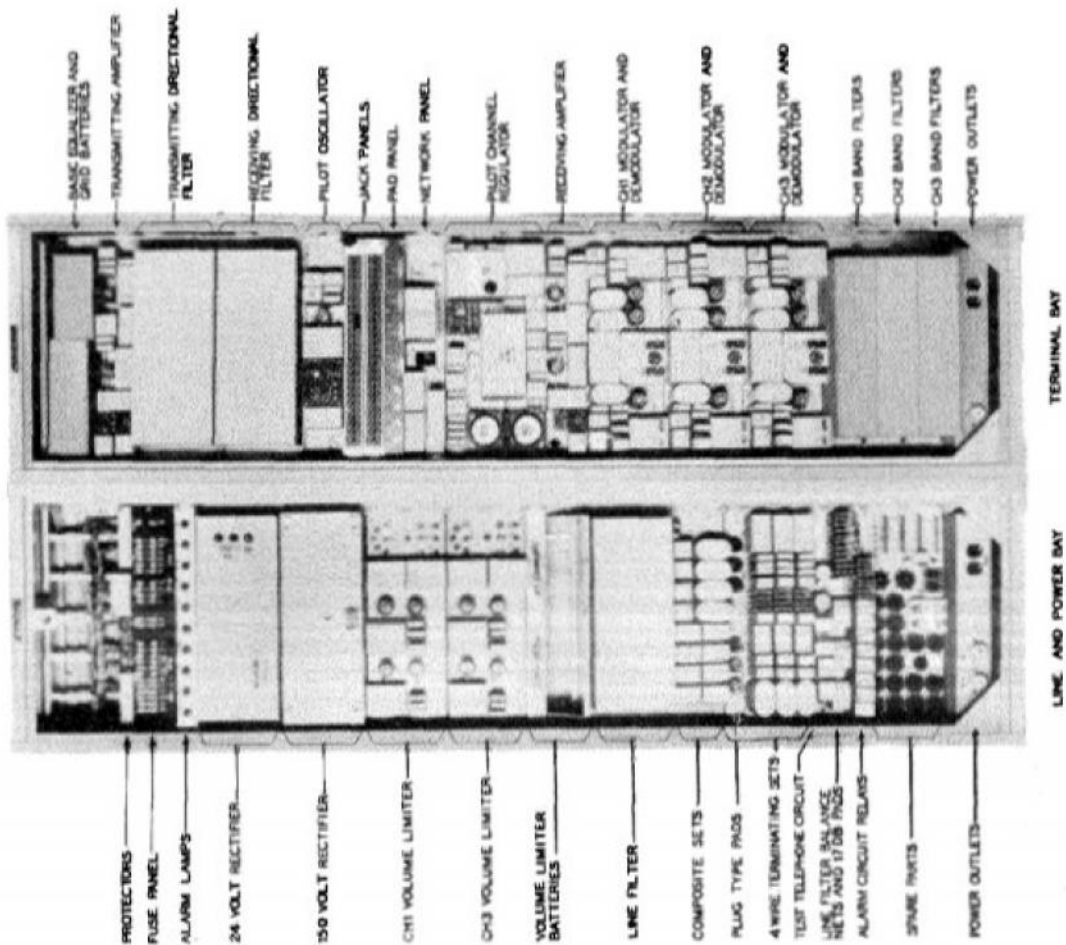

FIGURE 922. Terminal Package: Telephone; C Carrier X-61819P or R

920. APPARATUS CABINETS FOR TELEPHONE LINE TRANSMISSION EQUIPMENT - FIXED PLANT - DESCRIPTION

Item	Nomenclature		Estimated Weight Installed	Height Installed ^b	Remarks
	Name	Type No. ^a			
a	Cabinet: Telephone; Apparatus; 2' 4" high	X-61823D	95	2' 4"	For mounting equipment furnished on 19" panels. Has built in relay rack with 22-3/4" vertical mounting plate space. Cabinets may be stacked. Furnished in one shipping case. A-c convenience outlets for supplying power to equipment and test sets. Includes drawing of power supply circuit.
b	Cabinet: Telephone; Apparatus; 3' 6" high	X-61823E	140	3' 6"	For mounting equipment furnished on 19" panels. Has built in relay rack with 35" vertical mounting plate space. Cabinets may be stacked. Otherwise same as item a.
c	Cabinet: Telephone; Apparatus; 7' 0" high	X-61823F	250	7' 0"	For mounting equipment furnished on 19" panels. Has built in relay rack with 77" vertical mounting plate space. Otherwise same as item a.

^aWestern Electric Co. code numbers.

^bSteel cabinets require floor space 1' 10-1/4" wide x 1' 5" deep. Four feet clearance front and rear desirable for access to equipment.

921. TELEPHONE LINE TRANSMISSION EQUIPMENT - FIXED PLANT - STOCK NUMBERS AND LOGISTICAL DATA.

Nomenclature Name	Type No. ^a	Weight - lbs. Largest Package Packed for		Total Weight - lbs. Packed for		Total Cu. Ft. Packed for		Ship Tons ^b
		Export	Export	Export	Export	Export	Export	
VOICE FREQUENCY TELEPHONE EQUIPMENT								
Panel; Line Terminating and Simplifier; Telephone	X-61823H	30		30		1.8		-
Panel; Line Terminating and Composite; Telephone	X-61823C	75		75		3.5		.1
Repeater Package; Telephone; V.F. (single)	X-61821J	610		610		25.0		.6
Repeater Package; Telephone; V.F. (triple)	X-61821K	835		940		35.5		.9
VOICE FREQUENCY RINGERS								
Ringer Package; Voice Frequency; 4-Circuit	X-61820A	325		325		11.0		.3
Ringer Package; Voice Frequency; 2-Circuit	X-61820B	145		145		5.3		.1
Ringer	TA-3/FT	70		70		3.6		.1
CARRIER FREQUENCY TELEPHONE EQUIPMENT								
Terminal Package; Telephone; H Carrier	X-66217A	125 ^c		125 ^c		6.0 ^c		.2
Repeater Package; Telephone; H Carrier	X-66217B	70 ^c		70 ^c		4.5 ^c		.1 ^c
Panel; Line Filter and Balancing; Telephone	X-66217C	40 ^c		40 ^c		2.9 ^c		.1 ^c
Terminal Package; Telephone; C Carrier; East	X-61819P	810		1680		75.0		1.9
Terminal Package; Telephone; C Carrier; West	X-61819R	810		1680		75.0		1.9
Repeater Package; Telephone; C Carrier	X-61819S	725		1570		75.0		1.9
Panel; Transfer; C Carrier; Packaged Telephone Unit	X-61823B EE-105	150		150		6.0		.2
APPARATUS CABINETS								
Cabinet; Telephone; Apparatus; 2' 4" high	X-61823D	175 ^c		175 ^c		11.0		.3
Cabinet; Telephone; Apparatus; 3' 6" high	X-61823E	265 ^c		265 ^c		15.7 ^c		.4 ^c
Cabinet; Telephone; Apparatus; 7' high	X-61823F	420 ^c		420 ^c		30.0		.8

^a Western Electric Co. code numbers except TA-3/FT and EE-105

^b 40 cu. ft. assumed equal to 1 ship ton.

^c Approximate values.

922. SELECTION OF EQUIPMENT.

a. Paragraphs 923 and 924 give a general method for selecting the equipment required to set up the various types of telephone circuits and systems. Detailed information will be found in TM 11-2022. Paragraph 923 covers the equipment individual to each telephone circuit or system. Paragraph 924 covers the equipment common to an office. The last column of each table provides a cross-reference to descriptive information on the particular equipment.

b. In ordering equipment, the information in paragraph 923 should be applied to each circuit or system individually. The equipment required is itemized by packages. In the case of voice-frequency repeaters, two options are available, a single repeater package which also contains a two-circuit voice-frequency ringer and a three repeater package. Likewise, a two-circuit voice-frequency ringer package and a four-circuit voice-frequency ringer package are available. The type and number of voice-frequency repeater and ringer packages should be governed by the total number of repeaters and ringers required per office. Obviously, if repeaters and ringers were required for two circuits, two of the three repeater packages would not be ordered. The proper order would be for one three repeater package and one four-circuit ringer package. In general, greatest use should be made of the three repeater package X-61821K and the four-circuit voice-frequency ringer package X-61820A because of the economy of shipping weight and installation time.

c. Paragraph 924 serves as a guide in selecting equipment which is common to an office. When the equipment ordered is furnished on panels, the sum of the heights of all of the panels should be

determined. After the total height of all panels is determined, an apparatus cabinet should be selected, which has sufficient vertical mounting space to house the panels. In addition, consideration should be given to future requirements for mounting space. The office tool set for each office should be selected to provide a sufficient number of tools for the estimated number of men required to operate that office. The summary of office tool sets given in chapter 13 may be used as a guide to determine which office tool set is required. Each office containing packaged carrier equipment should have available a Telephone Unit EE-105 for use by the linemen, so that they can talk over a voice-frequency circuit without disturbing operation of superposed carrier systems.

d. An adequate supply of regular and emergency power should be supplied at each office. The power requirements of an office may be determined by adding the sum of the power required for operation of the telephone equipment to the total power required by the telegraph equipment as determined from chapter 10. To this should be added 350 VA for operation of test sets, soldering irons, etc. and 350 VA for general lighting. Three engine generators are required, two to supply regular power and one for standby. The load should be divided equally between each of the two regular power supplies. The generators should be connected to the equipment through an Automatic Engine Transfer panel in order to maintain uninterrupted service. Information on generators and automatic transfer panels will be found in chapter 12. Power wiring should also be furnished to each cabinet. A good office ground is required together with adequate leads to the equipment cabinets.

**923. SELECTION OF PACKAGED TELEPHONE TRANSMISSION EQUIPMENT - FIXED PLANT
EQUIPMENT REQUIRED PER CIRCUIT.**

Item	Type of Circuit	Equipment Required at Each Office			
		Nomenclature		Reference	
		Name	Type No. ^{a, b, c}	Par.	Item
a	Non-repeatered Voice Circuit Order for conditions (1), (2), (3), or (4) as required. Cross connecting wire must be ordered separately				
(1)	Physical or side circuit arranged for simplex tele- graph, 20-cycle signaling	Panel; Line Terminating and Simplex; Telephone.	X-61823H	917	<u>a</u>
(2)	Physical or side circuit equipped with composite sets, 1000-cycle signaling	Panel; Line Terminating and Composite; Telephone. Ringer Package: Voice Frequency.	X-61823C X-61820A or B	917 918	<u>b</u> <u>a</u> or <u>b</u>
(3)	Phantom circuit, 20-cycle signaling	Panel; Line Terminating and Simplex; Telephone.	X-61823H	917	<u>a</u>
(4)	Phantom circuit, 1000-cycle signaling	Panel; Line Terminating and Simplex; Telephone. Ringer Package: Voice Frequency.	X-61823H X-61820A or B	917 918	<u>a</u> <u>a</u> or <u>b</u>
b	Repeatered Voice Circuit				
(1)	At each terminal without a terminal voice frequency repeater	Panel; Line Terminating and Composite; Telephone. Ringer Package: Voice Frequency.	X-61823C X-61820A or B	917 918	<u>b</u> <u>a</u> or <u>b</u>
(2)	At each terminal with a terminal repeater	Repeater Package: Tele- phone; Voice Frequency. Ringer Package: Voice Frequency (required only with X-61821K).	X-61821J or K X-61820A or B	917 918	<u>c</u> or <u>d</u> <u>a</u> or <u>b</u>
(3)	At each intermediate repeater point	Repeater Package: Tele- phone; Voice Frequency.	X-61821J or K	917	<u>c</u> or <u>d</u>
(4)	At each repeater point at which a bridged circuit is required	Depends on type of exten- sion see Instruction book X-66230.	-		

^aWestern Electric Co. code number.

^bThe number of voice frequency ringer packages required for each office is deter-
mined by the total number of circuits requiring ringers at that office. The four
circuit ringer package X-61820A should be used whenever possible in preference to
the two circuit package X-61820B. The ringers in X-61821J may be used instead of
X-61820A or B, when available.

^cThe number of voice frequency telephone repeater packages required for each office
is determined by the total number of circuits requiring voice repeaters at that
office. The three repeater package X-61821K should be used whenever possible in
preference to the single repeater package X-61821J.

Table continued on next page

**SELECTION OF PACKAGED TELEPHONE TRANSMISSION EQUIPMENT - FIXED PLANT EQUIPMENT
REQUIRED PER CIRCUIT (Continued).**

Item	Type of Circuit	Equipment Required at Each Office			
		Name	Type No. ^{a,b,c}	Reference Par. Item	
c Type C Carrier System					
(1)	At East Terminal In addition provide the following: 2 Batteries BA-8, 10 Batteries BA-27, 6 Batteries BA-34	Terminal Package: Telephone; C Carrier; East. Ringer Package: Voice Frequency. (One ringer per channel. No ringer required on channels equipped with V.F. Telegraph).	X-61819P X-61820A	919 918	<u>d</u> <u>a</u>
(2)	At West Terminal In addition provide the following: 2 Batteries BA-8, 10 Batteries BA-27, 6 Batteries BA-34	Terminal Package: Telephone; C Carrier; West. Ringer Package: Voice Frequency. (One ringer per channel. No ringer required on channels equipped with V.F. Telegraph).	X-61819R X-61820A	919 918	<u>e</u> <u>a</u>
(3)	At C Carrier Repeater Point In addition provide the following: 6 Batteries BA-34	Repeater Package: Telephone; C Carrier	X-61819S	919	<u>f</u>
d Type H Carrier System					
(1)	At each terminal	Terminal Package: Telephone; H Carrier. Panel; Line Filter and Balancing; Telephone. Ringer Package: Voice Frequency. (Voice circuit equipment per items <u>a</u> or <u>b</u> must be furnished)	X-66217A X-66217C X-61820A or B	919 919 918	<u>a</u> <u>e</u> <u>a</u> or <u>b</u>
(2)	At each H Carrier Repeater Point	Repeater Package: Telephone; H Carrier. Two Panels; Line Filter and Balancing; Telephone. (Voice circuit equipment per items <u>a</u> or <u>b</u> must be furnished on each side of H Repeater)	X-66217B X-66217C	919 919	<u>b</u> <u>e</u>
e Carrier Transfer Sets					
(1)	At each C Carrier Transfer Point	Panel; Transfer; C Carrier; Packaged. (Voice circuit equipment per items <u>a</u> or <u>b</u> must be furnished on each side of transfer panel)	X-61823B	919	<u>e</u>
(2)	At each H Carrier Transfer Point	Two Panels; Line Filter and Balancing; Telephone. (Voice circuit equipment per items <u>a</u> or <u>b</u> must be furnished on line side of each line panel)	X-66217C	919	<u>e</u>

^aWestern Electric Co. code number.

^bThe number of voice frequency ringer packages required for each office is determined by the total number of circuits requiring ringers at that office. The four circuit ringer package X-61820A should be used whenever possible in preference to the two circuit package X-61820B. The ringers in X-61821J may be used instead of X-61820A or B, when available.

^cThe number of voice frequency telephone repeater packages required for each office is determined by the total number of circuits requiring voice repeaters at that office. The three repeater package X-61821K should be used whenever possible in preference to the single repeater package X-61821J.

**924. SELECTION OF TELEPHONE LINE TRANSMISSION EQUIPMENT - FIXED PLANT
COMMON EQUIPMENT REQUIRED PER OFFICE.**

Item	Equipment Required	Equipment Required at Each Office		
		Name	Type No. ^a	Reference Par. Item
a	<u>Apparatus Cabinets</u>			
	Equipment mounted on 19-inch wide panels, not furnished in cabinets, should be mounted in one of the following apparatus cabinets according to the space required. One cabinet may house several types of panels.			
	(1) 22-3/4 inches vertical mounting space	Cabinet: Telephone; Apparatus; 2'-4" high	X-61823D	920 <u>a</u>
	(2) 35 inches vertical mounting space	Cabinet: Telephone; Apparatus; 3'-6" high	X-61823E	920 <u>b</u>
	(3) 77 inches vertical mounting space	Cabinet: Telephone; Apparatus; 7' high	X-61823F	920 <u>c</u>
b	<u>Office Tool Sets</u>			
	Any office which contains packaged equipment should be equipped with one of the following office tool sets.			
		Tool Set: Telephone and Telegraph; Installation and Maintenance; for Small Offices	X-66086	1311
		Tool Set: Telephone and Telegraph; Installation and Maintenance; for Medium Offices	X-66087	1311
		Tool Set: Telephone and Telegraph; Installation and Maintenance; for Large Offices	X-66088	1311
c	<u>Testing Equipment</u>			
	Each office which contains any of the following telephone equipment should have available the testing equipment listed below. Only one test package of each type is normally required per office. At each office equipped with			
	(1) Line Terminating and Simplex Panels	None		
	(2) Line Terminating and Composite Panels	None		
	(3) One Voice Frequency Repeater	None		
	(4) Two or more Voice Frequency Repeaters	Testing Package: Telephone; Voice Frequency	X-61821L	1314
	(5) Type H Carrier	Testing Package: Telephone; Voice Frequency	X-61821L	1314
	(6) Type C Carrier	Testing Package: Telephone; C Carrier	X-61819T	1314
		Testing Package: Telephone; Voice Frequency	X-61821L	1314
d	<u>Lineman's Telephone Set</u>			
	Each office containing types C or H carrier equipment should have available a lineman's telephone set designed for use by lineman working on carrier equipped lines.	Telephone Unit	EE-105	919 <u>h</u>

^aWestern Electric Co. code numbers except Telephone Unit EE-105.

Table continued on next page

SELECTION OF TELEPHONE LINE TRANSMISSION EQUIPMENT - FIXED PLANT
COMMON EQUIPMENT REQUIRED PER OFFICE (Continued).

Item	Equipment Required	Equipment Required at Each Office		Reference Par. Item
		Name	Type No. ^a	
<u>e</u>	<u>Power Supply</u> An adequate supply of regular and emergency power to care for ultimate office requirements should be provided. In addition to power required by telephone and telegraph equipment provide the following: 350VA for test sets, soldering irons, etc. 550VA for general lighting. Refer to Chapter 10 for telegraph and teletype-writer power requirements. Power wiring to each cabinet must be ordered separately. Regular and Emergency Power	3-115 Volt 60 Cycle a-c Engine Alternators. Automatic Engine Power Transfer Panel (Number of panels determined by load, each panel has 2 busses, each with 50 amperes capacity)	Model ^a A-100-A-GD6	
<u>f</u>	<u>Grounds</u> A good ground is required. Ground wiring to each line of cabinets must be furnished separately.			

^aMade by Pacific Enterprises, San Francisco, Calif.

925. EXAMPLES OF USE OF PACKAGED EQUIPMENT.

a. Three examples, paragraphs 926, 927, and 928 are given to show the application of the ordering methods outlined in paragraphs 923 and 924. The upper part of each figure shows in a general way the type of equipment and circuit arrangements to be set up. The lower part of each figure shows the equipment which should be ordered. The packages are indicated by boxes outlined by solid lines, and the equipment making up each package is enclosed by dash lines. In all cases spare parts are included. In the smaller packages these are included in the same box as the equipment and in the larger packages they are packed in separate boxes. The testing equipment and tools required at each office for setting up and maintaining the equipment are shown in the boxes below the equipment associated with the telephone circuits.

b. Paragraph 926 illustrates the condition where one pair of wires is equipped to provide a low net loss Type H carrier circuit and a high net loss voice-frequency circuit with an intermediate repeater. As such a pair would ordinarily be used for composited d-c telegraph circuits, line terminating and composite panels, and not line terminating and simplex panels, are used at the terminals of the voice-frequency circuit. It is assumed that there is little possibility of further expansion on this line, so the single repeater package is used at Office B. The two spare ringers provided in this package may be used on other circuits terminating there if desired. At Office A, Apparatus Cabinet X-61823E is required to mount the several types of voice and carrier equipment. At Office C it is anticipated that there may be requirements for further panel mounted equipment, so Apparatus Cabinet X-61823F has been indicated in preference to the smaller cabinet which would otherwise be adequate.

c. Paragraph 927 illustrates the use of packaged equipment to provide one Type C system and one voice-frequency telephone circuit with intermediate repeaters on a single open-wire pair. Although the

requirements for voice-frequency ringers and repeaters are identical at Office A and Office C, ordering of different packages is indicated in order to illustrate the options which may be exercised in this connection. Office A is considered to be on the outer fringe of a communications network with little anticipated future growth. Hence, a single voice-frequency repeater package is used. The ringer requirements are met by providing only a two-circuit voice-frequency ringer, which together with the two-circuit ringer in the repeater package, meet the requirements. Office C, however, is assumed to be a larger office for which considerable growth is anticipated. In this case a three repeater package is provided although only one repeater is required for the layout shown. A four-circuit voice-frequency ringer package X-61820A is also used. The spare repeaters and ringers are available for use on other circuits.

d. Paragraph 928 shows the equipment layout for two open-wire pairs arranged to provide one Type C and one Type H carrier system and two voice-frequency circuits with terminal and intermediate repeaters. The three repeater voice-frequency repeater package X-61821K is used at each office instead of two single repeater packages. This provides one spare repeater at each location which may be used for a third voice-frequency circuit when required. At Office A two four-circuit voice-frequency ringer packages X-61820A are used, leaving three spare ringers for use on other circuits. At Office C only one four-circuit voice-frequency ringer package and one two-circuit package are used. The use of the two-circuit voice-frequency ringer package X-61820B in this case is a matter of judgment and is shown to indicate the possible variations in treatment. One spare ringer is available at Office C; therefore, one more voice-frequency circuit could be added between A and C without ordering additional equipment.

e. Illustrative problems in the ordering of complete communication systems are given in chapter 2.

926. H CARRIER PACKAGED EQUIPMENT ON A SINGLE OPEN WIRE PAIR.

a. Circuit Arrangement.

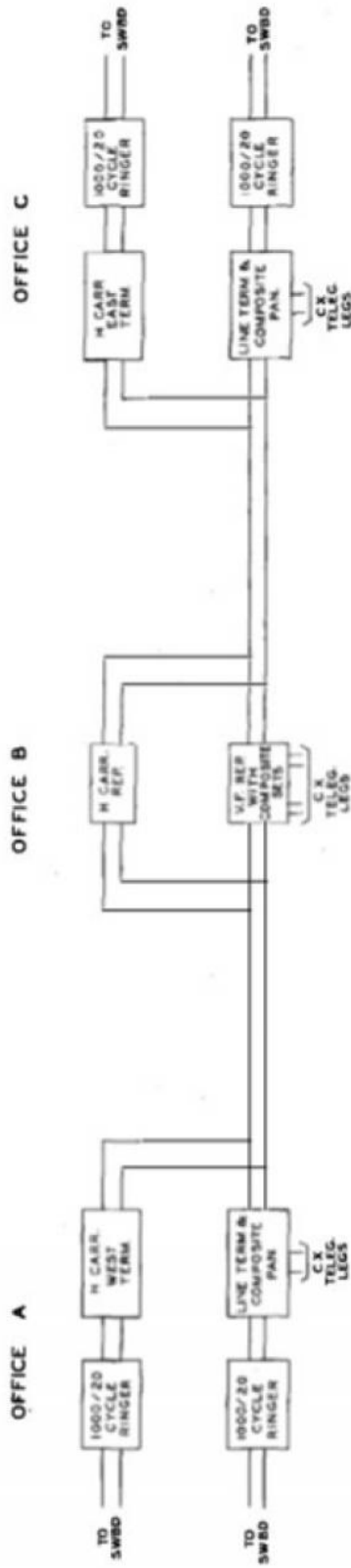

b. Packaged Equipment.

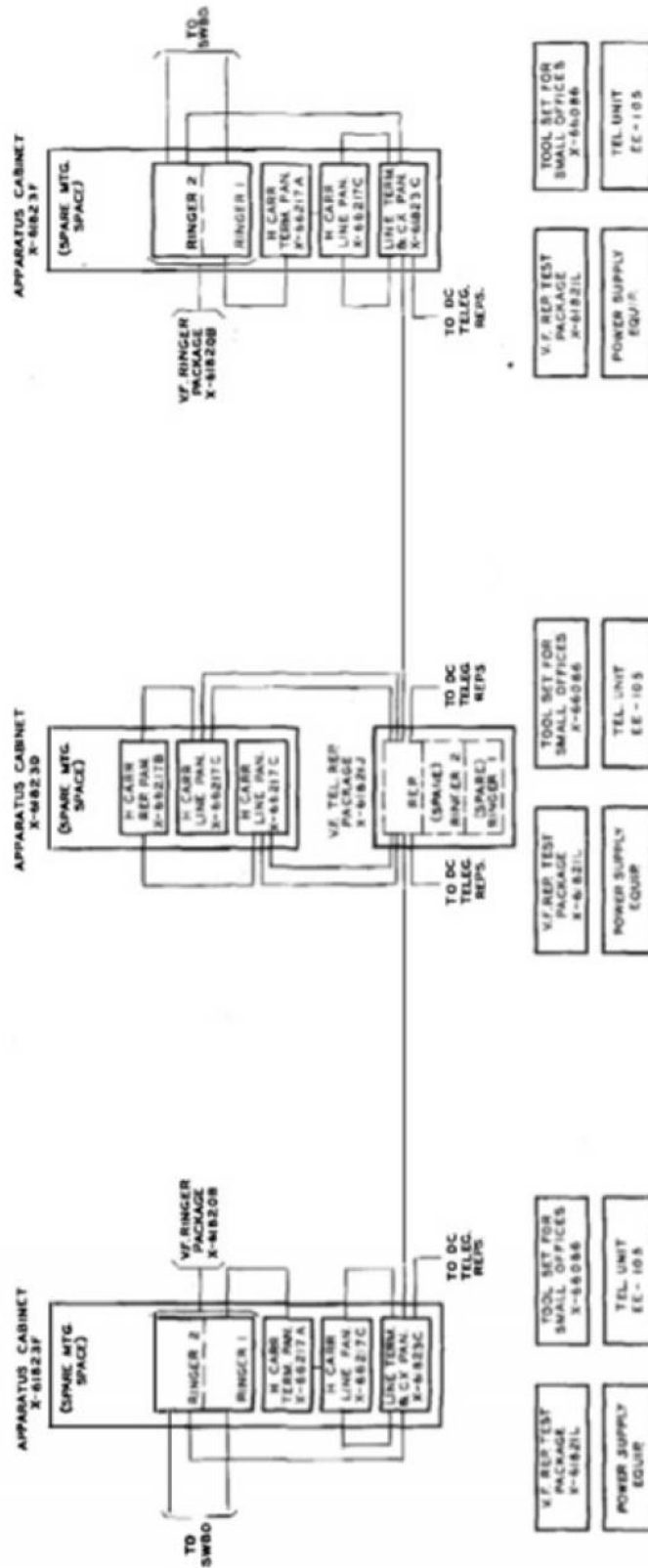

927. C CARRIER PACKAGED EQUIPMENT ON A SINGLE OPEN WIRE PAIR.

a. Circuit Arrangement.

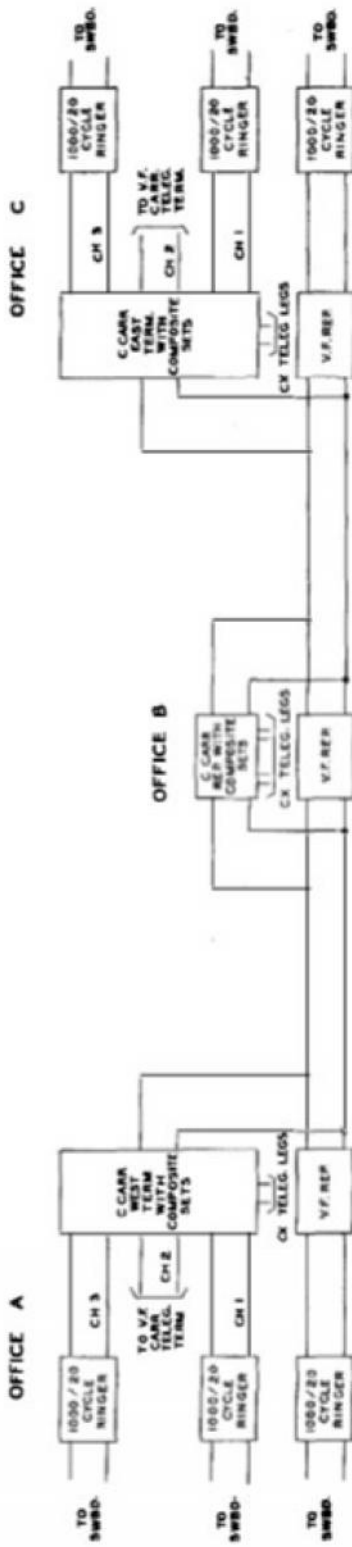

b. Packaged Equipment.

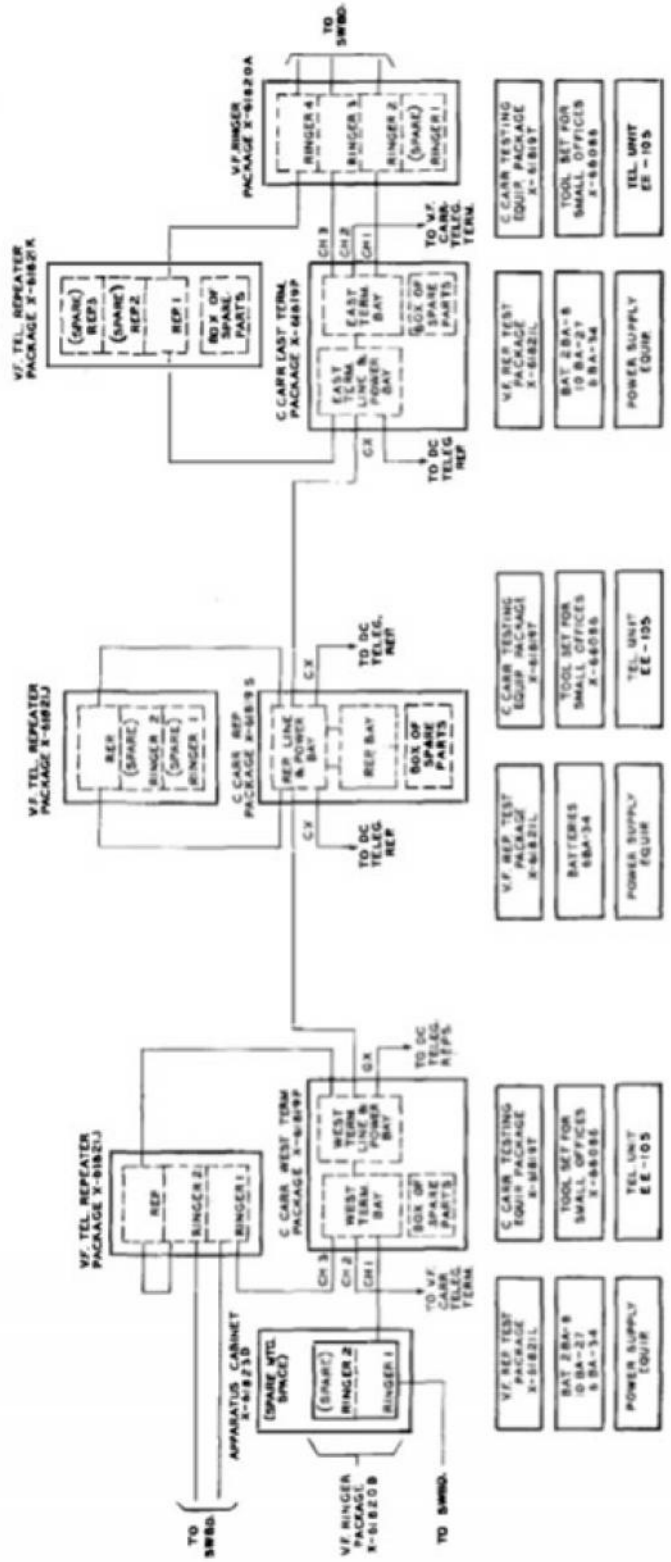

928. C AND H CARRIER PACKAGED EQUIPMENT ON TWO OPEN WIRE PAIRS.

B. Circuit Arrangement.

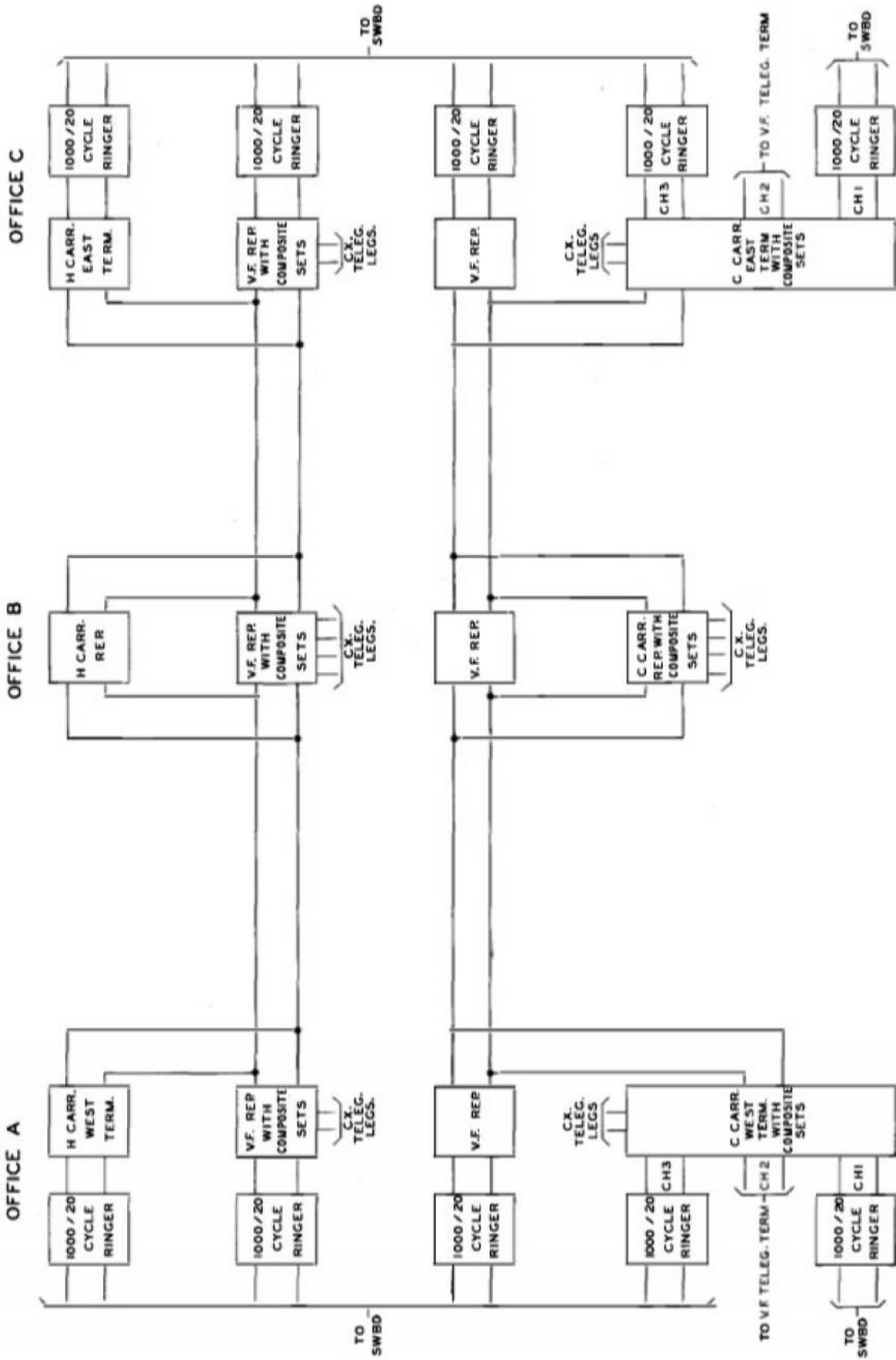

b. Packaged Equipment.

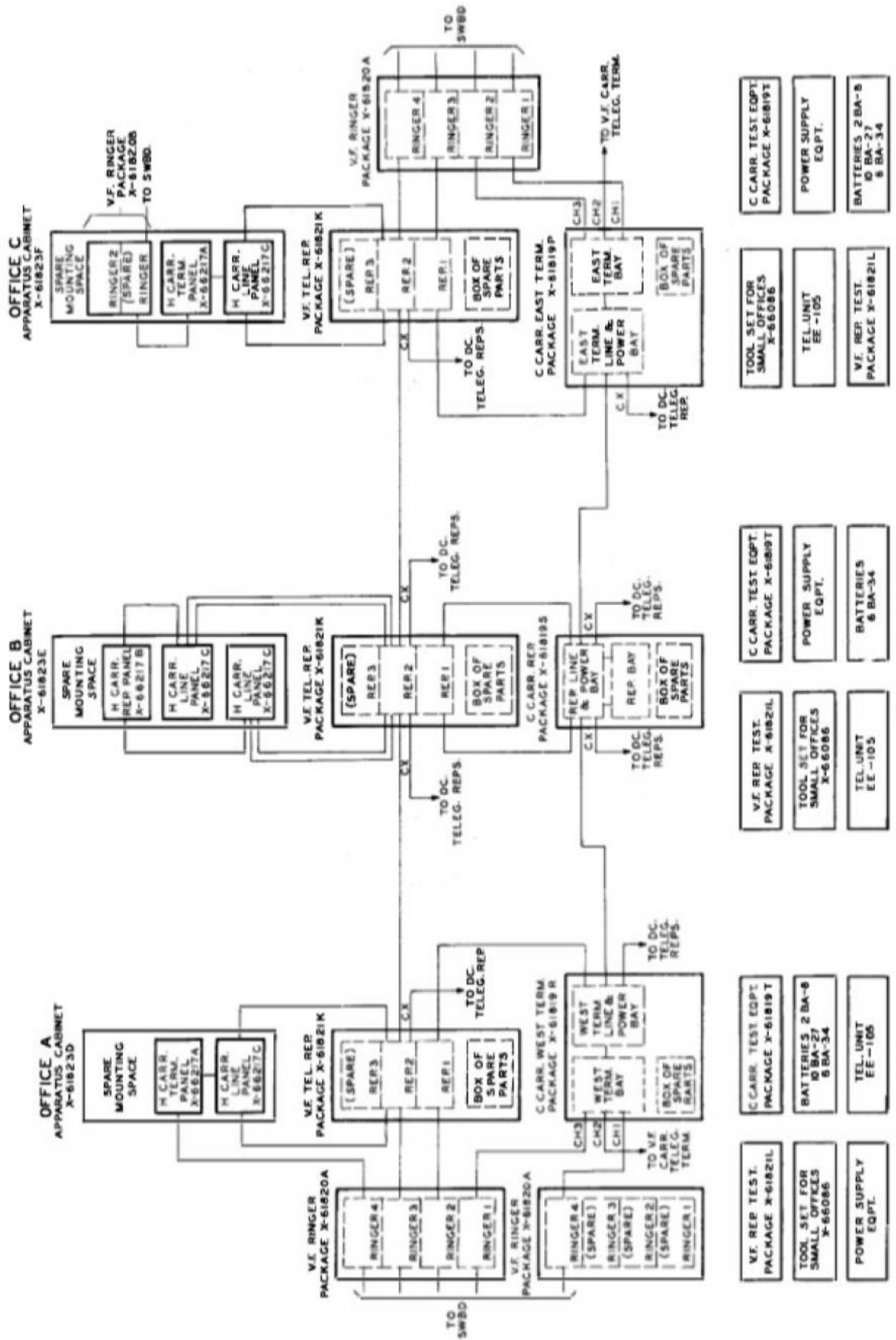

This Page Intentionally Blank

CHAPTER 10
TELEGRAPH EQUIPMENT

Section I
General

1001. INTRODUCTION.

a. The telegraph equipment referred to in this chapter includes tactical and fixed plant equipment for operation on wire circuits and on radio links in combination with other communication equipments. Telegraph equipment includes carrier terminal equipment, d-c equipment, teletypewriter equipment and radio-teletype terminal equipment.

b. Composite sets and simplex coils for deriving d-c telegraph circuits are included in the telephone line transmission equipment covered in chapter 9.

c. Section II covers tactical equipment and section III covers fixed plant equipment. In addition to descriptive matter, stock numbers and logistical data these two sections also give illustrations of the use of the various tactical and fixed plant telegraph equipments. The same test sets, tool equipment and teletypewriter supplies are used with both tactical and fixed plant equipment. Test packages are furnished with fixed plant packaged equipments. These items are covered in section IV and in chapter 13.

d. Information on the engineering of systems employing telegraph equipment may be obtained from "Electrical Communication Systems Engineering - General Information" TM 11-486. More detailed information regarding particular types of equipment can be obtained from "Application of Fixed Plant Telephone and Telegraph Packaged Equipment to Open Wire Lines" TM 11-2022 and to Technical Manuals, Instruction Books or Instruction Manuals covering the individual equipments. Technical Manuals are issued by the War Department. Instruction Books (I-numbers) are prepared by the Western Electric Co. Instruction Manuals are prepared by Teletype Corporation.

e. In many cases tactical and fixed plant equipment may be employed in the same system. A problem illustrating the interoperation of tactical and fixed plant wire telegraph equipment is given in chapter 2.

f. As a rule tactical teletypewriter equipments are not supplied with line relays whereas fixed plant teletypewriter equipment are supplied with line relays.

Section II
Telegraph and Teletypewriter Tactical
Equipment

1002. GENERAL.

a. The outstanding feature of tacti-

cal telegraph and teletypewriter equipment is that connections are established in the field by use of cords, plugs, and binding posts without the need for soldered connections. Furthermore, controls for obtaining the required operating options and means for measuring voltage and currents are conveniently located on exterior panels.

b. The tactical carrier telegraph terminal equipment is designed to employ one of the channels made available by the carrier telephone tactical equipment.

c. Teletypewriter sets are issued in all cases with a line unit, rectifier and teletypewriter, and some sets are issued with a gasoline engine power unit in addition. Repeater set nomenclature applies to a terminal or an intermediate d-c telegraph repeater and the sets are issued without a teletypewriter or a power unit. Telegraph sets are manual Morse sets and are issued without ground rods, line or local batteries.

1003. DESCRIPTIVE INFORMATION.

a. For convenience in presenting this information the tactical telegraph equipment has been divided into three categories namely, d-c wire equipment, carrier equipment, and teletypewriter equipment.

b. The d-c telegraph repeaters were designed especially for operation on long field wire circuits. They are, however, equally adaptable to composited open wire and cable lines. The terminal repeaters are suitable for interoperation with British terminal equipment.

c. Descriptions of the various items of equipment are given in paragraphs 1006, 1007 and 1008 and the component parts of sets are given in paragraph 1009.

1004. STOCK NUMBERS AND LOGISTICAL DATA.

Paragraphs 1010 and 1011 give stock numbers, weights and volumes of the various telegraph and teletypewriter equipments and sets.

1005. ILLUSTRATIONS. Paragraphs 1012 to 1015 inclusive give illustrations of the use of tactical telegraph equipment on point to point circuits employing neutral, polarential and two path polar methods of line transmission. Paragraphs 1016 and 1017 illustrate the use of these equipments in teletypewriter switching networks and paragraphs 1018 and 1019 illustrate their use with d-c loops to carrier telegraph terminals.

1006. D-C WIRE TELEGRAPH EQUIPMENT - TACTICAL - DESCRIPTION.

Nomenclature Name	Type No.	Fig. No.	Carrying Case or Chest. Weight and Dimensions	Approx. Power Consumption Watts	Approx. Power Input Req. b	Approx. Size in Chest L x W x H	Remarks
Switchboard	BD-100	1004	225 lbs. incl. chest CH-70 for running spares, tools and accessories. Smbd. transported in iron frame-work which forms a stand when in service. Chest CH-70 is 21-1/2" x 12-1/2" x 7" and 40 lbs. packed. Smbd. in field use is 18" x 16" x 26" and 180 lbs.	150 W. at 115 V d-c	150 W. at 115 V d-c	16x 16x 52	Ten-line telegraph switchboard for interconnecting teletypewriter station lines and trunk circuits. Line transmission is neutral. Connections established by patching cords. Conference connections may be established. Operator uses Teletypewriter TB-7-(). Contains bias measuring circuit for use in adjusting the mechanically "biased" neutral line relays. Three boards (lines not multiplied) may be operated as a single installation and by improvised field arrangements more than three have been operated together. D-c power for lines, trunks and local circuits obtained from Rectifier RA-45-A. Part of Telegraph Central Office Set TC-3.
Line Unit	BE-77	-	25 lbs. in Chest CH-53 with accessories, running spares and tltpr. supplies. Chest CH-53 is 11-1/2" x 19" x 10-1/2".	.060 amp. at 115 V. d-c 7 W. (tltpr. magnet)	.060 amp. at 115 V. d-c 7 W. (tltpr. magnet)	6x6x6	To connect neutral circuit to a teletypewriter. Includes line relay, line current rheostat and meter. Line relay is adjusted mechanically to compensate for bias of incoming line signals. Bias Meter I-97-A used in making adjustment. Part of Teletypewriter Sets BE-97 and BE-98.
Line Unit	BE-77-A or BE-77-B	1001	28 lbs. in Chest CH-53-A with accessories, running spares and tltpr. supplies. Chest CH-53-A is 11-1/2" x 19" x 10-1/2".	.060 amp. at 115 V. d-c 7 W. (tltpr. magnet)	.060 amp. at 115 V. d-c 7 W. (tltpr. magnet)	6x6x6	Same as Line Unit BE-77 except that the bias measuring feature is included in the unit and separate bias meter is not required. Part of Teletypewriter Sets BE-97-A, BE-98-A, BE-102 and Reperator Teletypewriter Sets TC-16 and TC-17. Line Unit BE-77-B same as BE-77-A except for a minor apparatus difference.
Repeater (Terminal)	TU-30	1002	130 lbs. in carrying case. Cover opened for service and repeater not removed from case. Case is 25" x 19" x 14-1/2". Running spares supplied in case.	100 V.A. at 115 V. or 250 V. 50/60 cyc. a-c. 50 W. at 115 V. d-c. D-c power source must be non-grounded.	100 V.A. at 115 V. or 250 V. 50/60 cyc. a-c. 50 W. at 115 V. d-c. D-c power source must be non-grounded.	25x 15x 16	D-c telegraph terminal-type repeater used for making connections from two-path polar or polarmental line circuits to neutral type local circuits such as used in teletypewriters, Switchboard BD-100, Line Unit BE-77-A and to Telegraph Terminal CF-2-() when long polarmental circuits are employed. Contains built-in rectifier for operation on 115 or 250 volts a-c and also contains a built-in manual telegraph set. Is supplied with a 115 volt power receptacle for supplying teletypewriter motor. Test Set I-195-A is used for testing and adjusting the polar relays. Part of Repeater Set TC-18 (Terminal).
Repeater (Intermediate)	TU-51	1003	180 lbs. in carrying case. Cover opened for service and repeater not removed from case. Case dimensions 25" x 19" x 14-1/2". Running spares supplied in case.	95 V.A. at 115 V. or 250 V. 50/60 cyc. a-c. 25 W. on 115 V. d-c. 5 new Bat. RM-26 (115 V.) will last about 4 days at normal temp. On 12 V. stor. bat. (one BB-46 or two BB-55) drain is 2 amp.	95 V.A. at 115 V. or 250 V. 50/60 cyc. a-c. 25 W. on 115 V. d-c. 5 new Bat. RM-26 (115 V.) will last about 4 days at normal temp. On 12 V. stor. bat. (one BB-46 or two BB-55) drain is 2 amp.	25x 15x 16	D-c telegraph intermediate-type repeater for retransmitting signals from one polarmental line section to another polarmental line section (differential sending only.) Does not retune or reform signals. Will operate unattended on dry cell or storage battery supply when a teletypewriter is not required. Provides operation with a local teletypewriter when power supply is 115 or 250 volts a-c or 115 volts d-c gas engine power unit. Has built-in rectifier for a-c operation and also contains a built-in manual telegraph set. Test Set I-195-A used for testing and adjusting the polar relays. Part of Repeater Set TC-19 (Intermediate).

Manufacturer Name	Fig. No.	Carrying Case or Chest, Weight and Dimensions	Approx. Size in Oper. (In.) ^a	Approx. Power Limit Req. b	Tech. Man.	Remarks
Telegraph Set TU-5-A	-	7 lbs. with batteries and in Case CS-49-A which is 8"x6"x10" with adjustable shoulder strap.	8x7x5	1 Bat. BA-2 2 Bat. BA-50	TM 11-551	Manual telegraph set consisting of telegraph key, line relay, oscillator (howler) and telephone headset. Is equipped with a "call" bell. When headset is connected, the oscillator provides a tone in the telephone receiver of about 1000 cycles which is under control of line relay. Line relay operates on about 1.5 milliamperes and has air-gap and spring-tension adjustment. Ground rods and batteries are not furnished with set.
Telegraph Set TU-5-B	1005	9-3/4 lbs. with bat. and in Case CS-49-A which is 8"x6"x10" with adjustable shoulder strap.	8x7x5	1 Bat. BA-2	TM 11-551	Same as Telegraph Set TU-5-A except box is steel instead of aluminum and line relay is more sensitive (0.2 milliamperes minimum operating current). Line relay has spring tension adjustment only.

^a The first two dimensions represent minimum floor space requirements. When equipment with front and rear covers is set up for service, it should be placed three or four feet from a wall to permit removing the rear cover for maintenance.

^b Gasoline engine power units and rectifiers used with tactical equipment will be found in Chapter 12.

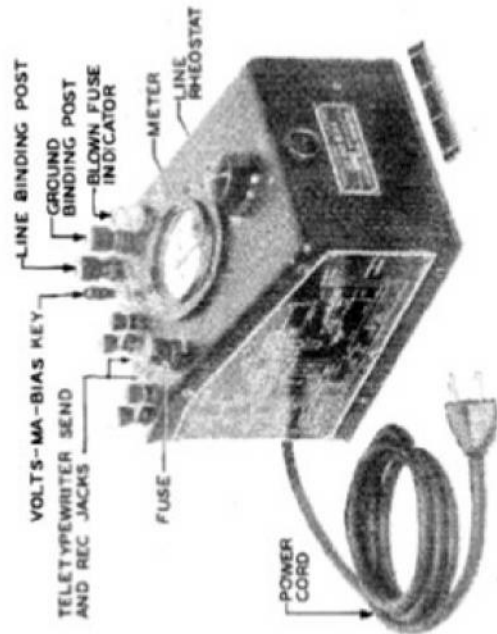

FIGURE 1001. Line Unit BE-77-A or BE-77-B

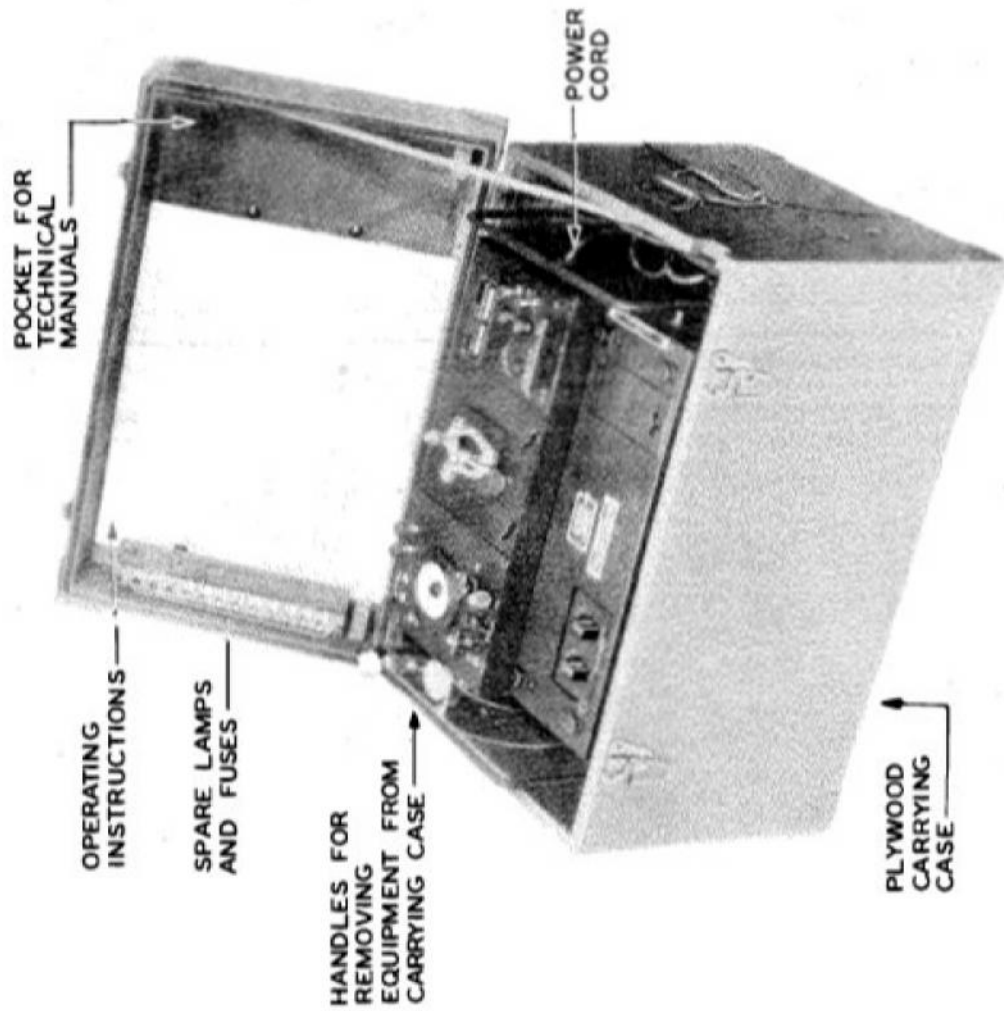

FIGURE 1003. Repeater TG-31 (Intermediate)

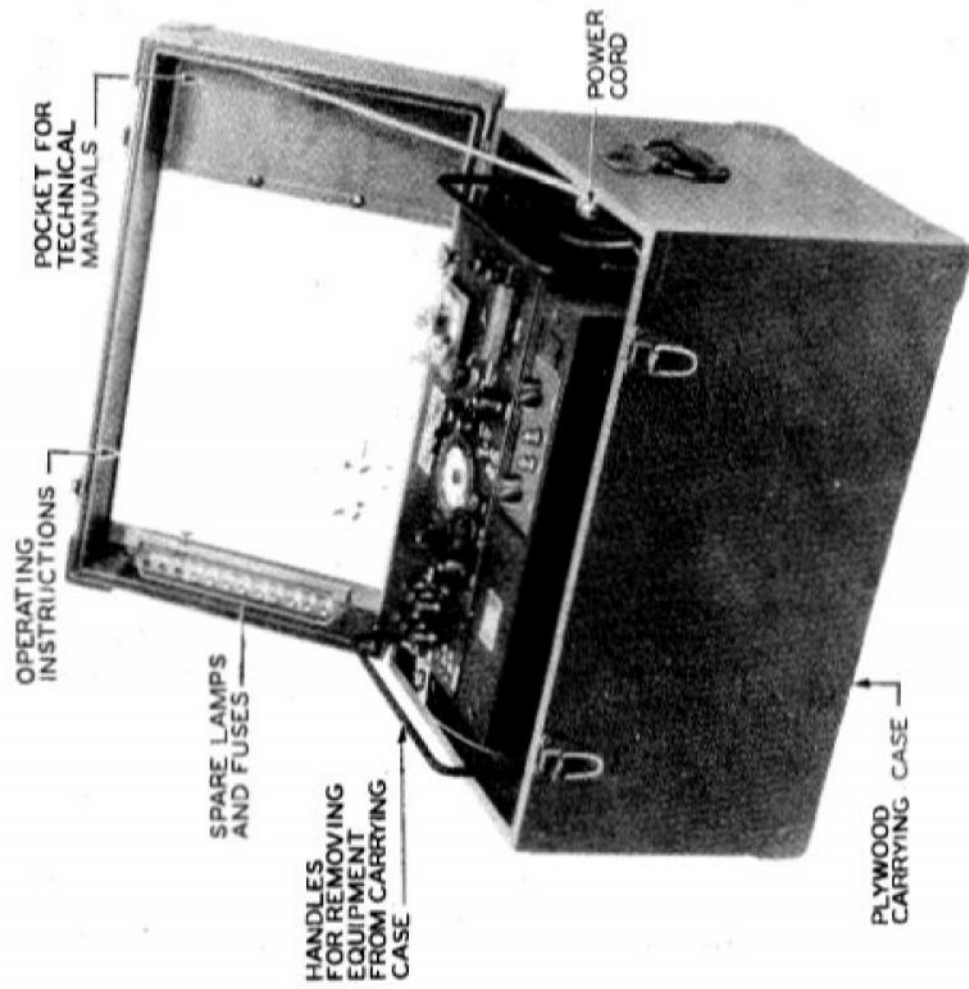

FIGURE 1002. Repeater TG-30 (Terminal)

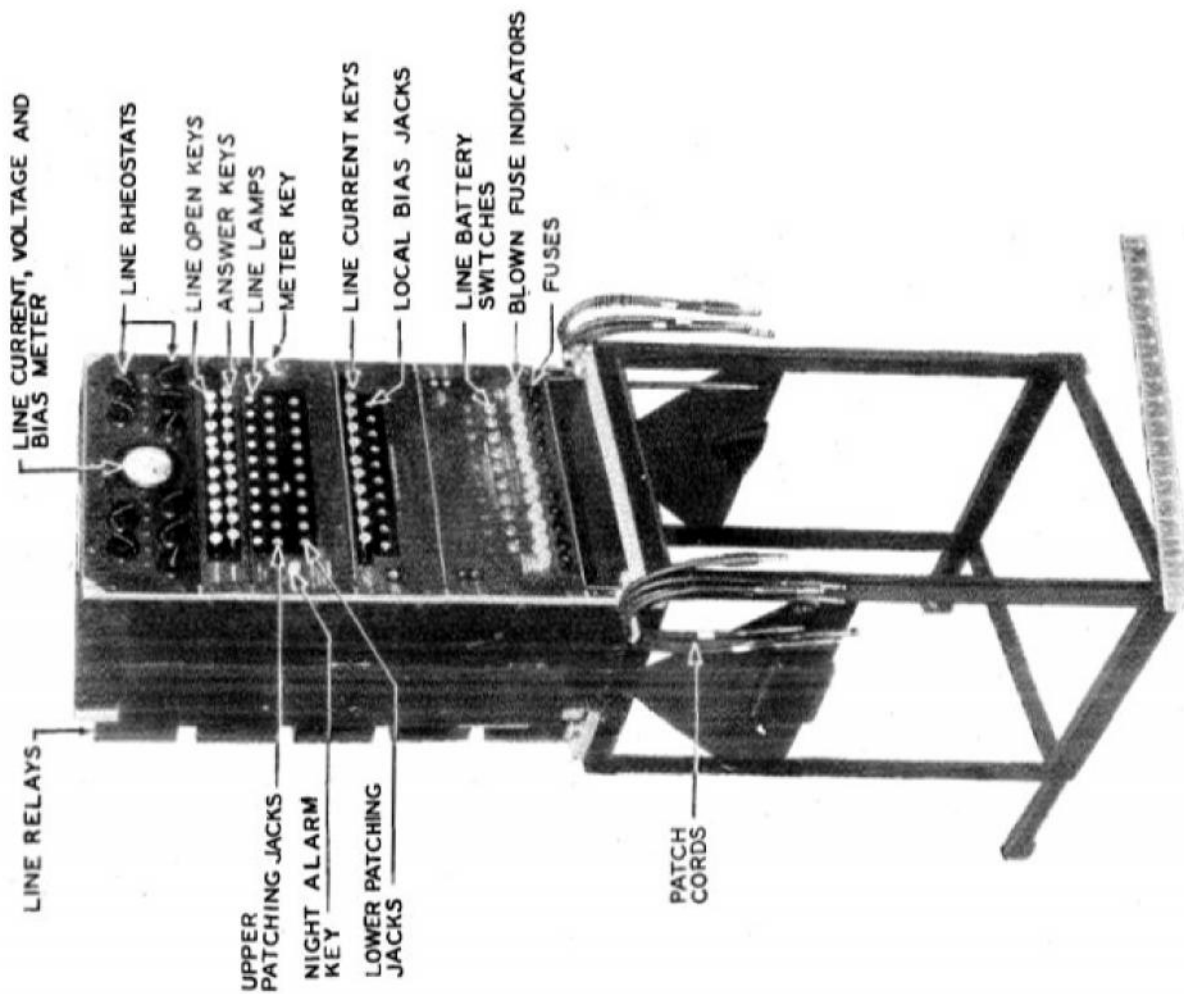

FIGURE 1004. Switchboard BD-100

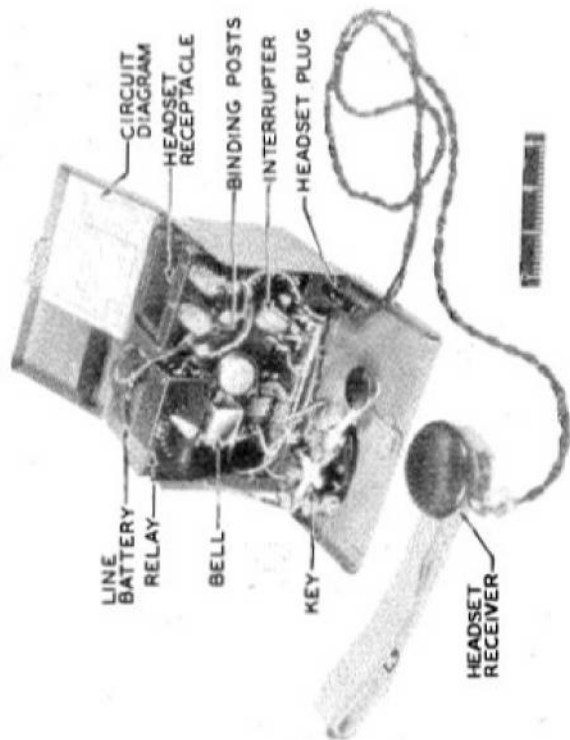

FIGURE 1005. Telegraph Set TG-5-B

1007. CARRIER TELEGRAPH EQUIPMENT - TACTICAL - DESCRIPTION.

Designation	Nomenclature	Shown in Figure No.	Carrying Case or Chest, Weight and Dimensions	Dimensions in Operation (inches) ^a	Approximate Power Input Requirements ^b	Technical Manual Instruction Book Instruction Manual	Remarks
Telegraph Terminal	CF-2-A	1006	530 lbs. per bay. (Bay 1) in case 5'6" x 27-1/2" x 19". Bay 2 has same dimensions and weight as Bay 1. Furnished with front and rear covers. Front cover removed for service. Each bay supplied with running spares and polar relay adjusting tools.	27-1/2x19x56 (Bay 1) Bay 2 is the same size.	250 V.A. at 115/250 volts 50/60 cycles (Bay 1). Same for Bay 2.	TM 11-355	Voice frequency carrier telegraph terminal providing four 2-way telegraph circuits. Two bays (2 circuits per bay) required for four circuits. Each bay contains rectifiers to supply d-c for operation of the d-c loop circuits and local circuits in the bay. Each bay contains a relay test circuit. Frequency range is 500 to 2050 cycles. The d-c loops provide for neutral (half & full duplex) and polar terminal and polar circuits. For operation with Telephone Terminal Set TC-21-(). Part of Telegraph Terminal Set TC-22-().
Telegraph Terminal	CF-2-B	1007	575 lbs. in case 5'6" x 27-1/2" x 19". Furnished with front and rear covers. Front cover is removed for service. Case is supplied with running spares and polar relay adjusting tools.	27-1/2x19x56	325 V.A. at 115/250 volts 50/60 cycles	TM 11-355-B	Voice frequency carrier telegraph terminal with four circuits in one bay and essentially the electrical equivalent of Telegraph Terminal CF-2-A. Part of Telegraph Terminal TC-22-().
Telegraph Terminal	CF-6-()	1008	400 lbs. in case 4'2" x 24" x 17". Supplied with front and rear covers. Front cover is removed for service. Case is supplied with running spares and polar relay adjusting tools.	24x17x50	175 V.A. at 115/250 volts 50/60 cycles	I-66616	Voice frequency carrier telegraph terminal containing two circuits for use primarily in combination with Telegraph Terminals CF-2-A or CF-2-B to provide Channels 5 and 6. The d-c loop circuits are like those in Telegraph Terminal CF-2-B. When used with CF-2-A or CF-2-B equipment, frequency range is 340 to 2400 cycles. Case is supplied with rectifiers and relay test circuit.
Telegraph Terminal	TH-1/TC-1	-	-	-	-	-	Known as S+DL. See paragraph 1025.

^a The first two dimensions represent minimum floor space requirements. Additional space will be required. When equipment with front and rear covers is set up for service, it should be placed three or four feet from a wall to permit removing the rear cover for maintenance.

^b A-c power for operating rectifiers obtained from power unit supplied with Telephone Terminal Set TC-21-().

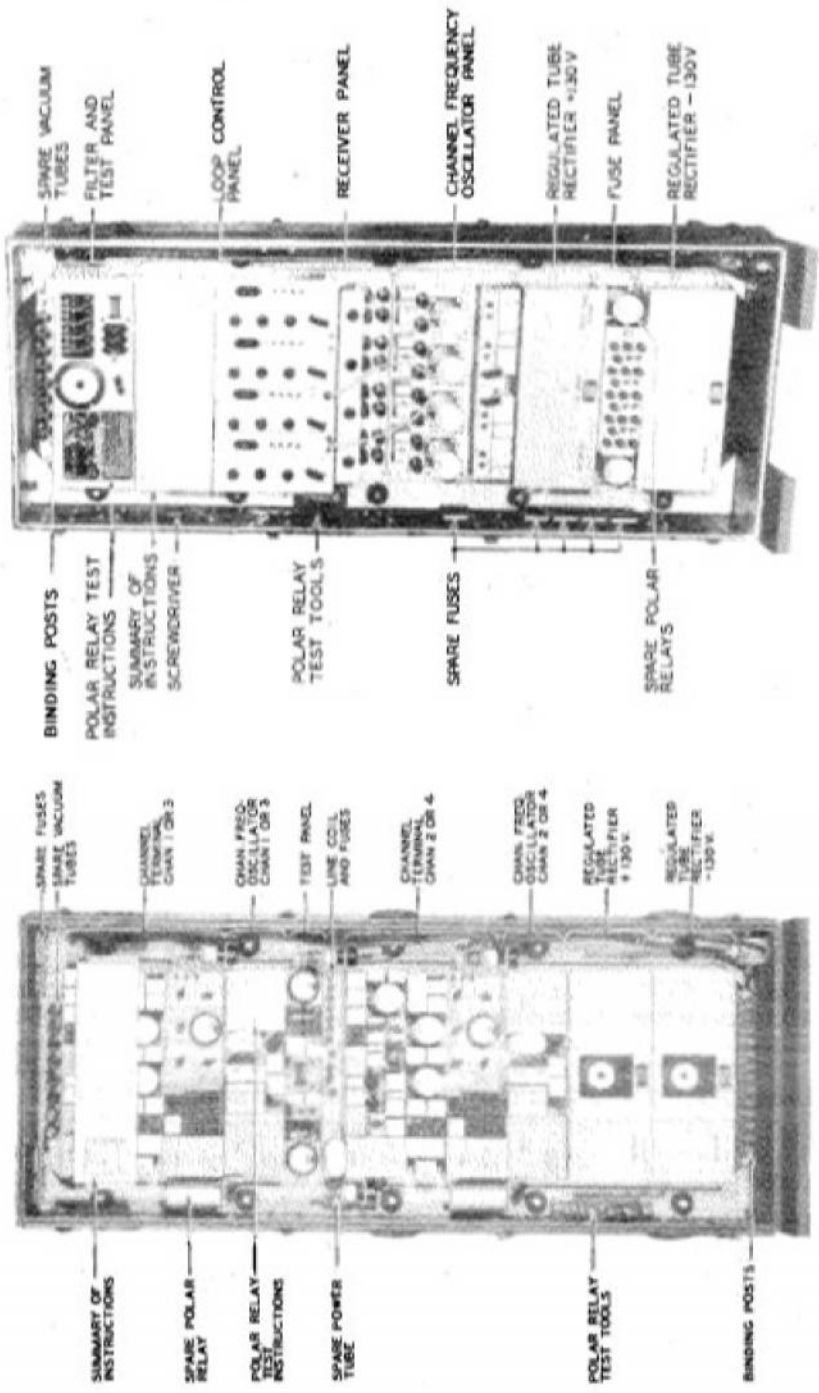

FIGURE 1006. Telegraph Terminal CF-2-A (One bay)

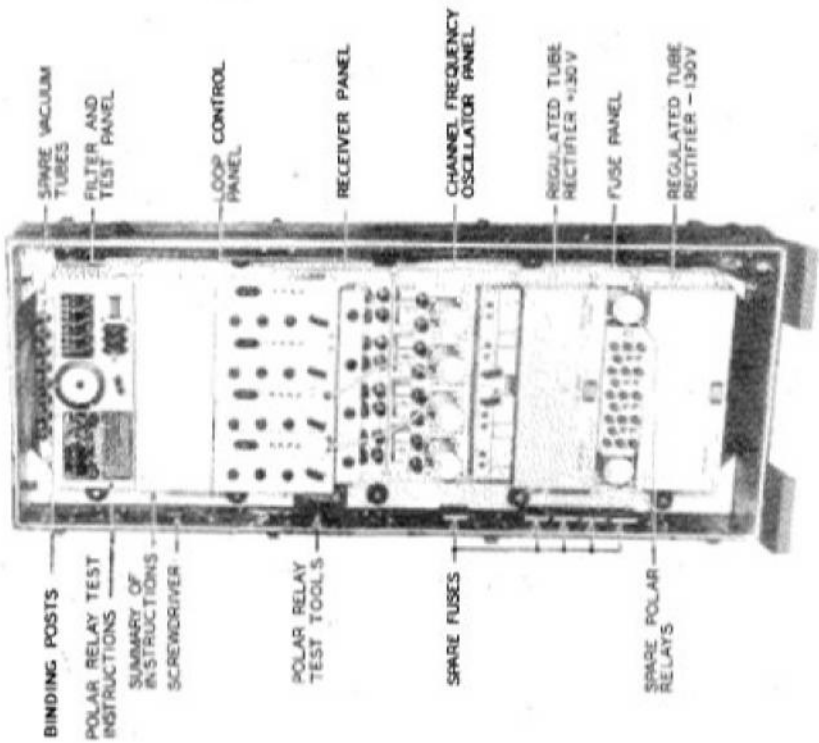

FIGURE 1007. Telegraph Terminal CF-2-B

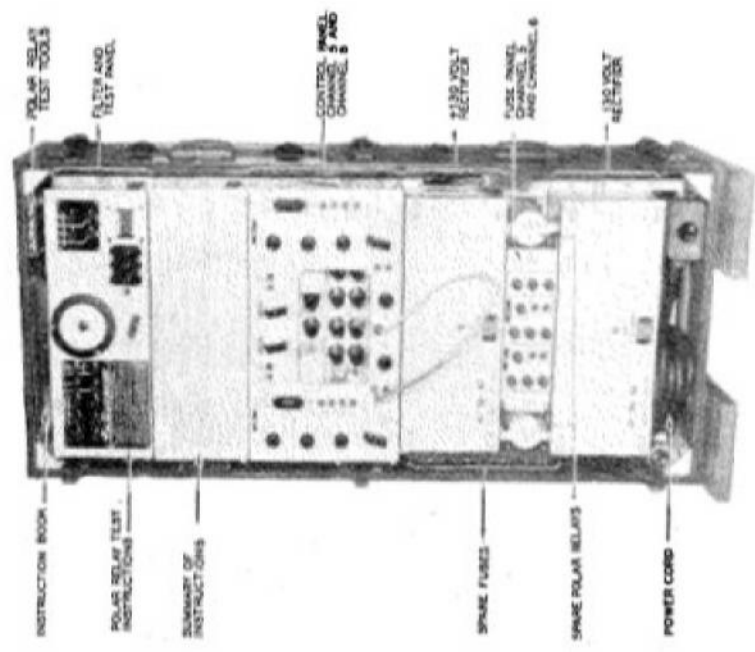

FIGURE 1008. Telegraph Terminal CF-6-A

1008. TELETYPEWRITER EQUIPMENT - TACTICAL - DESCRIPTION

Nomenclature Name	Type No.	Carrying Case or Chest, Weight and Dimensions	Approx. Size in Open (In.) ^a	Approx. Power Instr. Req. ^b	Tech. Man. Instr. Book Instr. Man. d	Remarks
Teletypewriter TU-7-A or TU-7-B		225 lbs. in Chest CI-50-A (20" x 25" x 18-5/8") and Chest CI-62-A (18-5/8" x 18-5/8" x 16-1/4"). Base of machine carried in Chest CI-50-A (weight 138 lbs.) and typing unit in Chest CI-62-A (87 lbs.)	20x 19x 42	140 V.A. on 115 V. 50/60 cye. or 110 W. on 115 V. d-c (motor power only)	TM 11-552 and Instr. Man. No. 11	Page-receiving and keyboard-sending teletypewriter. "Standard" communication keyboard and type-bar arrangement. Pulling magnet selector and no line relay. Series a-c governed motor operating on 25, 40 (TU-7-B only) 50 and 60 cycles 115 volts a-c and 115 volts d-c. Motor controlled by switch or automatic built-in control. Supplied with motor power cord, a sending cord and a receiving cord. Motor speed adjusted for 368 or 404 o.p.m. by use of proper tuning fork. Teletypewriter TU-7-B is the same as Teletypewriter TU-7-A except that certain minor features not required in tactical service have been omitted. Part of the Teletypewriter Sets EE-97, EE-97-A, EE-98, EE-98-A and Telegraph Central Office Set TC-3.
Teletypewriter TU-37-B		225 lbs. in Chest CI-50-B or F (20" x 25" x 18-5/8") and Chest CI-62-B or F (18-5/8" x 18-5/8" x 16-1/4"). Base of machine carried in Chest CI-50-B or F (138 lbs.) and typing unit in Chest CI-62-B or F (87 lbs.)	20x 19x 42	140 V.A. on 115 V. 50/60 cye. or 110 W. on 115 V. a-c (motor power only)	TM 11-552 and Instr. Man. No. 11	Same as Teletypewriter TU-7-B except equipped with keyboard and type-bar symbols for communication and for sending and receiving "weather" information. Part of Teletypewriter Set EE-102.
Reperforator Transmitter Shown in Fig. 1010	TU-26-()	225 lbs. in carrying case (33" x 25" x 19"). Cover removed for service and used as a table.	35x 19x 38	225 V.A. on 115 V. 50/60 cye. a-c 190 W. on 115 V. d-c (motor power for typing reperforator and trans. distrib. only)	TM 11-557 and TM 11-2201	Perforates and types message on the tape from keyboard locally or from line signals and sends signals from tape thru transmitter. Typing reperforator with keyboard and transmitter distributor mounted on a common wood base which is also the base of the carrying case. Reperforator equipped with "standard" communication keyboard and type-bar symbols. A jack box mounted on the base provides a means of making connections to 60 milliamperes neutral circuits. Reperforator supplied with pulling magnet and no line relay. Motors are series a-c governed type adjustable for 368 or 404 o.p.m. Motor switch control. Part of Reperforator Teletypewriter Set TC-16.
Reperforator Transmitter Shown in Fig. 1010	TU-27-()	225 lbs. in carrying case (33" x 25" x 19"). Cover removed for service and used as a table.	35x 19x 38	225 V.A. on 115 V. 50/60 cye. a-c 190 W. on 115 V. d-c (motor power only)	TM 11-557 and TM 11-2201	Same as Reperforator Transmitter TU-26-() except equipped with reperforator keyboard and type-bar symbols for communication and for sending and receiving weather information. Part of Reperforator Teletypewriter Set TC-17.
Perforator Set	TU-11	145 lbs.	18x 18x 39	135 V.A. on 115 V. 50/60 cye. a-c	TM 11-555 and Instr. Man. No. 9	For perforating tape locally only communications keyboard. Mounted on a metal table which also mounts rectifier to supply d-c for perforator solenoid. Table 4TPEK2. Rectifier 4TREC11.
Perforator Transmitter Set	TU-23	160 lbs.	24x 18x 39	225 V.A. on 115 V. 50/60 cye. a-c	TM 11-555 and Instr. Man. No. 8	Perforates tape locally only and tape is run thru transmitter which sends message. Uses same perforator as Perforator Set TU-11. Both units are mounted on a metal table which also mounts rectifier for operating solenoid of perforator. Series a-c governed motor used in transmitter-distributor. This equipment is commercial, "substitute standard". Stop gap for TU-26-(). Table 4TTR-40. Rectifier 4TREC11.
Reperforator Transmitter Set	TU-25	195 lbs.	24x 18x 41	215 V.A. on 115 V. 50/60 cye. a-c	TM 11-555 and Instr. Man. No. 12	Perforates tape (without typing) from incoming line signals only. Tape is run thru transmitter which sends message. Equipments mounted on a metal table which also mounts rectifier to provide d-c for local circuits. Both units equipped with series a-c governed motors with switch control. This equipment is commercial, "substitute standard". Stop gap for TU-26-(). Table 4TTR-98. Rectifier 4TREC12.

^a The first two dimensions represent minimum floor space requirements. Additional space will be required. When equipment with front and rear covers is set up for service, it should be placed three or four feet from a wall to permit removing the rear cover for maintenance.

^b Gasoline engine power units and rectifiers used with tactical equipment will be found in Chapter 12.

^c Chests are for Teletypewriter TU-7-A. Equivalent Chests for Teletypewriter TU-7-B are Chests CI-50-B or F and CI-62-B or F.

^d Teletype Corporation.

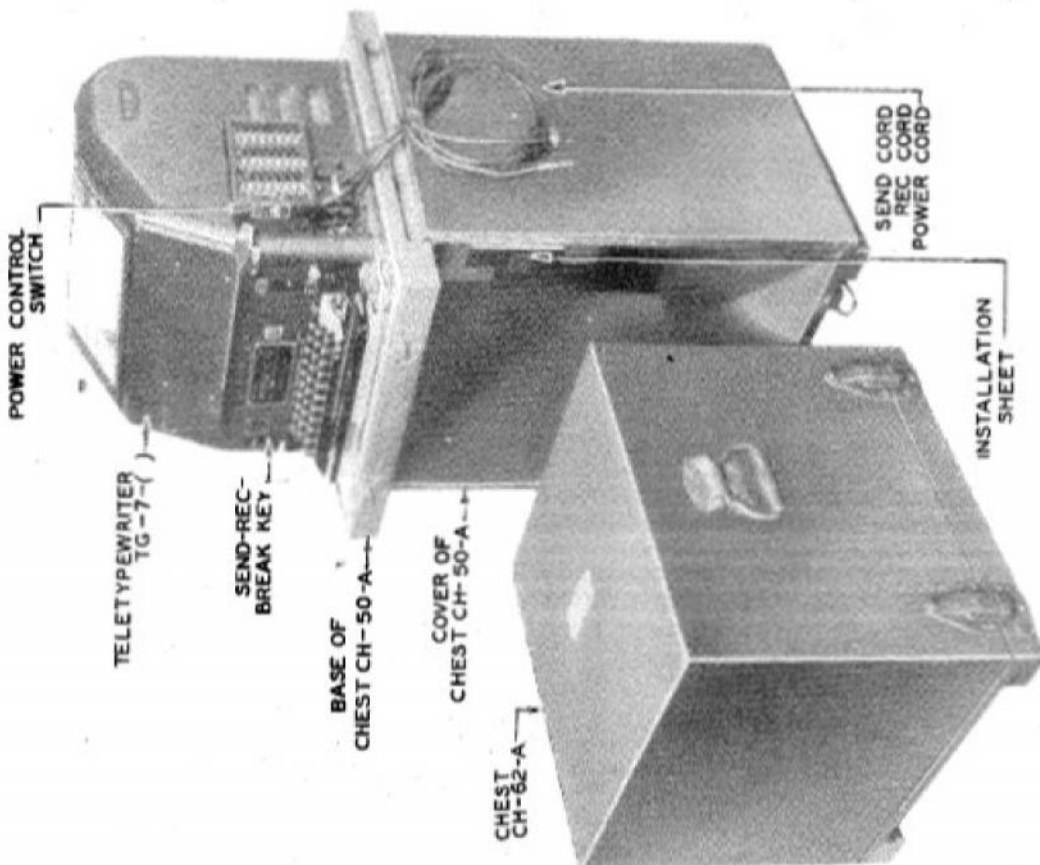

FIGURE 1009. Teletypewriter TG-7-A

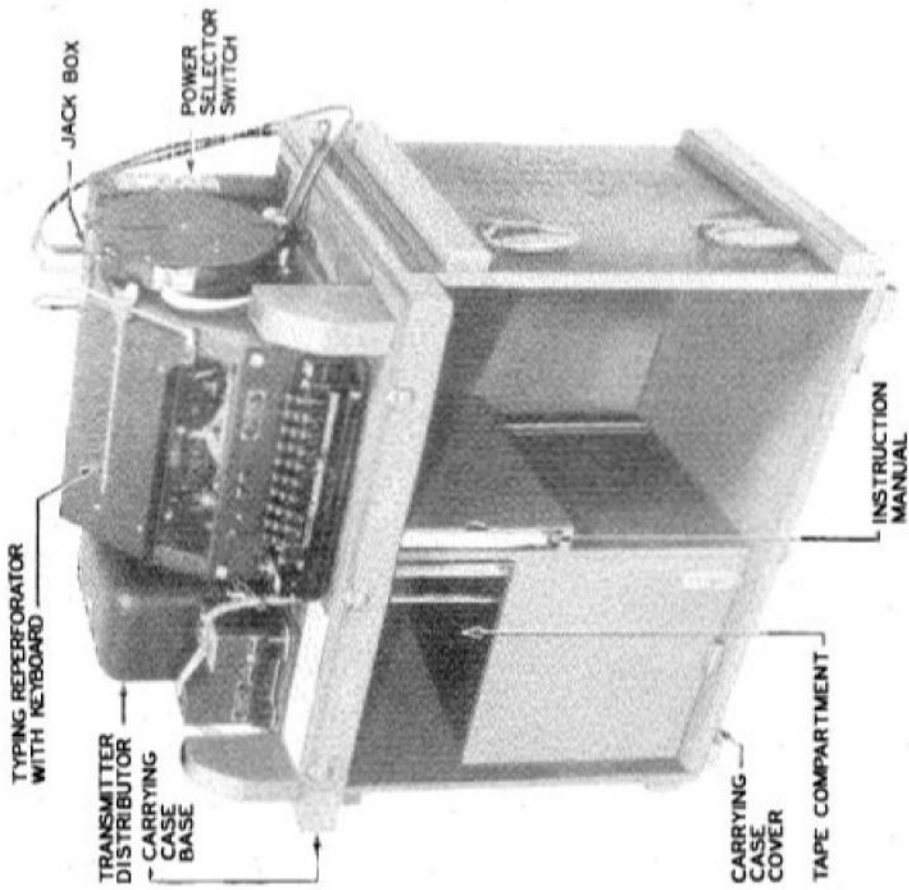

FIGURE 1010. Reperforator Transmitter TG-26-A

Nomenclature		Quantity	Major Components	Dimensions (inches) ^a	Weight in Operation (pounds) ^b
Name	Type No.				
Telegraph Central Office Set	TC-3	1	Switchboard BD-100 (no chest required) Chest CH-70 (tools and running spares only) Teletypewriter TC-7-A ^c (in two chests)	16 x 16 x 26 21-1/2 x 12-1/2 x 7	180 45
Shown in Fig. 1011		1	Chest CH-50-A Chest CH-62-A Chest CH-53 (running spares and supplies) Rectifier RA-43-B Case CS-62-A Power Unit PG-75-D (on skids) Ground Rod GP-29d	20 x 25 x 19 18-1/2 x 20-1/2 x 16-1/2 11-1/2 x 19 x 10-1/2	138 87 34
		1		30 x 16 x 19	190
		1		36 x 19 x 26	325
		2		1-1/4 diam. x 36 long	16
				Total 31 cu. ft.	1015
Repeater Teletypewriter Set	TC-16	1	Repeater Transmitter TC-26-() (complete in chest) Rectifier RA-67 Chest CH-158 Line Unit BE-77-A Chest CH-53-A (with running spares and supplies) Ground Rod GP-29d	25 x 33 x 19	225
		1		12-1/2 x 18-1/2 x 10-1/2	59
		1		11-1/2 x 19 x 10-1/2	31
		2		1-1/4 diam. x 36 long	16
				Total 12 cu. ft.	331
Repeater Teletypewriter Set	TC-17	1	Same as Repeater Teletypewriter Set TC-16 except that Repeater Transmitter TC-27-() ^e is substituted for Repeater Transmitter TC-26-()	Total 12 cu. ft.	331
Repeater Set (Terminal)	TC-18	1	Repeater TC-30 (Complete in carrying case) Ground Rod GP-29d	25 x 14-1/2 x 16 1-1/4 diam. x 36 long	130 16
		2		Total 3-1/2 cu. ft.	146
Repeater Set (Intermediate)	TC-19	1	Repeater TC-31 (Complete in carrying case) Ground Rod GP-29d	25 x 14-1/2 x 16 1-1/4 diam. x 36 long	120 16
		2		Total 3-1/2 cu. ft.	136

^a The first two figures are minimum floor dimensions. When arranging a set for service provide adequate space (3 or 4 feet front and rear) for operation and maintenance.

^b Total "weight-in-operation" includes carrying case or chests, running spares, accessories and equipment unit supplied therein.

^c Teletypewriter TC-7-B in Chest CH-50-B or F and Chest CH-62-B or F may be issued in place of Teletypewriter TC-7-A.

^d Ground Rod MK-148/G, 6 ft. long, 3/4 in. diam., weight 10 pounds may be substituted.

^e Repeater Transmitter TC-26-() except typing reperforator equipped with "weather" communications keyboard and type-bar symbols.

Nomenclature		Type No.	Quantity	Major Components	Dimensions (inches) ^a	Weight in Operation (pounds) ^b
Name						
Telegraph Terminal Set (Carrier)	TC-23-()	1	Telegraph Terminal CF-2-A	27-1/2 x 19 x 66 (Bay 1) 27-1/2 x 19 x 66 (Bay 2)	530 550	
		1	Telegraph Terminal CF-2-B or Ground Rod, Hubbard No. 9566 or equal Ground Rod Clamp, Reliable No. S-58 or equal Clamp TM-106 Maintenance Equipment ME-75 ^c Wire W-2 Wire W-69-A, 150 feet	27-1/2 x 19 x 66 1/2 diam., 72 long (3-1/2 cu. ft.)	575 10	
			Total	45 cu. ft. (CF-2-A) 25 cu. ft. (CF-2-B)	1127 642	
Teletypewriter Set	EE-97	1	Teletypewriter TG-7-A (in two chests) Chest CH-50-A Chest CH-62-A Rectifier RA-57 Chest CH-51 Line Unit EE-77 Chest CH-53 (with running spares, supplies and Bias Meter I-97-A in CS-49-A) Ground Rod GP-29d Power Unit PE-77- (A through E)	20 x 25 x 19 18-1/2 x 20-1/2 x 16-1/2 12-1/2 x 16-1/4 x 9-3/4 11-1/2 x 19 x 10-1/2 1-1/4 diam. x 36 long 17 x 21-1/2 x 22 Total 16-1/2 cu. ft.	158 87 40 32 16 127 440	
Teletypewriter Set	EE-97-A	1	Teletypewriter TG-7-B (in two chests) Chest CH-50-B or F Chest CH-62-B or F Rectifier RA-87 Chest CH-158 Line Unit EE-77-A Chest CH-53-A (with running spares and supplies) Ground Rod GP-29d Power Unit PE-77 (A through E)	20 x 25 x 19 18-1/2 x 20-1/2 x 16-1/2 12-1/2 x 18-1/2 x 10-1/2 11-1/2 x 19 x 10-1/2 1-1/4 diam. x 36 long 17 x 21-1/2 x 22 Total 16-3/4 cu. ft.	158 87 59 28 16 127 455	

^a The first two figures are minimum floor dimensions. When arranging a set for service provide adequate space (3 or 4 feet front and rear) for operation and maintenance.

^b Total "weight-in-operation" includes carrying case or chests, running spares, accessories and equipment unit supplied therein.

^c Spare parts in this list may be supplied through organizational maintenance.

^d Ground Rod MX-149/G, 6 ft. long, 3/4 in. diam., weight 10 pounds may be substituted.

Table continued on next page

TELETYPEWRITER SETS - TACTICAL - COMPONENT PARTS (Continued)

Weight in
Operation
(pounds)^b

Dimensions (inches)^a

Major Components

Nomenclature Name	Type No.	Quantity	Major Components	Dimensions (inches) ^a	Weight in Operation (pounds) ^b
Teletypewriter Set	EE-98		Same as Teletypewriter Set EE-97 except power unit is omitted	Total 12 cu. ft.	315
Teletypewriter Set	EE-98-A		Same as Teletypewriter Set EE-97-A except power unit is omitted	Total 12-1/4 cu. ft.	328
Teletypewriter Set	EE-102		Same as Teletypewriter Set EE-97-A except Teletypewriter TG-37-Bc is issued in place of TG-7-B and power unit is omitted	Total 12-1/4 cu. ft.	328

a The first two figures are minimum floor dimensions. When arranging a set for service provide adequate space (3 or 4 feet front and rear) for operation and maintenance.

b Total "weight-in-operation" includes carrying case or chests, running spares, accessories and equipment unit supplied therein.

c Teletypewriter TG-7-B except equipped with "weather" communications keyboard and type-bar symbols.

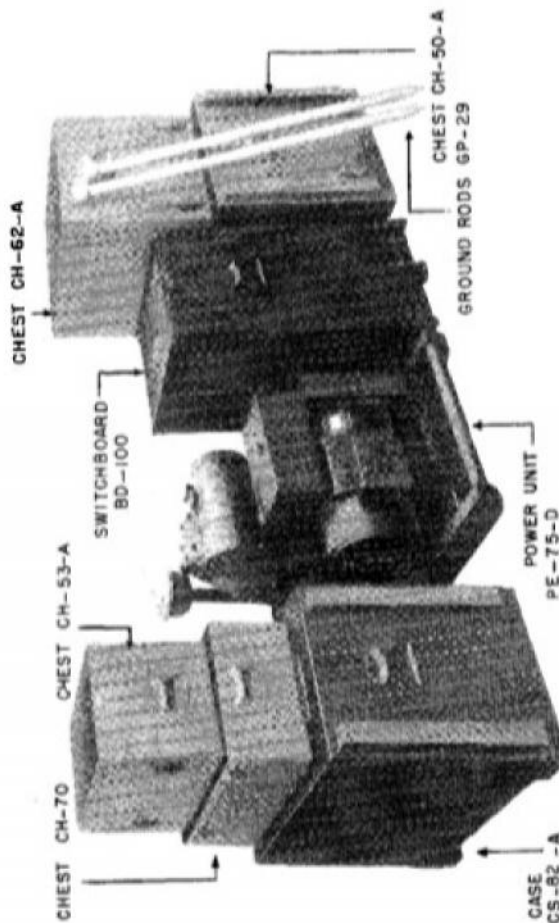

FIGURE 1011. Telegraph Central Office Set TC-3

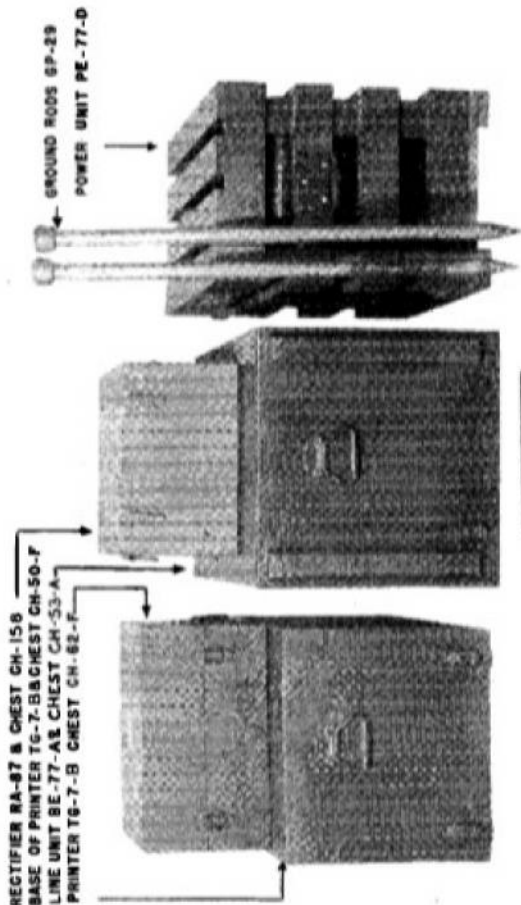

FIGURE 1012. Teletypewriter Set EE-97-A

1010. TELEGRAPH AND TELETYPEWRITER EQUIPMENT - TACTICAL - STOCK NUMBERS AND LOGISTICAL DATA.

Nomenclature Name	Type No.	Stock No.	Total Weight (pounds)		Total Displacement (cu.ft.)		Ship Tons ^a
			Packed for Export	In Chest or Carrying Case	Packed for Export	In Chest or Carrying Case	
Switchboard	BD-100	4A2560	375	225	10	5.0	0.3 ^b
Line Unit	BS-77	47L03554	40	25	2.9	1.35	0.1 ^c
Line Unit	BS-77-A	47L03554A	40	28	2.9	1.35	0.1 ^d
Repeater (Terminal)	TG-30	4A2830.1	170	130	6.5	3.4	0.2
Repeater (Intermediate)	TG-31	4A2131	160	120	6.5	3.4	0.2
Telegraph Set	TG-5-A	4A2805A	9-1/4	7 ^e	0.36	0.18	-
Telegraph Set	TG-5-B	4A2805B	11-1/4	8-3/4 ^e	0.36	0.18	-
Telegraph Terminal (Carrier)	CF-2-A	4A2892A	1460	1060	84	40	2.1
Telegraph Terminal (Carrier)	CF-2-B	4A2892B	760	575	42	20	1.1
Telegraph Terminal (Carrier)	CF-6-()	None assigned	520	400	27	12	0.7
Teletypewriter	TG-7-A	472.13A-1	400	225	27	8.7	0.7
Teletypewriter	TG-7-B	472.28A-1	400	225	27	8.7	0.7
Teletypewriter	TG-37-B	472.23A-1	400	225	27	8.7	0.7
Reperforator Transmitter	TG-26-()	47L2.1A-1	370	225	22	9.2	0.5
Reperforator Transmitter	TG-27-()	47L2.2A-1	370	225	22	9.2	0.5
Perforator Set	TG-11	478.3A-1	200	-	17	-	0.4
Perforator Transmitter Set	TG-23	476.6A-1	325	-	23	-	0.6
Reperforator Transmitter Set	TG-25	477.2-1	355	-	25	-	0.6
Ground Rod	GP-16	5B4416					
Ground Rod	GP-29	3Z3329					
Ground Rod	MX-14B/G	3Z3330-148					
Ground Rod	Hubbard	3Z3332					

^a A "ship ton" equals 40 cubic feet.

^b Includes Chest CH-70 with tools and running spare parts.

^c Includes Chest CH-53 with running spare parts and supplies.

^d Includes Chest CH-53-A with running spare parts and supplies. Line Unit BS-77-B also supplied in Chest CH-53-A and weight and displacement is the same as for Line Unit BS-77-A.

^e Includes one Battery BA-2 and two Batteries BA-30.

16" long, weight 2 pounds. Used with Telegraph Sets TG-5-A and TG-5-B
 3' long, 1-1/4" diam., weight 8 pounds
 6' long, 3/4" diam., weight 10 pounds
 6' long, 1/2" diam., weight 5 pounds

1011. TELEGRAPH AND TELETYPEWRITER SETS - TACTICAL - STOCK NUMBERS AND LOGISTICAL DATA.

Name	Nomenclature	Type No.	Stock No.	Additional Equipment Required ^a	Weight (pounds) of Heaviest Package in Set		Total Weight (pounds) of Set		Total Displacement (cu.ft.) of Set Packed for Export or Chests	Ship Tons ^b	
					Packed for Export or Chests	In Cases or Chests	Packed for Export or Chests	In Cases or Chests			
Telegraph Central Office Set	TC-3	4A2788			400	215	1365	1015	62	31	1.6
Reperforator Teletypewriter Set	TC-16	4TT016		Teletypewriter TC-7-B ^c when page copies are required. Power Unit PE-77- (A through E) ^d	370	225	587	331	33	15	0.8
Reperforator Teletypewriter Set	TC-17	4TT017		Teletypewriter TC-37-B (weather keyboard) when page copies are required. Power Unit PE-77- (A through E) ^d	370	225	587	331	33	15	0.8
Repeater Set (Terminal)	TC-18	4A2118		Teletypewriter TC-7-B ^c or TC-37-B (weather keyboard). Power Unit PE-77- (A through E) ^d	170	130	195	146	6.5	3.4	0.2
Repeater Set (Intermediate)	TC-19	4A2119		Teletypewriter TC-7-B ^c or TC-37-B (weather keyboard). Power Unit PE-77- (A through E) ^d Battery BA-26 or two Battery BB-55 or one Battery BB-46 ^e	160	120	185	136	6.5	3.4	0.2

^a Weights and displacements do not include additional equipment required.

^b A "ship-ton" is equal to 40 cu. ft.

^c Teletypewriter TC-7-A may be issued in place of Teletypewriter TC-7-B.

^d When suitable a-c or d-c power source not available.

^e Batteries may be used for unattended service (no teletypewriter).

Nomenclature Name	Type No.	Stock No.	Additional Equipment Required ^d	Weight (pounds) of Heaviest Package in Set		Total Weight (pounds) of Set		Total Displacement (cu.ft.) of Set		
				Packed for Export	In Cases or Chests	Packed for Export	In Cases or Chests	Packed for Export	In Cases or Chests	Ship Tons ^b
Telegraph Terminal Set (Carrier)	TC-22-()	4A2822A ^c	Power Supply ^d	750	530	1540	1130	85	45	2.2
Telegraph Terminal Set (Carrier)	TC-22-()	4A2822B ^c	Power Supply ^d	760	560	840	640	45	25	1.1
Teletypewriter Set	EE-97	4TEE97		400	225	685	440	38	16-1/2	1
Teletypewriter Set	EE-97-A	4TEE97A		400	225	700	455	38	16-3/4	1
Teletypewriter Set	EE-98	4TEE98	Power Unit PE-77-() ^e	400	226	547	313	32	12	0.8
Teletypewriter Set	EE-98-A	4TEE98A	Power Unit PE-77-() ^e	400	225	562	328	32	12-1/4	0.8
Teletypewriter Set	EE-102	4TEE102	Power Unit PE-77-() ^e	400	225	562	328	32	12-1/4	0.8

^a Weights and displacements do not include additional equipment required.

^b A "ship-ton" is equal to 40 cu. ft.

^c Suffix letters A and B indicate Telegraph Terminals CF-2-A and CF-2-B respectively.

^d Suitable 115/230 volt 50/60 cycle power supply.

^e When suitable a-c or d-c power source not available.

1012. POINT-TO-POINT TELETYPEWRITER CIRCUIT (NEUTRAL LINE TRANSMISSION) - TACTICAL EQUIPMENT. Paragraph 1013 illustrates a typical teletypewriter circuit between Station A and Station B using the neutral method of line transmission. Since a neutral line is employed a line unit is interposed between the line and the teletypewriter. Both stations are shown using Teletypewriter Set EE-97-A which is complete with line unit, teletypewriter, rectifier, gas engine power unit, ground rods, running spare parts and sufficient supplies for the teletypewriter for initial service.

Power for operating the equipment may be obtained either from the power unit or from the rectifier and a suitable a-c supply. From a transmission standpoint, Teletypewriter Sets EE-97, EE-98, EE-98-A, or EE-102 (weather) might be substituted. The EE-98, EE-98-A and EE-102 are not issued with a power unit, and Power Unit PE-77-(A thru E) must be ordered unless a source of power is available. The component parts of these teletypewriter sets will be found in paragraph 1009. The line circuit may be simplex for simultaneous telephone and telegraph service.

1013. DIAGRAM OF A POINT TO POINT TACTICAL TELETYPEWRITER CIRCUIT (NEUTRAL LINE TRANSMISSION).

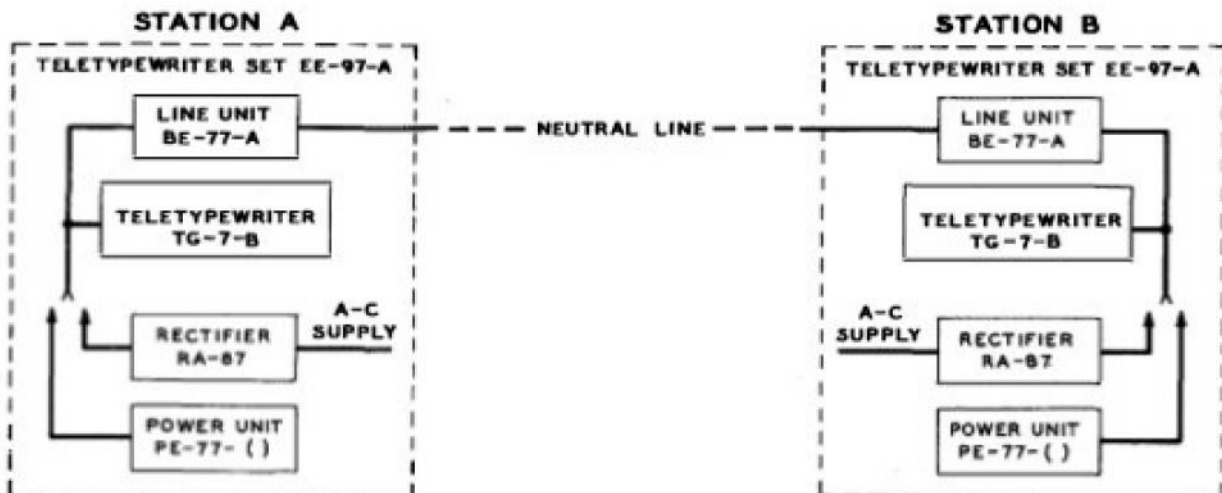

1014. POINT-TO-POINT TELETYPEWRITER CIRCUIT (POLARENTIAL AND 2 PATH POLAR LINE TRANSMISSION) - TACTICAL EQUIPMENT. Paragraph 1015 illustrates a typical teletypewriter circuit using the polar-entential or two-path polar methods of line transmission between two terminals, Station A and Station C with an intermediate Station B (polar-entential only). A repeater is required to connect a polar-entential or two-path polar line to a teletypewriter. Both terminal points are shown using Repeater Set TC-18 with which the teletypewriter must be

ordered separately. An a-c supply of power for operating the repeaters and teletypewriter may be used directly as Repeater TG-30 and Repeater TG-31 include a rectifier. Power Unit PE-77- () which must be ordered separately may be used when a-c is not available. The intermediate point, Station B is shown using Repeater Set TC-19 with optional power supply obtained from a source of a-c, a power unit or batteries. The line facilities may be simplex for simultaneous telephone and telegraph service.

1017. DIAGRAM OF A TELETYPEWRITER SWITCHING NETWORK - TACTICAL EQUIPMENT.

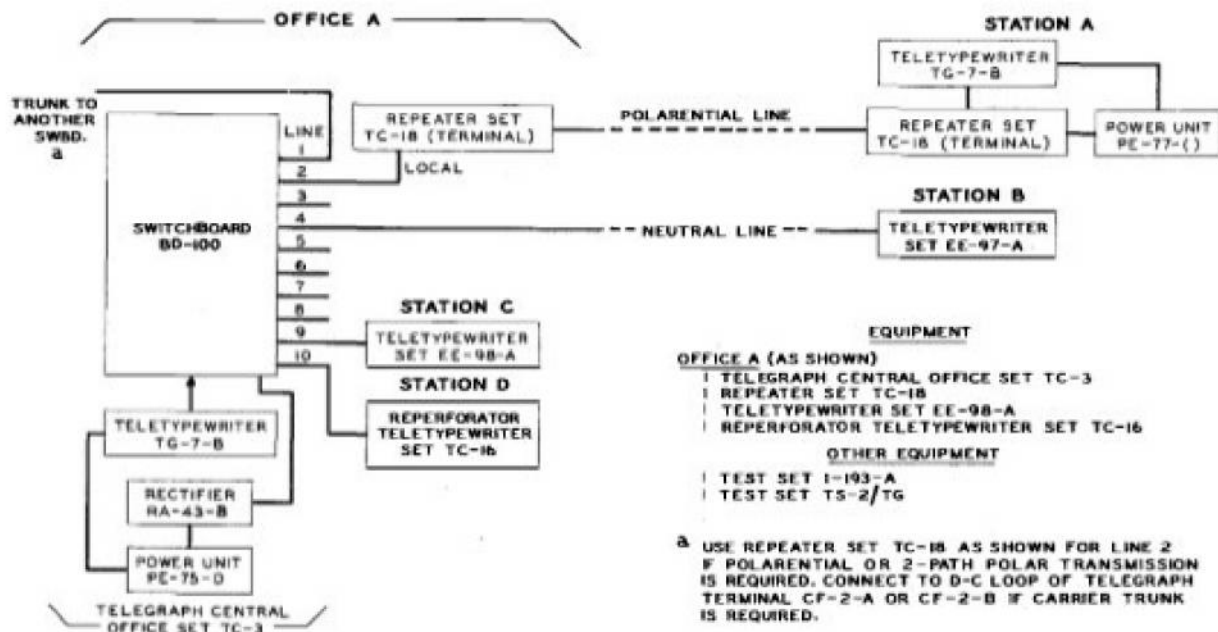

1018. D-C LOOP CONNECTIONS FOR TELEGRAPH TERMINAL CF-2-B (CARRIER)-TACTICAL EQUIPMENT. Paragraph 1019 illustrates typical connections for the d-c loop circuits of Telegraph Terminal CF-2-B. The carrier side of the telegraph terminal is connected generally to channel 3 of Telephone Terminal CF-1-A. All channel terminals in Telegraph Terminal CF-2-A are identical to those in the CF-2-B equipment and each might be connected to any of the equipment illustrated. Channel 1 is shown connected to Switchboard BD-100 and this channel might provide a trunk to another switchboard or a line to a distant station. In order to provide a long range polarential circuit Repeater TG-30 is connected locally to channel 2 and the line side of the re-

peater extended to a distant station also equipped with a Repeater TG-30. Channel 3 is connected directly to Line Unit BE-77-A for operation with a teletypewriter. Rectifier RA-87 would be used to supply d-c for operating the teletypewriter selector magnet. If channel 4 is arranged for neutral line transmission Line Unit BE-77-A would be employed in combination with a teletypewriter. If channel 4 is arranged for polarential or two-path polar line transmission Repeater TG-30 will be used in combination with a teletypewriter. A-c power for the carrier telegraph terminal, the repeater and the teletypewriter motors, might be obtained from the office supply used to operate the telephone terminal equipment.

1019. DIAGRAM OF CONNECTIONS FOR D-C LOOPS OF TELEGRAPH TERMINAL CF-2-B (CARRIER) - TACTICAL EQUIPMENT.

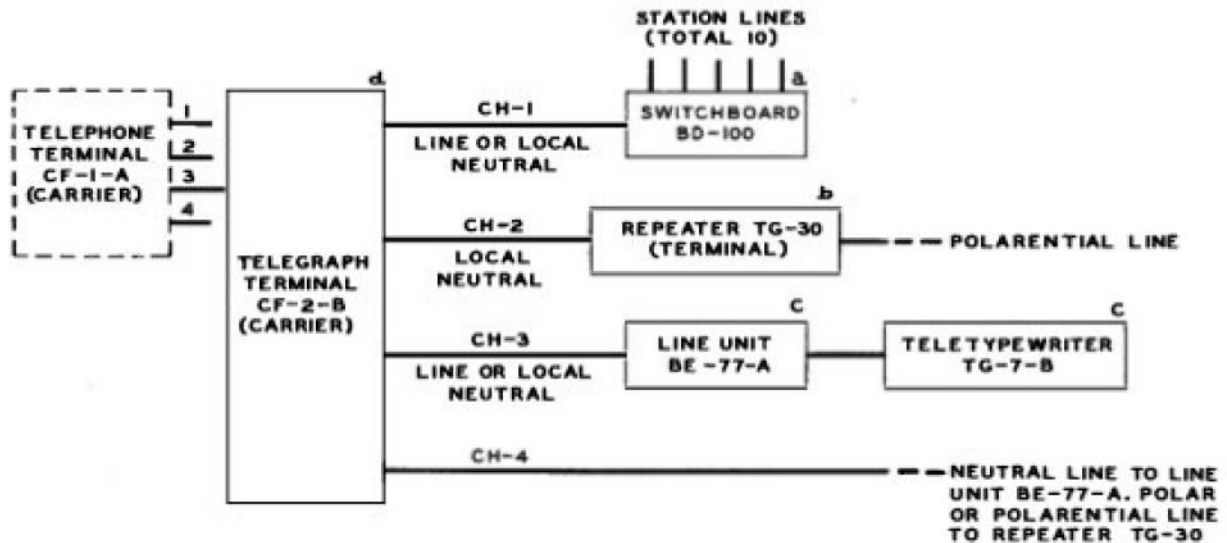

- a PART OF TELEGRAPH CENTRAL OFFICE SET TC-3.
 b PART OF REPEATER SET TC-18 (TERMINAL).
 c PART OF TELETYPEWRITER SET EE-97-A AND EE-98-A.
 d PART OF TELEGRAPH TERMINAL TC-22 (CARRIER)

Section III
Telegraph and Teletypewriter
Fixed Plant Equipment

1020. GENERAL.

a. Fixed plant telegraph line circuits (carrier and d-c) employ telegraph equipment packaged in the same manner as telephone line transmission equipment. Fixed plant teletypewriter equipments are essentially of a commercial nature. This equipment will provide service comparable to that furnished by equivalent commercial equipments.

b. None of this equipment is suitable for outdoor use however, it is capable of operation over temperature ranges normally encountered within a frigid (fully enclosed wooden) type of building.

c. In addition to the instruction books covering individual packaged equipments reference should also be made to TM 11-2022 "Application of Packaged Equipment to Open Wire Lines".

1021. DESCRIPTIVE INFORMATION.

a. Paragraphs 1024 to 1027 inclusive give descriptive matter pertaining to fixed plant telegraph and teletypewriter equipments.

b. Fixed plant d-c telegraph equipment consists of a packaged d-c telegraph repeater and a packaged d-c regenerative telegraph repeater.

c. Fixed plant carrier telegraph equipment consists of a packaged 12-channel

voice frequency system for use ordinarily over a type C carrier telephone channel.

d. Teletypewriter equipments used in fixed plant consist of sending and receiving page teletypewriters, perforators, typing reperforators and transmitter distributors.

e. Automatic Morse code equipment is Boehme automatic keying and recording equipment used generally on radio telegraph circuits where high speed and automatic transmission is a requirement.

f. A radioteletype terminal may use single channel two-tone radioteletype equipment in combination with signal center teletypewriter equipment. The radio sets associated with these radioteletype equipments are described in chapter 14. Radioteletype systems are available only on specially engineered projects. In addition to the individual instruction books reference should be made to TM 11-2207 "The Radioteletype Code Room and Signal Center".

1022. STOCK NUMBERS AND LOGISTICAL DATA.

Paragraph 1028 gives stock numbers, weights and volumes of fixed plant telegraph and teletypewriter equipments.

1023. ILLUSTRATIONS. Examples of the use of fixed plant telegraph equipments on wire and radio circuits are given in paragraphs 1029 to 1032 inclusive.

1024. D-C WIRE TELEGRAPH EQUIPMENT - FIXED PLANT - DESCRIPTION

Name	Monoclitature	Type No.	Fig. No.	Total Wt. in Service lbs.	Size in Oper. (In.) ^a	Approx. Power Input Req.	Tech. Man., ^b Instr. Book, ^b Insir. Man.	Remarks
Repeater Package; D.C. Telegraph;	X-61824A ^b		1013	365	22x 17x 42c	475 V.A. on 115 V. 50/60 cyc. a-c. (In- cludes d-c power for X-66031A D-C Regen. Teleg. Rep. Pkg.)	TM 11-2034 or X-66038b	Cabinet containing two X-61824 D-c Telegraph Repeaters for use on com- posited or simplexed open wire circuits or field wire circuits. Line side arranged under control of a switch for two-path polar or polaren- tial operation. Local side under control of a switch arranged for neu- tral (half and full duplex) operation and two-path polar operation. Cabinet is supplied with a common teletypewriter monitoring circuit, patching jack field and meter panel. Supplied with one positive and one negative regulated tube rectifier. Running spares and patch cords supplied in cabinet. Polar relays are tested and adjusted in Test Set I-195-A.
Repeater Package; Re- generative Telegraph;	X-66031A ^b		1014	315	22x 17x 42c	180 V.A. on 115 V. 50/60 cyc. a-c for motor which drives regen. units. D-C power supplied by X-61824A D-C Teleg. Rep. Pkg.	TM 11-2032 or X-66039b	Cabinet containing two d-c regenerative telegraph repeaters for use on teletypewriter circuits operating 368 o.p.m. or 404 o.p.m. Each re- peater consists of relay repeating circuit and two LB regenerator units. Extension circuits arranged for neutral operation (half and full duplex) and for neutral three-way service. A-c series governed motor. Cabinet contains common meter panel and a patching jack circuit. Running spares and patch cords supplied in cabinet. Polar relays are tested and ad- justed in Test Set I-195-A. Regenerator units lined up by using Test Set TS-2/TG. Maintenance tools (not a part of Tool Equipment TE-50-A) and Test Set TS-2/TG furnished in X-66031B Test Package.
Telegraph Switch- board	SB-6-()/CG		1015	4	7-5/16x 4-5/8x 4-3/4 (wall mtd.)	None	TM 11-2035 or X-66520b	Patching board containing termination for four lines, each with four jacks (2 Looping jacks, one set jack and one miscellaneous jack). Patch cords used to interchange lines and loops. In normal service no patch cords are used. No current is supplied at the board and no supervisory features are incorporated. Six boards may be mounted as a unit to pro- vide 24 lines. Manufacturer's code number is 63-C-2 per X-66068. Sup- plied with 2 W.E.Co. cords P-2AW/347 and 2 W.E.Co. dummy plugs No.165C.

a The first two dimensions represent minimum floor space requirements exclusive
of clearance for operation and maintenance. Packaged equipments should be
installed in an office in accordance with TM 11-2037.

b Western Electric Code numbers.

c Two cabinets each 42-inches high may be stacked to utilize the floor space of
one cabinet.

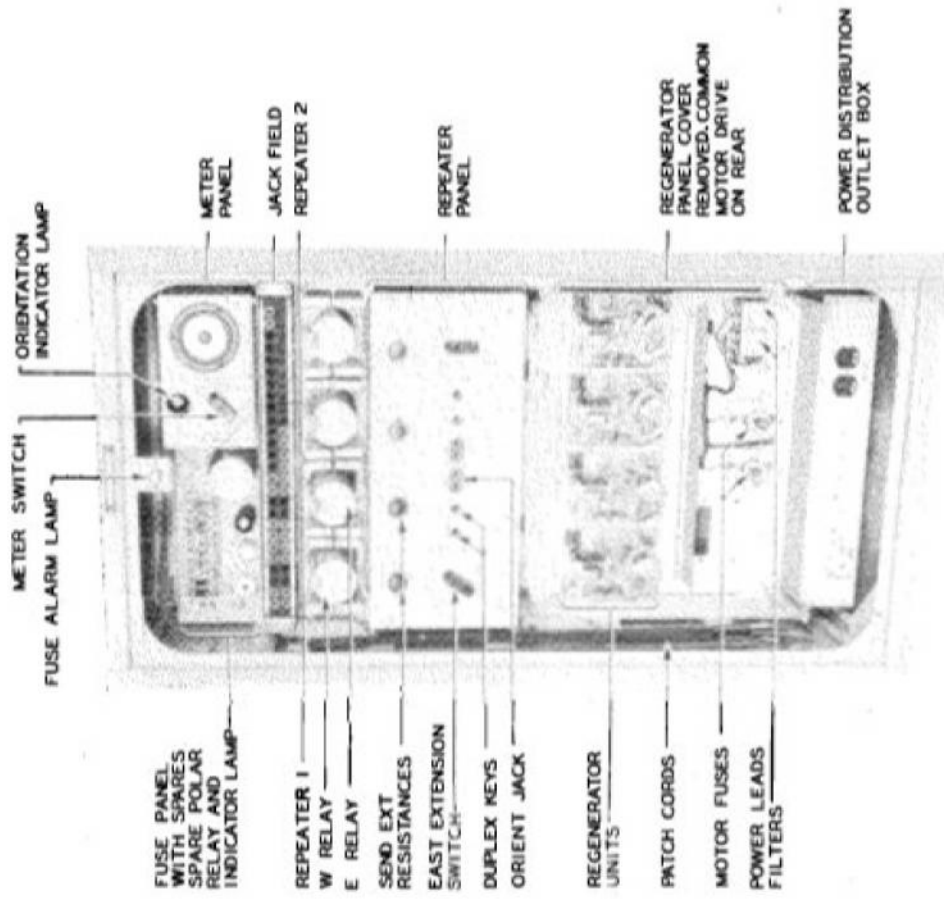

FIGURE 1014. Repeater Package: Telegraph; Regenerative X-66031A

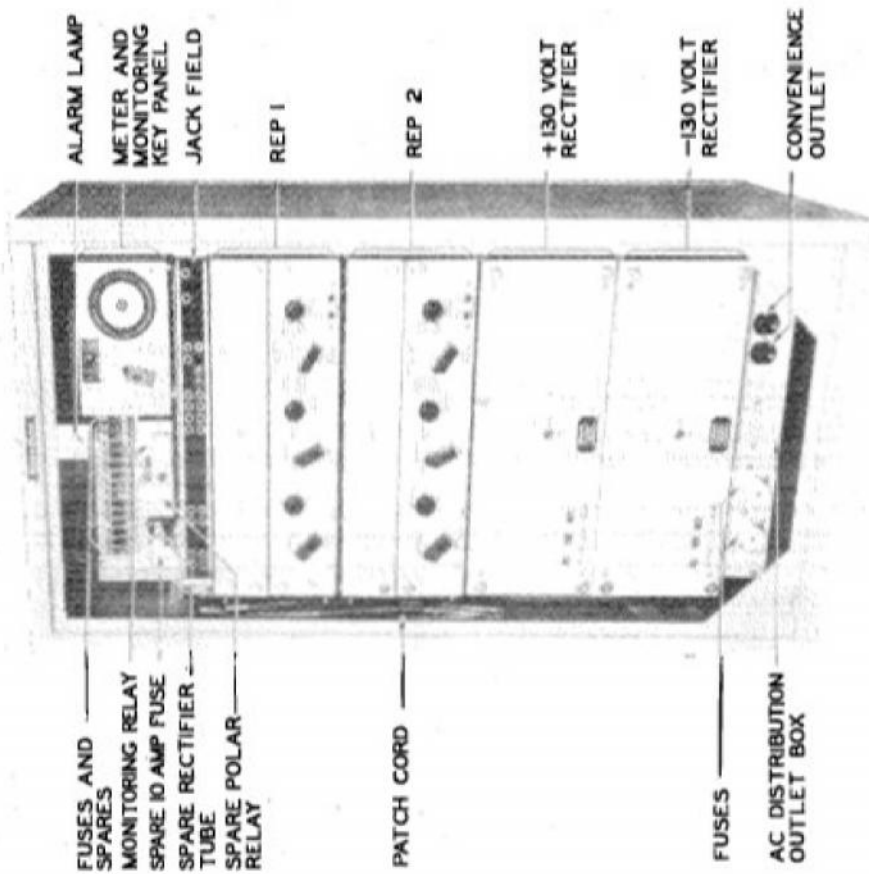

FIGURE 1013. Repeater Package: Telegraph; DC X-61824A

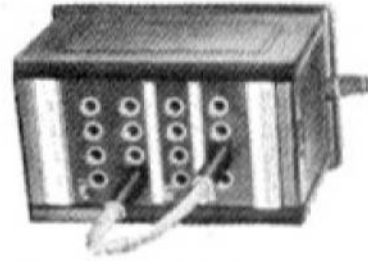

FIGURE 1015. Telegraph Switchboard SB-6-()/GG

1025. CARRIER TELEGRAPH EQUIPMENT - FIXED PLANT - DESCRIPTION.

Manufacturer Name	Type No.	Fig. No.	Total Wt. in Service lbs.	Size in Oper. (In.) ^a	Approx. Power Input Req.	Tech. Man. Instr. Book ^b	Remarks
Telegraph Carrier Package; Voice Frequency; 6 Channel	X-61822A ^b	1016	1175 (2 cabinets, channels 1 to 6)	46x 17x 84	825 V.A. on 115 V. 50/60 cyc. (2 cabinets)	TM 11-2024 or X-66147, & TM 11-2029 or X-63653	Telegraph terminals employed at each end of a carrier telegraph system and connected to one channel of C Carrier Telephone Terminal. Provide six 2-way telegraph circuits (channels 1 to 6) over a 4-wire facility. Mid-band channel frequencies 425 to 1275 cycles spaced 170 cycles. D-c extensions are neutral bal. and full duplex, two-path polar or polar-neutral. Spare parts and running spares supplied in a separate box. Requires X-610220 Test Package which includes Test Set I-193-A.
Telegraph Carrier Package; Voice Frequency; 6 Channel	X-61822B ^b	1016	1175 (2 cabinets, channels 7 to 12)	Same	Same	Same	Same as X-61822A V.F. Carrier Telegraph Repeater Package except different channels (7 to 12). Same carrier telephone channel. Mid-band channel frequencies 1445 to 2295 cycles spaced 170 cycles. May be operated with X-61822A on same telephone channel to provide 12 telegraph circuits.
Carrier Telegraph Equipment	42E1 ^b	-	1760 (2 send. term. cabinets and 2 rec. term. cabinets)	92x 17x 84 (Two send. and two rec. cabinets)	600 V.A. on 115/230 V. 50/60 cyc. a-c. (Two send. term. cabinets and two rec. term. cabinets)	X-61757	Six channel voice frequency carrier telegraph system. Two cabinets required at sending terminal for 6 channels and two cabinets at receiving terminal for 6 channels. Bombe's automatic Morse code and teletypewriter equipments used at stations. Two-way transmission is employed over separate paths. Mid-band channel frequencies are 425 to 2125 cycles spaced 340 cycles. Running spares supplied in separate boxes.
Telegraph Terminal	2E-1/100-1	1017	167	22-1/4x 17-1/2x 21-1/4	176 V.A. on 115/230 V. 50/60 cyc. a-c. 12.5 amp. drain on 12 V. stor. bat.	TM 11-2206	"Speech-Plus-Duplex" (S + IX) equipment. Derives one carrier telegraph circuit from a telephone circuit while retaining the voice circuit. Separation of speech and telegraph by band elimination filters which block out about 1800 to 2000 cycles for telegraph use. Frequency band passed by filters centered at 1690 cycles for one direction of transmission and 1860 cycles for the other direction. D-c loops are neutral, half and full-duplex, polar-neutral or two-path polar. Ringing may be voice frequency, 30 cycle or d-c. Filter F-2/30 is used at an intermediate point to by-pass telephones equipment. Carrier is on for "mark" and off for "space". Terminal may be stacked with "packaged" equipments. Running spares are included.
V.F. Carrier Telegraph, Multi-channel two-tone, single-sideband H.F.	V.E.Co. 40C1 modified plus additions	-	4405 (8 cab-inets) 5260 (10 cab-inets)	186x 17x 84 (8 cab.) 231x 17x 84 (10 cab.)	4000 V.A., 115 V. 50/60 cyc.	X-61755 X-66578 ^c	Provides 2-way teletypewriter circuits. 8 cabinets provide 3 frequency diversity circuits or 6 circuits without frequency diversity. Two more cabinets (double modulation equipment) increase capacity to 6 frequency diversity circuits. One single tone interrupted C.N. telegraph order wire included. Stock nos. and logistical data for complete radio telegraph system given in par. 1424.

^aThe first two dimensions represent minimum floor space requirements exclusive of clearance for operation and maintenance. Packaged equipments should be installed in an office in accordance with TM 11-8037.

^bWestern Electric code numbers.

^cFor equipment supplied after Jan. 1, 1944.

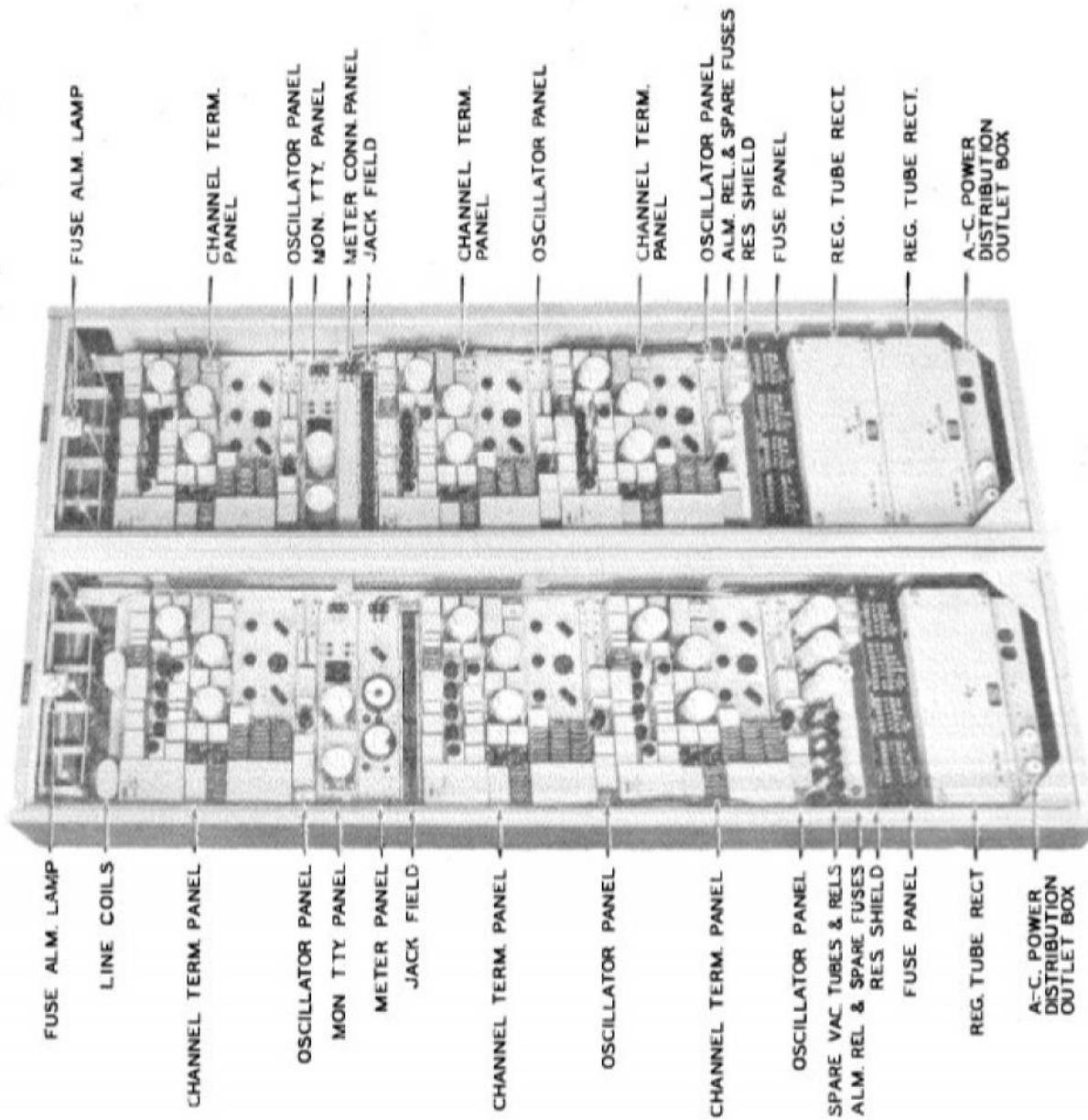

FUSE ALM. LAMP

LINE COILS

CHANNEL TERM. PANEL

OSCILLATOR PANEL

MON TTY PANEL

METER PANEL

JACK FIELD

CHANNEL TERM. PANEL

OSCILLATOR PANEL

CHANNEL TERM. PANEL

OSCILLATOR PANEL

SPARE VAC TUBES & RELS

ALM. REL & SPARE FUSES

RES SHIELD

FUSE PANEL

REG. TUBE RECT

A-C. POWER DISTRIBUTION OUTLET BOX

FUSE ALM. LAMP

CHANNEL TERM. PANEL

OSCILLATOR PANEL

MON TTY PANEL

METER CONN. PANEL JACK FIELD

CHANNEL TERM. PANEL

OSCILLATOR PANEL

CHANNEL TERM. PANEL

OSCILLATOR PANEL

ALM. REL. & SPARE FUSES

RES SHIELD

FUSE PANEL

REG. TUBE RECT

REG. TUBE RECT.

A-C. POWER DISTRIBUTION OUTLET BOX

FIGURE 1016. Telegraph Carrier Package X-61822A or B

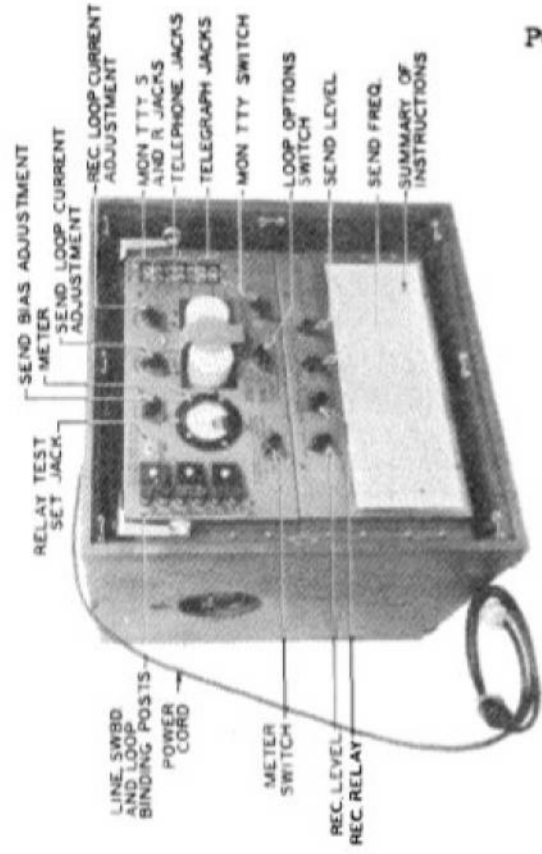

RELAY TEST SET JACK

SEND BIAS ADJUSTMENT

METER SEND LOOP CURRENT ADJUSTMENT

REC LOOP CURRENT ADJUSTMENT

MON TTY S AND R JACKS

TELEPHONE JACKS

TELEGRAPH JACKS

MON TTY SWITCH

LOOP OPTIONS SWITCH

SEND LEVEL

SEND FREQ.

SUMMARY OF INSTRUCTIONS

LINE SWBD AND LOOP BINDING POSTS

POWER CORD

METER SWITCH

REC. LEVEL

REC RELAY

FIGURE 1017. Telegraph Terminal TH-1/TCC-1

1026. TELETYPEWRITER AND AUTOMATIC MORSE CODE EQUIPMENT - FIXED PLANT - DESCRIPTION.

Nomenclature		Shown in Pkg. No.	Total Weight - lbs. Unpacked and in Service	Dimensions in Operation (Inches) ^a	Approximate Power Input Requirements	Technical Manual, Instruction Book, d Instruction Manual	Remarks
Name	Type No.						
Teletypewriter Set: Printer; Sending and Receiving; Standard Keyboard	Model 15 ^b	1018	215	21-1/2x18-1/2 x42	240 V.A. on 115 volts 50/60 cycles a-c. (Motor power and input to recti- fier to furnish 30 mill line relay bias current)	TM 11-355 Instruction Manual Nos. 7 or 22	Page-receiving and keyboard-sending teletype- writer. "Standard" communications keyboard and type bar arrangement. Pulling magnet selector and line relay. Motor controlled by switch and automatic built-in control. A-c series governed motor operating on 115 volts, 50-60 cycles, a-c. Motor speed adjusted for 368 or 404 o.p.m. Teletypewriter mounted on metal table which also mounts rectifier supply- ing d-c for local circuits. Rectifiers avail- able for operation on 115 volts, 50-60 cycles or for operation on 115 volts or 250 volts, 25, 40, 50 or 60 cycles. Rectifiers operating on 250 volts have 115 volt tap on transformer for supplying teletypewriter motors.
Teletypewriter Set: Printer; Sending and Receiving; Weather Keyboard	Model 15(W) ^b	-	Same	Same	Same	Same	Same as Model 15 Teletypewriter except with "weather" communication keyboard and with automatic motor control omitted.
Teletypewriter Set: Printer; Sending and Receiving; Standard Keyboard	Model 19 ^b	1019	406	37x24x42	520 V.A. on 115 volts 50/60 cycles a-c. (For trans- mitter-distributor motor, teletype- writer motor, perforator magnet and line relay bias current)	TM 11-355 Instruction Manuals Nos. 10 or 26	Page-receiving, keyboard-sending and tape per- forating teletypewriter mounted on metal table with a transmitter-distributor for tape send- ing. "Standard" communications keyboard and type bar arrangement. Motors in teletype- writers and transmitter-distributors are a-c series governed motors adjustable for 368 or 404 o.p.m. Teletypewriter motors have switch and automatic motor control. Table for mount- ing teletypewriter and transmitter-distributor also mounts rectifier to supply d-c for local circuits. Rectifiers available for operation on 115 volts, 50-60 cycles or 115 volts or 250 volts, 25, 40, 50 or 60 cycles. Rectifiers operating on 250 volts have 115 volt tap on transformer for supplying teletypewriter and transmitter-distributor motors.
Teletypewriter Set: Printer; Sending and Receiving; Weather Keyboard	Model 19(W) ^b	-	Same	Same	Same	Same	Same as Model 19 Teletypewriter Set except that the teletypewriter is supplied with "weather" keyboard and type-bar arrangement.

^a The first two dimensions represent minimum floor space require-
ments exclusive of clearance for operation and maintenance.

^b Teletypewriters include line relay (Western Electric Co. 255a
which is Teletype Corp. RT-90). 60-speed tuning fork, radio
filter, copy holder, metal table, universal 115 volt a-c series
governed motor and rectifier are furnished with sets.

^c Keyboard for communication and with symbols and type-bar arrangement
for sending and receiving weather information.

^d Teletype Corporation.

Designation	Model No.	Shown in File No.	Total Weight - lbs. Unpacked and in Service	Dimensions in Operation (Inches)	Approximate Power Input Requirements	Technical Manual, Instruction Book, Instruction Manual	Remarks
Teletypewriter Set	AM/TCC-1	1080	475	24x24x65	570 V.A. on 115 volts 50/60 cycles a-c 425 watts on 115 volts d-c	TM 11-2203	Sending and receiving tape relaying package unit. In console. Includes multiple transmitter-distributor (3 message transmitters and 1 number transmitter driven by common motor), 2 typing perforators, 1 motor driven tape winder, rectifier, and tape feed-out feature and necessary controls and alarms. Units may be combined in a single installation, messages received on perforated tape with typing, may be torn and inserted manually in a transmitter. Operation single or duplex at 366 o.p.m. Duplex operation either neutral or polar. May be used for "normal" or split operation on one or two circuits respectively.
Boehme Automatic Keying and Recording Equipment ^b		1021				TM 11-377	Equipment for automatically transmitting and for receiving at high-speed International Morse Code telegraph signals on radio. At transmitting point, the equivalent of dots and dashes is perforated in tape (15/32 inch wide) by the use of a Wheatstone perforator which has a typewriter keyboard. Tape is run through keying head mounted on keying drive. Keying head controls radio transmitter. Principle equipments with transmitting table are Boehme keyer, two Wheatstone perforators, time stamp and rectifier such as General Electric Co. GERRICK (115 volt 50/60 cycle) or GERRICK (250 volt 50/60 cycle), when d-c power is not available. At receiving point, equipment is mounted on a receiving table, the principle equipments thereon being a Boehme ink recorder and recorder driving unit, tape puller with magnetic release attachment, tape puller with rewind reel attachment and tape bridge. Recorder driving unit receives keyed tone dot and dash signals from radio receiver or similar source and converts the signals to d-c to operate ink recorder. Coil in recorder actuates fountain-type pen which makes a record on tape symbolic of dot and dash signals. Tape is pulled over tape bridge just above keyboard of a typewriter and operator transcribes message.
Keying Head	4-K		B	Mounts on Keying Head Drive	Keying Head Drive		
Keying Head Drive Ink Recorder	4-D 4-C		50 29	11x18x13 10x10x10 (base 7 inch dia.) 19x12x10-1/2	Motor 130 watts on 110 volts d-c Ink Recorder, 35 watts on 110 volt d-c		
Recorder Driving Unit	4-C		105	9x13-1/2x16-1/2 7x13x8	Recorder Driving Unit 175 watts on 110 volts 60 cycles a-c (210 V.A. estimated)		
Tape Puller	4-F Series B		30 ^d , 20 ^e				
Rewinder Reel Attachment	4-FA			10-1/2x5-1/2 x23 (base 5-3/4x5-1/4)			
Magnetic Release Attachment	7-7A			Over-all 23 long, 8-1/4 high on two pedestals each with 4 inch dia. base	Tape Pullers, each about 75 watts on 110V d-c		
Tape Reel	7-H		5				
Tape Bridge	4-K		5				
Tape Perforator, Wheatstone Receiving Table	(Teletype)		41	20x18x16	150 watts on 110 volts d-c	Instruction f Manual No. 15	
Transmitting Table			125	95 long x 19 wide x 27 high			
			125	95 long x 19 wide x 27 high			

a The first two dimensions represent minimum floor space requirements exclusive of clearance for operation and maintenance. Boehme equipment mounts on tables.

b Boehme Code Numbers.

c Mounts on small relay rack mounted on receiving table.

d With Rewinder Reel Attachment.

e With Magnetic Release Attachment.

f Teletype Corporation.

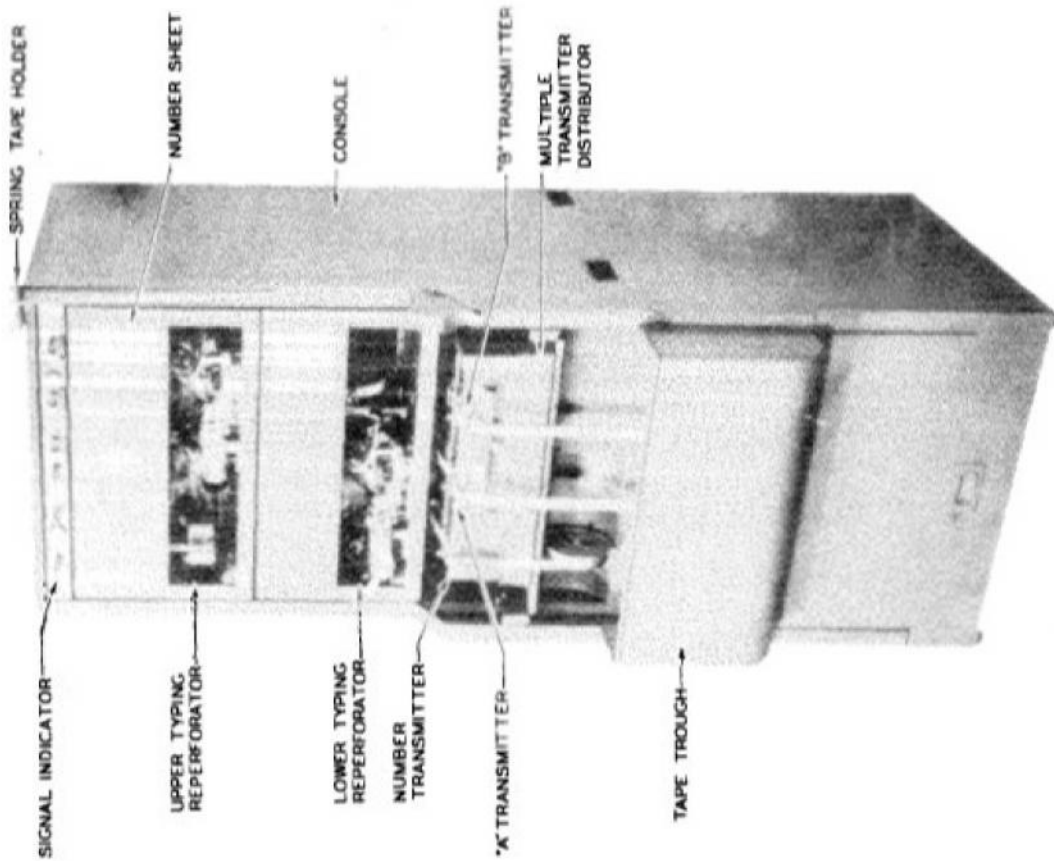

FIGURE 1020. Teletypewriter Set AN/TCC-1

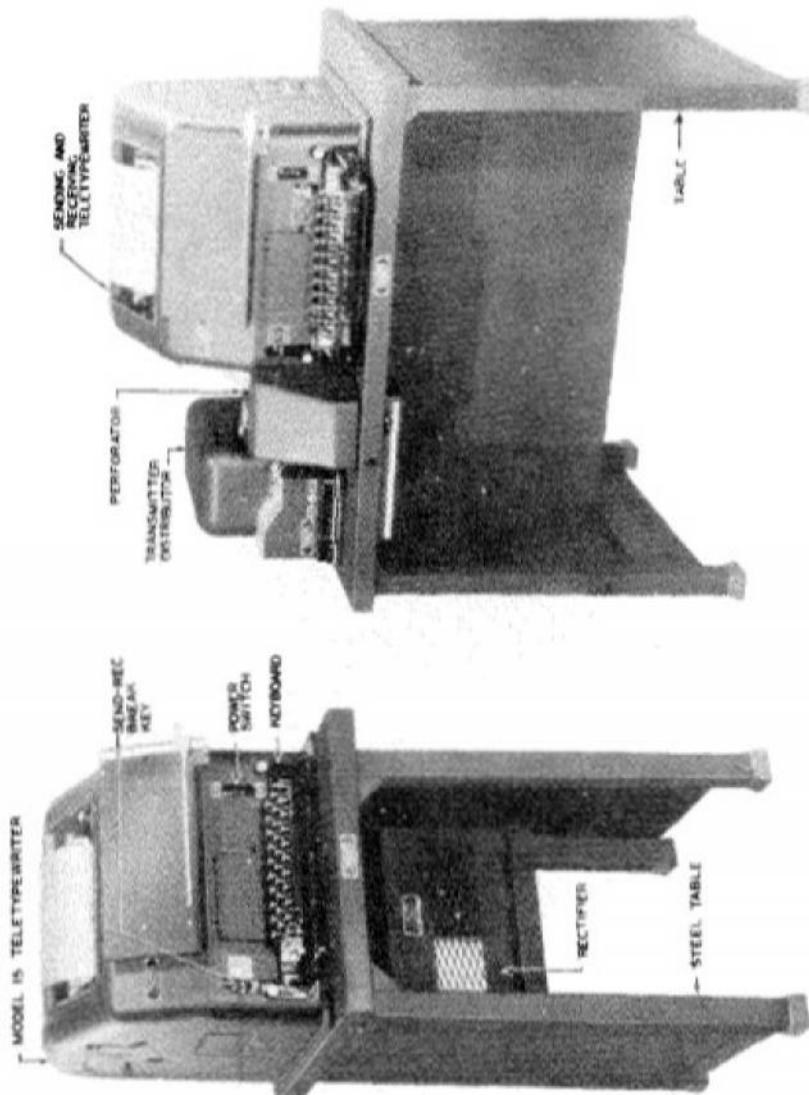
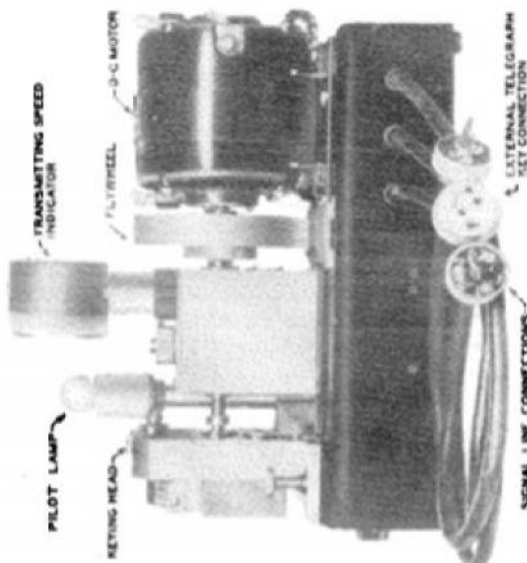
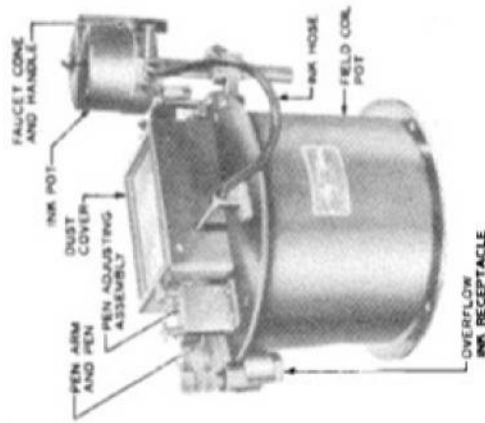

FIGURE 1019. Model 19 Teletypewriter Set

FIGURE 1018. Model 15 Teletypewriter Set



Keying Head with Keying Drive



Ink Recorder

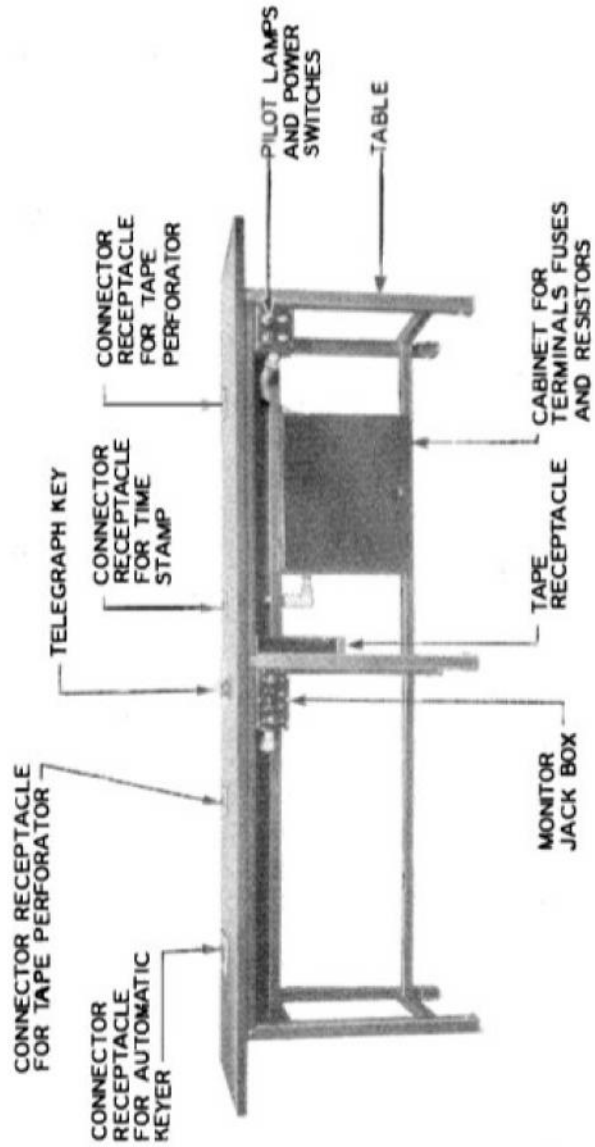

Transmitting Table

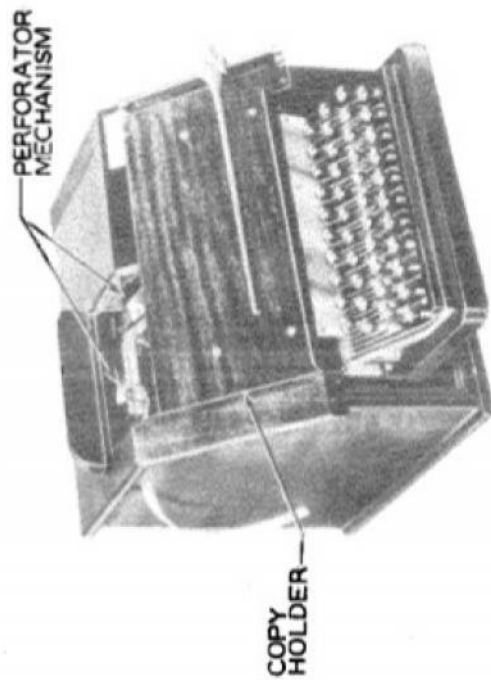

Wheatstone Perforator (Teletype)

FIGURE 1021. Boehme Automatic Keying and Recording Equipment

1027. RADICTELETYPE TERMINAL AND ASSOCIATED SIGNAL CENTER TELETYPEWRITER EQUIPMENT - FIXED PLANT - DESCRIPTION.

Base Name	Manufacturer	Type No.	Fig. No.	Total Wt. in Service lbs.	Size in Oper. (in.) ^a	Approx. Power Input Req.	Tech. Man. Instr. Book	Remarks
Radio teletype Terminal Equipment	AM/FOC-1	1022		425	22x 17x 84	160 V.A. on 115 V. 50/60 cye.	TM 11-3656	Voice frequency carrier telegraph equipment for use as single channel two-tone space diversity radioteletype receiving terminal. Associated radio receivers invert the incoming signals to a frequency of 2125 cycles for the "closed" condition and 2995 cycles for the "open" condition of the sending contacts. The AM/FOC-1 equipment rectifies these signals to d-c telegraph signals for operation of teletype-writer equipment at a signal center.
Teletypewriter Subscriber Set	132A2 ^b	1025		600	26x 22x 44	360 V.A. on 115 V. a-c. Operates on 115/200 V. 25/50 cye.	TM 11-2210 or X-6615 ^b	Cabinet-type table with a receiving-only typing reperforator with a synchronizing circuit for receiving from a radio channel and a transmitter-distributor for sending to a radio transmitter or other circuit. Typing reperforator has holding-magnet selector. Transmitter-distributor and typing reperforator supplied with series a-c governed motor.
Repeater and Control Unit	X-6610A ^b	-		18	In 132A2 Set	36 V.A. from 132A2 Set	X-66330 ^b	Used with and located inside the table of the 132A2 set. Arranges set connections for simplex service, sending polar signals to radio transmitter and controlling radio receiver and transmitter.
Teletypewriter Subscriber Set	133A1 ^b	-		375	26x 22x 44	265 V.A. on 115 V. 50/60 cye. a-c	TM 11-2211 or X-6615 ^b	Cabinet-type table with a receiving-only typing reperforator and transmitter-distributor for code room circuits or for sending or receiving on lead lines. Table supplied with polar relay for converting from neutral to polar transmission or vice versa. Typing reperforator supplied with holding magnet selector.
Teletypewriter Subscriber Set	133A2 ^b	-		390	26x 22x 44	360 V.A. on 115 V. a-c. Operates on 115/230 V. 25/50 cye.	TM 11-2214	Similar to 132A2 set except that synchronizing circuit omitted. Also used in place of 133A1 set.
Transmitter-Distributor	XD91 ^c	1024		42	Part of 132A2 Set	Part of 132A2 Set	X-66365 ^b	Two-channel transmitter-distributor furnished in place of the single-channel transmitter-distributor on a 132A2 set when two-channel operation is desired. Two tapes sent simultaneously from transmitter and either may be started and stopped independently of other. Transmitter-distributor may be switched to single channel operation, if required. Motor is series a-c governed.
Oscillator Exciter	O-5/72 (Press Wireless 2512A Koyer)	1026		81	13x 19x 15	150 V.A. 110/250 V. 50/60 cye. a-c	TM 11-2206	Provides a means for keying an HF radio transmitter by the frequency shift method to obtain "mark" and "space" conditions for transmitting signals over radio circuits. The "space" frequency is 425 cycles lower than the carrier frequency and the "mark" frequency is 425 cycles higher than the carrier frequency. Thus the frequency shift is 850 cycles and is suitable for reception by Radioteletype Terminal AM/FOC-1. Exciter receives d-c telegraph signals from teletypewriter or other sending source and its output side is connected to the radio transmitter using a coaxial line. Exciter replaces the regular radio frequency oscillator of the radio transmitter to which it is connected. Equipment is panel mounted and arranged for use on 19-inch relay rack. Running spares are provided.

^aThe first two dimensions represent minimum floor space requirements exclusive of clearance for operation and maintenance.

^bWestern Electric Code numbers.

^cTeletype Corporation number.

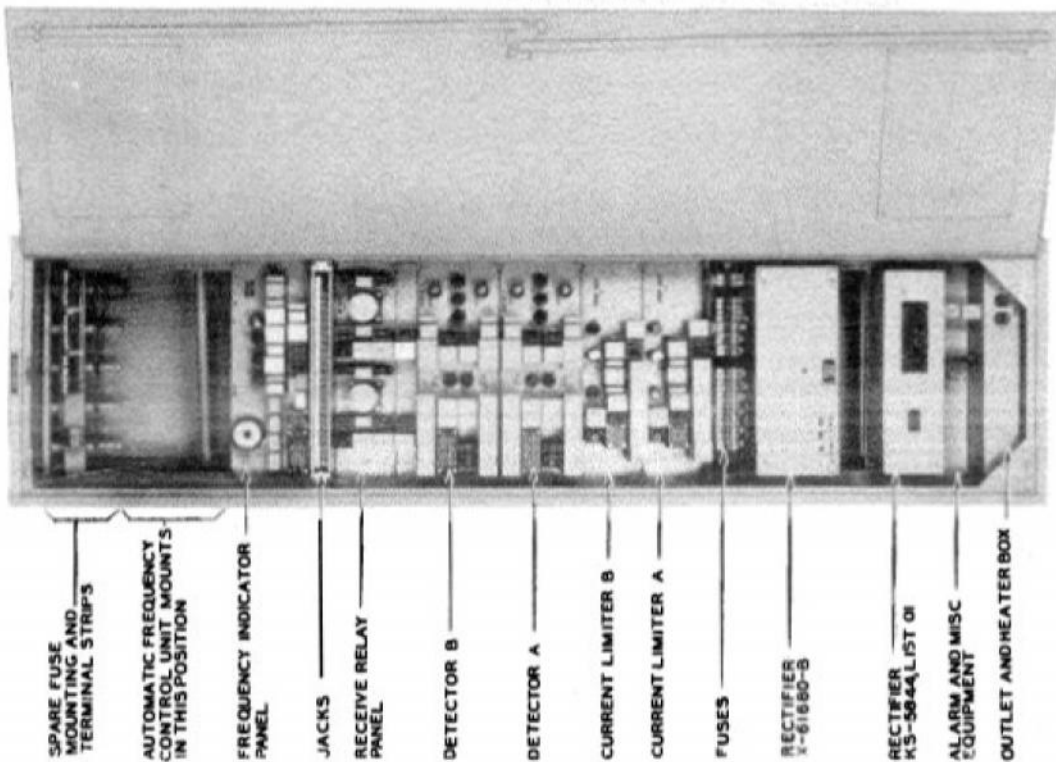

FIGURE 1022. Radioteletype Terminal Equipment AN/FGC-1

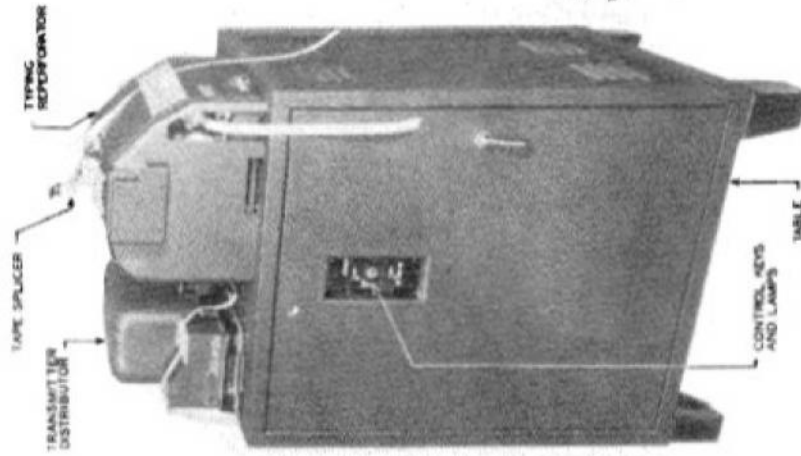

FIGURE 1023. Teletypewriter Subscriber Set 132A2

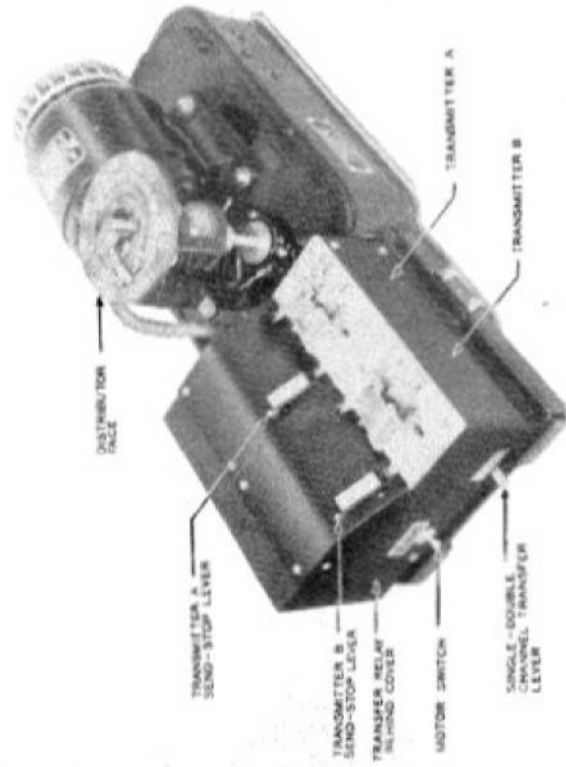

FIGURE 1024. Transmitter-Distributor XD91

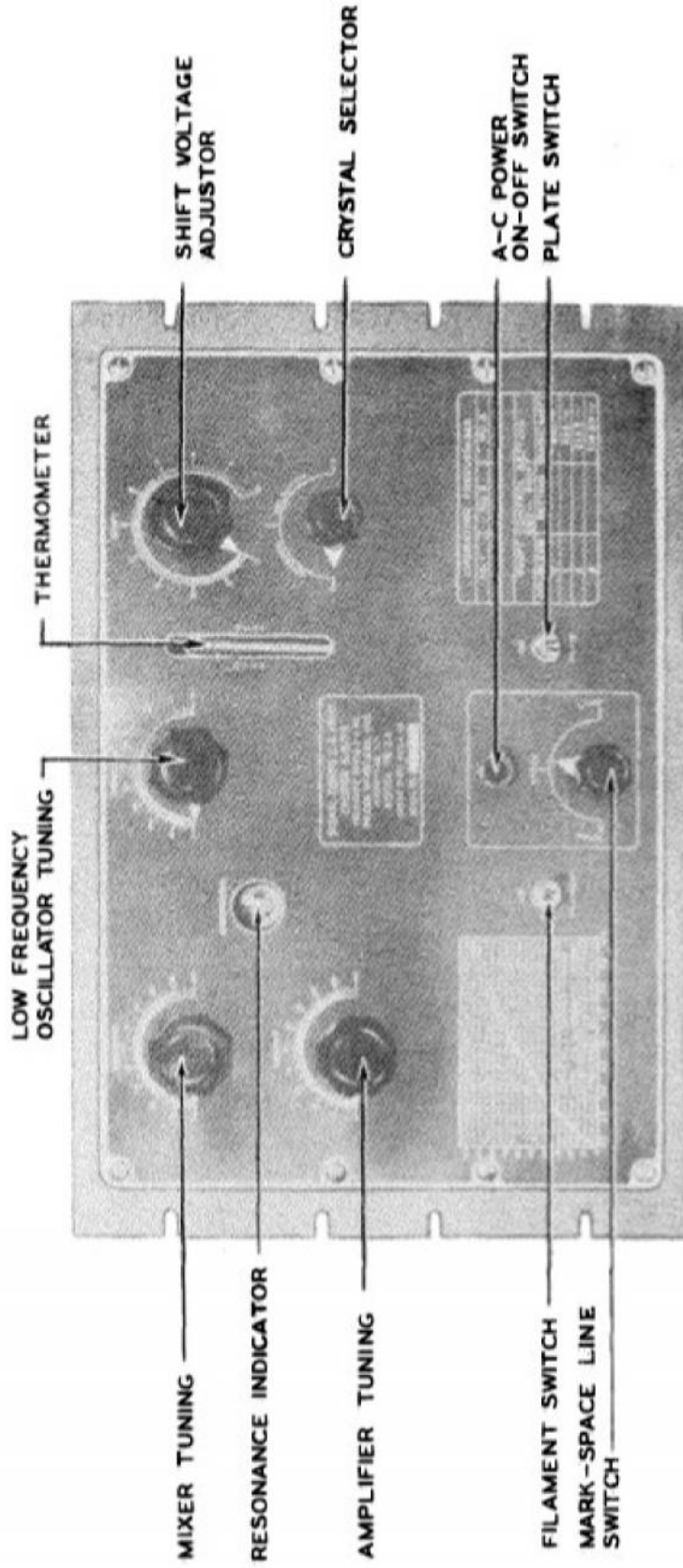

FIGURE 1025. Oscillator Exciter O-5/FR
(Press Wireless F512A Keyer)

1028. TELEGRAPH, TELETYPEWRITER AND AUTOMATIC MORSE CODE EQUIPMENT - FIXED PLANT - STOCK NUMBERS AND LOGISTICAL DATA.

Description Name	Type No.	Stock No.	Weight (lbs.) of		Total Displacement (cu. ft.)	Ship Tonnage ^a
			Box Packed for Export	Total Weight (lbs.) Packed for Export		
Telegraph Carrier; Package; Voice Frequency; 6 Channel	I-61822A	442794	775	1580	66 (5 boxes)	1.7
Telegraph Carrier; Package; Voice Frequency; 6 Channel	I-61822B	442794.1	775	1580	66 (5 boxes)	1.7
Repeater Package; Telegraph; D.C.	I-61894A	442798	500	500	25 (1 box)	0.6
Repeater Package; Telegraph; Regenerative	I-66051A	None assigned	450	500	25 (1 box)	0.6
Repeater and Control Unit	I-66106A	476189-18				
Teletypewriter Set; Printer; Sending and Receiving; Std. Keyboard	Model 15	472.18A-1 ^b	235	450	35 (2 boxes)	0.9
Teletypewriter Set; Printer; Sending and Receiving; Weather Keyboard	Model 15(W)	472.98-1 or ^c 472.18A-1	235	450	35 (2 boxes)	0.9
Teletypewriter Set; Printer; Sending and Receiving; Std. Keyboard	Model 19	474.15A-1 ^d	210	775	59 (4 boxes)	1.5
Teletypewriter Set; Printer; Sending and Receiving; Weather Keyboard	Model 19(W)	474.8A-1 or ^e 474.15A-1 or 474.15B-1	210	775	59 (4 boxes)	1.5
Radioteletype Terminal Equipment	AM/FGO-1	47961789	635	635	30	0.8
Teletypewriter Subscriber Set	153A2	FTMT-471487KDS-G.1 ^f	300	650	34 (3 boxes)	0.9
Teletypewriter Subscriber Set	153A1	FTMT-47387KDS-G	280	490	30 (2 boxes)	0.8
Teletypewriter Subscriber Set	153A2	47W153A2 ^f	290	642	34 (3 boxes)	0.9
Transmitter Distributor	ED91	None assigned		70	5	0.1
Switchboard	SB-G-()/GG	None assigned		10(1 board) 45(6 boards)	0.57(1 board) 1.85(6 boards)	-
Carrier Telegraph Equipment	42E1	442503-G	625	2970 (8 boxes)	140 (8 boxes)	3.5
Teletypewriter Set	AM/FGO-1	471000-1	690	1190	85 (4 boxes)	2.1
Telegraph Terminal	TH-1/700-1	442895	225	225	15	0.35
Bohm Automatic Keying and Recording Equipment						
Keying Head	4-E	441245		24	0.7	
Keying Head Drive	4-D	44564		180	6.1	
Ink Recorder	4-C	441954		88	3.0	
Recorder Driving Unit	4-C	441215		165	5.5	
Tape Puller	4-F, Series K	442704.2 ^g , 442704.1 ^h		68 ⁱ , 60 ^d	3.1 ^e , 2.4 ^d	
Revolving Reel Attachment	4-F1					
Magnetic Release Attachment	7-2A					
Tape Reel	7-B	442707B		20	1.0	
Tape Bridge	4-K	442744K		20	0.8	
Tape Perforator, Wheatstone	(Teletype)	441720		300	30	0.75
Transmitting Table	-	443025J		320	50	1.25
Receiving Table	-	443024J		320	50	1.25
Oscillator Exciter	O-G/YE	2C2710-5	138	138	6.35 cubic feet	0.2

^a A "Ship Ton" equals 40 cu. ft.

^b Stock No. 472.18A-1. Communications keyboard, figures "P" motor stop, Rectifier REC29 for 95-125 and 190-250 volts and 25,40,50 or 60 cycle a-c input. Table is KRT-115.

^c Stock No. 472.98-1. Weather keyboard, motor switch control, Rectifier REC10 for 115 volt, 50-60 cycle a-c input. Table is KRT-106.

Stock No. 472.15A-1. Weather keyboard, motor switch control, Rectifier REC29 for 95-125 and 190-250 volts and 25,40,50 or 60 cycle a-c input. Table is KRT-106.

^d Stock No. 474.15A-1. Communications keyboard, character counter pointer and dial, figures "P" motor stop, Rectifier REC30 for 95-125 and 190-250 volts and 25,40,50 and 60 cycle a-c input. Table is KRT-116.

^e Stock No. 474.8A-1. Weather keyboard, motor switch control, Rectifier REC15 for 115 volt, 50-60 cycle a-c input. Table is KRT-107.

Stock No. 474.15A-1. Weather keyboard character counter pointer and dial, Rectifier REC30 for 95-125 and 190-250 volts and 25,40,50 and 60 cycle a-c input. Table is KRT-116.

Stock No. 474.18A-1. Weather keyboard, character counter pointer and dial, carriage return and line feed automatically at end of each line and on carriage return signal, figures "P" motor stop, Rectifier REC30 for 95-125 and 190-250 volts and 25,40,50 or 60 cycle a-c input. Table is KRT-116.

^f Stock number is for table supplied with single-channel transmitter-distributor. When table is supplied with two-channel transmitter-distributor (ED91) the total weight pack for export is 725 pounds and total displacement is 39 cu. ft.

^g Includes Revolving Reel Attachment Assembly.

^h Includes Magnetic Release Attachment Assembly.

ⁱ Includes hand telegraph key, monitor jack box, conduit and wiring, receptacle connectors, terminal and fuse cabinet, power toggle switches and pilot lamps.

1029. PACKAGED TELEGRAPH EQUIPMENT ON
OPEN WIRE LINES - FIXED PLANT.

Paragraph 1030 illustrates a use for packaged telegraph equipment on two open wire pairs operating with Type C Carrier. This diagram shows the telegraph equipment and only that part of the telephone equipment (shown by dotted lines) which is directly involved in the telegraph connections. Similar illustrations of the use of packaged telephone equipment are given in Chapter 9. Terminal Office A is shown as being equipped with X-61822 A and B carrier telegraph terminal packages, X-61824A d-c telegraph repeater packages, and X-66031A d-c regenerative telegraph repeater package. Office B is shown as an intermediate office with X-61824A d-c telegraph repeater packages, and X-66031A d-c regenerative telegraph re-

peater package. Terminal Office C is shown equipped the same as Office A except that the regenerative repeater is omitted. Each office should be supplied with a monitoring teletypewriter for supervising service as it is not included in packaged equipments. A Test Set I-193-A should be made available for Office B since no carrier telegraph equipment is located at that office and therefore the X-61822C test package containing Test Set I-193-A is not available. A Test Set TS-2/TG should be available in Office C for lining up teletypewriter circuits. In Office A and Office B this set will be available because the X-66031B regenerative repeater test package containing Test Set TS-2/TG will be available for use with the X-66031A d-c regenerative repeater package.

1030. DIAGRAM OF PACKAGED TELEGRAPH EQUIPMENT ON OPEN WIRE LINES.

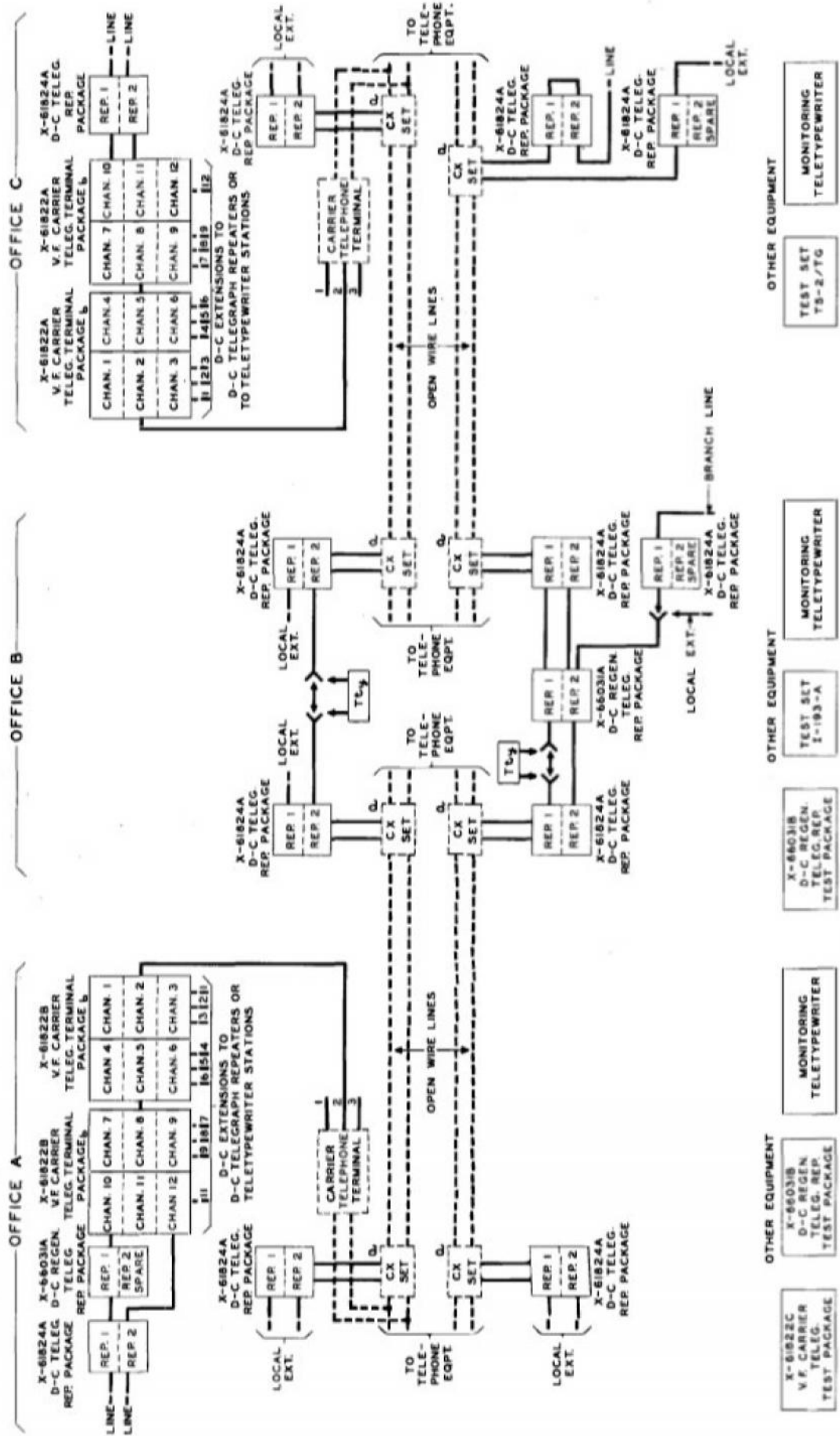

a. COMPOSITE SETS ARE FURNISHED WITH THE TELEPHONE EQUIPMENT.
 b. INCLUDES A BOX OF RUNNING SPARE PARTS.

1031. RADIOTELETYPE TERMINAL AND SIGNAL CENTER. Paragraph 1032 illustrates a single-channel (two-tone) radioteletype system composed of a receiving station, a transmitting station and a signal center. Signals are sent initially from the transmitter-distributor on the 132A2 set to the radio transmitting station. The transmitter sends its normal frequency for the marking (closed) condition and a frequency 850 cycles lower for the spac-

in (open) condition. At the receiving station the diversity receivers invert and then convert the radio signals to frequencies in the voice range (mark, 2125 and space, 2975 cycles) which are rectified in Radioteletype Terminal AN/FGC-1 to d-c telegraph signals. These d-c signals are finally received by the typing reperforator in the 132A2 set. The 133A1 set is shown as being used in connection with room circuits.

1032. DIAGRAM OF A RADIOTELETYPE TERMINAL AND SIGNAL CENTER.

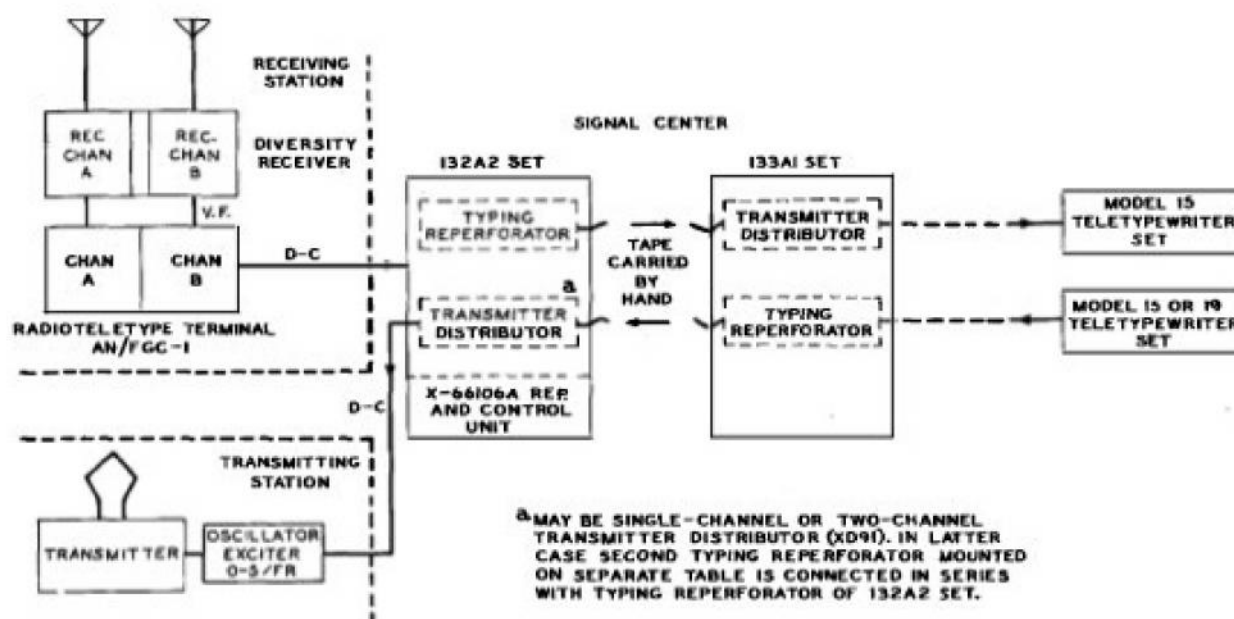

**Section IV
Telegraph and Teletypewriter Testing
Equipment, Tool Equipment and
Teletypewriter Supplies**

1033. GENERAL

a. This section contains information covering teletypewriter expendable supplies. These items are applicable to both tactical and fixed plant equipments.

b. Information concerning teletypewriter test sets, tool equipment and maintenance equipment will be found in chapter 13.

c. The teletypewriter supplies listed are those which are essential in all cases for the operation of teletypewriter equipment and include supplies required for producing page copies and perforated tape with or without typing. The lubricating oils and greases are for general lubrication of teletypewriter equipments.

1034. TELETYPEWRITER SUPPLIES - TACTICAL AND FIXED PLANT - DESCRIPTION AND STOCK NUMBERS.

<u>Name</u>	<u>Description</u>	<u>Stock No.</u>	<u>Suppliers No.</u>
Paper, single copy	Teletype, roll form for page teletypewriters, 8-1/2" wide, 350 foot roll, canary yellow	4T1 ^a (formerly 4A1650)	
Paper, duplicate copy	Teletype, roll form for page teletypewriters, one carbon insert, 2-ply, 8-1/2" wide, canary yellow	4T2 (formerly 4A1650.1)	
Paper, triplicate copy	Teletype, roll form for page teletypewriters, canary yellow, two carbon inserts, 8-1/2" wide, 5" diam., 3-ply	4T11 (formerly 4A1650.3)	
Ribbon	Teletype, black record, medium inking, 1/2" wide, 12 yards long	6M1175 ^a	
Tape	Teletype, paper for perforators and reperforators, 11/16" wide, 1000 feet long	4A2702	
Oil	One quart, lubricating oil	6G1325 (formerly 4T88770)	W.E.Co., KS-7470 Teletype, No. 88970
Oil	One gallon, lubricating oil	6G1326 (formerly 4T88971)	W.E.Co., KS-7470 Teletype, No. 88971
Grease	One 4 oz. tube, lubricating grease	4T97116	W.E.Co., KS-7471 Teletype, No. 97116
Grease	One pound, lubricating grease	4T88973	W.E.Co., KS-7471 Teletype, No. 88973

^a Part of Chest CH-53, 4TCH53, formerly 4A353 and Chest CH-53-A, 4TCH53A, formerly 4A353A. Chest CH-53 is part of EE-97. Chest CH-53-A is part of EE-97-A.

This Page Intentionally Blank

CHAPTER 11
FACSIMILE EQUIPMENT

1101. GENERAL. Facsimile comprises the transmission of fixed graphic material including pictures, sketches, text or handwriting from one point to another by electrical means. Three different facsimile equipments are available for general use as covered in accompanying photographs and tabulations and described briefly below.

1102. TAPE FACSIMILE EQUIPMENT RC-58-B. This is a machine for transmitting copy generally in the form of hand printing on a tape. Standard typewriter characters are too small. At the sending end the text is hand printed with pencil in a 3/8" high band on a 3/4" wide tape, using a writing stand provided with guides and means for holding a roll of blank tape. Hand printing can be done at speeds up to about 15 words per minute or 18" of tape per minute. The machine sends tape at the rate of 50" per minute, or about 42 words per minute. The scanning is at 72 lines per lineal inch of tape. The output of the machine is a frequency modulated signal, picture white being set at 1150 cycles and picture black at 1650 cycles. The sending and receiving machines are mounted in a single housing, and the receiver can be used to monitor outgoing signals if desired. The receiver uses direct electromechanical recording, in which the tape is pressed against an inked printing element to make the marks. The received record is in the form of two duplicate lines of letters, one above the other, on a tape 3/4" wide. Tape facsimile signals may be transmitted over any voice channel, wire or radio, and carrier telephone channels may be used.

1103. FACSIMILE EQUIPMENT RC-120.

a. This is a general purpose page machine providing for the transmission and reception of printed, written, drawn or photographic copy over regular voice communication channels. Original copy for transmission may be up to 7" x 8-5/8" in dimensions but the actual message or picture for transmission should not exceed 7" x 7-3/8" for photographic recording of 6-1/4" x 7-3/8" for direct

recording. Transmission may be arranged for reception as a negative on film, or a positive on bromide photographic paper, or as a positive on direct recording paper (Teledeltos). The so-called "transceiver" unit includes a driving motor and rotating drum for carrying the record sheet or film, and may be used for either sending or receiving purposes.

b. The output of the sending machine gives amplitude modulation of an 1800 cycle carrier current. The double side-band width is somewhat over 1250 cycles, in the range from about 1175 to 2425 cycles. For radio operation a Converter CV-2/TX is available to transform the amplitude modulated (AM) signal into a frequency modulated (FM) signal shifting from 1800 cycles for maximum signal to 3000 cycles for minimum signal. Alternatively this converter can be used for translating the FM signals back to AM signals at the receiver. Scanning is at the rate of 96 lines per inch at 90 rpm and a 7" x 7-3/8" picture may be sent in about 7 minutes. Facsimile Equipments RC-120-A and RC-120-B include minor improvements in design but can be used interchangeably on the same circuit with the RC-120 equipment.

1104. FACSIMILE SET AN/TXC-1. This is a page machine for transmitting weather maps and other copy as large as 12" x 17-1/2" in about 20 minutes. It uses Facsimile Transceiver TT-1/TXC-1, and either direct or photographic recording. Other technical features of the equipment are similar to those of the RC-120 equipment, but in view of the difference in picture sizes this equipment cannot be used interchangeably with RC-120 type equipments. In the AN/TXC-1 set, scanning is at the rate of 96 lines per inch at 60 rpm of the drum. The equipment is intended for fixed station use only. Unlike the RC-120 equipment, it includes no provision for operation from a 6-volt battery, no portable dark tent, and the photographic equipment is different. Converter CV-2/TX can be used with the AN/TXC-1 set, if desired.

1105. FACSIMILE EQUIPMENT - DESCRIPTION.

Nomenclature Name	Type No.	Fig. No.	Shown in	Component Parts	Weight Lbs.	In Operation Dimensions in Inches			KVA or Watts	T.M.	Remarks
						L	D	H			
Tape Facsimile Equipment	RC-58-B	1101							10 amps. at 12 volts dc	11-374	Equipment for transmitting copy generally in the form of band printing on a tape 3/4" wide, either over wire circuits or radio circuits. For use in vehicles or at fixed stations. In vehicles equipment is powered from 12 volt vehicle battery, at fixed stations from Battery BB-50 and Rectifier RA-54-A.
				Amplifier BC-908B	39	14-1/2	8-1/2	9-7/8			Includes scanner and recorder amplifiers and dynamotor.
				Amplifier Cover BC-128-B	0.8	15	8-5/8	9-1/2			Waterproof canvas cover. Permanently installed on portable unit for use in service.
				Amplifier Mounting FT-318-B	4	14-3/8	7-1/8	9-5/8			Base and rear wall support with rubber shock mountings.
				Cord CD-606-B	2.6	96					18 conductor shielded cable to interconnect amplifier and recorder-scanner.
				Cord CD-608-B	1.7	102					2 conductor shielded DC power cord.
				Cord CD-1018	0.5	120					2 conductor shielded receiver cord. Has Plug PL-55.
				Cord CD-1019	0.6	120					2 conductor shielded transmitter cord. Shield used as a 3rd conductor. Has Plug PL-68.
				Recorder-Scanner BC-918-B	35	11-5/8	11-3/8	10			Combination recorder unit for receiving and tape scanning unit for sending. Includes tape reel.
				Recorder-Scanner Cover BC-118-B	0.8	11-3/4	11	9-1/2			Waterproof canvas cover. Permanently installed on portable unit for use in service.
				Recorder-Scanner Mounting FT-328-B	3.7	11-1/4	8	9-5/8			Base and rear wall support with rubber shock mountings.
				Recorder Tape M-298 (48 rolls) per roll	0.9	3/4	7 diam.				Tape for either sending or receiving purposes.
				Spare Parts Chest CH-108-B	9	14-3/4	9	8-3/4			Contains 4 rolls extra tape, fuses, vacuum tubes, vibrator and other replaceable parts. Weight is for chest alone, not including spare parts.
				Writing Stand MC-308-B	2	9-1/4	8-1/2	1-1/4			Flat metal box holding 1 roll of tape and having writing guides.
				2 Copies of TM 11-374							
Rectifier RA-54-A		1101			68	18	16-1/2	9	450 watts	11-374	Selenium type for charging 12-volt Battery BB-50 from 115 volt 60 cycle ac.
Battery BB-50		1101			64	12-7/8	7-1/8	9-7/8		11-374	12 volt storage battery for supplying equipment RC-58-B in fixed installations.

Nomenclature Name Type No. Fig.No.	Shown in	Component Parts	Weight Lbs.	In Operation Dimensions in Inches			KVA or Watts	T.M.	Remarks
				L	D	H			
Facsimile RC-120 Equipment	1102						11-375B	Page 7 x 7-3/8" can be transmitted in 7 min. For use on wire or short radio circuits on AM basis or in combination with Converter CV-2/FX on longer radio circuits on FM basis. Either direct or photographic recording process may be used. Connects to line thru telephones, not included. Includes drive motor, scanning drum, amplifiers, connecting cords and line connecting coils. Scans at 96 lines per inch at 90 rpm. For use on 100 to 150 volt, 50 to 65 cycle ac.	
Facsimile Transceiver FX-1			60	22	12	10			
Power Supply PE-140			50	12	12	10	250 watts		
Power Supply PE-150			60	14	8-3/4	11-1/2			
Chest CH-117			112	27-1/4	19	13		6 volt storage battery, battery case and a charger. For emergency operation of transceiver on battery. Battery drain 28 amps. (Not provided with RC-120-A or RC-120-B). Carrying case for Facsimile Transceiver FX-1. (Weight includes unit).	
Chest CH-116			105	27	16-1/4	16-3/4		Carrying case for Power Supply PE-140. Also carries 1000 sheets of Teledeltos paper, running spare tubes for FX-1 and PE-140, 2 developing tanks PH-409 and 3 pads of message paper. Includes Bag EG-140 (portable dark tent) in Bag EG-122 and Frame FM-60 in Bag EG-126. Also Bag EG-124 (Duffle bag to contain all other bags). Also includes photographic chemicals, films, paper and supplies in Case PH-410 and tanks in Chest CH-116.	
Photographic Equipment PH-411			85	28	13	14			
TM 11-375B							11-375B		
Facsimile RC-120-A Equipment	1102							Similar to equipment RC-120 and will work with same. Differs from FX-1 of RC-120 in apparatus details. Differs from PE-140 of RC-120 in apparatus details. Same as for RC-120. Same as for RC-120. Same as for RC-120.	
Facsimile Transceiver FX-1-A			60	22	12	10			
Power Supply PE-140-A			50	12	12	10	250 watts		
Chest CH-117			112	27-1/4	19	13			
Chest CH-116			105	27	16-1/4	16-3/4			
Photographic Equipment PH-411			85	28	13	14			
TM 11-375B									

Table continued on next page

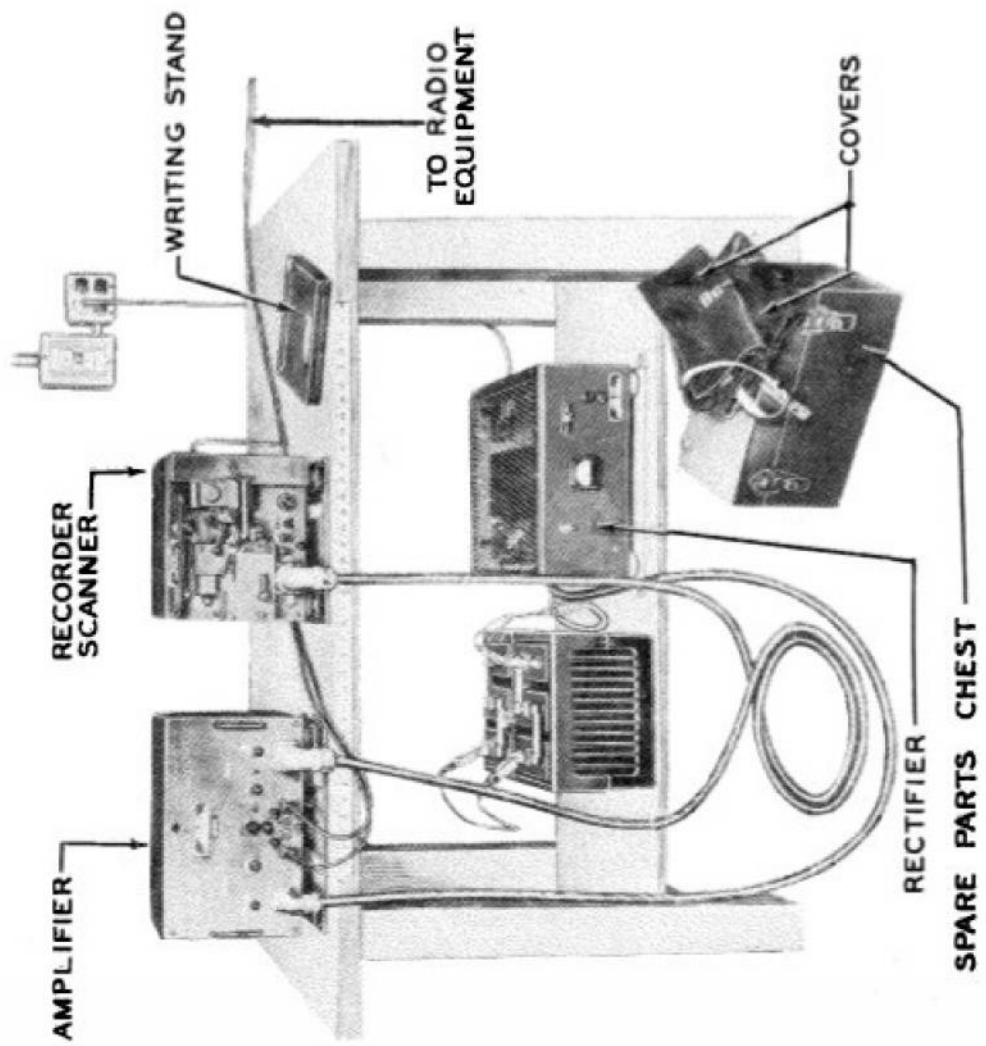

FIGURE 1101. Tape Facsimile Equipment RC-58-B

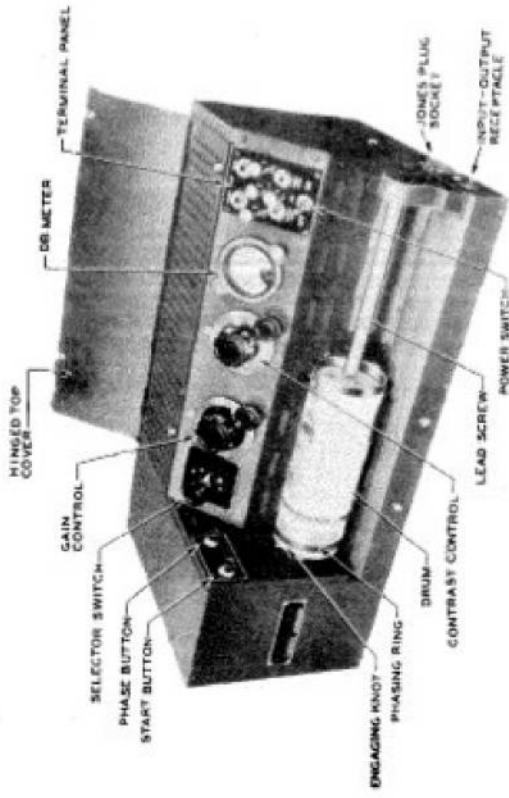

FIGURE 1103. Facsimile Transceiver FX-1-B

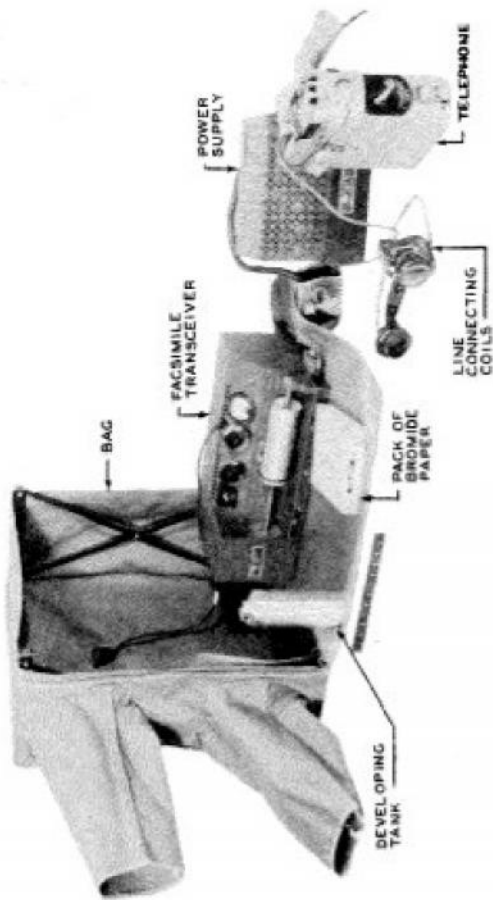

FIGURE 1102. Facsimile Equipment RC-120

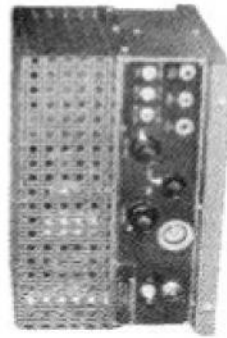

FIGURE 1104. Converter CV-2/TX

1106. FACSIMILE EQUIPMENT - STOCK NUMBERS AND LOGISTICAL DATA.

Nomenclature			Heaviest Pkg.		Total Weight		Total	
Name	Type No.	Stock No.	Packed for Export	In Carrying Case	Packed for Export	In Carrying Case	Packed for Export	In Carrying Case
Tape Fac- simile Equipment	RC-58-B ^a	6C25-58B	350 ^c	255	350 ^c	255	30 ^c	20
Rectifier	RA-54-A	3H4684		99		99		3.2
Battery	BB-50	3B50		64		64		1
Facsimile Equipment	RC-120 ^b	6C25-120	146	113	500	390	22	13
Facsimile Equipment	RC-120-A ^b	6C25-120-A	146	113	417	322	20	11.5
Facsimile Equipment	RC-120-B ^b	6C25-120-B	146	113	417	322	20	11.5
Facsimile Set	AN/TXC-1 ^b							
Converter Case	CV-2/TX CY-56/TX	2C720-2) 221891-56)	113	53	113	53	3.5	2.3

^aFor fixed installations also requires Rectifier RA-54-A and Battery BB-50.

^bFor long radio circuits also requires Converter CV-2/TX with Case CY-56/TX

^cEstimated.

1107. EXPENDABLE SUPPLIES.

Nomenclature		Expendable Supplies	Stock No.
Name	Type No.		
Tape Facsimile Equipment	RC-58-B	Recorder Tape	-
Facsimile Equipment	RC-120-()	Teledeltos Paper (1000 sheets) Film Type A Developer-Powder D-72 (quart size) Developer-Powder DK-60A (gallon size)	6M877 8D50-1 8C14-1 8C48-1
Facsimile	AN/TXC-1	Teledeltos Paper Film Photographic chemicals	- - -

This Page Intentionally Blank

CHAPTER 12
POWER EQUIPMENT

Section I
General

1201. SCOPE AND USE.

a. This chapter gives descriptive information on power equipment which can be used to supply power to any tactical or fixed plant equipment communication system.

b. Although very often the power equipment is a part of a particular communication system, in many cases, however, its design is not necessarily confined to such a system. For the most part its design is such that it can be used universally to supply power for various types and kinds of load within its particular capacity, which insures that its field of use is not limited to any particular communication system.

c. The information on the power equipment is divided into five parts as follows:- section II Engine Driven Generator Sets, section III Rectifiers, section IV Power Ringing Units, section V Batteries.

d. A summary of the prevailing electrical frequencies, voltages and other characteristics of commercial power supplies throughout the world is given in section VI.

Section II
Engine Driven Generator Sets

1202. GENERAL.

a. The engine driven generator sets for tactical use are designed to deliver either direct current or alternating current of the proper voltage and capacity as required for the operation of the associated communication systems. The direct current sets vary in capacity from 0.25 KW to 0.75 KW while the capacity of the alternating current sets vary from 0.3 KW to 10 KW

b. The engine driven generator sets for use in the fixed plant range in capacity from 0.75 KW to 100 KW. Except for PE-167-A they generate single phase or three phase alternating current of the required voltage

1203. DESCRIPTION OF TACTICAL ENGINE GENERATOR SETS.

a. The engine driven generator sets when used with tactical communication systems are necessarily designed to be readily portable. The assembly consists of the engine, generator, base, control panel and fuel tank so as to form a complete self contained power unit. In general the larger capacity sets are mounted

on skid type metal bases and are enclosed in sheet metal housing with removable sides, while the smaller capacity sets are mounted on a wooden base to which a wooden crate can be fastened by snap latches when the set is not in use. All engines use gasoline for fuel and a number of the light weight sets use a two cycle engine. Descriptions of these sets are given in paragraph 1207.

b. This same list of engine driven generator sets has been arranged in accordance with the magnitudes of their power output in paragraph 1208.

1204. STOCK NUMBER & LOGISTICAL DATA FOR TACTICAL ENGINE GENERATOR SETS

Paragraph 1209 gives stock number and logistical data for the engine driven generator sets listed in paragraph 1207.

1205. DESCRIPTION OF FIXED PLANT ENGINE GENERATOR SETS.

a. The engine driven generator sets for this type of installation are, in general, designed to mount on concrete or heavy wooden bases located inside a building or shelter to protect them from the weather. All sets are equipped with fuel pumps permitting the use of a separate fuel tank, which may be a small tank located adjacent to the engine or a buried tank for supplying one or more of the larger capacity sets. The fuel tanks, except for a few of the smaller capacity units, are not furnished as part of the sets. For the sets of 10 KW capacity and above a separate control panel is furnished as part of the power unit. The sets of 15 KW output and more, with the exception of the 35 KW set, are driven by Diesel engines, all the other sets use gasoline for fuel.

b. The exceptions to the above general descriptions are the PE-95-F and the PE-235-A, which are mounted on skid type metal bases and enclosed by a sheet metal housing with removable sides. The control panel, fuel tank and starting storage battery are mounted inside the housing. The assembly thus forms a self contained power unit, which can be used in the open, if found desirable to do so. The descriptions of these sets are listed in paragraph 1210.

c. Paragraph 1211 shows the fixed plant engine generator sets arranged by capacities.

1206. STOCK NUMBERS AND LOGISTICAL DATA FOR FIXED PLANT ENGINE GENERATOR SETS.

Paragraph 1212 gives the stock numbers and logistical data for the engine driven generator sets listed in paragraph 1210.

1207. ENGINE GENERATOR SETS - TACTICAL - DESCRIPTION

Type No.	Fig. No.	Net Wt. lbs.	Approx. Size in			Gen. Mfr. Code	KVA	PF	KW	Generator ^a			Rated Volts DC	Volt Reg.	No. Wires	Control Panel on Set
			Oper. - In.	L	H					W	Rated Volts AC	RPM				
FE-45-HH	-	137	23	22	20	FIO		0.55				32	INH	2	No	
FE-45-HJ	-	130	23	25	20	FIO		0.55				32	INH	2	No	
FE-45-HX	-	100	23	15	24	FIO		0.55				32	INH	2	No	
FE-49-D,-F,-G & -H	-	257	36	22	17	COM		(0.55) (0.56)		2750		1000) 14.6)	RHSD	8 Cond. Plug	Yes	
FE-75-D,-G,-H,-J,-K,-P,-S,-T,-U,-AA,-AB & -AC	1201	330	36	26	19	LEL	2.5	1.0	2.5	120	1800	1	INH	(Two-) (2 Wire) (Reeps)	No	
FE-77-A to -C	1202	72	20	22	16	FIO		0.25					115	Comp. Wound	(Two-) (2 Wire) (Reeps)	No
FE-77-D & -E		86	22	22	12	FIO		0.25					115			
FE-95-A,-B & -C	1203	1360	73	39	27	OMA			5.0	115		1	INH	2	Yes	
FE-95-G & -H	1205	1556	68	39	28	OMA	(12.5 12.5)	(1.0 0.8)	(10 5)	120/240) 120/240)		1	INH	2 or 3	Yes	
FE-99-A,-B,-D,-E & -F	1204	1150	60	42	28	(GEC (ACE (FSE (COM	7.5	1.0	7.5	120	1800	3	Yes	3	Yes	
FE-109-A,-B & -C	1205	250	30	27	28	FIO	0.6	1.0	0.6	110		1	12.5	(7% (INH (Plug	7 Cond.	
FE-109-D & -E		250	30	27	28	FIO	0.6	1.0	0.6	110		1	12.5	(7% (INH	Yes	
FE-162-A	1208	40	19	11	14	EMS			0.25				(.4A-500V) (7.5A-7V)			
FE-197-A	1206	790	44	31	22	HOB	6.2	0.8	5	120		1	Yes	2	Yes	
FE-201-A,-B & -C	1207	341	36	24	19	LEL	(0.7 (0.3)	1.0	(0.7 0.3)	115	1800		14.5	INH	(Two-) (2-Wire) (Reeps)	Yes
FE-210-B		60	18	11	14	EMS			0.45				7 to 22	INH		Yes
FE-214-A	1208	40	18	11	14	EMS	0.3	1.0	0.3	120/240		1			(One-)	
FE-214-B	1209	56	18	11	14	EMS	0.3	1.0	0.3	120/240		1			(2 Wire) (Reep)	
FU-8/TTQ-1		383	44	40	22	OMO	3	1.0	3	115	1800	1	INH	2	Yes	

GENERATOR MANUFACTURER'S REFERENCES

Manufacturer	Address	Reference
American Custom Built Motor	Chicago, Ill.	ABC
Continental Electric Company	Newark, N. J.	COM
Electric Motor & Specialities Company	Ft. Wayne, Ind.	EMS
F. S. Electric Company	Memphis, Tenn.	FSE
General Electric Company	Ft. Wayne, Ind.	GEC
Hobart Bros.	Troy, Ohio	HOB
Leland Electric Company	Dayton, Ohio	LEL
D. W. Ogan & Sons	Minneapolis, Minn.	OMO
Pioneer Gen-&Motor Corp.	Chicago, Ill.	FIO

^aAll a-c generators operate at 60 cycles.

Engine ^b											TM or Instr. Book	Remarks
Eng. Mfr. Code	Mod.	No. Cyl.	No. Cvs.	HP	RPM	Ca. In. Displ.	Cooling	Starting	Gal. Hrly Fuel Cons.	How Connected		
BMS	AP	1	4	1.95	2350	9.0	A	Man.	0.25	Dir.	TM 11-302H	PE-45 in part of Bat. Chg. Set SCR-169. Consists of PE-45, Panel HD-17-61 and Cord CD-107. PE-45 mtd. on crate platform base & equipped with cover attached by 4 snap latches.
WIS	AB	1	4	2.85	2350	15.5	A	Man.	0.25	Dir.		
JAC	J-150	1	2	1.55	2350	7.0	A	Man.	0.25	Dir.		
WIS	ARS	1	4	3.6	2750	15.5	A	Elect.	0.25	Dir.	TM 11-920 (F only covered)	Mtd. on skid type base. Has wooden hood base & hood with 4 drawbolts latches & 4 handles. Control panel equipped with ammeter, field switch, field rheostat, starter button and terminals for charging batteries from 14.6 volt winding.
BMS	ZZ	1	4	6.5	2400	22.9	A	Man.	0.65	Belt	TM 11-900	Mtd. on skid type base. Tools & spare part box mtd. on top of gen.
BMS	IL	1	4	1	2700	4.7	A	Man.	0.12	Dir.	TM 11-905	Mtd. on wood base, equipped with crate cover.
BMS	W	1	4	1.5	2700	6.2	A	Man.	0.12	Dir.		
Ford	OHV	4	4	19	1200	119.7	W	Elect.	1.2	Dir.	TM 11-904H	Mtd. on skid type base. Enclosed in sheet metal housing with removable sides. Control panel, fuel tank & bats. mtd. inside the housing. Generator output depends upon power factor of load.
WIL	JP441	4	4	31	1800	134.2	W	Elect.	1.2	Dir.		
WIS	VE-4	4	4	20	2200	91.5	A	Elect.	1.7	Belt	TM 11-925	Mtd. on skid type base. Bats & control panel mtd. on base. Cont. panel equipped with 3 ammeter, voltmeter & voltmeter switch, circuit breaker, freq. meter, voltage reg. bat. chg. ammeter, time meter, two 2-wire reccs, 1 3-wire recp. & 5 power term. studs. Replaced by PE-197.
WIS	AA	1	4	1.4	1800	10.9	A	Elect.	0.5	Dir.	TM 11-927	Mtd. on crate base with crate cover fastened by 4 clamp latches. Cover has 4 handles. Control panels for all sets have a-c voltmeter, 2 reccs., magnetic starting switch, bat. cutout rel. & filter coils.
WIS	AB	1	4	2.5	1800	15.5	A	Elect.	0.4	Dir.		
JAC	J-100	1	2	1	3600	4.7	A	Man.	0.1	Dir.		
HER	ZXB	4	4	13.5	1800	65	W	Elect.	1.1	Dir.	TM 11-940	Mtd. on skid type base. Enclosed in sheet metal housing with removable sides. Control panel, fuel tank & bats. mtd. inside the housing. Incl. cable, tools and spare bat. Replaces PE-99.
BMS	B	1	4	5.5	2400	14.2	A	Man.	0.5	Belt	TM 11-941	Mtd. in pipe framework. Output limited to 1 KW; for example, 700 watts AC and 300 watts DC or 1000 watts AC and no DC or combination thereof. No longer procured. Replaced by PE-1.
JAC	J-100	1	2	1	3000	4.7	A	Elect.	0.1	Dir.		Tubular loop frame and canvas cover. Continuously variable from 7 to 22V. Includes meters (V. and Ampe.)
JAC	J-100	1	2	1	3600	4.7	A	Man.	0.1	Dir.	TM 11-915	Replaced by PE-214-B. Tubular loop frame. Includes tool and spare parts box and 1 gal. gas tank. Replaces PE-214-A.
JAC	J-100	1	2	1	3600	4.7	A	Man.	0.1	Dir.		
ONO	W-3M	2	4	7	1800	58.8	W	Man.	0.8	Dir.	TM 11-932	Part of Operations Center AN/TTQ-1.

ENGINE MANUFACTURER'S REFERENCES

Manufacturer	Address	Reference
Briggs & Stratton Corp.	Milwaukee, Wis.	BMS
Ford Motor Company	Detroit, Mich.	Ford
Jacobsen Manufacturing Co.	Racine, Wis.	JAC
Hercules Motors Corp.	Canton, Ohio	HER
Willy-Overland Motors	Toledo, Ohio	WIL
Wisconsin Motor Corp.	Milwaukee, Wis.	WIS

^b Gasoline used in all types. Magneto ignition is employed in all sets except PE-95-G & H which employ battery ignition.

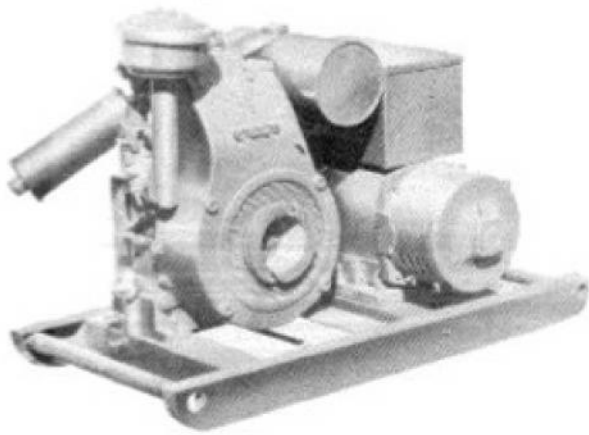

FIGURE 1201. Power Unit
PE-75-D

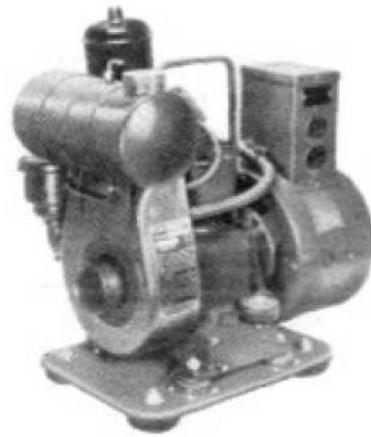

FIGURE 1202. Power Unit
PE-77-B

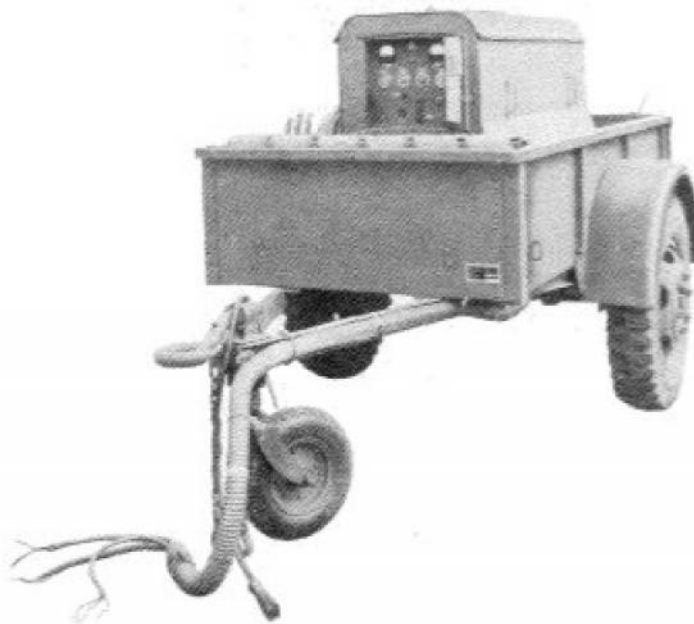
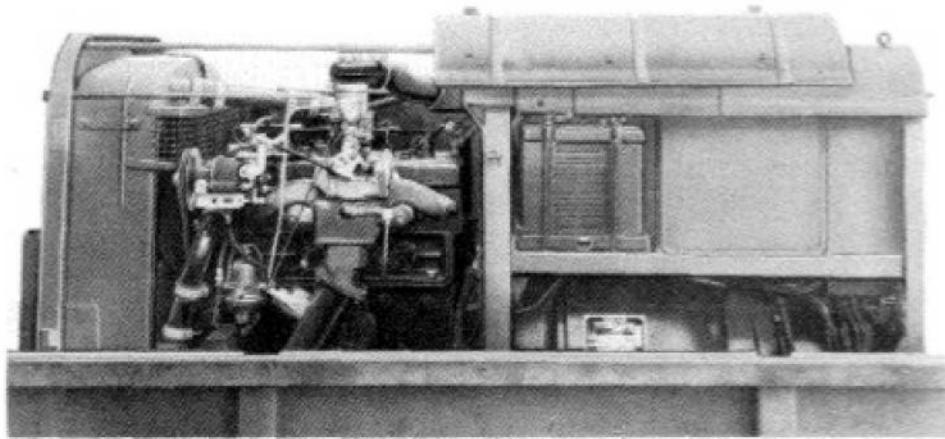

FIGURE 1203. Power Unit PE-95-()
Part of Trailer K-52-()

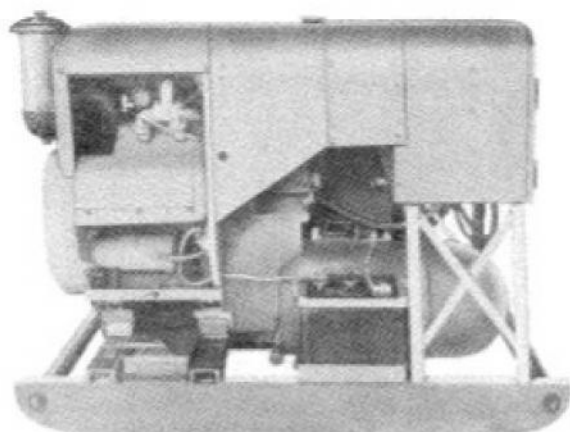

FIGURE 1204. Power Unit PE-99-E

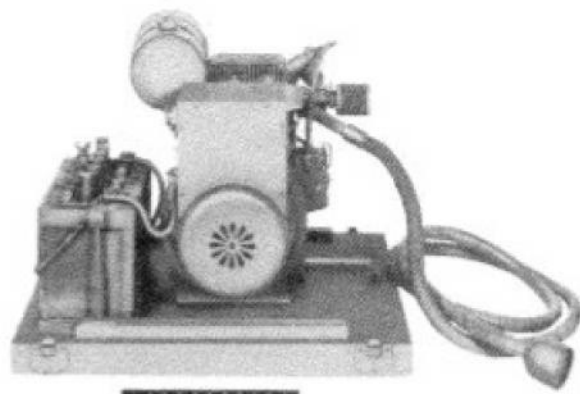

FIGURE 1205. Power Unit PE-106-A



FIGURE 1206. Power Unit PE-197

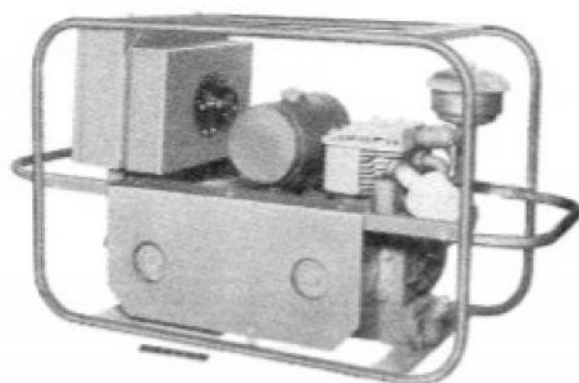

FIGURE 1207. Power Unit PE-201-B

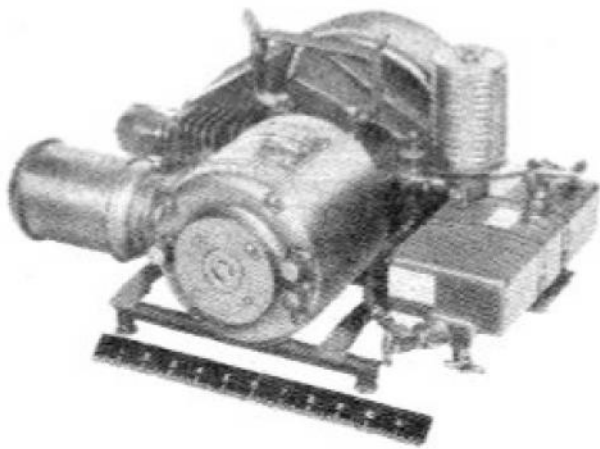

FIGURE 1208. Power Unit PE-214-A

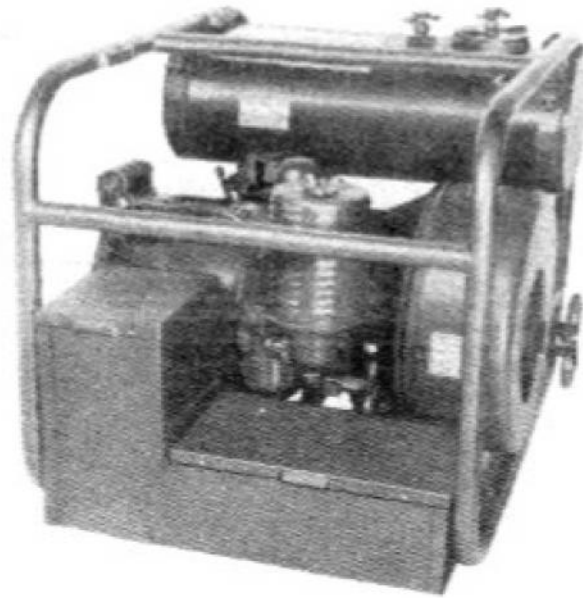

FIGURE 1209. Power Unit PE-214-B

1208. ENGINE GENERATOR SETS - TACTICAL - ARRANGED BY CAPACITIES.

KW	Nomenclature Type No.	Volts		PH	Wires
		D-C	A-C		
0.25	PE-77-()	115			2
0.25	PE-162-A	500/7			4
0.3	PE-214-()		120/240	1	2
0.45	PE-210-B	7 to 22			2
0.55	PE-43-()	32			2
0.6	PE-108-()		115	1	7 Cond. Plug
0.71	PE-49-()	14.6/1000			1 & 8 Cond. Plugs
1.0	PE-201-()	14.5	115	1	4
2.5	PE-75-()		120	1	2
3.0	PU-8/TFQ-1		115	1	2
5.0	PE-95-A, -B, & -C		115	1	2
5.0	PE-95-G & H		120/240	1	2 or 3
5.0	PE-197-A		120	1	2
7.5	PE-99-()		120	3	3
10.0	PE-95-G & -H ^b		120/240	1	2

^aAll a-c generators operate at 60 cycles.

^bPE-95-G & -H is 10 KW at unity power factor or 5 KW when power factor is 0.8.

1209. ENGINE GENERATOR SETS - TACTICAL - STOCK NUMBERS AND LOGISTICAL DATA.

Nomenclature Type No.	Stock No.	Weight (lbs.) Heaviest Package		Total Weight (lbs.)		Total Volume Cubic Feet		Ship Tons ^a
		Packed for Export	In Carry- ing Case	Packed for Export	In Carry- ing Case	Packed for Export	In Carry- ing Case	
PE-43-BE	3B4543-7	270	180	270	180	10	7.4	0.3
PE-43-BJ	3B4543 (BJ)	260	170	260	170	10	7.4	0.3
PE-43-BK	3B4543 (BK)	220	140	220	140	7	5	0.2
PE-49-D,F, G or H	3B4549D,F,G, or H	495	300	495	300	20.2	13	0.5
PE-75-D,G,H, J,K,P,S,T, U,AA,AB, or AC.	3B4575D,G,H, J,K,P,S,T,U, AA,AB, or AC	445	No Case	445	No Case	16	No Case	0.4
PE-77-A,B,C, D, & E	3B4577A,B,C, D, or E	225	110	225	110	7.5	5	0.2
PE-95-A,B,& C	3B4595A,B or C	1700	No Case	1700	No Case	84	No Case	2.1
PE-95-G & H	3B4595G or H	1800	No Case	1800	No Case	84	No Case	2.1
PE-99-A,B,C, E, & F	3B4599A,B,C, E, or F	1592	No Case	1592	No Case	76	No Case	1.9
PE-108-A,B,C, D, & E	3B4600-108 A,B,C,D, or E	429	277	429	277	18.1	13	0.5
PE-162-A ^b	3B4600-162A	132	87	132	87	7.2	4.1	0.2
PE-197-A	3B4600-197A	1240	No Case	1261	No Case	56	No Case	1.4
PE-201-A,B, & C	3B4600-201A, B, or C	450	No Case	450	No Case	17	No Case	4
PE-210-A ^b	3B4600-210A	140	95	140	95	7.2	4.1	0.2
PE-214-A ^b	3B4600-214A	132	87	132	87	7.2	4.1	0.2
PE-214-B ^b	3B4600-214B	140	95	140	95	7.2	4.1	0.2
PU-8/TTQ-1	3B4531-8	1000	No Case	1100	No Case	56	No Case	1.4

^aA ship ton = 40 cu. ft.

^bFor two PE-162-A, two PE-210-A or two PE-214-A or B in Export Box (without Carrying Case) weight is 160 lbs., cubic feet is 7.0.

1210. ENGINE GENERATOR SETS - FIXED PLANT - DESCRIPTION

Type No. ^b	Fig. No.	Net lbs.	Approx. Dimen. in Oper. - In.			Mfr. Code	Generator ^a			Rated Volts	Phase	Volt Reg.	No Wires	Control Panel on Set
			L	H	W		kVA	FF	kW					
FE-78-A,-B,-C	-	1850	80	39	28	FID	12.5	0.8	10	120/240	1	Yes	5	No
FE-78-F	1210	2050	84	45	28	COL	12.5	0.8	10	120/240	1	Yes	3	No
FE-78-H	1210	2050	84	45	28	COL	12.5	0.8	10	120/240	1	Yes	3	No
FE-79-D & -E	-	1870	81	45	28	ACB	12.5	0.8	10	240	5	Yes	5	No
FE-79-F	1211	1680	81	45	28	WES	12.5	0.8	10	240	5	Yes	3	No
FE-81-E	1212	3705	100	51	52	COL	43.7	0.8	35	240	3	Yes	5	No
FE-81-F	-	3705	100	5	52	COL	43.7	0.8	35	240	3	Yes	3	No
FE-85-F	1213	5100	95	63	38	CCM	31.2	0.8	25	120/208	3	Yes	4	No
FE-85-L	1214	3690	95	52	34	RDA	31.2	0.8	25	250	3	Yes	3	No
FE-85-M	1215	3950	89	61	35	CCM	31.2	0.8	25	250	3	Yes	3	No
FE-95-F	1216	1545	75	59	31	OMA	6.2	0.8	5	120/240	1	Yes	2/3	Yes
FE-142-B	-	5700	110	67	41	EM	62.5	0.8	50	240	3	Yes	3	No
FE-142-C	1217	6500	114	75	59	EM	62.5	0.8	50	240	3	Yes	3	No
FE-142-D	1218	5700	110	67	41	EM	62.5	0.8	50	240	3	Yes	3	No
FE-142-E	1219	5700	110	67	41	EM	62.5	0.8	50	240	3	Yes	3	No
FE-148-A	1220	900	57	57	24	KAT	3	0.8	2.4	110/220	1	RRFD	2/3	No
FE-167-A	1221	75	19	16	15	AAP			(0.175 {0.350	6 12		RRFD		Yes
FE-205-A	1222	3000	92	51	30	GEC	18.7	0.8	15	120/240	1	Yes	3	No
FE-205-B	1223	3770	85	58	28	GEC	18.7	0.8	15	120/240	1	Yes	3	No
FE-207-A	1222	3000	92	51	30	GEC	18.7	0.8	15	120/208	3	Yes	4	No
FE-207-B	1223	3770	85	58	28	GEC	18.7	0.8	15	120/208	3	Yes	4	No
FE-215-A	1224	5600	119	60	41	GEC	62.5	0.8	50	240	3	Yes	3	No
FE-220-A & -B	1225	18670	194	108	65	WES	125	0.6	100	240	3	Yes	5	No
FE-231-A	1226	890	50	38	25	OMA	5	1.0	5	110/220	1	IMH	3	Yes
FE-236-A	1227	141	20	22	15	AAP	0.7	1.0	0.7	115	1	RRFD	2	Yes
FU-19/23C	1228	4200	96	59	32	IDB	25	0.8	20	120/240	1	Yes	3	No
OMAN-WSM-13	1229	450	35	31	18	OMA	3	1.0	3	115	1	IMH	2	No
Kohler IME1A	1230	496	45	37	18	KOH	1.5	1.0	1.5	110	1	IMH	2	Yes

GENERATOR MANUFACTURER'S REFERENCES

Manufacturer	Address	Reference
Atlas Aircraft Products Co.	New York, N.Y.	AAP
American Custom Built Motors	Chicago, Ill.	ACB
Columbia Electric Company	Cleveland, Ohio	COL
Continental Electric Co.	Newark, N.J.	CCM
Electrical Machinery Co.	Minneapolis, Minn.	EM
Fidelity Electric Company	Lancaster, Pa.	FID
General Electric Company	Pt. Wayne, Ind.	GEC
The Ideal Electric & Mfg. Co.	Mansfield, Ohio	IDB
Kato Electric Company	Munkato, Minn.	KAT
Kohler Company	Kohler, Wis.	KOH
D. W. Onan and Sons	Minneapolis, Minn.	OMA
Rogers Diesel & Aircraft Corp.	New York, N. Y.	RDA
Westinghouse Elec. & Mfg. Co.	E. Pittsburgh, Pa.	WES

^aAll generators are 60 cycles a-c except FE-167-A which provides 6 or 12 volts d-c.

^bDesignations other than FE and FU are manufacturer's codes.

^cInstruction books are issued by the manufacturer. See paragraph 1212 for stock numbers of Instruction Books.

Engine ^d											
Code	Model	Type	No Cyl	HP	RPM	Ca.In. Disp.	Igni-tion	Fuel Tank on Set	Gal Fuel Cons.	Tech. Man. or Instr.Book ^c	Remarks
HSR	QIB-5	Gas	6	47	1800	205	Bat.	No	2.00	Instr.Book)	Separate Control Panel is furnished. Fuel Tank is not included with set.
HSR	JIB-5	Gas	6	34.8	1800	265	Bat.	No	2.00	Instr.Book)	
HSR	JIB-5	Gas	6	34.8	1800	265	Bat.	No	2.00	TM 11-911)	
HSR	JIB-5	Gas	6	34.8	1800	265	Bat.	No	2.00	Instr.Book)	Same as for PE-78
COW	F-226	Gas	6	32.7	1800	226	Bat.	No	2.00	TM 11-912F)	
HSR	KILC	Gas	6	65.4	1800	529	Bat.	No	5.00	Instr.Book)	Same as for PE-78
HSR	KILD	Gas	6	90	1800	558	Bat.	No	5.00	Instr.Book)	
CUM	MI-600	Diesel	4	60	1200	448		No	3.00	Instr.Book)	Same as for PE-78
HIL	C-R	Diesel	6	54.7	1800	318		No	3.00	TM 11-916)	
INT	UD-9	Gas/ Diesel	4	46	1800	334	Mag.	No	3.00	TM 11-916B)	
WIL	JP-441	Gas	4	34	1800	134	Bat.	Yes	1.1	TM 11-904	Wtd. on base and enclosed in metal casing with removable sides. Control panel fuel tank and bat. are mtd. inside of casing.
CUM	HI-600	Diesel	6	90	1200	672		No	5.0	Instr.Book)	Same as for PE-78, PE-143C has super charger for high altitude location.
CUM	HIS-600	Diesel	6	108	1200	672		No	5.0	Instr.Book)	
CUM	HI-600	Diesel	6	90	1200	672		No	5.0	TM 11-942D)	
CUM	HI-600	Diesel	6	90	1200	672		No	5.0	TM 11-942E)	
WIT	VD-11	Diesel	1	4	1200	57		No	0.5	Instr.Book	Concrete base is recommended.
BIS	NP	Gas	1	1.4	2350	6	Mag.	Yes	0.2	TM 11-946	Bat. charging set. Wooden base for mtg. must be obtained locally. Separate fuel tank and line are furnished. 6 or 12 volts d-c.
HIL	4R	Diesel	4	27	1200	212		No	1.6	Instr.Book)	Same as for PE-78
INT	UD-9	Gas/ Diesel	4	46	1200	334	Mag.	No	1.6	Instr.Book)	
HIL	4R	Diesel	4	27	1200	212		No	1.6	Instr.Book)	Same as for PE-205-A & -B
INT	UD-9	Gas/ Diesel	4	46	1200	334	Mag.	No	1.6	Instr.Book)	
INT	UD-16	Diesel	6	92	1200	691		No	6.0	TM 11-941	Same as for PE-78
MAU	1-1286	Semi-Diesel	6	262	900	2094	Mag.	No	12.2	Instr.Book	Same as for PE-78 PE-220-B for high altitude locations.
COW	T-91	Gas	4	17.1	1800	90	Bat.	Yes	1.2	Instr.Book	Wtd. on skid base & enclosed in metal casing with removable sides. Control panel, fuel tank & bats. mtd. inside casing.
B&S	BP	Gas	1	2	1800	14	Mag.	No	0.3	Instr.Book	Separate fuel tank & fuel line are furnished. Wooden base for mtg. must be obtained locally.
INT	UD-9	Gas/ Diesel	4	46	1200	334	Mag.	No	2.5	Instr.Book	Fuel tank is not included. Separate control panel furnished with set.
OSM	WSM	Gas	2	7	1800	39	Mag.	No	1.0	Instr.Book	Base for mtg. must be furnished locally. Separate fuel tank & fuel line are furnished.
KOH	IM-21	Gas	4	3.2	1800	38	Mag.	No	0.4	TM 11-935	Eng. base has 4 holes for mtg. on concrete or heavy wooden base furnished locally.

ENGINE MANUFACTURER'S REFERENCES

Manufacturer	Address	Reference
Briggs & Stratton Corp.	Milwaukee, Wis.	B&S
Continental Motors Corp.	Muskegon, Mich.	COW
Cummins Engine Company	Columbus, Ind.	CUM
Hercules Motors Corp.	Canton, Ohio	HSR
Hill Diesel Engine Company	Lansing, Mich.	HIL
International Harvester Co.	Chicago, Ill.	INT
Kohler Company	Kohler, Wis.	KOH
D. W. Oram & Sons	Minneapolis, Minn.	OSM
Waukesha Motor Company	Waukesha, Wis.	MAU
Willy-Overland Motors	Toledo, Ohio	WIL
Witte Engine Works	Kansas City, Mo.	WIT

^dAll are 4 cycle engines. All are water cooled except PE-167-A, PE-226-A which are air cooled. All are directly connected to generator except PE-143-A which is belt connected. Starting is electrical for all except PE-220-A & -B which are started by gas engine and PE-226-A, Oram-WSM-13 and Kohler IM21A which are started manually.

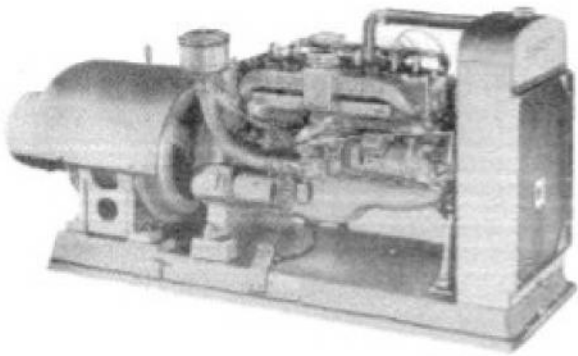

FIGURE 1210. Power Unit PE-78-F

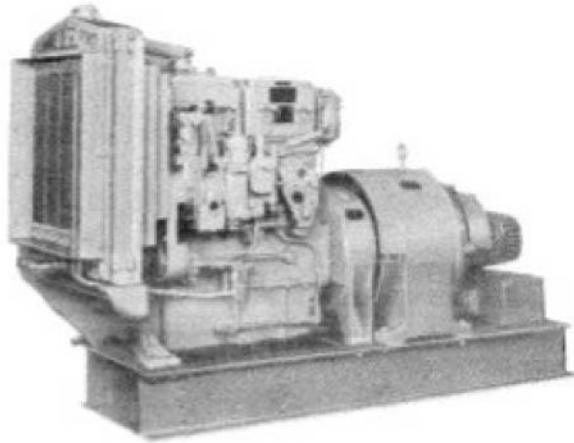

FIGURE 1213. Power Unit PE-85-F

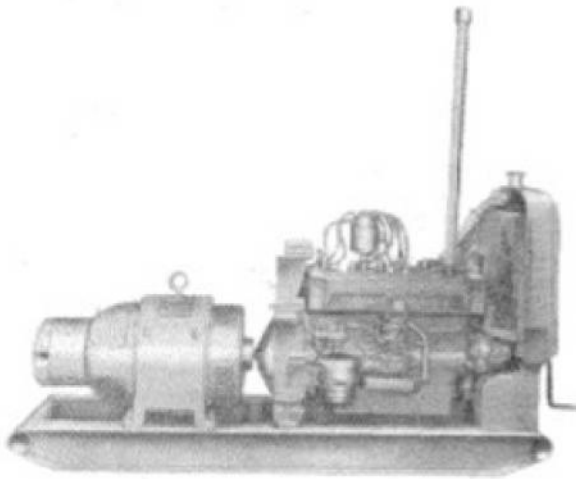

FIGURE 1211. Power Unit PE-79-F

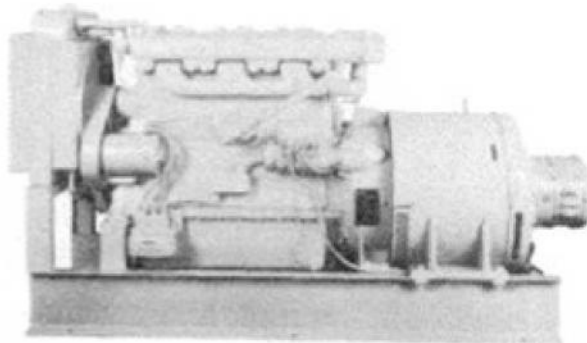

FIGURE 1214. Power Unit PE-85-L

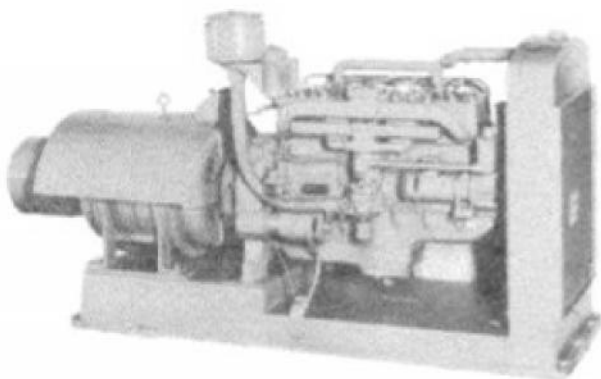

FIGURE 1212. Power Unit PE-81-E

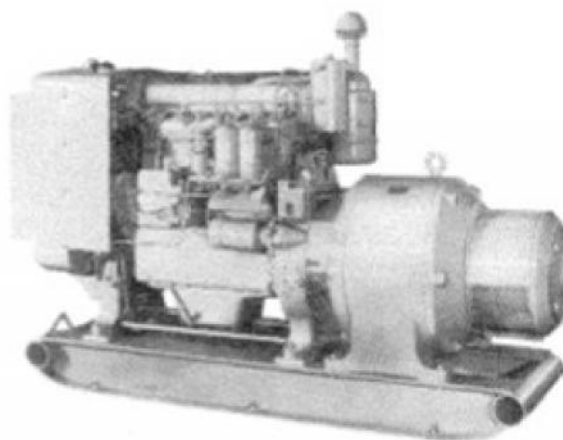

FIGURE 1215. Power Unit PE-85-M

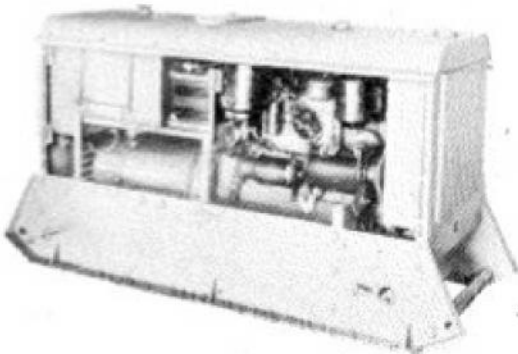

FIGURE 1216. Power Unit PE-95-F

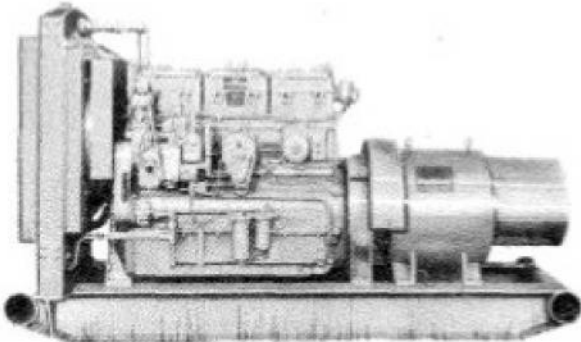

FIGURE 1219. Power Unit PE-142-E

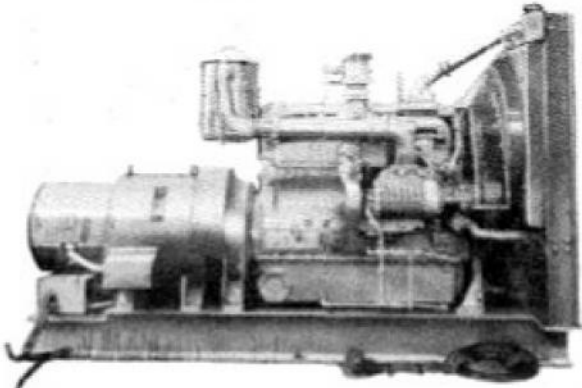

FIGURE 1217. Power Unit PE-142-C

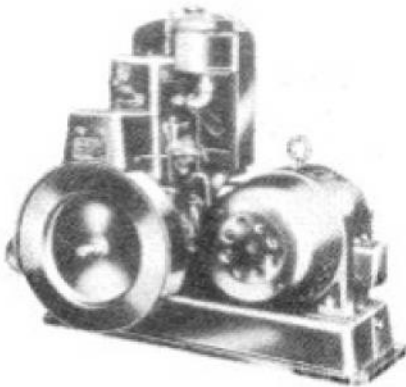

FIGURE 1220. Power Unit PE-148-A

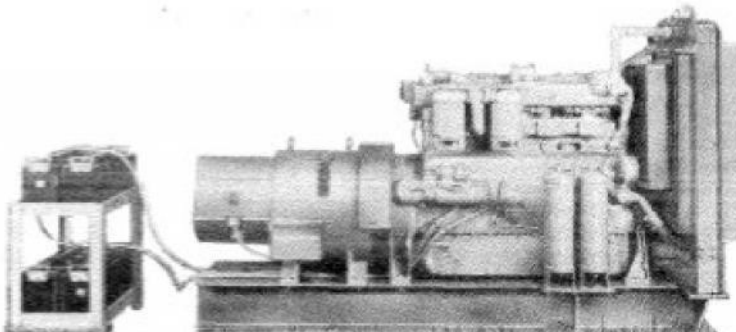

FIGURE 1218. Power Unit PE-142-D

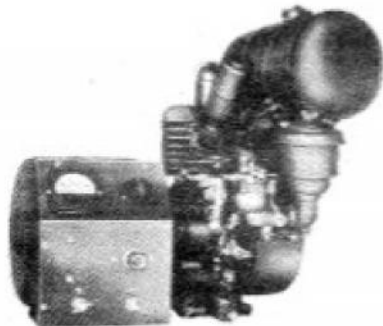

FIGURE 1221. Power Unit PE-167-A

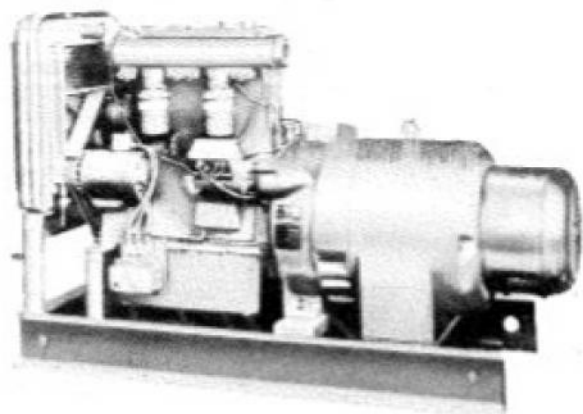

FIGURE 1222. Power Unit PE-205-A
or PE-207-A

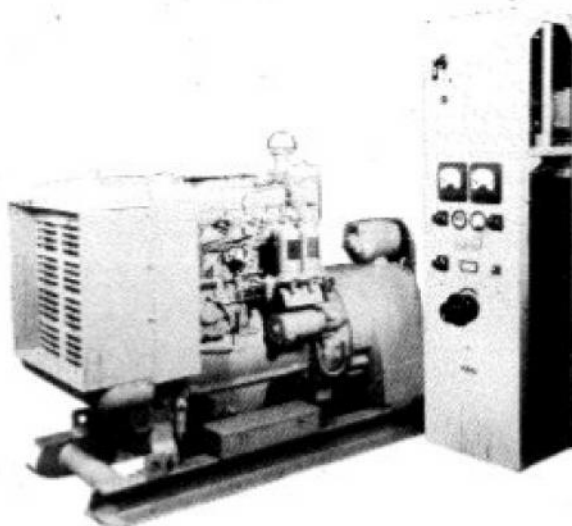

FIGURE 1223. Power Unit PE-205-B

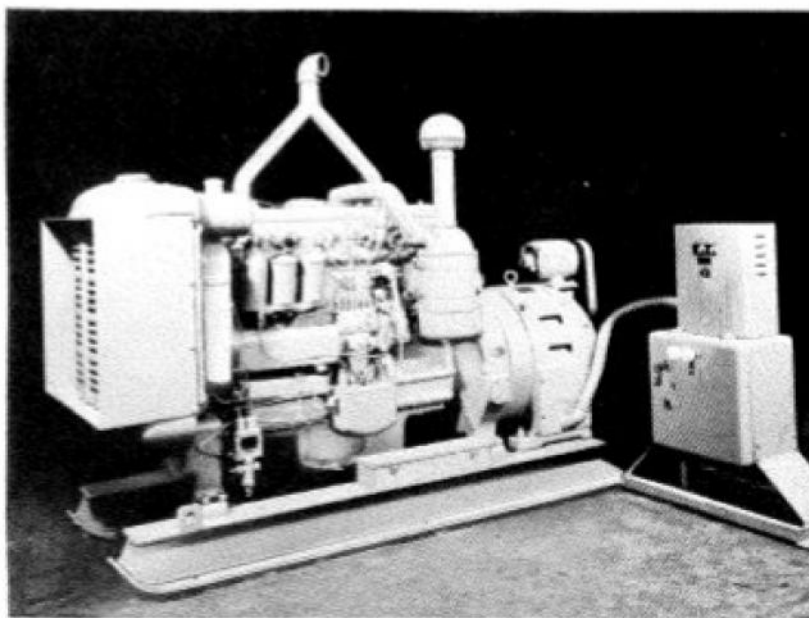

FIGURE 1224. Power Unit PE-215-A

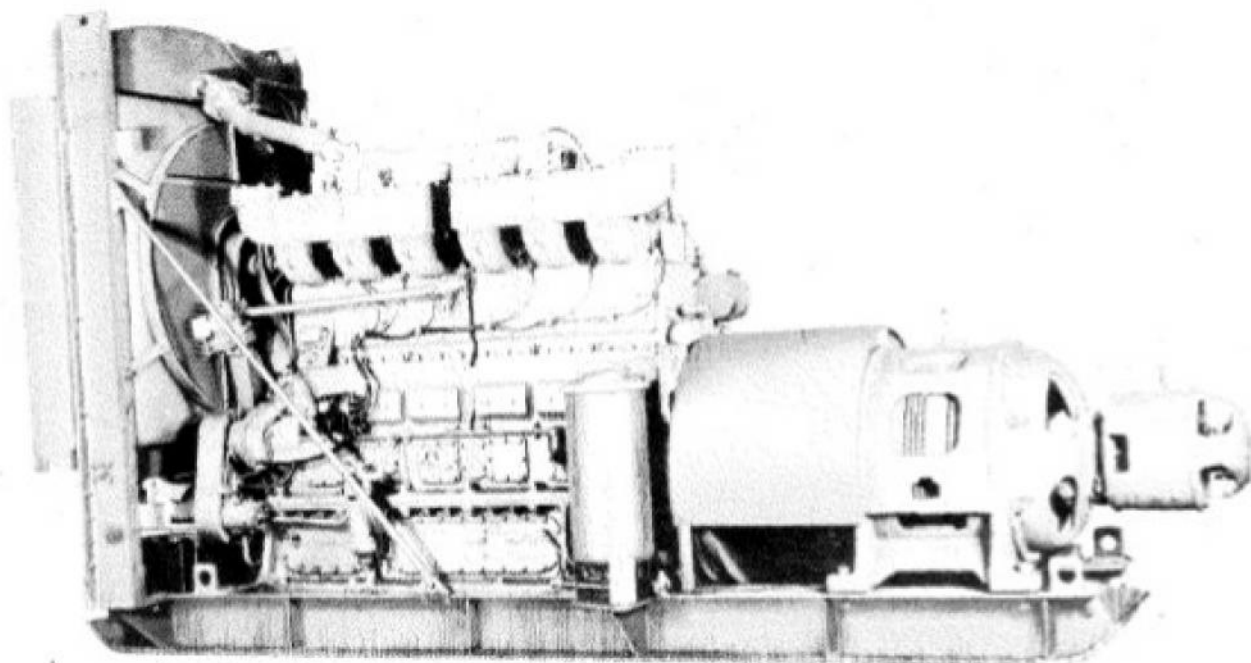

FIGURE 1225. Power Unit PK-220-A or B

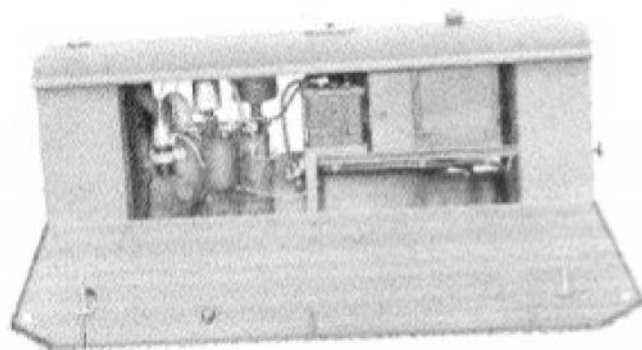

FIGURE 1226. Power Unit PK-235-A



FIGURE 1227. Power Unit
PE-236-A

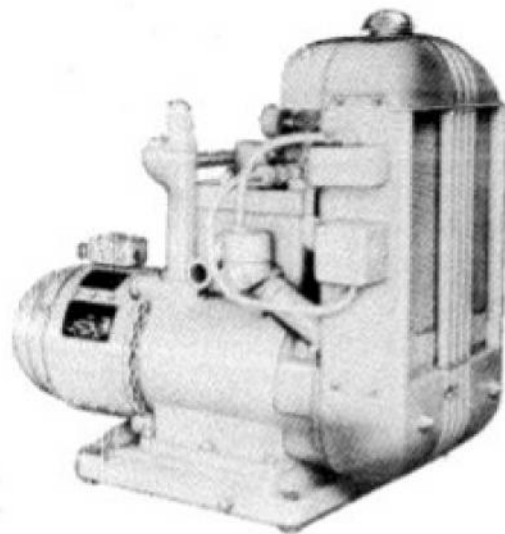

FIGURE 1229. Engine Generator
(Onan W3M-13)

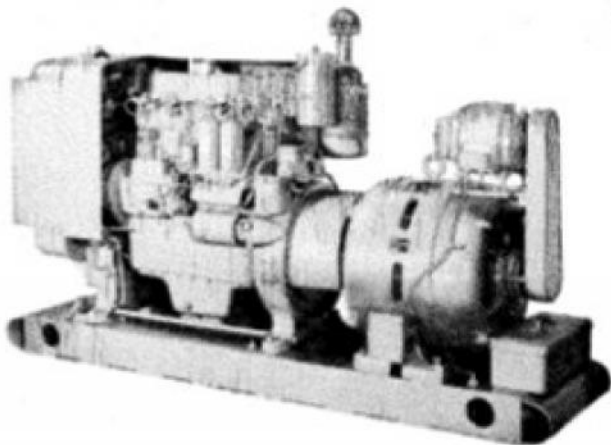

FIGURE 1228. Power Unit
PU-19/PRC

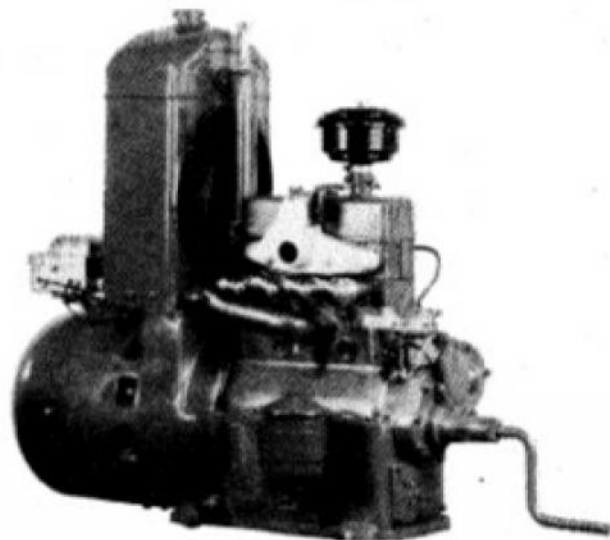

FIGURE 1230. Engine Generator
(Kohler 1M21A)

1211. ENGINE GENERATOR SETS - FIXED PLANT - ARRANGED BY CAPACITIES.

KW	Nomenclature ^a		Volts	PH	Wires
	Type No.				
0.35	PE-167-A		6/12 ^b		
0.75	PE-236-A		115	1	2
1.5	Kohler 1M21A		115	1	2
2.4	PE-148-A		110/220	1	2
3.0	Qman MSM-13		115	1	2
5.0	PE-95-F		120/240	1	3
5.0	PE-235-A		120/240	1	3
10	PE-78-()		120/240	1	3
10	PE-79-()		240	3	3
15	PE-205-()		120/240	1	3
15	PE-207-()		120/208	3	4
20	PU-19/PSC		120/240	1	3
25	PE-85-F		120/208	3	4
25	PE-85-L & -M		230	3	3
35	PE-81-()		240	3	3
50	PE-142-()		240	3	3
50	PE-215-A		240	3	3
100	PE-220-()		240	3	3

^aDesignations other than PE and PU are manufacturers codes.

^bD-c generator; all others 60 cycles a-c.

1212. ENGINE GENERATOR SETS - FIXED PLANT - STOCK NUMBERS AND LOGISTICAL DATA.

Nomenclature ^a Type No.	Stock Numbers		Weight (lbs.) Heaviest Package Packed for Export	Total Weight (lbs.) Packed for Export Pounds	Total Displacement Packed for Export Cu.Ft.	Ship Tons ^b
	Units	Instr. Book				
PE-78-A	3H4578A)	3H4578A/1/1	3340	3600	92	2.3
PE-78-B	3H4578B)		3340	3600	92	2.3
PE-78-C	3H4578C	3H4578C/1	3340	3600	92	2.3
PE-78-F	3H4578F	3H4578F/1	3340	3600	92	2.3
PE-78-H	3H4578H.1		3340	3600	92	2.3
PE-79-D	3H4579D	3H4579D/1	3030	3390	93	2.3
PE-79-E	3H4579E	6D7900E9E	3030	3390	93	2.3
PE-79-F	3H4579F		3030	3390	93	2.3
PE-81-E	3H4581-E	3H4581E/1	4600	5000	161	4.3
PE-81-F	3H4581-F		4600	5000	161	4.3
PE-85-F	3H4585F	3H4585F/1L	6300	6900	378	9.5
PE-85-L	3H4585L		5050	5600	211	5.2
PE-85-M	3H4585M		5310	5860	225	5.6
PE-95-F	3H4595F		2050	2050	80	2
PE-142-B	3H4600-142B	6D7800B22B	6700	8800	400	10
PE-142-C	3H4600-142C	6D7800B22C	7300	9215	494	12.3
PE-142-D	3H4600-142D		6700	8800	400	10
PE-142-E	3H4600-142E		6700	8800	400	10
PE-148-A	3H4512.3-1	3H4512.3-1/1	1196	1196	61	15
PE-167-A	3H4600-167		108	108	3.6	0.9
PE-205-A	3H4600-205A	3H4600-205A/1L	3726	4894	191	4.8
PE-205-B	3H4600-205B	6D7800B15B	5100	6710	246.5	
PE-207-A	3H4600-207A	3H4600-207A/1L	3800	4917	194	4.9
PE-207-B	3H4600-207B		5100	6710		
PE-215-A	3H4600-215A.1		8925	8925	308	7.7

Table continued on next page

ENGINE GENERATOR SETS - FIXED PLANT - STOCK NUMBERS AND LOGISTICAL DATA. (CONTINUED)

Nomenclature ^a Type No.	Stock Numbers		Weight (lbs.) Heaviest Package Packed for Export	Total Weight (lbs.) Packed for Export Pounds	Total Displacement Packed for Export Cu.Ft.	Ship Tons ^b
	Units	Instr. Book				
PE-220-A	3H4600-220A	3H4600-220A/BI	19300	21359	1113	27.8
PE-220-B	3H4600-220B	3H4600-220A/BI	19300	21359	1113	27.8
PE-235-A	3H4600-235A	6D7800B22A	1390	1390	70	1.8
PE-256-A	3H4511-1	3H4511-1/1	225	225	10	0.3
FU-19/FRC	3H4531-19F	3H4531F/BI	4750	5900	167	4.2
Onan WSM-13	3H4512.6	3H4512.6/BI0	662	662	34	0.9
Kohler 1M21A	3H4524-1M21A		880	880	28	0.7

^a Designations other than PE and FU are manufacturer's codes.

^b A ship ton = 40 cu. ft.

Section III
Rectifiers

1213. GENERAL.

a. Rectifiers are of the tube and disc types and are intended primarily for charging lead storage batteries. In case such storage batteries are connected to a telephone load while being charged a filtering device in the rectifier output is required in order to insure quiet telephone circuit operation. This filter is sometimes furnished separate from the rectifier and as such is usually referred to as a reactor.

b. Some of these rectifiers have their output regulated which insures the maintenance of close voltage limits on switchboards or other equipment being supplied. Others are of the non-regulated type and have rather wide voltage variations with a-c input and load changes.

c. Paragraph 1214 gives descriptive information on rectifier equipments. They operate on a-c power of 115 or 230 volts, and frequencies of 25, 40, 50 or 60 cycles. They range in capacities from a few milliamperes to 30 amperes.

d. Paragraph 1215 gives stock numbers and logistical data for rectifiers.

1214. RECTIFIERS - DESCRIPTION

Name	Nomenclature Type No.	Mfr.	Mfr's. No.	Shown in Fig. No.	Rating ^a			Is Operation Dimensions			Input Volts Cycles	TM or Instruction Book	Remarks		
					Amperes	Volts	Hz.	Weight	Height	Width				Depth	
a. Tungsar Type Rectifier	-	Gen. Elec. Co.	3049455	1231	3	10-52		48	17-1/2	12-1/8	15	115	60	GECo's Inst. GEL-2859A	For general use in charging 6 to 24 cells of storage battery or for charging telephone batteries while in use.
Rectifier	-	Gen. Elec. Co.	680487 ^b	1232	6	7-1/2-75		57	19-3/8	8-1/4	9	115	25-40	GECo's Inst. GEL-070C	For general use - will charge up to 12, 6 volt lead storage cells.
Rectifier	-	Gen. Elec. Co.	680538 ^b	1233	6	7-1/2-75		32	10-1/2	18-1/2	7-5/8	115	60	GECo's Inst. GEL-319C	For general use - will charge up to 12, 6 volt lead storage cells.
Rectifier	-	Gen. Elec. Co.	680637	1234	2-12	6-65		66	19-8/8	8-1/4	9	115	60	GECo's Inst. GEL-660A TM 11-951Q	For general use - may be used for charging telephone batteries while in use by using an external filter reactor GECo's Cat. #3126680, weighing 63-1/2 lbs., height 10-1/2", width 6-1/2", and depth 7-3/4".
Rectifier	-	Gen. Elec. Co.	93249	1235	12	6-90		90	17-1/2	12-1/8	14-7/8	250	50-60	None	For general use - charging up to 15, 6 volt storage batteries at 12 amps., or 30, 6 volt storage batteries at 5 amps. - may also be used for charging telephone batteries while in use by using an external filter reactor GECo's Cat. #3049455, weighing 65 lbs., height 10-1/2", width 6-1/2", and depth 7-7/8".
Rectifier	-	Power Equipmt.	FEE-161	-	30	30		268	20-1/2	18	14	110-250	40-60	None	For charging 10-12 cells of storage battery.
Rectifier and Filter Reactor	EA-36-1	Gen. Elec. Co.	680637 (Modified) 3126769 or 3126680	1236	12	0-65		125	19-3/8	11-1/2	11-5/8	115	60	TM 11-358, TM 11-951 and TM 11-951Q	The EA-36-1 rectifier includes an external reactor filter coil and may be used for charging telephone batteries while in use. This rectifier is suitable for general use in charging any lead storage cells.
b. Elektron Tube Type Rectifier	-	Trojan Rectifier and Equipmt. Co.	2702D	-	10-30	30		34	15-3/8	17	17	100-200	40-60	Trojan Inst. Sheet on Catalogue #2702D Rectifier	For general use - charging 10-12 cells of storage batteries and for charging telephone batteries while in use.
c. Grid Controlled Type Rectifier	MR-43-1	-	-	1237	0.5-4.5	120		140	22	17-1/2	10-3/4	95-250	60	TM 11-358 TM 11-954	For use where regulated 120 volts d-c is required, such as a telegraph central office.

^a All are full wave rectifiers except the Tungsar Type Gen. Elec. Co. 680487 and 680538 which are half wave rectifiers.

RECTIFIERS - DESCRIPTION (Continued)

Nomenclature Type No.	Mfr.	Mfr's. No.	Shows in Fig. No.	Rating ^a			In Operation Dimensions			Input Volts Cycles	TM or Instruction Book	Remarks	
				Amps.	Volts	Watts	Height	Width	Depth				Weight
d. Copper Oxide Type Rectifier													
	Raytheon Mfg. Co.	N-3155	1238	3	23-65 ± 25	170	21-1/8	19-1/8	11-1/2	95- 130	60	For charging 11 cells of storage battery and for constant float - automatic charge of telephone batteries while in use.	
Rectifier	Raytheon Mfg. Co.	N-3326	-	3	49-45 ± 25	240	27-7/8	19-1/8	15-1/4	95- 130	60	For charging 25 cells of storage battery and for constant float - automatic charge of telephone batteries while in use.	
Rectifier	Raytheon Mfg. Co.	N-1067	1238	6	23-65	240	27-7/8	19-1/8	15-1/4	95- 130	60	For charging 11 cells of storage battery and for constant float - automatic charge of telephone batteries while in use.	
Rectifier	Raytheon Mfg. Co.	N-2169A	1238	6	23-65 ± 25	240	27-7/8	19-1/8	15-1/4	95- 130	60	For charging 11 cells of storage battery and for constant float - automatic charge of telephone batteries while in use.	
Rectifier	Raytheon Mfg. Co.	N-3453	-	6	23.7	161	21-3/4	19-1/8	11-1/4	95- 130	60	For charging 11 cells of storage battery and for constant float - automatic charge of telephone batteries while in use.	
e. Selenium Type Rectifier													
			1239	0.4 3	115 115 AC	25-1/2	6-1/2	8-1/2	12-1/4	110	50-60	TM 11-955	For small 115V D-C applications.
Rectifier			1240	0.4 4.35	115 115 AC	40	7-1/2	8-3/8	7-1/2	115/ 230	50-60	TM 11-957	For small 115V D-C applications up to 46 watts and for 115V A-C up to 500 watts.
Rectifier			1241	6-12	30-10	51	16	14	10	115/ 230	50-60	TM 11-963	Portable Battery Charger.
Rectifier			-	2-12	6-48	150	25-1/4	21-1/4	15-1/4	115/ 230	50-60		For general use in charging 3 to 24 cells of storage battery.

^a All are full wave rectifiers except the Tungar Type Gen. Elec. Co. 6304B7 and 6305B2 which are half wave rectifiers.



FIGURE 1231. Tungar Rectifier
(General Electric Co. 3049455)

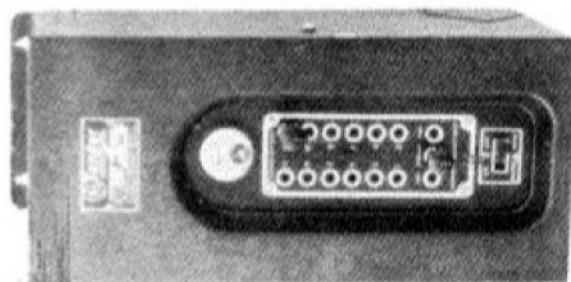

FIGURE 1232. Tungar
Rectifier (General
Electric Co. 6RB4B7)

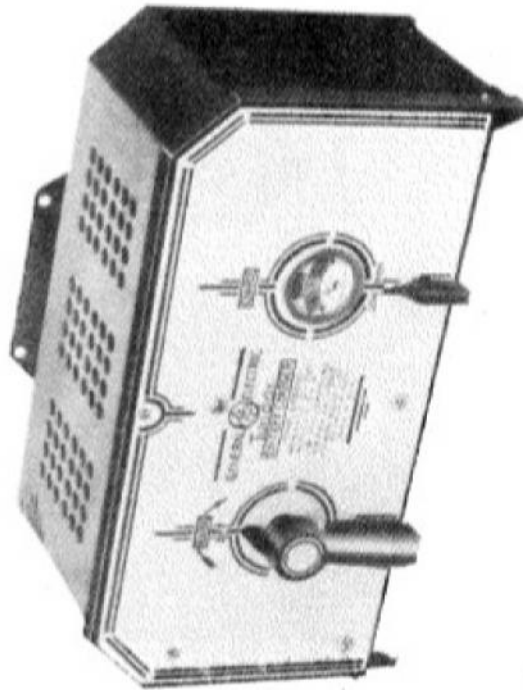

FIGURE 1233. Tungar Rectifier
(General Electric Co. 6RB33B2)

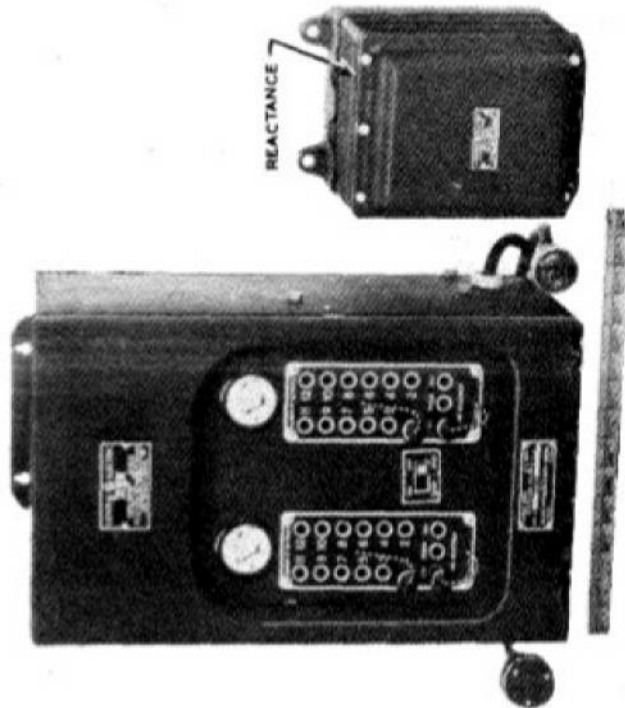

FIGURE 1236. Rectifier RA-36-1 ()



FIGURE 1235. Tungar Rectifier
(General Electric Co. 9A649)

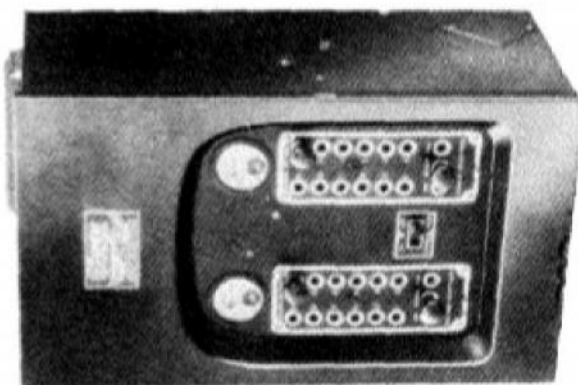

FIGURE 1234. Tungar
Rectifier (General
Electric Co. 6RB6B17)

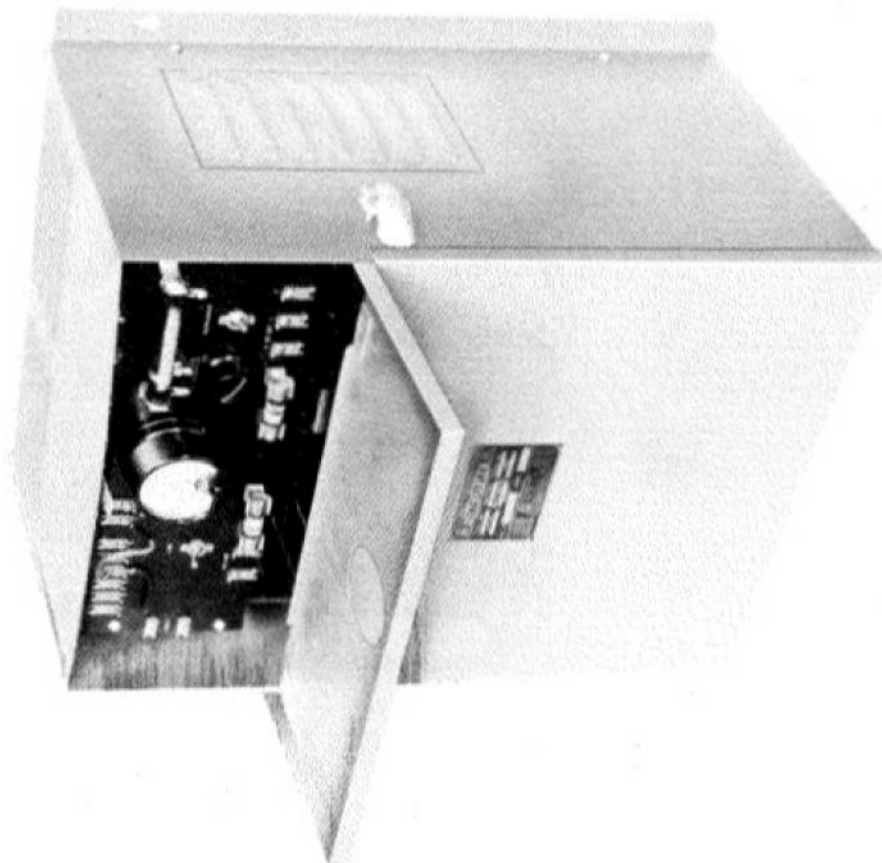

FIGURE 1238. Copper Oxide Rectifier (Raytheon Mfg. Co. W-3155, W-1067 and W-2168A)

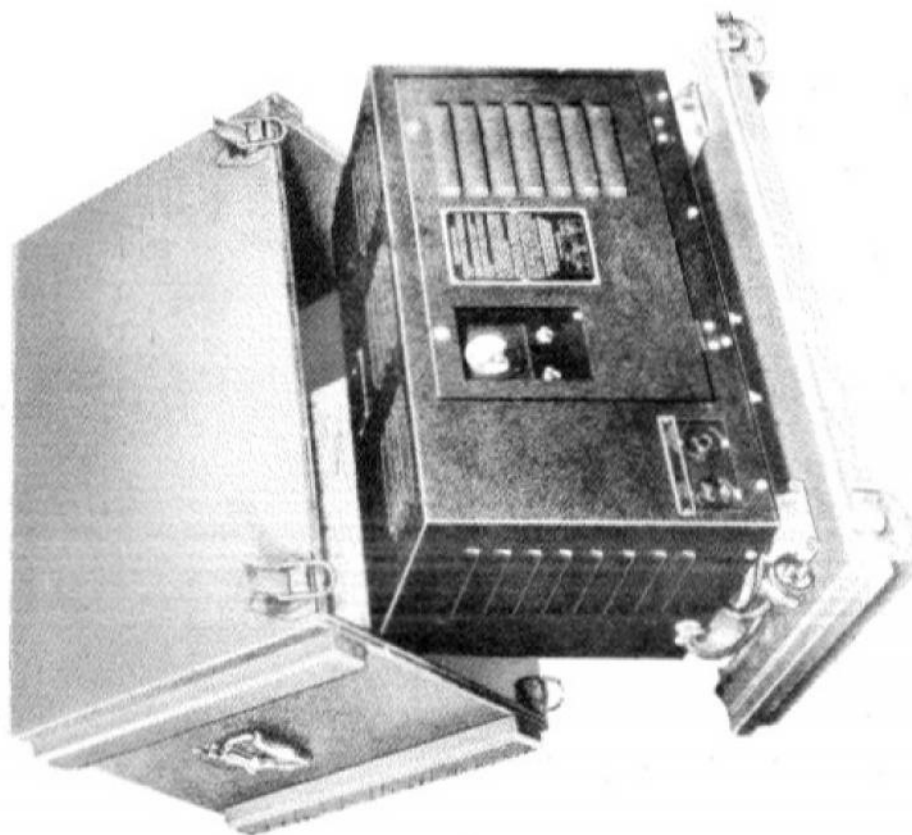

FIGURE 1237. Grid Controlled Rectifier RA-43-()

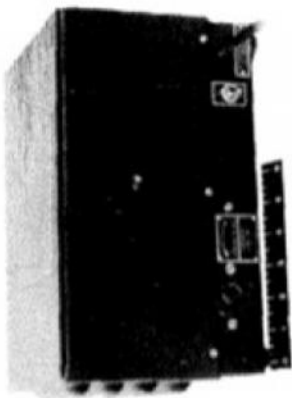

FIGURE 1239. Rectifier RA-37



FIGURE 1240. Rectifier RA-67

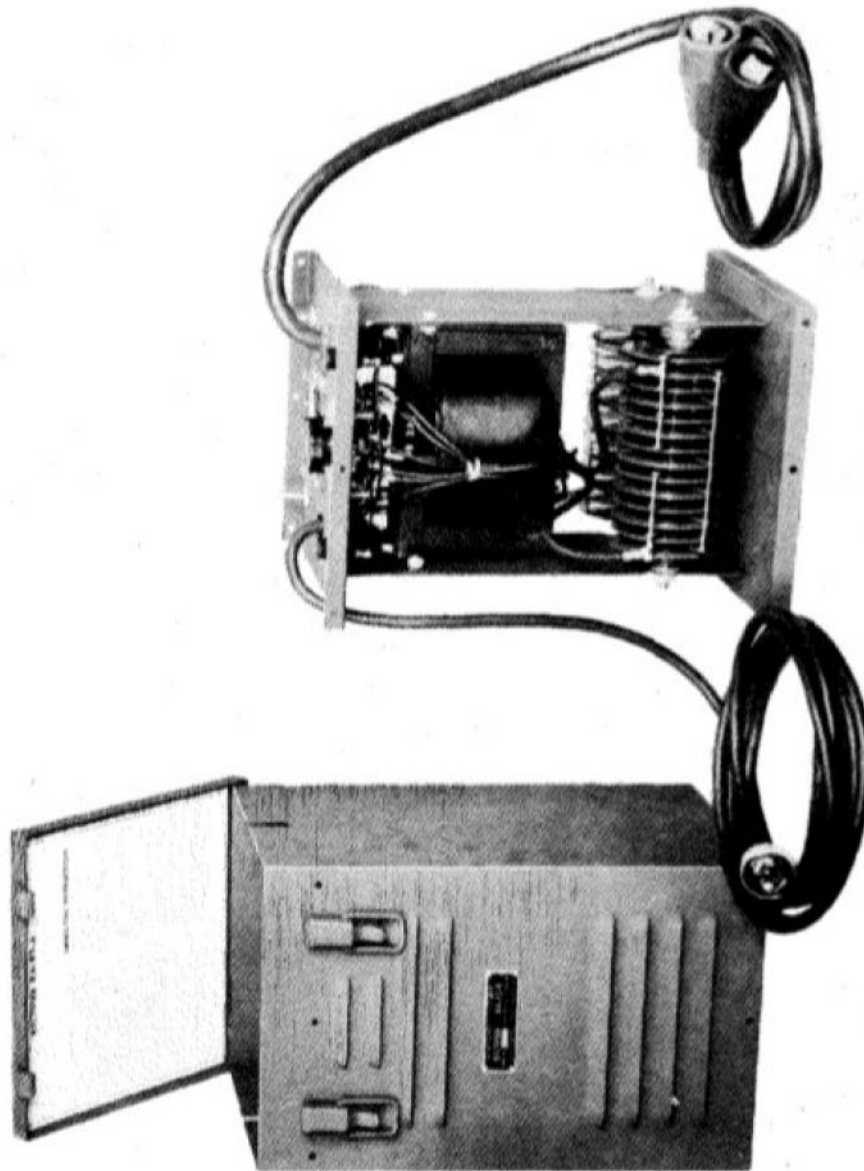

FIGURE 1241. Rectifier RA-83-()

1215. RECTIFIERS - STOCK NUMBERS AND LOGISTICAL DATA

Item	Nomenclature		Stock No.	Type of Equipment	Mfr.	Mfr.'s. No.	Total Weight lbs.		Total Displacement	
	Name	Type No.					In	Cu. Ft.	In	Cu. Ft.
a.	Rectifier	-	SH4703	Tungar	Gen.Elec.Co.	3049455	88	53	7	2.1
b.	Rectifier	-	SH4706.2	Tungar	Gen.Elec.Co.	6RB4B7	98	64	5.5	1.1
c.	Rectifier	-	SH4706B	Tungar	Gen.Elec.Co.	6R53B2	36	33	1.2	1.0
d.	Rectifier	-	SH4712.1A	Tungar	Gen.Elec.Co.	6RB6B17	114	74	5.5	1.1
	Reactor for use with above rectifier	-	SH4604-1	Reactor	Gen.Elec.Co.	3126680	73	66	2	0.4
e.	Rectifier	-	SH4712.3	Tungar	Gen.Elec.Co.	9X649	140	106	7	2.0
	Reactor for use with above rectifier	-	-	Reactor	Gen.Elec.Co.	3049480	75	69	2	0.4
f.	Rectifier	-	SH4701	Tungar	Power Equipt. Co.	PEC-161	324	275	9.1	4.2
g.	Rectifier & Reactor	RA-36-()	SH4676()	Tungar & Reactor	-	-				
	(1) Rectifier & Reactor	RA-36-A,B or C	SH4676A,B or C	Tungar Reactor	Gen.Elec.Co.	6RB6B17(Modified)	213	146	7	2.1
					Gen.Elec.Co.	3126680				
	(2) Rectifier & Reactor	RA-36-J,K or L	SH4676J,K or L	Tungar Reactor	Gen.Elec.Co.	6RB6B17(Modified)	223	156	7	2.1
					Gen.Elec.Co.	3126680				
	(3) Rectifier & Reactor	RA-36-E or Q	SH4676E or Q	Tungar Reactor	Gen.Elec.Co.	6RB6B17(Modified)	230	159	7	2.1
					Gen.Elec.Co.	3126769				

Additional Equipment Required for (1)(2), or (3) above
 (A) Frame for Rectifier FM-30 RA-36-() and its reactor
 (B) Case for FM-30 frame CS-73 and RA-36-() rectifier and reactor
 (C) Total for item g

75	50	16	9
80	65	18	10.8
385	274	18	10.8

Table continued on next page

RECTIFIERS - STOCK NUMBERS AND LOGISTICAL DATA (Continued)

Item	Nomenclature		Stock No.	Type of Equipment	Mfr.	Mfr's. No.	Total Weight lbs.		Total Displacement		
	Name	Type No.					In	Case or Export Container	In	Cu. Ft.	
h.	Rectifier	-	3H4701-3	Electron Tube	Trojan Rectifier & Equipt. Co.	27820		12	6.2		
i.	Rectifier	RA-43-()	3H4663()	Grid Controlled Grid Controlled			182	140	7	3	
	(1) Rectifier	RA-43-A	3H4663A								
	Additional Equipment Required										
	Case for RA-43-A Rectifier	CS-82-A	2Z1882A	Case			70	50	9	5.3	
j.	Rectifier	RA-43-B	3H4663B	Grid Controlled			182	140	7	3	
											(2) Rectifier
k.	Rectifier and Case Includes case CS-82-B	RA-43-B	3H4663B.1	Grid Controlled in case			252	190	9	5.3	
											(3) Rectifier
j.	Rectifier	-	3H4703.1	Copper Oxide	Raytheon Mfg. Co.	W-3155	231	185	9	3.1	
k.	Rectifier	-	3H4703.2	Copper Oxide	Raytheon Mfg. Co.	W-3826	319	255	12.5	5.2	
l.	Rectifier	-	3H4703.4	Copper Oxide	Raytheon Mfg. Co.	W-1067	319	255	12.5	5.2	
m.	Rectifier	-	3H4706.3	Copper Oxide	Raytheon Mfg. Co.	W-2168A	319	255	12.5	5.2	
n.	Rectifier	-	3H4705.4	Copper Oxide	Raytheon Mfg. Co.	W-3483	220	175	9	3.1	
o.	Rectifier	RA-37	3H4677	Selenium							
	Additional Equipment Required.										
	(1) Chest for RA-37 Rectifier	CH-51	4TCH51	Chest			65	41.5	2.9	1.1	

Item	Nomenclature		Type No.	Stock No.	Type of Equipment	Mfr.	Mfr's. No.	Total Weight lbs.		Total Displacement- Cu. Ft.	
	Name							In	Case or Container	Packed for Export	Carrying Case or Container
p.	Rectifier		RA-87	3H4699-87	Selenium			50	40	1.8	0.5
q.	Rectifier and Chest Includes Chest CH-153		RA-87	3H4699-87.1	Selenium in Chest			81	59	3.3	1.5
r.	Rectifier		RA-83	3H4699-83	Selenium			64	51	1.5	1.1
s.	Rectifier in carrying case		RA-83-A	3H4699-83A	Selenium			64	51	1.5	1.1
t.	Rectifier		RA-91	3H4699-91	Selenium			195	155	5	0.5

Section IV
Power Ringing Units

b. Two types of ringing equipment are available; namely the vibrating type, which is normally used in the tactical plant, and the static type, which is normally used in the fixed plant.

c. Descriptions of these equipments are covered in paragraph 1217 and stock numbers and logistical data are given in paragraph 1218.

1216. GENERAL

a. Ringing equipments provide 20 cycle ringing current as required for signaling purposes.

1217. RINGING EQUIPMENT-DESCRIPTION

Nomenclature		Shown in Fig.	Output Rating			Wt.	In Operation Dimensions			TM or Inst. Book	Remarks
Name	Type No.		Cycles	Volts	Watts		Height	Width	Depth		
a. Tactical											
Interrupter	W.E. Co's 84F ^a	1242	18-1/2	115	20	16	7-15/16	9-1/4	5-17/32		Vibrating type; requires power source of 24V, 1 amp. d-c
Interrupter	W.E. Co's 84G ^a	1242	18-1/2	115	20	16	7-15/16	9-1/4	5-17/32		Vibrating type; requires power source of 37V, .75 amp. d-c
Telering	Tel- kor Mod. H ^a	1243	20	90	-	11	11-7/8	8-1/2	5-1/8		Vibrating type; requires power source of 110V, 60 cycles a-c
Converter	M-222	1244	20	120	-	11	6-3/4	6-5/8	8-1/4	TM11-344	Vibrating type; requires power source of 2 Batteries BA-23. Part of Telephone Central Office Set TC-4.
b. Fixed Plant											
Subcycle	Lorain Pro- ducts Corp. Model 5 ^a	1245	20 or 16-2/3	75-90	15	30	5	8	11-1/2	Lorain Products Corp. Instruc- tion Form 130	Static type, requires power source 105-125 volts. For 60 cycle input output will be 20 cycles. For 50 cycle input output will be 16-2/3 cycles. Non-moistureproof.

^a Manufacturer's code numbers.

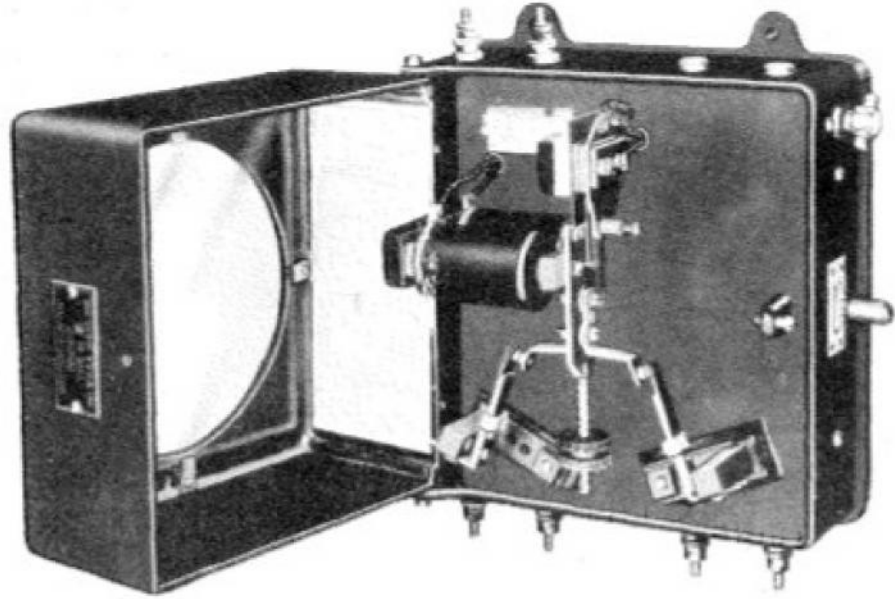

FIGURE 1242. Interrupter (Western Electric Co. Types 84F or G)

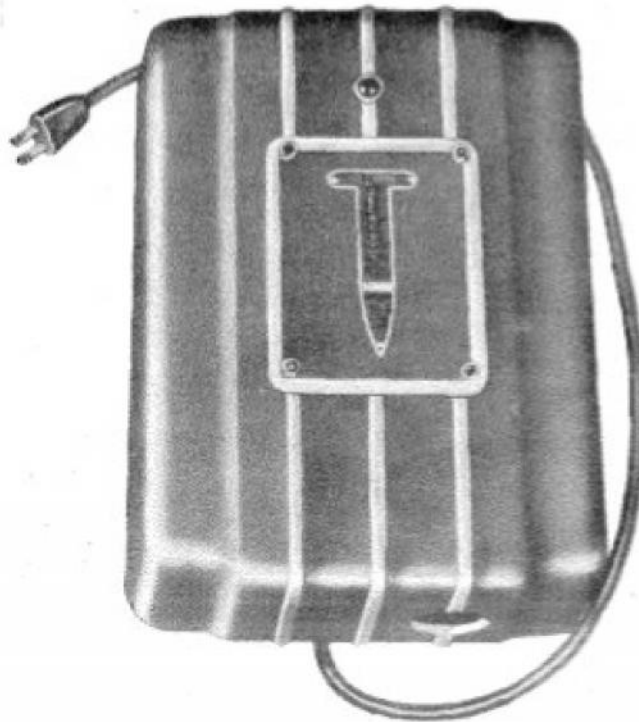

FIGURE 1243. Teletype Terminal (Telkor Model H)

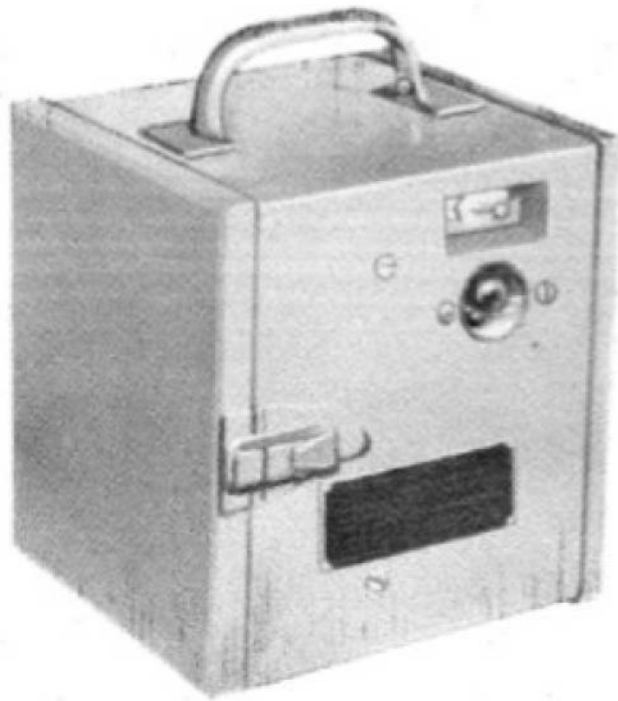

FIGURE 1244. Converter M-223



FIGURE 1245. Subcycle Static Frequency Converter

1218. RINGING EQUIPMENT - STOCK NUMBERS AND LOGISTICAL DATA.

Name	Type No.	Stock No.	Weight Lbs.- Heaviest Package		Total Weight - Lbs.		Total Volume - cu. ft.	
			Packed for Export	In Carrying Case or Container	Packed for Export	In Carrying Case or Container	Packed for Export	In Carrying Case or Container
<u>a. Tactical</u>								
Interrupter	W.E.Co. 84F ^a	4F1084F	35	17	35	17	0.5	0.3
Interrupter	W.E.Co. 84G ^a	4F1084G	35	17	35	17	0.5	0.3
Telering	Telkor Model H ^a	4F2425	35	12	35	12	0.8	0.4
Converter ^b	M-222	4F222	25	11	25	11	0.5	0.2
<u>b. Fixed Plant</u>								
Subcycle	Lorain Products Corp - Model S ^a	4F2315	54	34	54	34	0.5	0.3

^a Manufacturer's code numbers.

^b Furnished with a carrying case built as an integral part of the converter.

Section V
Batteries

1219. LEAD STORAGE BATTERIES.

a. The batteries described in this section include those for use with radio sets; aircraft, automotive equipment, communication sets, etc. The smaller types of batteries for portable equipment are provided in most instances with plastic cases which are lighter in weight and stronger than moulded cases. Other cells are provided with molded hard rubber cases and covers. All batteries are of the sealed type with vents, or vent plugs.

b. Most of the batteries used with radio or other communication sets are provided with bolt, or wing nut terminals and the equipment leads are supplied with terminals to fit. If it is necessary to use, with such equipment, batteries having post terminals, an adapter for the battery posts can be obtained. Information on this adapter is given in paragraph 1224.

c. All storage batteries for export are shipped dry charged. The electrolyte is shipped separately in quantity to depots, but as far as possible should be obtained locally from appropriate

theater, base, command or department funds for this purpose. Sulphuric acid electrolyte of 1.280 sp.gr. and 1.400 sp.gr. in one gallon containers and 10 gallon carboys is listed in paragraph 1223.

d. Paragraph 1222 gives the stock numbers and logistical data for dry charged batteries listed in paragraph 1221.

e. Storage batteries after filling with electrolyte must be kept charged to avoid deterioration. Reference should be made to TM 11-430 for the proper maintenance procedure to be followed and to sections II and III of this chapter for charging equipment which may be used.

1220. DRY BATTERIES.

a. Dry batteries are made in a variety of shapes and sizes to fit different types of equipment. In general the ampere hour capacity of a dry battery is a function of its weight. This is exemplified by the BA-70 and BA-80 batteries which are identical in voltage, but different in size. The BA-70 has twice the capacity of, and approximately twice the weight of the BA-80.

b. Information concerning the quantities of dry batteries required for the operation of equipment maintained by the Signal Corps is given in SB 11-6, "Dry Battery Supply Data".

c. Paragraphs 1225 to 1226 give information concerning the various types of dry batteries which are available. The data are arranged by voltage as well as by code numbers. Reference is made to a drawing which shows the terminal arrangements of the various batteries.

d. Dry batteries are usually supplied in quantities to depots as general stock. These batteries are stocked in sealed unit packages to protect them against moisture until ready for use. Stock numbers for dry batteries and the number of batteries per unit package are listed in paragraph 1227. The data are arranged in accordance with the code numbers of the batteries. Wherever possible, supplies of batteries should be drawn from stock in these unit packages and only opened as needed.

e. In some instances the depots may be supplied with commercial dry batter-

ies instead of the regular BA types. They will be equivalent in electrical characteristics but may vary slightly in physical size from the dimensions shown for the equivalent BA type. Data on commercial type dry batteries which are equivalent to the BA types are also given in paragraph 1227.

f. Dry batteries in use should be checked for corrosion of contacts and this condition corrected according to TB SIG 6. Dry batteries are not rechargeable and should be replaced when their voltage in use falls below that needed to operate the equipment with which they are associated. This is usually .90 to 1.1 volts per cell. When dry batteries have been stored under adverse conditions, or for a period extending beyond the data for placing them in service, they should be tested according to TB SIG 14.

1221. LEAD STORAGE BATTERIES - DESCRIPTION.

Type No.	Mfg. Type	Capacity at 80°F		Fig. No.	Rate Hrs.	Rate Hrs.	Charge Rate Amps.		Terminal Type	Oper- tions Lbs.	Overall Dimensions Inches			Quantity of Electrolyte Cells.	Remarks
		Initial	Final				Length	Width			Height				
2 - VOLT BATTERIES (SINGLE CELL)															
BB-54	Willard ER-27-2	1946	50	20	3	1.2	Bolt	4.25	3-31/32	3	5-1/2	0.1	Plastic container; nonspilling; fibrite separators. Has charge indicator and separate filling hole.		
BB-205/U	Willard ER-1-B	-	2.5	20	0.5	0.12	Pin	0.56	1-13/32	3 1/32	4-5/16	0.7	Plastic container; nonspilling; fibrite separators. Has pin terminals. Used with meteorological equipment. Similar in appearance to BB-51.		
BB-210/U	Willard ERH-25-2	-	24	20	2.7	1.06	Bolt	2.95	2-9/16	2-9/16	6-7/16	0.5	Plastic container; nonspilling; fibrite separators. Has charge indicator and separate filling hole.		
BB-212/U	Willard ER-40-2	-	40	20	4.5	1.8	Bolt	5.50	6-7/8	2-3/8	4-1/2	0.5	Plastic container; nonspilling; fibrite separators. Has charge indicator and separate filling hole.		
BB-215/U	Willard ER-6-2	-	6	20	0.8	0.4	Bolt	1	2-1/8	1-11/16	4	0.5	Plastic container; nonspilling; fibrite separators. Has charge indicator and separate filling hole.		
BB-216/U	Willard ER-60-2	-	60	20	6	2.5	Bolt	7.2	4-15/16	3-15/16	6-9/16	0.7	Plastic container; nonspilling; fibrite separators. Has charge indicator and separate filling hole.		
4 - VOLT															
BB-29	Exide 2-XCM-15	1247	100	20	11	5.5	Wing Nut	37.5	9-11/16	7-5/16	10-9/32	0.7	Hard-rubber container; moulded-rubber screw plug; microporous rubber separator.		
BB-215/U	Willard ER-40-4	-	42	20	4.5	1.8	Socket ^a	10.9	6-1/4	5-5/4	4-3/16	0.5	Plastic container; nonspilling; fibrite separators. Has charge indicator and separate filling hole.		
6 - VOLT															
BB-49	Firestone 151	-	90	20	10	4	Tapered Stud	39	9-1/8	7-1/8	9-1/8	1.4	Hard-rubber container; moulded-rubber screw plug; microporous rubber separator. Has wing nut terminals.		
	Willard SR-1-92	-													
	Exide 151	-													
	National 515-1	-													
	Goodrich RD-145	-													
	Globe 63	-													
	Delco 15AJ	-													
	Autolite PR15	-													
BB-51	Willard ER-3	1248	0.50	100	0.1	.04	Pin	0.54	3-7/16 ^b	1-5/16	5 1/32	0.7	Plastic container; open vent and filling hole; fibrite separators. Fibrite fills all free space of cells and absorbs free electrolyte. Used with meteorological and direction finder equipments.		
BB-55	Exide XM-194	1249	150	20	17	6.8	Tapered Stud	65	12-1/16	7-1/8	9-3/8	1.9	Hard-rubber container, moulded-rubber screw plug; microporous rubber separator.		
	Willard SR-5-153	-													
	National M-19-44	-													
	Autolite T38-4-19	-													
	Firestone L-104	-													
BB-57	Exide XH-25	-	200	20	22	8.8	Tapered Stud	80	16-1/4	7-1/8	9-5/8	2.5	Hard-rubber container; moulded-rubber screw plug; microporous rubber separator.		
	Willard SR-12-200	-													
	Delco 25AT	-													
	Autolite RR-25	-													
	Firestone P-25B	-													
BB-207/U	Willard ER-15-6	-	20.2	20	2	0.8	Bolt	9.75	8-11/32	3-51/32	4-3/8	0.25	Plastic container; nonspilling, microporous separators. Has charge indicator and separate filling hole.		

^a One socket hole in center of vertical front side of each cell.

^b Length over pin terminal, 4-5/16".

Table continued on next page

LEAD STORAGE BATTERIES - DESCRIPTION (CONTINUED)

Type No.	Mfg. Type	Fig. No.	Capacity at 80°F		Charge Rate		Terminal Type	Weight in Operations lbs.	Overall Dimensions Inches		Quantity of Electrolyte Cells	Remarks	
			Ass. Hrs.	Rate Hrs.	Initial	Final			Length	Width			Height
6 - VOLT (Cont'd)													
BB-214/U	Willard W-T-6	-	5.5	20	0.4	0.16	Flat Cap	1.6	5-19/32	1-13/16	2-3/8	Plastic container; nonspilling; fibrite separators.	
12 - VOLT													
BB-46	Exide FVA-7-1	1250	90	20	9	4.5	Wing Nut	120	15-7/8	6-1/2	14-9/16	2.4	Hard-rubber container; moulded-rubber screw plug; wood and rubber separators. Used with radio sets and telephone centrals.
BB-50		1251	55	20	6.5	3.2	Wing Nut	64	12-7/8	7-1/8	9-7/8	1.2	Hard-rubber container; moulded-rubber screw plug; wood and rubber separators. Used in tanks and armored cars.
BB-53	Exide 6-TS-15-1	1252	58	5	5	2	Wing Nut	58	10-5/16	5-5/16	11-9/32	1	Hard-rubber container; nonspilling; wood and rubber separators. Used with photographic sets.
OTHER 12 - VOLT													
BB-52	Willard BB-18 (36 volts)	-	.08	20	.02	.008	Pin	0.59	5-7/16 ^a	1-7/16	1-1/16		Plastic container; open vent and filling hole; fibrite separators. Fibrite fills all free space of cells and absorbs free electrolyte. Used with meteorological and direction finder equipment. Similar in appearance to BB-51.
BB-201/U	---- (14 volts)	-	15	1/2	4.5	1.8	Wing Nut	40	10-7/8	4-7/8	8		Hard-rubber container; moulded-rubber screw plug; microporous rubber separator.
	Philco 11KRTS) 22v. Philco 11KRT6)	-	120	8	16	5	Bolt	275	22 26-7/8	7-9/16 7-9/16	11-3/4 11-3/4	5	Hard-rubber container. Cells are mounted in wooden trays. 2 hydrometers, 2 thermometers, 2 lugs and one jumper are included.
	Philco 19ILA) ^b 22v. Philco 19ILA)	-	536	8	72	24	Post	1210	20-7/8 27-1/8	10-5/4 10-5/4	25 25	29	Hard-rubber container. Cells are mounted in wooden trays with lids. 22 v. battery includes 2 hydrometers, 2 thermometers, 2 lugs and two jumpers.

COMBINATION UNITS

BB-208 AMT	Willard One 6 Volt BB-51 & Three 36 Volt BB-52	Pin	For Information on Capacity, Dimensions, etc. see Data for BB-51, BB-52 and BB-205/U
BB-209 AMT	Willard One 2 Volt BB-205/U Three 36 Volt BB-52		Meteorological Sets Battery units are packed in vacuum can. Device is provided for vacuum filling

^a Length over pin terminals, 4-3/16".

^b Furnished in units of one 19IL5 and two 19ILA to provide 22 volts.

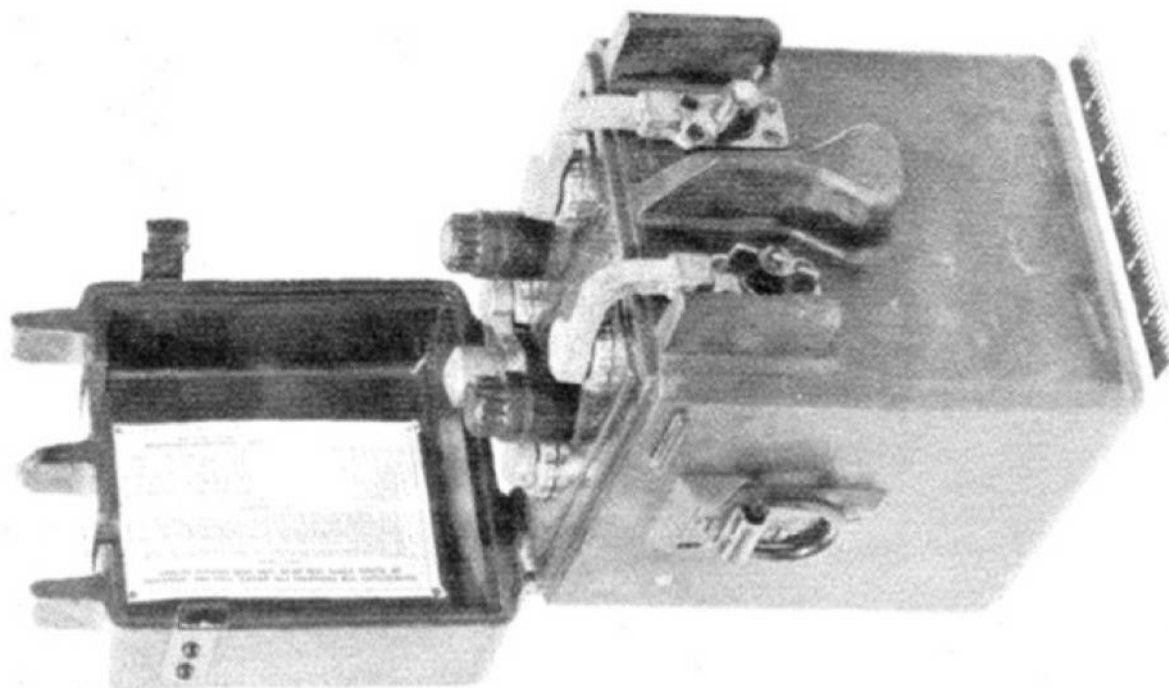

FIGURE 1247. Battery BB-29

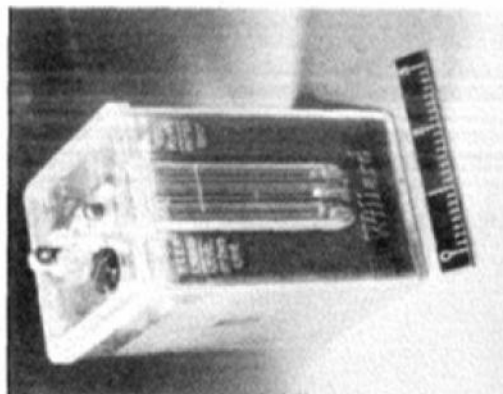

FIGURE 1246. Battery BB-54



FIGURE 1248. Battery BB-51

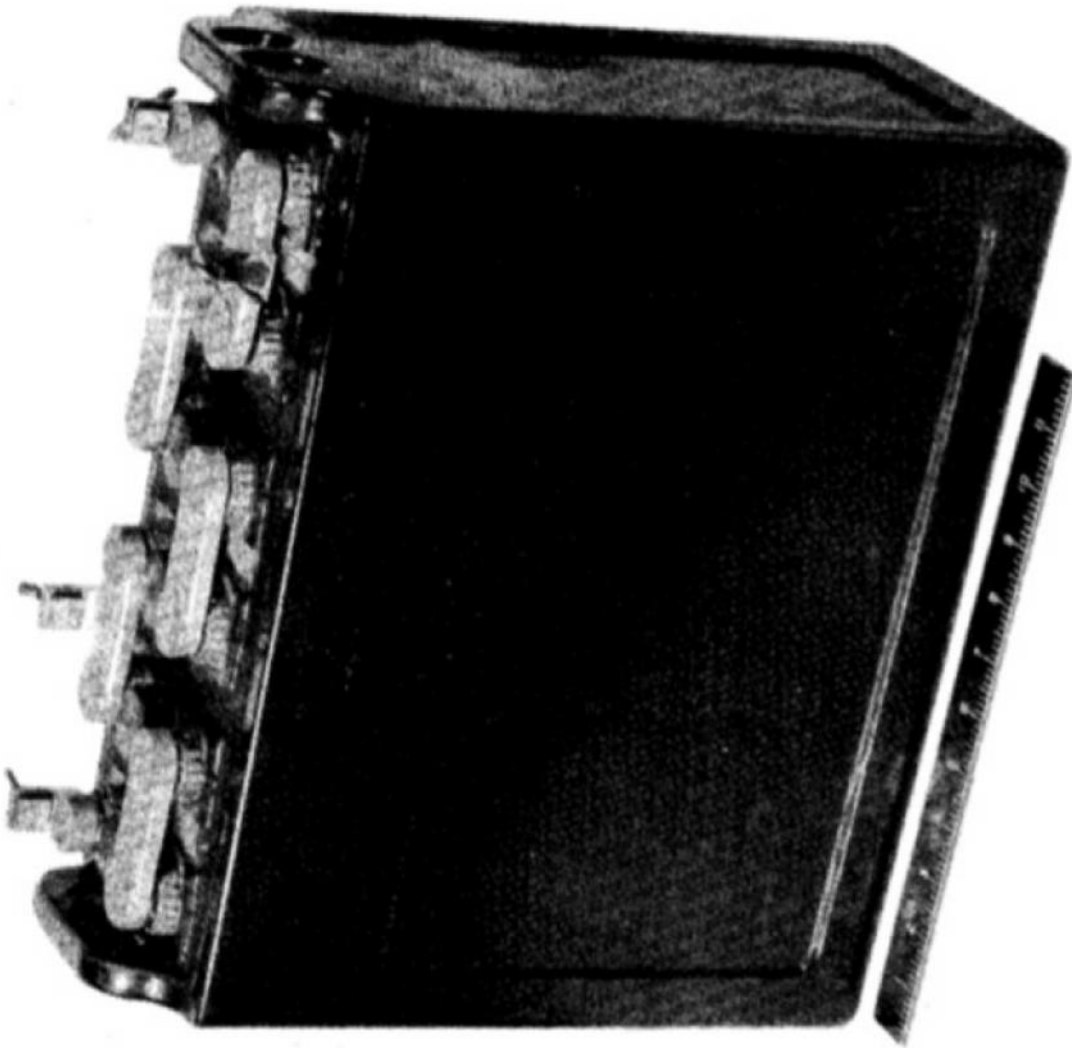

FIGURE 1250. Battery BB-46

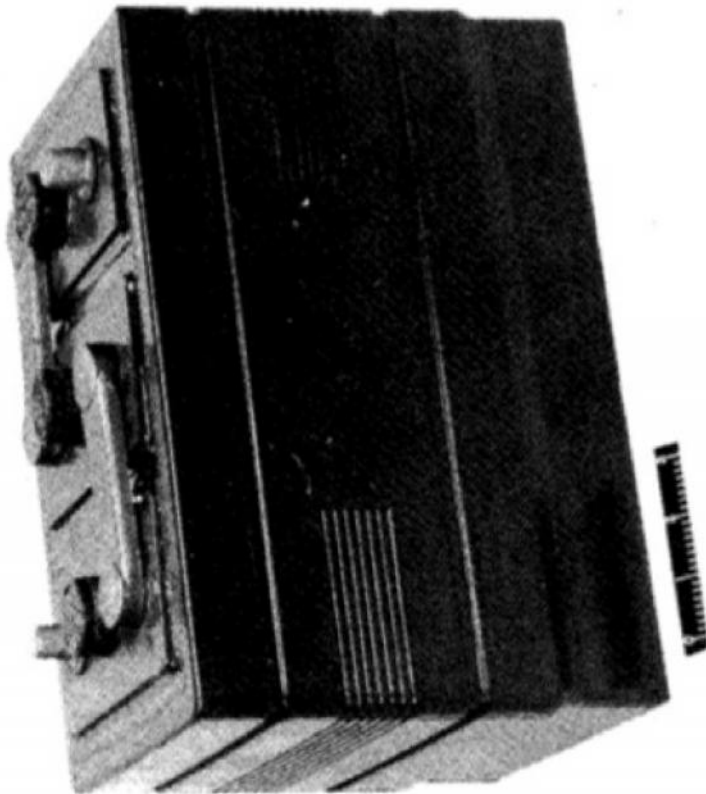

FIGURE 1249. Battery BB-55

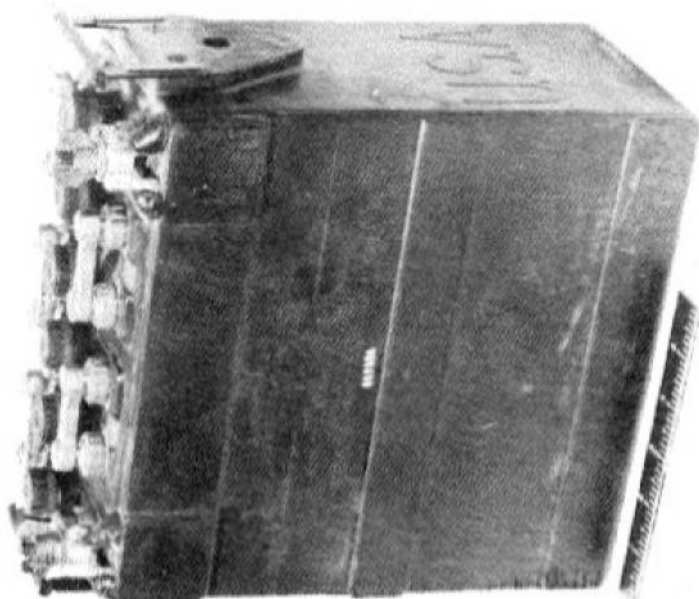

FIGURE 1252. Battery BB-53



FIGURE 1251. Battery BB-50

1222. LEAD STORAGE BATTERIES - STOCK NUMBERS AND LOGISTICAL DATA.

Type No.	Stock No.	Terminal Volts	Batteries Per Export Package	Export Package Weight-Lbs. ^a	Export Package Volume Cu. Ft.
BB-29	3B29	4	2	70	1.2
BB-46	3B46	12	1	122	2
BB-49	3B49	6	4	154	3
BB-50	3B50	12	1	80	1.2
BB-51	3B51	6	120	47	1
BB-52	3B52	36	120	48	1
BB-53	3B53	12	4	155	3
BB-54	3B54	2	6	33	1
BB-55	3B55	6	1	70	1.1
BB-57	3B57	6	1	85	1.3
BB-201/U	3B275-201	14	1	60	.5
BB-205/U	3B275-205	2	120	49	1
BB-208 AMT	3B280-208	6 "A"	50	103	2.3
		108 "B"			
BB-209 AMT	3B280-209	2 "A"	50	103	2.3
		188 "B"			
BB-210/U	3B275-210	2	18	56	1.3
BB-212/U	3B275-212	2	24	122	1.3
BB-213/U	3B275-213	4	12	118	1.4
BB-214/U	3B275-214	6	20	86	3.1
BB-215/U	3B275-215	2	-	-	-
BB-216/U	3B275-216	2	-	-	-
Phileo 11KRT	3B238.1	22	2	310 ^b	11 ^c
Phileo 19XL	Two FFM5075 One FFM5076	22	1	1250 ^d	60 ^e

^aExport weights are for batteries dry charged less electrolyte.

^dWt. of electrolyte is approximately 600 lbs.

^bWt. of electrolyte is approximately 175 lbs.

^cIncludes electrolyte (6 of 3B1514 in one package).

^eIncludes electrolyte (3 of FFM134001, each in separate package).

1223. ELECTROLYTE (SULPHURIC ACID).

Stock No.	Quantity Gals. ^a	Sp. Gr.	Container
3B1500.1-1	1	1.400	Bottle
3B1500.1-10	10	1.400	Carboy
3B1514	1	1.280	Bottle
3B1514-10	10	1.280	Carboy
FM134001	10	1.275	Carboy

^aElectrolyte for batteries is obtained locally wherever possible; otherwise it can be obtained from depots if ordered by stock numbers listed, such as "1 Each" of stock No. 3B1514. Fractional amounts should not be ordered.

1224. BATTERY TERMINAL ADAPTER.

Stock No.	Polarity
3B4294	Pos.
3B4294.1	Neg.

Shown in Fig. No. 1253



FIGURE 1253. Battery Terminal Adapter

1225. DRY BATTERIES - DESCRIPTION - SINGLE UNIT TYPES.

Type No.	Terminals ^a		Fig. 1254 Sketch No.	Weight In Operation (Lbs)	Dimensions (Inches)			Overall Height	Application ^b
	Type	Weight In Operation (Lbs)			Length	Width	Height		
1.5 - VOLT									
BA-15A	Screw & Knurled Nut	0.88	5	2-11/16	1-3/8	4-1/16	4-7/16	Radio Sets, Test Equipments	
BA-25	Screw & Knurled Nut	2.4	5		2-5/8 Diam.	6-1/8	6-11/16	Switchboards, Test Sets, Radio Sets	
BA-30/BA-130 ^c	Flat Cap	0.25	1	2-11/16	1-11/32 Diam.	2-11/32	2-13/32	Radio Sets, Test Sets, Telephone	
BA-35	Screw & Nut	1.5	5		2-11/16	4	4-5/16	Radio Sets, Test Sets	
BA-37	Flat Cap	0.63	1		1-11/32 Diam.	6-1/8	6-7/32	Radio Sets	
BA-42	Flat Cap	0.13	1		1-1/32 Diam.	1-29/32	1-29/32	Test Equipments	
BA-58	Flat Cap	.031	1		37/64 Diam.	1-29/32	1-31/32	Test Sets	
BA-65	Socket (2 Hole)	1.5	9	2-5/8	2-5/8	4-1/16	4-1/16	Radio Sets	
BA-202/UF ^d	Flat Cap	0.25	1		1-11/32 Diam.	2-3/8	2-7/16	Photo Flash, Only	
3 - VOLT									
BA-1	Flat Cap	0.63	1	1-1/8	1-11/32 Diam.	6-1/16	6-1/8	Test Sets, Telegraph Sets	
BA-50	Wire Coil Socket	0.10	16	2-11/16	9/16	2	2-3/8	Meteorological	
BA-204/U	Socket	0.88	5	2-11/16	1-11/16	4-5/16	4-3/8	Blasting	
BA-205/U	Screw & Nut	0.88	5	2-11/16	1-5/16	4-1/16	4-9/16	Radio Sets, Test Set	
BA-208/U	Flat Spring	0.13	2	1-5/16	11/16	2-1/4	2-5/8	Meteorological	
BA-209/U	Flat Cap	0.25	1		1-1/32 Diam.	3-7/8	3-15/16	Meteorological	
4.5 - VOLT									
BA-9	Flat Spring	0.38	2	2-17/32	27/32	2-5/8	3-1/16	Radio Sets	
BA-23	Flat Spring	0.25	2	2-1/16	11/16	2-5/16	2-11/16	Sound Ranging Set	
BA-31	Screw & Nut	0.38	5	2-13/32	27/32	2-23/32	3-3/16	Test Sets	
BA-216/U	Spring Clip	4.5	3	3-15/16	3-15/16	5-7/16	5-15/16	Radio Sets, Telephone	
6 - VOLT									
BA-44	Screw & Nut	9	5	10-1/2	2-3/4	6-3/4	7-1/2 ^e	Trailer Brakes	
BA-200/U	Spring Type	1.5	19	2-11/16	2-11/16	3-15/16	4-5/8	Lanterns	
BA-203/U	Socket	3.25	9	3-15/16	2-25/32	5-9/16	5-9/16	Radio, Test and Detector Sets	
BA-210/U	Socket	1.5	5	2-5/8	2-5/8	4	4	Radio Receiving Sets	
BA-222/U	Insulated Nut & Screw	5.38	6	8-1/4	2-3/4	5-13/16	5-3/8	Signal Light	

^a Figures are typical and not actual arrangements of contacts in all instances.

^b For further details see Dry Battery Supply Data SB 11-6.

^c This battery is a low temperature type corresponding to the conventional type bearing a nomenclature number which is 100 smaller, e.g., Battery BA-102 corresponds to BA-2. The two batteries are physically identical and electrically interchangeable, except that the low temperature type has a better service life at low temperature.

^d BA-202/UF is similar to BA-30 except for a high flash current characteristic.

^e Web stamp does not project beyond terminals except when used as a handle. Dimension includes space occupied by terminals.

DRY BATTERIES - DESCRIPTION - SINGLE UNIT TYPES (Continued)

Type No.	Terminals ^a		Weight In Operation (Lbs)	Dimensions (Inches)			Application ^b
	Type	Fig. 1294 Sketch No.		Length	Width	Height	
9 - VOLT							
BA-206/U	Insulated Nut & Screw	6	15.5	7-7/8	5-5/16	6-13/16	Tool Equipment Searchlight
BA-207/U	Insulated Nut & Screw	6	9.5	8-9/16	4-1/16	5-15/16	
22.5 - VOLT							
BA-2/BA-102 ^c	Flexible Lead	4	1.0	3-1/2	2-3/32	2-21/32	Radio Sets, Test Sets
BA-8	Flexible Leads	4	4.5	6-5/8	4-1/8	3-1/8	
BA-211/U	Socket	12	1.5	4-1/8	2-19/32	3	
BA-219/U	Spring Clip	3	1.25	4-1/4	2-5/8	2-13/16	
45 - VOLT							
BA-56	Snap Fasteners	13	0.63	2-9/16	31/32	3-41/64	Monitor, Radio Receivers Test Equipment
BA-59	Socket (5 holes)	15	2	3-17/32	1-3/4	5-1/2	
OVER 45 VOLT							
BA-33/BA-136 ^d	Flat Cap	1	1.25	1-11/32	1-11/32	11-21/32	Radio Sets, Detector Sets
BA-51	Snap Fastener	13	.88	2-11/16	1-3/8	3-11/16	
BA-215/U	Socket	6	4.75	6-1/8	5-5/16	3-3/16	

^aFigures are typical and not actual arrangements of contacts in all instances. For further details see Dry Battery Supply Data SB 11-6.

^cThis battery is a low temperature type corresponding to the conventional type bearing a nomenclature number which is 100 smaller, e.g., Battery BA-102 corresponds to BA-2. The two batteries are physically identical and electrically interchangeable, except that the low temperature type has a better service life at low temperature.

^d3/8" allowance has been made for space occupied by flexible lead.

^eTwo separate sockets each having single hole at same end of battery.

1226. DRY BATTERIES - DESCRIPTION - MULTIPLE UNIT TYPES.

Type No.	Terminal Volts	Terminals ^a		Fig. 1254 Sketch No.	Weight in Operation (Lbs)	Dimensions (Inches)			Application ^b	
		Type				Length	Width	Height		Overall Height
BA-26	22.5, 45	Spring Clip		3	12.9	8-1/4	4-1/2	7-3/8	7-15/16	
BA-27/BA-127c	-1.5, -3, -4.5	Screw & Nut		5	1	4-1/16	1-1/2	3-1/8	3-1/2	Radio sets
BA-32	3 "A" Unit 144 "B" Unit -13.5 "C" Unit 4.5 "M" Unit	Socket (5 hole)		17	14	8	5	6-15/16	7-7/32	Radio sets
BA-33	45 135	Insulated Nut & Screw		7	6	6-1/4	3-9/16	5-3/16	5-3/4	Test sets
BA-34	-1.5, -3, -4.5, -6, -7.5	Screw & Nut, -7.5 has Flexible Lead		4 & 5	0.6	4-1/8	7/8	2-7/8	3-3/8	Test sets
BA-36	22.5, 45	Screw & Nut		5	3.4	4-1/4	2-9/16	5-7/8	6-3/8	Radio sets, test sets & telephone repeaters
BA-39/BA-139c	7.5 "A" Unit 150 "B" Unit	Socket (5 hole)		20	8.8	6-1/2	3-13/16	7-1/8	7-9/16	Radio sets
BA-40/BA-140c	1.5 "A" Unit 90 "B" Unit	Socket (4 hole)		21	7.8	5-5/16	4-1/8	7	7-7/16	Radio sets
BA-41	4.5 "A" Unit 25.5 "B" Unit 60 "B ₂ " Unit	Socket (5 hole)		12	1	2-3/8	2-1/8	3-1/2	3-1/2	Radio sets
BA-43	1.5 "A" Unit 90 "B" Unit -45 "C" Unit	Socket (8 hole)		10	5.1	3-7/8	3-31/32	7-1/16	7-1/4 ^d	Radio sets
BA-46	1.5 "A" Unit 90 "B" Unit	Socket (4 hole)		21	5.5	10	2-7/32	4-7/8	4-7/8	Radio sets

^aFigures are typical and not actual arrangements of contacts in all instances.

^bFor further details see Dry Battery Supply Data SB 11-6.

^cThis battery is a low temperature type corresponding to the conventional type bearing a nomenclature number which is 100 smaller, e.g., Battery BA-102 corresponds to BA-2. The two batteries are physically identical and electrically interchangeable, except that the low temperature type has a better service life at low temperature.

^dAllowance has been made for space occupied by the web strap.

DRY BATTERIES - DESCRIPTION - MULTIPLE UNIT TYPES. (CONTINUED)

Type No.	Terminal		Type	Fig. 1254 Sketch No.	Weight in Operation (lbs)	Dimensions (Inches)			Application ^b	
	Volts	Terminal ^a				Length	Width	Height		Overall Height
BA-49	1.5 "A" Unit 67.5 "B" Unit 67.5 "B ₂ " Unit		Socket (5 hole) Plus 2 Outside Holes in Top	11	2.5	5-9/16	1-1/2	6-9/16	6-9/16 ^c	Radio sets
BA-53	22.5, 45		Screw & Nut	5	1.63	3-1/16	1-15/16	4-9/16	5-1/8	Test sets
BA-63	22.5, 45		Socket (5 hole)	8	1.5	3	2-5/16	4-1/8	4-1/8	Radio sets
BA-67	3 "A" Unit 90 "B" Unit		Socket (3 hole)	14	1.6	4-1/16	1-15/16	4-9/16	4-9/16	Meteorological
BA-70	4.5 "A" Unit 90 "B ₁ " Unit 60 "B ₂ " Unit		Socket (8 hole)	18	16	10-3/8	4-9/16	7-7/8	3-7/32	Radio sets
BA-80	4.5 "A" Unit 90 "B ₁ " Unit 60 "B ₂ " Unit		Socket (8 hole)	18	9	10-3/8	4-9/16	4-3/4	5-1/8	Radio sets
BA-201/CEH-1	9 "A" Unit 67.5 "B" Unit		Socket	21	13.5	5-11/16	Diam.	15-1/2	15-1/2	Radio transmitting equip.
BA-212/U	1.5 "A" Unit 90 "B" Unit		Socket	21	25	15-7/8	4-9/16	7	7	Form radio
BA-213/U	3 "A" Unit 162 "B" Unit -12 "C" Unit		Socket	12	8.5	8-1/2	4-11/16	4-1/8	4-1/8	Radio sets
BA-214/U	6, 12		Screw & Nut & Flexible Lead	4 & 5	0.8	3-23/32	1-25/32	2-15/32	2-25/32	Radio sets
BA-217/U	12, 22.5		Flexible Lead	4	1.3	4-1/4	3-5/8	2-13/16	3-3/16 ^d	Radio sets
BA-218/U	3 "A" Unit 1.5 1 1/2 "B" Unit 156 "B" Unit -7.5 "C" Unit		Socket	12	15	9-3/8	6-9/16	4-3/8	4-3/8	Radio sets
BA-220/U	1.5 "A" Unit 90 "B" Unit		Socket	21	5	8-1/8	2-11/32	4-25/32	4-25/32	Radio sets
BA-221/U	1.5 "A" Unit 67.5 "B ₁ " Unit 13.5 "B ₂ " Unit -6 "C" Unit		Socket	15	2.3	3-21/32	1-27/32	6-9/16	6-9/16	Radio sets

^a Figures are typical and not actual arrangements of contacts in all instances.

^b For further details see Dry Battery Supply Data SB 11-6.

^c Ring does not project beyond flange on bottom of the battery, except when used as handle. Dimension includes space occupied by flange.

^d 3/8" allowance has been made for space occupied by flexible lead.

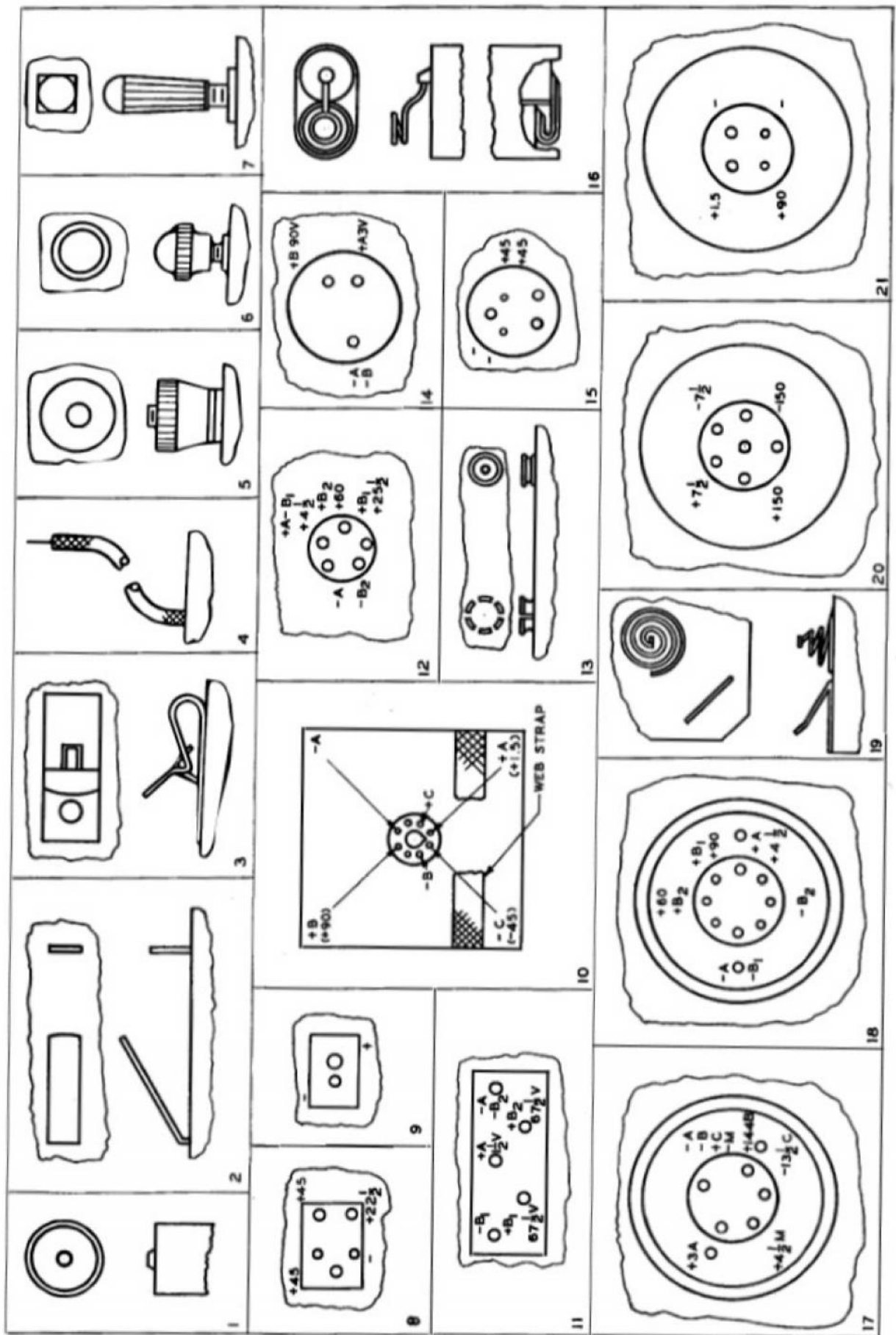

FIGURE 1254. Dry Battery Terminal Arrangements

1227. DRY BATTERIES - STOCK NUMBERS AND COMMERCIAL EQUIVALENTS.

May, 1927

Type No. ^a	Stock No.	Terminal Voltage	Commercial Equivalents ^a					Bright Star	Bond	General Dry	No. of Batteries per Sealed Unit Package ^b
			National Carbon	Ray-O-Vac	Burgess	Marathon	U.S. Electric				
BA-1	3A1	3								12	
BA-2/BA-102	3A2	22.5	763		4156				H15A	6	
BA-8	3A8	22.5								1	
BA-9	3A9	4.5	703		552	350			H3BF	5	
BA-15-A	3A15A	1.5			2FBP					8	
BA-23	3A23	1.5	6 7111	6				6A		5	
BA-26	3A26	22.5, 45								1	
BA-27/BA-127	3A27	-1/5, -3, -4.5	761-F							8	
BA-28	3A28	4.5	751		432					9	
BA-30/BA-130	3A30	1.5	950 1050	2IP	2		995		D	25	
BA-31	3A31	4.5	781		5360 F3SPG				H3B	5	
BA-32	3A32	3 "A" Unit 144 "B" Unit -13.5 "C" Unit 4.5 "M" Unit								1	
BA-33	3A33	45, 135								1	
BA-34	3A34	-1.5, -3, -4.5 -6, -7.5	773	551	5540					4	
BA-35	3A35	1.5		94-1S	4PH			462	4F1S	4	
BA-36	3A36	22.5, 45	762-S		5308					3	
BA-37	3A37	1.5								12	
BA-38/BA-138	3A38	103.5			XI69					12	
BA-39/BA-139	3A39	7.5 "A" Unit 150 "B" Unit			F5A100					1	
BA-40/BA-140	3A40	1.5 "A" Unit 90 "B" Unit			4CB60					1	

^aThe type shown in extreme left hand column may be used to replace any of the other types in the same horizontal line. The data are not to be used in a reverse direction.

^bDry Batteries should be ordered in sealed unit packages whenever possible.

Type No. ^a	Stock No.	Terminal Voltage	Commercial Equivalents ^a						No. of Batteries Per Sealed Unit Package ^b
			National Carbon	Ray-O-Vac	Burgess	Marathon Electric	Bright Star	General Dry	
BA-41	3A41	4.5 "A" Unit 25.5 "B ₁ " Unit 60 "B ₂ " Unit							1
BA-42	3A42	1.5	935	11P	1	110	101	C	25
BA-43	3A43	1.5 "A" Unit 90 "B" Unit -45 "C" Unit							1
BA-44	3A44	6	141 1461	641		640			1
BA-46	3A46	1.5 "A" Unit 90 "B" Unit			6TA60				1
BA-49	3A49	1.5 "A" Unit 67.5 "B ₁ " Unit 67.5 "B ₂ " Unit							1
BA-50	3A50	3	X91						18
BA-51	3A51	67.5	457	P4367		IX45			5
BA-53	3A53	22.5, 45				Z50N			1
BA-56	3A56	45	455			IX50			5
BA-58	3A58	1.5	915	7R	Z	170	908	59 AA	12
BA-59	3A59	45	482	P7830		M30			1
BA-63	3A63	22.5, 45	758	P7850		Z50		V30AA	3
BA-65	3A65	1.5	742	P94A		4F			5
BA-67	3A67	5 "A" Unit 90 "B" Unit	X442-A			4X2W60			4
BA-70	3A70	4.5 "A" Unit 90 "B ₁ " Unit 60 "B ₂ " Unit							1

^aThe type shown in extreme left hand column may be used to replace any of the other types in the same horizontal line. The data are not to be used in a reverse direction.

^bDry Batteries should be ordered in sealed unit packages whenever possible.

Table continued on next page

DRY BATTERIES - STOCK NUMBERS AND COMMERCIAL EQUIVALENTS. (CONTINUED)

Type No. ^a	Stock No.	Terminal Voltage	Commercial Equivalents ^a					U.S. Electric	Bright Star	General Dry	No. of Batteries Per Sealed Unit Package ^b
			National Carbon	Ray-O-Vac	Purgess	Marathon	Bond				
BA-80	3A80	4.5 "A" Unit 90 "B ₁ " Unit 60 "B ₂ " Unit								1	
BA-200/U	3A275-200	6	409 509	941	F4H	490		460 HD460	V4P	5	
BA-201/CEN-1	3A275-201	9 "A" 675 "B"								1	
BA-202/UF	3A275-202	1.5					10P			25	
BA-203/U	3A275-203	6	718	P698A	2P4	896		4829	8P4	1	
BA-204/U	3A275-204	3	704		F2RT					8	
BA-205/U	3A275-205	3			F2BP					5	
BA-206/U	3A275-206	9	1662	661B						1	
BA-207/U	3A275-207	9			4P6H					1	
BA-208/U	3A275-208	3	750		422		50-17			6	
BA-209/U	3A275-209	3	C791A		122		991	91-17M		25	
BA-210/U	3A275-210	6			F4P1					5	
BA-211/U	3A275-211	3, 4.5, 16.5, 22.5	768							1	
BA-212/U	3A275-212	1.5 "A" Unit 90 "B" Unit	748							1	
BA-213/U	3A275-213	3 "A" Unit 162 "B" Unit 12 Tap								1	
BA-214/U	3A275-214	6, 12									
BA-215/U	3A275-215	63									
BA-216/U	3A275-216	4.5			4P3H						
BA-217/U	3A275-217	12, 22.5	5151	5151	5156			1503	H15B(S)		

Type No. ^a	Stock No.	Terminal Voltage	Commercial Equivalents ^b					No. of Batteries Per Sealed Unit Package
			National Carbon	Ray-O-Vac	Hurress	Marathon	U.S. Electric	
BA-218/U	3A275-218	3 "A1" Unit			2F2B108			10CB-9G
		1.5 "A2" Unit						
		156 "B" Unit						
		-7.5 "C" Unit						
BA-219/U	3A275-219	22.5	77B-1					
BA-220/U	3A275-220	1.5 "A" Unit			4TA60			
		90 "B" Unit						
BA-221/U	3A275-221	1.5 "A" Unit	X444		8ML190M4			
		67.5 "B1" Unit						
		135 "B2" Unit						
		-6 "C" Unit						
BA-222/U	3A275-222	6			4F4H			

^aThe type shown in extreme left band column may be used to replace any of the other types in the same horizontal line. The data are not to be used in a reverse direction.

^bDry Batteries should be ordered in sealed unit packages whenever possible.

Section VI
Commercial Power Services

1228. GENERAL. The purpose of this section is to summarize and list the prevailing electrical frequencies, voltage, etc. of the commercial power supplies of the world. The power distribution frequencies and voltages for foreign countries are listed in paragraphs 1230, 1231 and 1232 respectively.

1229. DISTRIBUTION.

a. Frequencies.

(1) **50 Cycles:** This is the preferred or most prevalent frequency in all of Europe, all of Asia except Manchuria and North Borneo, which have 60 cycles, all of Africa except Belgian Congo, which has 60 cycles, all of Australia except a few towns in west, where 40 cycles prevails, all of Oceania except Society Island British which has 60 cycles, and all of South America except Columbia, Ecuador, British Guiana, and Venezuela, all of which have 60 cycles. In North America some of the British, French, and Netherland West Indies have 50 cycles; also, in the United States a section in southern California operates on 50 cycles.

(2) **60 Cycles:** This is practically universal in the United States and all of its World Possessions except Canal Zone where 25 cycles prevails; in Canada except an area adjoining Niagara Falls in Ontario where 25 cycles is provided. It is also standard in Mexico and all of

Central America and in some of the British West Indies.

(3) Many of the countries where a frequency of 50 cycles prevails, have 60 and other frequencies to a lesser degree; also many of the countries where a frequency of 60 cycles prevails, have some 50 cycle areas. In the United States 25 cycles was formerly used to some extent and some large plants have not changed over. It is, however, practically extinct in the U. S. as a distribution system.

b. Voltages.

(1) **Great Britain:** The electrical authorities of Great Britain have adopted a scheme of unifying the electrical distribution systems of the entire country. Under this plan 230 volts has been selected as the standard pressure both for a-c and d-c supply. Other voltages now used will be changed over gradually. The frequency of the a-c supply will be 50 cycles. Attachment plugs are commonly of the round pin rather than the flat blade type.

(2) **United States:** Voltages in the United States are predominantly 110-120/200-240, 60 cycles, with a trend toward 120/208, 1 and 3 phase. A few cities also have 2 phase. Eleven large cities in the United States still have d-c loads from 5000 to 350,000 kw, in the business areas, but in most cases a-c is also available and is being used in new buildings and on major reconstruction.

1230. POWER DISTRIBUTION DATA - FOREIGN COUNTRIES AND CITIES

Countries & Cities of 200,000 Population & Over	D-C Voltage		A-C					
	Pref.	Other	Phase ^a		Freq. in Cyc.		Voltage ^b	
			Pref.	Other	Pref.	Other	Pref.	Other
ALASKA (par. 1232)								
ALBANIA	220	-	-	-	50	-	220	125,150
ALGERIA	220	-	-	-	50	-	*115	110,127
Algiers	-	-	3	-	50	-	115/200	-
ANGOLA	-	-	-	-	50	-	110	-
ARABIA	-	-	-	-	50	-	230	-
ARGENTINA	*220	-	-	-	50	60,43	*220	225
Avellaneda	-	-	3	-	50	-	220/380	-
Buenos Aires	220/440	-	3	-	50	-	220/380	-
Cordoba	-	-	3	-	50	-	220/380	-
Rosario	220/440	-	3	-	50	-	220/380	-
AUSTRALIA								
New South Wales	*240	-	-	-	50	-	*240	-
Sydney	240/480	-	3	-	50	-	240/415	-
Queensland	220	240	-	-	50	-	*240	-
Brisbane	-	-	3	-	50	-	240/415	-
So. Australia	200	230,220	3	-	50	-	*200	230,240
Adelaide	-	-	3	-	50	-	210/420	-
Tasmania	230	-	-	-	50	-	*240	-
Victoria	230	-	-	-	50	-	*230	-
Melbourne	230/460	-	3	-	50	-	230/400	-
West Australia	*220	110,230	-	-	40	-	250	-
Perth	-	-	3	-	40	-	240/440	-

Countries & Cities of 200,000 Population & Over	D-C Voltage		A-C					
	Prof.	Other	Phase ^a		Freq. in Cyc.		Voltage ^b	
			Prof.	Other	Prof.	Other	Prof.	Other
AUSTRIA	220 150	110	-	-	50	-	*220	120,127, 110, & Other
Vienna	-	-	3	-	50	-	220/380	-
AZORES	220	-	-	-	50	-	220	-
BELGIAN CONGO	-	-	-	-	60	-	220	-
BELGIUM	220	110,120	-	-	50	40	*220	127,110, 115,135, & Other
Antwerp	-	-	3	-	50	-	115/200	-
Brussels	-	-	3	-	50	-	110/190	-
BOLIVIA	110	-	-	-	50	60	*110	220
BRAZIL	-	-	-	-	50	60	127	120,220
Para	-	-	3	-	50	-	120/240	-
Pernambuco	220/440	-	3	-	50	-	220	-
Rio de Janeiro	-	-	3	-	50	-	125/216	-
Sao Paulo	-	-	3	-	60	-	120/208	-
BRITISH EAST AFRICA								
Kenya	-	-	-	-	50	-	240	-
Mauritius	-	-	-	-	50	60,100	230	110,100
Nyasaland	220	-	-	-	-	-	-	-
Tanganyika	220	-	-	-	-	-	-	-
Zanzibar	220	-	-	-	-	-	-	-
BRITISH GUIANA	-	-	-	-	60	50	110	-
BRITISH HONDURAS	110	-	-	-	-	-	-	-
BRITISH MALAYA								
Fed. Malay States	-	-	-	-	50	60,40	230	-
Non-Fed. Malay States	230	-	-	-	-	-	-	-
North Borneo	-	-	-	-	60	-	110	-
Straits Settlements	*230	-	-	-	50	-	230	-
Singapore	230/460	-	3	-	50	-	230/400	-
BRITISH WEST AFRICA								
Gambia	-	-	-	-	50	-	230	-
Gold Coast	*220	-	-	-	50	-	230	-
Nigeria	-	-	-	-	50	-	230	-
Sierra Leone	-	-	-	-	50	-	230	-
BRITISH WEST INDIES								
Antigua	220	-	-	-	-	-	-	-
Bahamas	-	-	-	-	60	-	115	-
Barbados	-	-	-	-	50	-	110	-
Bermuda	-	-	-	-	60	-	110	-
Dominica	220	-	-	-	-	-	-	-
Grenada	-	-	-	-	50	-	115	-
Jamaica	-	-	-	-	40	60	110	-
St. Kitts	240	-	-	-	-	-	-	-
Trinidad	-	-	-	-	60	-	110	220
HUNGARY	220	120	-	-	50	-	*220	120,150
Sofia	-	-	3	-	50	-	220/380	-
CANADA	110	-	-	-	60	25	*110	150,115, 230
Montreal	-	-	3	-	60	-	115/230	-
Toronto	-	-	3	-	25	-	115/230	-
Vancouver	-	-	3	-	60	-	110/220	-
Winnipeg	-	-	3	-	60	-	120/220	-
CANARY ISLANDS	110	-	-	-	50	-	*127	110
CEYLON	220	-	-	-	50	60	230	-
Colombo	220/440	-	3	-	50	-	230/400	-
CHILE	220	110	-	-	50	60	*220	-
Santiago	220/440	-	3	-	50	-	220/380	-
Valparaiso	220/440	-	3	-	50	-	220/380	-

a. In general, any 3-phase service can be used for single phase. For 110-120 volt equipment, it will be necessary to provide 2:1 transformers in many foreign countries where lighting service is in the 220-volt class.

b. *Where both a-c and d-c are available an asterisk (*) indicates the type of current and voltage which predominates. When approximately equal quantities of a-c and d-c are used an asterisk precedes each of the principal voltages.

Table continued on next page

POWER DISTRIBUTION DATA - FOREIGN COUNTRIES AND CITIES (Continued)

Countries & Cities of 200,000 Population & Over	D-C Voltage		A-C					
	Pref.	Other	Phase ^a		Freq. in Cyo.		Voltage ^b	
			Pref.	Other	Pref.	Other	Pref.	Other
CHINA	220	110	-	-	50	60,25	*110	220
							*200	
Amoy	-	-	3	-	60	-	110/220	-
Canton	-	-	3	-	60	-	220/380	-
							110/190	
Chungking	-	-	3	-	50	-	220/380	-
Foochow	-	-	3	-	50	-	220/380	-
Hankow	220/440	-	3	-	60	-	220/380	-
Hong Kong	-	-	3	-	50	-	200/350	-
Nanking	-	-	3	-	50	-	220/380	-
Ningpo	-	-	3	-	50	-	220/380	-
Peiping	-	-	3	-	50	-	220/380	-
Shanghai	-	-	3	-	50	-	200/350	110/190
Int. Settlement	-	-	3	-	50	-	220/380	-
Tientsin	-	-	3	-	50	-	220/380	-
Tsinan	-	-	3	-	50	-	220/380	-
							110/190	
Tsingtao	-	-	3	-	50	-	120/200	-
COLOMBIA	-	-	-	-	50	60	*110	220/150
Bogota	-	-	3	-	60	-	150/260	-
COSTA RICA	110	-	-	-	-	-	*110	-
CUBA	110	220	-	-	60	-	*110	220
Havana	-	-	3	-	60	-	110/220	-
CYPRUS	*220	-	-	-	50	-	110	-
CZECHOSLOVAKIA	220	120,150	-	-	50	42	*220	110,115
	150	Various						127
	110							Various
Brno	-	-	3	-	50	-	110/220/380	-
Praha	-	-	3	-	50	-	120/220/380	-
DEMMARK	220	110	-	-	50	-	*220	120,127
Copenhagen	220/440	-	3	-	50	-	220/380	-
							127/220	
DOMINICAN REP.	110	-	-	-	60	-	*110	120
ECUADOR	-	-	-	-	60	-	*110	-
EGYPT	220	-	-	-	50	40	200	110,220,
								110
Alexandria	-	-	1	-	50	-	115/230	-
Cairo	110	-	1	-	40	-	100/200	-
IRE	*220	-	-	-	50	-	*220	200
Belfast	-	-	3	-	50	-	220/380	-
Dublin	-	-	3	-	50	-	220/380	-
ESTONIA	*220	110	-	-	50	-	220	127
ETHIOPIA	-	-	-	-	50	-	220	250
FIJI ISLANDS	240	110,250	-	-	-	-	-	-
FINLAND	*120	220,110	-	-	50	-	220	120,115,
								110
Helsingfors	225/450	-	3	-	50	-	127/220	-
FRANCE	110	220,120,	-	-	50	25	*110	120,125
		125					*115	115,220,230
Bordeaux	110	-	3	-	50	-	115/200	-
Lille	120	-	3	-	50	-	120/208	-
Nice	110	-	3	-	25	-	110/190	-
Paris	-	-	3	-	50	-	110/190	-
FRENCH INDO-CHINA	110	120,220,	-	-	50	-	*120	*220,110,
		240						115,240
FRENCH WEST INDIES								
Guadeloupe	-	-	-	-	-	-	120	-
Martinique	110	-	-	-	50	-	*110	-

a. In general, any 3-phase service can be used for single phase. For 110-120 volt equipment, it will be necessary to provide 2:1 transformers in many foreign countries where lighting service is in the 220-volt class.

b. *Where both a-c and d-c are available an asterisk (*) indicates the type of current and voltage which predominates. When approximately equal quantities of a-c and d-c are used an asterisk precedes each of the principal voltages.

Countries & Cities of 200,000 Population & Over	D-C Voltage		A-C					
	Prof.	Other	Phase ^a		Freq. in Cyc.		Voltage ^b	
			Prof.	Other	Prof.	Other	Prof.	Other
GERMANY	220	110,120 250	-	-	50	25	*220	127,120, 110
Altona	220/440 110	-	3	-	50	-	220/380	-
Berlin-Greater	220/440	-	3	-	50	-	220/380	-
Bochum	-	-	3	-	50	-	220/380	-
Bresen	-	-	3	-	50	-	127/220 230/400	-
Breslau	-	-	3	-	50	-	125/216 220/380	-
Ghemnitz	-	-	3	-	50	-	120	-
Dortmund	220/440 110	-	3	-	50	-	220/380 125/216	-
Dresden	-	-	3	-	50	-	220/380 110/220 220/380	-
Dusseldorf	110	-	3	-	50	-	220/380	-
Essen	110	-	3	-	50	-	220/380	-
Frankfort	-	-	3	-	50	-	220/380 127/220	-
Halle	220/440	-	3	-	50	-	220/380	-
Hamburg	220/440 110	-	3	-	50	-	220/380	-
Kiel	220/440	-	3	-	50	-	220/380	-
Konigsberg	-	-	3	-	50	-	220	-
Leipzig	220/440	-	3	-	50	-	220/380	-
Medgeburg	-	-	3	-	50	-	220/380 230/400	-
Mannheim	-	-	3	-	50	-	220/380 127/220	-
Munich	220/440 110	-	3	-	50	-	220/380	-
Stettin	220/440	-	3	-	50	-	220/380	-
Stuttgart	220/440 110	-	3	-	50	-	220/380 127/220	-
CYPRUS	440	-	-	-	76	-	*110	-
GOZO, ISLAND OF	-	-	-	-	50	-	110	-
GREAT BRITAIN (See United Kingdom)								
GREECE	*220	110,150	-	-	50	-	*127	110,220
Athens	-	-	3	-	50	-	220/380	-
Piraeus	230/460	-	3	-	50	-	220/380 200/346	-
Saloniki	220/440	-	-	-	-	-	-	-
GUAM	-	-	-	-	60	-	110	-
GUATEMALA	220	125	-	-	60	50	*110	220
HAITI	-	-	-	-	60	50	*110	220
HAWAII	-	-	1 & 3	-	60	-	110-115/ 220-230	-
HONDURAS	110	220	-	-	60	-	*110	220
HUNGARY	220	110,120	-	-	42	50	*100 *105 *110	220,120 Various
Budapest	110	-	3	-	50	-	220/380	-
ICELAND	-	-	-	-	50	-	220	-

a. In general, any 3-phase service can be used for single phase. For 110-120 volt equipment, it will be necessary to provide 2:1 transformers in many foreign countries where lighting service is in the 220-volt class.

b. *Where both a-c and d-c are available an asterisk (*) indicates the type of current and voltage which predominates. When approximately equal quantities of a-c and d-c are used an asterisk precedes each of the principal voltages.

Table continued on next page

POWER DISTRIBUTION DATA - FOREIGN COUNTRIES AND CITIES (Continued)

Countries & Cities of 200,000 Population & Over	D-C Voltage		Phase*		A-C			
	Pref.	Other	Phase*		Freq. in Cyc.		Voltage ^o	
			Pref.	Other	Pref.	Other	Pref.	Other
INDIA	220	110,225 230,250	-	-	50	25	230	220,110 Various
Agra	-	-	3	-	50	-	230/400	-
Ahmedabad	-	-	3	-	50	-	230/400	-
Amritsar	220/440	-	3	-	50	-	230/400	-
Bangalore	-	-	1	-	60	-	220	-
Benares	-	-	3	-	50	-	230/400	-
Bombay	230/460	-	3	-	50	-	230/400	-
Calcutta	225/450	-	3	-	50	-	230/400	-
Cawnpore	225/450	-	3	-	50	-	230/400	-
Delhi	220/440	-	3	-	50	-	200/400	-
Hyderabad	-	-	3	-	50	-	220/380	-
Karachi	220/440	-	3	-	50	-	220/380	-
Lahore	220/440	-	3	-	50	-	220/380	-
Lucknow	230/460	-	3	-	50	-	230/400	-
Madras	225/450	-	3	-	50	-	250/400	-
Nagpur	220/440	-	3	-	50	-	230/400	-
Poona	220/440	-	3	-	50	-	230/400	-
IRAN	220	110	-	-	50	-	220	-
Tabriz	-	-	3	-	50	-	220/380	-
Teheran	-	-	3	-	50	-	220/380	-
IRAQ	*220	200	-	-	50	-	220	230
Bagdad	220/440	-	3	-	50	-	220/380	-
ITALIAN AFRICA								
Cyrenaica	150	-	-	-	50	-	*110	150
Eritrea	-	-	-	-	50	-	127	-
Libya (Tripoli)	-	-	-	-	*50	42,45	*125	110,270
Somaliland	120	-	-	-	50	-	*230	-
ITALY	110	125,150 220,250 160	-	-	*42	45	*150	125,120, 110,115, 120,260 220,135
Bologna	-	-	3	-	42	-	127/220	-
Catania	-	-	3	-	50	-	150/260	-
Florence	150/300	-	3	-	50	-	150/260	-
Genoa	-	-	3	-	50	-	150/260	-
	-	-	3	-	50	-	127/220	-
Messina	-	-	3	-	50	-	150/260	-
Milan	-	-	3	-	50	-	150/260	-
	-	-	3	-	42	-	144/250	-
Naples	220/440	-	3	-	50	-	150/260	-
Palermo	-	-	3	-	50	-	150/260	-
Rome	-	-	3	-	45	-	127/220	-
Trieste	-	-	3	-	42	-	127/220	-
Turin	-	-	3	-	50	-	127/220	-
Venice	-	-	3	-	42	-	127/220	-
JAPAN	100	-	-	-	50	60	*100	110
Dairen	-	-	3	-	50	-	110/220	-
Hiroshima	-	-	3	-	60	-	100/200	-
Kyoto	-	-	3	-	60	-	100/200	-
Tokio, Greater	-	-	3	-	50	-	100/200	-
	-	-	3	-	60	-	100/200	-
	-	-	3	-	50	-	*220	120
LATVIA	220	110	-	-	50	-	120/220/380	-
Riga	-	-	3	-	50	-	*220	-
LITHUANIA	220	110	-	-	50	-	*220	-
MADAGASCAR	-	-	-	-	50	-	120	-
MALTA	-	-	-	-	100	-	105	-
MANCHURIA	-	-	-	-	60	50,25	110	-
Harbin	-	-	3	-	50	-	135/234	-
Mukden	-	-	3	-	60	-	110/220	-
MEXICO	110	220	-	-	60	50	*110 *125	115,220 230

a. In general, any 3-phase service can be used for single phase. For 110-120 volt equipment, it will be necessary to provide 2:1 transformers in many foreign countries where lighting service is in the 220-volt class.

b. *Where both a-c and d-c are available an asterisk (*) indicates the type of current and voltage which predominates. When approximately equal quantities of a-c and d-c are used an asterisk precedes each of the principal voltages.

Countries & Cities of 200,000 Population & Over	D-C Voltage		A-C					
	Pref.	Other	Phase ^a		Freq. in Cyc.		Voltage ^b	
			Pref.	Other	Pref.	Other	Pref.	Other
MONACO	-	-	-	-	42	-	110	-
MOROCCO								
French	110	-	-	-	50	-	115	110
Spanish	200	-	-	-	50	-	*127	110,115
MOZAMBIQUE	220	120,240	-	-	50	-	240	120
NETHERLANDS	220	-	-	-	50	-	220	120,127
Amsterdam	-	-	3	-	50	-	220/360	-
Hague, The	-	-	3	-	50	-	127/220	-
Rotterdam	220/440	-	3	-	50	-	220/360	-
NETHERLANDS EAST INDIES								
Borneo	110	-	-	-	50	-	*127	110
Celebes	-	-	-	-	50	-	127	-
Java & Madura	220	110	-	-	50	-	*127	110,220
Batavia	-	-	3	-	50	-	127/220	-
Soerabaya	-	-	3	-	50	-	110/190	-
Soenda Islands	-	-	-	-	50	-	127	-
Sumatra	220	-	-	-	50	-	*127	220,110
NETHERLANDS WEST INDIES								
Curacao	-	-	-	-	50	-	127	-
NEW ZEALAND	230	-	-	-	50	-	*230	-
Auckland	230/460	-	3	-	50	-	230/400	-
NICARAGUA	110	-	-	-	60	-	*110	-
NORWAY	220	-	-	-	50	-	*220	150,127, *230 110, 120,150
Oslo	230/460	-	3	-	50	-	230	-
PALESTINE	-	-	-	-	50	-	220	-
PANAMA								
Republic	-	-	-	-	60	50	110	220
Canal Zone	-	-	-	-	25	-	110	-
PARAGUAY	*220	-	-	-	50	-	220	-
PERU								
Lima	-	-	3	-	60	-	220	-
PHILIPPINE ISLANDS	220	240,230	1 & 2	1 & 3	60	-	*220	230,110
POLAND	220	110	-	-	50	-	*220	120,110
Lwow	-	-	3	-	50	-	110/220	-
Poznan	-	-	3	-	50	-	220/360	-
Warsaw	-	-	3	-	50	-	120/220	-
PORTUGAL	220	150,125	-	-	50	42	*220	110,125
Lisbon	220/440	-	3	-	42	-	220/360	-
Oporto	-	-	3	-	50	-	110/190	-
Oporto	-	-	-	-	-	-	220/360	-
Oporto	-	-	-	-	-	-	110/190	-
PUERTO RICO	-	-	1 & 3	-	60	-	110- 115/220- 230	-
RUMANIA	*220	110,105 120	-	-	50	42	120	220,110, 115,105
Bucharest	-	-	3	-	50	-	120/208	-
RUSSIA	220	110,115, 220,250	-	-	50	-	*120	110,220
Baku	-	-	1 & 3	-	50	-	120/210	-
Karkov	-	-	1 & 3	-	50	-	110/190	-
Kiev	-	-	1 & 3	-	50	-	110	-
Leningrad	-	-	1 & 3	-	50	-	120	-
Moscow	-	-	1 & 3	-	50	-	120	-
SALVADOR	110	220	-	-	60	-	*110	-
SAMOA	-	-	-	-	50	-	110	-
SENEGAL	230	-	-	-	50	-	120	-
SOCIETY ISLANDS	-	-	-	-	60	-	120	-

a. In general, any 3-phase service can be used for single phase. For 110-120 volt equipment, it will be necessary to provide 2:1 transformers in many foreign countries where lighting service is in the 220-volt class.

b. *Where both a-c and d-c are available an asterisk (*) indicates the type of current and voltage which predominates. When approximately equal quantities of a-c and d-c are used an asterisk precedes each of the principal voltages.

Table continued on next page

POWER DISTRIBUTION DATA - FOREIGN COUNTRIES AND CITIES (Continued)

Countries & Cities of 200,000 Population & Over	D-C Voltage		A-C					
	Pref.	Other	Phase ^a		Freq. in Cye.		Voltage ^b	
			Pref.	Other	Pref.	Other	Pref.	Other
SPAIN	*110	120,115 105	-	-	50	-	*120	125,150, 110,115, 220,130
Madrid	120	-	3	-	50	-	120	-
Sevilla	110	-	3	-	50	-	127/220	-
SURINAM			(No Current Distributed)					
SWEDEN	220	110,120 115,250	-	-	50	20,25	*220	127,110, 125
Goteborg	-	-	3	-	50	-	120/380	-
Stockholm	220/440	-	3	-	50	-	220	-
SWITZERLAND	220	120,110 150	-	-	50	40	*120	145,150, *220 110,120 & Other
Zurich	-	-	3	-	50	-	220/380 125/220 145/250	-
	-	-	1	-	50	-	110/220 220/440	-
SYRIA	-	-	-	-	50	-	110	115,220
THAILAND	-	-	-	-	50	-	100	-
Bangkok	-	-	3	-	50	-	110/220	-
TUNISIA	110	-	-	-	50	-	*110	-
Tunis	-	-	3	-	50	-	110/190	-
TURKEY	220	110	-	-	50	-	*220	110
Istanbul	-	-	3	-	50	-	220/380 110/190	-
UNION OF SOUTH AFRICA	220	230,240 110	-	-	50	-	*220	230,240
Cape Town	-	-	3	-	-	-	-	-
UNITED KINGDOM (par. 1229b)	230	220,240	-	-	50	25,40	*230	240 & Other
Birmingham	220/240	-	3	-	50	-	230/400	-
Bradford	220/440	-	3	-	50	-	230/400	-
Bristol	250/500	-	3	-	50	-	210/365	-
Cardiff	200/400	-	3	-	50	-	200/230	-
Croydon	230/460	-	3	-	50	-	230/400	-
Edinburgh	230/460	-	3	-	50	-	230/400	-
Glasgow	250/500	-	3	-	50	-	250/440	-
Hull	220/440	-	3	-	50	-	230/400	-
Leeds	200/346	-	3	-	50	-	230/400	-
Leicester	220/440	-	3	-	50	-	240/415	-
Liverpool	230/460	-	3	-	50	-	230/400	-
London	-	Many	3	-	50	Various	230/400	Many
Manchester	200/400	-	3	-	50	-	230/400	-
Plymouth	-	-	3	-	50	-	230/400	-
Portsmouth	-	-	3	-	50	-	230/400 200/400	-
Salford	230/460	-	3	-	50	-	230/400	-
Sheffield	-	-	3	-	50	-	200/350	-
Stoke-on-T	220/440	-	3	-	50	-	240/415	-
URUGUAY	220	-	-	-	50	-	*220	-
Montevideo	-	-	3	-	50	-	220	-
VATICAN CITY	-	-	-	-	45	-	125	-
VENEZUELA	110	220	-	-	60	-	*110	-
VIRGIN ISLANDS	110	220	-	-	-	-	-	-
YUGO-SLAVIA	110	120	-	-	50	42	*120	220,150
Belgrade	-	-	3	-	50	-	220/380 59 120/206	-

a. In general, any 3-phase service can be used for single phase. For 110-120 volt equipment, it will be necessary to provide 2:1 transformers in many foreign countries where lighting service is in the 220-volt class.

b. *Where both a-c and d-c are available an asterisk (*) indicates the type of current and voltage which predominates. When approximately equal quantities of a-c and d-c are used an asterisk precedes each of the principal voltages.

1231. POWER DISTRIBUTION DATA FOR CANADA - BREAKDOWN BY PROVINCES
(MCGRAW CENTRAL STATION DIRECTORY - 1938)

Province	No. Listed Cities & Towns	Freq. in		Principal Volt-ages	Other Systems		Remarks
		Cycles	Phase		Voltage	Cycles	
Alberta	43	60	1 & 3	110/220	230,440	60	
British Columbia	53	60	1 & 3	110/220	-	-	
	5	25	1 & 3	110/220/440	-	-	a
	1	d-c	-	110	-	-	City Lighting 250 Pop.
Vancouver	-	60	1 & 3	110/230	-	-	
Manitoba	34	60	1 & 3	110-120/220-240	-	-	
New Brunswick	38	60	1 & 3	110-115/220-230	-	-	
St. John	-	60	1 & 3	110-115/220-230	440,550	-	60,500 Pop.
Newfoundland	16	60	1 & 2	110/220	-	-	
Nova Scotia	51	60	1 & 3	110-115/220-230	-	-	
New Waterford	-	60	1 & 3	110/220	-	25	5,615 Pop.
Ontario							
Various Utilities	100	60	1 & 3	110-120/220-230	550	60	110/220 mostly
	110	25	1 & 3	110-120/220-230	550	25	b
Hydro Elect. Pwr. Com. of Ontario	277	60	1 & 3	110-120/220-240	550	60	
Toronto	308	25	1 & 3	110-120/220-240	550	25	
	-	25	1 & 3	120/240/550	120/240	d-c	Buys from Hydro E.P.C.
Prince Edward Is.	5	60	1 & 3	115/230	-	-	
Quebec	Many Hundred	60	1 & 3	110-120/220-230	-	-	
Montreal	-	60	1 & 3	110/220/550	-	25	c
Saskatchewan	53	60	1 & 3	110-120/220-230	-	-	
Yokon Territory	2	60	1 & 3	110/220	-	-	

a. This 25-cycle supply is all supplied from Canadian Collieries of Nanaimo, which serve 5 small cities and towns with a total population of 14,280.

b. It is estimated that 80 per cent of the Ontario supply, within 150 miles of Niagara Falls, has a frequency of 25

cycles and about 20 per cent more than 150 miles from Niagara Falls, has a frequency of 60 cycles.

c. One company in Montreal (Beauharnois Light, Heat, & Power) is listed as generating both 60 and 25 cycle, but it is believed all the 25 cycle goes to two or three plants. Nothing but 60 cycle general distribution.

1232. POWER DISTRIBUTION DATA FOR ALASKA - BREAKDOWN BY CITIES

Town	Phase ^a	No. of Wires	Voltage	Popula- tion	Town	Phase ^a	No. of Wires	Voltage	Popula- tion
Anchorage	1 & 3	3	115/230	2277	Sitka	1 & 3	3	110/220	1056
Chichagoff	1 & 3	3	110	67	Skagway	1 & 2	4	120/240	492
Cordova	1 & 3	3	110/220	980	Valdez	1 & 2	4	110/220	442
Douglas	1 & 3	3	110/220	593	Wrangell	1 & 3	3	110/220	948
Eklutna	1 & 3	3	115/230	158					
Fairbanks	1 & 3	3	110/220/440	2101					
Hyder	1 & 3	4	110/220	254					
Juneau	1 & 3	3	110/220	4043					
Ketchikan	1 & 2	4	115/230	3796					
Nome	1 & 3	3	115	1213					
Petersburg	1 & 3	3	110/220	1252					
Seward	1 & 2	4	120/240	835					

a. All distributions 60 cycles a-c, principally 1 and 3 phase. 3 or 4 wire, 110/220 or 115/230 volts.

This Page Intentionally Blank

CHAPTER 13
MAINTENANCE SUPPLIES

Section I
General

1301. SCOPE.

a. This chapter includes a description of the supply plan for maintenance parts for Ground Signal Communications Equipments, and outlines the relationship of the Signal Supply Catalog to this plan. It also tabulates Maintenance, Tool, and Test Equipments and Test Sets which are applicable to Ground Signal Communications Equipments, with information as to nature and use of each. The succeeding part of the chapter is divided as follows:

- Section II - Maintenance
- Section III - Maintenance Equipments
- Section IV - Tool Equipments

- Section V - Test Equipments
- Section VI - Test Sets
- Section VII - Cross Reference Data

b. The tabulations of this chapter consist mainly of items having an assigned Signal Corps Nomenclature, i.e.; TE-, ME-, etc.; however certain other maintenance sets, apparatus or accessories which are applicable within the categories of each section, and which have not been assigned nomenclature, also are included.

Section II
Maintenance

1302. SYSTEM OF MAINTENANCE

a. Signal Corps maintenance follows the basic Army FIVE-ECHELON SYSTEM, which is illustrated in Figure 1301.

OPERATOR MAINTENANCE
Use, care, operation, adjustment, minor repairs and "plug-in" parts replacement of running spares.

USING UNIT MAINTENANCE
Unit mechanic of the using unit, such as radio repairmen, etc. Preventive maintenance, technical advice and inspection. Repair within limits of skill and replacements within stock of Organizational spare parts.

MOBILE REPAIR SHOP MAINTENANCE
Mobile Repair Units of Signal Repair Companies, Service groups, etc. Overhaul and repair, and carry limited stock of emergency repair parts.

SEMI-FIXED REPAIR SHOP MAINTENANCE
Repair Platoon of signal depot company and signal depot company aviation, at Army repair shops. Stock of repair parts and assemblies to serve all forward echelons.

FIXED REPAIR SHOP MAINTENANCE
Base Depot repair shop. Recondition material by reclamation and limited manufacture, mainly for return to Supply Depot stock.



FIGURE 1301. Echelons of Signal Repair Theater of Operations

b. The first and second echelons of repair, both being within the using organization, are known as "Organizational Maintenance".

c. The third, fourth and fifth echelons of maintenance are furnished by "Service Units":

- Third Echelon - by Division, Corps, or Army
- Fourth Echelon - by Army
- Fifth Echelon - by Communications Zone

d. Variations in the responsibilities of the echelons from those shown in the illustration may occur to a minor extent for specific equipments, due to the

nature of the equipment, or to peculiarities in its field of use. For example, a second echelon may for certain equipments perform third echelon repair, and be provided with corresponding repair part stocks, if the equipment is highly specialized and the second echelon repair man is of a specially trained type. In such cases, there will be no third echelon of repair as such.

e. The supporting depot supply of repair parts required for the initial and continued functioning of the five echelons of maintenance, is illustrated diagrammatically by figure 1302, insofar as the "Flow" of such supplies is concerned.

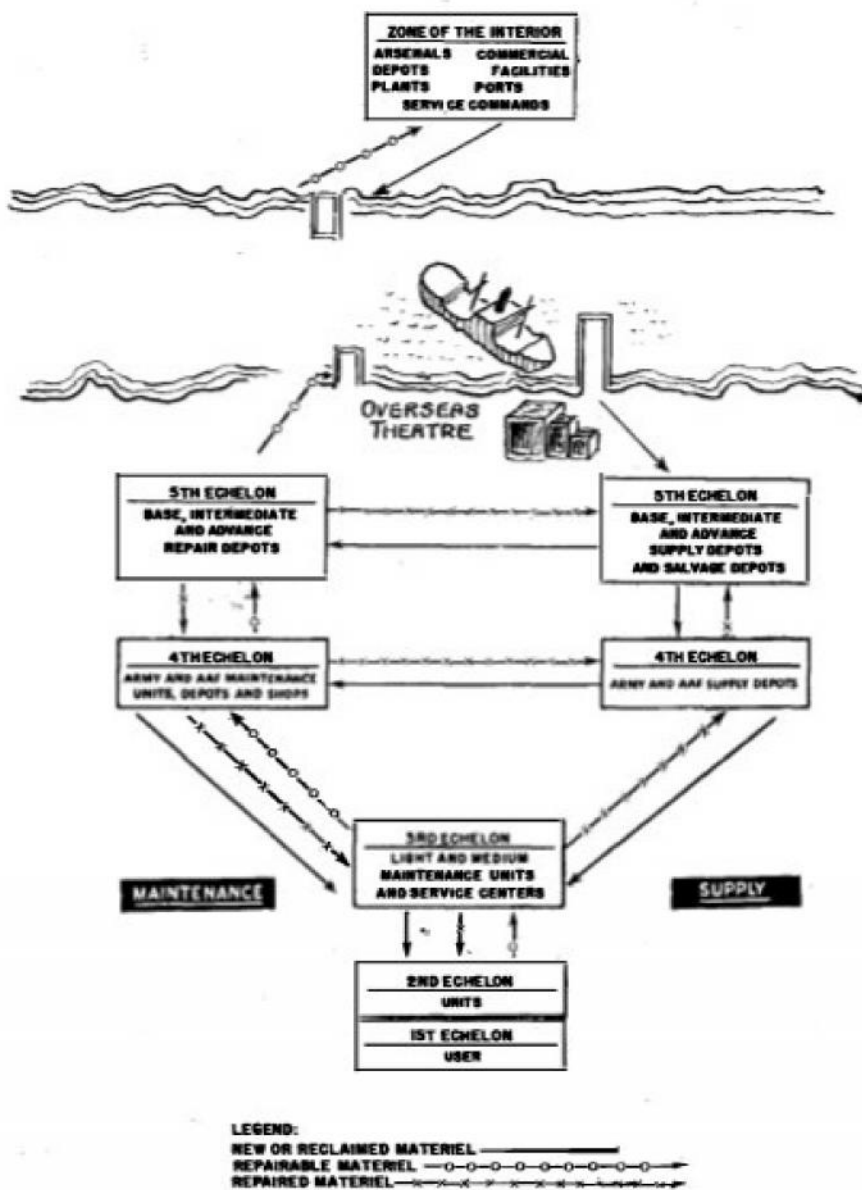

FIGURE 1302. Flow of Supplies - Thru Depot Supply Channels and Thru Maintenance Repair

1303. MAINTENANCE PARTS - SUPPLY PLAN.**a. General**

(1) The supply of maintenance parts to the field is based primarily on Supply Catalog sections SIG 7 and SIG 8 for tactical equipments and SIG 10 for fixed plant equipments.

(2) Two main categories of maintenance parts are available for the servicing and repair of communications equipment: those at the Front, consisting of running spares, organizational spares and 3rd Echelon spare parts; and the spare equipments and parts available at dumps and depots and their associated repair shops.

b. Expendable Supplies. Expendable supplies required by each organization but which are not included in SIG 7 or in Tables of Equipment are, in general, initially issued to newly activated organizations in accordance with section SIG 4-1 of the Supply Catalog. They are obtained by requisition on the basis of SIG 4-1.

c. Maintenance Parts. (1) Maintenance parts for theatres of operation are supplied generally in accordance with War Department Circular No. 227 1944, "Spare Parts Requirements, Procurement, and Issues".

(2) First and second echelon spares, as shown in SIG 7, are issued initially automatically, and thereafter by requisition.

(3) Third and fourth echelon spares are furnished from overseas depot stocks, however, when specific types of equipment for which an organization will provide maintenance can be determined in advance, issue may be made to the organization prior to its departure from the United States.

(4) Army depot spare parts stocks shown in SIG 8 are normally not issued to an organization departing for overseas, but such stock is drawn from the overseas base depot stock after arrival. Under special circumstances the initial issue of these parts may be made to army depot organizations, provided that the specific types and quantities of equipment which such organizations will support are known, and when the equipment is of such type that repair parts could not normally be expected to be already available within the theatre.

(5) Base depot spare parts stocks are furnished automatically to overseas base depots as a supply for all equipment being furnished to the theatre for the first time. Thereafter, automatic supply takes place only for substantial increases in like items previously furnished

to the theatre. In all other cases, maintenance parts are requisitioned by the overseas depot in accordance with theatre local stock control procedures, using SIG 8 as a guide. The supplies for base depot stock include stocks for the third and fourth echelon maintenance organizations and for the army depot, in quantities computed from SIG 8.

(6) Within the theatres, the distribution of maintenance parts for service and repair is usually in accordance with the maintenance parts lists of SIG 7 and SIG 8 for each equipment. Running spares of certain items, such as vacuum tubes, fuses, etc., are provided as a part of the issue equipment, and are carried either in the equipment or in accompanying chests. As these parts are expended replacements are requisitioned by item at convenient periods. The quantities of running spares which are provided with each equipment are shown in SIG 7. SIG 8 furnishes a list of maintenance parts, and quantities of parts to be used as a guide for issuance to higher echelons (third and fourth echelon and army and base depots). The quantities shown in SIG 8 are the allowable stocks which may be issued or maintained, but they do not constitute requirements for minimum mandatory issue.

1304. SIGNAL SUPPLY CATALOGS.

a. The Army Service Forces Catalogs include the Signal Supply Catalog (as authorized by ASF Circular No. 121; 1943). The Signal Supply Catalog will ultimately include all standard nomenclature lists, equipment lists, spare parts lists, allowances of expendable supplies, maintenance lists, and similar lists for requisition and issue, heretofore published by Circular or other medium.

b. The catalog sections do not supplant Tables of Allowances, Tables of Basic Allowances, Tables of Equipment, or Tables of Organization and Equipment; however, all items covered by these Tables are listed and detailed within the structure of the Signal Supply Catalog Sections.

c. All Sections of the Signal Supply Catalog and amendments thereto are distributed by the Adjutant General.

d. Paragraph 1305 indicates briefly the scope of each section of the Signal Supply Catalog.

1305. RELATIONSHIP OF SIGNAL SUPPLY CATALOG TO SUPPLY PLAN.

<u>Signal Supply Catalog</u>	<u>Title</u>	<u>Scope and Use</u>
SIG 1	INTRODUCTION	This section will include: (1) A guide to all sections of the Signal Supply Catalog, with explanations of their use. (2) Explanation of symbols and abbreviations used. (3) List of stock classes. (4) Sample requisition form, with explanation of its use. (5) Necessary cross references.
SIG 2	INDEX	
SIG 3	LIST OF ITEMS FOR TROOP ISSUE	Includes descriptive data and nomenclature for all items which appear in Tables of Equipment. Also includes certain assemblages, and nomenclature items which are subordinate to or dependent on items listed in the Tables of Equipment, and which may also appear in Catalog SIG 4-1; and some items which do not appear in Tables of Equipment but are considered of proper interest. Stock numbers, nomenclatures, net and packed weights and cubages are included. Purpose: To facilitate preparation of requisitions by unit commanders.
SIG 4-1	ALLOWANCES OF EXPENDABLE SUPPLIES FOR TROOP ISSUE	Lists expendable supply allowances according to using organizations, and also lists allowances of certain articles per unit of equipment. The quantities shown per organization or per unit of equipment are not periodic allowances, but are the maximum quantities authorized to be on hand. Formerly Signal Corps Circular No. 10-1, "Allowances of Spare Parts, Accessories, and Expendable Supplies", which it supersedes.
SIG 4-2	ALLOWANCES OF EXPENDABLE SUPPLIES FOR POSTS, CAMPS & STATIONS	Same as for Catalog SIG 4-1. Will supersede Signal Corps Circular No. 10-2.
SIG 5	STOCK LIST OF ALL ITEMS	A catalog of all items which have been assigned Signal Corps stock numbers. For the use of depots, procurement agencies and higher echelons in procurement, in keeping of property records, and the preparation of requisitions. Contains the stock number, nomenclature, identifying description, and units of measure for each listed item. Eventually will include unit price and indication of expendability of the items (Expendability is now indicated in Supply Bulletins 11-1 and 11-2). Listing is according to stock number.

Signal Supply Catalog	Title	Scope and Use
SIG 6	SETS	A set of sections, normally one pamphlet for each set of tool, test or maintenance equipment. Will list component items of these equipments.
SIG 7	ORGANIZATIONAL SPARE PARTS LISTS	One or more separate pamphlets for each important item of equipment, each containing the current issue lists of authorized equipment, including spare parts, for issue to the first and second echelons. The quantities shown are the authorized automatic initial issue, and the subsequent levels to which the organizational parts listed may be maintained by requisition. For the use of: All organizations using the equipment; all signal organizations charged with maintaining the equipment; all organizations or establishments charged with storing or issuing the equipment.
SIG 8	HIGHER ECHELON SPARE PARTS LISTS	One or more separate pamphlets for each equipment, containing a list of all parts for supply and maintenance, showing the quantity allowance for each part for the third and fourth echelons, the Army Depot Stocks, and the Base Depot Stocks. The quantities shown are not initial issue requirements; they are a guide for the determination of initial issue and subsequent stock levels. For use by all signal repair echelons higher than the second echelon charged with maintaining the equipment; all organizations or establishments charged with storing or issuing the equipment.
SIG 9		Not at present planned for issue.
SIG 10-1	FIXED PLANT MAINTENANCE LISTS - INSTRUCTIONS AND INDEX	A complete list of Fixed Plant Equipment arranged numerically and alphabetically by types of Equipment - Radio, Power, Wire, Teletype and Meteorological. Contains an index of maintenance lists arranged numerically by SIG 10 numbers; also a description of the SIG 10 Catalog.
SIG 10-2	FIXED PLANT MAINTENANCE LISTS - FACTOR TABLE, MFR. CODE NO. LIST, ABBREVIATIONS	Contains a factor table to be used to determine the quantities of parts to be stocked at stations, and for use as a guide for making initial issues to supply depots. Also contains a complete list of names of manufacturers of parts, and codes of manufacturers, and a list of abbreviations used in the SIG 10 catalog.
SIG 10-3	FIXED PLANT MAINTENANCE LISTS - EQUIPMENT FOR WHICH MAINTENANCE PARTS WILL NOT BE FURNISHED	Indicates equipment for which maintenance parts have not been procured.

Table continued on next page

RELATIONSHIP OF SIGNAL SUPPLY CATALOG TO SUPPLY PLAN. (Continued)

<u>Signal Supply Catalog</u>	<u>Title</u>	<u>Scope and Use</u>
SIG 10-4 to SIG 10-9	-	Not at present assigned.
SIG 10-10 to SIG 10-299	FIXED PLANT MAINTENANCE LISTS	Radio Transmitting Equipment Maintenance Parts Lists.
SIG 10-300 to SIG 10-399	FIXED PLANT MAINTENANCE LISTS	Radio Receiving Equipment Maintenance Parts Lists
SIG 10-400 to SIG 10-499	FIXED PLANT MAINTENANCE LISTS	Miscellaneous Radio Equipment Maintenance Parts Lists
SIG 10-500 to SIG 10-699	FIXED PLANT MAINTENANCE LISTS	Power Equipment Maintenance Parts Lists
SIG 10-700 to SIG 10-849	FIXED PLANT MAINTENANCE LISTS	Wire Equipment Maintenance Parts Lists
SIG 10-850 to SIG 10-899	FIXED PLANT MAINTENANCE LISTS	Teletype Equipment Maintenance Parts Lists
SIG 10-900 to SIG 10-925	FIXED PLANT MAINTENANCE LISTS	Meteorological Equipment Maintenance Parts Lists

Section III
Maintenance Equipments

1306. GENERAL.

a. Maintenance Equipments (ME's) as they currently exist, include a wide variety of types which may be generally defined as kits consisting of either maintenance parts, maintenance supplies, tools, test equipment, or any combination thereof issued initially as a unit to meet the needs of a particular type of organization which has repair and maintenance to perform on one or more signal equipments.

b. These equipments are of two principal classes, namely General Use parts, and Special parts grouped for the maintenance of specific equipments. Under current War Department policy, no new Maintenance Equipments (ME's) will be developed which contain special parts groups for maintenance of specific equipments. Provision for issue of such parts will be made in the spare parts lists in the appropriate SIG 7 and SIG 8 Catalog Sections.

c. Except for those cases where completely satisfactory Maintenance Equipments exist, Maintenance Equipments containing essentially spare parts for specific types of equipment will not be continued in use. The two types of Maintenance Equipments which will be continued in use, are as follows:

(1) Those containing parts commonly used in the maintenance and repair of

many types of communications equipment. Examples of this type are ME-9 and ME-10 which contain large assortments of general use screws, nuts, washers, wire and miscellaneous supplies.

(2) Those used as a means for the grouping of certain running spares, in order to facilitate initial issue and transportation.

d. In those cases where spare parts groups are retained as "Maintenance Equipments", the spare parts included in such an ME will appear as a maintenance list in the appropriate SIG 7 or SIG 8 catalog section, as a spare parts, that is, a maintenance parts list for the equipment to which they apply. A note on such lists indicates those parts which are carried by a certain Maintenance Equipment.

e. Such Maintenance Equipments ((1) and (2) above) will be authorized on Tables of Equipment or SIG 4-1 and described, in detail, by a publication of the parts lists in SIG 6 section of the Supply catalog.

1307. DESCRIPTION AND STOCK NUMBERS.

a. Paragraph 1306 gives a description of the maintenance equipments used in connection with signal equipment including some ME's which are cancelled or replaced by other ME's. These are listed for reference purposes. Replacement information is given when available.

b. Paragraph 1309 gives stock numbers, weights and volumes of the maintenance equipments listed in paragraph 1306.

1308. MAINTENANCE EQUIPMENTS - DESCRIPTION

Name	Nomenclature Type No.	Used for	Principal Users (See also Sig 4-1 and Tables of Equipment)	Description and Remarks
Maintenance Equipment	ME-4	Switchboard ED-80(TC-1) Switchboard ED-110(TC-10)	Sig. Opn. Cos.	Consists principally of miscellaneous small general use hardware with switchboard wire and power wiring accessories. Space provided for items in Chest CE-54. Part of Telephone Central Office Sets TC-1 and TC-10.
Maintenance Equipment	ME-6	Switchboard ED-89-A(TC-2)	Sig. Opn. Cos.	Consists principally of miscellaneous small general use hardware with cross-connecting wire and power wiring accessories. Space provided for items in Chest CE-59. Part of Telephone Central Office Set TC-2.
Maintenance Equipment	ME-7	Teletypewriter TC-7-() Line Unit BE-72 Teletypewriter, Model 15, commercial	See ME-80	Chest CE-69 containing a large assortment of maintenance parts for 15 teletypewriter sets; includes magnet coil, contact springs, motor brushes, special springs, screws, washers, fuses, oil, grease, ribbon etc; one-third of parts made up into 5 complete service kits; for 2nd and 3rd Echelon maintenance. Replaced by ME-80.
Maintenance Equipment	ME-9-()	Radio set repair and maintenance	Sig. Dep. Co. Sig. Rep. Co. Sig. Bn. Sig. Co. Inf. Div. Sig. Co. Arm. Div. Sig. Tr. Cav. Div. Sig. Serv. Org. Sig. Port. Serv. Co.	Large assortment of general use screws, nuts, bolts, and plugs, terminals, insulating tubing, shielding, bakelite plates and small wire for radio set repair. Used with radio repair truck. Available on requisition in accordance with Cat. SIG 4-1.
Maintenance Equipment	ME-10	Telephone and telegraph equipment repair and maintenance	Sig. Dep. Co. Sig. Rep. Co. Sig. Instl. Co. Sig. Serv. Org. Sig. Co. Inf. Div. Sig. Co. Arm. Div.	Large assortment principally of general use screws, nuts, and washers, wire, miscellaneous supplies, such as cloth, sandpaper, carbon tetrachloride. Available on requisition in accordance with Cat. SIG 4-1.
Maintenance Equipment	ME-11	Switchboard ED-96(TC-4). Panel ED-97	Sig. Opn. Co. Sig. Co. Inf. Div. Sig. Co. Arm. Div. Sig. Dep. Co. Sig. Tr. Cav. Div. Sig. Co. Amph. Sig. Co. Serv. Gp.	Chest CE-65 containing tools for 1st and 2nd Echelon maintenance of Switchboard ED-96 and Panel ED-97 (pliers, screwdrivers, soldering iron, drop light, wrench, etc.) and some maintenance parts (fuses, binding posts, cordage, ground rod, etc.). Part of Telephone Central Office Set TC-4.

MAINTENANCE EQUIPMENTS - DESCRIPTION (Continued)

Principal Users
(See also Sig 4-1
and Tables of
Equipment)

<u>Name</u>	<u>Nomenclature</u>	<u>Type No.</u>	<u>Used for</u>	<u>Description and Remarks</u>
Maintenance Equipment	ME-13-()		Radio Set SCR-509 " SCR-510 " SCR-609 " SCR-610 " SCR-619	Chest CH-71-() containing Oscillator VO-4-(), Voltammeter I-107, alignment tools and miscellaneous items with spare tubes and batteries for the included test instruments. For alignment of radio sets. Replaced by ME-73. TM 11-306C and D.
Maintenance Equipment	ME-14-()		Model HD Earth Boring Machine (Earth borer and pole setter) on Truck K-44-()	Large assortment of heavy spare parts for maintenance of earth borer and pole setting trucks; consists of parts for boring head, leveling worm, supporting case, clutch & brake, derrick & sheave, strap sheave and auger assembly. Used with but not part of Truck K-44-().
Maintenance Equipment	ME-15		1M Pole Derrick on Truck K-43-()	Spare parts for maintenance of pole derrick; includes foot, legs, sections, sheave, etc. Used with but not part of Truck K-43-().
Maintenance Equipment	ME-16-()		Winch L-18 on Trucks K-43-() and K-44-()	Spare parts for maintenance of Winch L-18 assembly with clutch; complete set of parts. Used with but not part of Trucks K-43-() and K-44-().
Maintenance Equipment	ME-18		Teletypewriter TC-7	Spare parts for 4th and 5th Echelon maintenance of 50 Teletypewriters TC-7. Includes large assortment of teletype-writer but not motor parts. Replaced by ME-90.
Maintenance Equipment	ME-22 ^a		Telephone KE-6-()	Case CS-112 containing spare parts for maintenance of Telephone KE-8-(); screws, binding posts, cord, case and strap, etc.; parts for 10 Telephones KE-8-() for 4 months. TM 11-349.
Maintenance Equipment	ME-23 ^a		Information Center SCS-5	Spare parts for repair of operations center; relays, cords, telephone sets, etc.
Maintenance Equipment	ME-24 ^a		Information Center SCS-5 Filter Center TC-15	Spare parts for maintenance of filter center; relays, cords, fuses, telephone sets, plotting materials, etc.
Maintenance Equipment	ME-25 ^a		Information Center SCS-5 Filter Center TC-15	Spare parts for maintenance of intercept frame; cords, fuses, resistors, lamps, telephone set parts, and small assortment of maintenance tools, etc.
Maintenance Equipment	ME-26 ^a		Information Center SCS-5 Filter Center TC-15	Spare parts for maintenance of terminal radio channel control equipment; vacuum tubes, fuses, dry cells, telephone sets, protector blocks, and several small tools such as pliers, screwdrivers, etc.

Nomenclature		Used for	Description and Remarks
Name	Type No.		
Maintenance Equipment	ME-30	Switchboard HD-91(TU-12)	Consists of pliers, screwdriver, soldering iron, twine, torch, wrench, cordage and miscellaneous items; contained in Case CS-78. 1st and 2nd Echelon maintenance of Switchboard HD-91. Used with but not part of TC-12.
Maintenance Equipment	ME-31-A	Reel Unit RL-26-A equipped with Briggs & Stratton engine	Chest of spare parts. Cancelled and replaced by ME-65 and ME-66.
Maintenance Equipment	ME-31-B and C	Reel Unit RL-26-A equipped with Leuson Engine Ray-843 [ME-31-(B)], or Leuson Engine Ray-885 [ME-31-(C)]	Chest BC-5 containing large number of gasoline engine spare parts for maintenance of Reel Unit RL-26-A with Leuson engine; parts such as spark plugs, magneto pistons & piston rings, gears, and miscellaneous small parts, for 3rd Echelon use in continental U.S. only.
Maintenance Equipment	ME-34()	Radio Set SCR-509 " " SCR-510 " " SCR-609 " " SCR-610	Chest CE-96 containing spare accessories consisting of antenna, headset with cords, microphone, tubes, etc. Classified as non-expendable items; expendable items included in ME-59.
Maintenance Equipment	LE-35	Radio Sets - General	Expendable items packed with Tool Equipment TE-113; consists of flashlight batteries, hack-saw blades, cloth, sandpaper, solder, terminals, wire, etc. Formerly issued to each radio repairman of Radio Repair Sections. Cancelled and components included in TE-113.
Maintenance Equipment	ME-36	Radio Set SCR-536-()	Box EK-66 containing ball antenna, microphone, grease, cement, switches, vacuum tubes, small parts, some hardware and moisture-proofing materials and instructions; for 2nd Echelon repair and maintenance of 20 radio sets SCR-536-().
Maintenance Equipment	ME-37	Teletypewriter repair.	Expendable items packed with Tool Equipment TE-50-A and TE-124; consists of flashlight batteries, carbon tetrachloride, solder, friction and rubber tape, etc. Cancelled and components included in TE-50-A.
Maintenance Equipment	ME-38	Telephone and telegraph repair.	Expendable items packed with Tool Equipment TE-49-A; consists of flashlight batteries, cloth, sandpaper, tape, etc. Formerly issued to each telephone repairman. Cancelled and components included in TE-49-A.

Table continued on next page

MAINTENANCE EQUIPMENTS - DESCRIPTION (Continued)

Principal Users
(See also Sig 4-1
and Tables of
Equipment)

Nomenclature		Used for	Description and Remarks
Name	Type No.		
Maintenance Equipment	ME-39 ^a	Switchboard BD-71 " " BD-92(TC-12) " " BD-96(TC-4)	Crate or box containing replacement parts for 3rd Echelon maintenance and repair of Switchboards BD-71, BD-72, BD-91 and BD-96. Consists of binding posts, capacitors, coils, cords, fuses, generators, switches, lamps, plugs, receivers, Switchboard Units EE-2-B and similar items.
Maintenance Equipment	ME-40-()	Radio Set SCR-300	Chest CH-165-() containing oscillator, alignment indicator, alignment tools, headset, antennas, cords, screwdriver and wrench for maintenance of 6 radio sets SCR-300-(). Expendable items for use with ME-40 are contained in ME-53. TM 11-315.
Maintenance Kit	ME-53	Radio Set SCR-300	Spare batteries, tubes and lamp for Radio Set SCR-300-() and for oscillator and indicator of ME-40-(); contained in Chest CH-165-() with ME-40-(). Used with ME-40-(). TM 11-315.
Installation Equipment	ME-58	200 Line Switchboards	Equipment packed in kits for installation of a 200 line switchboard. Packed by Phila. depot for export shipment.
Maintenance Kit	ME-59	Radio Set SCR-509 " " SCR-510 " " SCR-609 " " SCR-610	Expendable items associated with ME-34-(); consists of batteries, fuses, tubes, vibrators etc.; packed in an expendable container. Used with ME-34-().
Installation Equipment	ME-60	1000 Line Switchboards	Equipment packed in kits for installation of a 1000 line switchboard. Packed by Phila. depot for export shipment.
Maintenance Equipment	ME-63-()	Switchboard BD-120(TC-20)	Large assortment of screws, nuts, rivets and washers, assortment of power wiring cords, connections, plugs, etc. for maintenance of Telephone Central Office Set TC-20 which includes Switchboard BD-120-(). Space provided for ME-63 in Chest CH-64. Provided as part of TC-20.
Maintenance Kit	ME-64	Radio Set SCR-508 " " SCR-528 " " SCR-538 " " SCR-608 " " SCR-628	Small parts for field maintenance of 14 radio sets. Cancelled and being deleted for SIG 4-1. Never issued as any ME-64 replaced by SIC 8.

Nomenclature		Used for	Description and Remarks
Name	Type No.		
Maintenance Equipment	ME-65 ^b	Reel Unit ME-26-A using Briggs & Stratton engine	Chest BC-5 containing parts for reel unit and engine, such as coupling discs, cables, carburetor, filter, gaskets, spark plugs, etc. Replaces ME-31-A for 2nd Echelon maintenance.
Maintenance Equipment	ME-66 ^c	Reel Unit ME-26-A using Briggs & Stratton engine.	Chest BC-5 containing parts for reel unit and engine; a larger and more complete assortment of reel and engine parts for complete overhaul purposes. Replaces ME-31-A for 3rd Echelon maintenance.
Maintenance Kit	ME-67 ^a	Radio Set SCR-300	Large assortment of parts such as capacitors, antenna, coils, gaskets, jack assemblies, receiver and transmitter crystals, sockets, insulators, resistors, transformers, etc. and small hardware for maintenance of 10 Radio Sets SCR-300 for approx. 4 months. For 3rd Echelon maintenance.
Maintenance Kit	ME-69	Reperforator portion of: Reperforator Transmitter TC-26-(), Reperforator Model 14, commercial	Waterproof fibre box containing frequently used small repair parts for reperforators; springs, magnet, plates, screws, nuts, washers, etc. no motor parts. One ME-69 authorized per 4 Teletypewriter Sets TC-17.
Alignment Equipment	ME-73	Radio Set SCR-509 " " SCR-510 " " SCR-609 " " SCR-610 " " SCR-619	Chest CH-204-() containing tools, adapter, crystals, etc. for aligning Radio Sets SCR-509 and SCR-510 when equipped with Adapter M-394 and Radio Sets SCR-609 and 610 when equipped with Adapter M-399, and for aligning Radio Set SCR-619. Replaces ME-13-(). TM 11-318.

Principal Users
(See also Sig 4-1
and Tables of
Equipment)

Sig. Opn. Co.
Sig. Co. Amph.
Sig. Co. Cons. Arm.
Sig. Co. Mtz. Div.
Sig. Rad. Int. Co.
Sig. Depot Co.

Sigs. Opn. Co.
Sig. Co. Amph.
Sig. Co. Cons. Arm.
Sig. Co. Mtz. Div.
Sig. Rad. Int. Co.
Sig. Depot Co.

Issued per 10
Radio Sets SCR-300

Sig. Serv. Gp.
AAF

Car. Ren. Sqdn.
Tank Bn.
Arm. Inf. Bn.
Arm. Div. Trains
AAA Bn.
Sig. Co. Inf. Div.
Sig. Dep. Co.

a. To be replaced by sections in both Supply Catalogs SIG 7 and SIG 8

b. To be replaced by sections in Supply Catalog SIG 7 (Organizational Spare Parts)

c. To be replaced by sections in Supply Catalog SIG 8 (Higher Echelon Spare Parts)

Table continued on next page

MAINTENANCE EQUIPMENTS - DESCRIPTION (Continued)

32
33
34

Name	Nomenclature	Type No.	Used for	Principal Users (See also SIG 4-1 and Tables of Equipment)	Description and Remarks
Maintenance Equipment	MS-74b		Telephone Terminal Set TC-21-() (Carrier)	1st & 2nd Echelons of organizations to which TC-21-() (theatre pool equipment) is assigned.	Chest BC-5 containing expendable spare parts and small repair parts for Telephone Terminal Set TC-21-() of which Telephone Terminal CF-1-A is the major component; cords, capacitors, resistors, fuses, tubes, cordage, etc. Originally part of TC-21-().
Maintenance Equipment	MS-75b		Telegraph Terminal Set TC-22-() (Carrier)	1st & 2nd Echelons of organizations to which TC-22-() (theatre pool equipment) is assigned.	Chest BC-5 containing expendable spare parts and small repair parts for Telegraph Terminal Set TC-22-(), of which Telephone Terminal CF-2-() is a major component capacitors, resistors, fuses, tubes, cordage etc. For 1st & 2nd Echelon maintenance. Originally part of TC-22-().
Maintenance Equipment	MS-76b		Repeater Set TC-23-() (Carrier)	1st & 2nd Echelons of organizations to which TC-23-() (theatre pool equipment) is assigned.	Chest BC-5 containing expendable spare parts and repair parts for Repeater Set TC-23-() of which Repeater CF-3-() is a major component; capacitors, resistors, cords, fuses, tubes, etc. For 1st and 2nd Echelon maintenance. Originally part of TC-23-().
Maintenance Equipment	MS-77b		Ringier Set TC-24-() (Double Circuit)	1st & 2nd Echelons of organizations to which TC-24-() (theatre pool equipment) is assigned.	Chest BC-5 containing expendable spare parts and repair parts for Ringier Set TC-24-(), of which Ringing Equipment KE-100-() or KE-101-() is a major component; capacitors, resistors, cords, fuses, screws, etc. For 1st and 2nd Echelon maintenance. Originally part of TC-24-().
Maintenance Equipment	MS-79a		Spiral Four 100 Mile Carrier System	1st & 2nd Echelons of Signal Service organizations to which Spiral Four 100 Mile Carrier System is assigned.	Parts for maintenance of Spiral Four 100 miles carrier system such as cable assemblies, micropress sleeves, tape, drive hooks, cable hangers, etc. Cancelled 7/14/43.
Maintenance Kit	MS-80b		Teletypewriter TC-7-() Teletypewriter Model 15, commercial	Signal Port Service Co. Signal Radio Intelligence Co. Sig-Co.Inf.Div. Sig-Co.Arm.Div. Sig-Co.Eng.Spec.Brig. Sig.Field Opn.Co.	Waterproof fibre box containing frequently used repair parts for teletypewriters; screws, nuts, washers, springs, magnet coil, motor brushes and brush caps, contact springs, fuses, target lamp, and miscellaneous small parts, etc. Parts for 1 to 4 printers for 1st and 2nd Echelon use. Replaces MS-7. One MS-80 authorized per 4 Teletypewriter Sets TU-19, Model 19, TU-15 or Model 15.
Maintenance Kit	MS-81b		Perforator Set TU-13 Model 14X non-typing Reperforator (part of TU-25)	1st & 2nd Echelons AAF, ACF, AEF	Waterproof fibre box containing frequently used repair parts; springs, washers, nuts, screws, magnet coil, contact springs, motor brushes etc. For 1st and 2nd Echelon use. One MS-81 authorized per 4 Teletypewriter Sets TU-13, Model 14 or TU-25.

Nomenclature Name	Used for	Principal Users (See also Sig 4-1 and Tables of Equipment)	Description and Remarks
Maintenance Kit ME-82 ^b	Model 14 Transmitter-Distributor (Commercial) This is part of: Perforator Transmitter Set TG-23 Reperforator Transmitter Set TG-25 Reperforator Transmitter Set TG-26 Teletypewriter Model 19, commercial Teletypewriter TG-19	1st and 2nd Echelons AAF, AGF, ASF	Frequency used repair parts for transmitter-distributors (teletypewriter); screws, nuts, washers, springs, magnet, contact pin, contact springs, motor brushes etc. for 1st & 2nd Echelon use. One ME-82 authorized per 4 Teletypewriter Sets TG-19, Model 19, TG-25, TG-23, or TG-17.
Maintenance Kit ME-83 ^b	Model 14 Perforator Portion of: Perforator Set TG-11 Perforator Transmitter Set TG-23	1st & 2nd Echelons AAF, AGF, ASF	Small assortment of frequently used parts for maintenance of perforators; screws, nuts, washers, springs, magnet, rod head, etc. packed in envelopes and contained in a waterproof solid fibre board box with cover approx. 5" x 6" x 3" overall. For 1st & 2nd Echelon use. One ME-83 authorized per 4 Teletypewriter Sets TG-11, TG-23, TG-19, or Model 19.
Maintenance Kit ME-84 ^b	Perforator Portion of: Teletypewriter Set TG-19 Teletypewriter Model 19, commercial	1st & 2nd Echelons AAF, AGF, ASF	Small assortment of frequently used parts for maintenance of perforators; magnet coil, springs, lamp, screws, etc. packed in waterproof solid fibre board box with cover 2" x 6" x 3". For 1st & 2nd Echelon use. One ME-84 authorized per 4 Teletypewriter Sets TG-19 or Model 19.
Maintenance Kit ME-86 ^a	Teletypewriter equipment	Signal Repair Co.	Chest CH-69 containing a large quantity of teletypewriter repair parts consisting of Maintenance Equipments ME-69, ME-80, ME-81, ME-82 and ME-83, ME-84, in specified quantities packed both as maintenance equipment units and as individual parts in numerical order by Teletype Corporation part number. For 1st & 2nd Echelon maintenance.
Maintenance Equipment ME-87 ^c	Ten 100-mile Spiral Four Carrier Systems	5th Echelon Base Shops.	Limited quantity of infrequently required parts for maintenance of Spiral Four carrier equipment used in a "100-Mile Carrier System". Contains enough equipment to maintain 10 systems for one year, to be stocked at base depot. For 5th Echelon use.

a. To be replaced by sections in both Supply Catalogs, SIG 7 and SIG 8.

b. To be replaced by sections in Supply Catalog SIG 7 (Organizational Spare Parts)

c. To be replaced by sections in Supply Catalog SIG 8 (Higher Echelon Spare Parts)

MAINTENANCE EQUIPMENTS - DESCRIPTION (Continued)

Name	Nomenclature Type No.	Used for	Principal Users (See also Sig. 4-1 and Tables of Equipment)	Description and Remarks
Maintenance Equipment	ME-88 ^a	Four 100-mile Spiral Four Carrier Systems	Signal Depot Co., 4th Echelon repair shops and 5th Echelon base shops.	Same as ME-87 except quantity is sufficient for maintenance of four 100-Mile Carrier Systems for 90 days. Principally for 4th and also for 5th Echelon use and for re-supply of 1st and 2nd Echelon repair parts, such as those contained in ME-74, ME-75, ME-76 & ME-77.
Maintenance Kit	ME-89 ^b	Reperforator Portion of: Reperforator Transmitter- Distributor Set TG-26-() Reperforator Transmitter- Distributor Set TG-27-() Reperforator Set Model 14, commercial	4th & 5th Echelons AAF, AGF, ASF	Carton containing infrequently used spare parts for reperforators; feed roll, spacer collars, detent assembly, special screws, etc. For 4th and 5th Echelon use.
Maintenance Kit	ME-90 ^b	Teletypewriter TG-7-(). Teletypewriter Model 15, commercial	Sig. Depot Co.	Waterproof solid fibre board box with cover containing large assortment of infrequently used repair parts for teletype-writers; driving clutches, levers, terminal block assembly, bearings, screws, washers, etc. For 4th & 5th Echelon use.
Maintenance Kit	ME-91 ^a	Perforator Set TG-13. Model 14X non-typing Reperforator (part of TG-25)	4th & 5th Echelons AAF, AGF, ASF	Waterproof solid fibre board box with cover containing infrequently used repair parts for reperforators; feed roll, levers, terminal block, screws, washers, etc. For 4th & 5th Echelon use.
Maintenance Kit	ME-92 ^b	Model 14 Transmitter- Distributor, commercial. This is part of: Perforator Transmitter Set TG-23, Reperforator Trans- mitter Set TG-25, Reperforator Trans- mitter Set TG-26-(), Teletypewriter Set TG-19, Teletypewriter Model 19, commercial	4th & 5th Echelons AAF, AGF, ASF	Expandable carton containing infrequently used repair parts for maintenance of distributor-transmitters; terminals, roller, friction disc, bearings, washers, screws, etc. For 4th and 5th Echelon use.

Nomenclature		Used for	Principal Users (See also SIG 4-1 and Tables of Equipment)	Description and Remarks
Name	Type No.			
Maintenance Kit	ME-93 ^b	Model 14 Tape Perforator This is part of: Perforator Set TG-11, Perforator Transmitter Set TG-23	4th & 5th Echelons AF, AGF, ASF	Expendable carton containing infrequently used repair parts for maintenance of tape perforator; springs, bell cranks, feed roll, screws, nuts, washers, etc. For 4th & 5th Echelon use.
Maintenance Kit	ME-94 ^b	Perforator portion of: Perforator Transmitter Model 15, commercial, Teletypewriter Set TG-19, Teletypewriter Model 19, commercial	4th & 5th Echelons AF, AGF, ASF	Expendable carton containing infrequently used repair parts for maintenance of perforators; feed rolls, springs, terminals, screws, washers, etc. For 4th & 5th Echelon use.
Repair Parts Kit	ME-111 ^b	Repeater TG-30 (Terminal)	4th & 5th Echelons	Expendable carton containing repair parts for one year's maintenance of 20 Repeaters TG-30, capacitors, resistors, jacks and mountings, milliammeters, transformers, lamps, switches, rectifiers, etc. For 4th & 5th Echelon use.
Repair Parts Kit	ME-112 ^a	Repeater TG-30 (Terminal)	2nd & 3rd Echelons	Expendable carton containing small assortment of repair parts for 30 days maintenance of one Repeater TG-30; protector blocks, fuses, fuse extractor posts, polar relays, etc. For 2nd & 3rd Echelon use.
Repair Parts Kit	ME-113 ^b	Repeater TG-31 (Intermediate)	4th & 5th Echelons	Expendable carton containing repair parts for one year's maintenance of 10 Repeater TG-31; capacitors, retard coils, fuses, jacks, keys, resistors, protector blocks, lamps, switches, transformers, varistors, voltmeters, etc. For 4th & 5th Echelon use.
Repair Parts Kit	ME-114 ^a	Repeater TG-31 (Intermediate)	2nd & 3rd Echelons	Expendable carton containing small assortment of repair parts for 30 days maintenance of one Repeater TG-31; protector blocks, fuses, fuse extractor posts, polar relays, etc. For 2nd & 3rd Echelon use.

^aTo be replaced by sections in both Supply Catalogs SIG 7 and SIG 8.

^bTo be replaced by sections in Supply Catalog SIG 8 (Higher Echelon Spare Parts).

Table continued on next page.

MAINTENANCE EQUIPMENTS - DESCRIPTION. (Continued)

Par. 1308

Name	Nomenclature Type No.	Used for	Principal Users (See also Sig 4-1 and Tables of Equipment)	Description and Remarks
Maintenance Equipment	ME-4/TRC-1	Radio Set AN/TRC-1	Organizations to which Radio Set AN/TRC-1 is issued	Kit of running spares and spare parts for limited repair of Radio Set AN/TRC-1 in the field; consists of tubes, fuses, fuse holders, switches, relays, etc., and Test Oscillator TS-32/TRC-1. Expected to be cancelled as a Maintenance Equipment, but will be provided as components of Radio Set AN/TRC-1.
Maintenance Equipment	ME-5/TRC-3	Radio Set AN/TRC-3	Organizations to which Radio Set AN/TRC-3 is issued	Kit of running spare parts, tools, and test equipment for maintenance and limited repair of Radio Set AN/TRC-3 at the station; consists of tubes, lamps, fuses, relays, fans, pliers, tape, solder, alignment tools, Test Oscillator TS-32/TRC-1, analyzer, etc., in Chest EC-5. Expected to be cancelled as a Maintenance Equipment, but will be provided as components of Radio Set AN/TRC-3.
Maintenance Equipment	ME-6/TRC-4	Radio Set AN/TRC-4	Organizations to which Radio Set AN/TRC-4 is issued	Kit of running spares, spare parts, tools and test equipment for maintenance and limited repairs of Radio Set AN/TRC-4 at the station; consists of tubes, resistors, capacitors, fans, heaters, pliers, solder, alignment tools, Test Oscillator TS-32/TRC-1, analyzer, etc., in Chest EC-5. Expected to be cancelled as a Maintenance Equipment, but will be provided as components of Radio Set AN/TRC-3.
Spare Parts Kit	ME-11/TRA-1	Amplifier Equipment AN/TRA-1	Organizations to which Amplifier Equipment AN/TRA-1 is issued	Weatherproof packing case containing spare parts for limited maintenance and repair of Amplifier Equipment AN/TRA-1 at the station; consists of tubes, fuses, relays, fans, cords, connectors, etc. Part of Amplifier Equipment AN/TRA-1.

^aTo be replaced by sections in both Supply Catalogs SIG 7 and SIG 8^bTo be replaced by sections in Supply Catalog SIG 8 (Higher Echelon Spare Parts).

1309. MAINTENANCE EQUIPMENTS - STOCK NUMBERS AND LOGISTICAL DATA

Nomenclature			Packed for Export	
Name	Type No.	Stock No.	Weight (lbs.)	Volume (cu.ft.)
Maintenance Equipment	ME-4	4C5604	300	10
"	ME-6	4C5606	823	9
"	ME-7	4T104065	185	21
"	ME-9-()	2Z6409 ()	732	61
"	ME-10	4B1910	215	6.5
"	ME-11	4C5611	127.5	5.5
"	ME-13-()	2Z6413 ()	125	6
"	ME-14-()	6J714 ()	-	-
"	ME-15	4B1915	450	25
"	ME-16-()	4B1916 ()	57	2
"	ME-18	4T500-018	-	-
"	ME-22	4B1922	69	3.1
"	ME-23			
"	ME-24			
"	ME-25			
"	ME-26			
"	ME-30	4C5630	49.3	1.6
"	ME-31-()	4A1431()	82	7
"	ME-34-()	2Z6434 ()	75	4
"	ME-35	2Z6435	-	-
"	ME-36	2Z6436	77	3
"	ME-37	2Z6437	-	-
"	ME-38	2Z6438	-	-
"	ME-39	2Z6439	30	1
"	ME-40-()	2Z6440()	80	3.5
Maintenance Kit	ME-53	2Z6453.1	361.5	15
Installation Equipment	ME-58	4Z4758	282	10
Maintenance Kit	ME-59	2Z6459	195	6.5
Installation Equipment	ME-60	4Z4760	-	-
Maintenance Equipment	ME-63-()	4Z5763()	640	17
Maintenance Kit	ME-64	2Z6464	6	.3
Maintenance Equipment	ME-65	4A1465	74	6.5
"	ME-66	4A1466	65	5.5
Maintenance Kit	ME-67	2Z6467	33	1.4
"	ME-69	4C500-069	-	-
Alignment Equipment	ME-73	2Z6473	307	11.5
Maintenance Equipment	ME-74	4Z5774	-	-
"	ME-75	4Z5775	-	-
"	ME-76	4Z5776	-	-
"	ME-77	4Z5777	-	-
"	ME-79	4Z5779	-	-
Maintenance Kit	ME-80	4T106900	8.5	.3
"	ME-81	4T106901	2.5	.2
"	ME-82	4T106902	2.5	.2
"	ME-83	4T106903	1.5	.1
"	ME-84	4T106904	1.3	.1
"	ME-86	4T106920	90	4.5
Maintenance Equipment	ME-87	4Z5787	-	-
"	ME-88	4B1925-88	250	8
Maintenance Kit	ME-89	4T106195	14	.8
"	ME-90	4T106910	14	.8
"	ME-91	4T106911	14	.8
"	ME-92	4T106912	14	.8
"	ME-93	4T106913	14	.8
"	ME-94	4T106914	14	.8
Repair Parts Kit	ME-111	4A2112-111	472	23
"	ME-112	4A2112	-	-
"	ME-113	4A2112-113	277	10
"	ME-114	4A2112-114	5.1	.3
Maintenance Equipment	MK-4/TRC-1	2Z6476-4	180	6
"	MK-5/TRC-3	2Z6476-5	195	6
"	MK-6/TRC-4	2Z6476-6	198	6
Spare Parts Kit	MK-11/TRA-1	2Z5732-11	-	-

Section IV
Tool Equipments

1310. GENERAL.

a. Tool Equipments (TE's) consist of sets of tools and supplies for repair or maintenance of particular equipments, or of general classes of equipment such as radio sets, teletypewriter equipments, switchboards, etc. These vary in size from small pocket tool kits to large

assortments of tools for issue to a depot or base.

b. Paragraph 1311 gives a description of each Tool Equipment, the principal users of each, the type of equipment for which it is used and the Instruction Book or Technical Manual which covers it.

c. Paragraph 1312 gives stock numbers and logistical data for the Tool Equipments included in paragraph 1311.

1311. TOOL EQUIPMENTS AND TOOL SETS - DESCRIPTION.

Nomenclature Name	Type No.	Used for	Principal Users (See also SIG 4-1 and Tables of Equipment)	Description and Remarks
Tool Equipment	TE-5	General use	Nearly all units of AGF and AAF	Inspectors Pocket Kit; Case EG-29 (leather) containing file, electrician's knife, pliers, rule, scissors, screwdriver and tweezers. Limited standard ⁶ .
Tool Set	TE-16-()	Telephone cable repair and installation	Sig. Instl. Co. Sig. Lt. Const. Co. Sig. Co. Inf. Div.	Chest EC-31, containing cable splicers' tools and materials; hack saw, cable dresser, files, knife, pliers, blow torch, tape, etc. and Tool Equipment TE-5.
Lineman's Equipment	TE-21	Open wire line construction and repair		See Paragraph 637
Groundman's Equipment	TE-23	Open wire line construction and repair		See Paragraph 637
Soldering Equipment	TE-26-()	General use		Soldering equipment; Box EC-87-() containing sandpaper, solder, soldering iron and torch.
Tool Equipment	TE-27-()	Open wire pole line construction		See Paragraph 637
Tool Equipment	TE-29	General use	Same as TE-5	Same as Tool Equipment TE-5, except contained in canvas case (EC-48); issued when Tool Equipment TE-5 (with leather case) cannot be obtained.
Tool Equipment	TE-33	General use	Nearly all units of AGF and ASF	Pouch CS-34 or CS-35 containing knife and pliers.
Tool Equipment	TE-36	General use	All Signal Units	Canvas Tool Bag EC-44 containing files, pliers, screwdrivers, soldering iron and solder, tape, torch and wire.

⁶ Limited standard - not being procured, but may be supplied until present stock is exhausted.

TOOL EQUIPMENTS AND TOOL SETS - DESCRIPTION. (Continued) Principal Users
 (See also SIG 4-1 and Tables of Equipment)

<u>Name</u>	<u>Type No.</u>	<u>Used for</u>	<u>Principal Users</u>	<u>Description and Remarks</u>
Tool Equipment	TE-41-()	Radio repair	Sig. Opn. Co. Sig. Rep. Co. Sig. Dep. Co. Sig. Co. Mtz. Div. Sig. Co. Inf. Div. Sig. Co. Arm. Div. Sig. Rad. Int. Co.	Canvas Tool Bag BG-44 containing assortment of frequently used tools and supplies for radio repairman, 2nd Echelon; such as carbon tetrachloride, flashlight, files, knife, blow-torch, soldering iron and solder, burnisher, alignment tool, and various types of pliers, screwdrivers (including Phillips) and wrenches (including set screw).
Tool Equipment	TE-44-()	Switchboard BD-80 (TC-1) " BD-89 (TC-2) " ED-110 (TC-10) " ED-120 (TC-20) Aux. Telephone Central Office Set TC-5	Sig. Rep. Co. Sig. Dep. Avn. Sig. Dep. Co. Sig. Serv. Gp.	Chest CH-53 containing tools for repair of Switchboards BD-80, BD-89, BD-110, and ED-120, and Aux. Telephone Central Office Set TC-5; such as soldering irons, files, backsaw blades, pliers, screwdrivers, tinners snips, wrenches; also a pocket size voltmeter with leads. Part of TC-1, TC-2, TC-5, TC-10 and TC-20. Test Set TS-25/TSM (voltage ohmmeter for line testing, with cords and clips) is required for use with TE-44-A, but is issued as a separate item.
Tool Equipment	TE-45-()	Radio alignment	Sig. Repair Co. Sig. Radio Intelligence Co. Sig. Co. Inf. Div. Sig. Co. Arm. Div. Sig. Bn. Sig. Fort Service Co. Sig. Co. Amph. Sig. Co. Tr. Calv. Div. Sig. Co. Mtz. Div. Sig. Fixed Rad. Sta. Co.	Leatherette case with tools for radio alignment; 3 inch cabinet screwdriver and special screwdrivers and wrenches. Limited Standard ^a
Tool Equipment	TE-46	Radio repair	Sig. Depot Co. Sig. Repair Co. Sig. Fort Service Co. Sig. Bn. Sig. Co. Inf. Div. Sig. Co. Arm. Div.	Used with but not part of radio repair truck. Central supply of tools for general radio repairs, 3rd & 4th Echelon. Consists of brace and bits, electric drill and drill sets, speed indicator, soldering iron, rubber stamp set, files, chisels, gauges, screwdrivers, set screw wrenches, etc. Replaced by Tool Equipment TX-114. Substitute Standard. ^b

<u>Nomenclature Name</u>	<u>Type No.</u>	<u>Used for</u>	<u>Principal Users (See also SIG 4-1 and Tables of Equipment)</u>	<u>Description and Remarks</u>
Tool Equipment	TE-47	Telephone and telegraph equipment	Sig. Repair Co. Sig. Instl. Co. Sig. Co. Inf. Div. Sig. Co. Armad. Div. Sig. Bn. Sig. Port Svc. Co.	Central supply of tools for general repair of telephone and telegraph equipment. Assortment of tools for adjustment of relays and other apparatus and for general repair work, etc.; chisel, drills, "C" clamps, cordage, files, pliers, soldering iron, spring benders, gauges, etc. Replaced by TE-111 and TE-112. Substitute Standard. ^b
Tool Equipment	TE-48	General radio repair	Sig. Repair Co. Sig. Depot Co. Sig. Rad. Int. Co. Sig. Co. Inf. Div. Sig. Co. Armad. Div. Sig. Opa. Co. Sig. Bn.	Issued to each radio electrician in repair companies. Chest CH-77 containing general use tools for radio repair; hand drill, hack saw, files, knife, pliers, screwdrivers, wrenches, etc. and a multi-meter test set. Replaced by TE-113. Limited standard. ^a
Tool Equipment	TE-49-A	Telephone and telegraph equipment	Sig. Repair Co. Sig. Opa. Co. Sig. Field Opa. Co. Sig. Depot Co. Sig. Instl. Co. Sig. Bn. Sig. Port Service Co. Sig. Co. Inf. Div. Sig. Co. Armad. Div.	Issued to each telephone electrician in repair companies. Chest CE-77 containing pliers, soldering iron, receiver with headband and cord (ultimately TS-190/U) and connecting tools, screwdrivers, small wrenches, electricians scissors, whistle, etc. Also contains expendable supplies previously issued as ME-38.
Tool Equipment	TE-50-A	Teletypewriter equipment	Sig. Repair Co. Sig. Depot Co. Sig. Opa. Co. Sig. Field Opa. Co. Sig. Co. Inf. Div. Sig. Co. Armad. Div. Sig. Bn. Sig. Port Service Co.	For use of teletypewriter repairmen in repair companies for repairing teletypewriter equipment. Consists of adjusting tools and some general use tools; tuning forks 87.6 VPS for adjusting teletype motor to 368 OPM (American Speed) and 96.19 VPS for adjusting to 404 OPM (British Speed), pliers, screwdrivers, set of special teletype tools, wrenches, soldering iron, flashlight, etc. Also contains expendable supplies previously issued as ME-37.
Tool Equipment	TE-51	Welding	Sig. Depot Co. Hq. Co. Const. Bn. Sig. Dep. Co. Avn.	Welding Kit; contains gasoline torch, acetylene torch and accessory equipment, tools and expendable supplies; such items as chisels, "C" clamps, files, electric drill and drill sets, filler rods, flux, welder's gloves, goggles, hand shield, and helmet, electric grinder, blacksmith's and machinist's hammers, blacksmith's anvil, pliers, solder, vise and wrenches; also cylinders of oxygen and acetylene.

^aLimited standard - not being procured, but may be supplied until present stock is exhausted.

^bSubstitute standard - not being procured, but equipment in stock may be supplied as substitute for similar standard tool equipments which are not available.

Table continued on next page.

TOOL EQUIPMENTS AND TOOL SETS - DESCRIPTION. (Continued)

Nomenclature		Principal Users (See also SIG 4-1 and Tables of Equipment)	Description and Remarks
Name	Type No.		
Vulcanizing Equipment	TE-55-()	Sig. Co. Const. Armd. Sig. Heavy Const. Avn. Sig. Heavy Const. Co. Sig. Repair Co. Sig. Depot Co.	See paragraph 639.
Tool Set	TE-56-A		See paragraph 638.
Tool Equipment	TE-64-()	Sig. Co. Const. Armd. Sig. Heavy Const. Avn. Sig. Heavy Const. Co. Sig. Repair Co. Sig. Depot Co.	Set of wrenches for use with Truck K-44-B equipped with earth borer and pole setter.
Tool Equipment	TE-69-()	Plant Eng. Agency	W.E.Co. Tool Kit #102, large kit of general use, mechanics, carpenters, and switchboard cable tools; bench grinder, drills, taps, heavy wrenches, cable shears, nail pullers, etc.
Tool Equipment	TE-70	Plant Eng. Agency	W.E.Co. Tool Kit #5, small conduit installing kit, for installing conduit 2 inches or under; includes brace and bits, chisel, files, hacksaw, pipe vise, pipe wrenches, fish wire, etc. packed in small tool chest.
Tool Equipment	TE-71	Plant Eng. Agency	W.E.Co. Tool Kit #197, gauges and adjusting tools for maintaining the more commonly used types of W.E.Co. relays; frequently required items, spring adjusters, gauges, small wrenches, screwdrivers, etc.
Tool Equipment	TE-72	Plant Eng. Agency	W.E.Co. Tool Kit #197X, less frequently required gauges and adjusting tools for W.E.Co. relays.
Tool Equipment	TE-73	Plant Eng. Agency	W.E.Co. Tool Kit #168, wireman's pocket tool kit consisting of cutters, pliers, screwdriver and spudger in a pocket tool case.
Tool Equipment	TE-79	Plant Eng. Agency	Large kit of telephone central office installation tools, packed for export shipment; such as brace and bits, center punches, files, hacksaw, hammers, nail puller, cable strippers, soldering iron, stencils, multiple splicing frame, test receiver and flashlight type buzzer set.
Tool Equipment	TE-87-()	Plant Eng. Agency	Basic tool equipment for installing fixed plant radio station; light duty construction tools. Consists of axe, bit equipment and brace, hacksaws, block and tackle, chisel, emery cloth, an assortment of files, lineman's grip, knives, measuring tape, friction tape, rubber gloves, assortment of screws, nuts and bolts, Lineman's Equipment TE-21, etc.

Nomenclature		Used for	Principal Users (See also SIG 4-1 and Tables of Equipment)	Description and Remarks
Name	Type No.			
Tool Equipment	TE-111	Wire equipment repair	Sig. Repair Co. Sig. Instl. Co. Sig. Fort Service Co. Sig. Bn. Sig. Co. Inf. Div. Sig. Co. Arm. Div. Sig. Const. Bn.	Basic repair tools for 3rd Echelon repair units; for repair of switchboards and other telephone equipment (ground wire equipment) consists of brace and bits, electric drill, soldering iron, pliers, hacksaw, hammers, tinners snips, switchboard tools, wrench sets, etc.
Tool Equipment	TE-112	Wire equipment adjustments	Sig. Depot Co. Sig. Repair Co. Sig. Bn.	Supplemental to Tool Equipment TE-111. Adjusting tools and gauges for relays and other telephone apparatus and some general tools, for 4th and 5th Echelon repair units; consists of files, gauges, screwdrivers, spring adjusters, small wrenches, etc.
Tool Equipment	TE-113	Radio repair	Sig. Repair Co. Sig. Depot Co. Sig. Radio Int. Co. Sig. Fort Service Co. Sig. Co. Inf. Div. Sig. Co. Arm. Div. Sig. Co. Eng. Spec. Brig. Sig. Fixed Radio Sta. Co. Sig. Opn. Bn. Sig. Opn. Co. Sig. Radar Maint. Units	Chest CH-77 containing basic tool kit for use of radio and radar repairmen; chisels, hand drill, hacksaw, pliers, electrician's knife, screwdrivers, soldering iron, wrenches and wrench sets, etc. Also contains expendable supplies previously issued as MF-35. For 3rd, 4th, and 5th Echelon use.
Tool Equipment	TE-114	Radio repair	Sig. Repair Co. Sig. Depot Co. Sig. Fort Service Co. Sig. Bn. Sig. Co. Inf. Div. Sig. Co. Arm. Div.	Basic radio repair tool set for use of radio units; brace and bits, chisels, C-clamps, electric drill, files, valve grinding kit, screwdrivers, tinners snips, soldering irons, wrench sets, etc. For 3rd, 4th and 5th Echelon use.
Tool Equipment	TE-123	Telephone Terminal Set TC-21 Telegraph Terminal Set TC-22. Repeater Set TC-23 Ringer Set TC-24		Metal tool box (16" x 7" x 7") containing adjusting and general use tools and supplies for maintenance of Spiral Four Equipments; consists of cords and connecting tools, pliers, screwdrivers, soldering iron, solder, trouble lamp, whistle, wrenches, etc. Provided as part of TC-21 and TC-23. Revision being considered to include items now in Tool Equipment TE-124 and to replace TE-124 for depot use; also to include additional tools required for maintenance of Converter Set TC-33 and Repeater Set TC-37. Includes Instruction Book, Western Electric Co. X-66413. Net weight approximately 20 lbs.

Table continued on next page.

TOOL EQUIPMENTS AND TOOL SETS - DESCRIPTION. (Continued) Principal Users
(See also SIG 4-1 and Tables of Equipment)

Name	Nomenclature Type No.	Used for	Description and Remarks
Tool Equipment	TE-124	Telephone Terminal Set TC-21 Telegraph Terminal Set TC-22 Repeater Set TC-23 Ringer Set TC-24	Metal tool box (16" x 7" x 7") containing adjusting and general use tools and gauges for depot maintenance of Spiral Four Equipments; includes cords and connecting tools, hydrometer, burnisher, spring adjusters, skinning knife, pliers, screw-drivers, soldering iron, gauges, etc. Expected to be cancelled and replaced by TE-123.
Tool Set: Telephone and Telegraph Installation and Maintenance for Small Office	Western Electric Co. X-66086	Packaged Equipments	Plant Eng. Agency
Tool Set: Telephone and Telegraph: Installation and Maintenance; for Medium Office	Western Electric Co. X-66087	Packaged Equipments	Plant Eng. Agency
Tool Set: Telephone and Telegraph: Installation and Maintenance; for Large Office	Western Electric Co. X-66088	Packaged Equipments	Plant Eng. Agency

Metal tool box (16" x 7" x 7") containing adjusting and general use tools and gauges for depot maintenance of Spiral Four Equipments; includes cords and connecting tools, hydrometer, burnisher, spring adjusters, skinning knife, pliers, screw-drivers, soldering iron, gauges, etc. Expected to be cancelled and replaced by TE-123.

For small packaged equipment offices (one per office). Tools and supplies for installation and maintenance of equipment. Includes three pocket tool kits, tool box containing adjusting tools for relays and other apparatus, and general use tools such as soldering iron, brace and bite, drills, extension lamp, chisels, tinners' snips, rollers for moving equipment, etc. All contained in tool chest. Includes Instruction Book, Western Electric Co. X-66307. Net weight approximately 120 lbs.

For medium-size packaged equipment offices (one per office). Similar to Tool Set X-66086 except larger quantities; contains five pocket tool kits. Includes Instruction Book, Western Electric Co. X-66307. Net weight approximately 120 lbs.

For large packaged equipment offices (one per office). Similar to Tool Sets X-66086 and X-66087, except larger quantities and assortment of tools and supplies; contains twelve pocket tool kits. Includes Instruction Book, Western Electric Co. X-66307. Net weight approximately 200 lbs.

1312. TOOL EQUIPMENTS - STOCK NUMBERS AND LOGISTICAL DATA.

Nomenclature		Stock No.	Packed for Export	
Name	Type No.		Weight (lbs.)	Volume (Cu. Ft.)
Tool Eqpt.	TE-5	6R38005	2.1	-
Tool Set	TE-16-()	6R38016()	128	6
Lineman's Equipment	TE-21	6Q63521	22	1.5
Groundman's Equipment	TE-23	6Q48523	-	-
Soldering Equipment	TE-26-()	6R24426()	24.6	.8
Tool Eqpt.	TE-27-()	6R38027()	57	2
Tool Eqpt.	TE-29	6R38029	2.5	.1
Tool Eqpt.	TE-33	6R38033	3.5	.2
Tool Eqpt.	TE-36	6R38036	22	1.1
Tool Eqpt.	TE-41-()	6R38041()	29	1
Tool Eqpt.	TE-44-()	6R38044()	300	9.5
Tool Eqpt.	TE-45-()	6R38045()	.6	-
Tool Eqpt.	TE-46	6R38046	204	9
Tool Eqpt.	TE-47	6R38047	380	21
Tool Eqpt.	TE-48	6R38048	40	2
Tool Eqpt.	TE-49-A	6R38049A	38.4	1.2
Tool Eqpt.	TE-50-A	6R38050A	44	2
Tool Eqpt.	TE-51	6R38051	-	-
Vulcanizing Equipment	TE-55-()	6R47255()	415	12.1
Tool Set	TE-56-A	6R38056A	147	6
Tool Equipment	TE-64-()	6R38064()	25.3	1
Tool Equipment	TE-69-()	6R38069()	425	17
Tool Equipment	TE-70	6R38070	132	6
Tool Equipment	TE-71	6R38071	43.5	2
Tool Equipment	TE-72	6R38072	38	1.6
Tool Equipment	TE-73	6R38073	5	.2
Tool Equipment	TE-79	6R38079	-	-
Tool Equipment	TE-87-()	6R38087()	1659	55.3
Tool Equipment	TE-111	6R38111	600	20
Tool Equipment	TE-112	6R38112	-	-
Tool Equipment	TE-113	6R38113	40	2
Tool Equipment	TE-114	6R38114	135	8
Tool Equipment	TE-123	6R38123	-	-
Tool Equipment	TE-124	6R38124	-	-
Tool Set	W.E.Co. X-66086	6R38190	188	8
Tool Set	W.E.Co. X-66087	6R38191	188	8
Tool Set	W.E.Co. X-66088	6R38192	312	12

Section V
Test Equipments

1313. GENERAL.

a. A Test Equipment (IK-) or Test Package consists of one or more test sets together with the required accessories for their operation. Most of the test sets included in these test equipments are listed in section V, covering Test Sets.

b. Paragraph 1314 gives a description of each Test Equipment or Test Package, the principal users of each, and the equipment or kind of equipment which each is designed to test.

c. Paragraph 1315 gives stock numbers and logistical data for the Test Equipments and Test Packages covered in paragraph 1314.

d. As mentioned in section I, the Signal Supply Catalog SIG 6 when issued, will contain a listing of test equipments.

1314. TEST EQUIPMENTS AND TEST PACKAGES - DESCRIPTION.

Par. 1314

Name	Nomenclature Type No.	Used for	Principal Users (See also SIG 4-1 and Tables of Equipment)		Description and Remarks
			Radio Repair Section	Wire Repair Trucks	
Test Equipment	IE-9-C	Radio Repair	Radio Repair Section		Consists of Analyzer I-167 or I-153-B, Frequency Meter Sets I-129 and SCR-211-(), Signal Generators I-72-() and I-208, Test Set I-199 (dynamotor test set) or I-63, Tube Tester I-177, ammeters, output meter, voltohmmeter, loud speaker, microphones, cords, headsets, etc. For 3rd and 4th Echelon use. Replaces IE-9, IE-9A and IE-9B.
Test Equipment	IE-10	Telephones and telegraph tests	Wire Repair Trucks		Consists of Test Set I-61-A, (transmission measuring set), batteries and hydrometers for 3rd and 4th Echelon use. Test sets TS-26/TSM and TS-27/TSM used with but not part of IE-10. Substitute standard. ^a Replaced by IE-29.
Test Equipment	IE-12-()	Radio Set SCR-624 Radio Set AN/YEC-1 Radio Set AN/YEC-7	Repair Shops		For testing and repair of equipment. Consists of crystal units, dynamotor unit, Field Strength Meter I-96-A, headset, jack boxes, junction boxes, microphone, control box, receiver, transmitter, Signal Generator I-96-A, tubes, cords, plugs, batteries, etc
Test Equipment	IE-17-()	Radio Set SCR-636	Sig.Co. Inf. Div. Inf. Regt. Lt. Inf. Regt. Sig. Depot Co. Sig. Rep. Co.		Used with but not part of Radio Set SCR-636. Includes antenna, instruction book, test case, test stand and Test Unit I-135-(). TM 11-311.
Test Equipment	IE-19-A	Radio Set SCR-624 Radio Set AN/YEC-1	Sig.Co. Dep. Avn. Sig.Co. Serv.Cp.		For checking equipment. Chest CH-93-A containing Test Set I-139-A, Field-Stronngth Meter I-95-A or -B, special tool set, Signal Generator I-130-A, batteries, cord, Instruction Book, etc.
Test Equipment	IE-22	Information Center SCS-5 Filter Center TC-15 Relays of telephone and telegraph equipments	AW Regts. AW Bn. Sig. Opa. Co. Sig. Opa. Bn. Sig. Dept. Avn. Co.		Consists of Test Set I-181 (W.E.Co. D-162269) and accessories, for making current flow tests of relays.
Test Equipment	IE-23	Information Center SCS-5 Filter Center TC-15	AW Regts. AW Bn.		Patching Cord and Power Cable Test Set.
Test Equipment	IE-25-()	Radio tests	Signal Co., Service Groups		Consists of Frequency Meter Set SCR-211, Test Set I-56-() and Test Set I-76 (test oscillator), ammeters, antenna, oscillator, oscilloscope, Signal Generator I-72-(), vacuum tube voltmeter, wavemeter.

^aSubstitute standard - not being procured, but equipment in stock may be supplied as substitute for similar standard equipment.

Nomenclature		Used for	Principal Users (See also SIG 4-1 and Tables of Equipment)	Description and Remarks
Name	Type No.			
Test Equipment	IR-29	Telephone and telegraph equipment tests	Wire Repair Trucks	Consists of Test Set I-61 (tone test set), Test Set I-61-() (transmission measuring set), Tube Tester I-177, Voltmeters I-23 and I-50 and Voltammeter I-166, converter, hydrometer and batteries. For 3rd and 4th Echelon use. Replaces IR-10.
Test Equipment	IR-36	Radio Set SCR-624 Radio Set AN/YRC-1	Sig.Co. Dep. Avn. Sig.Co. Serv. Cp.	Similar to and proposed to replace Test Equipment IR-19-A.
Test Equipment	IR-63-()	Spinal four carrier terminal and repeater stations	1st & 2nd Echelons of organizations to which TC-21-() or TC-23-() (theatre pool equipment) is assigned	Part of Telephone Terminal Set TC-21-() and Repeater Sets TC-23-() and TC-37-(). Consists of Test Set IS-190/U (test receiver W.E.Co. D-173231 or 67B (SPL) test set) and Voltammeter I-166.
Test Equipment	IR-75-()	Radio Receiver and Transmitter BC-611-() (Part of Radio Set SCR-536)	Inf. Regt. Lt. Inf. Regt.	Test equipment for aligning Radio Receiver and Transmitter BC-611-(); consists of test case, mounting, battery case, cord, Headset HS-30-(), etc. Simplified IR-17.
Testing Package: Telephone; C Carrier	Western Electric Co. X-61819T	Packaged Equipments: Terminal Package: Telephone; C Carrier Repeater Package: Telephone; C Carrier	Plant Engineering Agency	Testing equipment required for installation and maintenance of C carrier telephone packaged equipment, in addition to Test Package X-61821L. One required per office. Includes instruction book for each test set, test cards, plugs, special tools, spare tubes, fuses, etc. in addition to the major components, which are as follows: 51A (SPL) Oscillator (W.E.Co.) 32A (SPL) Transmission Measuring Set (W.E.Co.) 67B (SPL) Test Set (W.E.Co.) (IS-190/U). D-166852 Volt-Ohm-Milliammeter (W.E.Co.)

Table continued on next page.

TEST EQUIPMENTS AND TEST PACKAGES - DESCRIPTION.

(Continued)

Principal Users
(See also SIG 4-1
and Tables of
Equipment)

Nomenclature		Used for	Description and Remarks
Name	Type No.		
Testing Package: Telephone; Voice Frequency	Western Electric Co. X-61821L	Packaged Equipments: Repeater Package: Telephone; VF Ringer Package: Voice Frequency; 2 Circuit and 4 Circuit Terminal Package: Telephone; C Carrier Terminal Package: Telephone; H Carrier	Testing equipment required for installation and maintenance of voice frequency repeater and ringer packaged equipment, and for C and H carrier telephone equipment. One required per office. Includes instruction book for each test set, see paragraph 1317, drawings, test cords, spare fuses and tubes etc. in addition to the major components which are as follows: 19C (SPL) Oscillator (W.E.Co.) 15A (SPL) Transmission Measuring Set (W.E.Co.) 5A (SPL) Attenuator (W.E.Co.) 67B (SPL) Test Set (W.E.Co.) (TS-190/U) D-166852 Volt-Ohm-Milliammeter (W.E.Co.) Test Set I-181 (W.E.Co D-162269) Tube Tester I-171 (Hickok 560)
Testing Package: Telegraph; VF Carrier	Western Electric Co. X-61822C	Packaged Equipment: Telegraph Carrier Package: Voice Frequency; 6 Channel	Test equipment for use in offices equipped with X-61822A or X-61822B carrier telegraph packaged equipment. Consists of Test Set I-193-A, test cord, spare polar relays and TM 11-2513.
Testing Package: Telegraph; Regenerative Re- peater	Western Electric Co. X-66031B	Packaged Equipment: Repeater Package: Tele- graph; Regenerative	Testing equipment for X-66031A regenerative telegraph re- peater packaged equipment. Contains Test Set TS-2/7G, dc local test cord and miscellaneous maintenance tools required in addition to Tool Equipment TE-50 or TE-50-A.

1315. TEST EQUIPMENTS - STOCK NUMBERS AND LOGISTICAL DATA.

Nomenclature		Stock No.	Packed for Export	
Name	Type No.		Weight (Lbs.)	Volume (Cu. Ft.)
Test Equipment	IE-9-C	3F3919C	850	40
Test Equipment	IE-10	3F3920	2.9	.1
Test Equipment	IE-12-()	3F3922()	370	12
Test Equipment	IE-17-()	3F3927()	10	.5
Test Equipment	IE-19-A	3F3929A	170	9
Test Equipment	IE-22	-	-	-
Test Equipment	IE-23	-	-	-
Test Equipment	IE-26-()	3F3933-26()	957	45
Test Equipment	IE-29	3F3933-29	137	7
Test Equipment	IE-36	3F3933-36	15	1
Test Equipment	IE-53-()	3F3933-53	-	-
Test Equipment	IE-75-()	-	65	3.5
Testing Package: Telephone; C Carrier	W.E.Co. X-61819T	3F3963.1	145	7.5
Testing Package: Telephone; Voice Frequency	W.E.Co. X-61821L	3F3964.1	195	15
Testing Package: Telegraph; VF Carrier	W.E.Co. X-61822C	4A2796	114	5
Testing Package: Telegraph; Regenera- tive Repeater	W.E.Co. X-66031B	-	180	14

Section VI
Test Sets1316. GENERAL.

a. This section lists the test sets used for maintenance of ground communications equipment. Paragraph 1317 gives a brief description of each test set, lists the Instruction Book or Technical Manual which covers each, and gives other pertinent information. Paragraph 1318 gives the stock numbers and logistical data for these test sets.

b. Nearly all the test sets covered in this section are components of Test Equipments (IE's) or Test Packages (see section V). However, they may also be supplied as separate units, in which case they may require additional equipment

(batteries, tubes, etc.) which must be obtained separately. When a test set is issued as part of a Test Equipment of Test Package, the required batteries, tubes and other accessories together with running spares are finally issued with that Test Equipment. The information in the table in paragraph 1317 on battery and tube requirements makes no allowance for running spares. The last column of this table indicates what Test Equipment or other equipment each test set is part of, or other available information as to its issuance.

c. Test sets and other electrical instruments will be listed in Signal Supply Catalogue SIG 5, class 3, sub-class F, for all except certain teletypewriter tests sets which appear in class 4, sub-class T.

1317. TEST SETS AND TEST INSTRUMENTS - DESCRIPTION.

Nomenclature Name	Type No.	Shown in Fig.No.	Net Weight (lbs.)	TM or Instruction Book	Description and Remarks	Issuance
Volttammeter	I-23	-	1		Small meter for battery testing; scale ranges, 0-35 amp. and 0-11 volts; with 10 in. cord.	Part of IB-29
Test Set	I-48-B	-	21		For measuring resistances 0-1000 megohms. 500 volt. Single range. "Megger".	Part of TB-56-A
Test Set	I-49	1303	8	TM 11-2019 or W.E.Co. Instr. Book I-61796	Portable decade type Wheatstone Bridge for use of wire chief, line repairmen and maintenance men. For maintaining open wire and field wire circuits, and short haul cable circuits in small offices only, and for location of grounds, crosses, and shorts. Cannot readily be used for open location and capacitance measurements. Requires use of 3 batteries BA-30.	Formerly part of IE-10. Provided in Fired Plant Offices.
Volttammeter	I-50	-	1.5		D-c, triple range. Scale ranges 0-3, 0-15, 0-150 Volts and 0-3, 0-15 and 0-30 amperes.	Part of IB-29
Test Set	I-51	1304	20	TM 11-379	Cable repairman's portable tone test set, for locating shorts, grounds, crosses, split pairs and wet spots in cables. Consists of a tone supply from a spark gap induction coil. Includes an exploring coil (W.E.Co. 19C Test Set) and receiver, cord and plug all of which comprise W.E.Co. 1019C Test Set. Has high output and therefore will introduce noise in parallel circuits. Where a set with lower output is required, use W.E.Co. 76A Test Set, 1019C or 1119C Test Set, 108A Amplifier and connecting cord. Requires 4 Batteries BA-25.	Part of IB-29
Test Set	I-56-()	-	37	TM 11-321 TM 11-303	A universal radio test set. Consists of a group of instruments for servicing radio equipment; output meter, tube tester, meters for measuring current, voltage and resistance in various ranges, test prods., etc. in carrying case.	Part of IB-26-()
Test Set	I-61-A	1305	21	TM 11-346	Transmission measuring set; portable, dry battery operation. To measure losses or gains in circuits or apparatus. Includes 1000-cycle oscillator, receiving amplifier, rectifier and meter. Oscillator has outputs -40, -20, and 0 dbm into a 600-ohm load. Will measure power from a 600-ohm source between -50 and +15 dbm over a frequency range from 100 to 10,000 cycles. No spare tubes included. Requires 5 Batteries BA-30 and 3 Batteries BA-56.	Part of IB-10 Part of IB-29
Test Set	I-61-B I-61-C	-	47	TM 11-346	Same as I-61-A except: oscillator transmits 500, 1000 and 2500 cycles, includes local battery telephone, spare tubes, no batteries. Requires following batteries: two BA-30, three BA-35 and two BA-56.	Part of IB-10 Part of IB-29
Signal Generator	I-72-()	-	20	TM 11-307	Self-containing; for operating on a 105-130 volt, 60 cycle (3F3852().1) or 25 cycle (3F3852().2), single phase power. Frequency range 100-32,000 kc, with provisions for 400-cycle modulation. Intended for vehicular use.	Part of IB-9-C Part of IB-26-()

Name	Type No.	Shown in Fig.No.	Net Weight (lbs.)	TM or Instruction Book	Description and Remarks		Issuance
Test Set	I-76	-		TM 11-1041	Test Oscillator BC-276-() with tubes and batteries, test indicator BE-67 with batteries and cords and Headset HS-23. Replaces I-66. For aligning marker beacon receivers.	Part of IE-26-()	
Test Set	I-83-A	-		TM 11-2506	Dynamotor test set; for measuring input current and voltage, output current and voltage and input and output ripple voltage of various 12 and 28 volt dynamotors and dynamotor units. Includes socket and cords.	May be supplied as an alternate in IE-9-C	
Test Meter	I-87-()	-			Tuning meter (0-100 ma) and micro-ammeter (center 0) mounted in a case. For adjusting transmitter and receiver to proper operation frequency. Includes cord and plug for connecting to receiver or transmitter under test.	Used with but not part of SCR-293 and SCR-294	
Field Strength Meter	I-95-()	-			For determining relative field strength readings and a rough over-all check of transmitter operation. Tube VT-172 (JAN-155) supplied separately. Requires 2 Batteries BA-2 and 1 BA-33.	Part of IE-12-() Part of IE-19-A	
Signal Generator	I-96-()	-			Provides signals for testing radio receivers and measuring equipment for metering the transmitter output. Includes milliammeter. Requires tubes as follows: 2 VT-202, 2 VT-203, 1 VT-139, 1 VT-197-A. For tuning and aligning BC-624 receiver and BC-625 transmitter.	Part of IE-12-()	
Bias Meter	I-97-A	-		TM 11-2200	Portable field meter of the zero center type. Used with Line Unit BE-77 for normal adjustment of teletypewriter circuits. Not required with BE-77-A or -B.	Part of EE-97 & -98	
Voltmeter	I-107	-		TM 11-306C or D	Vacuum tube, d-c, battery operated; ranges 0.1 to 10 megohms in 6 steps, 3 to 1000 volts full scale in 6 steps; input resistance 10 megohms on all voltage scales. Requires 2 Batteries BA-30 and 1 Battery BA-40.	Part of EE-13-()	
Frequency Meter Set	I-129-()	-		TM 11-304	Consists of four absorption type wave meters contained in a steel carrying case. Frequency range 1.5 to 40 mc.	Part of IE-9-C	
Signal Generator	I-130-A	-			Portable; frequency band 100-156 megacycles. Uses separate battery supply. Requires 2 Tubes JAN-902 and 3 Tubes JAN-903. Requires 6 Batteries BA-2 and 4 Batteries BA-23. For tuning Radio Receiver BC-624 and Radio Transmitter BC-625.	Part of IE-19-A	
Test Unit	I-135-()	-		TM 11-311	Case containing multi-range meter, RF and AF oscillators, receiver, microphone, crystal tester, switches, terminals, test harness, etc. Requires one Battery BA-23 and two Batteries BA-26.	Part of IE-17-()	
Test Set	I-139-A	-			Meter contained in metal case; 0-1 ma, d-c; designed for measuring current in 2 positions in Signal Generator I-130-A, in 5 positions in Radio Trans. BC-625 and 1 position in Radio Receiver BC-624; includes cord and plug.	Part of IE-19-A	
Analyzer	I-153-B	-			Multimeter; 0-6,000 volts; d-c 20,000, a-c and d-c 1,000 ohms per volt; 7 ranges 0-60 microamp. to 12 amp.; resistance 0-60 meg; six db ranges, +12 to +70 db, and 7 output ranges. Requires 1 Bat. BA-2 and 1 Bat. BA-30.	May be supplied as alternate for I-167-() in IE-9-C	

Table continued on next page.

TEST SETS AND TEST INSTRUMENTS - DESCRIPTION. (Continued)

Nomenclature Name	Type No.	Shown in Fig.No.	Net Weight (lbs.)	TM or Instruction Book	Description and Remarks	Issuance
Voltammeter	I-166	1306	4	TM 11-2613	Voltage ranges; a-c, 0-500V; d-c, 0-5, 0-15, 0-50, 0-150, 0-500, 0-1500V. Resistance ranges; d-c, 0-1000, 0-10,000, 0-100,000 ohms and 0-1 megohm. Measures audio frequency output voltage at 4000 ohms impedance, ranges 0-1.5, 0-5, 0-15, 0-50, 0-150 volts; and at 300 ohms impedance, ranges 0-5, 0-15, 0-30 volts. Requires 1 Battery BA-31.	Part of IE-29 Part of IE-53-() Part of test set I-56-()
Analyzer	I-167-()	-	-	-	Meter. Voltage ranges 2.5-1000V. in five steps a-c and d-c; current, 100 microamperes to 10 amperes in 7 steps, d-c; resistance, 3,000 ohms to 30 megohms in four steps; decibels -14 to +54. Requires 1 Battery BA-30 and 2 Batteries BA-34.	Part of IE-9-()
Tube Tester	I-171 (Hickok Model 560)	-	-	TM 11-2047 or W.E.Co. Instr.Books X-66157 and X-66464	Portable tube tester for small size amplifier and rectifier tubes, etc. Power required, 60 watts, 105-225 volts, 50-60 cycles, a-c. Replaced by I-177.	Part of Testing Package: Telephone; Voice Frequency X-61821L
Test Unit	I-176	-	-	-	Combined a-c and d-c voltmeter and ohmmeter, complete with test leads; can be used to check voltage between any two elements of a tube and current through tube when in operating circuit; ranges as follows: D-c, 0-5/25/100/250/1000/5000 V - 20,000 ohms per V. A-c and D-c, 0-5/25/100/250/1000 V - 1000 ohms per V. D-c, 0-1/6 amp. A-c, 0-0.5/1.0/5/10 amp. 0-1000/100,000/10,000,000 ohms. D-c, 0-1/10/100/500 ma. D-c, 0-50 microamperes.	Part of Test Set I-56-()
Tube Tester	I-177	1307	-	TM 11-2627	Portable tube tester of the dynamic or mutual transconductance type capable of operation on 110 or 220 volts, 50-60 cycles a-c. Replaces I-171.	Part of IE-9-C Part of IE-29 Part of Test Set I-56-()
Test Set	I-181	1308	9	TM 11-2036 or W.E.Co. Instr. Book X-61778	A portable current flow test set for use in testing and adjusting relays (and similar apparatus) in accordance with electrical requirements for performance of the relay. Provides for application of specified values of current thru the relay winding. May also be used as milliammeter in scale ranges 0-15 ma, 0-75 ma, 0-150 ma. Test cords and connecting tools as listed in X-61778 or TM 11-2036 are required but are not provided as part of test set. W.E.Co. D-162269 Test Set.	Part of Testing Package: Telephone; Voice Frequency X-61821L. Part of IE-22
Test Set	I-193-A	1309	65	TM 11-2513	Polar Relay Test Set. For testing and adjusting W.E.Co. telegraph polar relays 255A, D-163119A and D-164316. Includes special adjusting tools for these relays. Test set also provides source of 10 or 20 cycles "open-and-closed" signals for lining up the X-61822 carrier telegraph system. Cords supplied for connecting to d-c power source, or to rectifiers such as Rectifier RA-37 or RA-87. Power required, 10 watts, 115-130 volts d-c.	Part of Testing Package: Telegraph; VF Carrier X-61822C

Name	Nomenclature Type No.	Shown in Fig.No.	Net Weight (lbs.)	TM or Instruction Book	Description and Remarks	Issuance
Test Set	I-199	-	-	TM 11-2604	Dynamotor test set, two-meter instrument, measures input and output voltages, current and ripple. Replaces Test Set I-235-A in Test Equipment IE-9-C.	Part of IE-9-C
Signal Generator	I-208	-	-	TM 11-317	Frequency ranges 1.9 to 4.5 megacycles and 19.0 to 45.0 megacycles. Frequency generator. Can be operated from 12-volt vehicular battery or from a 115-volt 60-cycle a-c source. Used for calibration, sensitivity check and alignment purposes.	Part of IE-9-C
Alignment Indicator	I-210	-	-	TM 11-316	An electronic alignment unit, with electron ray tube VT-215. Optional replacement for Voltammeter I-107 in Maintenance Equipment ME-13-(). Requires 1 Batt. BA-39.	Part of ME-13-() Part of ME-40-()
Test Unit	I-236-()	-	-	-	Neon and Mazda lamp a-c and d-c voltage check unit used in maintaining teletypewriter equipment, to check the continuity of circuits which may or may not contain a "voltage".	Part of TE-50-A
Analyzer	BC-1052-()	-	-	-	Analyzer with multiplier for readings up to 3000 volts. Used with but not part of Radio Set SCR-299. Used with and part of Radio Sets SCR-399 and SCR-499.	Part of SCR-399 and 499
Cabinet	BE-70-()	-	-	See Paragraph 429		Formerly part of IE-10, part of Telephone Central Office Sets T-1 and T-2
Test Set	EE-65	-	16.8	TM 11-361	Wire chief's portable compact testing equipment for field and central office use. Includes telephone set, hand generator, buzzer, voltmeter (3,000 ohms) and 5 circuit switching keys. Voltmeter range 0-50 V d-c. For maintenance of common battery and magneto telephone equipment, station lines and trunks. Tests for grounds, crosses, shorts, opens, line capacitance to ground or to other lines and distance to an open; measures insulation resistance 500-115,000 ohms using conversion table of TM 11-361. Provides for talking and signaling to switchboards and telephones. Requires 1 Batt BA-1 and 2 Batt BA-2. Replaced by Test Sets TS-26/TSM and TS-27/TSM.	-
Test Set	EE-65-A and B	-	-	TM 11-361	Same as EE-65 except has 50,000 ohm voltmeter; measures insulation resistance of 10,000 ohms to 2 megohms; requires 2 Batt BA-30 and 2 Batt BA-2; and the following must be supplied separately: 1 Headset TS-9 equipped with Plug PL-58 or 1 Headset HS-30-() equipped with Cord CD-605 and Chest Set TD-1, 1 ground rod, and 1 Coil C-61 (W.E.Co. 12A) or W.E.Co. 12S. Replaced by Test Sets TS-26/TSM and TS-27/TSM.	-
Test Set	EE-65-C,D, E, F & G	1310	-	TM 11-361	Same as EE-65-A or B except has 6 keys; measures also loop resistance of 22 to 10,000 ohms by using conversion table of TM 11-361; and does not require use of 12A or 12S coil. Replaced by Test Set TS-26/TSM and TS-27/TSM.	-

Table continued on next page.

TEST SETS AND TEST INSTRUMENTS - DESCRIPTION. (Continued)

Name	Nomenclature Type No.	Shown in Fig. No. (lbs.)	Net Weight (lbs.)	TM or Instruction Book	Description and Remarks	Issuance
Frequency Meter Set	SOR-211-()	-	38	TM 11-300	Consists of frequency meter for calibrating radio transmitters and oscillating receivers by direct comparison, together with accessories (tubes, crystal units, etc.).	Part of IR-9-C Part of IR-26-()
Test Set	TS-2/TC	1311	70	TM 11-2208 or Teletype Instr. Man. No. 43	Portable teletypewriter signal distortion test set for sending normal and distorted (up to 50%) test signals for checking the quality and for lining up teletypewriter equipments, regenerative repeaters and teletypewriter circuits. The signal sent from motor-driven coms by an a-c series governed motor, adjustable for speeds of 368 or 404 cpm. Test signals may be a test message, repeat space, R or Y. Equipped with jacks and resistors to provide 60 mill local circuit (d-c power from external source) for checking performance of teletypewriters. Power input requirements: 150 V.A. at 115 V. 50/60 cyc. a-c for motor power; 7 W. at 115 V. d-c for local test circuit.	Part of Test Package: Tele- graph; Regenera- tive Repeater X-66031B
Test Set	TS-26/TSM	1312	8	TM 11-2017	Maintenance and lineman's multirange voltohmmeter, to maintain common battery and magneto office equipment, and lines. Tests for grounds, crosses, shorts and opens, line capacitance to ground or to other lines, and distance to an open on a line. Voltage scale ranges 0-600V. d-c; resistance 0-1 megohm, or 0-10 megohms if 45V test bat. is used. Requires 1 Bat. BA-31.	-
Test Set	TS-27/TSM	1313	50	TM 11-2058	Maintenance and lineman's portable field wire testing and fault locating set. Provides direct current bridge for measurement of conductor and insulation resistance, and the location of grounds, crosses and shorts, and an alternating current bridge for measurement of capacitance and location of open. A telephone set such as Telephone EE-8-() may be connected for two-way talking and signaling between maintenance groups. Requires 2 Bat. BA-30 and 2 Bat. BA-59 or BA-63.	-
Test Oscillator	TS-32/TRC-1	-	-	-	Crystal-controlled test oscillator with provision for 1000-cycle frequency modulation of output signal in frequency range of 70-100 mc with 200 kc separation. Includes provision for alternating and indicating HF outputs. Used to adjust and align Radio Receiver R-19/TRC-1 (part of Radio Sets AN/TRC-1, AN/TRC-3 and AN/TRC-4).	-
Test Set	TS-190/IV (W.E.Co. No. 67B(Sp1.), D-173231)	-	-	TM 11-2046 or W.E.Co. Instr. Book X-61806	High resistance test receiver, for making trouble location tests. Used in checking points in circuits for presence of battery or ground; and for continuity through contacts. When bridged across a contact, a click in the receiver indicates the contact is not making. Also may be used for monitoring. Has leads equipped with test pick and a socket type connector. The test pick includes a switch which short-circuits a 50,000 ohm resistance in series with the receiver. Receiver approximately 1,000 ohms.	Part of IR-53-() Part of Operations Center AN/ITQ-1 Part of Testing Package: Tele- phone; C Carrier X-61819F and Test- ing Package: Tele- phone; Voice Fre- quency X-61821L

Name	Nomenclature Type No.	Shown in Fig. No.	Net Weight (lbs.)	TM or Instruction Book	Description and Remarks	Issuance
Attenuator	Western Electric Co. No. 5A(Spl.)	1314		TM 11-2044 or W.E.Co. Instr.Book X-66234	Small portable attenuator for introducing 600-ohm impedance balanced losses of from 0 db to 81 db in steps of 1 db. Suitable for use up to 100 kilocycles.	Part of Testing Package: Telephone; V.F. X-61821L
Transmission Measuring Set	Western Electric Co. No. 13A(Spl.)	1315		TM 11-2045 or W.E.Co. Instr.Book X-66233	Portable test unit for measuring testing power over frequency range of 30 cycles to 15 kilocycles; input impedance approximately 600 ohms; can be used to measure received power from -45 db to +10 db. An external source of testing power of 1 milliwatt is required for gain or loss measurements. Power required for operation of set, 50 watts, 105-125 volts either d-c or 25-60 cycles a-c.	Part of Testing Package: Telephone; Voice Frequency X-61821L
Test Set	Western Electric Co. No. 19C	1304 1316	3		Exploring coil. See W.E.Co. No. 1019C and 1119C Test Sets.	Part of W.E.Co. 1019C and 1119C Test Sets
Oscillator	Western Electric Co. No. 19C(Spl.)	1317		TM 11-2039 or W.E.Co. Instr.Book X-66232	Heterodyne-type vacuum tube oscillator which provides a source of testing current for transmission measurements; is capable of supplying an output from -4 dbm to +6 dbm over a frequency range from 30 cycles to 15 kilocycles. One control dial serves to vary the frequency continuously over the full range. For greater precision as to frequency in the range below 250 cycles, an expanded scale is provided on the same dial. Employs five vacuum tubes; output impedance 600 ohms. Power required, 25 Watts, 105-125 Volts, either d-c or 50-60 cycles a-c.	Part of Testing Package Telephone; Voice Frequency X-61821L
Transmission Measuring Set	Western Electric Co. No. 32A(Spl.)	1318		TM 11-2048 or W.E.Co. Instr.Book X-66226	Portable test unit for measuring testing power over frequency range of 150 cycles to 150 kilocycles. Power from 600 ohm circuit can be measured either on a terminated or a bridging basis over a range of -35 dbm to +34 dbm. Includes an attenuator, range 35 db in 5 db steps. A 135-600 ohm impedance ratio repeating coil is included for measurements on 135-ohm circuits. Power input required 50 watts, 105-125V. 50-60 cycles a-c.	Part of Testing Package Telephone; C Carrier X-61819T
Oscillator	Western Electric Co. No. 51A(Spl.)	1319		TM 11-2040 or W.E.Co. Instr.Book X-66227	The 51A(Spl.) Oscillator per X-66065B is a portable unit capable of supplying single frequencies from 2 kilocycles to 79 kilocycles in one-kilocycle steps. A 0 KC to -1 KC control permits the frequencies to be continuously varied from 0 to -1 kilocycle from the indicated value. A minimum frequency of approximately one kilocycle may be obtained. Output range from +16 to -75 dbm. Output impedance 135 ohms; requires use of 135:600-ohm repeating coil when employed for supplying testing power to 600-ohm circuits. The repeating coil included in the 32A (Spl.) Transmission Measuring Set may be used for this purpose. Requires 60 watts; operates on 105-125 volts, 50-60 cycles, a-c.	Part of Testing Package Telephone; C Carrier X-61819T

Table continued on next page.

TEST SETS AND TEST INSTRUMENTS - DESCRIPTION.

(Continued)

Name	Nomenclature		Shown in Fig. No.	Net Weight (lbs.)	TM or Instruction Book	Description and Remarks	Issuance
	Type No.	Fig. No.					
Test Set	Western Electric Co. No. 76A	1316	18	-		Cable splicer's portable tone test set consisting of a tone supply from a battery operated vacuum tube oscillator. Used with W.E.Co. 108A Amplifier, 1019C or 1119C Test Set and W2BK cord equipped with 47B and 186 plugs for locating shorts, grounds, crosses, split pairs and wet spots in cables. Has a lower output than the Test Set I-51. Cable splicer can signal and talk to wire chief or maintenance man having a 76A Test Set. Vacuum tubes (VT147 and VT221) are furnished with the set. Requires 2 Batt. BA2, 2 Batt. BA27.	Part of TT-56-A
Amplifier	Western Electric Co. No. 108A	1316	11			For use with W.E.Co. 76A Test Set, 1019C or 1119C Test Set and W2BK cord equipped with 47B and 186 plugs in cable testing, fault locating for identifying wires in cables. Consists of 107A Amplifier, W2BJ cord equipped with 513A tool and No. 47B plug and R2CF cord equipped with 52B Receiver and No. 110 plug. Requires 1 Batt. BA27, 2 Batt. BA2, 3 Tubes VT44.	Part of TT-56-A
Test Set	Western Electric Co. No. 1017E	1320	7			Line repairman's telephone. Talking and listening. Also signaling to all switchboards and telephones. 20-cycle hand generator and buzzer. Will operate a 56A drop through 11,500 ohms. Consists of W.E.Co. 17E Test Set with transmitter and receiver. Requires 1 Batt. BA-27.	
Test Set	Western Electric Co. No. 1019C	1304				Exploring coil (W.E.Co. No. 19C Test Set) and 1 No. 52B or No. 716B Receiver equipped with RC2D cord and No. 186 plug; for use in locating various low resistance conductor faults in cable. If difficulty is experienced in hearing tone pickup, W.E.Co. No. 108A Amplifier may be used with No. 1019C Test Set, requiring the use of W2BK card equipped with No. 47B and No. 186 plugs (not furnished with test set). Used with W.E.Co. No. 76A Test Set.	Part of Test Set I-51. Part of TT-56-A
Test Set	Western Electric Co. No. 1119C					Same as W.E.Co. No. 1019C Test Set, except includes 2 No. 52B or No. 716B receivers equipped with a No. 1B headband and R2CC cord with No. 186 plug, instead of single receiver.	
Volt-Ohm-Milliammeter	Western Electric Co. No. D-166852	1321	3	TM 11-2042 or W.E.Co. Instr. Book X-66260		Portable meter. Ranges: voltage a-c or d-c, 0-3, 0-15, 0-30, 0-150, 0-300 volts; current d-c, 0-150 milliamperes. 0-3, 0-15 amp; resistance, 0-1000, 0-10,000, 0-100,000, 0-1,000,000 ohms. Is equipped with 4-1/2 volt battery. Includes two pairs of test leads, one pair equipped with test picks (W.E.Co. KS-9290), the other with test clips (W.E.Co. KS-9291). Carrying case (W.E.Co. KS-9307) and Carrying Strap (W.E.Co. KS-9308) are not included as part of meter. Carrying strap attaches either to meter or carrying case.	Part of Testing Packages: Telephone; C Carrier X-61819T and Telephone; V.F. X-61821L Part of Operations Center AN/TTQ-1 Alternate for I-166 in DE-53- ().

Name	Type No.	Shown in Fig. No.	Net Weight (lbs.)	TM or Instruction Book	Description and Remarks	Issuance
Volt-Ohm-Millimeter (Multimeter)	Western Electric Co. (Multimeter) No. D-169370	1522			Volt-ohm-millimeter (multimeter) similar to W.E.Co. D-166852 meter, but with test lead reversing switch, provision for connection of external 45 V battery and 0-10 megohm scale. Will perform same functions as Test Set TS-26/TSM by connection of external 45 V Battery RA-59. Includes pair of test pick leads (W.E.Co. ES-9290) and pair of test clip leads (W.E.Co. ES-9291). W.E.Co. Carrying Case ES-9307 (Stock No. 382573-2) may be used to contain meter and external battery, and Strap W.E.Co. ES-9308 (229049.11) for carrying meter or carrying case, but are not included as part of meter.	May be supplied in place of I-166 in IE-53-()
Patching and Power Cable Test Set	Per W.E.Co. ES-800092	-	-	-	Portable test set for testing power and patching cables terminated in 4- or 24-conductor Jones type plugs, for continuity, shorts and crosses. Required cords supplied with test set and with Filter Center and Information Center equipment.	Part of IE-23, Filter Center TC-15 and Information Center SC5-5
Test Set	Teletype Corp. No. DMD-1	1323	63	Teletype Corp. Instr. Man. No. 43	Signal distortion test set for use largely in maintenance depots and repair shops. Test signals transmitted from set may be distorted from 0 to 100%. Signals measured by means of a stroboscope containing a small neon lamp. Transmitted signals are test message, R and Y. A motor power cord is supplied. Additional equipment required: Motor Unit Assembly MU26 (115 V, 50/60 cys, a-c series governed motor) Set of Gears, #96572 Signal Line Cord, #103230 Stroboscope Cord, #103231 +110V D-c Cord, #103232 -110V D-c Cord, #103233 Motor requires power input of 125 VA at 115 volt, 50/60 cycle, a-c.	-
Test Set	Teletype Corp. No. DMD-4	-	63	Teletype Corp. Instr. Man. No. 25	Same as Test Set DMD-1 except arranged to send "blank" T, O, M, V or "letters" signals in addition to the test message, R and Y signals. Supplied with all required cords. Motor unit and gears are ordered separately.	-
Tuning Fork	Teletype Corp. 103628	-	-	-	87.6 VPS tuning fork for use in adjusting speed of teletypewriter motor to American Standard of 368 OPM.	Part of TB-50-A
Tuning Fork	Teletype Corp. 104984	-	-	-	96.19 VPS tuning fork for use in adjusting speed of teletypewriter motor to British Standard of 404 OPM.	Part of TB-50-A

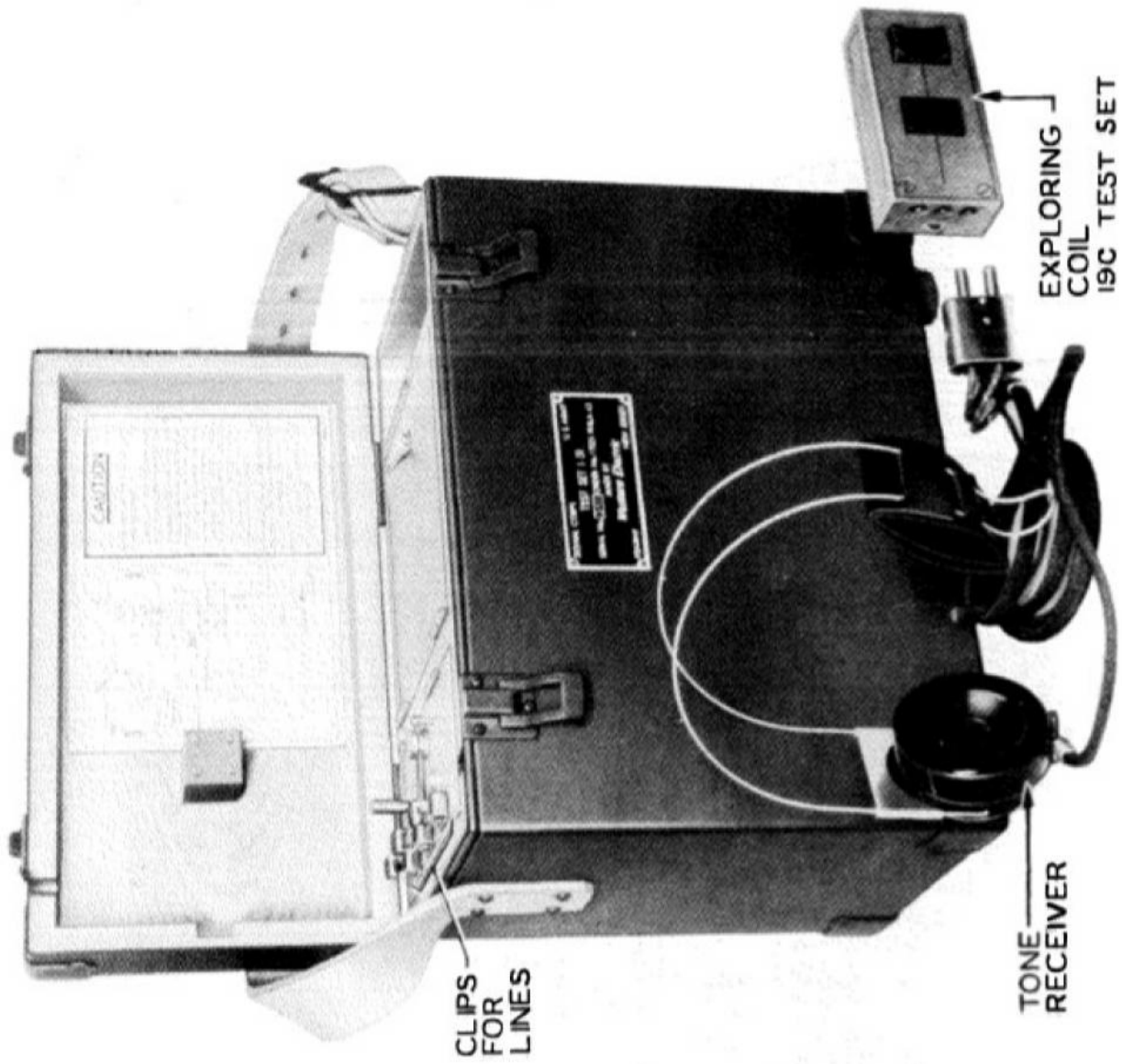

FIGURE 1304. Test Set I-51

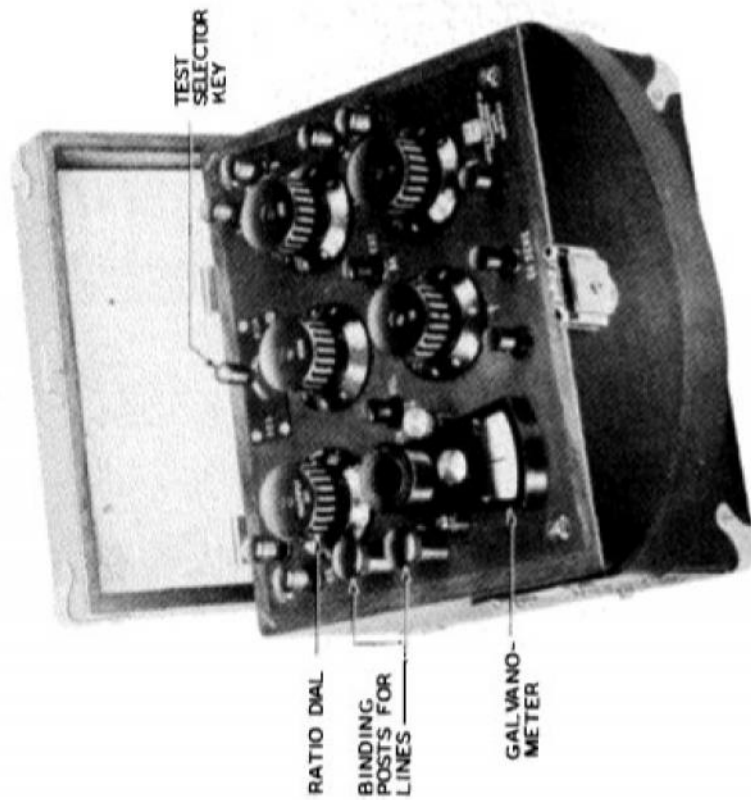

FIGURE 1303. Test Set I-49

FIGURE 1306
Voltmmeter I-166

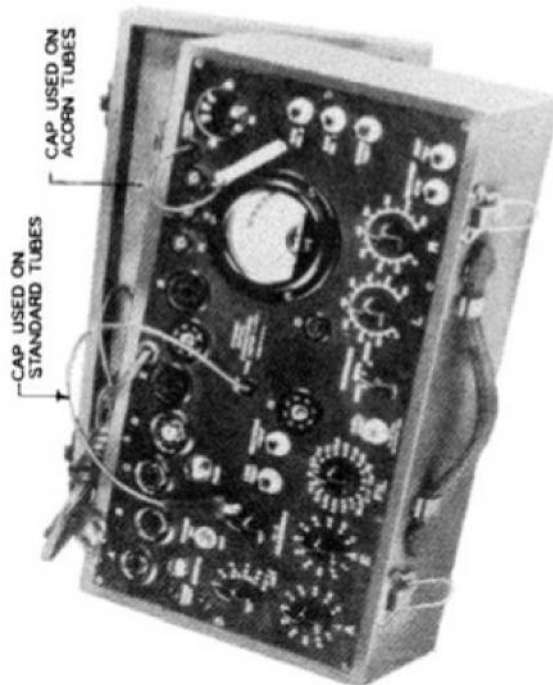
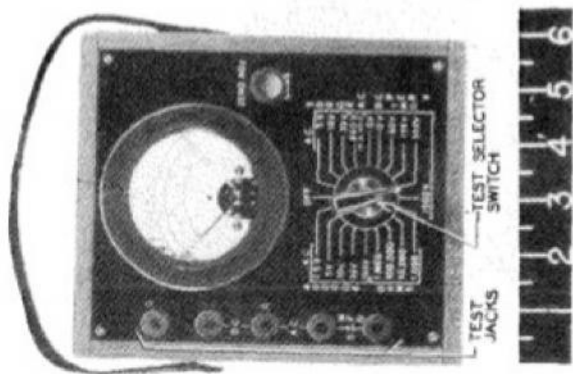

FIGURE 1307. Tube Tester I-177

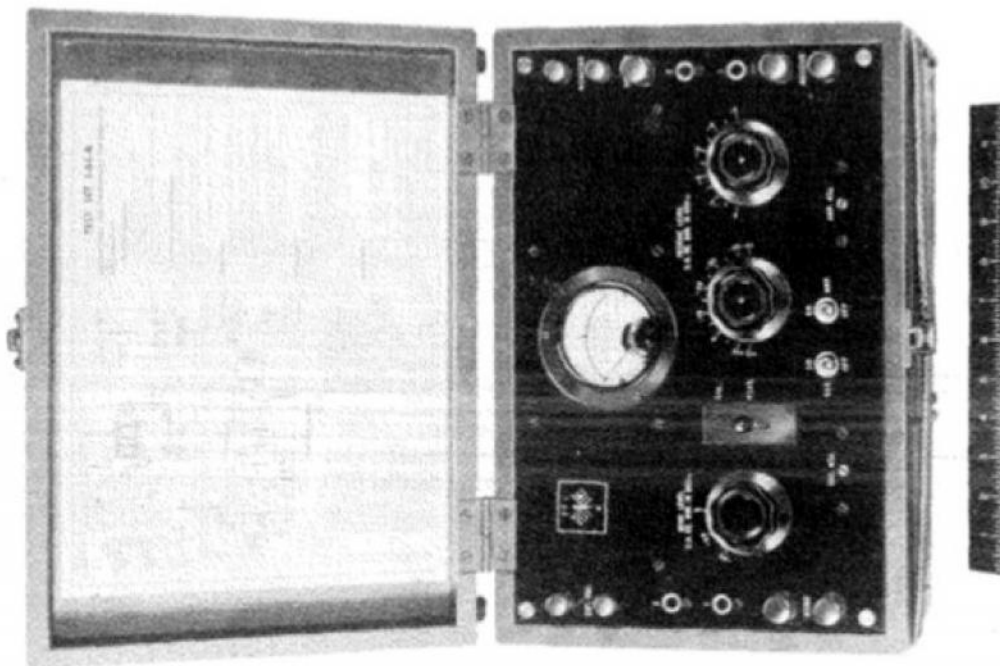

FIGURE 1305. Test Set I-61-A

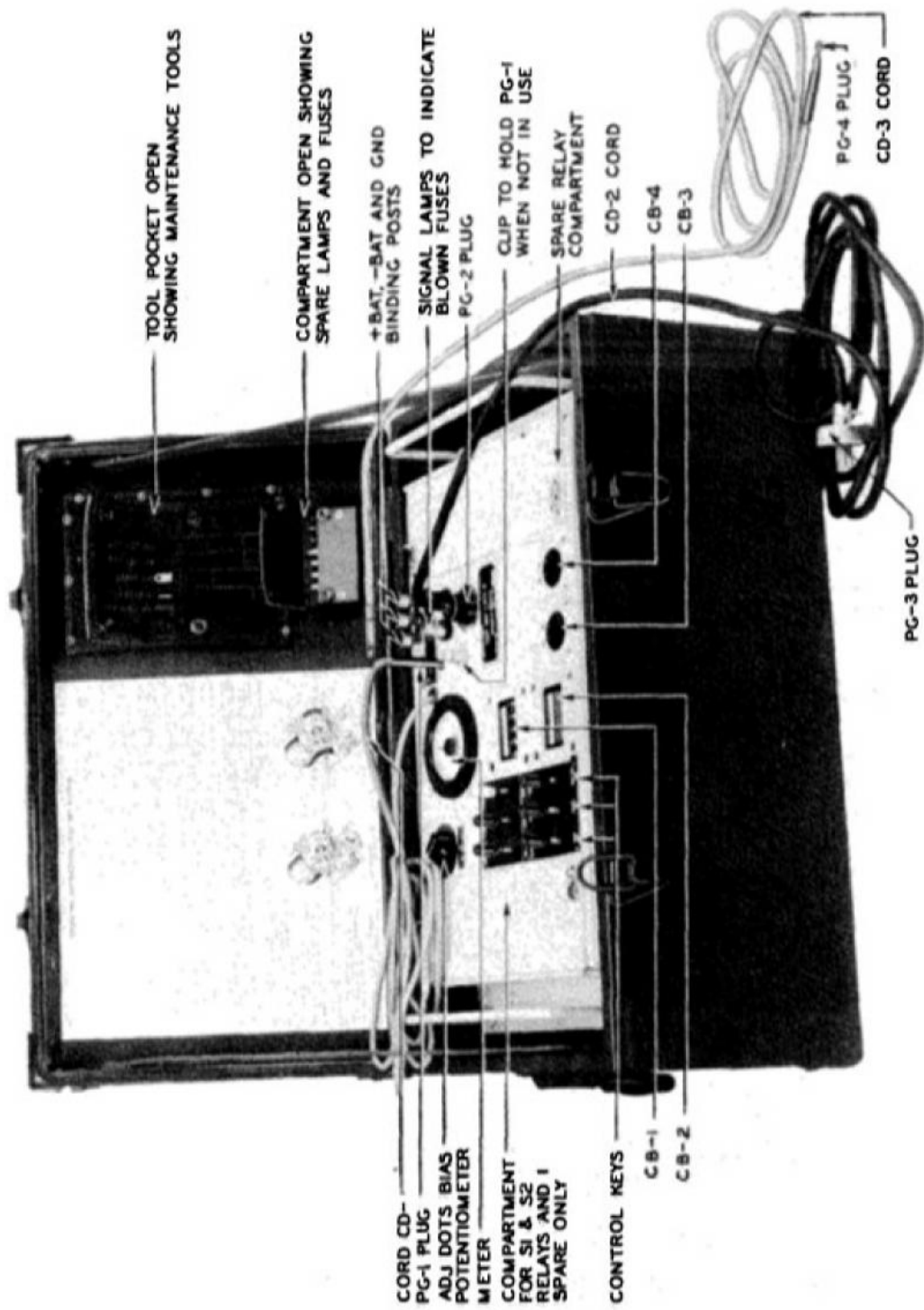

FIGURE 1309. Test Set I-193-A

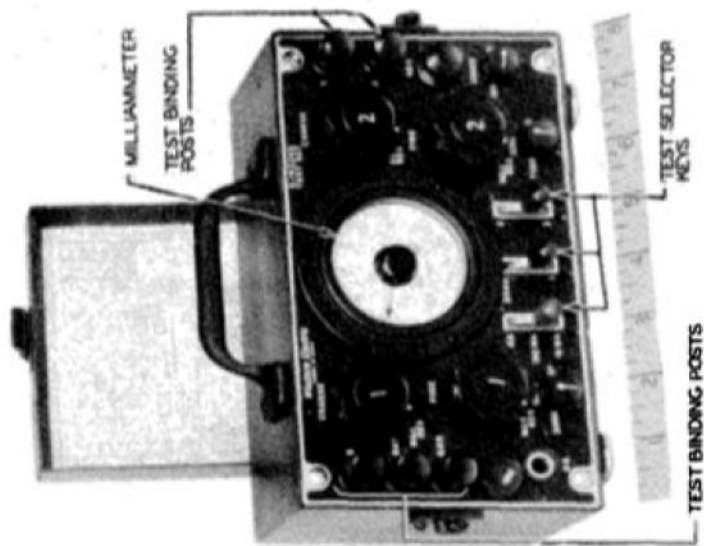

FIGURE 1308. Test Set I-161

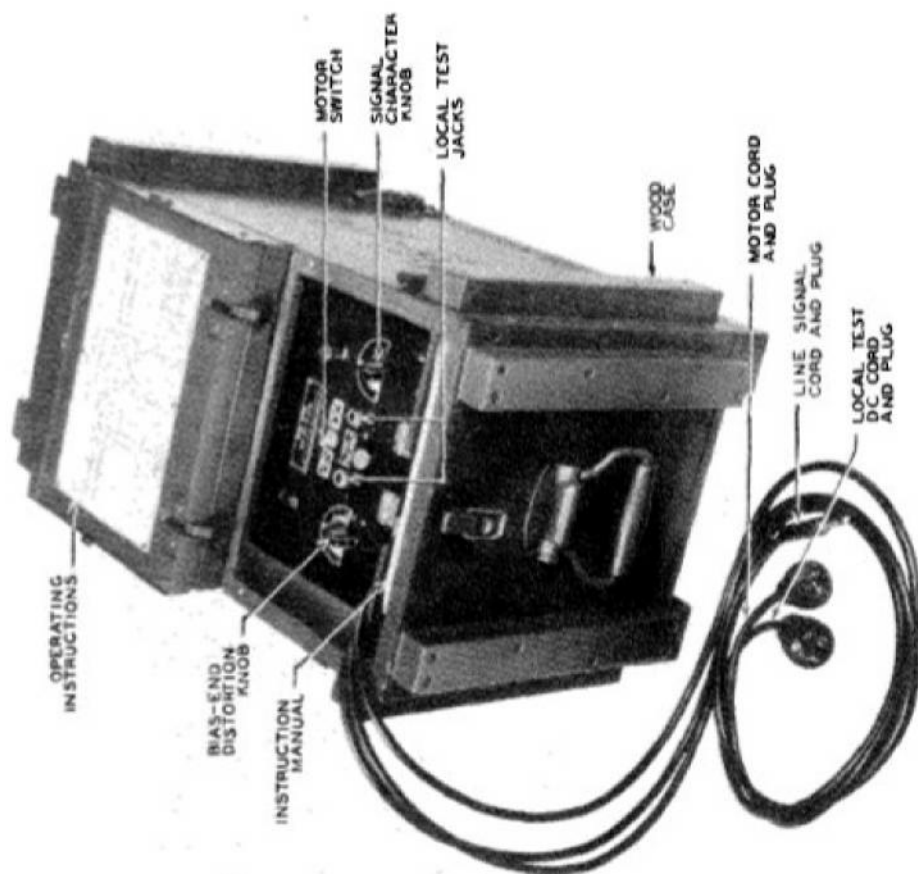

FIGURE 1311. Test Set TS-2/TG

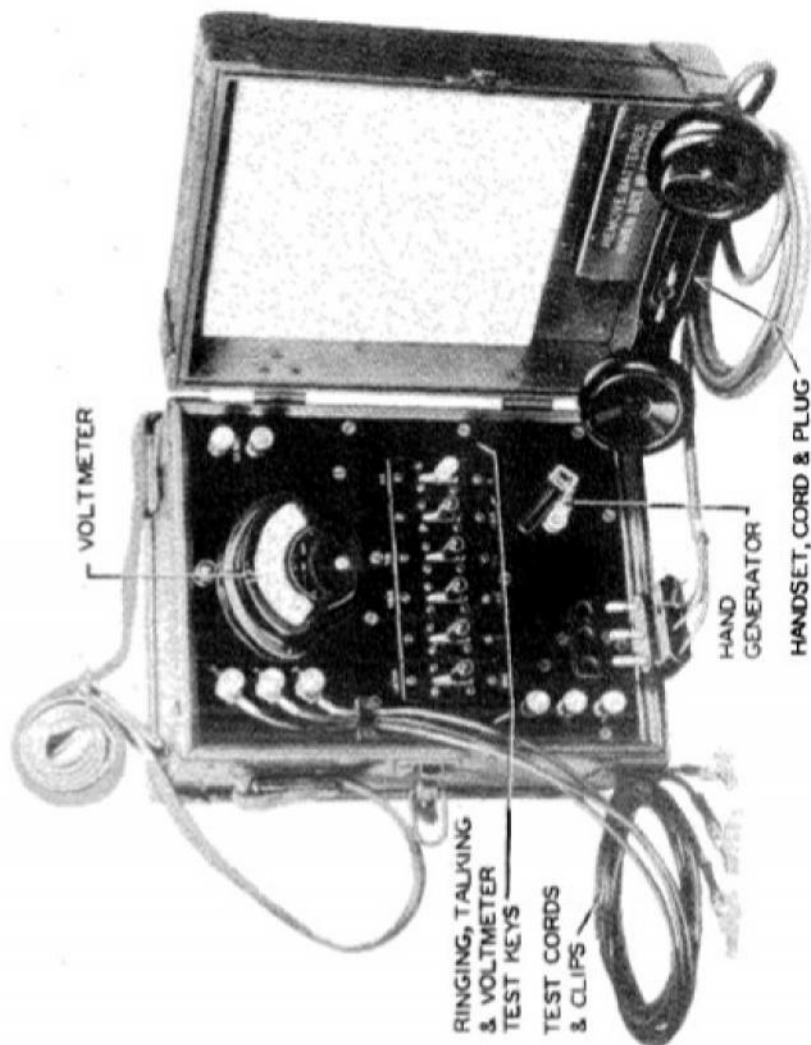

FIGURE 1310. Test Set EB-65-C, D, E, F or G

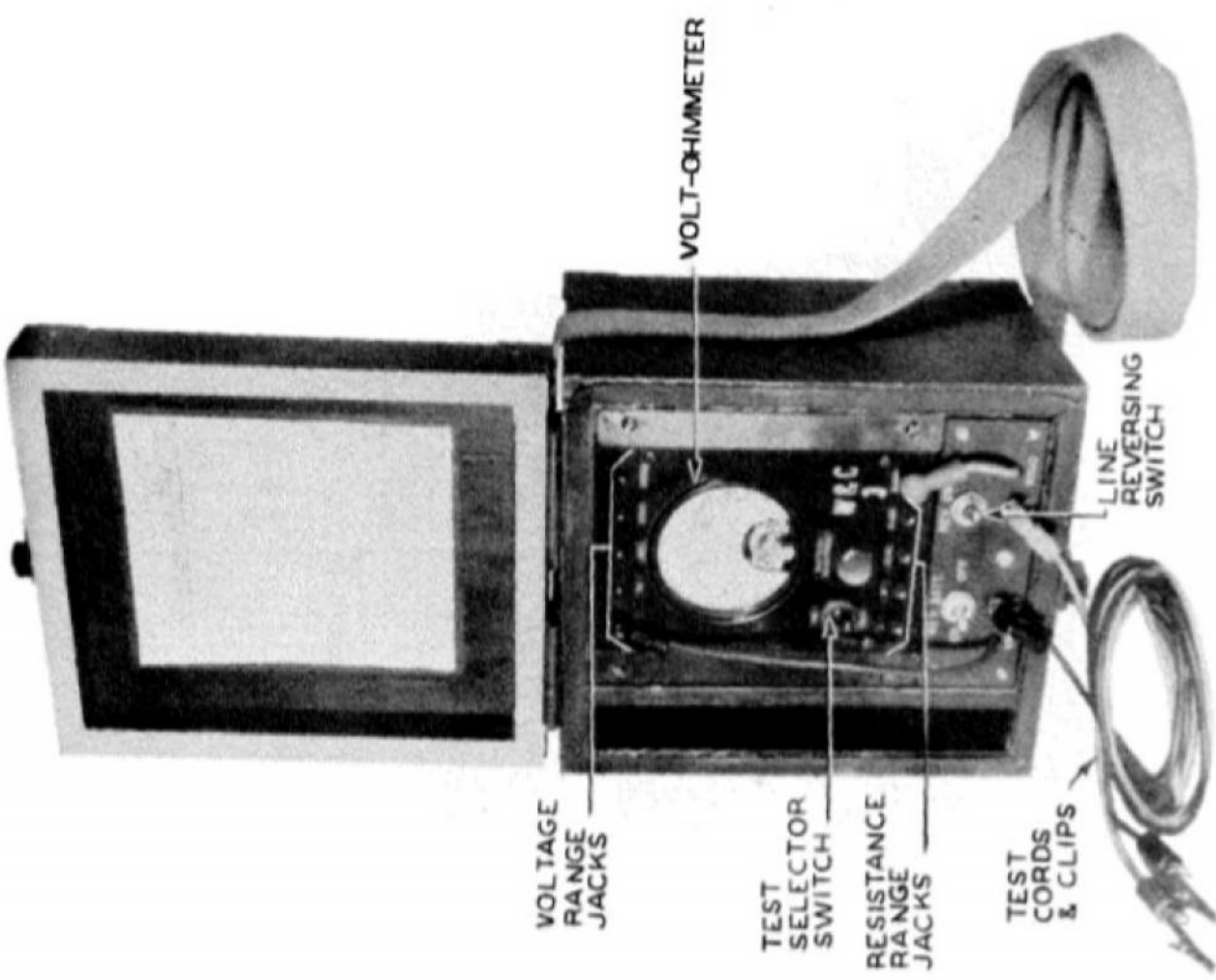

FIGURE 1312. Test Set TS-26/TSM

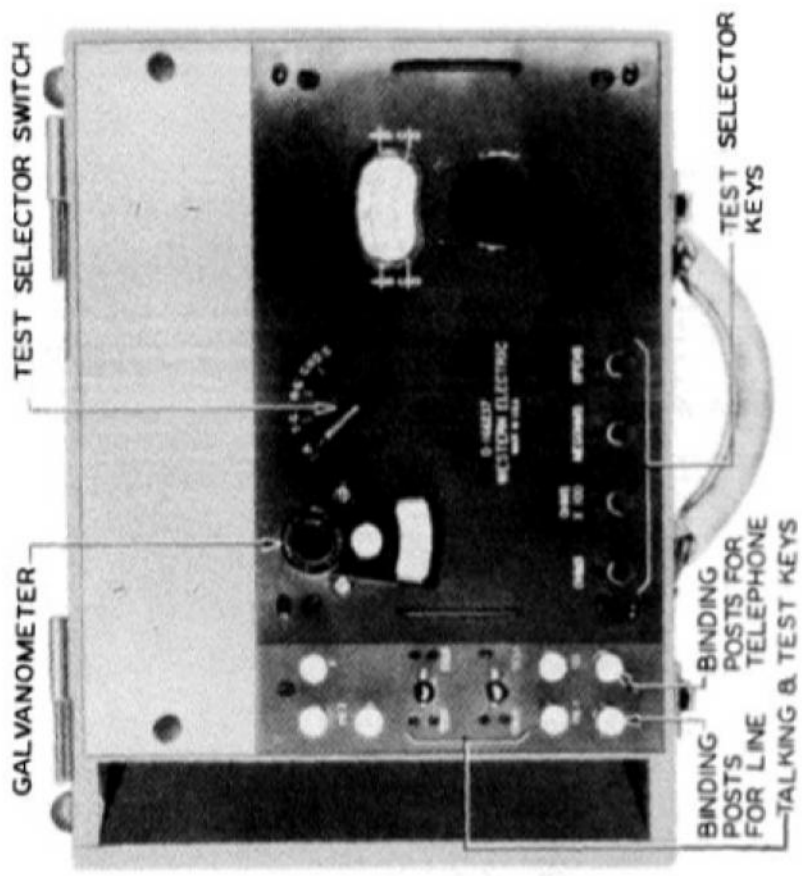

FIGURE 1313. Test Set TS-27/TSM

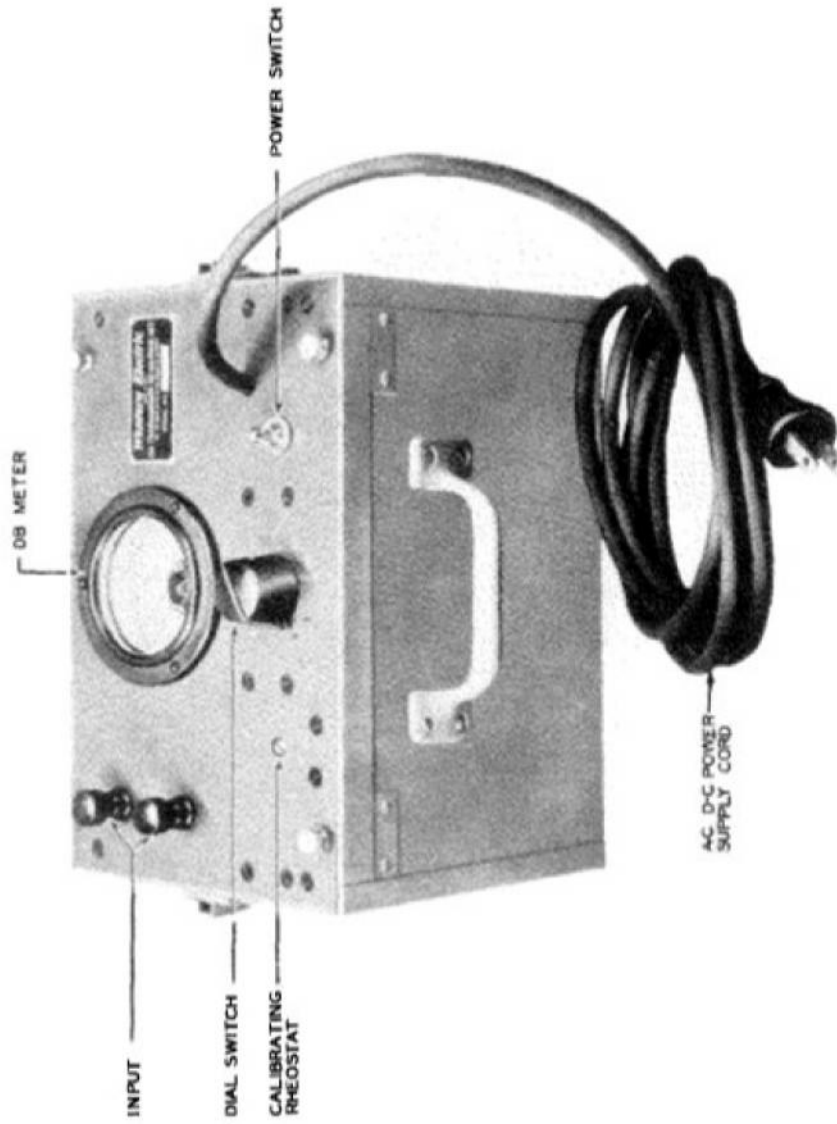

FIGURE 1315. Transmission Measuring Set
(Western Electric Co. 13A)

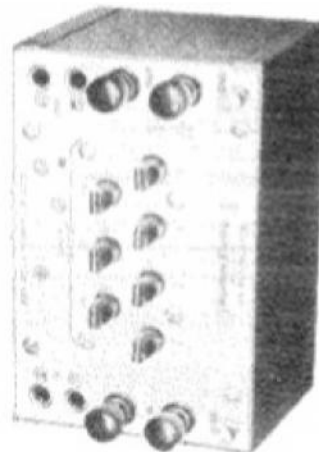

FIGURE 1314. Attenuator
(Western Electric Co. 5A)

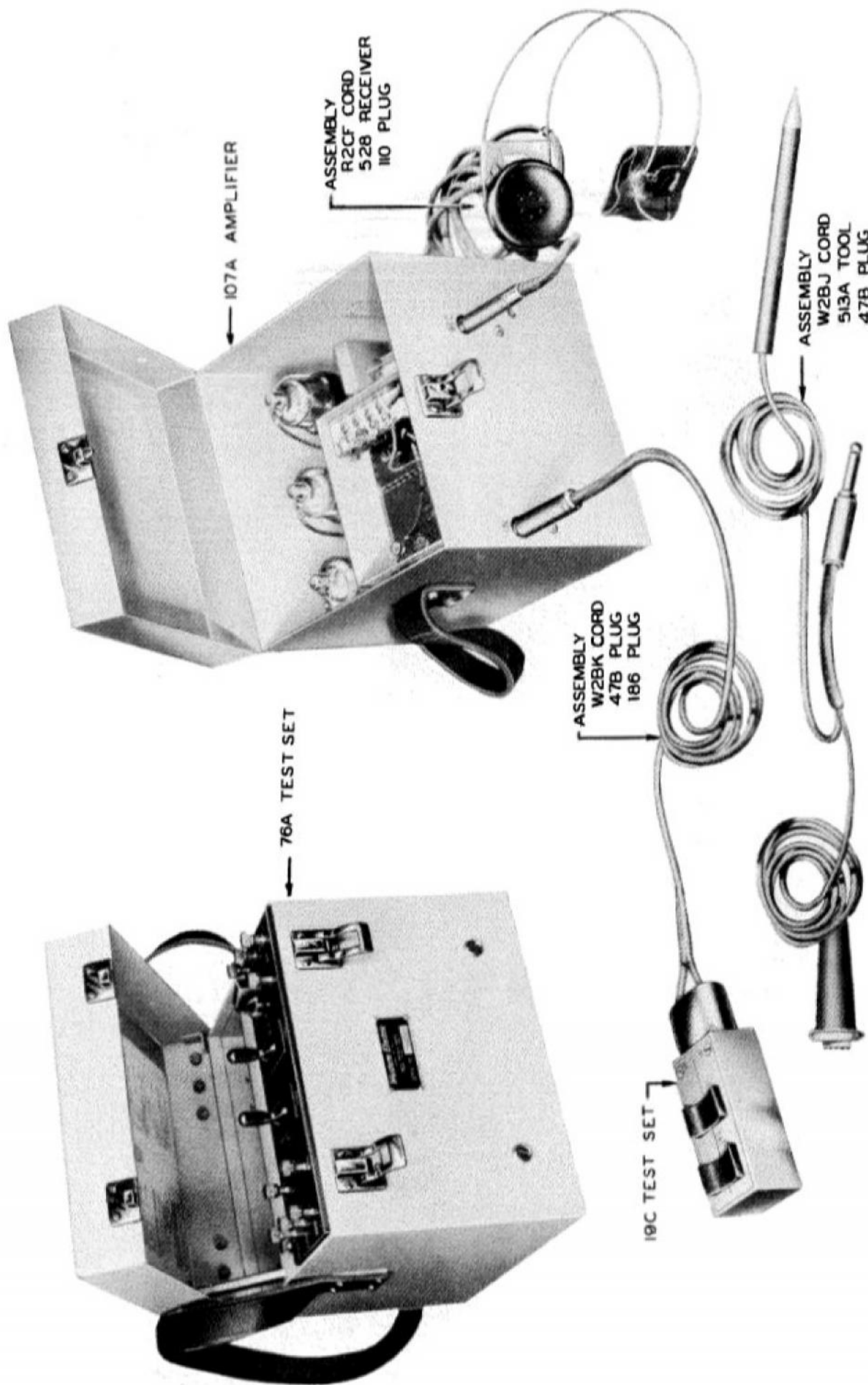

FIGURE 1316. Cable Fault Locating Equipment (Part of Tool Equipment TE-56-A)

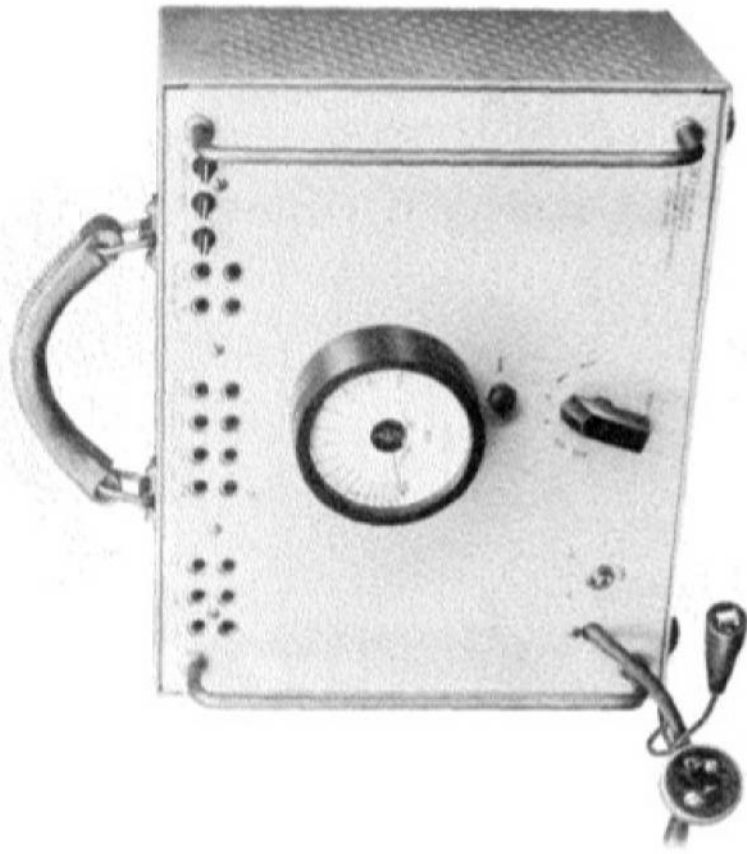

FIGURE 1318. Transmission Measuring Set
(Western Electric Co. 32A)

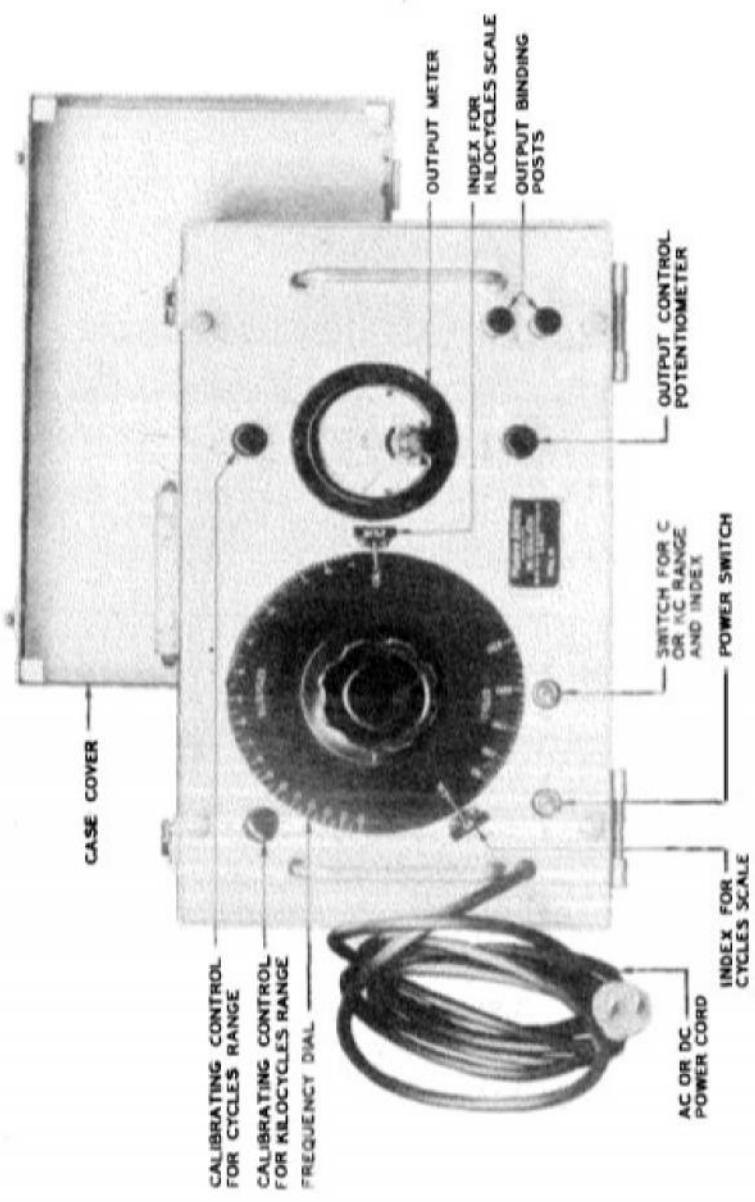

FIGURE 1317. Oscillator
(Western Electric Co. 19C)

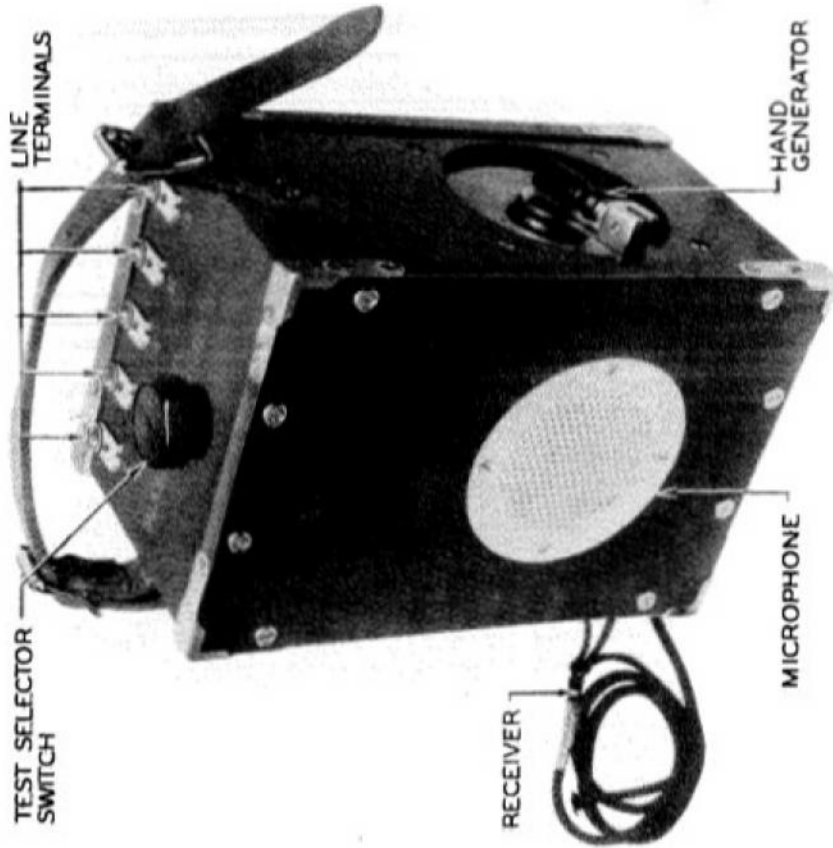

FIGURE 1320. Test Set
(Western Electric Co. 1017E)

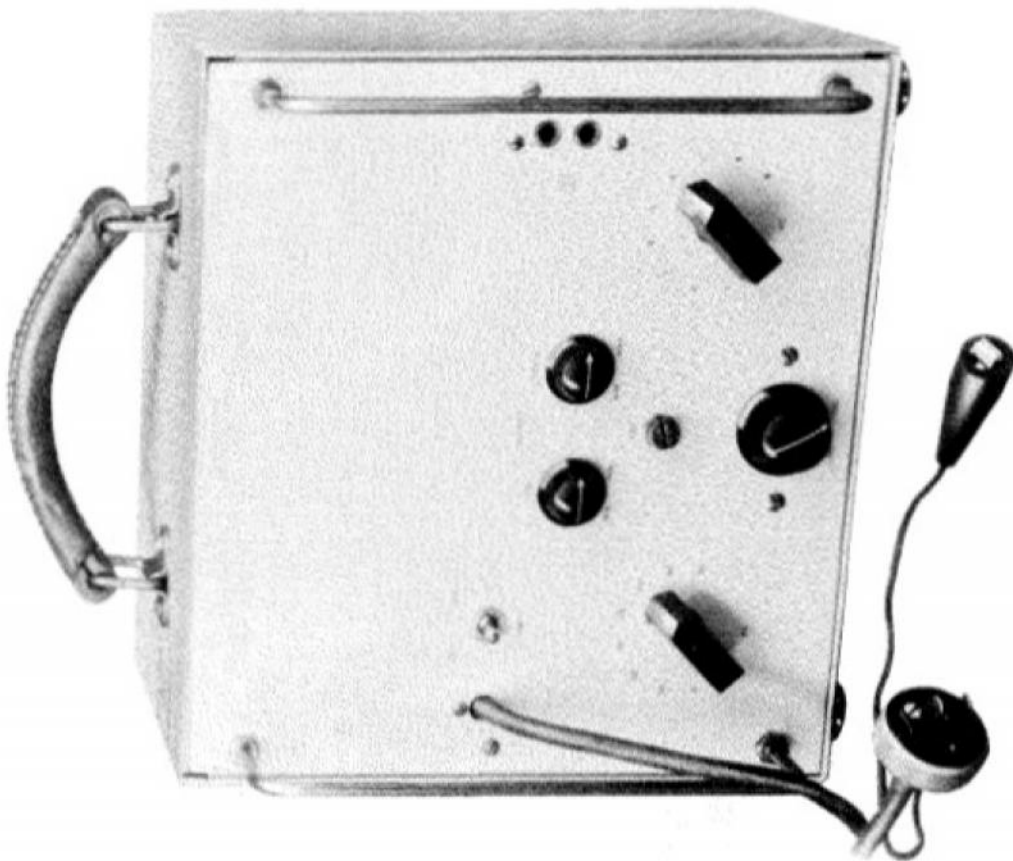

FIGURE 1319. Oscillator
(Western Electric Co. 51A)

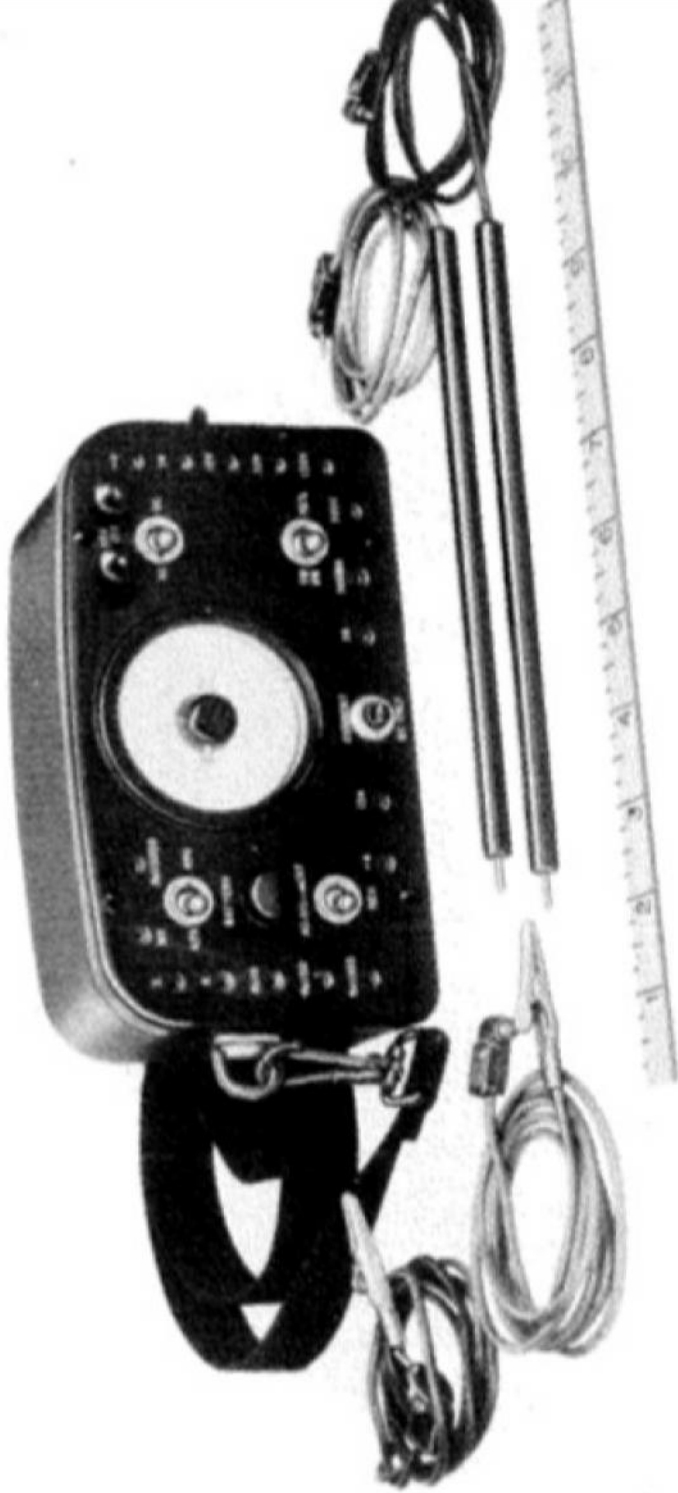

FIGURE 1322. Volt-Ohm-Milliammeter
(Western Electric Co. D-169370)

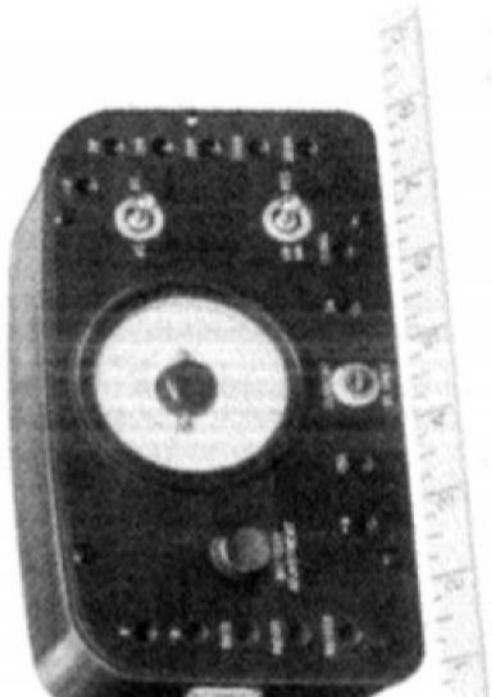

FIGURE 1321. Volt-Ohm-Milliammeter
(Western Electric Co. D-166852)
(Test leads not shown)

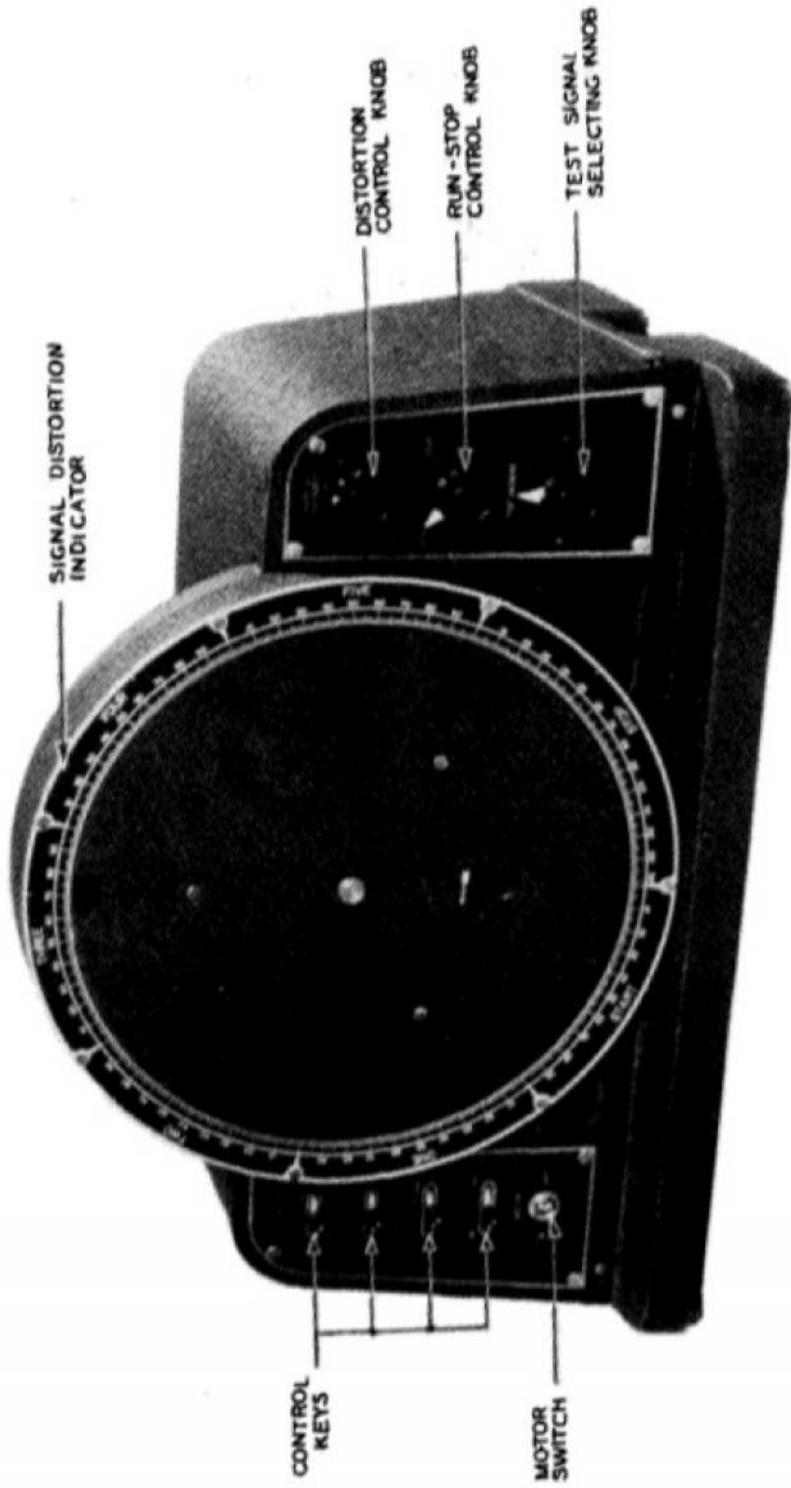

FIGURE 1323. Test Set (Teletype Corp. No. DXD-1)

1318. TEST SETS - STOCK NUMBERS AND LOGISTICAL DATA.

Nomenclature		Stock No.	Packed for Export	
Name	Type No.		Weight (lbs.)	Volume (Cu. Ft.)
Voltammeter	I-23	3F6023	3	0.2
Test Set	I-48-B	3F4048B	37	1.4
Test Set	I-49	3F4020 (formerly 3F4049)	22	0.7
Voltammeter	I-50	3F6050	3	0.2
Test Set	I-51	3F4051	40	1.2
Test Set	I-56-()	3F4056()	50	2.5
Test Set	I-61-A	3F4061A		
Test Set	I-61-B	3F4061B	60	1.5
Test Set	I-61-C	3F4061C		
Signal Generator	I-72-() 60 cyc.	3F3852().1	42	2.
Signal Generator	I-72-() 25 cyc.	3F3852().2	42	2.
Test Set	I-76	3F4076	36	1.4
Test Set	I-83-A	3F4083A	44	2.
Test Meter	I-87-()	3F4087()	17	1.
Field Strength Meter	I-95-()	3F2725()	18	1.1
Signal Generator	I-96-()	3F3896()		
Bias Meter	I-97-A	3F3397	5	0.3
Voltohmeter	I-107	3F7107	8	0.3
Frequency Meter Set	I-129-()	3F2729()	46	1.7
Signal Generator	I-130-A	3F3900-130A	40	1.6
Test Unit	I-135-()	3F4470-135()	36	1.5
Test Set	I-139-A	3F4139A	2	0.2
Analyzer	I-153-B	3F1715-153B	15	0.8
Voltohmeter	I-166	3F7166	14	0.5
Analyzer	I-167-()	3F1716()	17	1.
Tube Tester	I-171	3F4171	15	0.8
Test Unit	I-176	3F4470-176		
Tube Tester	I-177	3F5700-177	7	0.3
Test Set	I-181	3F4181	20	1.4
Test Set	I-193-A	3F4193A	95	4.5
Test Set	I-199	3F4190-199	48	2.2
Signal Generator	I-208	3F3900-208	124	5.5
Alignment Indicator	I-210	3F9-210	3	0.2
Test Unit	I-236-()	3F4470-236()	3	0.1
Analyzer	BC-1052-()	3F1710()	7	0.4
Test Set	KB-65	3F4065	40	1.5
Frequency Meter Set	SCR-211-()	2C1411.5	70	4.
Test Set	TS-2/TG	4TED57GC	160	12.
Test Set	TS-26/TSM	3F4325-26	22	0.7
Test Set	TS-27/TSM	3F4325-27	58	1.9
Test Oscillator	TS-32/TRC-1	3F4325-32	30	1.
Test Set	TS-190/U (W.E.Co. 67B)	3F4316.1	3	0.2
Test Set	Teletype DXD-1	4TDXD4/DTS	180	16.
Test Set	Teletype DXD-4	4TDXD4/DTS	180	16.
Tuning Fork	Teletype 103628	4FT103628	-	-
Tuning Fork	Teletype 104984	4FT104984	-	-
Attenuator	WECO 5A(SPL)	3F1775	10	0.3
Transmission Measuring Set	WECO 13A(SPL)	3F4270-2	25	1.2
Test Set	WECO 19C	3F4051/C1	7	0.2
Oscillator	WECO 19C(SPL)	3F3570-1	55	1.4
Transmission Measuring Set	WECO 32A(SPL)	3F4270-3	60	1.2
Oscillator	WECO 51A(SPL)	3F3570-2	60	1.2
Test Set	WECO 76A	3F4051C	35	0.8
Amplifier	WECO 108A	2C398	23	0.7
Test Set	WECO 1017E	3F4017E	18	0.6
Voltohmilliammeter	WECO D-166852	3F7127	6	1.5
Voltohmilliammeter	WECO D-169370	3F4072-13	6	1.5

Section VII
Cross Reference Data

1319. GENERAL.

a. This section is a cross reference of the ME's, TE's, IE's and Test Sets of sections III, IV, V and VI, tabulated according to the equipments to which they apply.

b. Equipments for which ME's, TE's, etc., are provided are listed in alphabetical order in par. 1320; opposite each equipment in the listing are tabulated the Maintenance Equipments, Tool Equipments, Test Equipments, and Test Sets, which specifically apply to that equipment. In addition par. 1320 lists general classes of equipment, such as "Teletypewriter Equipment - General", "Radio Sets - General", etc.; opposite

each general class are tabulated the ME's, TE's, etc., which are intended for maintenance of equipments in that general class and are not again indicated where the specific equipment is listed.

c. Par. 1320 is intended to serve as a key to indicate which ME's, TE's, etc. should be considered for use with any specific equipment, and as an aid in locating more detailed information in sections III, IV, V and VI. Several maintenance equipments or tool equipments, etc. may be listed as applicable to one type of equipment; not all may be required for a specific use of an equipment. The detailed information sections III, IV, V and VI must be referred to in order to determine the differences between items, such as the echelon of use, status (i.e. limited standard, replaced by, etc.) or the kinds of components.

1320. CROSS REFERENCE TABLE OF MAINTENANCE, TOOL AND TEST EQUIPMENTS, AND TEST SETS.

Equipment Type or Kind of Equipment	Reference to Detailed Information			
	Maintenance Equipments Par. 1308	Tool Equipments Par. 1311	Test Equipments Par. 1314	Test Sets Par. 1317
Amplifier Equipment AN/TRA-1	ME-11/TRA-1			
Cable - General		TE-16 and TE-55 and TE-56, or TE-73 (Fixed Plant)	IE-10 or IE-29	I-48 and I-49, and KE-65 or TS-26/TSM or W.E.Co. D-169370 Meter and TS-27/TSM, and BE-70 and I-51, or W.E.Co. 76A Test Set and W.E.Co. 108A Ampli- fier and W.E.Co. 1019C or 1119C Test Set
Conduit (Inside Wiring)		TE-70		
Converter CF-4-() (Carrier 2 Wire - 4 Wire)		TE-123	IE-53	TS-190/U, and I-166 or W.E.Co. D-166852 Meter or W.E.Co. D-169370 Meter, and TS-26/TSM or W.E.Co. D-169370 and TS-27/TSM
Converter Set TC-33-() (Carrier 2 Wire - 4 Wire)				
Earth Borer & Pole Setter (Model HD Earth Boring Machine) on Truck K-44-()	ME-14			
Filter Center TC-15	ME-24 and ME-25 and ME-26		IE-22 and IE-23	I-181 and W.E.Co. Patching and Power Cable Test Set ES-900092
Information Center SCS-5	ME-23 and ME-24 and ME-25 and ME-26		IE-22 and IE-23	I-181 and W.E.Co. Patching and Power Cable Test Set ES-900092
Line Unit BE-77	ME-7			I-97-A
Line Unit BE-77A & B	ME-7			
Operations Center AN/TTQ-1				TS-190/U and W.E.Co. D-166852 Meter

Equipment Type or Kind of Equipment	Reference to Detailed Information			
	Maintenance Equipments Par. 1308	Tool Equipments Par. 1311	Test Equipments Par. 1314	Test Sets Par. 1317
Operations Centers See also: Filter Center TC-15 Information Center SCS-5				
Packaged Equipment - General		W.E.Co. X-66086 or W.E.Co. X-66087 or W.E.Co. X-66088	See individual packaged equipments.	
Packaged Equipment See also: Repeater Package: Telegraph; Regenerative Repeater Package: Telephone; C Carrier Repeater Package: Telephone; VF Ringer Package: Voice Fre- quency; 2 Circuit and 4 Circuit Telegraph Carrier Package: Voice Frequency; 6 Channel Terminal Package: Telephone; C Carrier Terminal Package: Telephone; H Carrier				
Perforator, Model 14 (Commercial)	ME-83			
Perforator Set TO-11 Perforator portion	ME-83 or ME-93			
Perforator Set TO-13	ME-81			
Perforator Transmitter, Model 15 (Commercial)	ME-94			
Perforator Transmitter Set TO-23 Perforator portion	ME-83 or ME-93			
Transmitter-Distributor portion	ME-82 or ME-92			
Pole Derrick (IM) on Truck X-43-()	ME-15			
Radio Set SCR-293			I-87	
Radio Set SCR-294			I-87	
Radio Set SCR-299			BC-1052	
Radio Set SCR-300	ME-40 and ME-53 and ME-67		EE-65	
Radio Set SCR-399			BC-1052	
Radio Set SCR-499			BC-1052	
Radio Set SCR-508	ME-64			
Radio Set SCR-509	ME-13 or ME-73 and ME-34 and ME-59		I-107 or I-210	

Table continued on next page

CROSS REFERENCE TABLE OF MAINTENANCE, TOOL AND TEST EQUIPMENTS, AND TEST SETS.
(CONTINUED)

Equipment Type or Kind of Equipment	Reference to Detailed Information			
	Maintenance Equipments Par. 1308	Tool Equipments Par. 1311	Test Equipments Par. 1314	Test Sets Par. 1317
Radio Set SCR-510	ME-13 or ME-73, and ME-34 and ME-59			I-107 or I-210
Radio Set SCR-528	ME-64			
Radio Set SCR-536	ME-36		IE-17 or IE-75	I-135
Radio Set SCR-538	ME-64			
Radio Set SCR-608	ME-64			
Radio Set SCR-609	ME-13 or ME-73, and ME-34 and ME-59			I-107 or I-210
Radio Set SCR-610	ME-13 or ME-73, and ME-34 and ME-59			I-107 or I-210
Radio Set SCR-619	ME-13 or ME-73			I-107 or I-210
Radio Set SCR-624			IE-12 or IE-19 or IE-36	I-56 and I-95 and I-96 and I-130 and I-139
Radio Set SCR-628	ME-64			
Radio Set AN/TRC-1	ME-4/TRC-1			TS-32/TRC-1
Radio Set AN/TRC-3	ME-5/TRC-3			TS-32/TRC-1
Radio Set AN/TRC-4	ME-6/TRC-4			TS-32/TRC-1
Radio Set AN/TRC-7			IE-12	I-95
Radio Set AN/VRC-1			IE-12 or IE-19 or IE-36	I-56 and I-95 and I-130 and I-139
Radio Sets - General	ME-9 and ME-35	TE-41 and TE-48 or TE-113, and TE-46 or TE-114 and TE-45	IE-9 or IE-26	I-56 and I-72 and I-76 and I-83 or I-199 and I-129 and I-153 or I-166 or I-167 and I-176 and I-177 and I-208 and SCR-211-()
Radio Stations - Fixed Plant		TE-87		
Reel Unit RL-26-A With Lauson Engine Ray-843 With Lauson Engine Ray-885 With Briggs & Stratton Engine	ME-31-B ME-31-C ME-31-A or ME-65 or ME-66			

Equipment Type or Kind of Equipment	Maintenance Equipments Par. 1308	Reference to Detailed Information		
		Tool Equipments Par. 1311	Test Equipments Par. 1314	Test Sets Par. 1317
Relays - General (Adjusting)		TE-71 and TE-72 or TE-112	IE-22	I-181
Repeater TG-30 (terminal)	ME-111 or ME-112			
Repeater TG-31 (intermediate)	ME-113 or ME-114			
Repeater CF-3-() (Carrier)) Repeater Set TG-23-() (Carrier))	ME-76	TE-123 or TE-124	IE-53	TS-190/U and I-166 or W.E.Co. D-166852 Meter or W.E.Co. D-169370 Meter, and TS-26/TSM or W.E.Co. D-169370 Meter and TS-27/TSM
Repeater CF-5-() (Carrier -) 2 Wire)) Repeater Set TG-37-()) (Carrier - 2 Wire))		TE-123	IE-53	TS-190/U and I-166 or W.E.Co. D-166852 Meter or W.E.Co. D-169370 Meter, and TS-26/TSM or W.E.Co. D-169370 Meter and TS-27/TSM
Repeater Package: Telegraph; Regenerative		See Pkg. Eqpt. Gen.	W.E.Co. X-66031B	TS-2/TG
Repeater Package: Telephone; C Carrier		See Pkg. Eqpt. Gen.	W.E.Co. X-61819T	I-171 or I-177 and I-181 and W.E.Co. 32A Trans. Meas. Set and W.E.Co. 51A Oscillator and W.E.Co. 5A Attenuator and W.E.Co. 13A Trans. Meas. Set and W.E.Co. 19C Oscillator and TS-190/U and W.E.Co. D-166852 Meter or W.E.Co. D-169370 Meter
Repeater Package: Telephone; VF		See Pkg. Eqpt. Gen.	W.E.Co. X-61821L	I-171 or I-177 and I-181 and W.E.Co. 5A Attenuator and W.E.Co. 13A Trans. Meas. Set and W.E.Co. 19C Oscil- lator and TS-190/U and W.E.Co. D-166852 Meter or W.E.Co. D-169370 Meter
Reperforator, Model 14 (Commercial) Perforator portion	ME-83 or ME-93			
Reperforator portion	ME-69 or ME-89			
Reperforator, Model 14X (Commercial)	ME-81 or ME-91			
Reperforator Transmitter Set TG-25 Reperforator portion	ME-81 or ME-91			
Transmitter - Distributor portion	ME-82 or ME-92			

Table continued on next page

GROSS REFERENCE TABLE OF MAINTENANCE, TOOL AND TEST EQUIPMENTS, AND TEST SETS
(CONTINUED)

Equipment Type or Kind of Equipment	Reference to Detailed Information			
	Maintenance Equipments Par. 1308	Tool Equipments Par. 1311	Test Equipments Par. 1314	Test Sets Par. 1317
Reperforator Transmitter Set TG-26-() Reperforator portion	ME-69 or ME-89			
Transmitter - Distribution portion	ME-82 or ME-92			
Reperforator Transmitter Set TG-27-() Reperforator portion	ME-89			
Ringer Package: Voice Frequency; 2 Circuit and 4 Circuit		See Pkg. Eqpt. Con.	W.E.Co. X-61821L	I-181 and W.E.Co. D-166852 Meter or W.E.Co. D-169370 Meter
Ringing Equipment KE-100-()) (Voice Frequency)) Ringing Equipment KE-101-()) (Voice Frequency)) Ringer Set TC-24-() (Double) Circuit))	ME-77	TE-123 or TE-124	IE-53	I-166 or W.E.Co. D-169370 Meter or W.E. Co. D-166852 Meter and TS-190/U
Spiral Four - 100 mile Carrier System	ME-87 and ME-88	TE-123 or TE-124	IE-53	TS-190/U and I-166 or W.E.Co. D-166852 Meter or W.E.Co. D-169370 Meter, and TS-26/TSM or W.E.Co. D-169370 and TS-27/TSM
Spiral Four Equipment - See also: Telephone Terminal CF-1-() Telephone Terminal Set TC-21 Telegraph Terminal CF-2-() Telegraph Terminal Set TC-22 Repeater CF-3-() Repeater Set TC-23 Repeater CF-5-() Repeater Set TC-37 Converter CF-4-() Converter Set TC-33				
Switchboard HD-71	ME-39			
Switchboard HD-72	ME-39			
Switchboard HD-80 (TC-1)	ME-4 or ME-71	TE-44		TS-26/TSM or W.E.Co. D-169370 Meter
Switchboard HD-89-A (TC-2)	ME-6 or ME-72	TE-44		TS-26/TSM or W.E.Co. D-169370 Meter
Switchboard HD-91 (TC-12)	ME-30 or ME-39			
Switchboard HD-96 (TC-4)	ME-11 or ME-39			
Switchboard HD-110 (TC-10)	ME-4 or ME-71	TE-44		TS-26/TSM or W.E.Co. D-169370 Meter
Switchboard HD-120 (TC-20)	ME-63	TE-44		TS-26/TSM or W.E.Co. D-169370 Meter

Equipment Type or Kind of Equipment	Reference to Detailed Information			
	Maintenance Equipments Par. 1308	Tool Equipments Par. 1311	Test Equipments Par. 1314	Test Sets Par. 1317
Switchboard - 200 line (W.E.Co. #550-C PBX)	ME-58			
Switchboard - 1000 line (W.E.Co. #701 PBX)	ME-60			
Telegraph Carrier Package: VF; 6 Channel		See Pkg. Eqpt. Gen.	W.E.Co. X-61822C	I-193-A
Telegraph Equipment - General See also: (Teletypewriter Equipment - General Wire Equipment - General)	ME-10 and ME-38	TE-47 or TE-111 and TE-112, and TE-49 or TE-73 (Fixed Plt.) and TE-69 (Fixed Plt.) or TE-79	IE-10 or IE-29	I-23 and I-50 or I-166 or W.E.Co. D-166852 Meter or W.E.Co. D-169370 Meter, and I-181, and I-193-A, and TS-2/TG, and Teletype DXD-1 Test Set or Teletype DXD-4 Test Set
Telegraph Terminal CF-2-() (Carrier)	ME-75	TE-123 or TE-124	IE-53	TS-190/U and I-166 or W.E.Co. D-166852 Meter or W.E.Co. D-169370 Meter, and TS-26/TSM or W.E.Co. D-169370 Meter, and TS-27/TSM
Telegraph Terminal Set TC-22-() (Carrier)				
Telephone KE-8-()	ME-22			
Telephone Central Office Set (Aux.) TC-5		TE-44		TS-26/TSM or W.E.Co. D-169370 Meter
Telephone Central Office Set TC-1 - See Switchboard BD-80				
Telephone Central Office Set TC-2 - See Switchboard BD-89-A				
Telephone Central Office Set TC-4 - See Switchboard BD-96				
Telephone Central Office Set TC-10 - See Switchboard BD-110				
Telephone Central Office Set TC-12 - See Switchboard BD-91				
Telephone Central Office Set TC-20 - See Switchboard BD-120				
Telephone Equipment - General See also: Wire Equipment - General	ME-10 and ME-38	TE-47 or TE-111 and TE-112, and TE-49 or TE-73 (Fixed Plt.) and TE-69 (Fixed Plt.) or TE-79 (Fixed Plt.)	IE-10 or IE-29	I-23 and I-50 and I-61 and I-166 or W.E.Co. D-166852 Meter or W.E.Co. D-169370 Meter and I-177
Telephone Terminal CF-1-() (Carrier)	ME-74	TE-123 or TE-124	IE-53	TS-190/U and I-166 or W.E.Co. D-166852 Meter or W.E.Co. D-169370 Meter, and TS-26/TSM or W.E.Co. D-169370 Meter and TS-27/TSM
Telephone Terminal Set TC-21-() (Carrier)				

Table continued on next page

CROSS REFERENCE TABLE OF MAINTENANCE, TOOL AND TEST EQUIPMENTS, AND TEST SETS.
 (CONTINUED)

Equipment Type or Kind of Equipment	Reference to Detailed Information			
	Maintenance Equipments Par. 1308	Tool Equipments Par. 1311	Test Equipments Par. 1314	Test Sets Par. 1317
Teletypewriter Equipment - General See also: Telegraph Equipment - General Wire Equipment - General	ME-10 and ME-37 and ME-86	TE-50		I-97 and I-193 and I-236 or ES-2/TG and Teletype DID-1 Test Set or Teletype DID-4 Test Set, and Teletype 103628 and 104984 Tuning Forks
Teletypewriter, Model 15 (Commercial)	ME-7 or ME-80 and ME-18 or ME-90			
Teletypewriter, Model 19 (Commercial) or TG-19 Performer portion	ME-84 or ME-90 and ME-94			
Teletypewriter portion Model 15 or TG-7	ME-80			
Transmitter - Distributor portion	ME-82 or ME-92			
Teletypewriter TG-7	ME-7 or ME-80 and ME-18 or ME-90			
Terminal Package: Telephone; C Carrier		See Pkg. Eqpt. Gen.	W.E.Co. X-61819T and W.E.Co. X-61821L	I-171 and I-181 and W.E.Co. 32A Trans. Meas. Set and W.E.Co. 51A Oscillator and W.E.Co. 5A Attenuator and W.E.Co. 13A Trans. Meas. Set and W.E.Co. 19C Oscillator and TS-190/U and W.E.Co. D-166852 Meter or W.E.Co. D-169370 Meter
Terminal Package: Telephone; H Carrier		See Pkg. Eqpt.Gen.	W.E.Co. X-61821L	W.E.Co. 19C Oscillator and W.E.Co. 13A Trans. Meas. Set and W.E.Co. 5A Attenuator and W.E. Co. D-166852 Meter and I-181 and TS-190/U and I-171 or I-177.
Transmitter - Distributor Model 14 (Commercial)	ME-82 or ME-92			
Winch L-18 on Trucks K-43-() and K-44-()	ME-16			
Wire Equipment (Signal ground wire equipment) - General See also: Cable - General Telegraph Equipment - General Telephone Equipment - General Teletypewriter Equipment - General	ME-10 and ME-38	TE-5 or TE-29, and TE-86, and TE-53, and TE-36, and TE-47 or TE-111 and TE-112 and TE-49 and TE-51	IE-10 or IE-29	I-23 and I-50 or I-166 or W.E.Co. D-166852 Meter or W.E.Co. D-169370 Meter or TS-26/TM and I-61 and I-177 and I-181 and TS-27/TM

CHAPTER 14
RADIO EQUIPMENT

Section I
General

1401. INTRODUCTION.

a. This chapter provides descriptive, technical and logistical information pertaining to radio equipment for ground communication use. The information is given in the form of tables supplemented by photographs and sketches of radio sets and equipment.

b. This chapter covers only equipment which is used for ground to ground communication. It does not include such apparatus as direction finding, range, marker and radar equipment.

c. Section II covers the radio sets for ground use which are classified as tactical radio sets. These sets operate mainly in the HF (3.0 to 30 Mc) and VHF (30 to 300 Mc) ranges. However, some of them are capable of operating in the MF (.3 to 3.0 Mc) range. Information concerning remote control equipment which may be employed with these radio sets is included.

d. Section III gives information on fixed plant transmitting and receiving radio equipment used by the Army Communications Service. This includes Command communications and Airways communications facilities. This radio equipment is usually employed in long haul administrative and special service traffic. It is used mostly for telegraph or teletypewriter service and operates in the LF (.03 to .3 Mc), MF (.3 to 3.0 Mc), HF (3.0 to 30 Mc) and VHF (30 to 300 Mc) ranges.

e. Section IV gives information on antennas and associated equipment for both tactical and fixed plant radio sets.

f. An example of the use of information given in this chapter in planning a communication system involving radio links is given in Chapter 2.

1402. PHOTOGRAPHS.

a. This chapter includes photographs of practically all of the radio sets, radio transmitters and radio receivers which are listed in the tables. It also includes photographs of remote control and other miscellaneous equipment as well as sketches which illustrate the antenna types referred to in the descriptive tables.

b. In many cases, the photographs of radio sets or equipment show the radio components only, i.e. a radio transmitter, a radio receiver, or both. Rarely do they show all of the accessory components.

Section II
Tactical Radio Sets for Ground Use

1403. GENERAL.

a. Information given in this section is confined to tactical radio sets for ground use. No airborne sets are included, although a number of the sets listed are capable of communicating with aircraft radios. A few sets classified as "obsolete" are included, since they are encountered occasionally in the field.

b. Data are also given on remote control equipment which provides talking and listening facilities as well as send-receive control at a point remote from the radio set.

1404. RADIO SETS - DESCRIPTION.

a. Paragraph 1408 lists tactical radio sets for ground use in numerical sequence and gives descriptive information and technical data for each set. The information includes such items as frequency range, type of modulation, type of antenna, rated transmitter output power, power supply requirements, etc.

b. A list is given of the sets with which each radio set can communicate, excluding obsolete sets. Similar information including obsolete sets may be obtained from the chart in paragraph 1409.

c. Data are also given covering the types of emission and the corresponding military characteristic distance ranges of the sets. These are the distance ranges which were specified when the military characteristics of the sets were established and are ground wave ranges. The ground wave ranges obtained in field use may depart considerably from those shown, being greater or less depending on such factors as type and siting of the antenna, nature of the terrain, prevalence of noise, condition of set, etc. Under jungle conditions the ground wave range will usually be considerably reduced and it may be necessary to resort to sky wave transmission. Under suitable conditions sky wave transmission may provide communication over considerably greater distances.

d. In the column which indicates the type of antenna furnished with the radio set, reference is made to figures of representative antenna types. These sketches are merely illustrative and do not necessarily represent a particular Signal Corps antenna.

e. Maintenance equipment for electrical servicing is not furnished as a part of the radio set unless so indicated. For

many of these sets, the listed electrical instruments are those referred to in the respective technical manuals. They are listed as a guide to the type of equipment which should be available to any organization responsible for the maintenance of these sets. Some, but not all, of the larger radio sets include the listed electrical testing equipment for use in line-up and maintenance by the using organization. Information on maintenance equipment and test sets will be found in chapter 13.

1405. FREQUENCY RANGE CHARTS. The charts in paragraph 1409 illustrate graphically the frequency coverage of the transmitter and receiver of the tactical radio sets and are useful in rapidly identifying the various sets which operate in a given frequency range. One chart covers amplitude modulated sets and the other covers frequency modulated sets.

1406. RADIO SETS - STOCK NUMBERS AND LOGISTICAL DATA. Paragraphs 1410 to 1414, inclusive, give data such as stock number, weights and volume, etc., for the tactical radio sets for ground use. For this purpose the sets are divided into the following five categories: ground, transportable; vehicular; pack; air transportable; and ground, mobile.

1407. REMOTE CONTROL EQUIPMENT

a. Remote control equipment for use with certain tactical radio sets is described in paragraph 1415. Information on major components, range of operation, power input requirements, etc., is given.

b. Many of the radio sets are furnished with remote control equipment. For others, universal remote control equipment which will operate with a number of different types of radio sets is available but must be ordered separately. Some arrangements require a remote control unit at both ends of the associated wire line while others require only a telephone set at the remote point and a control unit at the radio set.

c. Various types of remote control equipment differ in the number of features provided. All use either dry cell batteries or power obtained from the a-c source which supplies the radio set, and in some cases, both.

d. Some kinds of remote control equipment provide only intercommunication between attendants, with the attendant at the radio set doing the necessary switching from receiving to transmitting and vice versa, while others, in addition, provide voice, CW and tone operation of the radio set from the remote point. Some units also control the power equipment associated with the radio set.

e. For most remote control equipment only one pair of wires is required. However, some equipment requires two pairs and some use the phantom circuit derived from two pairs to provide a third communication channel. Some types of remote control equipment must be located within a few feet of the radio set, while others can be located from a short distance to several miles away.

f. Paragraph 1416 gives stock numbers, weights and volumes for remote control equipment.

See following page
for paragraph 1408

1408. RADIO SETS FOR GROUND USE - TACTICAL - DESCRIPTIVE AND TECHNICAL DATA.

Type	Major Radio Components	Frequency Range-Mc	Type Mod.	Bandwidth & Military Char. Range in Miles ^a	Rated Trans. Power Output- Watts	Freq. Control ^b	Protect Channels	Communicates With ^c	Type Antenna ^d
SCR-151 Fig. No. 1401	Receiver and Transmitter BC-148	3.96-4.36	AM	CW-5 mi.	5	M.O.	None	SCR-151 (See Par. 1409)	Loop IP-7
SCR-161 Fig.No. 1401	Receiver and Transmitter BC-151	4.37-5.1	AM	CW-5 mi.	5	M.O.	None	SCR-161 (See Par. 1409)	Loop IP-7
SCR-171 Fig.No. 1402	Receiver and Transmitter BC-156	2.64-3.04	AM	CW-15 mi.	5	M.O.	None	SCR-171 (See Par. 1409)	60-Ft. Inv. L with Ctpse. CP-11 (Fig. 1458)
SCR-177-A Fig.No. 1405	Transmitter BC-191-A Tuning Unit TU-5-A TU-5-A TU-6-A Ant.Tun.Unit BC-306-A Receiver BC-189-A Coil Set C-144-A C-145-A C-147-A C-148-A	0.4-0.8 1.5-5.0 3.0-4.5 0.4-0.8	AM	CW-100 mi. Tone-70 Voice-50	75	M.O.	None	SCR-177,188,195, 197,205,209,210, 245,284,288,299, 399,499,506,511, 536,545,595,694, AM/TBC-2, AM/VBC-1	Crowfoot (0.4-0.8 Mc); 1/4 Wave Inv. L with Ctpse. (1.5-4.5 Mc.) Figs. 1459 & 1458
SCR-177-B Fig.No. 1404	Transmitter BC-191-C Tuning Unit TU-5-A TU-5-A TU-6-A Ant.Tun.Unit BC-306-A Receiver BC-314-C BC-312-C	0.4-0.8 1.5-5.0 3.0-4.5 0.4-0.8 0.15-1.5 1.5-18.0	AM	CW-100 mi. Tone-70 Voice-50	75	M.O.	None	SCR-177,188,195, 197,205,209,210, 245,284,288,299, 399,499,506,511, 536,545,595,694, AM/TBC-2, AM/VBC-1	Crowfoot (0.4-0.8 Mc); 1/4 Wave Inv. L with Ctpse. (1.5-4.5 Mc.) (Figs. 1459 & 1458)
SCR-178 Fig.No. 1405	Transmitter BC-187 Modulator BC-188 Receiver BC-186	2.4-3.7	AM	Pt.-to-Pt. CW-25 mi. Tone-20 Voice-10 Grd.-to-Plane CW-100 mi. Tone-75 Voice-50	5 2 3 Tone Tone-75 Voice-50	M.O.	None	SCR-178, 179 (See Par.1409)	25-Ft. Whip (NS-49 to 56 incl.) and Ctpse. CP-12 & CP-13 (Fig. 1460)
SCR-179 Fig.No. 1405	Transmitter BC-187 Modulator BC-188 Receiver BC-186	2.4-3.7	AM	Pt.-to-Pt. CW-25 mi. Tone-20 Voice-10 Grd.-to-Plane CW-100 mi. Tone-75 Voice-50	5 2 3 Tone Tone-75 Voice-50	M.O.	None	SCR-178, 179 (See Par.1409)	25-Ft. Whip (NS-49 to 56 incl.) and Ctpse. (CP-12 & CP-13) (Fig. 1460)

^aThis is the military characteristic distance range, see paragraph 1404.

^bM.O. is used to indicate Master Oscillator control and Ital to indicate crystal control.

^cSets with which it is possible to establish communication by virtue of overlap in operating frequency ranges. Communication may also be established with airborne radio sets which operate in the same frequency range. Obsolete sets not covered, see paragraph 1409 for their frequency overlap.

^dAntenna is part of set. Figure numbers refer to sketches of representative antennas.

^ePower supply units are normally furnished as a part of the radio set unless stated otherwise. The recently adopted policy of shipping equipment "less batteries" requires that dry batteries, in general, be requisitioned separately. Storage batteries, except vehicular, are supplied with the set.

Power Supply ^a	Power Input Requirements	Maintenance Equipment ^b	Weight In Use (lbs.)	TM or Inst. Book ^b	Remarks
Instr - Hand Gen. GN-35 Rec. - 3 Bat. BA-25 2 Bat. BA-2	Instr - 12.5W. 10V.DC 10W. 400V.DC Rec. - 0.75A at 4.5V.DC 10 Ma. at 90V. DC	AC Vacuum Tube Volt- meter	76.5	TM 11-257	OBSOLETE - Pack; loop, telegraph set using a regenerative receiver and Hartley oscillator transmitter. Can be carried by two men. Replaced by SCR-284. Used by Sig.C, INF, AF.
Instr - Hand Gen. GN-35 Rec. - 3 Bat. BA-25 2 Bat. BA-2	Instr - 12.5W. 10V.DC 10W. 400V.DC Rec. - 0.75A at 4.5V.DC 10 Ma. at 90V.DC	AC Vacuum Tube Volt- meter	76.5	TM 11-257	OBSOLETE - Pack; loop telegraph set using a regenerative receiver and Hartley oscillator transmitter. Can be carried by two men. Replaced by SCR-284. Used by FA.
Instr - Hand Gen. GN-35 Rec. - 3 Bat. BA-25 2 Bat. BA-2	Instr - 12.5W. 10V.DC 10W. 400V.DC Rec. - 0.75A at 4.5V.DC 10 Ma. at 90V.DC	AC Vacuum Tube Volt- meter	179	TR-1210-51	OBSOLETE - Ground, transportable; intended for command communication use between Division Headquarters and Brigades and Regiments. Transported by vehicle. Replaced by SCR-284. Used by Sig.C, INF, FA, AAF
Power Unit PE-49 Dyn. Unit HD-69 2 Stor. Bat. EB-50 (Incl. 1 spare)	Instr - (From PE-49) 365W. at 14.4V.DC 350W. at 1000V.DC Rec. - 5A. at 14V. DC	Freq. Meter SCR-211, Sig.Gen.I-72, Test Set I-56, Output Meter, Dummy Antenna, O-1A RF Ammeter	850	TM 11-252 TM 11-800 (Instr)	Ground, transportable; used between tactical field units. Carried in vehicle or cargo aircraft. Limited Standard. Replaced by SCR-177-B. Used by Sig.C, CAC, TD.
Power Unit PE-49-C 2 Stor. Bat. EB-46 (Incl. 1 spare)	Instr - (From PE-49) 365W. at 14.4V.DC 350W. at 1000V.DC Rec. - (Ma.) 4.2A. at 12V. DC	Freq. Meter SCR-211, Sig.Gen.I-72, Test Set I-56, Output Meter, Dummy Antenna, O-1A RF Ammeter	1000	TM 11-252 TM 11-800 (Instr) TM 11-850 (Rec.)	Ground, transportable; used between tactical field units and as ground set in ground-to-plane communication. Two receivers. Transported by vehicle or cargo aircraft. Used by Sig.C, AAF, CAC, TD.
Instr - Hand Gen. GN-37 Mod. - 2 Bat. BA-25 1 Bat. BA-27 Rec. - 4 Bat. BA-2 2 Bat. BA-25 1 Bat. BA-27	Instr - 25W. 8V. DC 50W. 500V.DC 5V. & 4.5V.DC Rec. - 0.25A. at 3V.DC 7 Ma. at 90V.DC		225 (Packed for Trans- porta- tion)	TM 11-251	OBSOLETE - Ground, transportable; intended for point-to-point and ground-to-plane communication between artillery units and aircraft for observation purposes. Replaced by SCR-608, SCR-609, SCR-610 and SCR-628. Used by Sig.C, AAF, FA.
Instr - Hand Gen. GN-37 Mod. - 2 Bat. BA-25 1 Bat. BA-27 Rec. - 4 Bat. BA-2 2 Bat. BA-25 1 Bat. BA-27	Instr - 25W. 8V.DC 50W. 500V.DC 5V. & 4.5V.DC Rec. - 0.25A. at 3V.DC 7 Ma. at 90V.DC		225 (Packed for Trans- porta- tion)	TM 11-251	OBSOLETE - Pack; same as SCR-176 except carrying cases have pack saddle hangers for transportation by pack animal. Replaced by SCR-608, SCR-609, SCR-610 and SCR-628. Used by FA.

^aMaintenance equipment is not furnished as a part of the radio set unless so indicated. Listed here are electrical instruments which may be required to provide normal servicing of the sets.

^bThe first TM listed for each radio set covers the complete set; subsequent TM's cover components of that set. All are normally supplied with the radio set.

Table continued on next page

RADIO SETS FOR GROUND USE - TACTICAL - DESCRIPTIVE AND TECHNICAL DATA. (Continued)

Type	Major Radio Components	Frequency Range-Mc	Emission Type Char. Mod. In Miles ^a	Rated Trans. Power Output-Watts	Freq. Control ^b	Preset Channels	Communicates With ^c	Type Antenna ^d
SCR-188 Fig.No. 1406	Transmitter BC-AA-191 Tuning Unit TU-AA-5 TU-AA-6 TU-AA-7 TU-AA-8 TU-AA-9 TU-AA-10 Ant. Tun. Unit BC-AA-194 Receiver BC-189-A Coil Set C-144-A C-145-A C-146-A C-147-A C-148-A C-149-A C-150-A C-151-A C-152-A	1.5-3.0 3.0-4.5 4.5-6.2 6.2-7.7 7.7-10.0 10.0-12.5 0.8-12.5	AM CW-100 mi. Tone-70 Voice-30	75	M.O.	None	SCR-177,188,193, 197,203,209,210, 245,284,288,299, 399,499,506,511, 536,543,593,694, AM/TRC-2, AM/VRC-1	1/4 or 3/4 Wave Inv. L Ant. with Ctpse. (Fig. 1458)
SCR-188-A Fig.No. 1407	Transmitter BC-191-C Tuning Unit TU-5-A TU-6-A TU-7-A TU-8-A TU-9-A TU-10-A Receiver BC-342-C Control Unit RM-12 RM-13	1.5-3.0 3.0-4.5 4.5-6.2 6.2-7.7 7.7-10.0 10.0-12.5 1.5-18.0	AM CW-100 mi. Tone-70 Voice-30	75 (Less at freq. above 8 Mc.)	M.O.	None	SCR-177,188,193, 197,203,209,210, 245,284,288,299, 399,499,506,511, 536,543,593,694, AM/TRC-2, AM/VRC-1	1/4- or 3/4-Wave Inv. L Ant. with Ctpse. (Fig. 1458)
SCR-193-() Fig.No. 1408	Transmitter BC-191 Tuning Unit TU-5-A TU-6-A Receiver BC-312	1.5-3.0 3.0-4.5 1.5-18.0	AM Stationary- CW-60 mi. Tone-40 Voice-20 Moving - CW-30 mi. Tone-20 Voice-15	75	M.O.	None	SCR-177,188,193, 197,203,209,210, 245,284,288,299, 399,499,506,511, 536,543,593,694, AM/TRC-2, AM/VRC-1	15-Ft. Whip (MS-49 to 53 incl.), or 22-1/2 Ft. Wire AM-24 in semi-fixed loc. (Fig. 1461b)
SCR-194 Fig.No. 1409	Receiver and Transmitter BC-222	27.7-52.2	AM Voice - 5 mi.	0.5	M.O. (Ital Cal- ibrated)	None	SCR-194	13-Ft. Telescoping Whip AM-29-B (Fig. 1461a) and Vert. Half-Rhombic RC-63 (Ordered separ- ately) (Fig. 1469)
SCR-195 Fig.No. 1410	Receiver and Transmitter BC-322	52.8-65.8	AM Voice - 5 mi.	0.5	M.O. (Ital Cal- ibrated)	None	SCR-195	6-Ft. Whip (MS-50&51) or 9-Ft. Telescoping Whip AM-30-B (Fig. 1461a) and Vert. Half- Rhombic RC-63 (Ordered separately) (Fig. 1469)

^aThis is the military characteristic distance range, see paragraph 1404.

^bM.O. is used to indicate Master Oscillator control and Ital to indicate crystal control.

^cSets with which it is possible to establish communication by virtue of overlap in operating frequency ranges. Communication may also be established with airborne radio sets which operate in the same frequency range. Obsolete sets not covered, see paragraph 1409 for their frequency overlap.

^dAntenna is part of set. Figure numbers refer to sketches of representative antennas.

^ePower supply units are normally furnished as a part of the radio set unless stated otherwise. The recently adopted policy of shipping equipment "less batteries" requires that dry batteries, in general, be requisitioned separately. Storage batteries, except vehicular, are supplied with the set.

Power Supply ^a	Power Input Requirements ^f	Maintenance Equipment ^g	Weight In Use (lbs.)	TN or Inst. Book ^h	Remarks
Power Unit PE-49 Dys. Unit BD-69 2 Stor. Bat. BB-50 (incl. 1 spare)	Intr - (From PE-49) 365W. at 14.4V.DC 350W. at 1000V.DC Rec. - 3A. at 14V.DC	Freq. Meter SCR-211, Dummy Antenna, 0-1A. RF Ammeter	1150	TN 11-235	Ground, transportable; used for ground-to-ground or ground-to-air communication. Transported by vehicle or cargo plane. Limited Standard. Replaced by SCR-188-A. Used by Sig.C, AAF.
Intr - 115V. or 250V. 60 cycle Com'l Power or Power Unit PE-75, and Rectifier BA-54 Rec. - 115V. 60 Cycle Com'l. Power if operated remote from transmitting site Control Units - 4 Bat. BA-50	Intr - 800W. 115V. 60 Cycle AC (200W. at 12V.DC, 350W. at 1000V.DC From Rect. BA-54) Rec. - 85W. 115V. 60 Cycle AC (or thru 0-250 ohm, 200W. Resistance to 250V.AC)	Freq. Meter SCR-211, Dummy Antenna, 0-1A. RF Ammeter	1385	TN 11-235 TN 11-800 (Intr) TN 11-850 (Rec.) TN 11-900 (Power Unit)	Ground, transportable; used for ground-to-ground, or ground-to-air communication. Intended for semi-fixed use inside of buildings where commercial AC power is available. Can be operated in an emergency from the gasoline engine driven generator supplied. Control Unit RM-12 and Control Unit RM-13 are components of Remote Control Equipment RC-47. All components of RC-47 are supplied with this radio set. Can be remotely controlled over 5 MI. of Wire W-110-B. Transported by vehicle or cargo plane. Used by Sig.C, AAF.
Dynamotor BD-77 Vehicle's 12V. Bat.	Intr - 57A. (Max.) at 14.2V. DC from Vehicle's Battery Generator Rec. - 4.2A. at 12V.DC	Freq. Meter SCR-211, Dummy Antenna, 0-1A. RF Ammeter	234	TN 11-275 TN 11-800 (Intr) TN 11-850 (Rec.)	Vehicular; for communication between stationary or moving vehicles. Normally installed in a vehicle equipped with a 12-volt, 180 ampere-hour storage battery and a 50-ampere generator. SCR-195 has different major components than SCR-195- () but operates in same frequency range. Used by Sig.C, AF, CAV, HMG.
Bat. BA-52	-13.5V, +5V, +4.5V, +14.4V.DC		301	TN 11-238	Pack; walkie-talkie, provides communication over relatively short distances. Two tube transceiver consisting of modulated oscillator/super regenerative detector and modulator/audio amplifier. Used for training purposes and special projects. Limited Standard. Replaced by SCR-609 and SCR-610. Used by Sig.C, AF, HMG, FA.
Bat. BA-52	-13.5V, +5V, +4.5V, +14.4V.DC		301 Portable 581 Vehicular	TN 11-238	OBsolete - Pack and vehicular; two tube transceiver consisting of modulated oscillator/super regenerative detector and modulator/audio amplifier. Used for training purposes and special projects. Replaced by SCR-609 and SCR-610. Used by Sig.C, INF.

^fAC power input requirements are given in watts. To obtain volt-amperes divide watts by 0.8 to 0.9.

^gMaintenance equipment is not furnished as a part of the radio set unless so indicated. Listed here are electrical instruments which may be required to provide normal servicing of the sets.

^hThe first TN listed for each radio set covers the complete set; subsequent TN's cover components of that set. All are normally supplied with the radio set.

^jThe weights of the sets are for normal field operation, excluding accessories not required for the type of operation indicated.

Table continued on next page

RADIO SETS FOR GROUND USE - TACTICAL - DESCRIPTIVE AND TECHNICAL DATA. (Continued)

Type	Major Radio Components	Frequency Range-Mc	Type Mod.	Emission & Military Char. Range In Miles ^a	Rated Trans. Power Output-Watts	Freq. Control ^b	Preset Channels	Communicates With ^c	Type Antenna
SCR-197 Fig.No. 1A11	Transmitter BC-325 Control Unit RM-7 Mtd. in Prime Mover, Truck K-18 5 Receivers BC-3A2 1 Monitor Receiver Hallicrafter S-20-R Control Unit RM-7 Mtd. in Trailer K-19	1.5-18.0 1.5-18.0 0.5A-4A.0	AM	CW-35 mi. Tone-35 Voice-35	400 CW 100 Voice or Tone	M.O. or Ital	None (See Remarks)	SCR-177,188,193, 197,203,209,210, 245,28A,288,299, 399,499,506,511, 536,543,593,69A, AM/TRC-2, AM/VRC-1	Intx-45-Ft. Vert. (MS-65 to 75 incl.) Rec.-3 15-Ft. Whips (MS-49 to 53 incl.) 2 Screen Roof Ant. (Fig. 1A60 without Ctpse.)
SCR-203 Fig.No. 1A12	Transmitter BC-228 Receiver BC-227 Control Box BC-235	2.2-3.06 2.1-3.1	AM	Stationary- CW-30 mi. Tone-20 Voice-5 Moving- CW-10 mi. Tone-6 Voice-3	7.5 -	M.O.	None	SCR-177,188,193, 197,203,209,210, 245,299,399,499, 506,511,543,593, AM/TRC-2, AM/VRC-1	25-Ft. Whip (MS-49 to 56 Incl.) (Fig. 1A60 with- out Ctpse.)
SCR-209 Fig.No. 1A13	Transmitter BC-176 Receiver BC-312 Control Box BC-206	2.2-2.6 1.5-18.0	AM	Stationary- CW-30 mi. Tone-20 Voice-5 Moving- CW-10 mi. Tone-6 Voice-3	8.5 CW 7.5 Voice or Tone	M.O.	None	SCR-177,188,193, 197,203,209,210, 245,299,399,499, 506,511,543,593, AM/TRC-2, AM/VRC-1	15-Ft. Whip (MS-49 to 53 Incl.) (Fig. 1A61b)
SCR-210 Fig.No. 1A14	Receiver BC-312 (Receiver BC-189 used in earlier model, char- acteristics not shown)	1.5-18.0	AM	CW, Tone, Voice	-	-	None	SCR-177,188,193, 197,203,209,245, 28A,288,299,399, 499,506,511,536 543,69A, AM/TRC-2, AM/VRC-1	15-Ft. Whip (MS-49 to 53 Incl.) (Fig. 1A61b)
SCR-245 Fig.No. 1A15	Transmitter BC-223 Tuning Unit TU-17 TU-18 TU-25 Receiver BC-312	 2.0-3.0 3.0-4.5 3.5-5.25 1.5-18.0	AM	Stationary- CW-45 mi. Tone-35 Voice-20 Moving- CW-25 mi. Tone-20 Voice-15	10	M.O. or Ital (Holder) (PT-171)	None (See Remarks)	SCR-177,188,193, 197,203,209,210, 245,28A,288,299, 399,499,506,511, 536,543,593,69A, AM/TRC-2, AM/VRC-1	15-Ft. Whip (MS-49 to 53 Incl.), or 22-1/2 Ft. Wire AN-2A in semi-fixed loc. (Fig. 1A61b)

^aThis is the military characteristic distance range, see paragraph 1A04.

^bM.O. is used to indicate Master Oscillator control and Ital to indicate crystal control.

^cSets with which it is possible to establish communication by virtue of overlap in operating frequency ranges. Communication may also be established with airborne radio sets which operate in the same frequency range. Obsolete sets not covered, see paragraph 1A09 for their frequency overlap.

^dAntenna is part of set. Figure numbers refer to sketches of representative antennas.

^ePower supply units are normally furnished as a part of the radio set unless stated otherwise. The recently adopted policy of shipping equipment "less batteries" requires that dry batteries, in general, be requisitioned separately. Storage batteries, except vehicular, are supplied with the set.

Power Supply ^e	Power Input Requirements ^f	Maintenance Equipment ^g	Weight In Use (Lbs.)	TM or Inst. Book ^h	Remarks
Intr - 115V. or 230V. 60 Cycle AC Com'l Power or Gen. GN-42 (Emergency) Rec. - 110V. 60 Cycle AC Com'l Power or 2 Power Units PK-75 Freq. Meter - 6 Bat. BA-2 4 Bat. BA-23 Control Units - 4 Bat. BA-30 Trailer K-19 1 Bat. BA-44	Intr - 4500W. 115V. or 230V. 60 Cycle AC Incl. 2150W. For Heaters and Lights Rec. - Bn. 55W, 115V. 60 Cycle AC (or thru 0-250 ohm, 200W. Res. to 230V. AC)	Freq. Meter SCR-211 (Incl. with Set), Test Set I-56	15700 Including Vehicles K-18, K-19	TM 11-241 TM 11-805 (Transmitt- ing Com- ponents) TM 11-900 (Power Unit)	Ground, mobile; high power radio station. For use at an Air Corps base or with large field units. Transmitter installed in Truck K-18. 3 receivers, plus monitor, installed in Trailer K-19. Switch selection of master oscillator or any one of five crystal frequencies. Provision for installation of telephone swbd., tele-type and typewriters in Trailer K-19. Transmitter can be remotely controlled using voice, tone or CW operation up to a distance of 7-1/2 Mi. of Wire W-110-B. Limited Standard. Replaced by SCR-399. Used by Sig.C, AAF, AF, INF.
Intr - Hand Gen. GN-35 2 Bat. BA-2 (Bias) Rec. - 4 Bat. BA-23 (Fill.) 4 Bat. BA-2 (Plate) 1 Bat. BA-27 (Bias)	Intr - Hand Gen. 20W. 8.25V.DC 34W. 340V. DC		162 Exclusive of Pack Saddle	TM 11-230	Pack; low power short range highly portable command set designed to clamp on a Phillips Pack Saddle for animal-pack transportation and operation. Limited Standard. Replaced by SCR-245. Used by Sig.C, CAV, FA.
Intr - 12V. Vehicular Bat. Motor Gen. & Bat. Unit PK-48 4 Bat. BA-2 Rec. - 12V. Vehicular Bat.	Intr - 8V. & 12V.DC from Vehicle's Battery 90V.DC Bias Bat. Rec. - 4.2A. at 12V.DC		174	Inst.Book (Stock No. 6DR209)	Vehicular; for use in combat and scout cars equipped with a 12-volt, 180 ampere-hour storage battery and a 50-ampere generator. Limited Standard. Replaced by SCR-508 and SCR-528. Used by AF.
12V. Vehicular Bat.	4.2A. at 12V.DC		71	TM 11-272	Vehicular; receiver only; for use in Signal Corps school and Armored Force replacement training center or for installation in any vehicle requiring a separate receiver. Limited Standard. Replaced by SCR-538. Used by Sig.C, AF.
Dyn. Unit PK-55 Vehicle's 12V. Bat.	Intr - +8V., +12V. & +500V. DC Derived from PK-55 operating on vehicle's Battery Rec. - 50W. at 12V. DC	Freq. Meter SCR-211, 0-100 MA or 0-200 MA RF Milliam- meter, A-58 Dummy Ant., Test Set I-56, Sig. Gen.I-72, Maintenance Equipment ME-5	185	TM 11-272	Vehicular; for providing communication between stationary or moving vehicles equipped with a 12-volt, 180 ampere-hour storage battery with a 50-ampere generator. Tuning Unit TU-25-A, covering frequency range 3.5 to 5.25 Mc, issued only to Cavalry. Switch selection of master oscillator or any one of four crystal frequencies. Replaced in Armored Force by SCR-508 or SCR-528. Used by Sig.C, AF, CAV, FA, INF.

^fAC power input requirements are given in watts. To obtain volt-amperes divide watts by 0.8 to 0.9.

^gMaintenance equipment is not furnished as a part of the radio set unless so indicated. Listed here are electrical instruments which may be required to provide normal servicing of the sets.

^hThe first TM listed for each radio set covers the complete set; subsequent TM's cover components of that set. All are normally supplied with the radio set. The stock number for the instruction book is given when no other identification is available.

Table continued on next page

RADIO SETS FOR GROUND USE - TACTICAL - DESCRIPTIVE AND TECHNICAL DATA. (Continued)

Type	Major Radio Components	Frequency Range-Mc	Type Mod.	Emision & Military Char. Range In Miles ^a	Rated Trans. Power Output-Matts	Freq. Control ^b	Preset Channels	Communicates With ^c	Type Antenna ^d
SCR-284-A Fig.No. 1416	Receiver and Transmitter BC-654 Remote Control RM-29	3.8-5.8	AM	CW-30 mi. Voice-7	High Power 20 CW 8 Voice Low Power (CW-45) 6.5 CW 2 Voice	M.O. (Ital Calibrated)	None	SCR-177,188,195, 197,210,245,284, 288,299,399,499, 506,511,536,545, 593,694, AN/VBC-2, AN/VBC-1	Field Use-25-Ft. Whip and Radial Ctsee., or optional (not supplied) Single-wire fed half-wave Antenna, Inv. L Ant., or Ground Ant. (Wire lying on ground) (Figs. 1460, 1464 & 1468) Vehicular - 15 Ft. Whip (Fig. 1461b)
SCR-285-A Fig.No. 1417	Receiver and Transmitter BC-474	2.3-6.5 3.5-6.3	AM	CW-30 mi Voice-15	4	M.O.	None	SCR-177,188,195, 197,210,245,284, 288,299,399,499, 506,511,536,545, 593,694, AN/VBC-2, AN/VBC-1	35-Ft. Hor. End Fed Wire with 35-Ft. Ctsee. on ground
SCR-293 Fig.No. 1418	Receiver and Transmitter BC-500 Receiver BC-499 Mounting FT-239	20.0-27.9	FM	Voice - Stationary 7 mi. Moving 5 mi.	Full Power 25 Low Power 0.5	Ital	5 (See Remarks)	SCR-293,294,508, 509,510,528,538, 608,609,610,628, 808,828	9-Ft. Flex. Whip AN-42-A with 2-ft. Ext. (Used on 20 to 23 Mc.) (Fig. 1461b)
SCR-294 Fig.No. 1419	Receiver BC-499 Mounting FT-239	20.0-27.9	FM	Voice	-	-	5 (See Remarks)	SCR-293,508,509, 510,528,608,609, 610,628,808,828	9-Ft. Flex. Whip AN-42-A (Fig. 1461b)
SCR-298-C Fig.No. 1420	Transmitter F.M.Link 35 UFM Receiver F.M.Link 11 WF	30-40	FM	Voice - Stationary 10 mi. Moving 7 mi.	35	Ital	1	SCR-298,608,609, 610,628,808,828, AN/CRC-3	6- or 7-Ft. Flex. Whip (Fig. 1461b)

^aThis is the military characteristic distance range, see paragraph 1404.

^bM.O. is used to indicate Master Oscillator control and Ital to indicate crystal control.

^cSets with which it is possible to establish communication by virtue of overlap in operating frequency ranges. Communication may also be established with airborne radio sets which operate in the same frequency range. Obsolete sets not covered, see paragraph 1409 for their frequency overlap.

^dAntenna is part of set. Figure numbers refer to sketches of representative antennas.

^ePower supply units are normally furnished as a part of the radio set unless stated otherwise. The recently adopted policy of shipping equipment "less batteries" requires that dry batteries, in general, be requisitioned separately. Storage batteries, except vehicular, are supplied with the set.

Power Supply ^a	Power Input Requirements	Maintenance Equipment ^b	Weight In Use (Lbs.)	TM or Inst. Book ^c	Remarks
Pack- Hand Gen. GM-45 Bat. BA-45 <u>Ground, trans- portable-</u> Hand Gen. GM-45 with Bat. BA-45 preferred, or with Power Con- verter PK-104-A. Control Unit- 1 Bat. BA-27 <u>Vehicular-</u> 6V. or 12V. vehic. bat. with Power Unit PK-105-A and Power Converter PK-104-A	<u>Transmitting-</u> 147W. 6V. DC or 174W. 12V. DC, or from GM-45 63W. 6V. & 500V. DC	Test Set I-56, Sig. Generator	111 Man Pack Operation 275 Vehicular Operation	TM 11-275	Ground, transportable; vehicular or pack. Command set to be used either in a vehicle or on the ground for communication princi- pally between the Rifle Regiment and its Battalion in the various phases of combat. For pack operation, carried as a three-man load. When used as a ground, transportable set it may be desirable to supply a 6-volt storage battery for operation of Power Con- verter PK-104-A rather than to operate hand generator for receiving. When present stocks are exhausted RM-29 will no longer be furnished as a component; RC-289 will then be ordered separately as a replacement remote control. Limited Standard. Replaced by SCR-694. Used by Sig.C. CAC, FA, INF.
<u>Intr -</u> Hand Gen. GM-44 <u>Rec. -</u> 1 Bat. BA-48 Preferred or Hand Gen. GM-44 with Filter FL-10	<u>Transmitting -</u> 0.1A. at 250V. DC and 1.65A. at 6.6V. DC	Freq. Meter SCR-211, Sig. Gen. I-72, Test Set I-56	71	TM 11-250	Pack and ground, transportable; carried in a vehicle or as a two man load. Temporary replacement for SCR-151, SCR-161 and SCR-171. Limited Standard. Replaced by SCR-264. Used by Sig.C, FA, INF.
12V. or 24V. Vehicular Bat. (3 Dynamos Integral with the Intr and Rec.) (SCR-295 for 12V. operation) (SCR-295-B for 24V. operation)		Test Meter I-87, Sig. Generator	115	Inst. Book (Stock No. 68295A)	Vehicular; for short range communication between units of the Armored Force. In- stalled in tank and scout cars. Principally intended for use by Battalion, Company and Platoon Commanders in the tactical control of their units in combat. The preset chan- nels are limited to adjacent 100 kc. chan- nels, two of which may be selected from the front panel, the remaining three being se- lected by means of switches inside the set. Limited standard. Replaced by SCR-508 and SCR-508. Used by AF.
12V. or 24V. Vehicular Bat. (Dynamo Integral with Rec.) (SCR-294 for 12V. operation) (SCR-294-B for 24V. operation)	2A. at 28V. DC or 4A. at 14V. DC	Test Meter I-87, Sig. Generator	56	Inst. Book (Stock No. 68295A)	Vehicular; receiver only of SCR-295. In- stalled in tank and scout cars. The preset channels are limited to adjacent 100 kc. channels which may be selected by a switch inside of the receiver. Limited standard. Replaced by SCR-558. Used by Sig.C, AF.
6V. Vehicular Bat. and WPA-5A Power Supply for Rec. (Dynamo In- tegral with Intr)	<u>Transmitting -</u> XCA. at 6V. DC <u>Receiving -</u> 9A. at 6V. DC (Incl. Intr Standby)	Test Set I-56	75	Inst. Book (Stock No. 68296C) (TM 11-609)	Vehicular; commercial police car set de- signed for two-way communication. Used by wire personnel. SCR-298-() may have different major radio components, and somewhat different characteristics depend- ing on the particular procurement. Sub- stitute standard. Used by FA.

^aMaintenance equipment is not furnished as a part of the radio set unless so indicated. Listed here are electrical instruments which may be required to provide normal servicing of the sets.

^bThe first TM listed for each radio set covers the complete set; subsequent TM's cover components of that set. All are normally supplied with the radio set. The stock number for the instruction book is given when no other identification is available.

Table continued on next page

RADIO SETS FOR GROUND USE - TACTICAL - DESCRIPTIVE AND TECHNICAL DATA. (Continued)

Type	Major Radio Components	Frequency Range-Mc	Type Mod.	Emission & Military Char. Range In Miles ^a	Rated Trans. Power Output-Watts	Freq. Control ^b	Pre-set Channels	Communicated With ^c	Type Antenna ^d
SCR-299 Fig.No. 1A21	Transmitter BC-610 Receiver BC-312 BC-342 Ant.Tun.Unit BC-729 Speech Amp. BC-61A 2 Telephones EE-8 All mounted in Truck K-51	2.0-8.0 (See Remarks) 1.5-18.0 1.5-18.0	AM	CV, Voice 100 mi. Stationary or Moving	400 CV 300 Voice	M.O. or Ital (Holder FT-171)	None	SCR-177,188,195, 197,203,209,210, 245,284,288,299, 399,499,506,511, 536,543,593,694, AM/VRC-2, AM/VRC-1	Extr - 15-Ft. Whip (MS-49 to 53 Incl., Hor. while in motion, vert. when stat.) Other options for in- creased range in stat operation, 21-Ft. Whip (2 MS-54 added to above) and between 2 to 4.5 Mc., 45-Ft. Aux. Wire Ant. (See Remarks) Rec. - 2 9-Ft. Whips (MS-49 to 51 Incl.) (Figs. 1A61b & 1A63)
SCR-300 Fig.No. 1A22	Receiver and Transmitter BC-1000	40-48	FM	Voice - 3 mi. (Long Ant.)	0.5	M.O. (Ital Cal- ibrated)	None	SCR-300,AM/VRC-3	10-Ft. 8-In. Whip (AM-151, Half-wave) or 33-In. Whip (Am-130, End Loaded) (Fig. 1A61b without base & 1A62) Ground- plane ant. (Fig. 1A72) - See Remarks
SCR-399 Fig.No. 1A23	Transmitter BC-610 Receiver BC-312 BC-342 Ant.Tun.Unit BC-939 Speech Amp. BC-61A 2 Telephones EE-8 All mounted in Shelter HO-17	2.0-18.0 1.5-18.0 1.5-18.0	AM	CV, Voice 100 mi. Stationary or Moving	400 CV 300 Voice (Less at Freq. above 8 Mc)	M.O. or Ital (Holder FT-171)	None	SCR-177,188,195, 197,203,209,210, 245,284,288,299, 399,499,506,511, 536,543,593,694, AM/VRC-2, AM/VRC-1	Extr - 15-Ft. Whip (MS-49 to 53 Incl., hor. while in motion, vert. when stat.) Other options for increased range in stat. oper. 21-Ft. Whip (2 MS-54 added to above) and Aux. Wire Ant. 25 to 65 Ft. long depending on freq. (See Re- marks) Rec. - 2 9-Ft. Whips (MS-51 to 53 Incl.) Option for stat. oper.; 2 15-Ft. Whips (MS-49 and MS-50 added to above) (Figs. 1A61b & 1A63)

^aThis is the military characteristic distance range, see paragraph 1A04.

^bM.O. is used to indicate Master Oscillator control and Ital to indicate crystal control.

^cSets with which it is possible to establish communication by virtue of overlap in operating frequency ranges. Communication may also be established with airborne radio sets which operate in the same frequency range. Obsolete sets not covered, see paragraph 1A09 for their frequency overlap.

^dAntenna is part of set. Figure numbers refer to sketches of representative antennas.

^ePower supply units are normally furnished as a part of the radio set unless stated otherwise. The recently adopted policy of shipping equipment "less batteries" requires that dry batteries, in general, be requisitioned separately. Storage batteries, except vehicular, are supplied with the set.

Power Supply ^a	Power Input Requirements ^f	Maintenance Equipment ^g	Weight In Use (Lbs.)	TM or Inst. Book ^h	Remarks
Power Unit PE-95 (Part of Trailer K-52) Incl. 12V. Stor. Bat. or optional, 115V. 60 cycle AC Com'l Power and 2 spare 6V. Stor. Bat. in Truck K-51 Freq. Meter - 6 Bat. BA-2 4 Bat. BA-23 Telephones - 4 Bat. BA-30 Analyzer - 1 Bat. BA-30 2 Bat. BA-34	<u>Entr</u> - 2000W. 115V. 60 cycle AC (Plus 1500W. for Heater and Lights) <u>Recs.</u> - BC-312 4.2A. at 12V.DC BC-342 85W. 115V. 60 cycle AC	Analyzer BC-1052, Frequency Meter SCR-211 (Both part of SCR-299) (Tools and spare parts are furnished to effect average repairs and maintenance)	12,375 Including Truck K-51, Trailer K-52 3200 (Approx. wt. of radio components removed from vehicles)	TM 11-280 TM 11-850 (Receivers) TM 11-904 (Power Unit) TM 11-300 (Frequency Meter) TM 11-333 (Telephone)	Ground, mobile; high power radio station for providing communication either from a stationary position or while moving at relatively high speeds over rough roads. May be remotely controlled up to a distance of one mile using the two telephones EE-8-() and Wire W-110-B supplied. The remote control equipment provides for remotely keying or voice modulating the transmitter, remotely listening to Receivers BC-312 and BC-342 and communicating with the operator in the radio station who assists in the foregoing operation. A noiseless portable typewriter is included. A half-wave doublet antenna kit has been made available for improving sky wave transmission, thus increasing the range and reliability of operation of this radio set when at a fixed location. (Transmitter of SCR-299-F covers frequency range of 2.0-12.0 Mc.) Frequency conversion kits are now available to extend the transmitter frequency range. Freq. Conversion Kit MC-509 gives coverage down to 1 Mc. Freq. Conversion Kit MC-516 gives coverage to 12 Mc. Freq. Conversion Kit MC-517 gives coverage to 18 Mc. Limited Standard - Replaced by SCR-299 and SCR-499. Used by Sig.C, AAF, CAV, FA, INF.
1 Bat. BA-70 & 1 Bat. BA-80 (Only one in use at a time)	<u>Entr</u> - 0.5A. at 4.5V.DC 25 Ma. at 90V.DC 45 Ma. at 150V.DC <u>Recs.</u> - 0.5A. at 4.5V.DC 25 Ma. at 90V.DC	ME-40 or DC Vacuum Tube Voltmeter & Voltammeter I-107, and Sig. Generator or Freq. Meter SCR-211	38	TM 11-242	Pack; designed primarily for "back-pack" or "on-ground" operation, providing two-way communication over short ranges. The short whip antenna gives less distance range than the half-wave whip. Ground plane Antenna Equipment BC-291 is available for use with this set for increasing the distance range obtained by virtue of the increase in antenna height. Must be ordered separately. Used by CAC, FA, INF.
Power Unit PE-95 (Part of Trailer K-52) Incl. 12V. Stor. Bat. or optional, 115V. 60 cycle AC Com'l Power, and 2 Spare 6V. Stor. Bat. in Shelter HO-17 Freq. Meter - 6 Bat. BA-2 4 Bat. BA-23 Telephones - 4 Bat. BA-30 Analyzer 1 Bat. BA-30 2 Bat. BA-34	<u>Entr</u> - 2000W. 115V. 60 cycle AC (Plus 1500W. for Heater, Blower & Lights). <u>Recs.</u> - BC-312 4.2A. at 12V.DC BC-342 85W., 115V. 60 cycle AC	Analyzer BC-1052, Frequency Meter SCR-211 (Both part of SCR-299) (Tools and spare parts are furnished to effect average repairs and maintenance)	6,595 Including Shelter HO-17, Trailer K-52	TM 11-281 TM 11-850 (Receivers) TM 11-904 (Power Unit) TM 11-300 (Frequency Meter) TM 11-333 (Telephone) Shelter HO-17 Inst. Leaf-let	Ground, mobile; high power radio station for providing communication either from a stationary position or while moving at relatively high speeds over rough roads. Installed in Shelter HO-17 combined with power plant normally carried in cargo trailer K-52. Shelter HO-17 may be mounted on a 2-1/2 ton 6 x 6 cargo truck (not a component) for vehicular operation, or on level ground for fixed operation. May be remotely controlled up to a distance of one mile using the two Telephones EE-8-() and Wire W-110-B supplied. The remote control equipment provides for remotely keying or voice modulating the transmitter, remotely listening to Receivers BC-312 and BC-342 and communicating with the operator in the radio station who assists in the foregoing operations. A noiseless portable typewriter is included. A half-wave doublet antenna kit is included for improving sky wave transmission, thus increasing the range and reliability of operation when at a fixed location. Frequency conversion kit MC-509 is available to extend the transmitter frequency range down to 1.0 Mc. Used by Sig.C, AAF, AF, CAV, FA, INF.

^fAC power input requirements are given in watts. To obtain volt-amperes divide watts by 0.8 to 0.9.

^gMaintenance equipment is not furnished as a part of the radio set unless so indicated. Listed here are electrical instruments which may be required to provide normal servicing of the sets.

^hThe first TM listed for each radio set covers the complete set; subsequent TMs cover components of that set. All are normally supplied with the radio set.

Table continued on next page

RADIO SETS FOR GROUND USE - TACTICAL - DESCRIPTIVE AND TECHNICAL DATA. (Continued)

Type	Major Radio Components	Frequency Range-Mc	Type Mod.	Emission & Military Char. Range In Miles ^a	Rated Trans. Power Output-Watts	Freq. Control ^b	Preset Channels	Communicates With ^c	Type Antenna ^d
SCR-499 Fig.No. 1424	Transmitter BC-610 Receiver BC-312 BC-342 Ant. Tun. Unit BC-939 Speech Amp. BC-614 2 Telephones EE-8	2.0-18.0 1.5-18.0 1.5-18.0	AM	CW, Voice 100 mi. Stationary or Moving (CW only when in 1/4 ton, 4 x 4 truck.)	400 CW 300 Voice (Less at freq. above 8 Mc.)	M.O. or Ital (Holder FT-171)	None	SCR-177,188,193, 197,203,209,210, 245,284,288,299, 399,499,506,511, 536,543,593,694 AN/VRC-2, AN/VRC-1	Intr - 15-Ft. Whip (NE-49 to 53 Incl.) Optional for increased range 21-Ft. Whip (2 NE-54 added to above) or, aux. wire ant. 25 to 65 Ft. long depending on freq. (See Remarks) Ecc. - 2 9-Ft. Whips (NE-51 to 53 Incl.) Optional; 2 15-Ft. Whips (NE-49 and NE-50 added to above) (Figs. 1461b & 1463)
SCR-506 Fig.No. 1425	Transmitter BC-653 Receiver BC-652 Mounting FT-253	2.0-4.5 2.0-6.0	AM	CW-50 mi. Voice-25	80 CW 20 Voice	M.O. (Ital Cal- ibrated)	5 (One of which is tunable)	SCR-177,188,193, 197,203,209,210, 245,284,288,299, 399,499,506,511, 536,543,593,694, AN/VRC-2, AN/VRC-1	15-Ft. Whip (NE-49 to 53 Incl.) Optional in Semi-fixed Loc. 25-Ft. Whip (3 NE-54 added to above) or 22-1/2 Ft. Aux. Wire Ant. (Fig. 1461b)
SCR-508 Fig.No. 1426	1 Transmitter BC-604 2 Receivers BC-603 Mounting FT-237 Interphone Control Boxes BC-606 ^k	20.0-27.9	FM	Voice - Stationary 15 mi. Moving - 10 mi.	30	Ital (Holder FT-241)	10	SCR-293,294,508, 509,510,528,538, 608,609,610,628, 808,828	9-Ft. Whip (NE-51 to 53 Incl.) (Fig. 1461b)
SCR-509 Fig.No. 1427	Receiver and Transmitter BC-620 Case CS-79	20.0-27.9	FM	Voice - 5 mi.	1.8	Ital (Holder FT-243)	2	SCR-293,294,508, 509,510,528,538, 608,609,610,628, 808,828	8-Ft. Telescoping Whip AN-45 (Fig. 1461a)

^aThis is the military characteristic distance range, see paragraph 1404.

^bM.O. is used to indicate Master Oscillator control and Ital to indicate crystal control.

^cSets with which it is possible to establish communication by virtue of overlap in operating frequency ranges. Communication may also be established with airborne radio sets which operate in the same frequency range. Obsolete sets not covered, see paragraph 1409 for their frequency overlap.

^dAntenna is part of set. Figure numbers refer to sketches of representative antennas.

^ePower supply units are normally furnished as a part of the radio set unless stated otherwise. The recently adopted policy of shipping equipment "less batteries" requires that dry batteries, in general, be requisitioned separately. Storage batteries, except vehicular, are supplied with the set.

Power Supply ^e	Power Input Requirements ^f	Maintenance Equipment ^g	Weight In Use (Lbs.)	TN or Inst. Book ^h	Remarks
Power Unit PE-95 Incl. 12V. Stor. Bat. or, optional 115V., 60 cycle AC Com'l Power, and 2 spare 6V. Stor. Bat. Freq. Motor - 6 Bat. BA-2 4 Bat. BA-23 Telephones - 4 Bat. BA-30 Analyzer - 1 Bat. BA-30 2 Bat. BA-34	Extr - 2000W. 115V. 60 cycle AC (Plus 1500W. for Heater, Blower & Lights) Recs. - BC-312 4.2A. at 12V. DC BC-342 85W., 115V., 60 cycles AC	Analyzer BC-1052, Frequency Meter SCR-211 (Both part of SCR-499) (Tools and spare parts are furnished to effect average repairs and maintenance)	3000	TN 11-281 TM 11-850 (Receivers) TM 11-904 (Power Unit) TM 11-300 (Frequency Meter) TM 11-333 (Telephone)	Air transportable; high power radio station smaller to SCR-399, except no shelter or trailer provided and components are packed for transportation by air. May be remotely controlled up to a distance of one mile using the two Telephones EE-8-() and Wire W-110-B supplied. The remote control equipment provides for remotely keying or voice modulating the transmitter, remotely listening to receivers BC-312 and BC-342 and communicating with the operator in the radio station who assists in the foregoing operations. A noiseless portable typewriter is included. A half-wave doublet antenna kit is included for improving sky wave transmission, thus increasing the range and reliability of operation of this radio set. When installed in 1/4 ton, 3/4 x 3/4 truck Antenna Equipment BC-293 (and fed 3/4 wave) is supplied, which together with counterpoise CP-15, is used instead of doublet kit. Frequency Conversion Kit MC-509 is available to extend the transmitter frequency range down to L.O Mc. Used by Sig.C, AAF, AF, CAV, FA, INF.
Vehicular 12V. or 24V. Bat. Extr - Dynamotor DM-42, 12V. DC or DM-43, 24V. DC Rec. - Dynamotor DM-40, 12V. DC or DM-41, 24V. DC	Receiving - 7A. at 12V. DC or 3.4A. at 24V. DC Transmitting - 47A. at 12V. DC or 25A. at 24V. DC Standby - (Not Incl. Rec.) 8A. at 12V. DC or 4.7A. at 24V. DC		357	TN 11-630	Vehicular; command radio set, designed for installation in tanks, amphibian cars, personnel carriers and cars to provide communication between these vehicles and airplanes or base stations. Used by Sig.C, AF, CAV, ENG, FA, TD.
Vehicular 12V. or 24V. Bat. (Dynamotor Integral with Extr & Rec.) (DM-34, 12V. or DM-36, 24V. for Rec.) (DM-35, 12V. or DM-37, 24V. for Extr - designed for 5 Min. "On" and 15 Min. "Off" operation)	Extr and 2 Rec. - 16A. at 24V. DC or 28A. at 12V. DC	Test Set I-56, Volt-Ohmmeter I-107, FM Sig. Generator, Adapter FT-384, Precision Wavemeter, Cord CD-786	200 (Basic Unit without Installation Components)	TN 11-600	Vehicular; short range set installed in tank, armored car, scout car and truck. Interphone amplifier, integral with transmitter, provides communication for personnel in installations where noise level is high. Used by AF.
1 Bat. BA-39 1 Bat. BA-40 1 Bat. BA-41 (Internal, Bias)	Receiving - 0.7A. at 1.5V. DC 25 Ma. at 90V. DC Transmitting - 0.7A. at 1.5V. DC 45 Ma. at 90V. DC 0.5A. at 7.5V. DC 45 Ma. at 150V. DC	ME-13 or ME-73	56 ^j	TN 11-605	Pack; low power, intended for operation on dry batteries from a stationary position. Used by AF.

^f AC power input requirements are given in watts. To obtain volt-amperes divide watts by 0.8 to 0.9.

^g Maintenance equipment is not furnished as a part of the radio set unless so indicated. Listed here are electrical instruments which may be required to provide normal servicing of the sets.

^h The first TN listed for each radio set covers the complete set; subsequent TN's cover components of that set. All are normally supplied with the radio set.

^j The weights of the sets are for normal field operation, excluding accessories not required for the type of operation indicated.

^k The number of Interphone Control Boxes will depend upon the type of vehicle in which the radio set is installed.

Table continued on next page

RADIO SETS FOR GROUND USE - TACTICAL - DESCRIPTIVE AND TECHNICAL DATA. (Continued)

Type	Major Radio Components	Frequency Range-Mc	Type Mod.	Emission & Military Char. Range In Miles ^a	Rated Trans. Power Output-Watts	Freq. Control ^b	Preset Channels	Communicates With ^c	Type Antenna ^d
SCR-510 Fig.No. 1428	Receiver and Transmitter BC-620 Case CS-79 Plate Supply Unit PE-97 Mounting FT-250	20.0-27.9	FM	Voice - 5 mi.	1.8	Ital (Holder FT-243)	2	SCR-293,294,508, 509,510,528,538, 608,609,610,628, 808,828	Vehicular Use 6-Ft. Whip (MS-52, MS-53) Field Use 8-Ft. Telescoping Whip AN-45 or 27-Ft. Wire (Figs. 1461b & 1461a)
SCR-511 Fig.No. 1429	Receiver and Transmitter BC-745 Tuning Unit BC-746 Chest Unit T-39	2.0-6.0	AM	Voice - 5 mi.	0.75	Ital (Holder FT-243)	1 (See Remarks)	SCR-177,188,193, 197,203,209,210, 243,284,288,299, 399,499,506,511, 536,543,593,694, AN/VRC-2, AN/VRC-1	10-1/2 Ft. Telescoping Whip (Fig. 1461a)
SCR-528 Fig.No. 1430	Transmitter BC-604 Receiver BC-605 Mounting FT-237 Interphone Control Boxes BC-606 ^k	20.0-27.9	FM	Voice - Stationary 15 mi. Moving 10 mi.	30	Ital (Holder FT-241)	10	SCR-293,294,508, 509,510,528,538, 608,609,610,628, 808,828	9-Ft. Whip (MS-51 to 53 Incl.) (Fig. 1461b)
SCR-536 Fig.No. 1431	Receiver and Transmitter BC-611	3.5-6.0	AM	Voice - 100 Ft. to 1 mi.	0.02	Ital (Holder FT-243)	1	SCR-177,188,193, 197,210,243,284, 288,299,399,499, 506,511,536,543, 593,694, AN/VRC-2, AN/VRC-1	39-In. Telescoping Whip (Fig. 1461a)
SCR-538 Fig.No. 1432	Receiver BC-603 Interphone Amplifier BC-605 Mounting FT-237 Interphone Control Boxes BC-606 ^k	20.0-27.9	FM	Voice	-	-	10	SCR-293,508,509, 510, 528,608,609, 610,628,808,828	9-Ft. Whip (MS-51 to 53 Incl.) (Fig. 1461b)

^aThis is the military characteristic distance range, see paragraph 1404.

^bM.O. is used to indicate Master Oscillator control and Ital to indicate crystal control.

^cSets with which it is possible to establish communication by virtue of overlap in operating frequency ranges. Communication may also be established with airborne radio sets which operate in the same frequency range. Obsolete sets not covered, see paragraph 1409 for their frequency overlap.

^dAntenna is part of set. Figure numbers refer to sketches of representative antennas.

^ePower supply units are normally furnished as a part of the radio set unless stated otherwise. The recently adopted policy of shipping equipment "less batteries" requires that dry batteries, in general, be requisitioned separately. Storage batteries, except vehicular, are supplied with the set.

Power Supply ^a	Power Input Requirements	Maintenance Equipment ^b	Weight In Use (lbs.)	TM or Inst. Book ^d	Remarks
Vehicular 6V. or 12V. Bat. with Plate Supply Unit PE-97 or PE-120, and 1 Bat. BA-41 (Internal, Bias). Field Use - 1 Bat. BA-39 1 Bat. BA-40 1 Bat. BA-41 (Internal, Bias)	<u>Vehicular Operation -</u> <u>Receiving -</u> 2.8A. at 6.2V.DC or 2.1A. at 12.4V.DC <u>Transmitting -</u> 3.5A. at 6.2V.DC or 2.9A. at 12.4V.DC (Dry Bat. Operation Same as SCR-509)	ME-13 or ME-73	121	TM 11-605	Pack and vehicular; low power. Same as SCR-509 with additional components for use with 6-volt or 12-volt vehicular storage battery and equipped with shock mount for mounting in a vehicle. When present stocks of PE-97 are depleted, PE-120 which operates on 6, 12 or 24-volts DC will be supplied as a component. Used by AF, FA.
1 Bat. BA-49 or Power Supply Unit PE-157 including self contained 2V. Stor. Bat. BB-54	<u>Rec. -</u> 355 Ma. at 1.5V.DC 20 Ma. at 67.5V.DC <u>Extr -</u> 490 Ma. at 1.5V.DC 50 Ma. at 120V.DC	Test Set I-56, Sig. Generator	39 ^d Vehicular (Less Mtg FT-358). 17.5 ^d Portable	TM 11-245	Packed and vehicular; for operation from dry battery or storage battery. Installed in vehicle or carried as guidon by man on horseback or (using dry battery) as one man load. When used with PE-157, the self-contained 2-volt storage battery can be recharged from a 6-volt or 12-volt storage battery. Spare tuning unit carried in chest unit and is readily available for a quick frequency change. Used by Sig.C, CAV, ENG, INF.
Vehicular 12V. or 24V. Bat. (Dynamotor Integral with Extr and Rec.) (IM-34, 12V. or IM-36, 24V. for Rec.) (IM-35, 12V. or IM-37, 24V. for Extr - designed for 5 Min. "On", 15 Min. "Off" operation)	<u>Extr and Rec.</u> 14A. at 24V.DC 24A. at 12V.DC	Test Set I-56, Volt-Ohmmeter I-107, FM Sig. Generator, Adapter FT-384, Precision Wavemeter, Cord CD-786	165 (Basic Unit without Installation Components)	TM 11-600	Vehicular; short range, installed in tank, armored car, scout car and truck. Interphone Amplifier, integral with transmitter, provides communication for personnel in installations where noise level is high. Same as SCR-508 less one receiver. Used by AF.
1 Bat. BA-37 1 Bat. BA-38	<u>Receiving -</u> 0.25A. at 1.5V.DC 11Ma. at 103.5V.DC <u>Transmitting -</u> 0.5A. at 1.5V.DC 35Ma. at 103.5V.DC	Test Equip. IE-17 or IE-15, and RF Sig. Generator, Freq. Meter SCR-211 and Test Set I-56	5.5	TM 11-235	Pack; very short range "Handie-Talkie". Lightweight, self-contained two-way voice radio set for parachute troops. Used by INF.
Vehicular 12V. or 24V. Bat. (Dynamotor Integral with Rec. and Interphone Amplifier, IM-34, 12V. or IM-36, 24V.)	<u>Rec. and Int. Amp.</u> 5A. at 24V.DC or 8A. at 12V.DC	Test Set I-56, Volt-Ohmmeter I-107, FM Sig. Gen., Adapter FT-384, Cord CD-786	115 (Basic Unit without Installation Components)	TM 11-600	Vehicular; receiver only of SCR-528 plus a separate interphone amplifier. Installed in tank and armored car. Interphone amplifier provides communication for personnel in installations where noise level is high. Used by AF.

^aMaintenance equipment is not furnished as a part of the radio set unless so indicated. Listed here are electrical instruments which may be required to provide normal servicing of the sets.

^bThe first TM listed for each radio set covers the complete set; subsequent TM's cover components of that set. All are normally supplied with the radio set.

^cThe weights of the sets are for normal field operation, excluding accessories not required for the type of operation indicated.

^dThe number of Interphone Control Boxes will depend upon the type of vehicle in which the radio set is installed.

Table continued on next page

RADIO SETS FOR GROUND USE - TACTICAL - DESCRIPTIVE AND TECHNICAL DATA. (Continued)

Type	Major Radio Components	Frequency Range-Mc	Type Mod.	Mission & Military Char. Range In Miles ^a	Rated Trans. Power Output-Watts	Freq. Control ^b	Preset Channels	Communicates With ^c	Type Antenna ^d
SCR-543 Fig.No. 1453	Receiver and Transmitter BC-669 Remote Control Unit RM-21	1.68-4.45	AM	Voice - Stationary 20 mi. Moving 15 mi.	45	Ital (Holder FT-171)	6	SCR-177,188,193, 197,203,209,210, 245,284,288,299, 399,499,506,511, 536,543,593,694, AM/VRC-2, AM/VRC-1	15-Ft. Whip (MS-49 to 53 Incl.) & 7 Ft. Radial Ctpse. CP-15 added for non-vehicular use. (Fig. 1461b)
SCR-592 Fig.No. 1454	Receiver BC-728	2.0-6.0	AM	Voice	-	-	4	SCR-177,188,193, 197,203,209,245, 284,288,299,399, 499,506,511,536, 543,694, AM/VRC-2, AM/VRC-1	7-Ft. Telescoping Whip AM-75-A (Fig. 1461a)
SCR-608 Fig.No. 1455	1 Transmitter BC-684 2 Receivers BC-685 Mounting FT-257 Remote Control RM-29	27.0-38.9	FM	Voice - Stationary 15 mi. Moving 10 mi.	30	Ital (Holder FT-241)	10	SCR-293,294,298, 508,509,510,528, 538,608,609,610, 619,628,808,828, AM/CRC-3	9-Ft. Whip (MS-51 to 53 Incl.), or 6-Ft. Whip (MS-52,53) In Half-track (Fig. 1461b)
SCR-609 Fig.No. 1456	Receiver and Transmitter BC-659 Case CS-79 Remote Control RM-29	27.0-38.9	FM	Voice - 5 mi.	2	Ital (Holder FT-241)	2	SCR-293,294,298, 508,509,510,528, 538,608,609,610, 619,628,808,828, AM/CRC-3	13-Ft. Telescoping Whip AM-29-C or 27-Ft. Wire for emerg. (Fig. 1461a)
SCR-610 Fig.No. 1457	Receiver and Transmitter BC-659 Case CS-79 Remote Control RM-29 Plate Supply Unit PE-117 Mounting FT-250	27.0-38.9	FM	Voice - Stationary 5 mi. Moving 3 mi.	2	Ital (Holder FT-241)	2	SCR-293,294,298, 508,509,510,528, 538,608,609,610, 619,628,808,828, AM/CRC-3	13-Ft. Telescoping Whip AM-29-C or 27-Ft. Wire for emerg. 9-Ft. Whip (MS-50-52) For Vehicular Use (Fig. 1461a & 1461b)

^aThis is the military characteristic distance range, see paragraph 1404.

^bM.O. is used to indicate Master Oscillator control and Ital to indicate crystal control.

^cSets with which it is possible to establish communication by virtue of overlap in operating frequency ranges. Communication may also be established with airborne radio sets which operate in the same frequency range. Obsolete sets not covered, see paragraph 1409 for their frequency overlap.

^dAntenna is part of set. Figure numbers refer to sketches of representative antennas.

^ePower supply units are normally furnished as a part of the radio set unless stated otherwise. The recently adopted policy of shipping equipment "less batteries" requires that dry batteries, in general, be requisitioned separately. Storage batteries, except vehicular, are supplied with the set.

Power Supply ^e	Power Input Requirements ^f	Maintenance Equipment ^g	Weight In Use (Lbs.)	TM or Inet. Book ^h	Remarks
Power Unit PE-108 Incl. 12V. Stor. Bat. Power Supply Unit PE-110	Receiving - 220V., 115V., 60 cycle AC, or 5.5A. at 12V. DC Transmitting - 550V., 115V., 60 cycle AC at 8% Power Factor		919	TM 11-625	Ground, transportable and vehicular; medium power transportable command set for use in vehicle or as field station. Equipped with its own gasoline driven source of power for either application. Receiver may be operated from storage battery when gasoline driven generator is not operating. Transmitter and power unit may be controlled from a distance of 18 feet with Remote Control RM-21. Substitute Standard. Used by GAC (AAA).
Stor. Bat. BB-5A (Chargeable from 6V. or 12V. Bat.)	1.85A. at 2V. DC Battery charger 1.1A. at 6V. DC or 0.85A. at 12V. DC		24 ^j Portable 30 ^j Vehicular (Incl. PT-338)	TM 11-859	Pack and vehicular; Push button controlled radio receiver for reception of alert or warning messages. Used by GAC (AAA), EWG.
Vehicular 12V. or 24V. Bat. (Dynamotor Integral with Intr & Rec.) (DM-3A, 12V. or DM-36, 24V. for Rec.) (DM-35, 12V. or DM-37, 24V. for Intr - Designed for 5 Min. "ON" 15 Min. "OFF" Operation) Remote Control - 1 Bat. BA-27	Intr and Recn. - 16A. at 24V. DC or 28A. at 12V. DC	Test Set I-36, Volt- Ohmmeter I-107, FM Sig. Gen., Adapter PT-38A, 4 to 20 Mc. Sensitive Precision Wavemeter, Cord CD-786	200 (Basic Unit with- out In- stallation Components and Remote Control)	TM 11-620 TM 11-308 (Remote Control)	Vehicular; short range, similar to SCR-508 except in frequency. Provides communication for Anti-Aircraft and Anti-Tank Warning and Control Nets. Basic sections at Battalion Command Post, for Fire Control and Fire Direction Nets, and for Intra-Battalion Communication. Installed in armored car, half track and truck. Arranged for remote control operation. When present stocks are exhausted, RM-29 will no longer be supplied as a component; Remote Control Equipment RC-261 will then be ordered separately. Used by FA, TD.
1 Bat. BA-39 1 Bat. BA-40 1 Bat. BA-41 (Internal, Bias) Remote Control - 1 Bat. BA-27	Receiving - 0.94A. at 1.5V. 28 Ms. at 90V. DC Transmitting - 0.94A. at 1.5V. DC 48 Ms. at 90V. DC 0.3A. at 7.5V. DC 50 Ms. at 150V. DC	ME-13 or ME-73	55 ^j without Remote Control 68 ^j With Re- mote Con- trol	TM 11-615 or TM 11-615A TM 11-308 (Remote Control)	Pack; low power, intended for operation on dry batteries from a stationary position. Higher frequency counterpart of SCR-509. Arranged for remote control operation. When present stocks are exhausted, RM-29 will no longer be supplied as a component; Remote Control Equipment RC-261 will then be ordered separately. Used by FA, TD.
Vehicular 6V. or 12V. Bat. with Plate Supply Unit PE-117, or Power Unit PE-120 1 Bat. BA-41 (Internal, Bias) Field Use - 1 Bat. BA-39 1 Bat. BA-40 1 Bat. BA-41 (Internal, Bias) Remote Control - 1 Bat. BA-27	Vehicular Opera- tion - Receiving - 2.7A. at 6.2V. DC or 2.25A. at 12.4V. DC Transmitting - 3.25A. at 6.2V. DC or 2.6A. at 12.4V. DC	ME-13 or ME-73	117 Without Remote Control 130 With Re- mote Con- trol (Both wts. include Case CS-79 and Bat- teries)	TM 11-615 or TM 11-615A TM 11-308 (Remote Control)	Pack and vehicular; low power, same as SCR-609, with additional components for use with 6-volt or 12-volt vehicular storage battery and equipped with shock mount for mounting in a vehicle. Arranged for remote control operation. When present stocks are exhausted, RM-29 will no longer be supplied as a component; Remote Control Equipment RC-261 will then be ordered separately. When present stocks of PE-117 are depleted, PE-120 which operates on 6, 12 or 24 volts, DC, will be supplied as a component. Used by FA, TD.

^f AC power input requirements are given in watts. To obtain volt-amperes divide watts by 0.8 to 0.9.

^g Maintenance equipment is not furnished as a part of the radio set unless so indicated. Listed here are electrical instruments which may be required to provide normal servicing of the sets.

^h The first TM listed for each radio set covers the complete set; subsequent TM's cover components of that set. All are normally supplied with the radio set.

^j The weights of the sets are for normal field operation, excluding accessories not required for the type of operation indicated.

Table continued on next page

RADIO SETS FOR GROUND USE - TACTICAL - DESCRIPTIVE AND TECHNICAL DATA. (Continued)

Type	Major Radio Components	Frequency Range-Mc	Type Mod.	Mission & Military Char. Range In Miles ^a	Rated Trans. Power Output-Watts	Freq. Control ^b	Preset Channels	Communicates With ^c	Type Antenna ^d
SCR-619 ^d Fig.No. 1438	Receiver and Transmitter BC-1555 Mounting FT-506 3 Battery Boxes CR-291	27.0-38.9	FM	Voice	1.5	Ital	2	SCR-295,294,298, 508,509,510,528, 538,608,609,610, 619,628,808,828, AN/CRC-3	Pack - 4-1/2 Ft. Whip (AB-23/GR, AB-24/GR) Field Use - 12-Ft. Whip (3 AB-21/GR, 1 AB-22/GR, 2 AB-23/GR, 1 AB-24/GR) Vehicular - 9-Ft. Whip (MS-116 to 118 Incl.) (Fig. 1461b) (See Remarks)
SCR-624 ^d Fig.No. 1439	Case CS-80 Containing Transmitter BC-625 Receiver BC-624 Rack FT-244 Control Box BC-1175 BC-1171 BC-1176 2 Telephones EK-8	100-156	AM	Voice - Line-of- Sight Max. 130 mi. Grd.- to-Plane	8	Ital (DC-11 or similar)	4	SCR-624, BC-256, BC-257, AN/TBC-7, AN/VRC-1	1/2-Wave J Ant. AN-94 on 50-Ft. Mast MA-7 (Fig. 1465)
SCR-628 ^d Fig.No. 1440	Transmitter BC-684 Receiver BC-683 Mounting FT-237 Remote Con- trol EM-29	27.0-38.9	FM	Voice - Stationary 15 mi. Moving 10 mi.	30	Ital (Holder FT-241)	10	SCR-295,294,298, 508,509,510,528, 538,608,609,610, 619,628,808,828, AN/CRC-3	9-Ft. Whip (MS-51 to 53 Incl.), or 6-Ft. Whip (MS-52,53) in Half-track (Fig. 1461b)
SCR-694-AW Fig.No. 1441	Receiver and Transmitter BC-1156	3.8-6.0	AM	Field Use- CW-50 mi. Voice-15 Vehic.Use- CW-15 mi. Voice-7	Vehic.- 25 CW 7 Voice Field- 15 CW 5 Voice	M.O. (Ital Calli- brated) or Ital (Holder FT-243)	None (See Remarks) SCR-177,188,193, 197,210,245,284, 288,299,399,499, 506,511,536,543, 593,694, AN/TBC-2, AN/VRC-1	15-Ft. Whip (MS-49 to 53 Incl.), or 1/2-Wave Sloping Wire (Fig. 1461b without base, & 1466)	
SCR-694-C Fig.No. 1442	Receiver and Transmitter BC-1506	3.8-6.5	AM	Field Use- CW-50 mi. Tone-20 Voice-15 Vehic.Use- CW-15 mi. Tone-10 Voice-7	Vehic.- 20 CW 7 Voice or Tone Field- 10 CW 5 Voice or Tone	M.O. (Ital Calli- brated) or Ital (Holder FT-243)	None (See Remarks) SCR-177,188,193, 197,210,245,284, 288,299,399,499, 506,511,536,543, 593,694, AN/TBC-2, AN/VRC-1	15-Ft. Whip (MS-49 to 53 Incl.) and Ctpee. CP-12, CP-13 or 1/2-Wave Sloping Wire AN-160 (Figs. 1460 & 1466)	

^aThis is the military characteristic distance range, see paragraph 1404.

^bM.O. is used to indicate Master Oscillator control and Ital to indicate crystal control.

^cSets with which it is possible to establish communication by virtue of overlap in operating frequency ranges. Communication may also be established with airborne radio sets which operate in the same frequency range. Obsolete sets not covered, see paragraph 1409 for their frequency overlap.

^dAntenna is part of set. Figure numbers refer to sketches of representative antennas.

^ePower supply units are normally furnished as a part of the radio set unless stated otherwise. The recently adopted policy of shipping equipment "less batteries" requires that dry batteries, in general, be requisitioned separately. Storage batteries, except vehicular, are supplied with the set.

RADIO SETS FOR GROUND USE - TACTICAL - DESCRIPTIVE AND TECHNICAL DATA. (Continued)

Type	Major Radio Components	Frequency Range-Mc	Type Mod.	Emision & Military Char. Range In Miles ^a	Rated Trans. Power Output-Watts	Freq. Control ^b	Preset Channels	Communications With ^c	Type ^d Antenna
SCR-619 ^d Fig.No. 1438	Receiver and Transmitter BC-1335 Mounting FT-506 3 Battery Boxes CR-291	27.0-38.9	FM	Voice	1.5	Ital	2	SCR-295,294,298, 508,509,510,528, 538,608,609,610, 619,628,808,828, AM/CRC-3	Pack - 4-1/2 Ft. Whip (AB-23/GR, AB-24/GR) Field Use - 12-Ft. Whip (3 AB-21/GR, 1 AB-22/GR, 2 AB-23/GR, 1 AB-24/GR) Vehicular - 9-Ft. Whip (MS-116 to 118 Incl.) (Fig. 1461b) (See Remarks)
SCR-624 Fig.No. 1439	Case CR-80 Containing Transmitter BC-625 Receiver BC-624 Rack FT-244 Control Box BC-1175 BC-1171 BC-1176 2 Telephones EE-8	100-156	AM	Voice - Line-of- Sight Max. 130 mi. Ord.- to-Plane	8	Ital (DC-11 or similar)	4	SCR-624, RC-256, RC-257, AM/TBC-7, AM/VRC-1	1/2-Wave J Ant. AN-94 on 50-Ft. Mast MA-7 (Fig. 1465)
SCR-628 Fig.No. 1440	Transmitter BC-684 Receiver BC-685 Mounting FT-257 Remote Control RM-29	27.0-38.9	FM	Voice - Stationary 15 mi. Moving 10 mi.	30	Ital (Holder FT-241)	10	SCR-295,294,298, 508,509,510,528, 538,608,609,610, 619,628,808,828, AM/CRC-3	9-Ft. Whip (MS-51 to 53 Incl.), or 6-Ft. Whip (MS-52,53) in Half-track (Fig. 1461b)
SCR-624-AW Fig.No. 1441	Receiver and Transmitter BC-1156	3.8-6.0	AM	Field Use- CW-50 mi. Voice-15 Vehic.Use- CW-15 mi. Voice-7	Vehic.- 25 CW 7 Voice 15 CW 5 Voice	M.O. (Ital Call- brated) or Ital (Holder FT-243)	None (See Remarks) SCR-177,188,195, 197,210,245,284, 288,299,399,499, 506,511,536,545, 595,694, AM/TBC-2, AM/VRC-1	15-Ft. Whip (MS-49 to 53 Incl.), or 1/2-Wave Sloping Wire (Fig. 1461b without base, & 1466)	
SCR-624-C Fig.No. 1442	Receiver and Transmitter BC-1306	3.8-6.5	AM	Field Use- CW-50 mi. Tone-20 Voice-15 Vehic.Use- CW-15 mi. Tone-10 Voice-7	Vehic.- 20 CW 7 Voice or Tone 10 CW 5 Voice or Tone	M.O. (Ital Call- brated) or Ital (Holder FT-243)	None (See Remarks) SCR-177,188,195, 197,210,245,284, 288,299,399,499, 506,511,536,545, 595,694, AM/TBC-2, AM/VRC-1	15-Ft. Whip (MS-49 to 53 Incl.) and Ctipes. CP-12, CP-15 or 1/2-Wave Sloping Wire AN-160 (Figs. 1460 & 1466)	

^aThis is the military characteristic distance range, see paragraph 1404.

^bM.O. is used to indicate Master Oscillator control and Ital to indicate crystal control.

^cSets with which it is possible to establish communication by virtue of overlap in operating frequency ranges. Communication may also be established with airborne radio sets which operate in the same frequency range. Obsolete sets not covered, see paragraph 1409 for their frequency overlap.

^dAntenna is part of set. Figure numbers refer to sketches of representative antennas.

^ePower supply units are normally furnished as a part of the radio set unless stated otherwise. The recently adopted policy of shipping equipment "less batteries" requires that dry batteries, in general, be requisitioned separately. Storage batteries, except vehicular, are supplied with the set.

RADIO SETS FOR GROUND USE - TACTICAL - DESCRIPTIVE AND TECHNICAL DATA. (Continued)

Type	Major Radio Components	Frequency Range ^a	Type Mod.	Emission & Military Char. Range In Miles ^b	Rated Trans. Power Output- Watts	Freq. Control ^b	Preset Channels	Communicates With ^c	Type Antenna ^d
<u>SCR-308</u> Fig.No. 1444	1 Transmitter BC-924 2 Receivers BC-923 Mounting FT-237	27.0-38.9	FM	Voice - Stationary 15 mi. Moving 10 mi.	35 High 2 Low	M.O. (Xtal Calibrated)	4	SCR-293,294,298, 508,509,510,528, 538,608,609,610, 619,628,808,828	9-Ft. Whip (MS-51 to 53 Incl.) or 6-Ft. Whip MS-52, 53 (Fig. 1461b)
<u>SCR-308</u> Fig.No. 1444	Transmitter BC-924 Receiver BC-923 Mounting FT-237	27.0-38.9	FM	Voice - Stationary 15 mi. Moving 10 mi.	35 High 2 Low	M.O. (Xtal Calibrated)	4	SCR-293,294,298, 508,509,510,528, 538,608,609,610, 619,628,808,828	9-Ft. Whip (MS-51 to 53 Incl.) or 6-Ft. Whip MS-52, 53 (Fig. 1461b)
<u>RC-256</u> Fig.No. 1445	Receiver BC-659 Freq. Meter BC-658 Frame FM-39	100-156	AM	CV, Tune, Voice	-	-	None	SCR-624, RC-257, AM/YBC-7, AM/YBC-1	Bal. Vert. Half-wave Dipole RC-81 on 90-ft. Mast AM-56. Normally supplied with RC-257 (Fig. 1467)
<u>RC-257</u> Fig.No. 1446	Transmitter BC-640	100-156	AM	Tune, Voice Line-of- Sight	50	Xtal	1	SCR-624, RC-256, AM/YBC-7, AM/YBC-1	Bal. Vert. Half-wave Dipole RC-81 on 90-ft. Mast AM-56 (Fig. 1467)
<u>AM/CRC-3</u> Fig.No. 1447	Transmitter PA-8218 Receiver PA-8098 Entr Control P-8209 Rec. Control P-8208 (Combined in Entr Kit PAC-508C Rec. Kit PACR-158C) Crystal Kit P-8214 (See Remarks)	30-40	FM	Voice - 25 mi.	50	Xtal	1	SCR-298,608,609, 610,619,628,808, 828, AM/CRC-3	Adj. Vert. Coax. Half- wave Dipole (F.M. Link 1566 or 1628), or Vert. Half-Rhombic and Coupling Unit All in Ant. Kit P-8212 (Figs. 1468 & 1469) (Anta. normally mtd. on 50-ft. plywood Mast AB-38/CR, not incl. in Ant. Kit)

^aThis is the military characteristic distance range, see paragraph 1404.

^bM.O. is used to indicate Master Oscillator control and Xtal to indicate crystal control.

^cSets with which it is possible to establish communication by virtue of overlap in operating frequency ranges. Communication may also be established with airborne radio sets which operate in the same frequency range. Obsolete sets not covered, see paragraph 1409 for their frequency overlap.

^dAntenna is part of set except for AM/CRC-3 in which case it is part of a system. Figure numbers refer to sketches of representative antennas.

^ePower supply units are normally furnished as a part of the radio set unless stated otherwise. The recently adopted policy of shipping equipment "less batteries" requires that dry batteries, in general, be requisitioned separately. Storage batteries, except vehicular, are supplied with the set.

Power Supply ^e	Power Input Requirements ^f	Maintenance Equipment ^g	Weight In Use (Lbs.)	TN or Inst. Book ^h	Remarks
Vehicular 12V. or 24V. Bat. (Dynamotor Integral with Extr and Rec.) (DM-6A, 12V. or DM-66, 24V. for Rec.) (DM-65, 12V. or DM-47, 24V. for Extr)	<u>Extr and Rec.</u> 20A. at 24V.DC or 40A. at 12V.DC		225 (Basic Unit without Installation Components)	TN 11-601	Vehicular; short range, used in sea coast Artillery Batteries and by Military Police. Similar to SCR-608 except using crystal calibrated, master oscillator control and interphone amplifier integral with transmitter for use in installations where noise level is high. Used by CAC, MP.
Vehicular 12V. or 24V. Bat. (Dynamotor Integral with Extr and Rec.) (DM-6A, 12V. or DM-66, 24V. for Rec.) (DM-65, 12V. or DM-47, 24V. for Extr)	<u>Extr and Rec.</u> 20A. at 24V.DC or 35A. at 12V.DC		190 (Basic Unit without Installation Components)	TN 11-601	Vehicular; used in sea coast Artillery Batteries and by Military Police. Same as SCR-608 less one receiver. Used by CAC, MP.
Rectifier BA-42 and 115V. or 250W. 60 cycle Com'l. Power	90W., 115V. or 250W. 60 cycle AC	BCA Volt-ohmmet Jr. or similar	600	AAF Technical Order AN 05-20-227	Ground, transportable; receiving equipment only, used with transmitting equipment RC-257 as a single channel radio link terminal station in conjunction with other VEF equipment. A 9x9x7 ft. or larger waterproof shelter is required to house the combined equipment. May be operated from a remote point, over telephone lines, up to a distance of 8 miles; or up to 14 miles with the addition of Telephone Repeater EE-99. (RC-639 also used in VEF Fighter Control Equipment SCR-565, 56A, 565, 566, 567, 574, 575, 633, 634, 657, 6A4, 6A5 and AN/CRC-2). Used by AAF.
115V. or 250W. 60 cycle Com'l Power	860W. 115V. or 250W. 60 cycle AC (1.18 KVA for RC-256 and RC-257 together)		4050	AAF Technical Order AN 05-20-227	Ground, transportable; transmitting equipment only, used with receiving equipment RC-256 as a single channel radio link terminal station in conjunction with other VEF equipment. A 9x9x7 ft. or larger waterproof shelter is required to house the combined equipment. May be operated from a remote point, over telephone lines, up to a distance of 8 miles; or up to 14 miles with the addition of Telephone Repeater EE-99. (RC-6A0 also used in VEF Fighter Control Equipment SCR-562, 567, 573, 632, 637, 6A3 and 6A5). Used by AAF.
115V., 60 cycle AC from PB-7) (Not supplied as a component part)	<u>Extr -</u> 250W. 115V. 60 cycle AC <u>Rec. -</u> 75W. 115V. 60 cycle AC	Microammeter P-8100 (Part of AN/CRC-3)		Preliminary Instruction Book for Signal Aircraft Warning System Communications Equipment	Air transportable; commercial police radio set, modified for use in Air Warning service. Packaged for transportation by air. Transmitter of AN/CRC-3 employs a frequency multiplication of 32 times crystal frequency. Replaced by AN/CRC-3A. Procurement shall be AN/CRC-3A. Type numbers of the major components are those assigned by the manufacturer (Galvin Mfg. Corp.) and are not Signal Corps designations. Used by AAF.

^f AC power input requirements are given in watts. To obtain volt-amperes divide watts by 0.8 to 0.9.

^g Maintenance equipment is not furnished as a part of the radio set unless so indicated. Listed here are electrical instruments which may be required to provide normal servicing of the sets.

^h The first TN listed for each radio set covers the complete set; subsequent TN's cover components of that set. All are normally supplied with the radio set.

Table continued on next page

RADIO SETS FOR GROUND USE - TACTICAL - DESCRIPTIVE AND TECHNICAL DATA. (Continued)

Type	Major Radio Components	Frequency Range-Mc	Type Mod.	Mission Char. Range In Miles ^a	Trans. Power Output-Watts	Freq. Control ^b	Preset Channels	Communicates With ^c	Type Antenna ^d
<u>AM/CRC-3A</u> Fig.No. 1447	Transmitter PA-8244 Receiver PA-8245 Xstr Control P-8209 Rec. Control P-8208 (Combined in Xstr Kit PMP-50BD Rec. Kit PGR-15BD) Crystal Kit P-8214 (See Remarks)	30-40	FM	Voice - 25 mi.	50	Ital	1	SCR-298,608,609, 610,619,628,808, 828, AM/CRC-3	Adj. Vert. Coax. Half-wave Dipole (F.M. Link 1566 or 1628), or Vert. Half-rhombic and Coupling Unit. All in Ant. Kit P-8212. (Figs. 1468 & 1469) (Anta. are normally mtd. on 50-ft. plywood Mast AB-38/CR, not incl. in Ant. Kit)
<u>AM/TRA-1</u> (Amplifier Equipment) Fig.No. 1448	Amplifier AM-8/TRA-1 Spare Parts Kit MK-11/TRA-1	70-100	-	-	250	-	-	-	3-Elem. Directional Array (Incl. in Ant. System AS-19/TRC-1) (Furnished with AM/TRC-1, 3 or 4) (Normally mtd. 40 ft. above ground) (Fig. 1470)
<u>AM/TRC-1</u> Fig.No. 1449	Transmitter T-14/TRC-1 Receiver R-19/TRC-1	70-100	FM	Voice - 25 mi. (Line-of-sight)	High Power 50 Low Power 10	Ital (Holder) Xstr (PT-241) Rec. (PT-243)	1	AM/TRC-1, AM/TRC-3, AM/TRC-4	3-Elem. Directional Array (Incl. in Ant. System AS-19/TRC-1) (2 supplied) (Fig. 1470) (Ant. Extension Kit MK-141/TRC-1 incl. for raising ant. from 40-ft. to 50-ft. when only one antenna is required.)

^aThis is the military characteristic distance range, see paragraph 1404.

^bM.O. is used to indicate Master Oscillator control and Ital to indicate crystal control.

^cSets with which it is possible to establish communication by virtue of overlap in operating frequency ranges. Communication may also be established with airborne radio sets which operate in the same frequency range. Obsolete sets not covered, see paragraph 1409 for their frequency overlap.

^dAntenna is part of set except for AM/CRC-3A, in which case it is part of a system. Figure numbers refer to sketches of representative antennas.

^ePower supply units are normally furnished as a part of the radio set unless stated otherwise. The recently adopted policy of shipping equipment "less batteries" requires that dry batteries, in general, be requisitioned separately. Storage batteries, except vehicular, are supplied with the set.

Power Supply ^a	Power Input Requirements ^f	Maintenance Equipment ^g	Weight In Use (Lbs.)	TM or Inst. Book ^h	Remarks
115V., 60 cycle AC from PE-75 (Not supplied as a component part)	Entr - 290W. 115V. 60 cycle AC Rec. - 75W. 115V. 60 cycle AC	Microammeter P-8100 (Part of AN/CRC-5A)			Air transportable; similar to AN/CRC-5 except transmitter employs a frequency multiplication of 8 times crystal frequency. Replaces AN/CRC-5. Usually obtained in groups of 50 sets. Antenna, spare parts, crystal kits, maintenance equipment, etc. except 50-foot plywood mast provided on a system basis. Type numbers of the major components are those assigned by the manufacturer (Calvin Mfg. Corp.) and are not Signal Corps designations. Used by AAF.
Power supply PP-15/TRA-1 (Operates from 115V., 60 cycle AC Com'l Power or Power Unit PE-75 normally supplied with AN/TRC-1, AN/TRC-3 or AN/TRC-4)	800W., 115V., 60 cycle AC	Test Set I-56 (Furnished with the associated AN/TRC-3 or AN/TRC-4)	282 (Less Running Spares & Spare Parts Kit MK-11/TRA-1)	TM 11-2601	Ground, transportable; amplifier equipment for use in conjunction with Radio Set AN/TRC-1, Radio Terminal Set AN/TRC-3 or Radio Relay Set AN/TRC-4. Provides approximately 6 db gain in output when used with the transmitters of the foregoing radio sets. Used by AGF, AGF.
115V., 60 cycle AC Com'l. Power or Power Unit PE-75	Entr - 250W. 115V. 60 cycle AC Rec. - 100W. 115V. 60 cycle AC	Test Dec. TS-52/TRC-1 (Part of AN/TRC-1) and Test Set I-56 (Not Included) (Spare parts and running spares furnished to effect average repairs and maintenance)	1455	TM 11-2601 TM 11-900 (Power Unit)	Ground, transportable; VHF FM radio transmitter and receiver together with the necessary accessories to set up a field radio station. Designed to operate with a voice frequency band from 200-12000 cycles and, in conjunction with spiral-four carrier terminal equipment, will provide four telephone circuits, any one of which may be used to provide one facsimile circuit or four voice frequency telegraph circuits. Transmitter employs a frequency multiplication of 96 times crystal frequency. Includes provision for installation as an intermediate automatic radio relay station. Provision is made for coupling directly to spiral-four cable and carrier Telephone Terminal CF-1 when the radio circuit is used as a part of the Signal Corps four-channel carrier telephone system. Alternatively, this set may be used on a single channel basis, push-to-talk, in which case it can be remotely controlled and the transmitter satisfactorily voice modulated from a distance of 2 miles over Wire W-110-B, using Remote Control Equipment AN/TRA-2. (Not furnished as a component part.) This distance may be extended to 7-1/2 miles of Wire W-110-B when used with Operations Center AN/TTQ-1 which includes an auxiliary amplifier. Used by Sig.C, AAF.

^f AC power input requirements are given in watts. To obtain volt-amperes divide watts by 0.8 to 0.9

^g Maintenance equipment is not furnished as a part of the radio set unless so indicated. Listed here are electrical instruments which may be required to provide normal servicing of the sets.

^h The first TM listed for each radio set covers the complete set; subsequent TM's cover components of that set. All are normally supplied with the radio set.

Table continued on next page

RADIO SETS FOR GROUND USE - TACTICAL - DESCRIPTIVE AND TECHNICAL DATA. (Continued)

Type	Major Radio Components	Frequency Range-Mc	Type Mod.	Emission & Military Char. Range In Miles ^a	Rated Trans. Power Output-Watts	Freq. Control ^b	Power Channels	Communicated With ^c	Type Antenna ^d
<u>AN/TRC-2</u> Fig.No. 1450	Receiver and Transmitter BC-1506 Receiver and Transmitter RT-12/TRC-2	3.8-6.5 2.0-3.4	AM	CW-80 mi. Tone-Voice	PK-162 20 CW 7 Tone or Voice GN-57 10 CW 5 Tone or Voice	M.O. (Ital Cal-ibrated) or Ital (Holder FT-243)	None (See Remarks)	SCR-177,188,193, 197,203,209,210, 245,284,288,299, 399,499,506,511, 536,543,593,694, AN/TRC-2, AN/TRC-1	1/4-Wave Inv. L Ant. with Ctpec. (for 2.0-3.4 Mc.) or 1/2-Wave Inv. L Ant. without Ctpec. (for 3.8-6.5 Mc.) (Fig. 1458)
<u>AN/TRC-3</u> Fig.No. 1451	2 Transmitters T-14/TRC-1 2 Receivers R-19/TRC-1 3 Telephones KE-8	70-100	FM	Voice - 25 mi. per link (Line-of-sight)	High Power 50 Low Power 10	Ital (Holder) Xstr (FT-241) Rec. (FT-243)	1	AN/TRC-1, AN/TRC-3, AN/TRC-4	3 Elem. Directional Array (Incl. in Ant. System AS-19/TRC-1 (2 supplied) Normally mtd. 40-ft. above ground (Fig. 1470)
<u>AN/TRC-4</u> Fig.No. 1452	3 Transmitters T-14/TRC-1 3 Receivers R-19/TRC-1 1 Control Box C-21/TRC-1 3 Telephones KE-8	70-100	FM	Voice- 25 mi. per link (Line-of-sight)	High Power 50 Low Power 10	Ital (Holder) Xstr (FT-241) Rec. (FT-243)	1	AN/TRC-1, AN/TRC-3, AN/TRC-4	3-Elem. Directional Array (Incl. in Ant. System AS-19/TRC-1 (4 supplied) Normally mtd. 40 ft. above ground (Fig. 1470)
<u>AN/TRC-7</u> ^j Fig.No. 1453	Receiver and Transmitter RT-53/TRC-7	100-156	AM	Voice - 35 mi. Ground-to-Plane (Line-of-sight)	0.5	Ital (DC-11 or Similar)	2	SCR-624, RC-256, RC-257, AN/TRC-7, AN/TRC-1	Vert. Conical Dipole AS-12/TRC-7 mtd. on 30-ft. alum. Mast (Incl. in Ant. Assembly AS-110/TRC-7) or 1/4-Wave Whip AT-59/TRC-7 mtd. on set with flex. Ant. Base AB-57/TRC-7 (Fig. 1471)

^aThis is the military characteristic distance range, see paragraph 1404.

^bM.O. is used to indicate Master Oscillator control and Ital to indicate crystal control.

^cSets with which it is possible to establish communication by virtue of overlap in operating frequency ranges. Communication may also be established with airborne radio sets which operate in the same frequency range. Obsolete sets not covered, see paragraph 1409 for their frequency overlap.

^dAntenna is part of set. Figure numbers refer to sketches of representative antennas.

^ePower supply units are normally furnished as a part of the radio set unless stated otherwise. The recently adopted policy of shipping equipment "less batteries" requires that dry batteries, in general, be requisitioned separately. Storage batteries, except vehicular, are supplied with the set.

Power Supply ^e	Power Input Requirements ^f	Maintenance Equipment ^g	Weight In Use (Lbs.)	TN or Inst. Book ^h	Remarks
1 Hand Gen. GW-57 or 2 Power Units PB-162 - 2 Bat. BA-48 2 Vib. Units PF-39/TSC-2 incl. 2 Stor. Bat. BB-54, re- chargeable from 6V. or 12V. vehicular bat. or GW-57 or PB-162	Approx. 50W. at 425V. DC., 6V., DC, and 1.5V. DC from GW-57, or 100W. at 500V. DC and 7V. DC from PB-162. Either receiver may be operated for ap- prox. 10 hrs. from a fully charged BB-54 & PF-39/TSC-2 or for approx. 20 hrs. from Bat. BA-48	-	500 (Radio equip- ment only)	TN 11-2603	Ground, transportable; and pack; special for communication from isolated units to headquarters. Two complete receiver and transmitter combinations each provided with switch selection of master oscillator or either of two crystal frequencies. Requires 12 to 14 men for transportation. Used by Sig.C.
115V., 60 cycle AC Com'l Power or Power Unit PB-75 (3 Sup- plied) Test Set - 1 Bat. BA-2 1 Bat. BA-30 1 Bat. BA-31 Telephones - 6 Bat. BA-30	Entr - 250W. 115V. 60 cycle AC Rec. - 100W. 115V. 60 cycle AC	Test Dec. TS-32/TSC-1 and Test Set I-56 (Both part of AN/TSC-3) (Spare parts and running spares furn- ished to ef- fect average repairs and maintenance)	2650	TN 11-2601 TN 11-900 (Power Unit) TN 11-333 (Telephone)	Ground, transportable; Radio Terminal Set utilizes the same basic components as Radio Set AN/TSC-1, but includes sufficient extra equipment to insure continuous 24-hour-a-day service as a four-channel carrier telephone radio terminal used in conjunction with carrier Telephone Terminal CF-1. When the radio circuit is used as a link in the spiral-four carrier telephone system, the carrier telephone terminal is located at the terminal of the wire system rather than at the radio terminal. A spare transmitter and receiver, and spare power units are furnished. Used by AAF, AGF, ASF.
115V., 60 cycle AC Com'l. Power or Power Unit PB-75 (3 Sup- plied) Test Set - 1 Bat. BA-2 1 Bat. BA-30 1 Bat. BA-31 Telephones - 6 Bat. BA-30	2 Entr - 500W. 115V. 60 cycle AC 2 Recs. - 200W. 115V. 60 cycle AC	Test Dec. TS-32/TSC-1 and Test Set I-56 (Both part of AN/TSC-4) (Spare parts and running spares furn- ished to ef- fect average repairs and maintenance)	3500	TN 11-2601 TN 11-900 (Power Unit) TN 11-333 (Telephone)	Ground, transportable; Radio Relay Set utilizes the same basic components as Radio Set AN/TSC-1, but includes sufficient extra equipment to provide an independent two-way four-channel radio repeater station with sufficient spare equipment to insure 24-hour a-day continuous service. Two transmitters and two receivers are required for the relay operation, with an extra unit of each provided as a spare. Used by AAF, AGF, ASF.
Hand Generator G-3/TSC-7, 3 Bat. BA-65 & 7 Bat. BA-211/U, or 1 Bat. BA-70	Transm. and Rec. - Approx. 22W. at 4.5V. and 150V. DC from Hand Gen. or 0.55A. at 4.5V. DC and 0.125A. at 150V. DC from Dry Bat. Receiving - 300 Ma. at 4.5V. DC 26 Ma. at 150V. DC	IX-19	85 Approx.		Pack; ground, transportable; light weight, VEF communication set. Transportable by four-man team. Can be remotely controlled up to a distance of 2 mi. of Wire W-110-B by the addition of Remote Control Equipment RC-261. It is possible, by means of the power switch, (1) to transmit and receive using battery supply only, (2) to transmit and receive using hand generator only, and (3) to transmit using hand generator and to receive using battery supply. Used by AAF.

^f AC power input requirements are given in watts. To obtain volt-amperes divide watts by 0.8 to 0.9.

^g Maintenance equipment is not furnished as a part of the radio set unless so indicated. Listed here are electrical instruments which may be required to provide normal servicing of the sets.

^h The first TN listed for each radio set covers the complete set; subsequent TN's cover components of that set. All are normally supplied with the radio set.

ⁱ Not available until late in 1944.

Table continued on next page

RADIO SETS FOR GROUND USE - TACTICAL - DESCRIPTIVE AND TECHNICAL DATA. (Continued)

Type	Major Radio Components	Frequency Range-Mc	Emission & Military Type Char. Range Mod. In Miles	Rated Trans. Power Output-Watts	Freq. Control ^b	Preset Channels	Communicates With ^c	Type Antenna ^d
AM/THC-8 ^d Fig.No. 1474	Transmitter T-30/THC-8 Receiver R-48/THC-8	230-250	FM Voice - (Line-of-sight)	12	M.O. (Temp. Compensated Concentric Tuned Trans. Line)	None	AM/THC-8, AM/THC-11, AM/THC-12	1/2 Wave Dipole with 90° Corner Reflector (Ant. Assembly AS-52/THC-8 and Ant. Support AS-()/THC-8) (2 Supplied) (Fig. 1475)
AM/THC-11 ^d Fig.No. 1475	2 Transmitters T-30/THC-8 2 Receivers R-48/THC-8 3 Telephones KE-8	230-250	FM Voice - (Line-of-sight)	12	M.O. (Temp. Compensated Concentric Tuned Trans. Line)	None	AM/THC-8, AM/THC-11, AM/THC-12	1/2 Wave Dipole with 90° Corner Reflector (Ant. Assembly AS-52/THC-8 and Ant. Support AS-()/THC-8) (2 Supplied) (Fig. 1475)
AM/THC-12 ^d Fig.No. 1456	3 Transmitters T-30/THC-8 3 Receivers R-48/THC-8 3 Telephones KE-8	230-250	FM Voice - (Line-of-sight)	12	M.O. (Temp. Compensated Concentric Tuned Trans. Line)	None	AM/THC-8, AM/THC-11, AM/THC-12	1/2 Wave Dipole with 90° Corner Reflector (Ant. Assembly AS-52/THC-8 and Ant. Support AS-()/THC-8) (4 Supplied) (Fig. 1475)
AM/VHC-1 Fig.No. 1457	Transmitter BC-191 Tuning Unit TU-6 TU-7 Receiver BC-312 Case CS-80 Containing Transmitter BC-625 Receiver BC-624 Rack FT-244 Int.Cont.Box BC-606	3.0-4.5 4.5-6.2 1.5-18.0	AM EF Portion- Stationary CW-60 mi. Tone-40 mi. Voice-20 mi. (BC-625) Moving CW-30 mi. Tone-20 mi. Voice-15 mi. VHF Portion- Voice - Line-of- Sight Max. 150 mi. Ord.-to- Plane	75 (BC-191) 6 (BC-625)	M.O. Ital (DC-11) BC-625	None (BC-191A BC-312) 4 (BC-625 & BC-624)	SCR-177,188,195, 197,203,209,210, 245,284,288,299, 399,499,506,511, 536,543,593,624, 694, BC-256, RC-257, AM/THC-2, AM/THC-7, AM/VHC-1	15-Ft. Whip (MS-49 to 53 Incl.) or 22-1/2 Ft. Wire for BC-191. 3-Ft. Whip (MS-55) for BC-625 (Fig. 1461b)
AM/VHC-3 Fig.No. 1422	Receiver and Transmitter BC-1000 Mounting FT-250 (Light Tank M4) or FT-317 (Med.Tank M4)	40-48	FM Voice	0.5	M.O. (Xtal Cal- ibrated)	None	SCR-300, AM/VHC-3	3-Ft. Whip MS-118 or 6-Ft. Whip MS-117 & MS-118 for Vehicular Use, or 35-in. Short Whip (AM-150) for portable use (Fig. 1461b & 1462)

^aThis is the military characteristic distance range, see paragraph 1404.

^bM.O. is used to indicate Master Oscillator control and Ital to indicate crystal control.

^cSets with which it is possible to establish communication by virtue of overlap in operating frequency ranges. Communication may also be established with airborne radio sets which operate in the same frequency range. Obsolete sets not covered, see paragraph 1409 for their frequency overlap.

^dAntenna is part of set. Figure numbers refer to sketches of representative antennas.

^ePower supply units are normally furnished as a part of the radio set unless stated otherwise. The recently adopted policy of shipping equipment "less batteries" requires that dry batteries, in general, be requisitioned separately. Storage batteries, except vehicular, are supplied with the set.

Power Supply ^e	Power Input Requirements ^f	Maintenance Equipment ^g	Weight in Use (Lbs.)	TM or Inst. Book ^h	Remarks
115V., 60 cycle AC Com'l Power or Power Unit PE-75 (1 Supplied)	Intr and Rec. - 410W., 115V. 60 cycle AC	(Spare parts and running spares furnished to effect average repairs and maintenance)	122 ^k		Ground, transportable, VHF FM radio transmitter and receiver together with the necessary accessories to set up a field radio station. Designed to operate with a voice frequency band from 200-12000 cycles and, in conjunction with spiral-four carrier terminal equipment will provide four telephone circuits, any one of which may be used to provide one facsimile circuit or four voice frequency telegraph circuits. Transmitter employs a frequency multiplication of 3 times the master oscillator frequency. Includes provision for installation as an intermediate automatic radio relay station. Provision is made for coupling directly to spiral-four cable and carrier Telephone Terminal CF-1 when the radio circuit is used as a part of the Signal Corps four-channel carrier telephone system. Alternatively, this set may be used on a single channel basis, push-to-talk, in which case it can be remotely controlled and the transmitter satisfactorily voice modulated from a distance of 2 miles over Wire W-110-B, using Remote Control Equipment AM/TRA-2. (Not furnished as a component part.) Used by Sig.C, AAF.
115V., 60 cycle AC Com'l Power or Power Unit PE-75 (3 Supplied)	Intr and Rec. - 410W., 115V. 60 cycle AC	(Spare parts and running spares furnished to effect average repairs and maintenance)	2229		Ground, transportable; Radio Terminal Set utilizes the same basic components as Radio Set AM/TBC-8, but includes sufficient extra equipment to insure continuous 24-hour-a-day service as a four-channel carrier telephone radio terminal used in conjunction with carrier Telephone Terminal CF-1. When the radio circuit is used as a link in the spiral-four carrier telephone system, the carrier telephone terminal is located at the terminal of the wire system rather than at the radio terminal. A spare transmitter and receiver, and spare power units are furnished. Used by AAF, AGF, ASF.
115V., 60 cycle AC Com'l Power or Power Unit PE-75 (3 Supplied)	2 Intrs. and 2 Recs. - 820W., 115V. 60 cycle AC	(Spare parts and running spares furnished to effect average repairs and maintenance)	3036		Ground, transportable; Radio Relay Set utilizes the same basic components as Radio Set AM/TBC-8, but includes sufficient extra equipment to provide an independent two-way four-channel radio repeater station with sufficient spare equipment to insure 24-hour-a-day continuous service. Two transmitters and two receivers are required for the relay operation, with an extra unit of each provided as a spare. Used by AAF, AGF, ASF.
Dyn. ED-77 Dyn. Unit PE-98 Vehicle's 12V. Stor. Battery	Intr - BC-191 57A. (Max.) at 14.2V.DC from Vehicle's Bat. Generator. Rec. - BC-312 4.2A. at 12V.DC Intr - BC-623 23A. at 14V.DC Rec. - BC-624 22A. at 14V.DC	Test Equip. IE-36 and Test Set I-139, or IE-19 or IE-12, and I-36	33 ^k	TM 11-277 (Combined Operation) TM 11-273 (Radio Set SCR-193). AAF, Technical Order TO CG-10-105 (Radio Set SCR-342).	Ground, mobile; combines SCR-342, air-to-ground set, with SCR-193 to give a combined HF and VHF set for ground-to-air and ground-to-ground communication. Mounted in 1/4-ton 4 x 4 truck (not a component). Used by AAF.
Bat. BA-70	Intr - 0.5A. at 4.5V.DC 25 Ma. at 90V.DC 45 Ma. at 150V.DC DC Rec. - 0.5A. at 4.5V.DC 25 Ma. at 90V.DC	ME-40 or DC Vacuum Tube Voltmeter & Voltammeter I-107, and Sig. Generator or Freq. Meter SCR-211		TM 11-242	Vehicular; similar to SCR-300 except arranged for installation in Light and Medium Tanks. Used by AF.

^f AC power input requirements are given in watts. To obtain volt-amperes divide watts by 0.8 to 0.9.

^g Maintenance equipment is not furnished as a part of the radio set unless so indicated. Listed here are electrical instruments which may be required to provide normal servicing of the sets.

^h The first TM listed for each radio set covers the complete set; subsequent TM's cover components of that set. All are normally supplied with the radio set.

^k Not available until late in 1944.

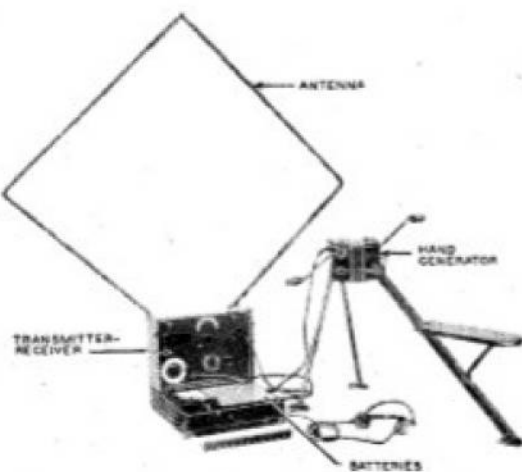

FIGURE 1401. Radio Set SCR-131 or 161

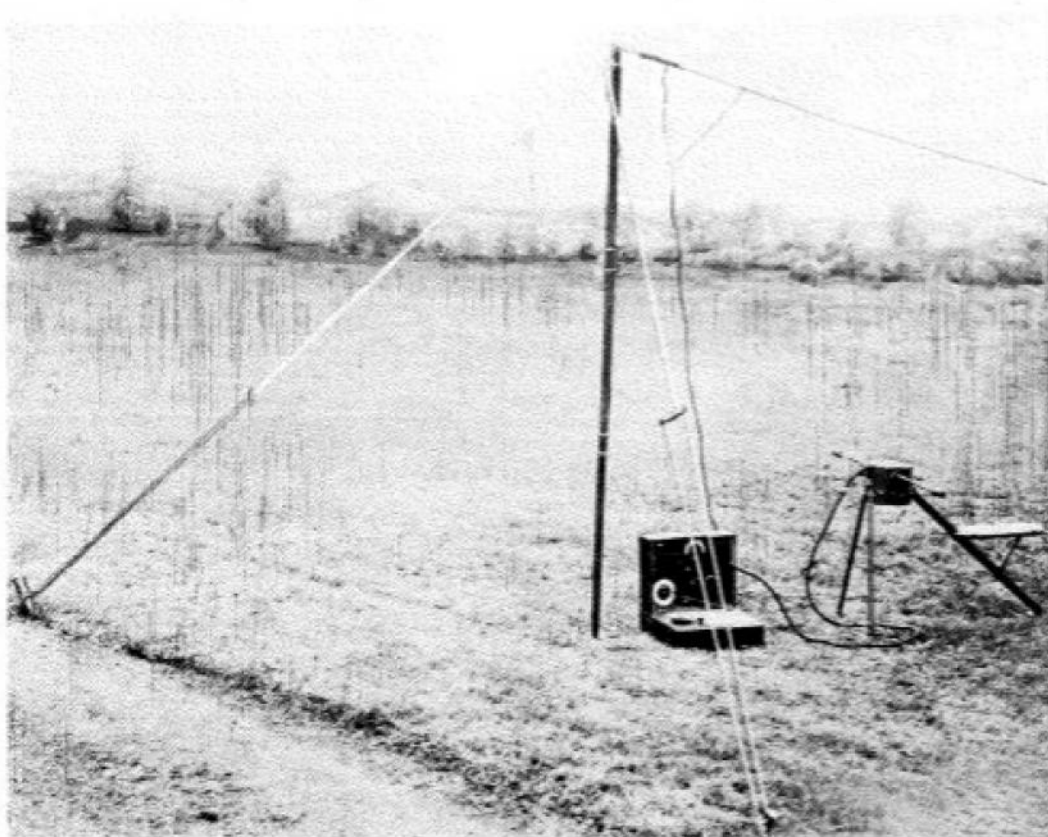

FIGURE 1402. Radio Set SCR-171

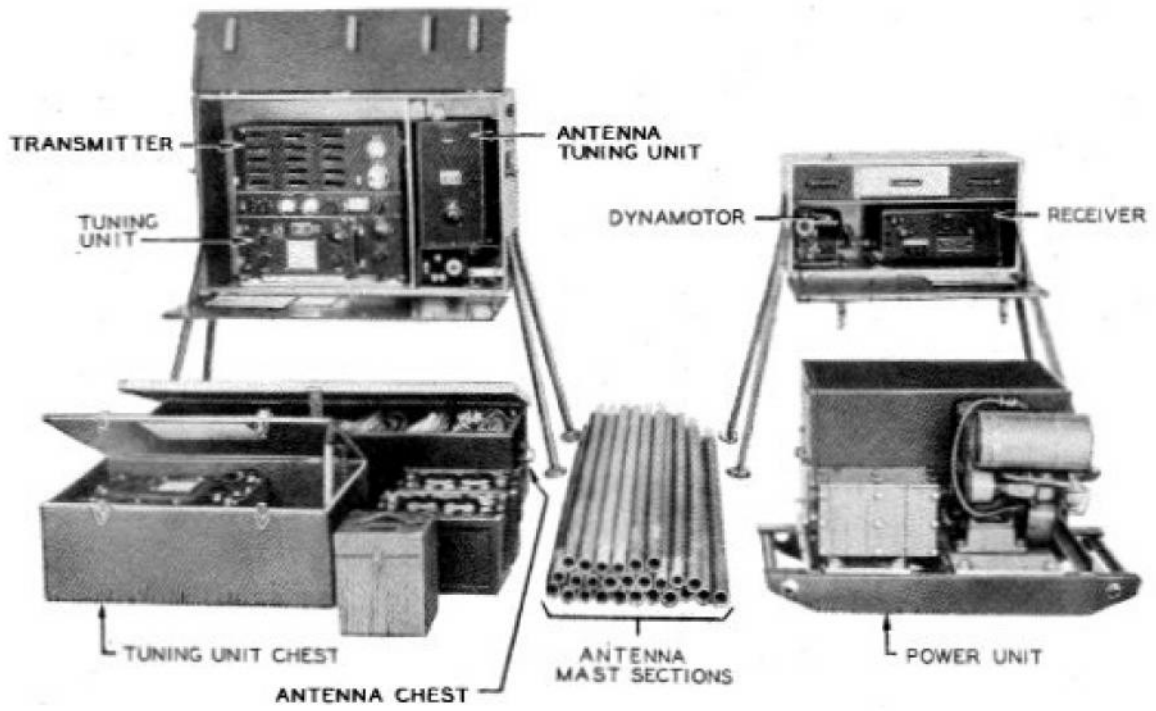

FIGURE 1403. Radio Set SCR-177-A

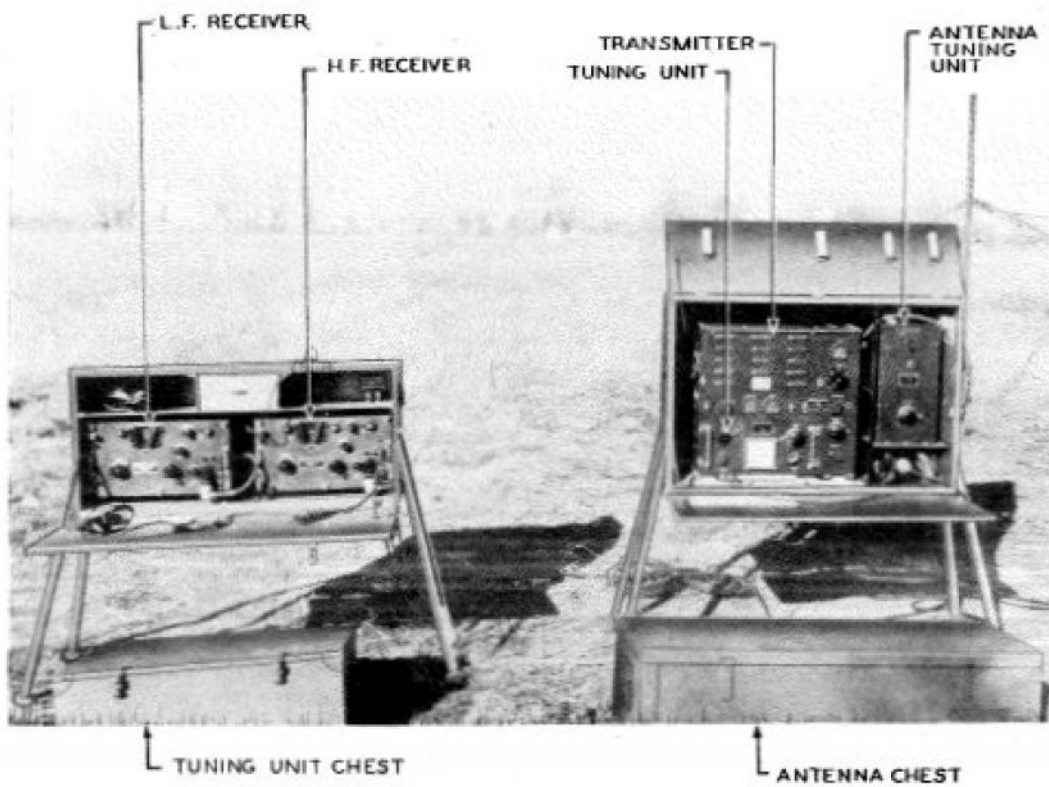

FIGURE 1404. Radio Set SCR-177-B

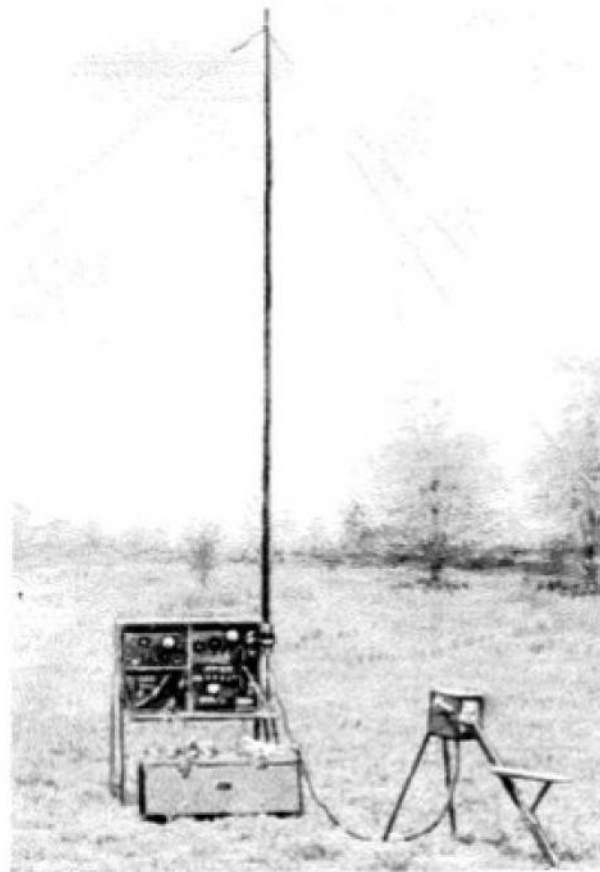

FIGURE 1405. Radio Set SCR-178 or 179

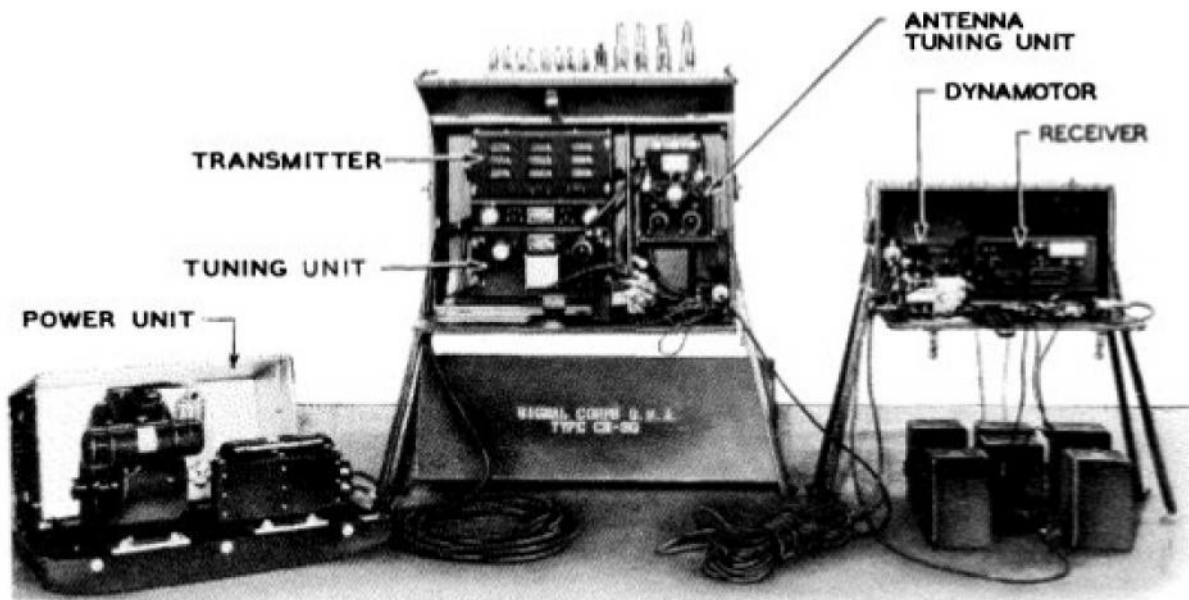

FIGURE 1406. Radio Set SCR-188

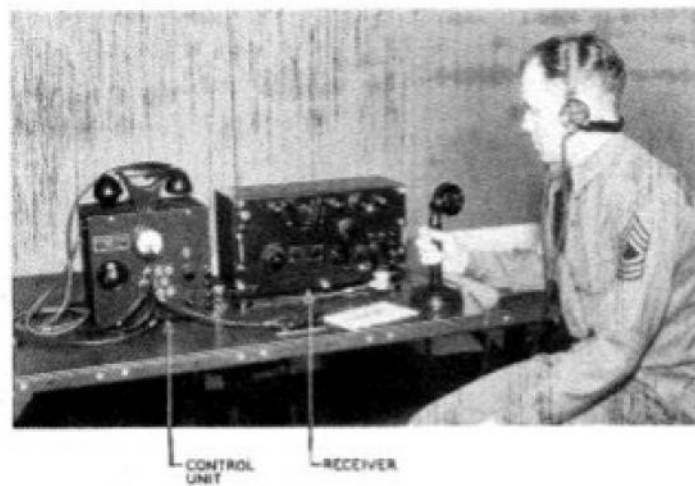
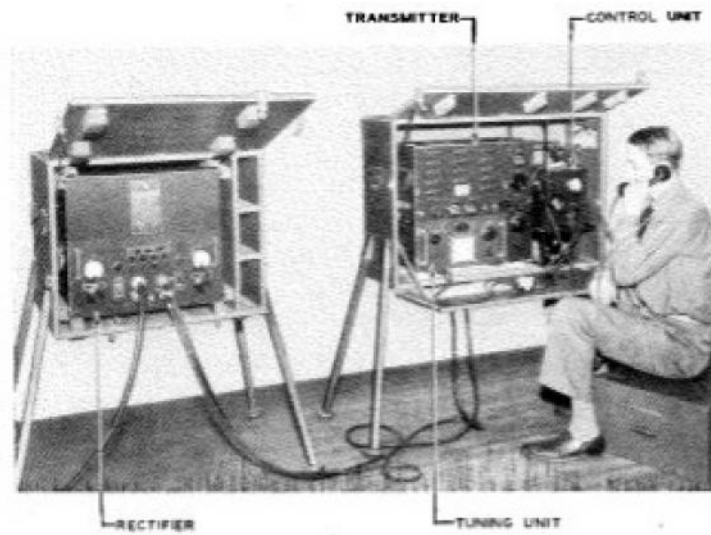

FIGURE 1407. Radio Set SCR-188-A

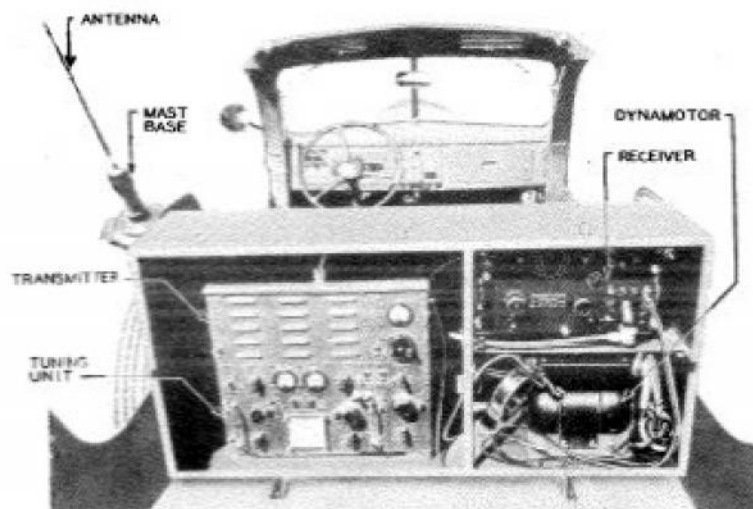

FIGURE 1408. Radio Set SCR-193-()

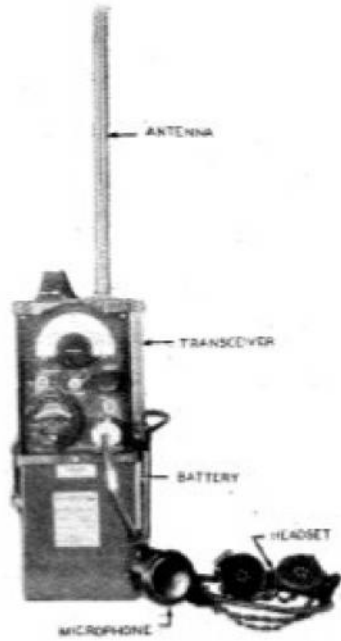

FIGURE 1409. Radio Set SCR-194



FIGURE 1410. Radio Set SCR-195

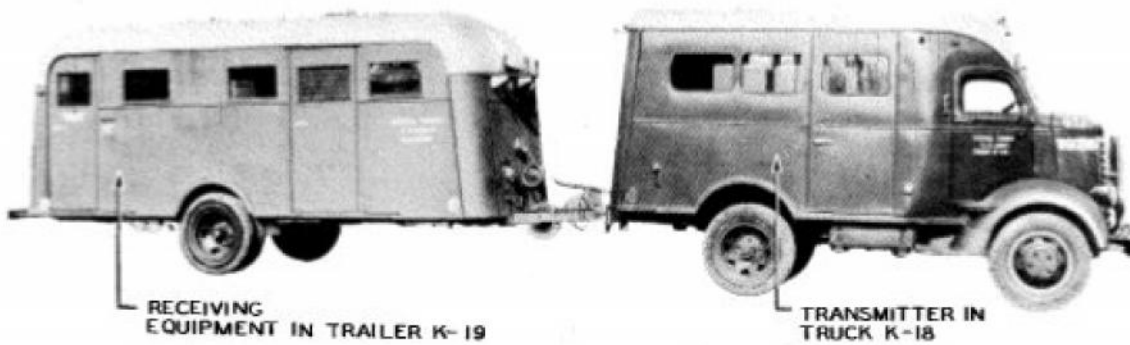

FIGURE 1411. Radio Set SCR-197

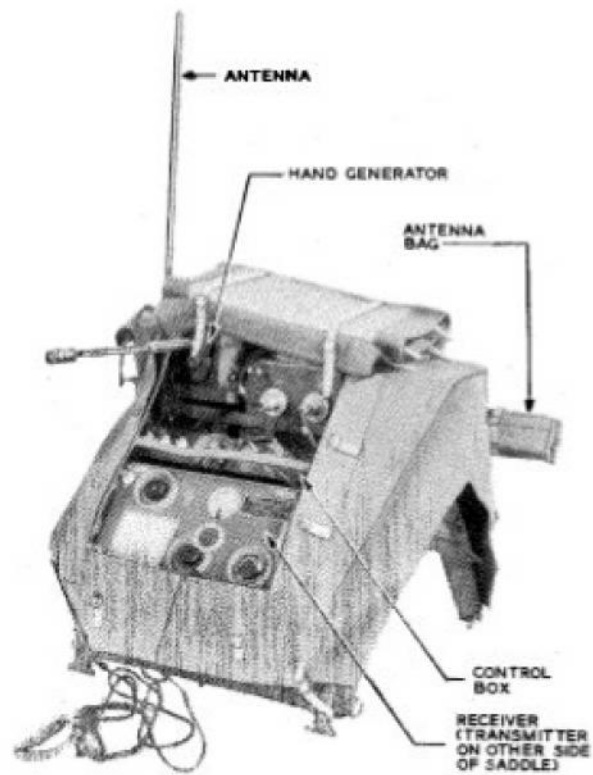

FIGURE 1412. Radio Set SCR-203

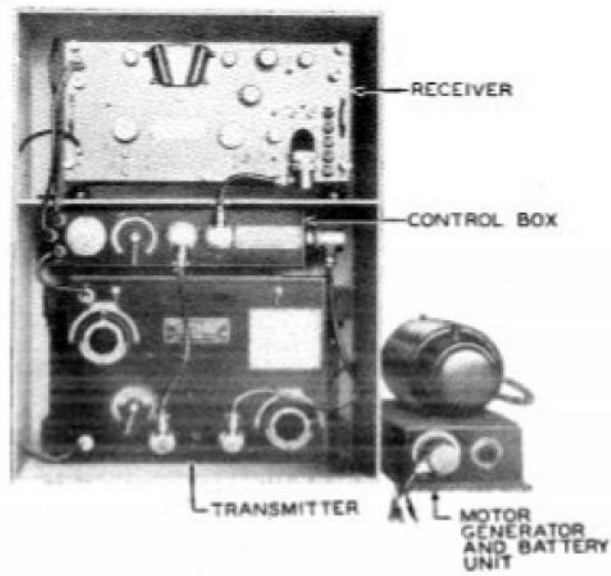

FIGURE 1413. Radio Set SCR-209

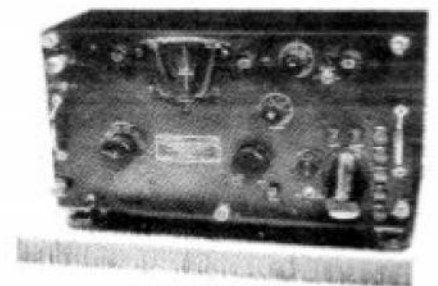

FIGURE 1414. Radio Set SCR-210

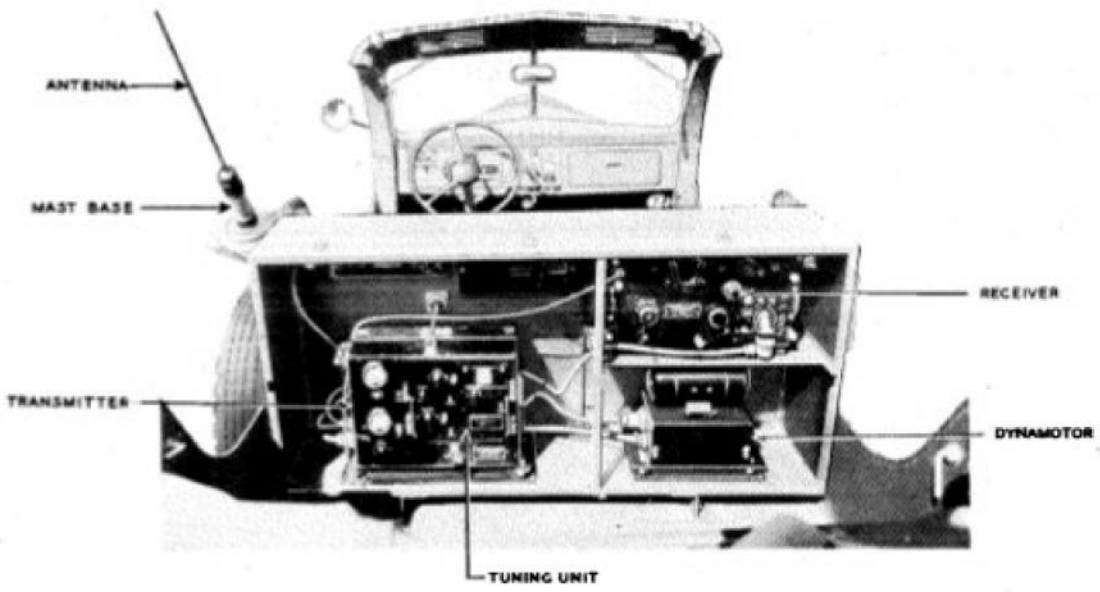

FIGURE 1415. Radio Set SCR-245

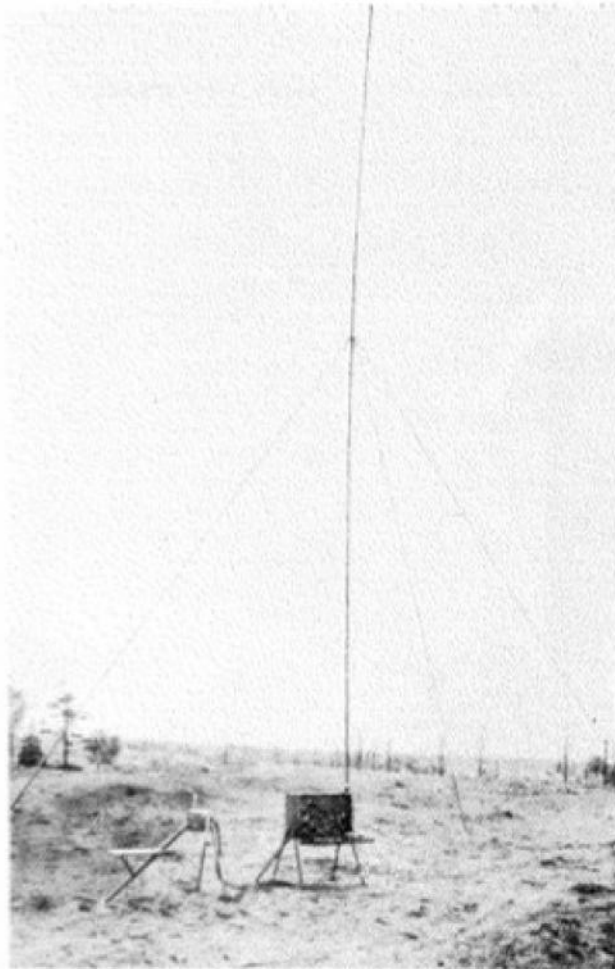

FIGURE 1416. Radio Set SCR-284

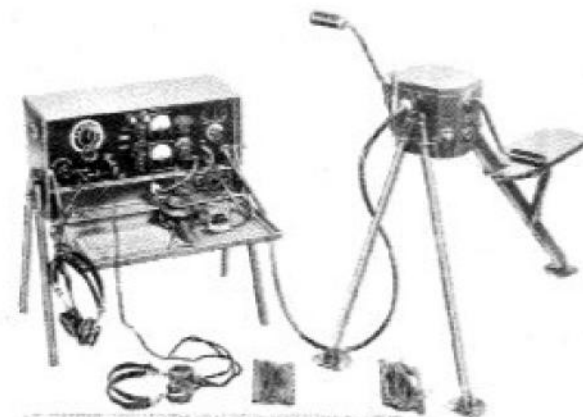

FIGURE 1417. Radio Set SCR-288

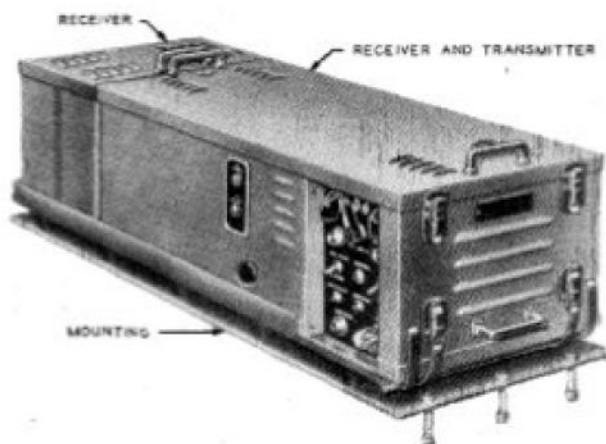

FIGURE 1418. Radio Set SCR-293

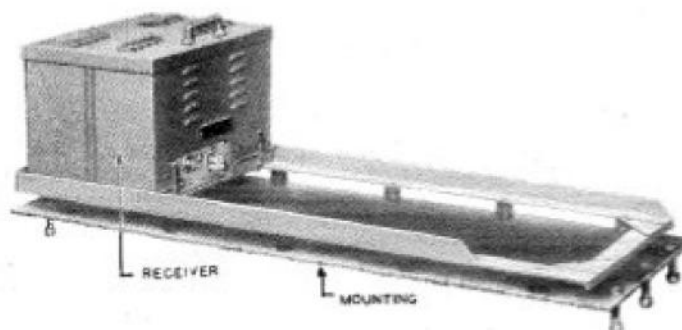

FIGURE 1419. Radio Set SCR-294



FIGURE 1420. Radio Set SCR-298-C

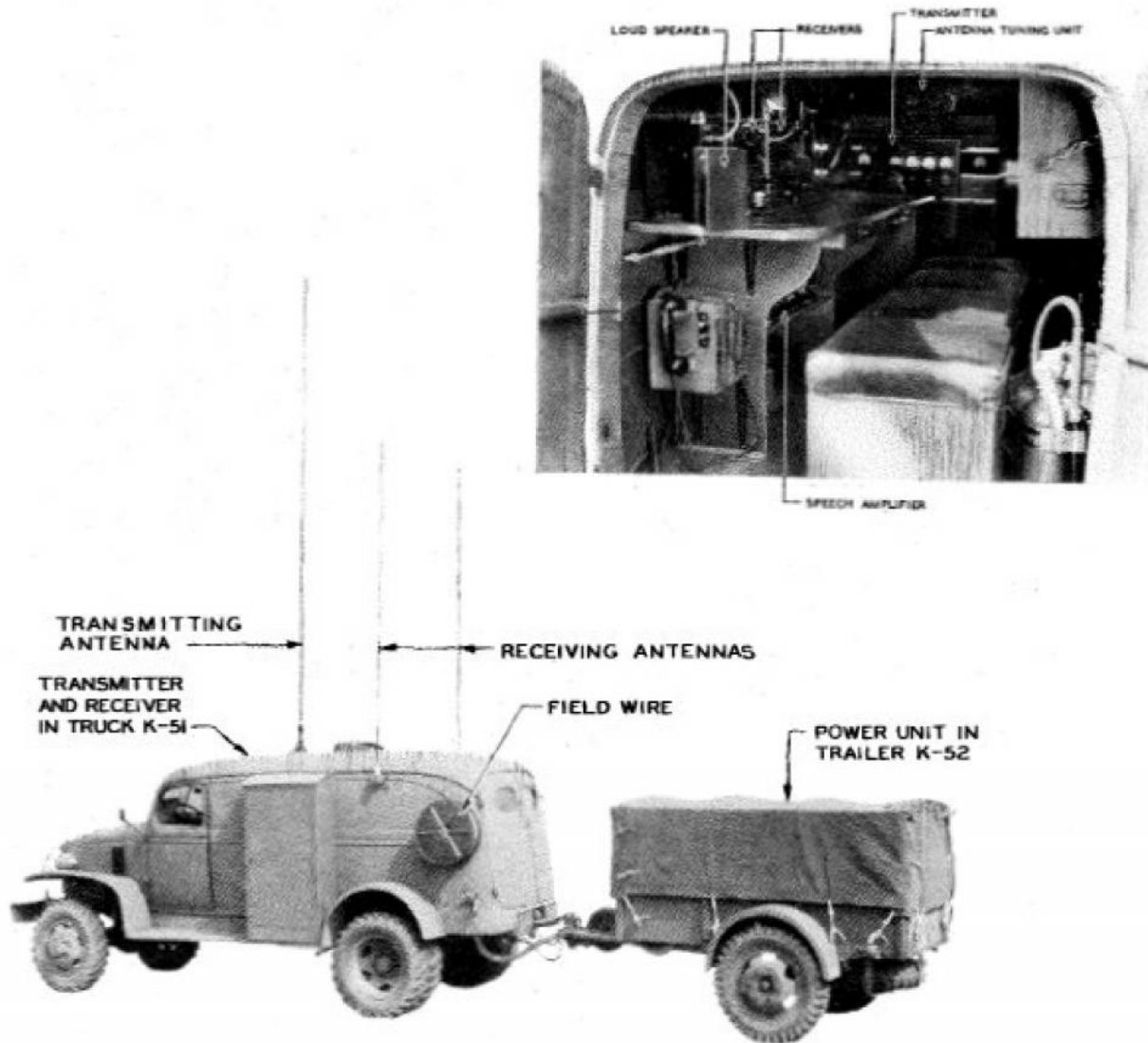

FIGURE 1421. Radio Set SCR-299

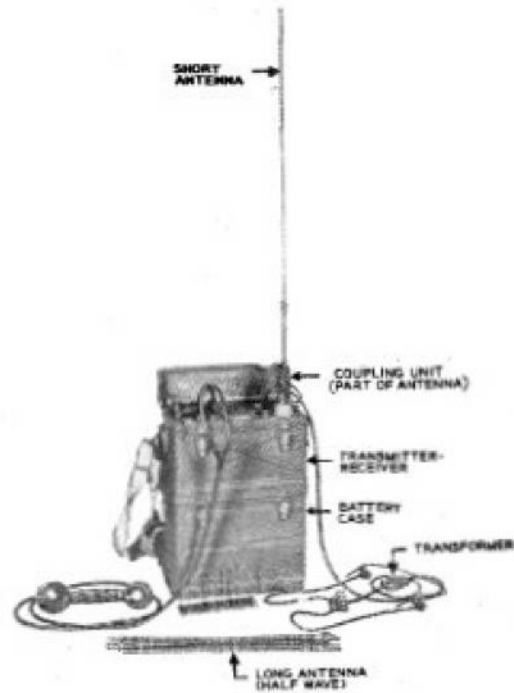

FIGURE 1422. Radio Set SCR-300

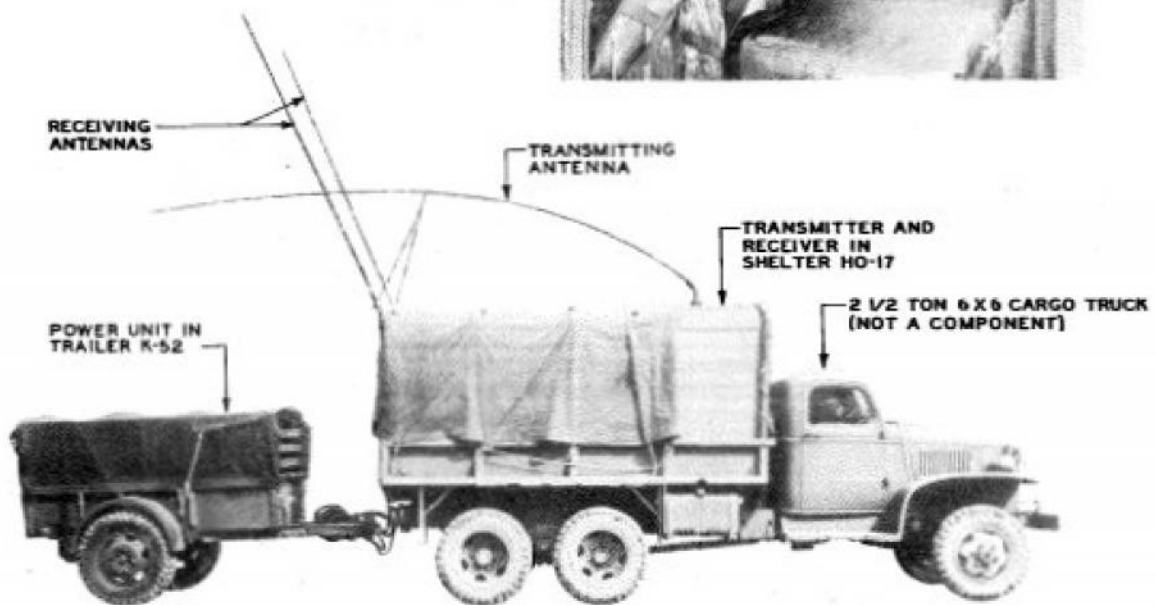
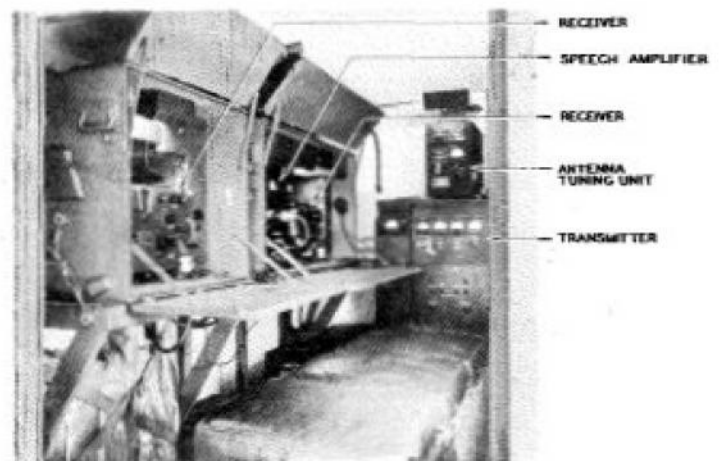

FIGURE 1423. Radio Set SCR-399

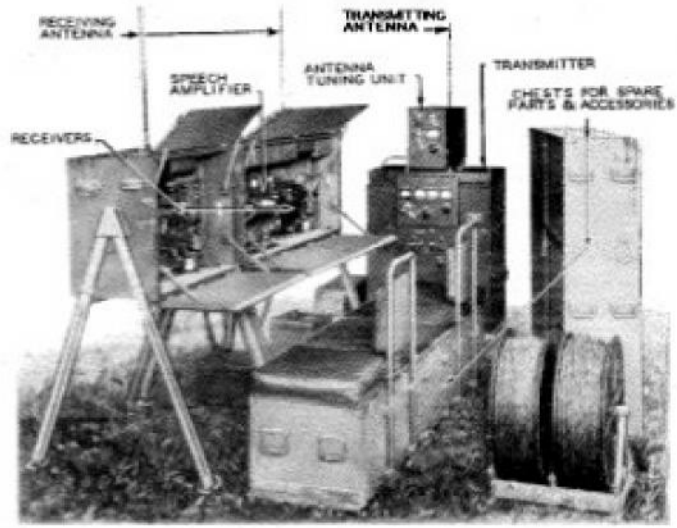

FIGURE 1424. Radio Set SCR-499

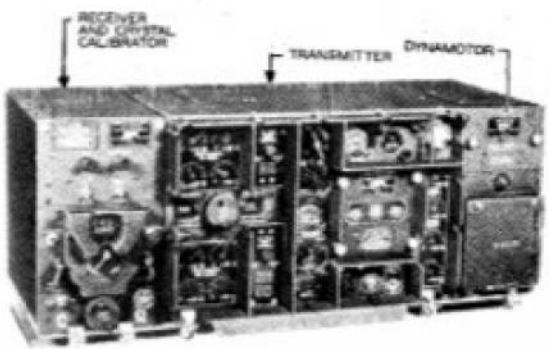

FIGURE 1425. Radio Set SCR-506

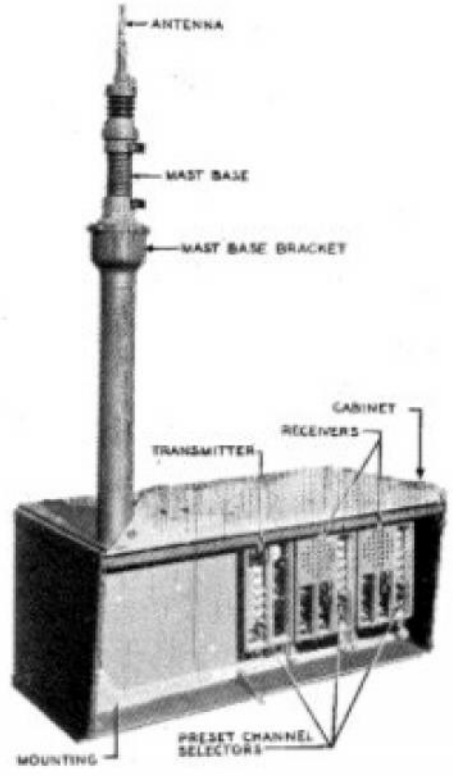

FIGURE 1426. Radio Set SCR-508

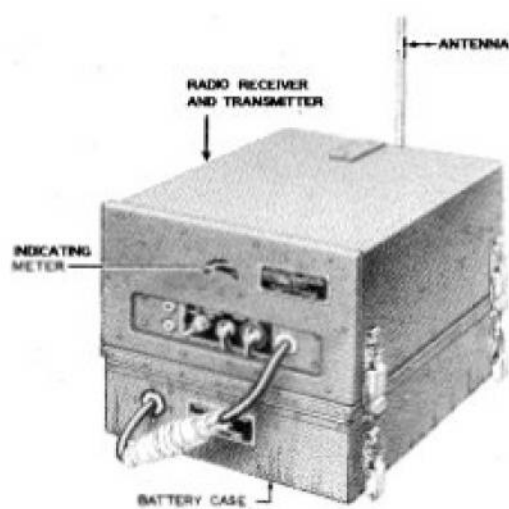

FIGURE 1427. Radio Set SCR-509

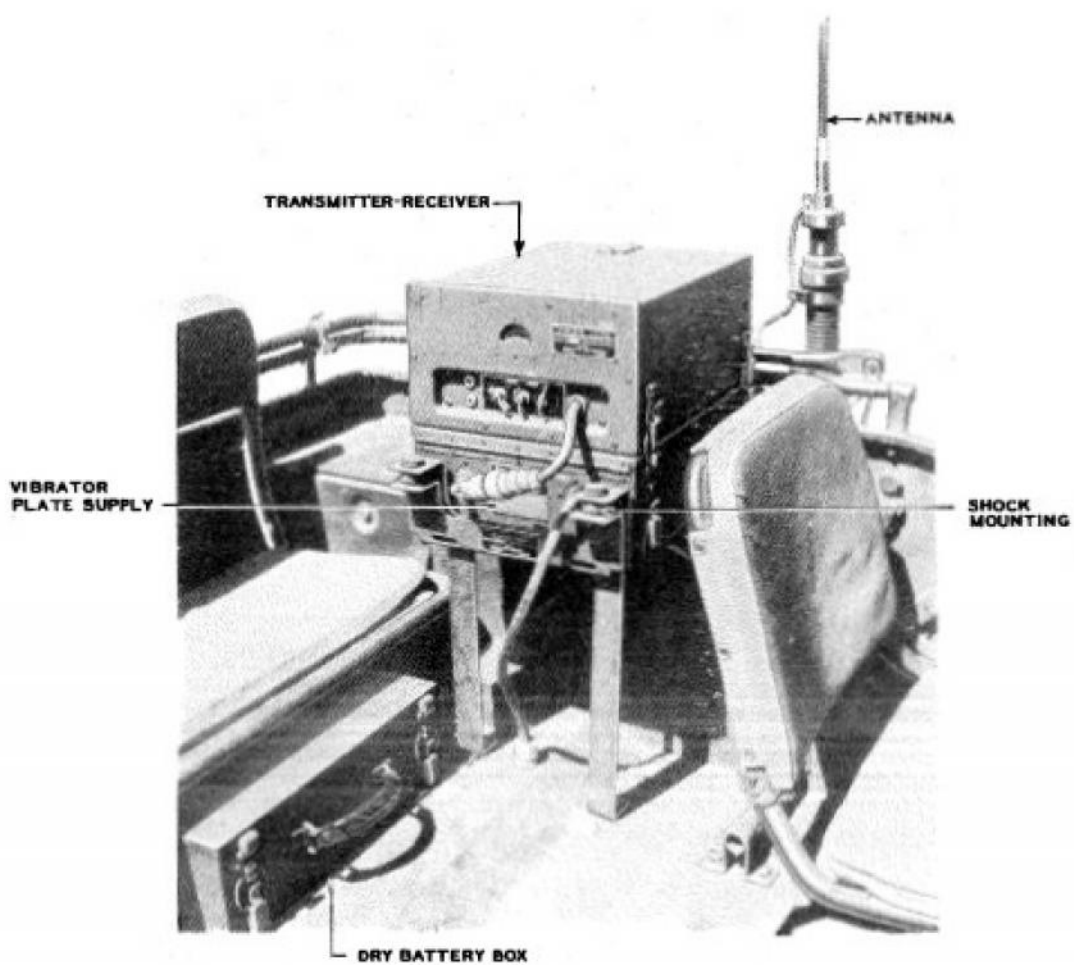

FIGURE 1428. Radio Set SCR-510



FIGURE 1429. Radio Set SCR-511

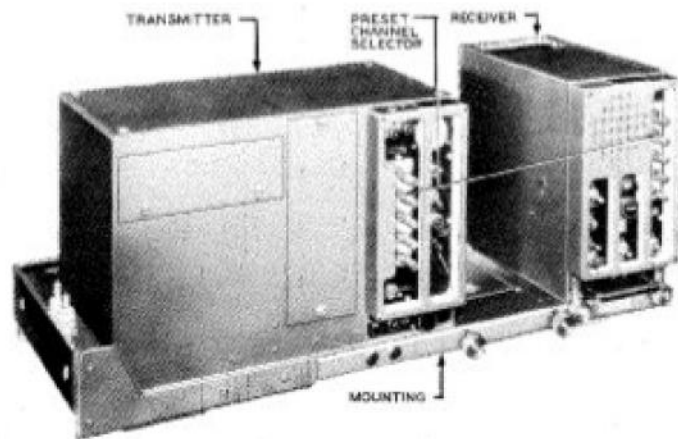

FIGURE 1430. Radio Set SCR-528

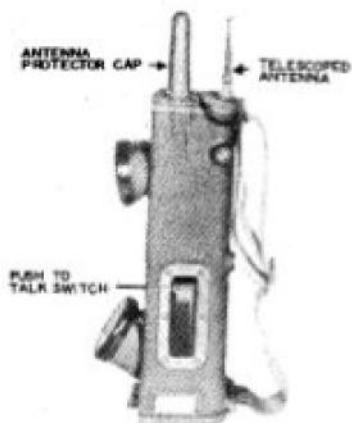

FIGURE 1431. Radio Set SCR-536

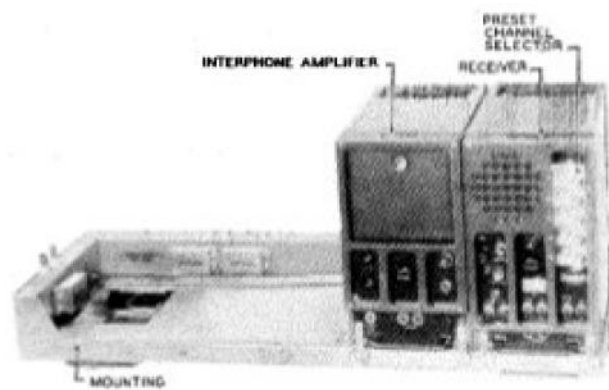

FIGURE 1432. Radio Set SCR-538

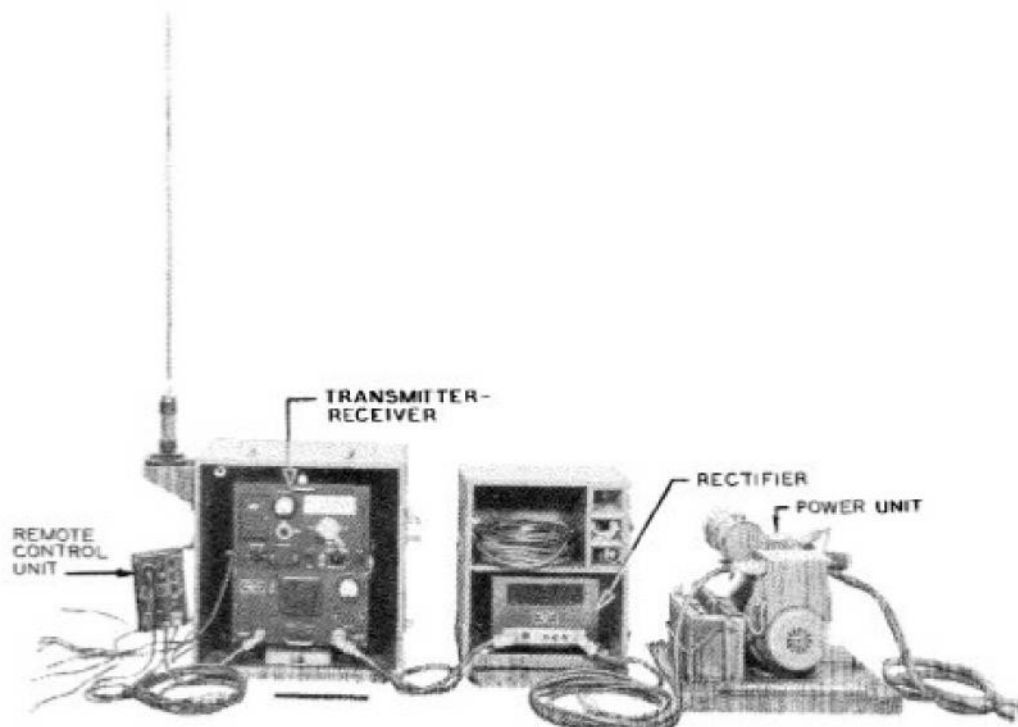

FIGURE 1433. Radio Set SCR-543

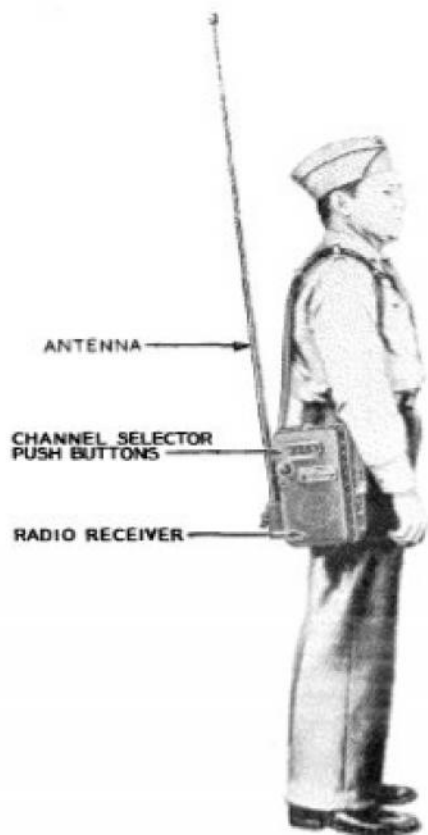

FIGURE 1434. Radio Set SCR-593

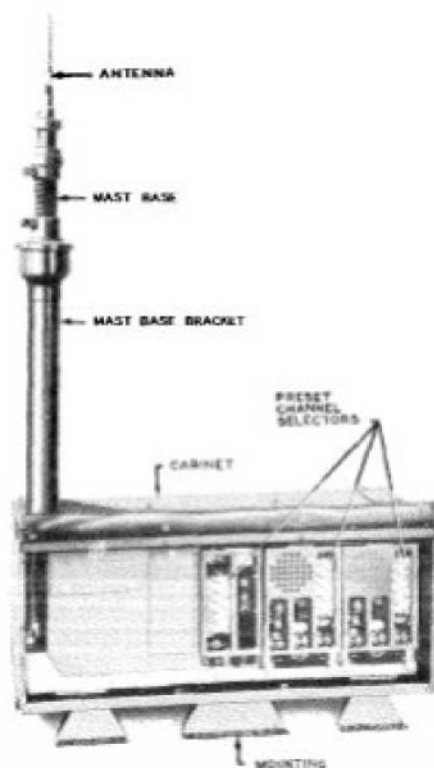

FIGURE 1435. Radio Set SCR-608

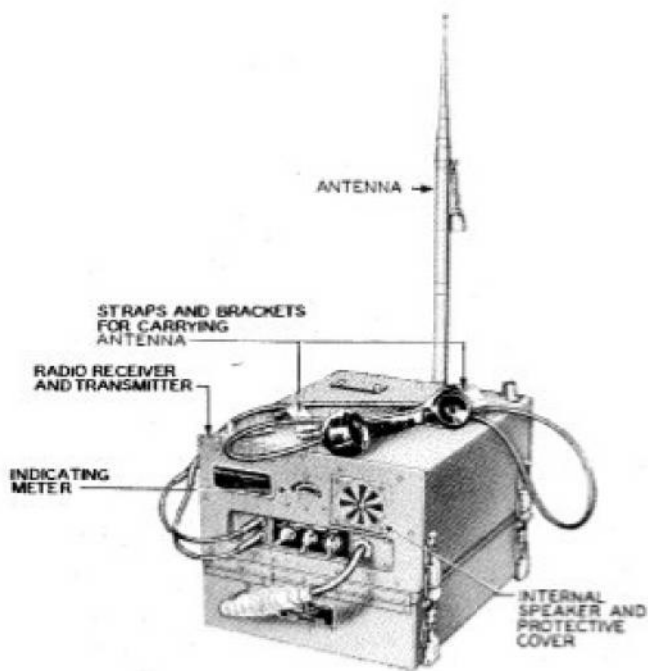

FIGURE 1436. Radio Set SCR-609

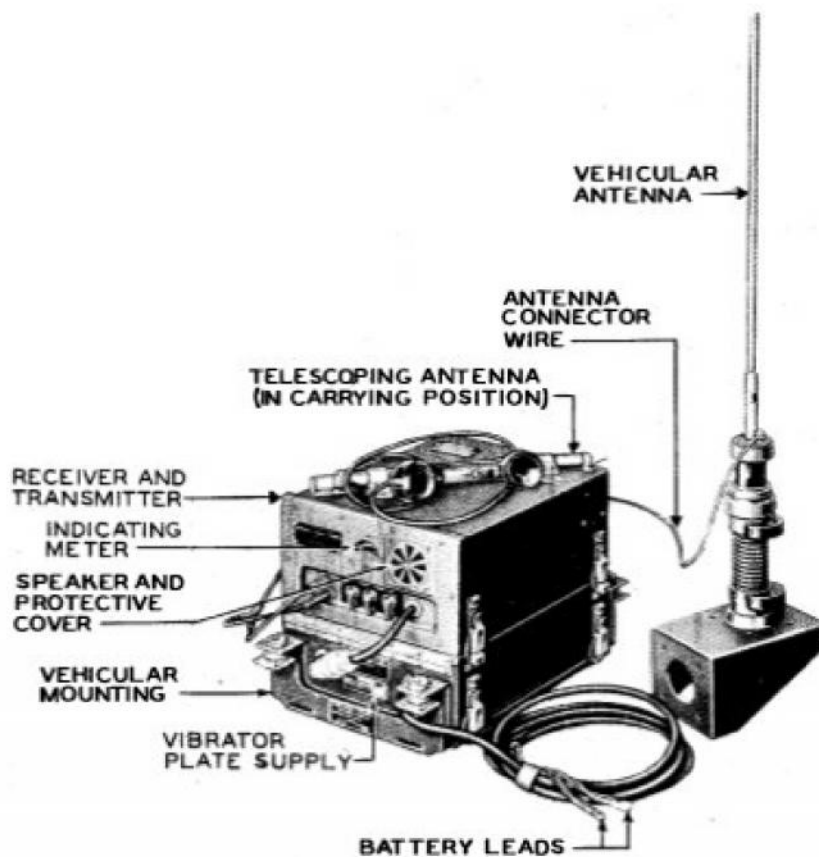

FIGURE 1437. Radio Set SCR-610

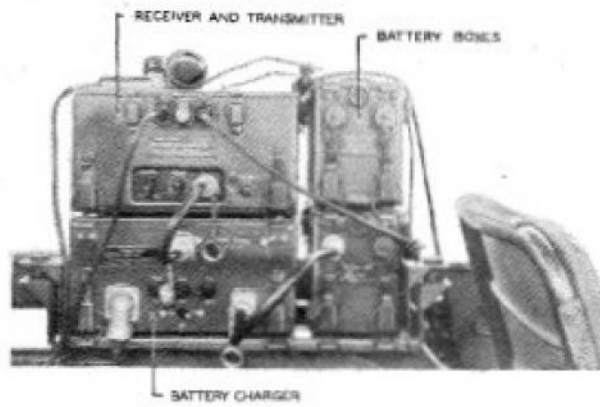

FIGURE 1438. Radio Set SCR-619

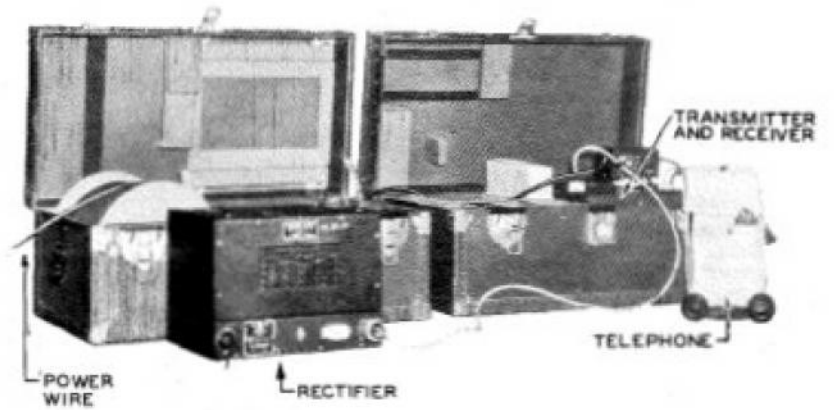

FIGURE 1439. Radio Set SCR-624

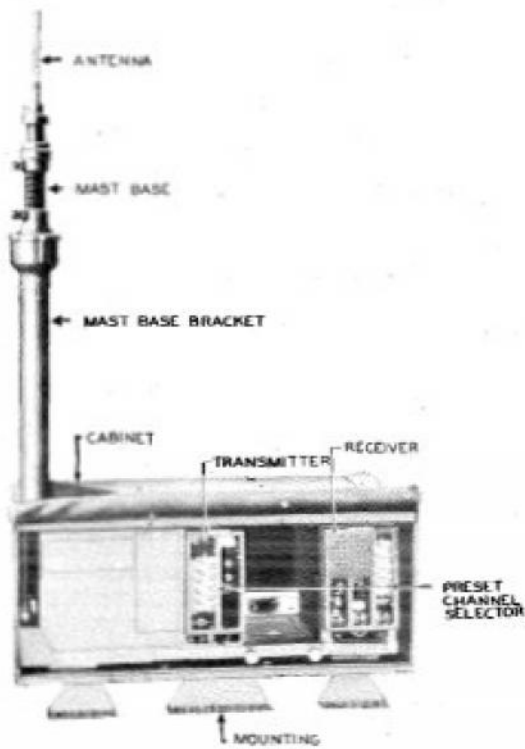

FIGURE 1440. Radio Set SCR-628

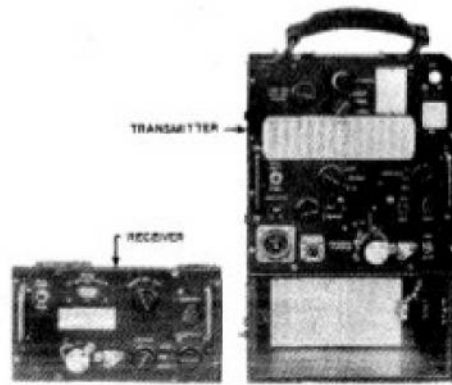

FIGURE 1441. Radio Set SCR-694-AW
(Receiver removed from case)

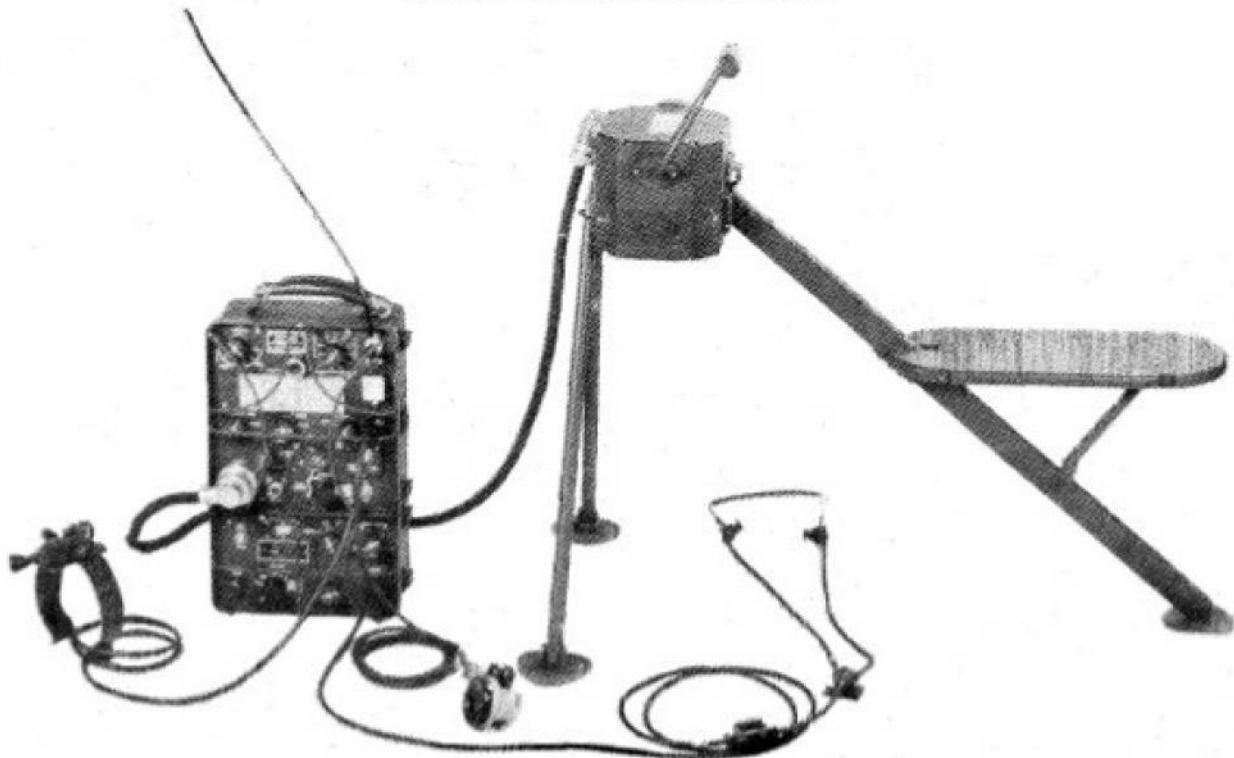

FIGURE 1442. Radio Set SCR-694-C

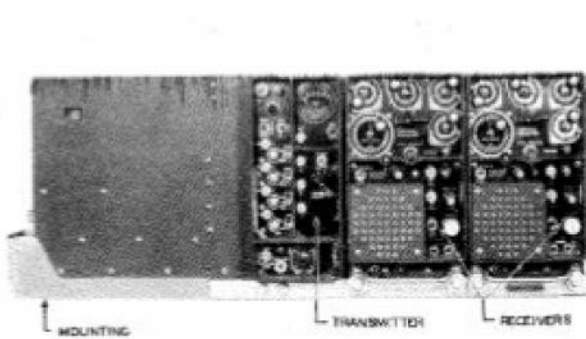

FIGURE 1443. Radio Set SCR-808

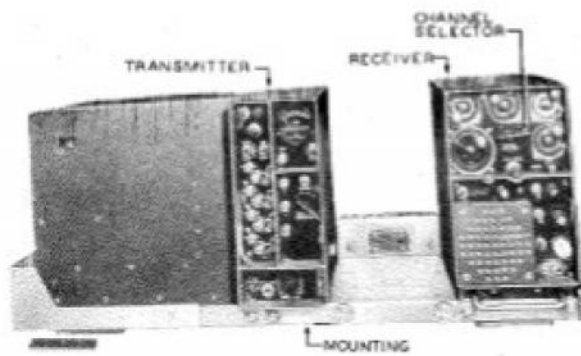

FIGURE 1444. Radio Set SCR-828

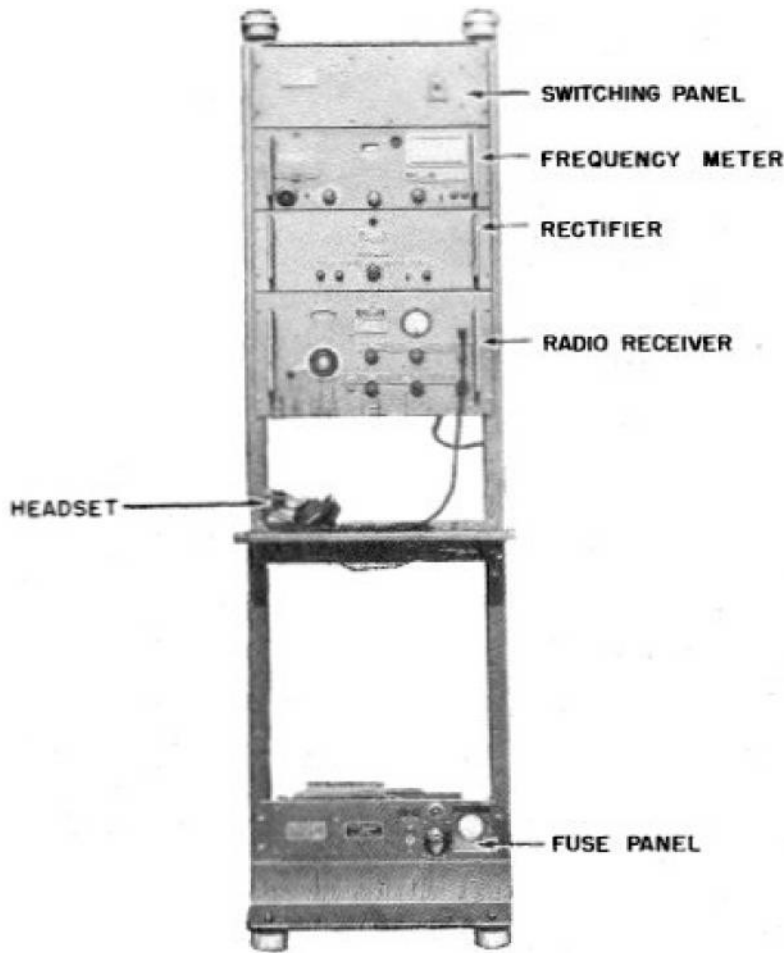

FIGURE 1445. Receiving Equipment RC-256

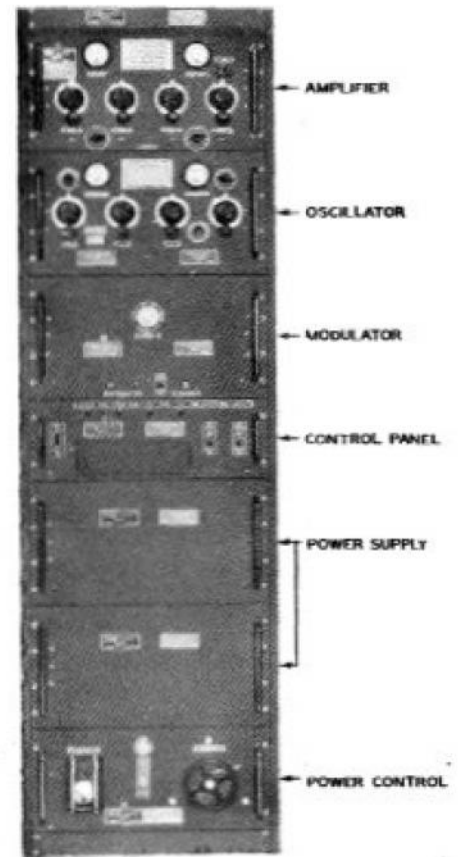

FIGURE 1446. Radio Transmitter RC-257

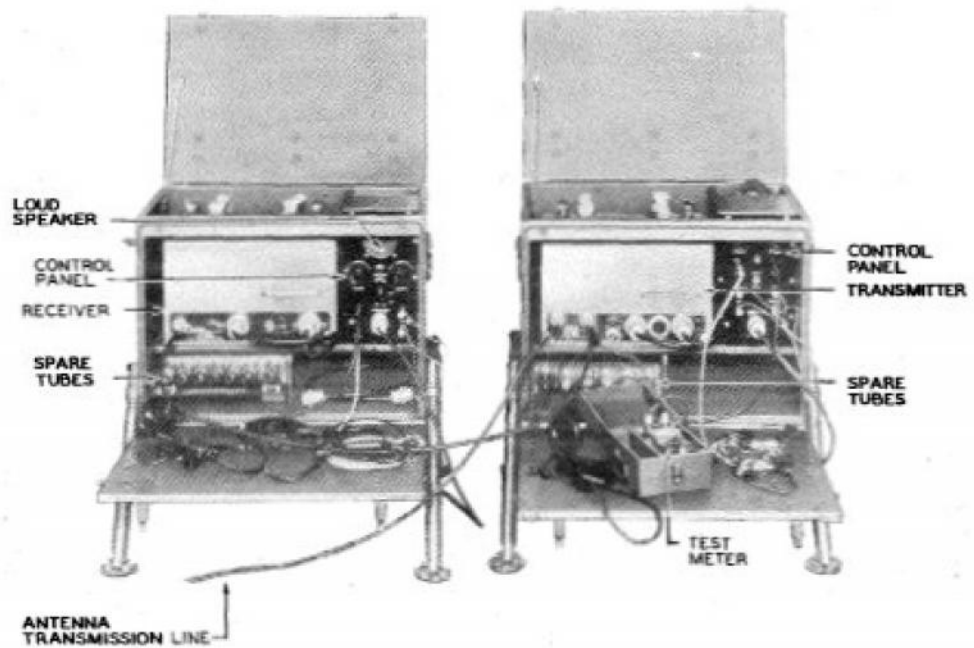

FIGURE 1447. Radio Set AN/CRC-3

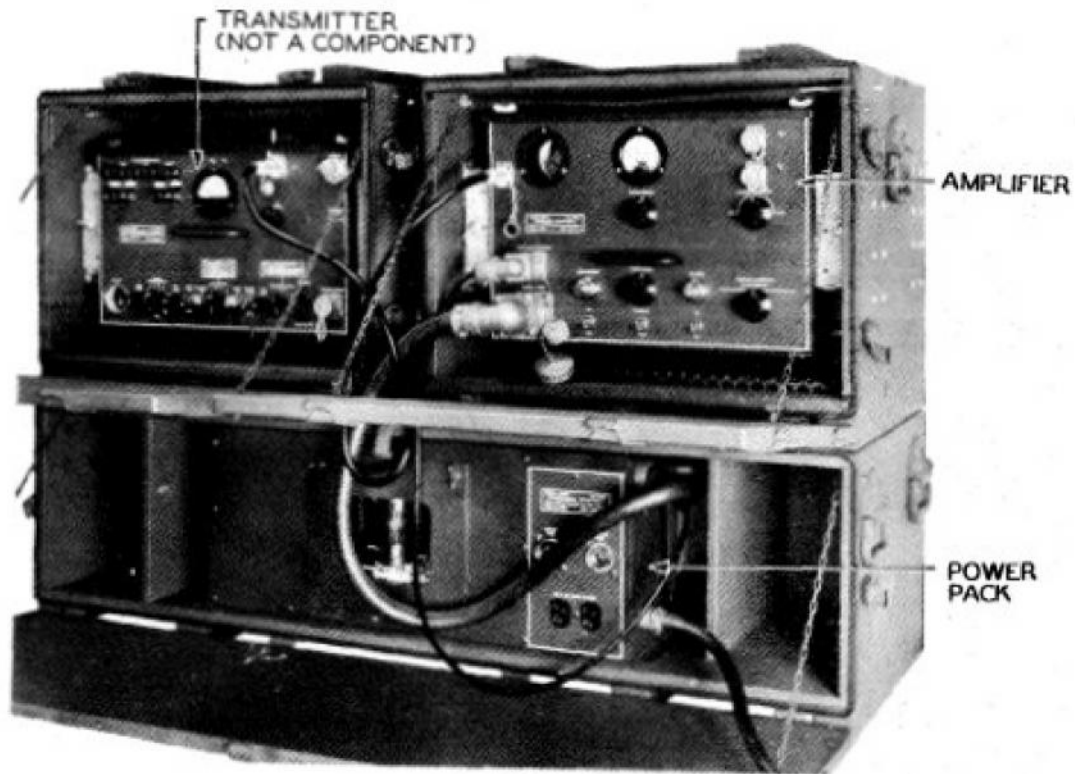

FIGURE 1448. Amplifier Equipment AN/TRA-1

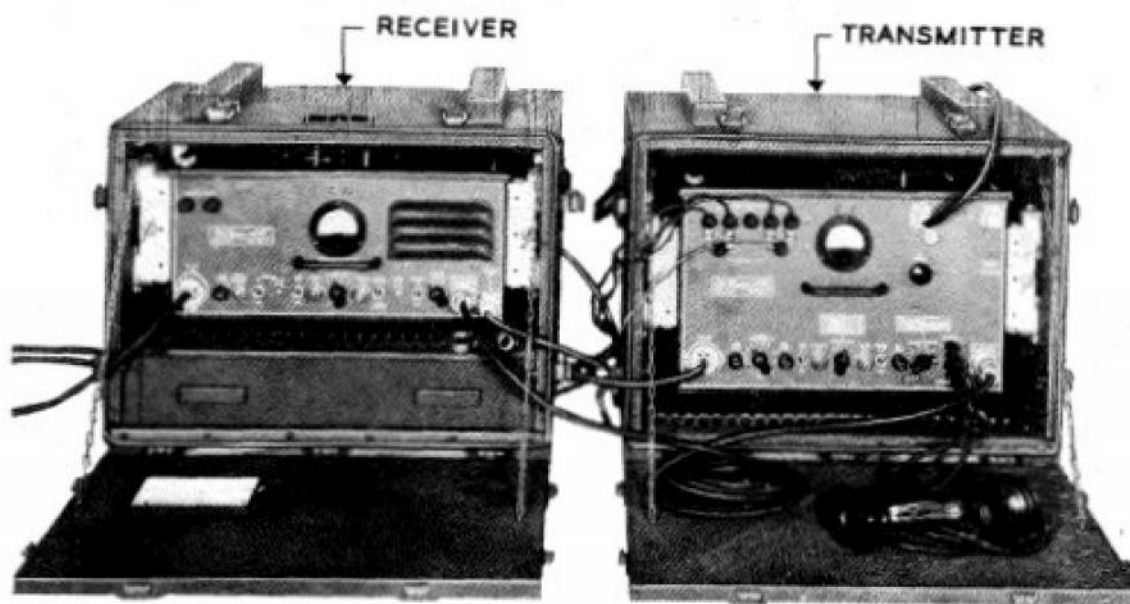
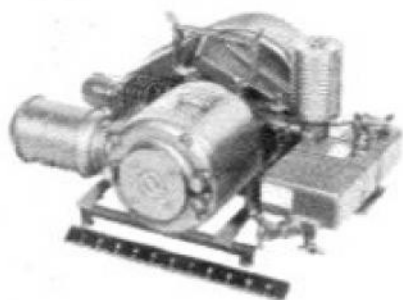
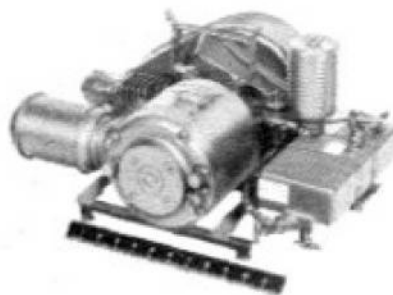

FIGURE 1449. Radio Set AN/TRC-1



Power Unit PE-162



Power Unit PE-162



Receiver and Transmitter RT-12/TRC-2

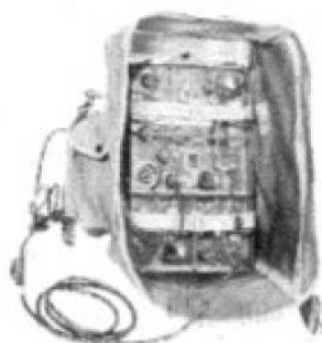

Receiver and Transmitter BC-1306

FIGURE 1450. Radio Set AN/TRC-2

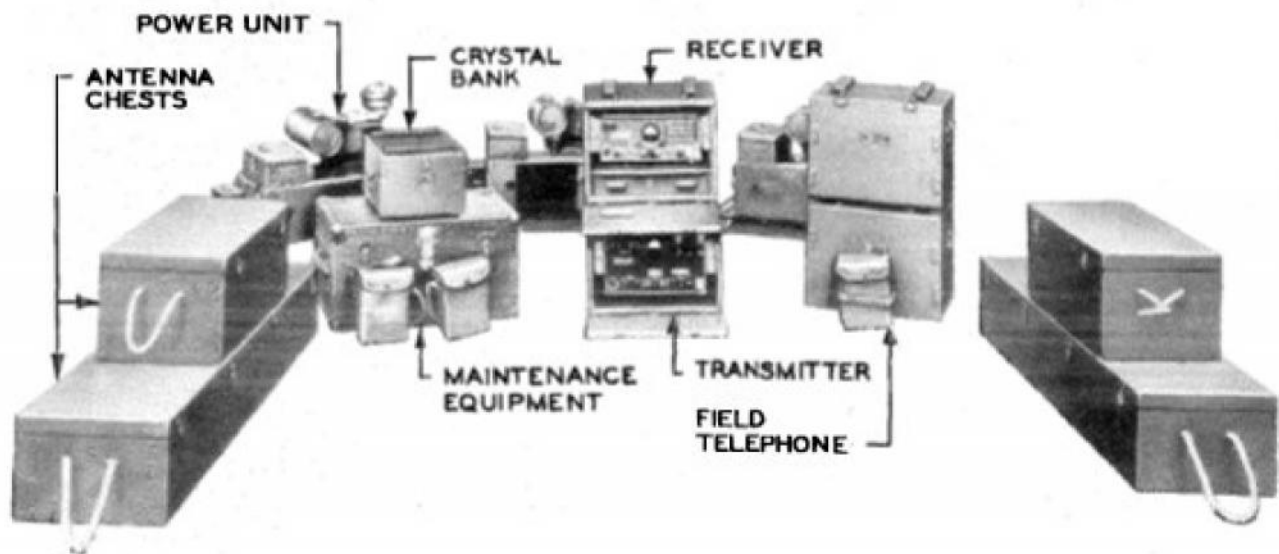

FIGURE 1451. Radio Terminal Set AN/TRC-3

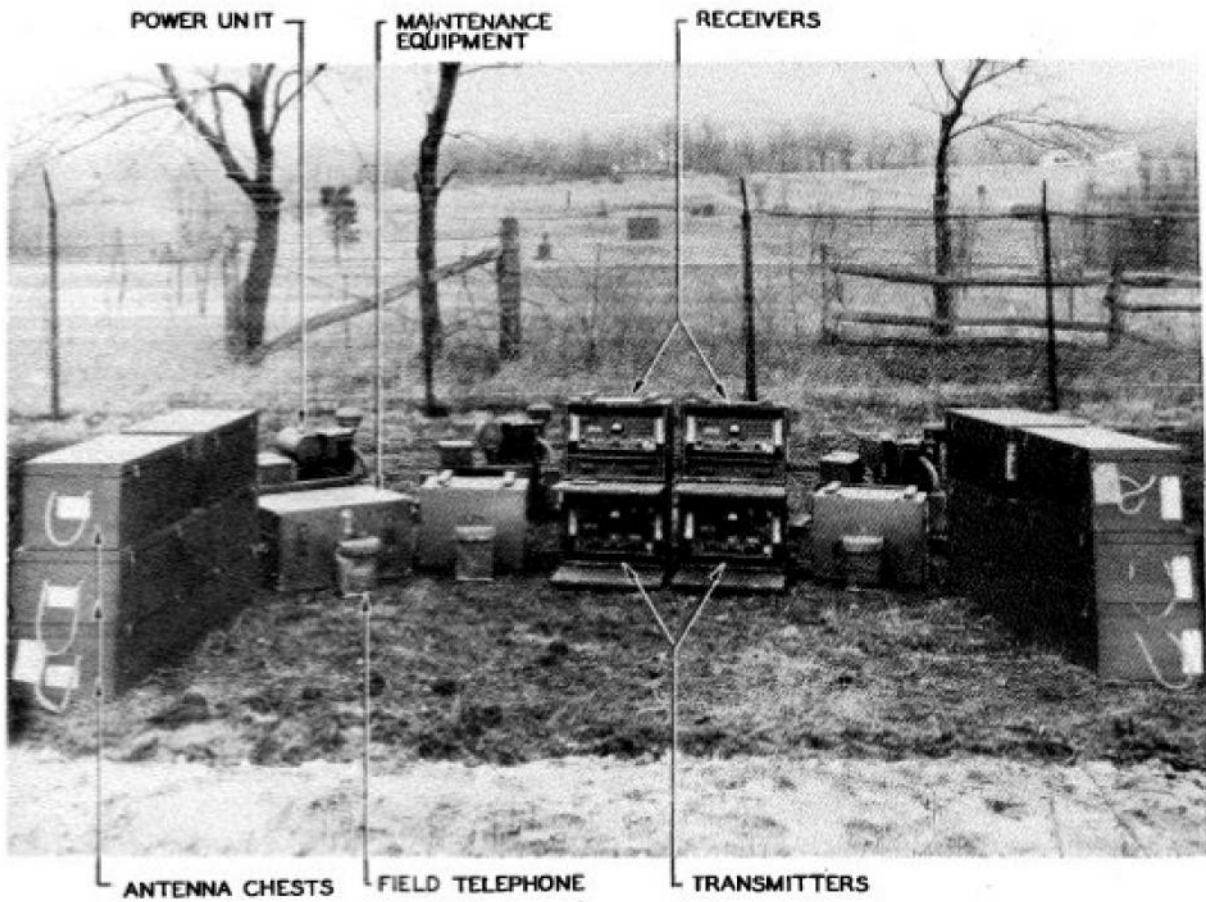

FIGURE 1452. Radio Relay Set AN/TRC-4

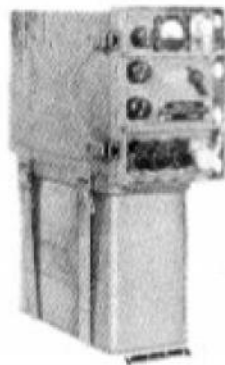
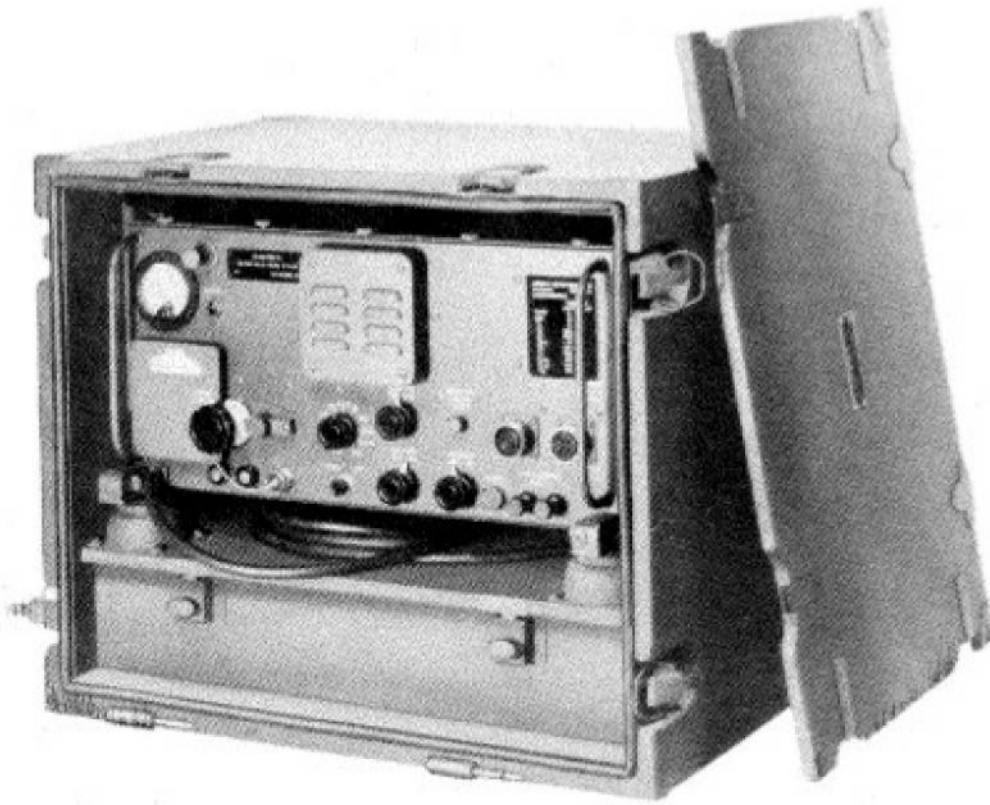
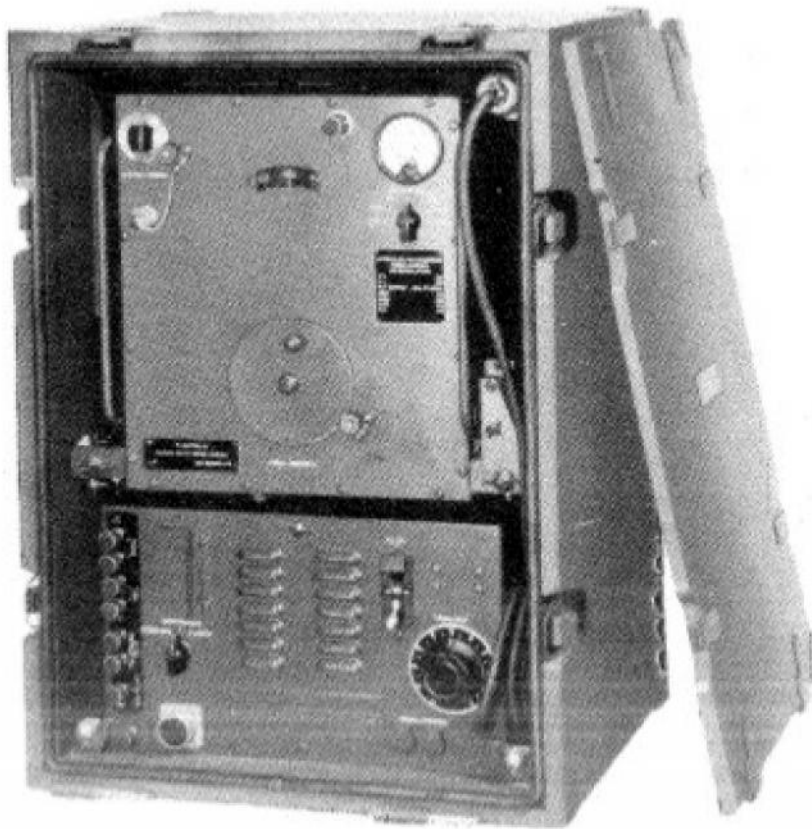

FIGURE 1453. Radio Set AN/TRC-7



Receiver



Transmitter

FIGURE 1454. Radio Set AN/TRC-8

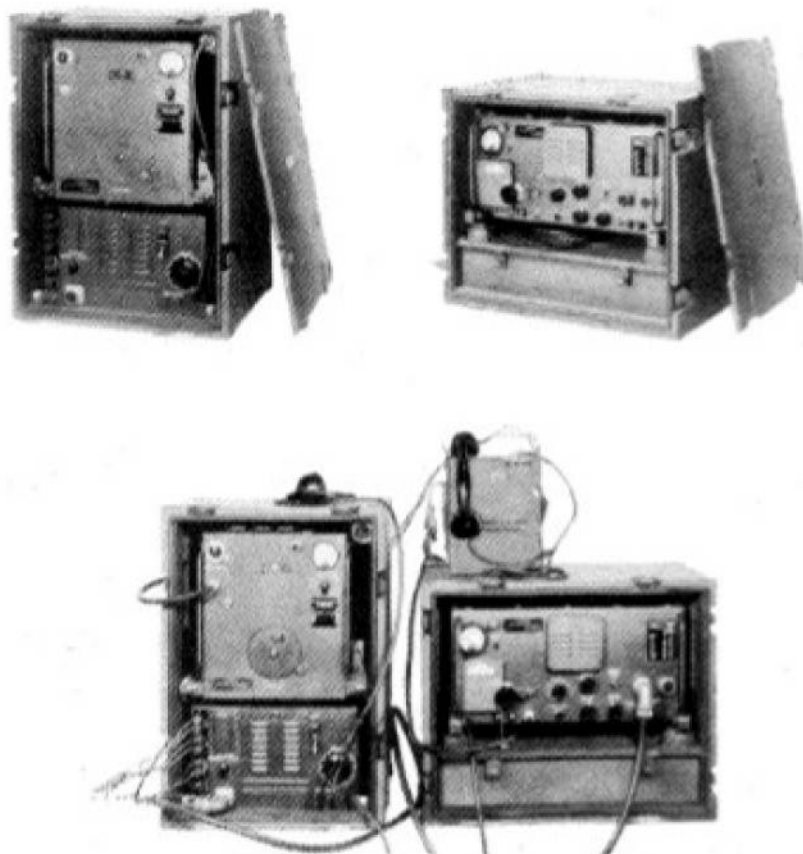

FIGURE 1455. Radio Terminal Set AN/TRC-11

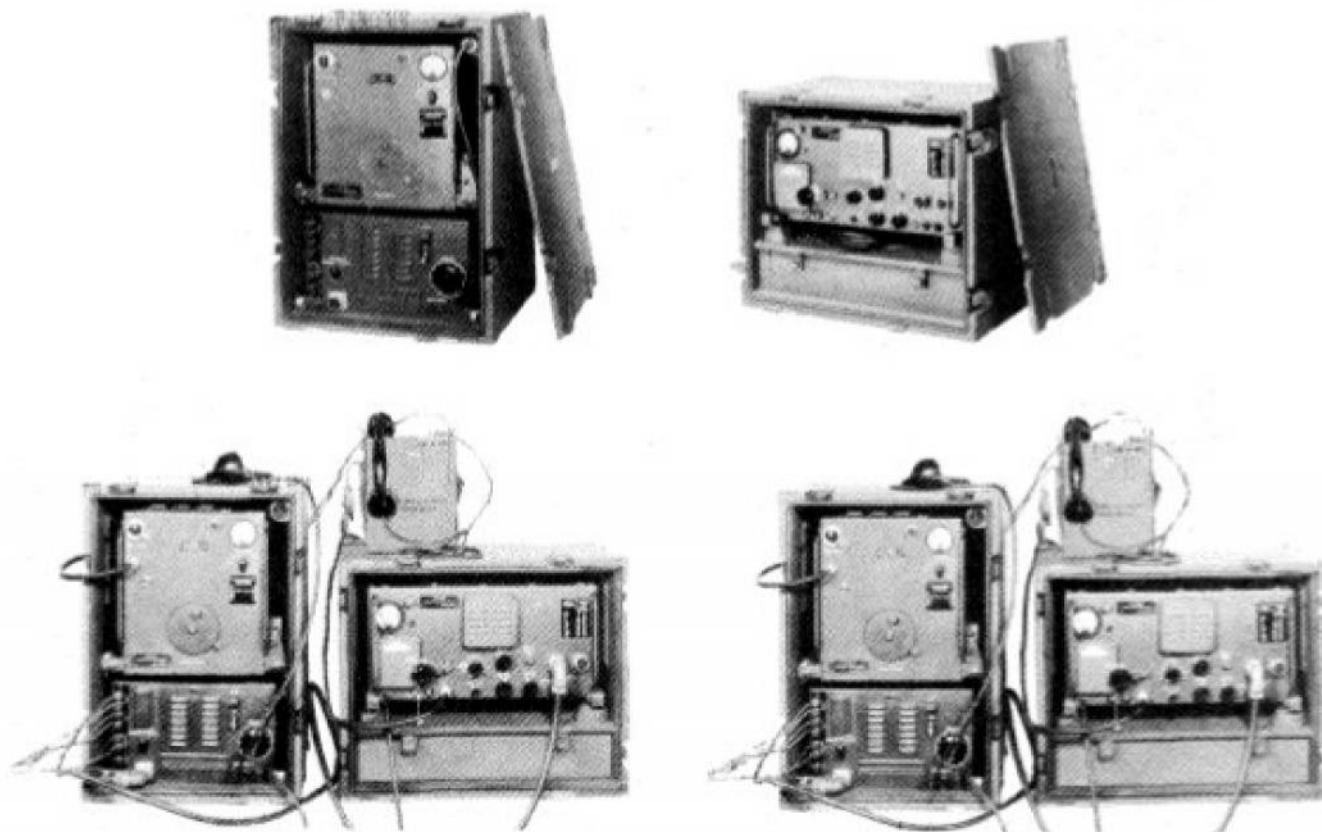

FIGURE 1456. Radio Set AN/TRC-12

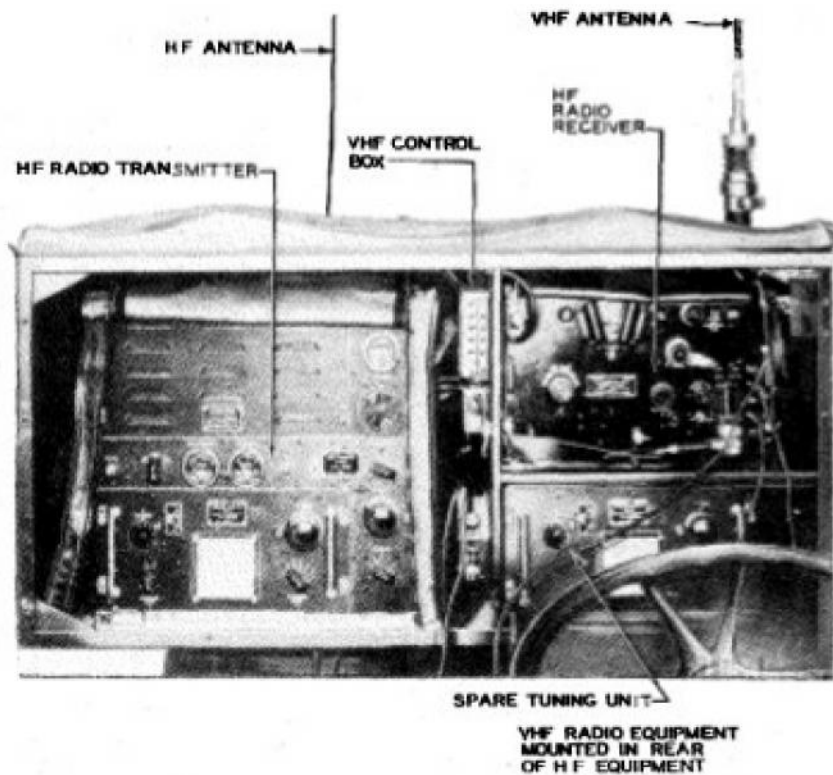

FIGURE 1457. Radio Set AN/VRC-1

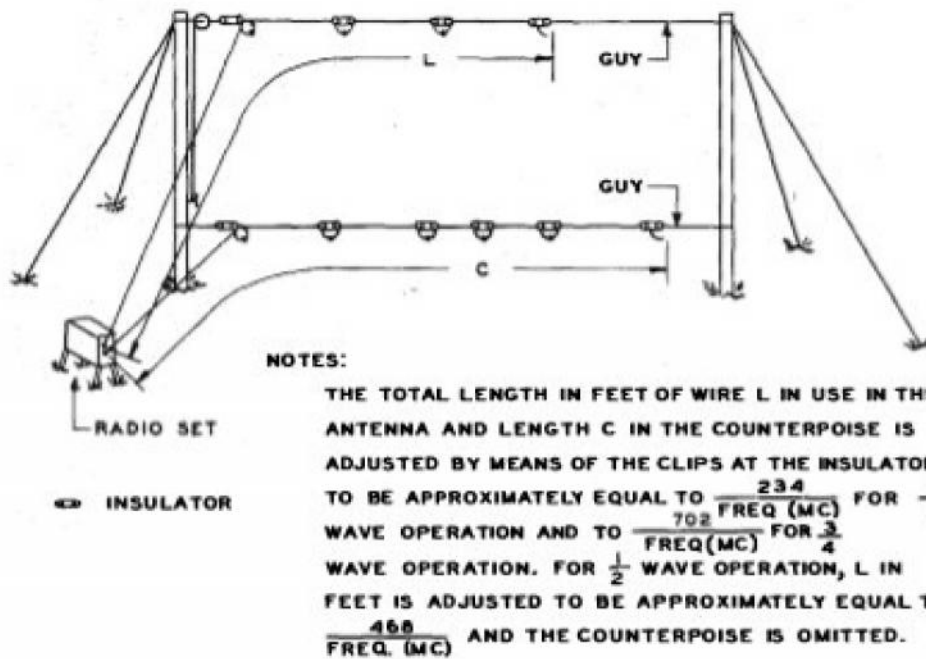

FIGURE 1458. Inverted L Antenna

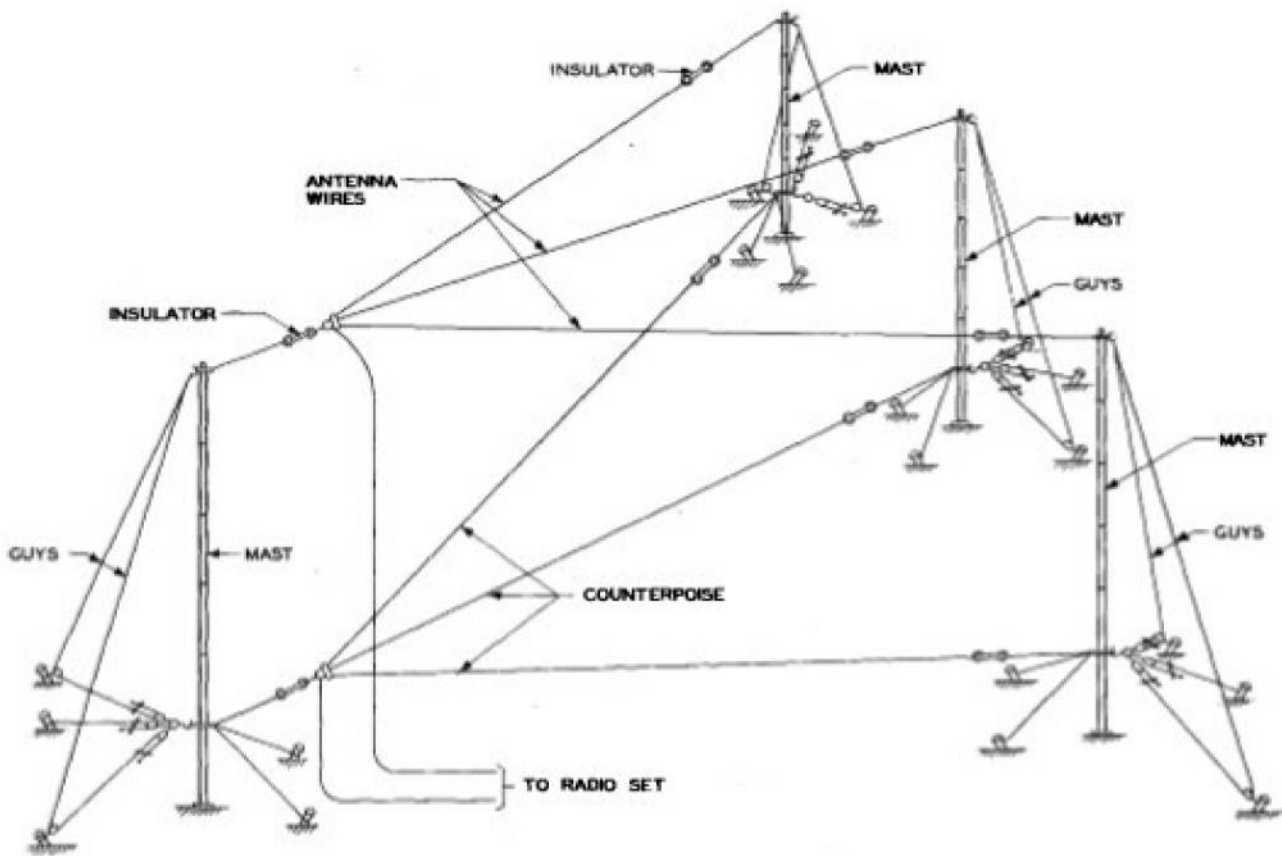

FIGURE 1459. Crowfoot Antenna

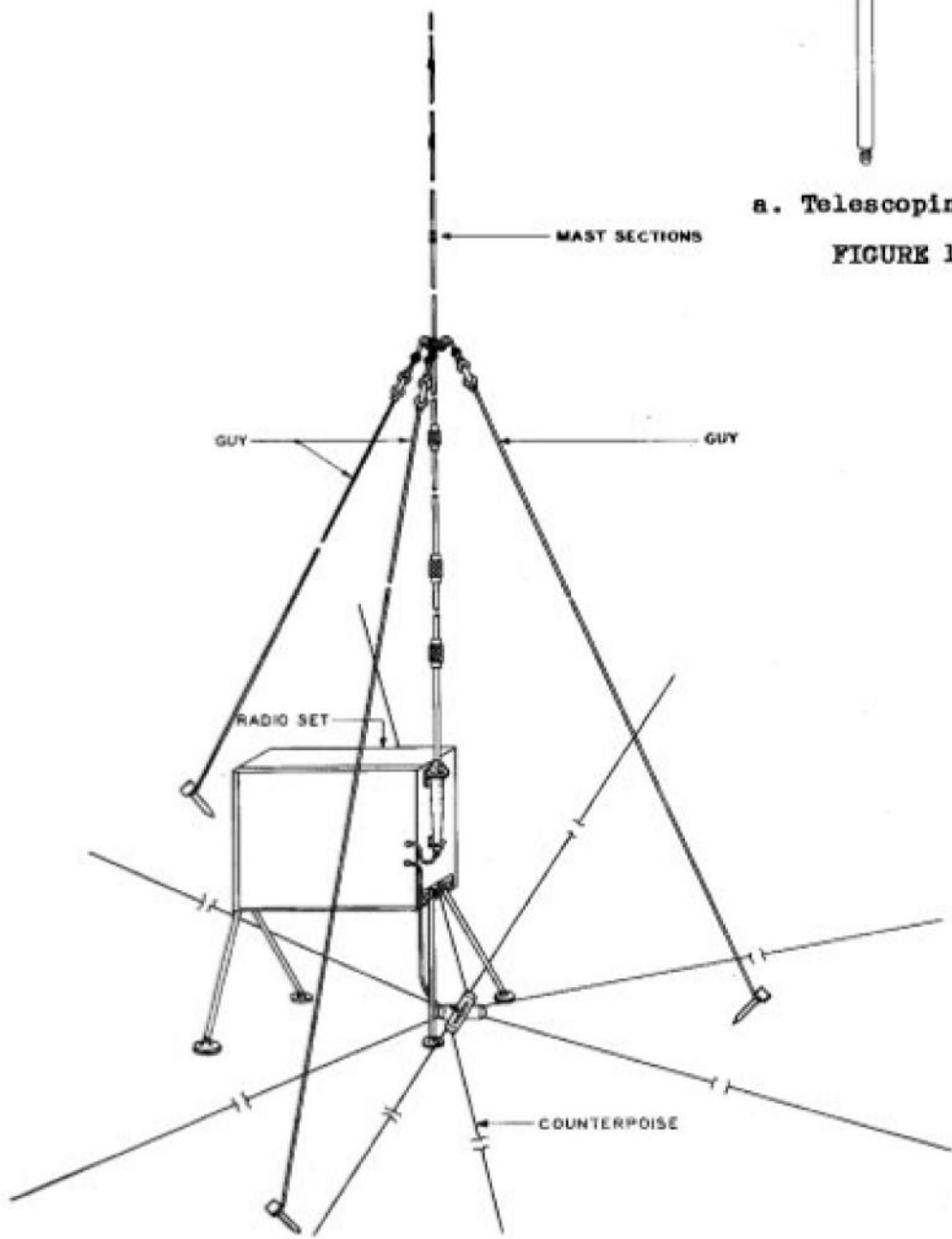

FIGURE 1460. Whip Antenna and Counterpoise

a. Telescoping



b. Sectionalized

FIGURE 1461. Whip Antennas



FIGURE 1462. Short Whip Antenna

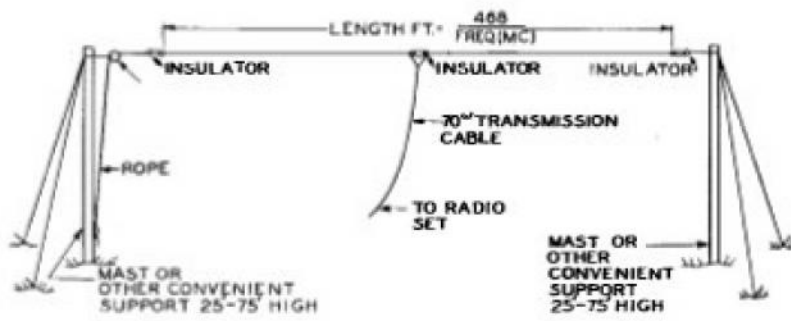

FIGURE 1463. Center-fed Horizontal Dipole Antenna

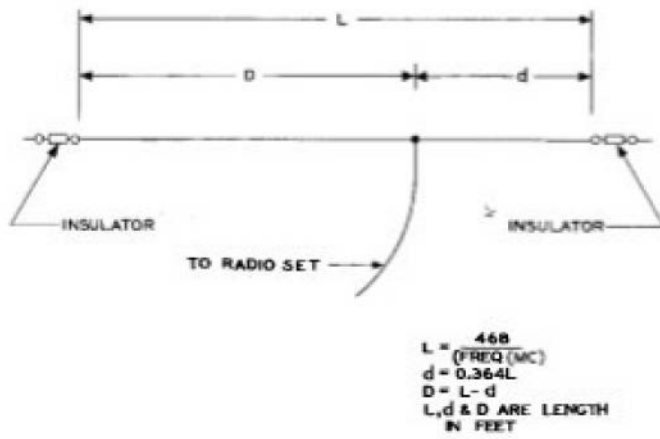

FIGURE 1464. Single Wire Fed Half-wave Antenna

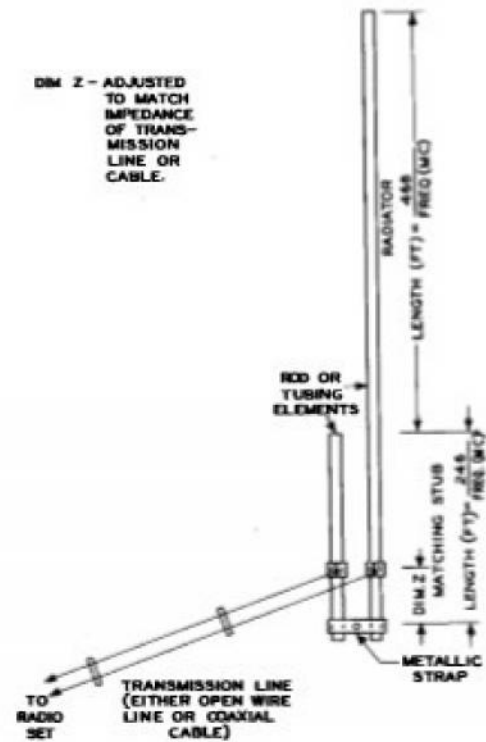

FIGURE 1465. Half-wave J Antenna

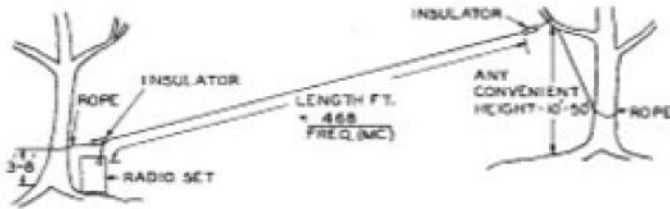
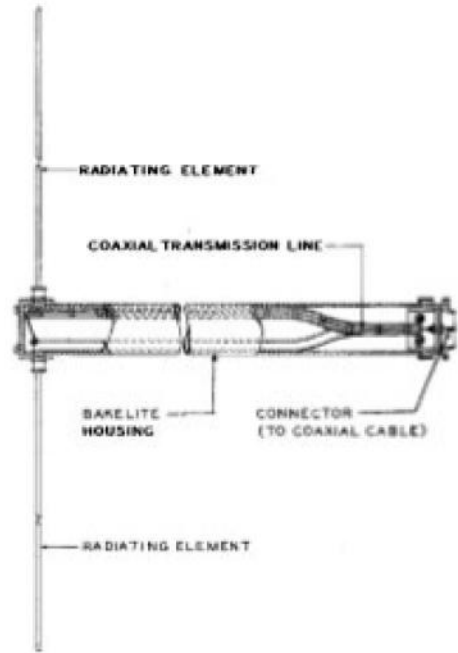
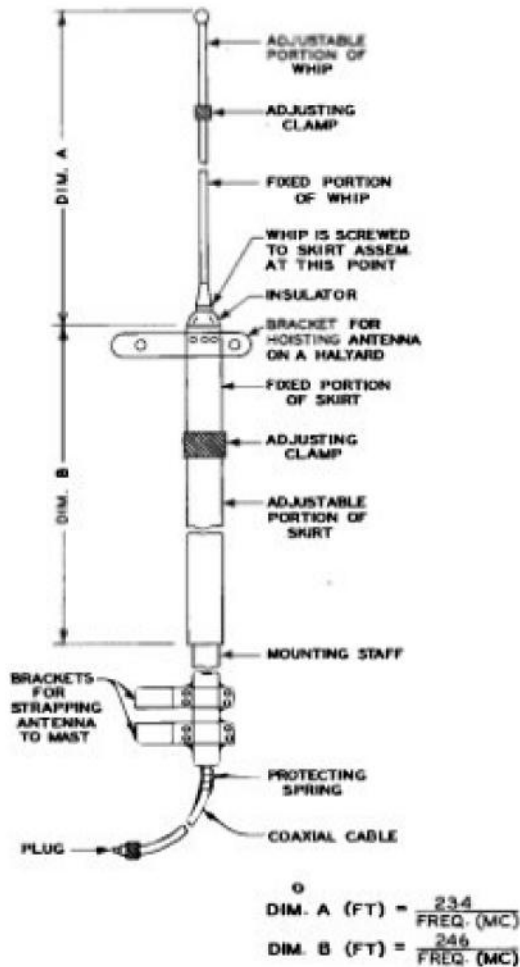

FIGURE 1466. Sloping Wire Antenna



FIGURES 1467. Balanced Half-wave Dipole Antenna



$$\text{DIM. A (FT)} = \frac{234}{\text{FREQ. (MC)}}$$

$$\text{DIM. B (FT)} = \frac{246}{\text{FREQ. (MC)}}$$

FIGURE 1468. Adjustable Coaxial Antenna

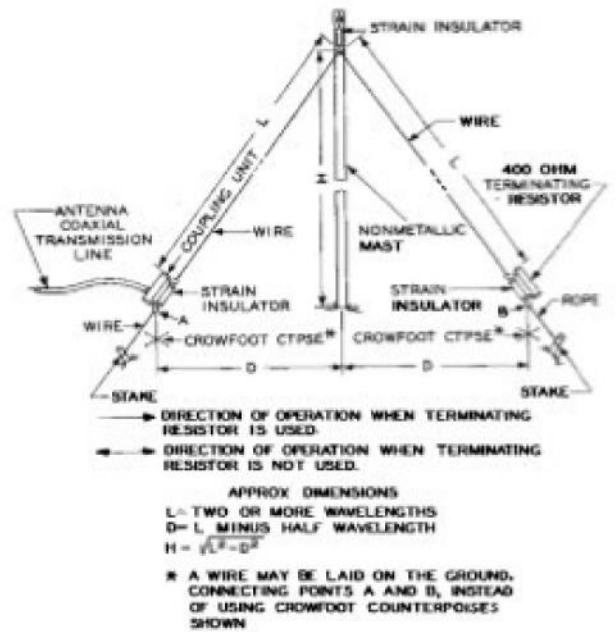

APPROX DIMENSIONS
 L - TWO OR MORE WAVELENGTHS
 D - L MINUS HALF WAVELENGTH
 $H = \sqrt{L^2 - D^2}$
 * A WIRE MAY BE LAID ON THE GROUND, CONNECTING POINTS A AND B, INSTEAD OF USING CROWFOOT COUNTERPOISES SHOWN

FIGURE 1469. Vertical Half Rhombic Antenna



FIGURE 1470. Three Element Directional Array

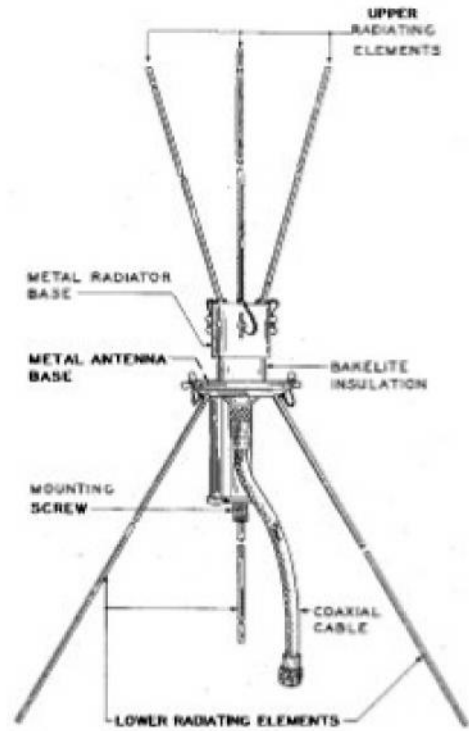

FIGURE 1471. Vertical Conical Dipole Antenna

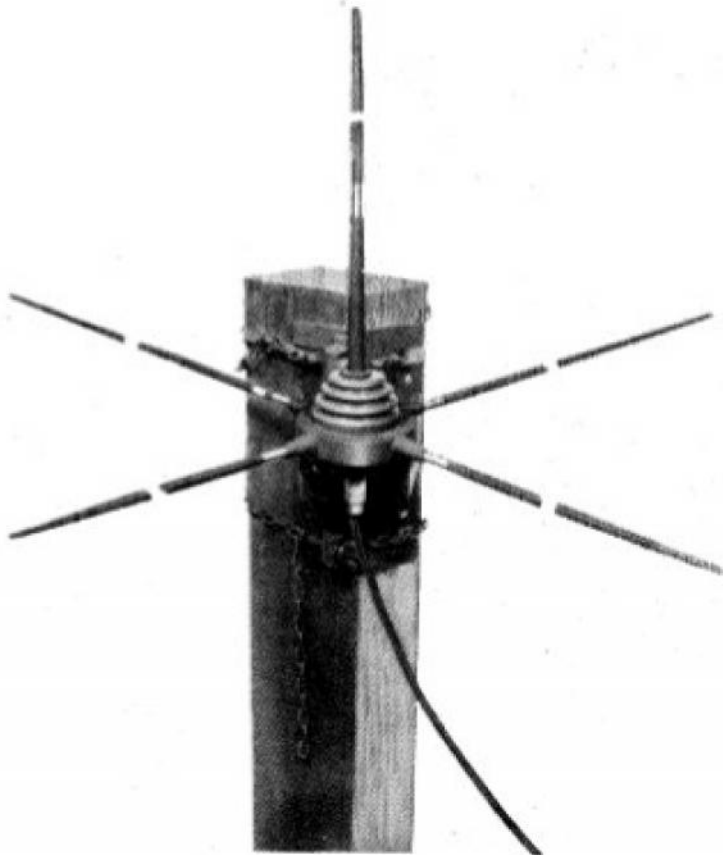

FIGURE 1472. Ground Plane Antenna

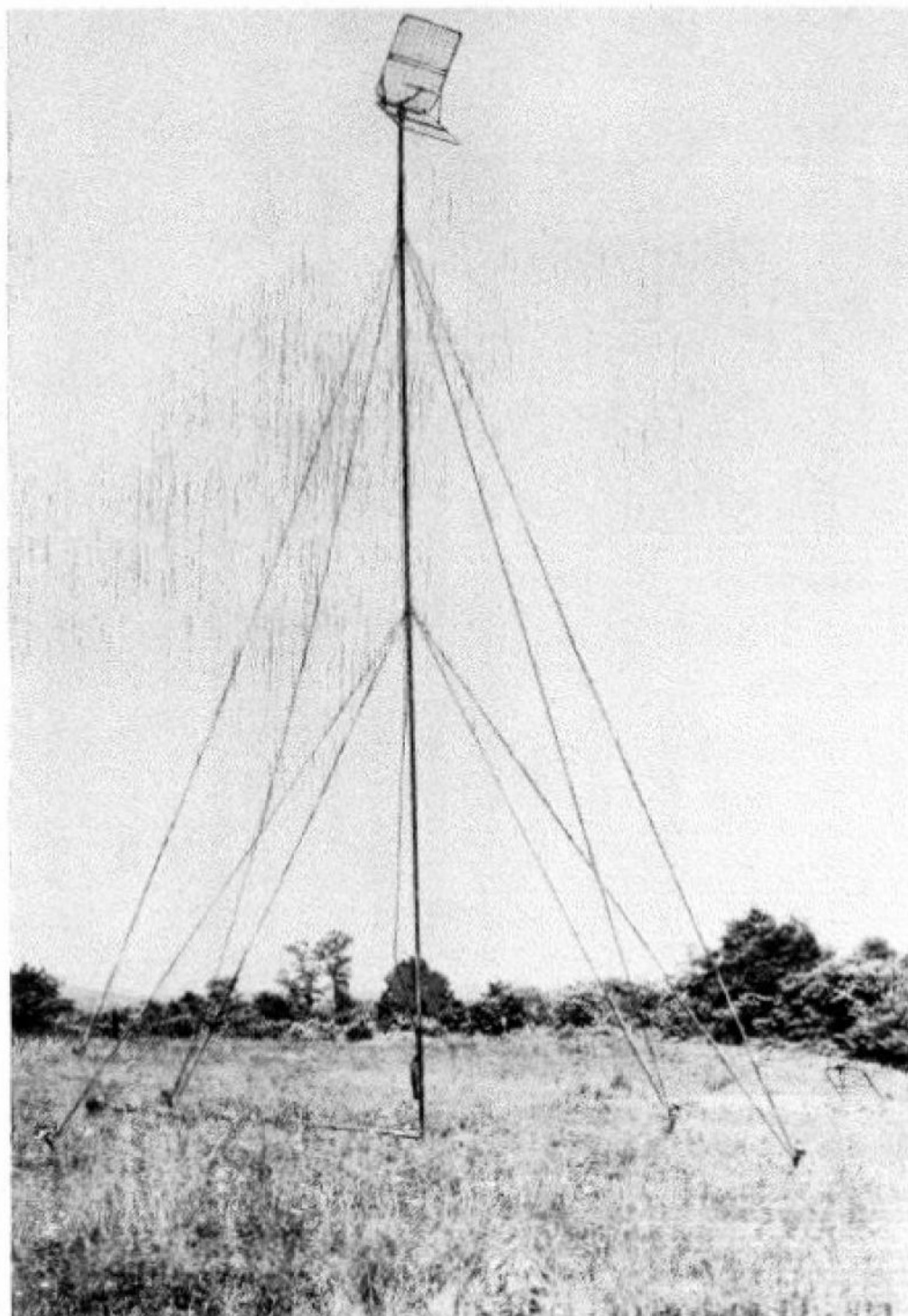
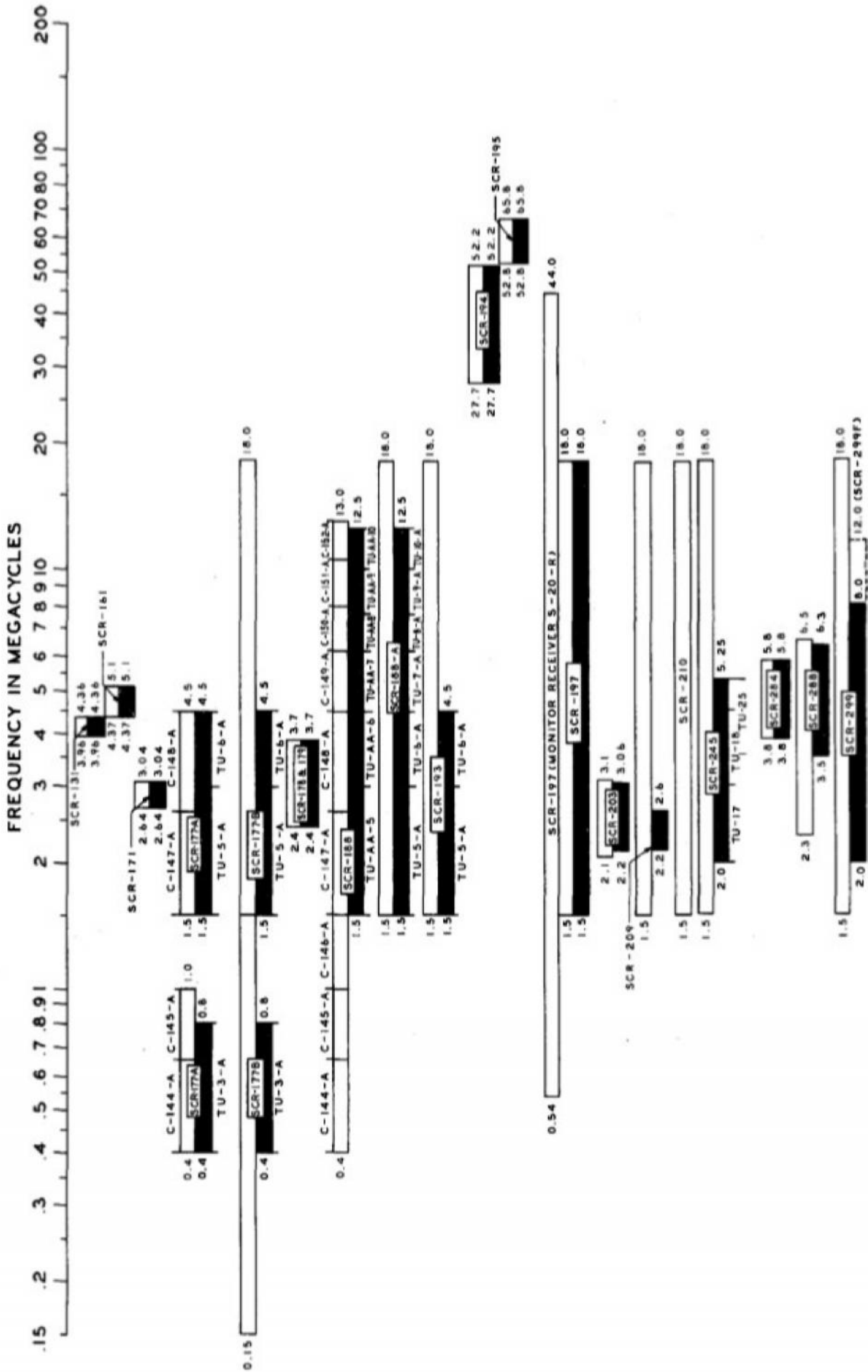
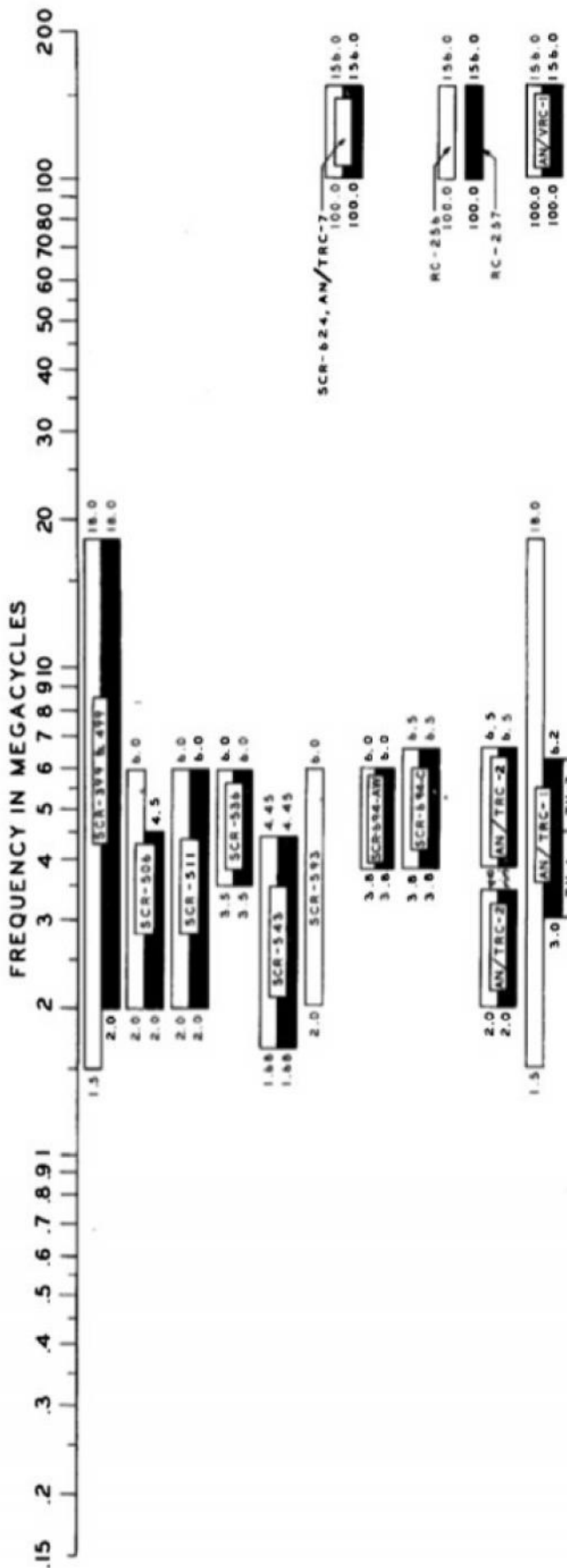

FIGURE 1473. Half-wave Corner Reflector Antenna

1409. FREQUENCY COVERAGE OF TACTICAL RADIO SETS FOR GROUND USE.

a. Amplitude Modulated Sets.





b. Frequency Modulated Sets.

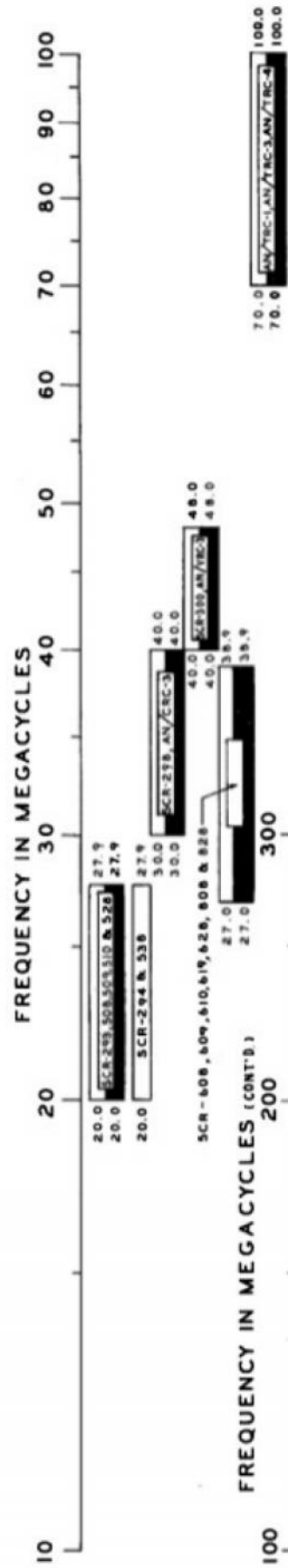

NOTES:
 A. RECEIVER
 TRANSMITTER
 B. THE NUMERALS SHOWN AT THE EXTREMES OF THE BLOCKS REPRESENT THE FREQUENCY COVERAGE OF THE RESPECTIVE UNITS.
 C. WHEN COIL SETS OR TUNING UNITS ARE EMPLOYED THEIR RANGES ARE INDICATED ABOVE AND BELOW THE RECEIVER AND TRANSMITTER BLOCKS RESPECTIVELY.

1410. GROUND, TRANSPORTABLE RADIO SETS - STOCK NUMBERS AND LOGISTICAL DATA - TACTICAL.

Type	Stock No.	Total Weight (lbs.)		Total Cu. Ft. Packed for Export	Ship Tons ^a
		Packed for Export	Net		
SCR-171	2S171	259	179	12	Obsolete
SCR-177-A	2S177A	1,030	850	28	0.7
SCR-177-B	2S177B	1,250	1,000	40	1.0
SCR-178	2S178.3	292	225	16	Obsolete
SCR-188	2S188	2,133	1,150	101	2.5
SCR-188-A	2S188A	2,018	1,385	100	2.5
SCR-284-A	2S284A	408	275	17	0.4
SCR-288	2S288	131	71	7	0.2
SCR-543- ()	2S543()	1,253	919	54	1.4
SCR-694-AW	2S694AW				
SCR-694-C	2S694C				
RC-256	2S55-256	725	600	44	1.1
RC-257	2S55-257	5,075	4,050	300	7.5
AN/CRC-3					
AN/CRC-3A					
AN/TRA-1	2S5006-1	547	402	32	0.8
AN/TRC-1	2S5002-1	2,000	1,435	78	2.0
AN/TRC-2	2S5002-2	1,001		52.5	1.3
AN/TRC-3	2S5002-3	3,150	2,560	132	3.3
AN/TRC-4	2S5002-4	4,500	3,500	187	4.7
AN/TRC-8					
AN/TRC-11					
AN/TRC-12					

1411. VEHICULAR RADIO SETS - STOCK NUMBERS AND LOGISTICAL DATA - TACTICAL.

Type	Stock No.	Total Weight (lbs.)		Total Cu. Ft. Packed for Export	Ship Tons ^a
		Packed for Export	Net		
SCR-193- ()	2S193()	375	234	18.5	0.5
SCR-195	2S195	145	96	7.5	Obsolete
SCR-209	2S209	217	174	8	0.2
SCR-210- ()	2S210()	160	71	7	0.2
SCR-245- ()	2S245()	220	185	11	0.3
SCR-284-A	2S284A	408	275	17	0.4
SCR-293- ()	2S293()	268	149	18	0.5
SCR-294- ()	2S294()	121	72	8	0.2
SCR-298-C	2S298C	187	75	15	0.4
SCR-506	2S506	535	357	25	0.6
SCR-508- ()	2S508()	265 ^b	200 ^b	14	0.3
SCR-510- ()	2S510()	235	137	12	0.3
SCR-511- ()	2S511()	98	65	4	0.1
SCR-528- ()	2S528()	215 ^b	165 ^b	12	0.3
SCR-538- ()	2S538()	155 ^b	115 ^b	7	0.2
SCR-543- ()	2S543()	1,253	919	57	1.4
SCR-593- ()	2S593()	63	38	3	0.1
SCR-608- ()	2S608()	265 ^{b,c}	200 ^{b,c}	14	0.3
SCR-610- ()	2S610()	280	176	12	0.3
SCR-619					
SCR-628- ()	2S628()	215 ^{b,c}	165 ^{b,c}	12	0.3
SCR-694-AW	2S694AW				
SCR-694-C	2S694C				
SCR-808	2S808		225 ^b		
SCR-828	2S828		190 ^b		
AN/VRC-3	2S4502-3				

^a40 cu. ft. assumed equivalent to 1 ship ton. Obsolete sets are so indicated in this column.

^bWeight of basic unit without installation components.

^cWeight of Remote Control RM-29 not included.

1412. PACK RADIO SETS - STOCK NUMBERS AND LOGISTICAL DATA - TACTICAL.

<u>Type</u>	<u>Stock No.</u>	<u>Total Weight (lbs.)</u>		<u>Total Cu. Ft. Packed for Export^a</u>
		<u>Packed for Export</u>	<u>Net</u>	
SCR-131	2S131	130	77	6 (Obsolete)
SCR-161	2S161	180	77	10 (Obsolete)
SCR-179	2S179	292	225	16 (Obsolete)
SCR-194	2S194	140	81	7
SCR-195	2S195	145	96	7.5(Obsolete)
SCR-203	2S203	330 ^b	162 ^b	17 ^b
SCR-284-A	2S284A	408	275	17
SCR-288	2S288	131	71	7
SCR-300	2S300	65	38	2.5
SCR-509-()	2S509()	210	130	9
SCR-510-()	2S510()	235	137	12
SCR-511-()	2S511()	98	65	4
SCR-536-()	2S536()	13	10.5	0.6
SCR-593-()	2S593()	63	38	3
SCR-609-()	2S609()	125	97	4
SCR-610-()	2S610()	280	176	12
SCR-619				
SCR-694-AW	2S694AW			
SCR-694-C	2S694C			
AN/TRC-2	2S5002-2	1001		52.5
AN/TRC-7				

^a Obsolete sets are so indicated in the export volume column.

^b Exclusive of Phillips Pack Saddle.

1413. AIR TRANSPORTABLE RADIO SETS - STOCK NUMBERS AND LOGISTICAL DATA - TACTICAL.

<u>Type</u>	<u>Stock No.</u>	<u>Total Weight (lbs.)</u>		<u>Total Cu. Ft. Packed for Export</u>	<u>Ship Tons^a</u>
		<u>Packed for Export</u>	<u>Net.</u>		
SCR-499	2S499	5,703	3,000	272	6.8
SCR-624	2S624	1,005	698	65	1.6
AN/CRC-3					
AN/CRC-3A					

^a 40 cu. ft. assumed equivalent to 1 ship ton.

1414. GROUND, MOBILE RADIO SETS - STOCK NUMBERS AND LOGISTICAL DATA - TACTICAL.

<u>Type</u>	<u>Stock No.</u>	<u>Total Weight (lbs.)</u>		<u>Total Cu. Ft. Packed for Export</u>	<u>Ship Tons^a</u>
		<u>Packed for Export</u>	<u>Net</u>		
SCR-197-()	2S197()	25,000	15,700	5,000	125
SCR-299-()	2S299()	16,800	12,375	1,567	39.2
SCR-399-()	2S399()	10,025	6,595	895	22.4
AN/VRC-1	2S4502-1	475	334	22	0.6

^a 40 cu. ft. assumed equivalent to 1 ship ton.

1415. REMOTE CONTROL EQUIPMENT FOR RADIO SETS - TACTICAL - DESCRIPTION.

Name	Nomenclature	Shown in Fig. No.	Major Components ^a	Dimensions - Inches				Weight Pounds	Range - Miles of Wire	Used with Radio Sets	Miles of Wire ^b	Number of Pairs	Power Input Requirements ^c	Technical Manual	Remarks
				H	W	D	Radio Sets								
Remote Control Equipment	AM/TRA-2 ^d	1474	Control Unit C-112/TRA-2-() (Remote Station)	20	9	12	12	20	AM/TRC-1 AM/TRC-3	2	1 or 2	D-c talking and signaling battery supplied over the line from trans. control unit		Used with but not a part of Radio Set AM/TRC-1 and -8. Consists of 2 units, a transmitter control unit C-112/TRA-2 located at the radio transmitter and a remote station unit C-112/TRA-3 located at a remote point. Provides: Press-to-talk control of the radio set on a 2 or 4-wire basis; volume limiter for limiting the transmission level input into the radio transmitter; listening at remote station with either phones or loudspeaker; inter-communication between attendants; manual volume control for the headphones at the remote station; automatic radio repeater operation; facilities for 3 attendants at the remote station. Two-wire operation is normally provided when the radio receiver and transmitter are closely associated with each other or when automatic repeater operation is used in which case the radio receiver is located with the remote station unit. Four-wire operation is provided when the radio receiver and transmitter are not located together or when the radio system uses two frequencies to provide simultaneous two-way communication.	
Remote Control Equipment	RC-49-() ^e	1475	Unit RM-13-() (Remote Station)	34	15	11	9	34	SCR-198-A	6 wet 10 dry	2	110V-60" or 220V-60" 2 Batteries BA-30 (1.5V)	TM 11-312 TM 11-233	Part of Radio Set SCR-198-A. Designed to control Radio Transmitter RC-191-() from the radio receiver location which may be at a remote point. Consists of two principal units, RM-12-() at the radio transmitter and RM-13-() at the radio receiver. Provides: Press-to-talk remote control for switching from receiving to transmitting; manual volume control; volume indicators at remote point and radio transmitter input; one stage of speech input amplification at remote point; receiver disabling when transmitting with voice or telegraph. A microphone modulator channel and a local battery telephone channel are provided on two separate pairs, and a telegraph channel on the phantom derived from these two pairs. At the receiver point, any one of three microphones, three telegraph keys or three radio receivers may be selected through a rotary type three-position selection switch. This equipment permits operating the transmitter on phone, CW, or Tone from either the transmitter location or from the remote point.	
Remote Control Equipment	Control Unit RM-12-() (Transmitter)		Control Unit C-113/TRA-2-() (Transmitter)	29	15	10	9	29				2 Batteries BA-30 (1.5V)			

^a Running spares included.

^b Other wire lines may be used where they are equivalent to or better than Wire W-110-B, for transmission and signaling.

^c AC power, where indicated, is supplied from radio set.

^d Part of radio set with which it is used.

^e Not available until late in 1944.

Nomenclature Name	Type No.	Shown in Fig. No.	Major Components	Dimensions - Inches			Weight Pounds	Used with Radio Sets	Miles of Wire - N-110-8 ^b Pairs	Power Input Requirements ^c	Technical Manual	Remarks
				H	W	D						
Remote Control Equipment	RC-261	1476	Control Unit RM-52 (Remote Station)	3	6	8	4	SCR-608 SCR-609 SCR-610 SCR-619 SCR-623 SCR-300 SCR-309 SCR-510 AM/75C-7	2	1	4 Batteries BA-30 (1.5F)	Used with but not a part of the radio sets listed. Consists of two units, a Control Unit RM-52 located at a remote point and a Control Unit RM-53 located with the transmitter. By means of a three-position selection switch in the RM-53 the following types of traffic are provided for, corresponding to the switch positions indicated: Remote - Press-to-talk remote control from the RM-52 for switching from receiving to transmitting and voice modulating the transmitter. Radio - When the Control Unit RM-53 is used in this switch position, normal control at the radio set itself is relinquished and the operator at the control unit has press-to-talk control of the radio set. Interphone - Both control units function as a telephons and the operators can talk to each other. However, no means for ringing are provided. The radio set cannot be used by either operator on this switch position.
Remote Control Equipment	RC-289	1477	Control Unit RM-29-() (Transmitter)	14	7	10	6	SCR-178 SCR-284 SCR-608 SCR-609 SCR-610 SCR-626 SCR-694	5	1	1 Battery BA-27 (4.5F) 2 Batteries BA-34 (7.5F)	Used with but not a part of the radio sets listed. Consists of the Control Unit RM-29-() at the transmitter location and a Telephone KE-8-() and Key J-47 at the remote station. Operates similar to RM-29-() providing the same features under control of a manually operated locking type selection switch. However, an additional feature is obtained which provides means for CW keying the transmitter from either the remote station or the control unit.
Remote Control Equipment	RC-290		Control Unit RM-29-() (Transmitter)	14	7	10	6	SCR-178 SCR-284 SCR-608 SCR-609 SCR-610 SCR-626	2	1	1 Battery BA-27 (4.5F) Current Drain 50-75 MA 2 Batteries BA-30 (1.5F)	Used with but not a part of the radio sets listed and other models of similar design. Consists of the Control Unit RM-29-() at the transmitter location and a Telephone KE-8-() at the remote station. All operating features are the same as described for the RM-29-().
Remote Control Equipment			Telephone KE-8-() (Remote Station)	10	10	8	4	SCR-608 SCR-609 SCR-610 SCR-626				
			Case CS-76-()	2	10	11	7					

^c AC power supplied from radio set.

^a Running spares included.
^b Other wire lines may be used where they are equivalent to or better than Wire #110B, for transmission and signaling.

Table continued on next page

REMOTE CONTROL EQUIPMENT FOR RADIO SETS - TACTICAL - DESCRIPTION (Continued)

Nomenclature Name	Shown in Type No., Fig. No.	Major Components	In Operation Dimensions -		Used with Radio Sets	Range - Miles of Number Wire	Pairs	Power Input Requirements ^b	Technical Manual	Remarks
			Weight Pounds	Inches						
Remote Control Unit.	EM-7-() c 1478		56	11 18 12	SCR-197	7.5	2	110V-60" 220V-60" 60 watts	TM 11-641 TM 11-605	Two Remote Control Units EM-7-() are furnished as part of Radio Set SCR-197. Each unit provides two operating positions, either of which can be used for teletype keying or voice modulating the Radio Transmitter BC-325-(). The control unit can be used at either of two operating locations, in the truck for local operation with the transmitter or in the receiver trailer at a remote point. The control unit includes the chassis of Telephones KE-8-() making possible intercommunication between units over a pair of wires. Another pair is used for voice modulating the transmitter. Telegraph keying can be obtained on one of three different channels; on the simplex of line 1, the simplex of line 2 or the phantom derived from Line 1 and Line 2. Provides: Audio gain control, audio level indicator; receiver dimming; one stage of speech input amplification at the remote point.
Remote Control Unit	EM-14 1479		15	10 11 7	SCR-194 SCR-195	2	1	1 Battery BA-2 (22.5V) 2 Batteries BA-30 (1.5V)		Used with but not a part of radio sets listed. Provides for operation of radio sets at the control unit, which is always located at the radio set, or from a remote Telephone KE-8-() and also functions as a telephone for the operator to communicate with an KE-8-() telephone connected to the line. By means of a three-position locking type selection switch similar traffic to that obtained with the EM-29-() is obtained with this unit.
Remote Control Unit	EM-21 c 1480		10	9 13 6	SCR-543	18 ft.	7 con- cord ductor cord	None	TM 11-625	Part of Radio Set SCR-543. Control panel for operating radio set. Provided with a short cord and plug for direct connection to Radio Receiver and Transmitter BC-659-A for operation at the radio set. Using Cord CD-513-A as an extension, the unit may be placed up to 18 feet from the radio set. Provides means for: starting, choking, or stopping Power Unit PE-108-A; listening on the receiver, volume control of signal received in the headset or headset by means of a variable resistor; switching from receiving to transmitting by means of the press-to-talk switch on headset or microphone; voice modulating transmitter.

^aOther wire lines may be used where they are equivalent to or better than Wire W-110-B, for transmission and signaling.

^bAC power supplied from radio set.

^cPart of radio set with which it is used.

Nomenclature Name	Type No.	Fig. No.	Shown in	Major Components	In Operation			Used with Radio Sets	Miles of Wire	Number of Pairs	Power Input Requirements ^b	Technical Manual	Remarks
					Weight Pounds	H	W						
Remote Control Unit	RM-29-()	143H			15	10	11	7	2	1	1 Battery BA-27 (4.5V) Current Drain 50-95 MA	TW 11-308	Part of RC-290. Used with but not a part of the radio sets listed. In earlier models was part of SCR-294, 609, 609, 610 and 628. It is a complete and self contained unit always located not further than the length of the cord from the radio set and operates with a Telephone KE-8-() or a Switchboard BD-71 or BD-72 at the remote station. An operator is always required when this unit is being used. By means of a three-position locking type selection switch the following types of traffic are provided, corresponding to the switch positions indicated: Through - The radio set is controlled by the operator at the control unit. However, he cannot transmit but can only monitor the signals passing over the line between the radio receiver and the remote Telephone KE-8-(), or between that telephone and the radio transmitter. Since no press-to-talk control of the radio transmitter is provided from the remote station telephone, the operator at the control unit must switch manually from the transmitter to the receiver in accordance with instructions received while monitoring. The operator at the remote station can listen to the radio receiver or voice modulate the radio transmitter. Radio - When the control unit is used in this switch position, normal control at the radio set itself is relinquished and the operator at the control unit has press-to-talk control of the radio set. Telephone - Control unit functions as a telephone and the operator can communicate with the distant Telephone KE-8-(). However, neither the operator at the remote telephone nor the operator at the control unit can transmit to or receive from the radio set in this switch position.

^aOther wire lines may be used where they are equivalent to or better than Wire W-110-B, for transmission and signaling.
^bAC power supplied from radio set.

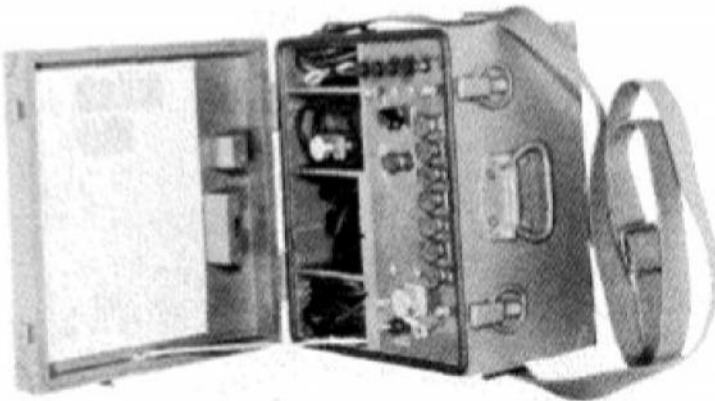

Control Unit C-112/TRA-2

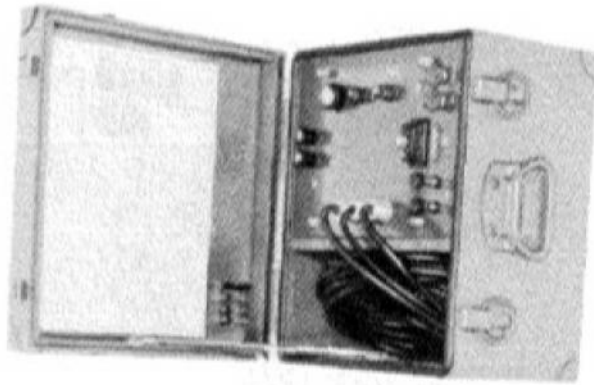

Control Unit C-113/TRA-2

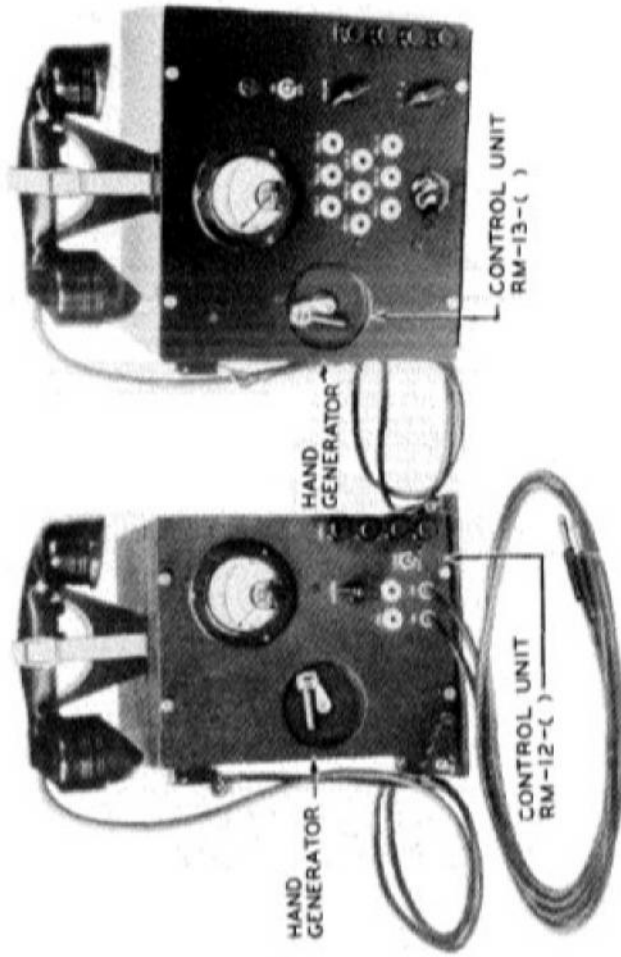

FIGURE 1474. Remote Control Equipment AN/TRA-2

FIGURE 1475. Remote Control Equipment RC-47-()

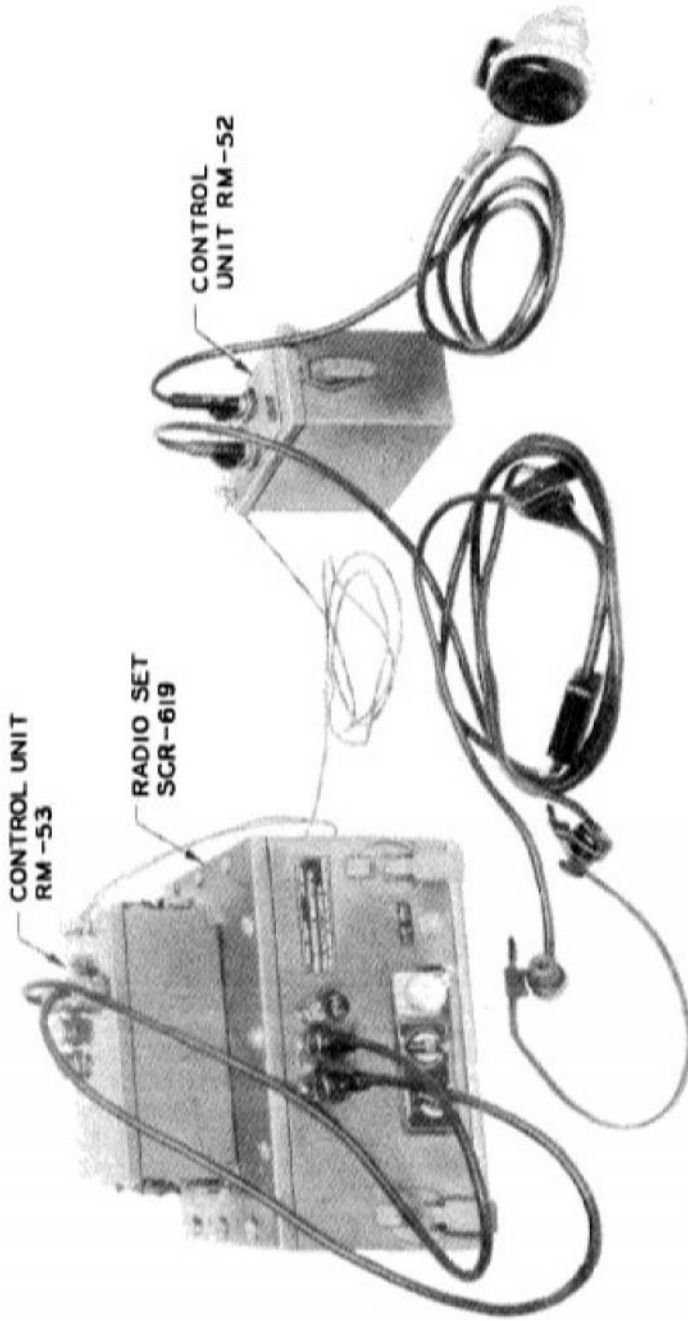

FIGURE 1475. Remote Control Equipment RC-261 with Radio Set SCR-619

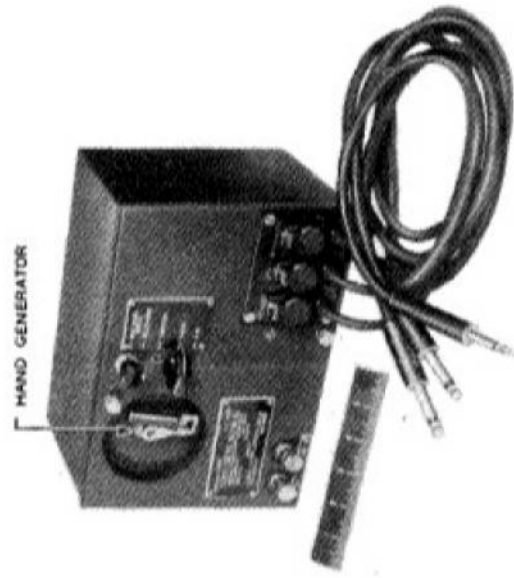

FIGURE 1477. Remote Control Unit RM-39-()

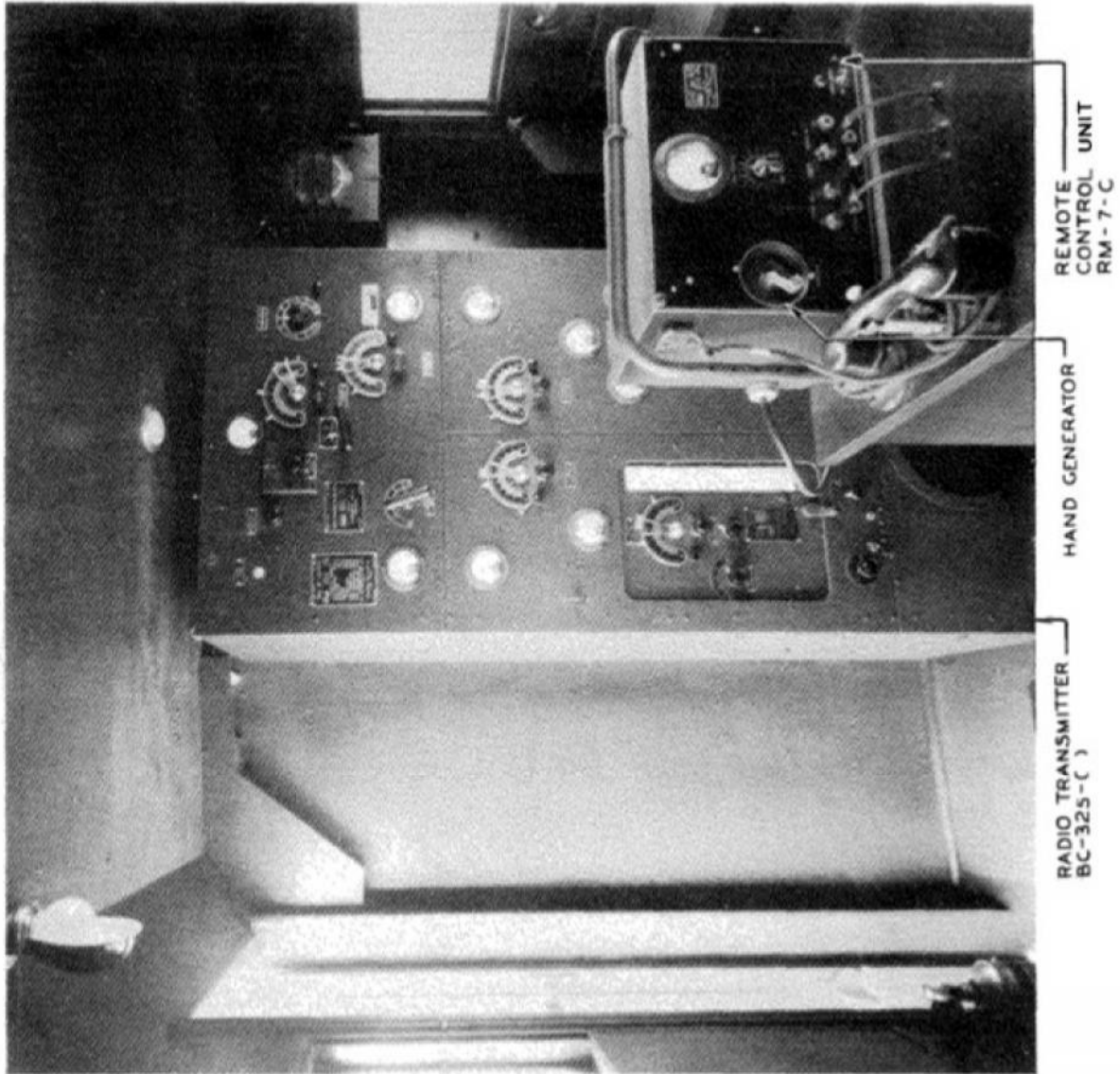

FIGURE 1478. Remote Control Unit RM-7-() with Radio Transmitter BC-325-()



FIGURE 1481. Remote Control Unit RM-29-()

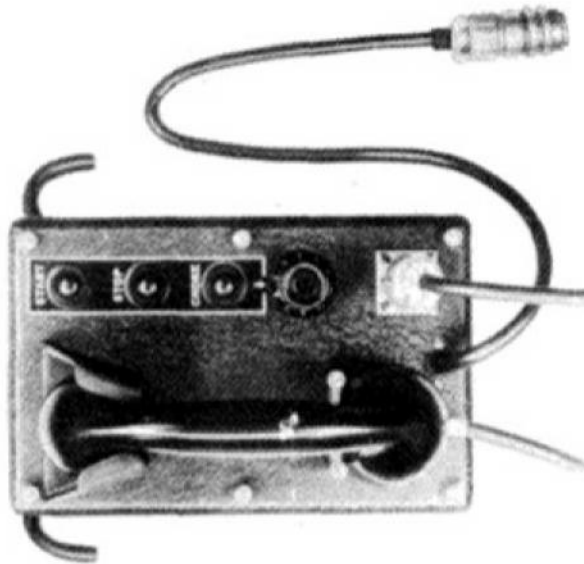

FIGURE 1480. Remote Control Unit RM-21

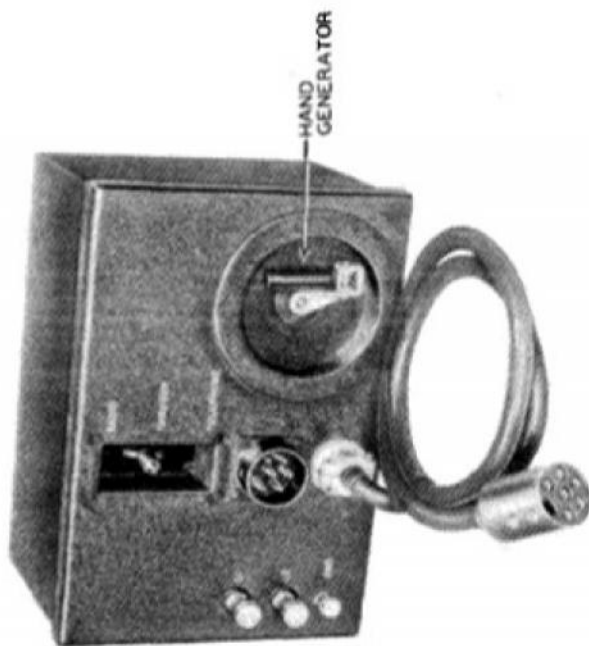

FIGURE 1479. Remote Control Unit RM-14

1416. REMOTE CONTROL EQUIPMENT - TACTICAL-STOCK NUMBERS AND LOGISTICAL DATA

Nomenclature Name	Type No.	Stock Number	Packed for Export	
			Total Weight Pounds	Total Cubic Feet
Remote Control Equipment	AN/TRA-2	2S5006-2	45	2.5
Remote Control Equipment	RC-47() a, b	2S47()	266	9.0
Remote Control Equipment	RC-261	2C7600-261	15	1.0
Remote Control Equipment	RC-289	2C7600-289	33	1.7
Remote Control Equipment	RC-290 c & d.	2C7600-290	35	1.8
Remote Control Unit	RM-7()	2C677()	60	2.5
Remote Control Unit	RM-14	2C7614	14	0.5
Remote Control Unit	RM-21	2C7621	18	0.8
Remote Control Unit	RM-29()	2C7629()	22	0.6

^aPart of the radio sets.

^bIncludes RM-12-(), stock number 2C678() and RM-13-(), stock number 2C679().

^cRequires 2 Batteries BA-30 for Telephone EE-8-().

^dRequires 1 Battery BA-27, 1 Headset P-19 and 1 Microphone T-17.

Section III
Fixed Plant Radio Equipment

1417. GENERAL-

^aThis section covers radio transmitting and receiving equipment commonly used by the Army Communications Service. Navigational aid equipment has not been included unless it is also used for ground communications. Data concerning antennas, towers and other accessory equipment are given in section IV.

b. In general, fixed plant installations are engineered individually, based on proposals submitted by the theater regarding equipment requirements. The data tabulated in this section cover the major equipment components which are available through Army Communications Service and provide information useful in making the preliminary engineering estimates in the theater. Information on typical installations is available through the office of the Chief Signal Officer, SPSLP.

c. The equipment is divided into two categories, that used by Command Radio and that used by the Airways Section, respectively. In a few cases, the same equipment types are listed in both categories, but the associated stock numbers may differ, indicating that the assemblies differ in some respect.

d. The stock number listed for a major component, such as a transmitter, frequently does not cover such essential accessories as crystals, tuning coils, etc. Requirements for such accessories will depend on the specific installation, necessitating separate procurement.

e. Equipment supplied upon requisition by specific stock number may not always be identical with that designated in the descriptive tables, depending on the particular type available at the time. It will, however, have comparable operating characteristics.

f. The pictures of apparatus are representative of the designated equipment. The remote control equipment sometimes shown is not a component of the assembly unless so stated in the descriptive tables.

g. The descriptive tables refer to figures which give sketches of antenna types and, in some cases, associated ground systems normally used with a given equipment. These sketches are merely illustrative and do not necessarily represent any specific Signal Corps antenna assembly.

1418. COMMAND RADIO SETS - DESCRIPTION.

^aParagraph 1422 lists transmitting equipment and paragraph 1423 lists receiving equipment commonly used by Command Radio. Descriptive information and technical data are given for each set. The information includes such items as frequency range, type of modulation and emission, type of antenna, transmitter output power, power supply requirements, etc.

b. In general, Command Radio installations are engineered individually, based on information supplied by the theater concerning the proposed circuit. This information includes; the anticipated traffic load and associated circuits, equipment already in operation, equipment and power available for this installation, location of and distances between sites for transmitter, receiver and message center installations. Army Communications

Service, Plant Engineering Agency, upon receipt of such information, together with War Department approval, initiates the supply action to provide all material necessary for the installation, operation and maintenance of the station, including specifications and drawings.

c. Materials issued for new stations which are not additions to existing installations will normally include, in addition to major radio items, all tools for installation of equipment and antennas; all materials for wiring of power, light and signal circuits in the building, based on typical layouts which permit considerable latitude in floor plans. In addition, materials will be provided to construct a complete power plant at each radio and message center building, including sufficient subterranean power cable to permit a 25-foot separation between the power plant and associated building. Approximately 3 miles of subterranean cable and adequate splicing materials will be provided for control and voice frequency transmission circuits between the transmitter and the message center buildings, and cable and splicing material will also be provided for control and voice frequency transmission circuits between the receiver and the message center buildings when a separate receiver building is required. Telephones for use over control circuits, test equipment and stationery will also be furnished.

d. Buildings, furniture, operators' benches for manual positions, cement for concrete foundations, and short poles for R.F. transmission lines are not supplied.

e. Transmitters used by Command Radio, which are capable of remote keying, normally may be operated over distances up to 5 miles of 22 ga. cable.

1419. COMMAND RADIO SETS - STOCK NUMBERS AND LOGISTICAL DATA.

a. Paragraph 1424 gives data such as stock number, shipping weight and volume for transmitting equipment used by Command Radio.

b. Paragraph 1425 gives similar information for receiving equipment used by Command Radio.

1420. AIRWAYS SECTION RADIO SETS - DESCRIPTION.

a. Paragraph 1426 lists transmitting equipment, paragraph 1427 lists receiving equipment and paragraph 1428 lists combined transmitting and receiving equipment commonly used by the Airways Section. Descriptive information and technical data are given for each type of equipment. The information includes such items as frequency range, type of modulation and emission, type of antenna, transmitter output power, power supply requirements, etc.

b. Under the column in paragraph 1426 "Additional Equipment Required" are listed such key items as exciter units, rectifiers, modulators, antenna tuning units, etc. which normally will be required for the designated transmitting equipment installation.

1421. AIRWAYS SECTION RADIO SETS - STOCK NUMBERS AND LOGISTICAL DATA.

a. Paragraphs 1429, 1430 and 1431 give data such as stock number, shipping weights and volume for transmitting equipment, receiving equipment and for combined transmitting and receiving equipment, respectively, used by the Airways Section.

1422. TRANSMITTING EQUIPMENT COMMONLY USED BY COMMAND RADIO - ARMY COMMUNICATIONS SERVICE - DESCRIPTION

Type ^a	Fig. No.	Rated Power Output	Type of Mission ^b	Freq. Range-Mc	Freq. Control	Normal Antenna ^d	Power Req. ^e	Size in Oper. ft.	Weight in Use (lbs.) ^f	Instr. Book or Tech. Man. ^h	Remarks
BC-339-()	1482	1 KW	A1 & Special	4.0-26.5	M.O. or Ital (Holder FT-164)	Rhombic or Doublet (Fig. 1536 & 1537)	4.8 KVA 280 V. 3 φ 60 cye.	3.5x 3x7	1335	6075339()	One unit - transmitter. Telegraph or teletype operation; local or remote start-stop and remote keying; switch selection of master oscillator or one of six crystals. Requires external exciter for teletype operation; also used as exciter for Power Amplifier BC-340 (see paragraph 1486.)
BC-365-()	1483	350 W.	A1	0.15-0.55	M.O.	Intermediate Flat Top (Fig. 1536)	1.8 KVA 110/220 V. 1 φ, 60 cye.	2.5x 2.5x 6.5	629	TM 11-828	Includes two units - transmitter and remote control unit EM-10. Telegraph operation only; local or remote control; manual adjustment of master oscillator; also used as exciter for Bunnell 6 KW Amplifier.
BC-447-()	1484	300 W.	A1	2.0-6.0 & 4.0-15.4	M.O. or Ital (Holder FT-164)	Doublet (Fig. 1537)	1.5 KVA 110/220 V. 1 φ, 50/60 cye.	3x2.5 x6	645	TM 11-827	Includes two units - transmitter and remote control unit EM-17. Telegraph operation; local or remote control; local or remote selection of two pre-tuned channels (one channel modified to operate 2 to 8 Mc); can be modified for teletype operation using external exciter.
O-5/Fx Oscillator, Exciter (Press Wireless FS-1240)	See paragraph 1027										
SCR-231-()	1485	25 W.	A3	1.7-2.75	Ital (Billey Holder A-AP7)	Single Wire (85' or longer)	Transmitting - 250 W. at 115 V. 1 φ, 60 cye. Receiving - 110 W. at 115 V. 1 φ, 60 cye.	2x2x 2.5	93	TM 11-844	One unit - receiver and transmitter BC-441-(). For use on coastal and harbor vessels or at inland stations for communication with such vessels. Four preset channels. Operation of the equipment approximates that of an ordinary hand telephone in simplicity of operation.
10-KW Transmitting Equipment	1486	10 KW	A1 & Special	4.0-26.5	M.O. or Ital (Holder FT-164)	Rhombic (Fig. 1536)	35 KVA 220 V. 3 φ 60 cye.	15x 5x7	6456	202940()/1	Includes five units - Power amplifier BC-340, Transmitter BC-339 (exciter), Rectifier RA-22, Water Cooling Unit BU-8 and expansion tank. Telegraph or teletype operation; local or remote start-stop and remote keying; switch selection of master oscillator or one of six crystals.
Bunnell 6 KW (Amplifier)	1487	10 KW (6 KW out of Tuning House)	A1	0.15-0.55	-	Intermediate Flat Top (Fig. 1536)	25 KVA, 220 V. 3 φ 50/60 cye.	10x5x6.5 Plus Tuning House 6x5x7	6110	20466/M	Includes three units - power amplifier, rectifier and antenna tuning house. Used with transmitter BC-365.

Type ^a	Fig. No.	Rated Power Output	Type of Emission ^b	Freq. Range-Mc	Freq. Control ^c	Normal Antenna ^d	Power Req. ^e	Size in Oper. ft. f	Weight in Use (lbs.) g	Instr. Book or Tech. Man. h	Remarks
Press Wireless ^j PW-15-()	1488	15 KW	A1 & Special	4.0-21	Ital (Holder FT-164)	Rhombic (Fig. 1536)	37 KVA, 220 V. 3 φ 60 cyc.	9x5x7	6945	208890/ST	One unit - transmitter. Telegraph or teletype operation; local start-stop, remote keying; manual selection of one of six crystals; requires external exciter for teletype operation.
Press Wireless ^j PW-40-()	1489	40 KW	A1 & Special	4.0-21	M.O. or Ital (Holder FT-164)	Rhombic (Fig. 1536)	94 KVA, 220 V. 3 φ 60 cyc.	18x5x7	11000	TM 11-825	Includes five units - rectifier, exciter, power amplifier, water cooling unit and expansion tank. Telegraph, teletype or single side-band operation; local start-stop, remote keying; manual selection of master oscillator, one of six crystals or external exciter; external exciter, for teletype operation required. May also be arranged to operate as a linear amplifier for single side-band operation requiring W.S.Co., D-156000 transmitter as an exciter.
Press Wireless ^j PW-981-()	1490	2.5 KW	A1 & Special	2.5-26	M.O. or Ital (Holder FT-164)	Rhombic (Fig. 1536)	9.6 KVA, 220 V. 3 φ 50/60 cyc.	3x3x7	2000	TM 11-854	One unit - transmitter. Telegraph or teletype operation, local or remote start-stop and remote keying, manual frequency selection from master oscillator, one of five crystals or teletype exciter; requires remote control unit.
Western Electric Co. ^j D-156000	1491	2 KW	Special	4.5-22	Ital (Spec. Holder)	Rhombic (Fig. 1536)	5 KVA, 220 V. 3 φ 50/60 cyc.	5x2.5x7	2428	FTMP 609652	One unit-transmitter, mounted in 3 bays. Local start-stop, remote signaling, fixed frequency operation. May also be used as exciter for PW-40 arranged for operation as a linear amplifier. Part of entire terminal for single-side band, reduced carrier, radio telephone system for twin channel operation, giving 6 two-way telegraph circuits over one two-way radio telephone circuit. Entire terminal consists of radio transmitter; distortion measuring set; single side-band receiver (W.S.Co. D-99945, par.1423) including its associated testing and measuring equipment; and V.F. Carrier Telegraph Equipment (par. 1088). The entire terminal is listed under one stock number (par. 1424).

^a The listed type identification refers to the radio transmitting equipment only. The material provided under corresponding stock numbers given in paragraph 1424 includes the additional items listed under "Remarks".

^b A1 indicates continuous wave telegraphy; A3 indicates voice transmission.

^c M.O. is used to indicate Master Oscillator control and Ital to indicate crystal control.

^d Figure numbers refer to sketches of representative antennas shown in paragraph 1428.

^e Includes power required for equipment shown in "Remarks" column.

^f The first two dimensions are width and depth, respectively, and represent the area required by the designated equipment plus the accessory equipment listed in the "Remarks" column and do not represent the floor space required for the complete station installation. Allowance is not made for opening of apparatus doors or drawers, space between units, and operating and maintenance space for personnel. The last dimension is the height of the tallest unit.

^g Includes weight of equipment listed in "Remarks" column.

^h When other identification is not available for instruction books, the stock number is shown.

^j Type number assigned by the manufacturer.

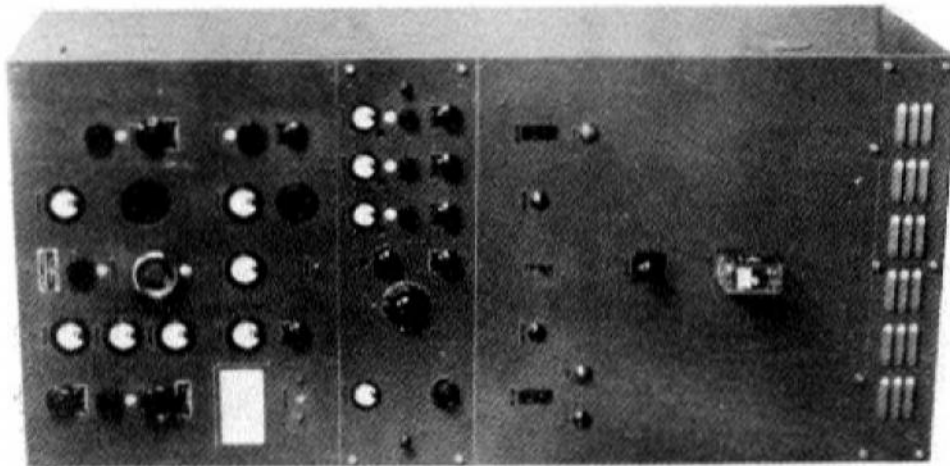

FIGURE 1482. Radio Transmitter BC-339-()

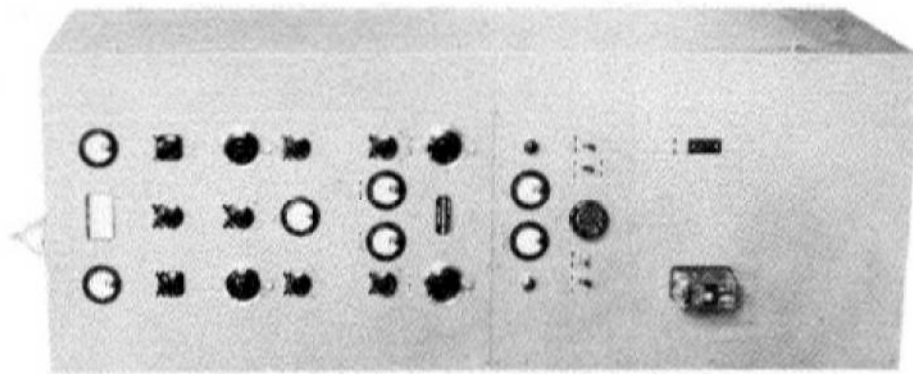

FIGURE 1483. Radio Transmitter BC-365-()

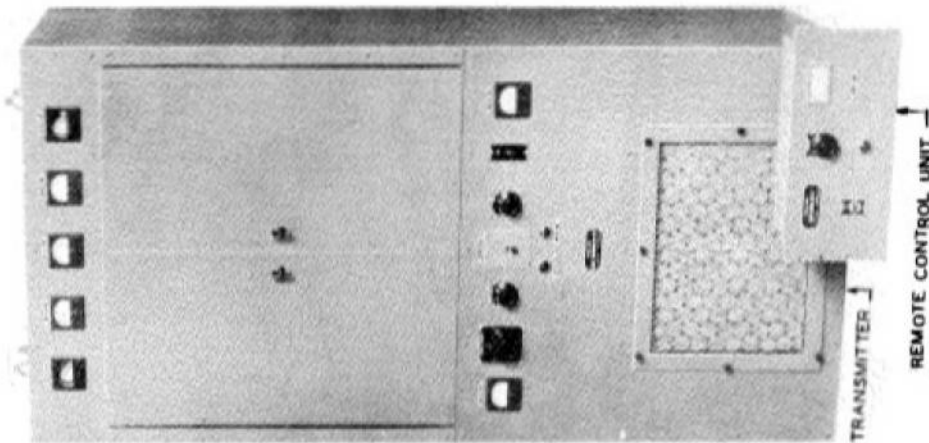

FIGURE 1484. Radio Transmitter BC-447-() and Remote Control Unit RM-17

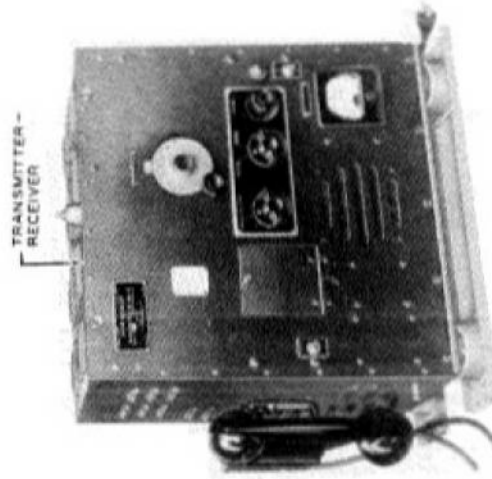

FIGURE 1485. Radio Set SCR-281

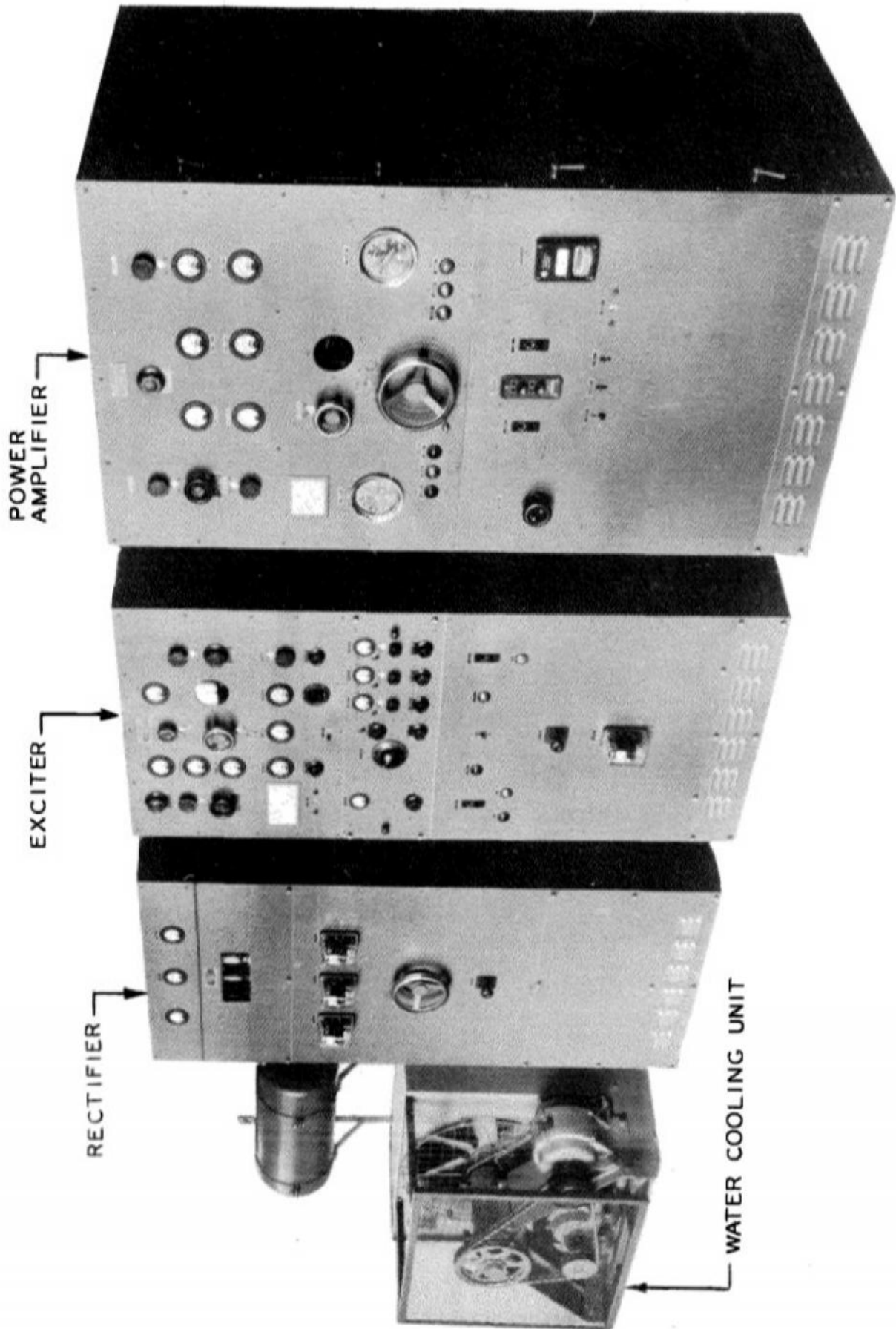
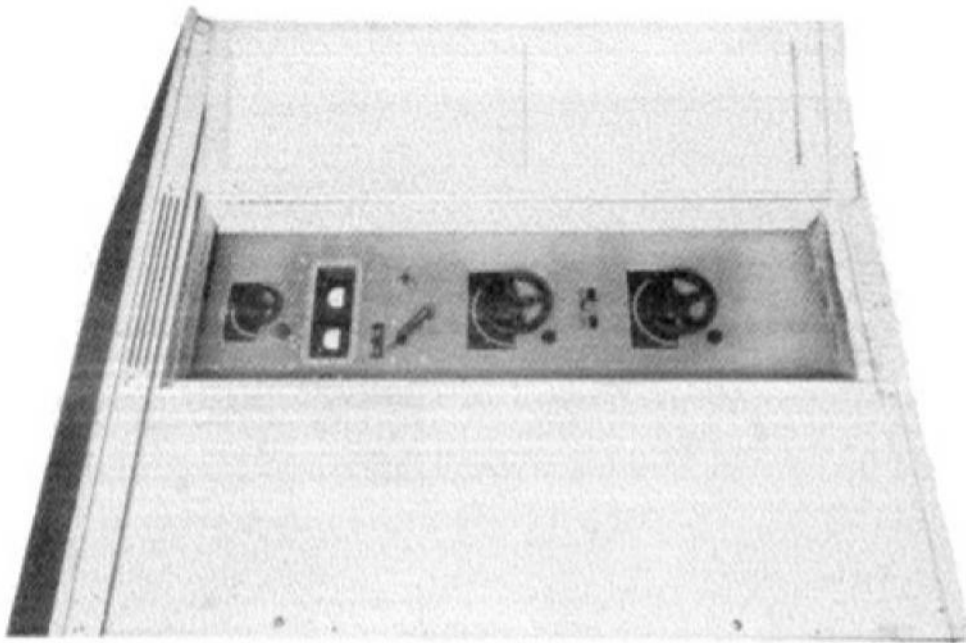
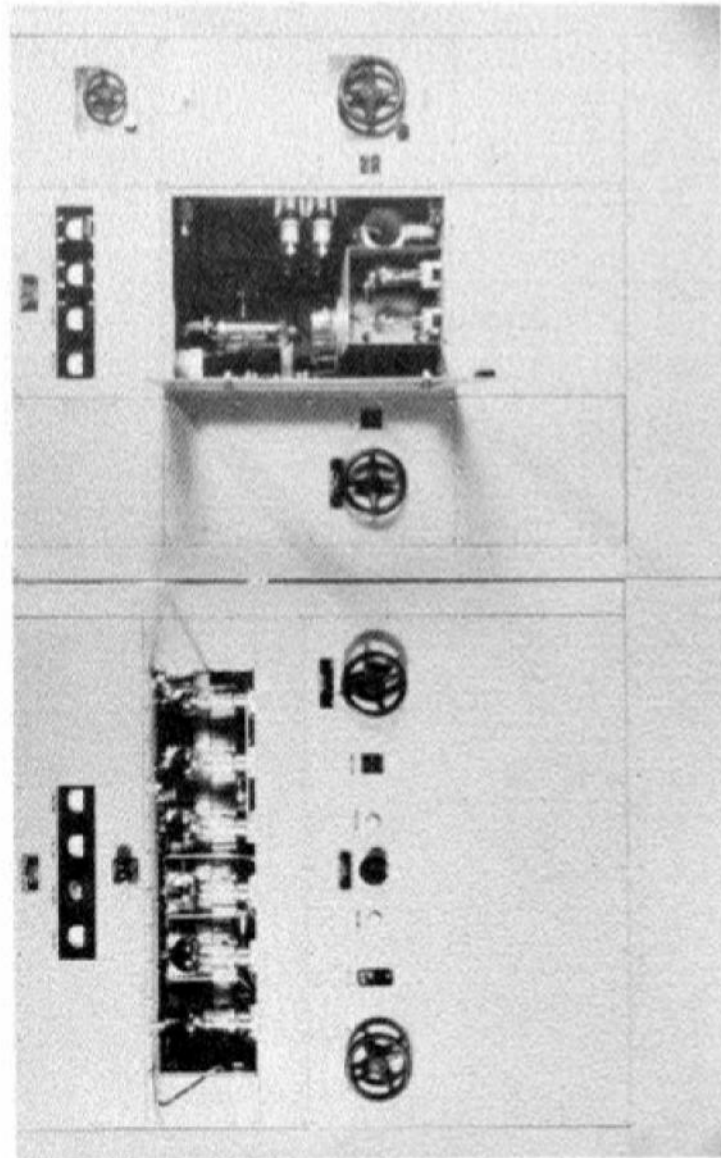

FIGURE 1486. 10KW Transmitting Equipment



AT-1A Antenna Tuning House



RA-1A Rectifier - PA-1A Power Amplifier

FIGURE 1487. Radio Amplifying Equipment (Bunnell 6 KW)

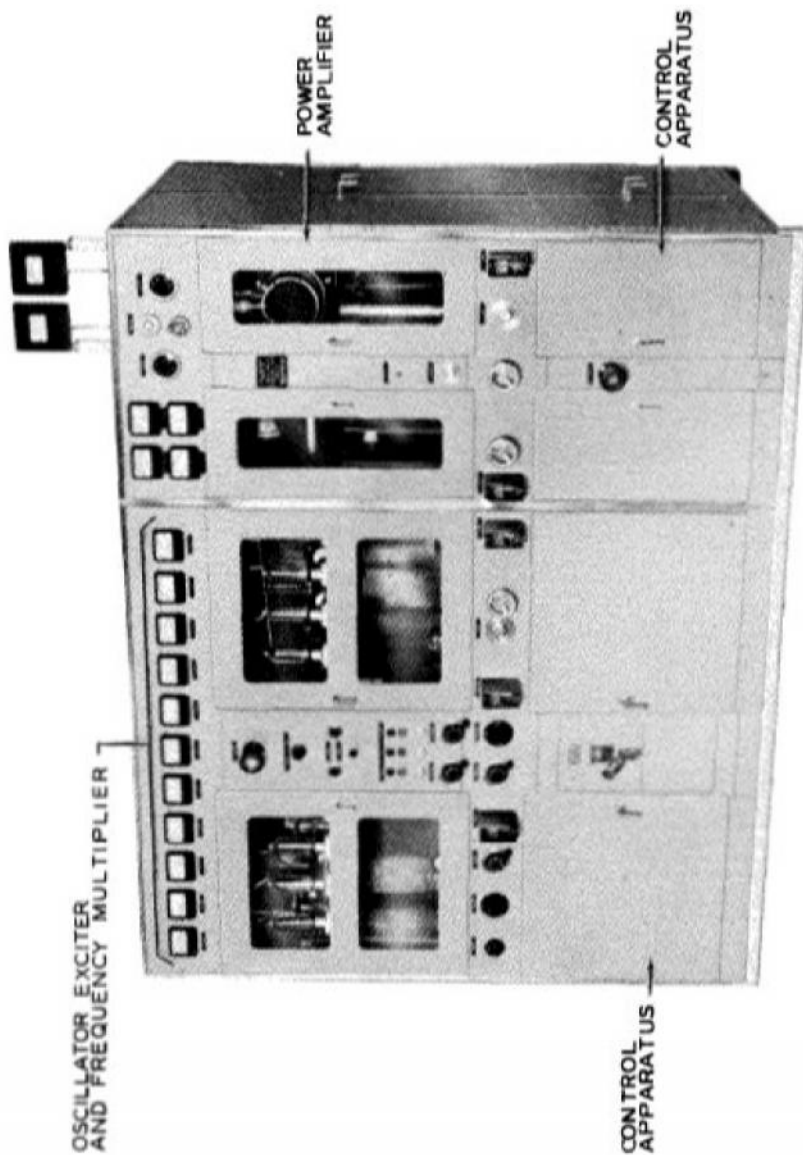

FIGURE 1488. Radio Transmitter (Press Wireless PW-15-())

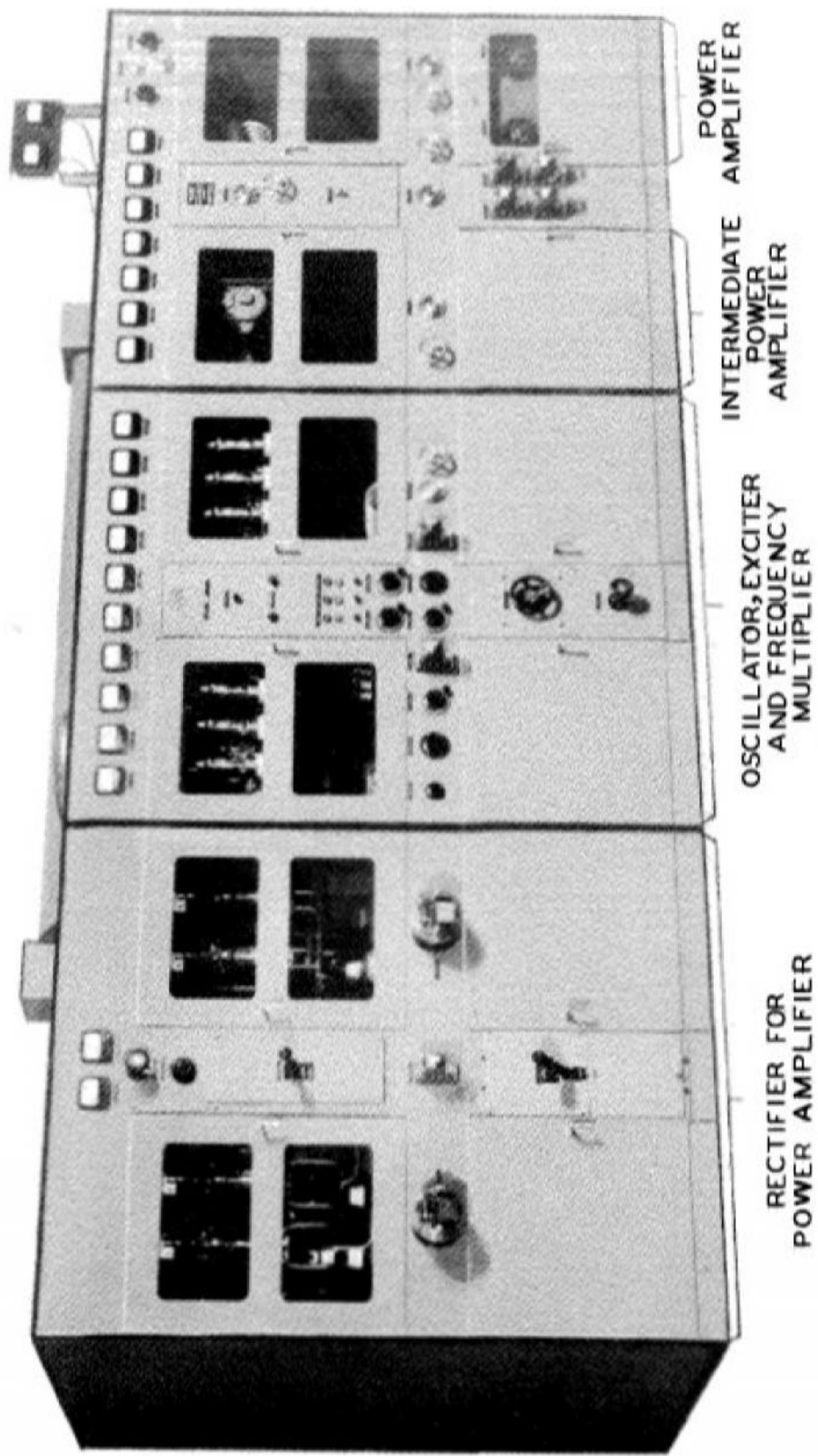

FIGURE 1489. Radio Transmitter (Press Wireless PW-40-())

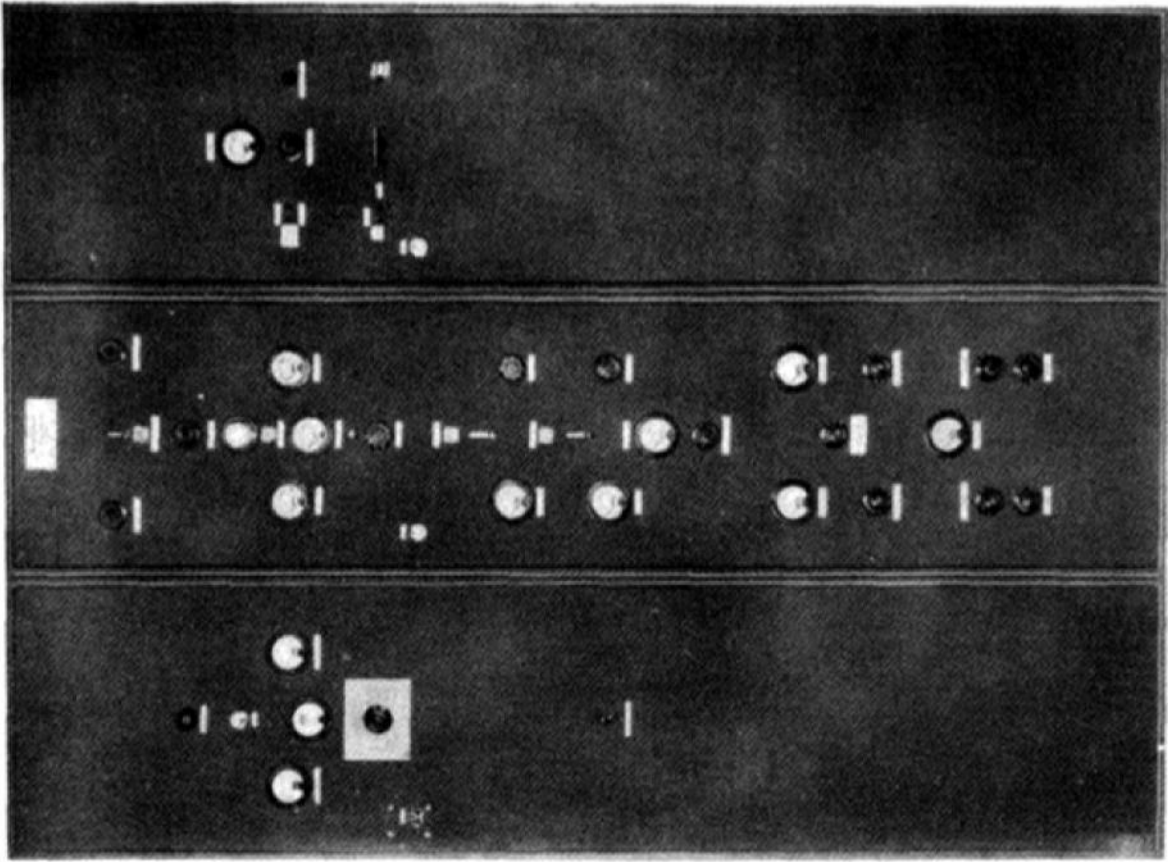

FIGURE 1491. Single Side Band Transmitter
(Western Electric Co. D-156000)

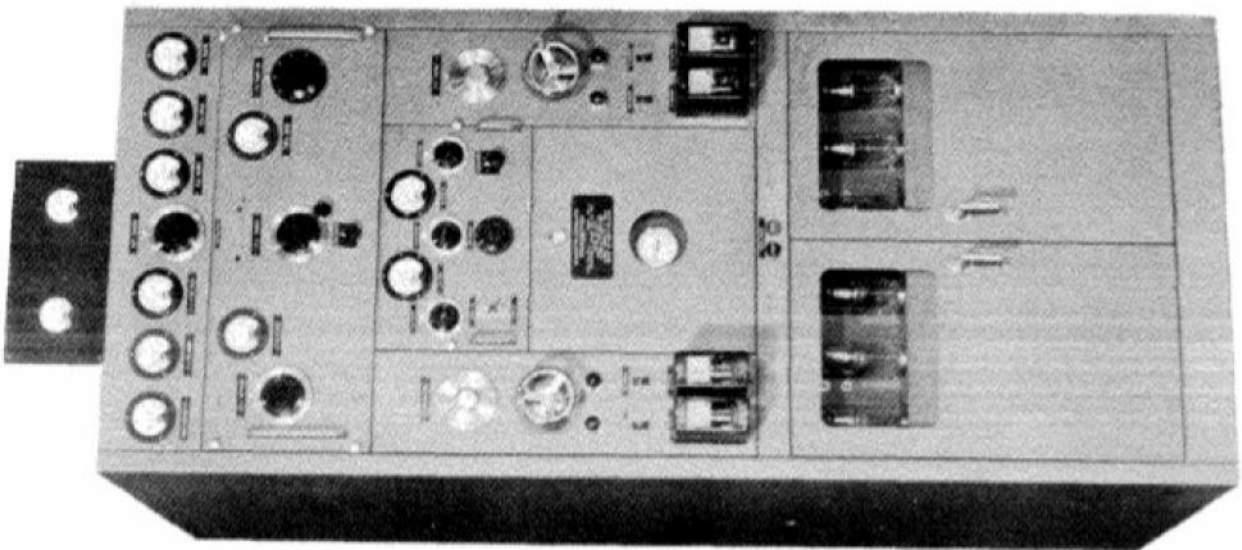

FIGURE 1490. Radio Transmitter
(Press Wireless 981-())

1423. RECEIVING EQUIPMENT COMMONLY USED BY COMMAND RADIO - ARMY COMMUNICATIONS SERVICE - DESCRIPTION

Type	Fig. No.	Type Emission Received ^a	Freq. Range-Mc	Freq. Control	Normal Antenna ^b	Type Output	Power Req.	Size in Oper. ft., c.	Weight in Use (Lbs.,)	Inst. Book or Tech. Man. ^d	Remarks
AM/FCC-1 Radio-teletype terminal equipment	-	See paragraph 1027									
AM/FER-3 Press Wireless Diversity	1482	Special	2.4-23	Ital (Holder FT-249)	2 Rhombics (Fig. 1539)	Dual Bal. 600 ohm	400W., 110/220 V, 1 φ, 50/60 cyc.	2x 1.5x7	650	TM 11-672	One unit; local or remote control; requires one terminal unit AM/FCC-1; used as radioteletype receiving station.
BC-779-()	1483	A1, A2 & A3	0.1-0.4 & 2.5-80	Manual	Rhombic or Double Doublet (Figs. 1539 & 1540)	SW. 600 or 8000 ohm, grounded	180W., 115/230 V, 1 φ, 50/60 cyc.	2x2x1	100	TM 11-666	Includes two units, receiver and power supply RA-94. For 105/115/125 volts, 50/60 cycles, use RA-94 and for 95-130/190-280 volt, 25/60 cycles, use RA-74 which must be ordered separately. Three of these receivers used with each Schutting Diversity equipment. Also used as manual receiving station. Similar to Hamarlund Super-Pro receiver.
BC-794-()	1485	A1, A2 & A3	1.25-40	Manual	Rhombic or Double Doublet (Figs. 1539 & 1540)	SW. 600 or 8000 ohm, grounded	180W., 115/230 V, 1 φ, 50/60 cyc.	2x2x1	100	TM 11-666	Same as BC-779 except for frequency range.
Schutting Diversity ^e (Mixing unit only)	1494	A1	-	Manual A.F. only	-	SW. Bal. 600 ohm	40W., 110/220 V, 1 φ, 50/60 cyc.	4x 1.5x7	850	2C863.1/82	One unit; local operation only; requires 2 racks, 3 ea. BC-779-() or BC-794-() and power supplies; used as receiving station for high speed tape circuit.
Western Electric Co. ⁶ D-99945	1495	Special	4.5-22	Ital (Spec. Holder)	Rhombic (Fig. 1539)	SW. Bal. 600 ohm	60W., 115 V, 1 φ, 50/60 cyc.	5.5x 1.5x7	1436	FTNP 2C4522/81	One unit; single-sideband triple detection receiver, contained in three bays. Used with WF Carrier Telegraph Equipment (par. 1025), single-sideband radio transmitting equipment (W.E.Co. D-155000 par. 1422) and associated testing and measuring equipment to form a single-sideband HF radio telegraph terminal.

^a A1 indicates continuous wave telegraphy; A2 indicates tone modulated telegraphy; A3 indicates voice transmission.

^b Figure numbers refer to sketches of representative antennas shown in paragraph 1426.

^c The first two dimensions are width and depth, respectively, and represent the area required by the designated equipment and do not represent the floor space required for the complete station installation. Allowance is not made for opening of apparatus doors or drawers, space between units, and operating and maintenance space for personnel. The last dimension is the height of the tallest unit.

^d The stock number is given when no other identification is available for the instruction book.

^e Type numbers assigned by the manufacturer.

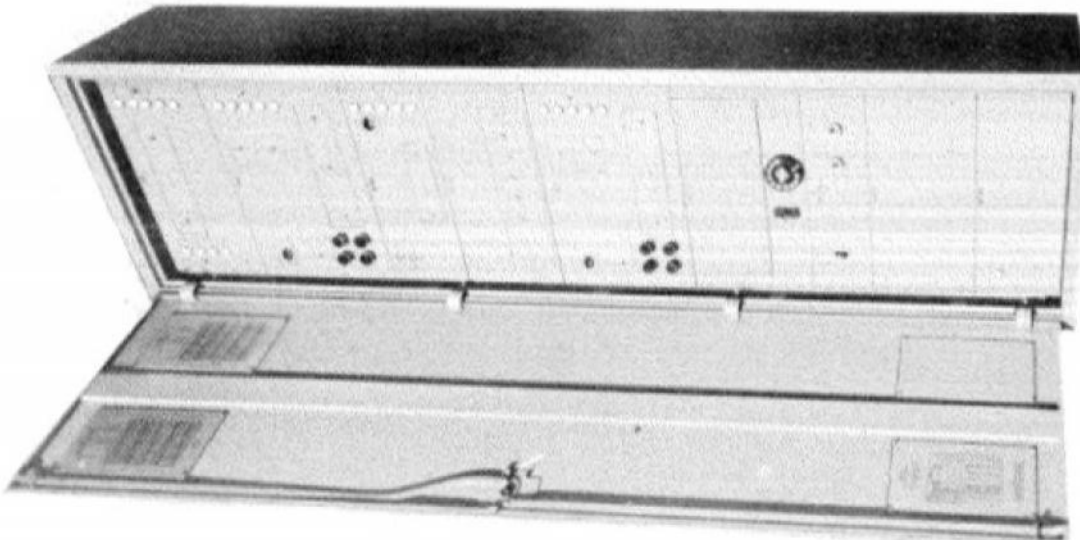

FIGURE 1492. Diversity Receiver
AN/FRR-3

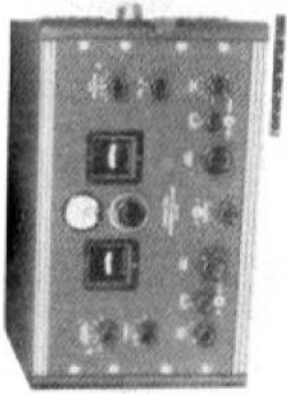

FIGURE 1493. Radio Receiver
BC-779-() (Hammarlund
Super Pro)

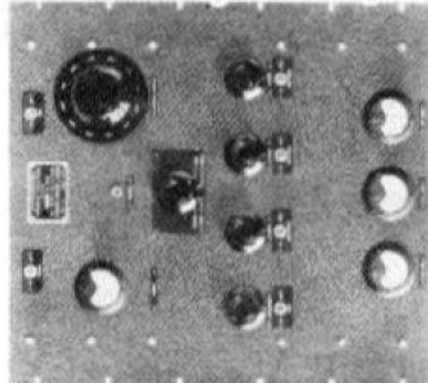

FIGURE 1494. Diversity
(Schuttig) Mixing
Unit

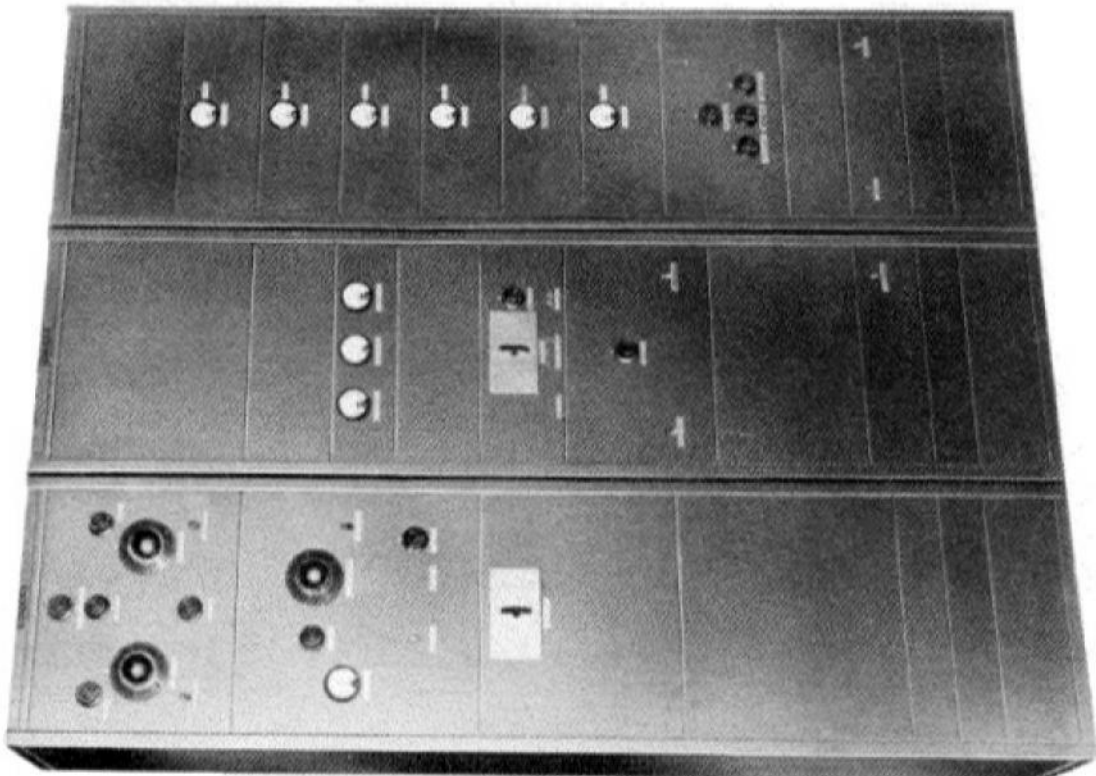

FIGURE 1495. Single Side Band Receiver (Western
Electric Co. D-99945)

1424. TRANSMITTING EQUIPMENT COMMONLY USED BY COMMAND RADIO - ARMY COMMUNICATIONS SERVICE - STOCK NUMBERS AND LOGISTICAL DATA.

<u>Type No.</u>	<u>Stock No.</u>	<u>Export Weight Lbs.</u>	<u>Export Volume Cu. Ft.</u>	<u>Ship Tons^a</u>
BC-339-()	2C6339()	2173	153	3.8
BC-365-()	2C6905-3.5()	965	84	2.1
BC-447-()	2C6903-31-1()	1247	92	2.3
SCR-281-()	2S281()	150	6.5	0.2
10 KW Transmitting Equipment	2C6905-100()	8294	470	11.8
Bunnell 6 KW ^b	2C466	10092	672	16.8
Press Wireless ^b PW-15-()	2C6890	12000	850	21.3
Press Wireless ^b PW-40-()	2C6895.1	21715	1661	41.6
Press Wireless ^b PW-981-()	2C6781A	3317	188	4.7
Western Electric Co. ^b D-156000 (Entire single-sideband radio telegraph terminal)	None (Part of entire terminal 2C5110) 2C5110 (without double modulation) 2C862.1 (double modulation eqpt.)	3724 11550 1190	315 758 60	7.9 19.0 1.5

1425. RECEIVING EQUIPMENT COMMONLY USED BY COMMAND RADIO - ARMY COMMUNICATIONS SERVICE - STOCK NUMBERS AND LOGISTICAL DATA.

<u>Type No.</u>	<u>Stock No.</u>	<u>Export Weight Lbs.</u>	<u>Export Volume Cu. Ft.</u>	<u>Ship Tons^a</u>
AN/FGC-1 Radioteletype Terminal Equipment	See paragraph 1027			
AN/FRR-3 Press Wireless Diversity	2S2001-3	1175	55	1.4
BC-779-()	2C4779()	210	11	0.3
BC-794-()	2C4794()	210	11	0.3
Schuttig Diversity ^b (Mixing unit only)	2C863.1	243	14	0.4
Western Electric Co. ^b D-99945	2C4522 (Also part of entire terminal 2C5110)	1906	161	4.0

^a40 cu.ft. assumed equivalent to 1 ship ton.^bType numbers assigned by the manufacturer.

1426. TRANSMITTING EQUIPMENT COMMONLY USED BY AIRWAYS SECTION - ARMY COMMUNICATIONS SERVICE - DESCRIPTION.

Type No.	File No.	Additional Equipment Required	Power Output	Type of Emission	Frequency Range	Freq. Control	Preset Channels	Normal Antenna	Power Required	Dimensions in Operation - H x W x D	Height in Use - (Ant., L, Manual)	Instr. Book or Manual	Remarks
BC-315	1496	Rect. & Modulator BA-18 Art. Tuning Unit BC-316 Remote Control Unit RM-5	400W	A1, A2, A3	2.0 - 18.1	Xtal (Holder PT-249)	10	Double Cage (Figure 1541)	4.5 KVA 220V, 3φ 60 cycles	7x2.5x6.5	3000	626040 626040-1	Point-to-point and ground-to-air. Dial selection of preset channel frequencies. No longer procured.
BC-325-()	1497	Remote Control Unit RM-7-()	400W 100W	A1 A2, A3	1.5 - 18.0	M.O. or Xtal (Holder PT-171)	None (See Remarks)	Double Cage (Figure 1541)	2.2 KVA 110/220V 1φ 60 cycles	3.5x2.5x6	900	627350	Point-to-point and ground-to-air. Switch selection of master oscillator or any one of five crystal frequencies. Also used as transmitter of 3CR-197. No longer procured.
BC-339-()	1498		1 KW	A1	4.0 - 26.5	M.O. or Xtal (Holder PT-164)	None (See Remarks)	Rhoohic or Doublet (Figures 1536 & 1537)	4.3 KVA 220V, 3φ 60 cycles	3.5x2.5x7	1336	627339()	Point-to-point. Switch selection of master oscillator or any one of six crystal frequencies. May also be used as exciter for Power Amplifier 5C-540-().
BC-540-() (Amplifier)	1499	Transmitter BC-339-() Rectifier BA-22-() Water Cooling Unit RW-2-()	20 KW	A1	4.0 - 26.5	-	None	Rhoohic or Doublet (Figures 1536 and 1537)	33 KVA 220V, 3φ 60 cycles	15x2.5x7	2038	202940 ()/1	Point-to-point. Provides approx. 10 db increase in power output when used with Transmitter BC-339.
BC-565-()	1498	Remote Control Unit RM-10-()	350W	A1	0.15-0.55	M.O.	None	Intermediate Frequency Flat Top (Figure 1538)	1.8 KVA 110/220V 1φ 60 cycles	2.5x2.5x6.5	629	74 11-088	Point-to-point.
BC-401-()	1499	Rect. & Modulator BA-50-() Remote Control Unit RM-11-()	400W	A1, A2, A3	2.0 - 18.1	Xtal (Holder PT-249, Collins 1D or WE-5A)	10	Double Cage (Figure 1541)	3.7 KVA 220V, 3φ 60 cycles	5x2.5x6.5	600	626040-2	Point-to-point and ground-to-air. Dial selection of preset channel frequencies. No longer procured.
BC-460-()	1490	Remote Control Unit RM-20-()	250W 200W	A1 A2, A3	2.0 - 18.0	M.O. or Xtal (Holder PT-249)	10	Double Cage (Figure 1541)	1.8 KVA 220V, 1φ 60 cycles	3x2x6.5	1060	626020-3 626020-4	Point-to-point and ground-to-air. Dial selection of preset channel frequencies.

^aAll indicates continuous wave telegraphy; A2 indicates amplitude modulated tone telegraphy; A3 indicates amplitude modulated telephony. M.O. is used to indicate Master Oscillator control and Xtal to indicate crystal control.

^bFigure numbers refer to sketches of representative antennas shown in paragraph 1428 except where reference is made to paragraph 1408.

^cIncludes power required for equipment shown in "Additional Equipment Required" column.

^dThe first two dimensions represent width and depth respectively, and indicate the area required by the designated equipment plus the equipment listed in the "Additional Equipment Required" column, and do not represent the floor space required for the complete station installation. Allowance is not made for opening of apparatus doors or drawers, space between units, and operating and maintenance space for personnel. The last dimension is the height of the tallest unit.

^eThis weight does not include that for equipment shown in "Additional Equipment Required" column.

^fWhen other identification is not available for instruction books, the stock number is shown.

^gLate models are same as Navy TDO and are M.O. controlled only.

Table continued on next page

TRANSMITTING EQUIPMENT COMMONLY USED BY AIRWAYS SECTION — ARMY COMMUNICATIONS SERVICE — DESCRIPTION. (Continued)

Draw No.	Fig. No.	Additional Equipment Required	Power Output	Type of Emission	Frequency Range-Mc	Freq. Control	Preset Channels	Normal Antenna	Power Required	Dimensions in Operation - Ft. (Lbs.)	Weight in Use of Instr. Manual	Remarks
BC-010	1501		400W 300W	A1 A3	2.0 - 18.0	M.O. or Ital (Holder FT-171)	None	1/4-or 3/4-Wave Inverted L or Doublet (Figures 1458 par. 1408, and 1537)	2 KVA 115V, 1φ 50/60 cycles	2.5x2x5	446	TM 11-613 Point-to-point and ground-to-air. Similar to Hallcrafters commercial type HT-4-B and transmitter of SCR-899, SCR-399 and SCR-499. Includes Speech Amplifier BC-614-E and Antenna Tuning Unit BC-039-A.
BC-042	1502	Modulator BC-043 Rectifier RA-44 Transformer and Contacter BC-044 Remote Control Unit RM-15	5 KW	A1, A3	4.0 - 20.0	Ital (Holder Collins 1D)	10	Rhombic or Doublet (Figures 1415 & 1537)	10 KVA 220V, 3φ 60 cycles	6.5x2x5.5	590	20305.30- 1/1 Point-to-point. Dial selection of preset channel frequencies. No longer procured.
BC-1100-()	1503		75W 50W	A1 A3	1.5 - 10.0	Ital (Holder FT-849)	4	1/4-or 3/4-Wave Inverted L or Doublet (Figures 1459 par. 1408, and 1537)	500W 110/220V 1φ, 25-60 cycles	3.5x2.5x1.5	403	Point-to-point and ground-to-air. May be remotely controlled by addition of Remote Control Unit RM-40-A. Part of Radio Transmitter Equipment BC-803.
BC-52-()	1504		500W	A1, A2, A3	1.5 - 7.0	Ital (Holder FT-104)	2	Rhombic or Doublet (Figures 1536 & 1537)	2.5 KVA 115V/220V 1φ, 60 cycles	3.5x2x5	1250	609052() Point-to-point and air warning. Includes Radio Transmitter BC-452-() and Remote Control Unit RM-22-().
T-4/FRG	1505	Rectifier PP-1/FRG Modulator MD-1/FRG Operator Control Console CY-101/FRG (Formerly CS-81.2)	400W	A1, A2, A3	2.0 - 18.0	M.O. or Ital (Holder FT-849)	1	Rhombic or Doublet (Figures 1536 & 1537)	8 KVA (4 Channels) 220V 1φ, 50/60 cycles	1x2x5 per channel (Transmitter Only)	TM 11-680	Point-to-point and ground-to-air. May be used in conjunction with Transmitter T-5/FRG. Typical installation uses four T-4/FRG, one T-5/FRG, one MD-1/FRG and one PP-1/FRG.

^aA1 indicates continuous wave telegraphy; A2 indicates amplitude modulated tone telegraphy; A3 indicates amplitude modulated telephony.
^bM.O. is used to indicate Master Oscillator control and Ital to indicate crystal control.

^cFigure numbers refer to sketches of representative antennas shown in paragraph 1428 except where reference is made to paragraph 1408.
^dIncludes power required for equipment shown in "Additional Equipment Required" column.

^eThe first two dimensions represent width and depth respectively, and indicate the area required by the designated equipment plus the equipment listed in the "Additional Equipment Required" column, and do not represent the floor space required for the complete station installation. Allowance is not made for opening of apparatus doors or drawers, space between units, and operating and maintenance space for personnel. The last dimension is the height of the tallest unit.

^fThis weight does not include that for equipment shown in "Additional Equipment Required" column.
^gWhen other identification is not available for instruction books, the stock number is shown.

Type No.	Fig. No.	Additional Equipment Required	Power Output	Type of Modulation	Frequency Range*	Freq. Control	Power Channels	Normal Antenna	Power Required	Dimensions in Operation - H x W x D (Inches)	Weight in Use (Lbs.)	Inst. in Use, Book or Manual	Remarks
T-5/FBC	1506	Rectifier PP-1/FBC Modulator MD-1/FBC Operator's Control Console CT-161/FBC (Formerly CS-212)	600W	A1, A2, A3	0.15-0.55	M.O. or Kial (Holder FT-249)	1	Insulated Tower 8 kVA or Intermediate (4 Channels) Frequency Flat 850V, 1 ϕ 50/60 cycles (Figures 1542 & 1538)	8 kVA 19C/245V, 1 ϕ , 60 cycles	2x2x5 per channel (Transmitter Only)	TK 11-880	Point-to-point and homing. May be used in conjunction with transmitter T-4/FBC. Rectifier PP-1/FBC will supply power for four transmitter units and one dual modulator unit.	
Aircraft Accessories Corp. 5008	1506		1000W	A1, A2, A3	0.275-0.44 1.6-10.0	Kial (Holder FT-249)	2	1/2-90-ft. or 180-ft. Insulated Tower or Intermediate Frequency Flat Top (Figures 1542 & 1538) RF-rhombic or Doublet (Figures 1536 & 1537)	6.5 kVA 19C/245V, 1 ϕ , 60 cycles	8x2x7	MD3608/21	Point-to-point and homing. Includes Antenna Tuning Unit 500 MAT and Remote Control 500 RLC. Provides two RF channels for simultaneous operation. Either channel may be modulated, the other operating on CW. Simultaneous operation requires two antennas.	
Collins ^b SC-2A	1507		75W 50W	A1 A3	1.5-15.0	M.O. or Kial (Holder Collins 1C)	4	1/4-or 3/4-Wave Inverted L or Doublet (Figures 1458 par. 1406, and 1537)	115V, 1 ϕ 30/60 cycles	2x1.5x1	120	60K913C-846P or 60K913C-2A7P	Point-to-point, Ground-to-air and airport control. Includes RF unit, modulator and power supply in one case.
Federal ^h FT-300	1508		5 kW	A1, A3	2.0-20.0	Kial (Holder FT-249)	1 (per RF unit)	Rhombic or Doublet (Figures 1536 & 1537)	220V, 3 ϕ 60 cycles	11x5x6	252700/21	252700/21	Point-to-point. Normally 8 channels per rectifier and modulator. Includes Power Supply 115-4, Audio Amplifier 125-4, remote control unit, and 8 Radio Frequency Units 124-4. Dial selection of desired channel.
Pan American Airways ^a 15-AC1-C	1509		1200W	A1, A3	1.6-24.0	Kial (Holder FT-249)	2	Rhombic or Doublet (Figures 1536 & 1537)	5 kVA 210/250V, 1 ϕ , 60 cycles	2x1.5x5.5			Point-to-point. Push button selection of either preset channel frequency.

*A1 indicates continuous wave telegraphy; A2 indicates amplitude modulated tone telegraphy; A3 indicates amplitude modulated telephony.

M.O. is used to indicate Master Oscillator control and Kial to indicate crystal control.

Figure numbers refer to sketches of representative antennas shown in paragraph 1428 except where reference is made to paragraph 1406.

^dIncludes power required for equipment shown in "Additional Equipment Required" column.

^eThe first two dimensions represent width and depth respectively, and indicate the area required by the designated equipment plus the equipment listed in the "Additional Equipment Required" column, and do not represent the floor space required for the complete station installation. Allowance is not made for opening of apparatus doors or drawers, space between units, and operating and maintenance space for personnel. The last dimension is the height of the tallest unit.

^fThis weight does not include that for equipment shown in "Additional Equipment Required" column.

^gWhen other identification is not available for instruction books, the stock number is shown.

^hType numbers assigned by the manufacturer.

Table continued on next page

TRANSMITTING EQUIPMENT COMMONLY USED BY AIRWAYS SECTION — ARMY COMMUNICATIONS SERVICE — DESCRIPTION. (Continued)

Type No.	Fig. No.	Additional Equipment Required	Power Output	Type of Modulation	Frequency Range-Mc	Freq. Control	Pre-set Channels	Normal Antenna ^c	Power Required ^d	Dimensions in Operation - Ft.	Weight in Use - Lbs.	Inst. Book of Reference ^e	Remarks
Pan American Airways ^h 1P-GLY-2	1510		1200W 750W	A1 A2, A3	0.25-1.75	Ital (Holder PT-249)	2	T Cage (Furnished) (Figure 1543)	3.2 AVA 210/250W, 1½, 60 cycles	2.5x1.5x5.5			Point-to-point and homing. Includes Modulator CM-6, Antenna Tuning Unit ATU-12, and Remote Control Unit MC-2. Dial selection of either preset channel frequency.
Pan American Airways ^h EPA-50 (Amplifier)	1511	Transmitter PAA 1P-ACX-2	5 KW	A1, A2, A3	5.0-24.0	-	None	Rhoebic or Doublet (Figures 1536 & 1537)	800/240V, 3½ 50/60 cycles	5x2x6.5			Point-to-point. No longer procured.
Press Hireless ^h PW-10LF	1512		10 KW	A1	0.11-0.14	M.O.	None	Insulated Tower or Wave Antenna (Figures 1542 & 1544)	250W, 3½ 60 cycles	9x5x7 (See Remarks)	206888/81		Point-to-point and Radio-teletype. Consists of two units, transmitter and rectifier, normally bolted together. Antenna coil mounts on top of transmitter and adds 3-1/2 ft. in height.
Temco ^h 250-GSC	1513		200W	A1, A2, A3	2.0-16.0	M.O. or Ital (Holder PT-249)	None	1/4-or 3/4-Wave Inverted L or Doublet (Figures 1456 par. 1408, and 1537)	1.2 KVA 205/235V, 1½ 50/60 cycles	2x2x6	P4-30390		Point-to-point and ground-to-air. Switch selection of master oscillator or key one of four crystal frequencies. May be controlled over 1000 yds. of #18 Ga. copper wire by use of remote control box furnished.
Temco ^h 1000-AG-OW	1514		1000W	A1	2.0-16.0	Ital (Holder Eliley MC-7)	6	1/4-or 3/4-Wave Inverted L or Doublet (Figures 1456 par. 1408, and 1537)	3.2 KVA 115V, 1½ 50/60 cycles	3x2.5x7	2200	609600	Point-to-point and ground-to-air. No longer procured.
Western Electric Co. ^h D-151249 (Pan Amer. Airways 6B77A)	1515		350W 100W	A1 A3	1.6-13.2	Ital (Holder WE-5A or PT-249)	2	Doublet (Figure 1537)	220/250V, 1½ 50/60 cycles	2x2x6	571	609654	Point-to-point and ground-to-air. Consists of radio frequency chassis, modulator and power supply mounted in one cabinet. Relay selection of either of the preset channel frequencies. No longer procured.

^aA1 indicates continuous wave telegraphy; A2 indicates amplitude modulated tone telegraphy; A3 indicates amplitude modulated telephony.

^bM.O. is used to indicate Master Oscillator control and Ital to indicate crystal control.

^cFigure numbers refer to sketches of representative antennas shown in paragraph 1458 except where reference is made to paragraph 1408.

^dIncludes power required for equipment shown in "Additional Equipment Required" column.

^eThe first two dimensions represent width and depth respectively, and indicate the area required by the designated equipment plus the equipment listed in the "Additional Equipment Required" column, and do not represent the floor space required for the complete station installation. Allowance is not made for opening of apparatus doors or drawers, space between units, and operating and maintenance space for personnel. The last dimension is the height of the tallest unit.

^fThis weight does not include that for equipment shown in "Additional Equipment Required" column.

^gWhen other identification is not available for instruction books, the stock number is shown.

^hType numbers assigned by the manufacturer.

Type No.	Fig. No.	Additional Equipment Required	Power Output	Type of Mission ^a	Frequency Range-Kc.	Freq. Control	Preset Channels	Normal Antenna ^c	Power Required	Dimensions in Operation - ft. x ft. x ft.	Weight In Use (lbs.)	Inst. In Use, Book or Manual ^d	Remarks
Wilcox ^h 90A	1516	Rect. & Mod. 26A or 26B Dialing Unit 1668B	2.5 KW	A1, A5	2.0 - 15.0	Ktal (Holder FT-849)	1	1/4-or 3/4-wave Inverted L, Rhombic or Rhombic (Figures 1458 par. 1408, 1536 and 1537)	220V, 3φ 60 cycles	12x26 per channel (Transmit- ter Only)	609098A	Point-to-point and radio- teletype. Normally 8 channels per rectifier. No longer procured.	
Wilcox ^h 90C & 90C-5	1517	Rectifier 26A Modulator 50A Operator's Control Console CI-16L/FIC (Formerly CS-212)	3 KW	A1, A2, A5	2.0 - 20.0	Ktal (Holder FT-849)	1	1/4-or 3/4-wave Inverted L, Rhombic or Rhombic (Figures 1458 par. 1408, 1536 & 1537)	20 KVA (4 channels) 220V, 3φ 60 cycles	12x26 per chair- net Plus 8.5 x 3x6	609090C P4-290689	Point-to-point and radio- teletype. Normally 4 channels per rectifier.	
Wilcox ^h 90-800A	1518	Rect. & Mod. 26A or 26B Operator's Control Console CS-390	2 KW	A1, A2, A5	0.195-0.525 M.O. or Ktal	(Holder FT-849)	1	Insulated Tower or Wave Antenna (Figures 1542 & 1544)	10 KVA 220V, 3φ 60 cycles	3x2x6 per channel (Transmit- ter Only)		Point-to-point and homing. No longer procured.	
Wilcox ^h 90-300B	1519	Rect. & Mod. 26A or 26B Operator's Control Console CS-390	2 KW	A1, A2, A5	0.195-0.525 M.O. or Ktal	(Holder FT-849)	1	Insulated Tower or Wave Antenna (Figures 1542 & 1544)	10 KVA 220V, 3φ 60 cycles	3x2x6 per channel (Transmit- ter Only)		Point-to-point and homing.	

^aA1 indicates continuous wave telegraphy; A2 indicates amplitude modulated tone telegraphy; A5 indicates amplitude modulated telephony.
^bM.O. is used to indicate Master Oscillator control and Ktal to indicate crystal control.

^cFigure numbers refer to sketches of representative antennas shown in paragraph 1426 except where reference is made to paragraph 1408.
^dIncludes power required for equipment shown in "Additional Equipment Required" column.

^eThe first two dimensions represent width and depth respectively, and indicate the area required by the designated equipment plus the equipment listed in the "Additional Equipment Required" column, and do not represent the floor space required for the complete station installation. Allowance is not made for opening of apparatus doors or drawers, space between units, and operating and maintenance space for personnel. The last dimension is the height of the tallest unit.

^fThis weight does not include that for equipment shown in "Additional Equipment Required" column.

^gWhen other identification is not available for instruction books, the stock number is shown.

^hType numbers assigned by the manufacturer.

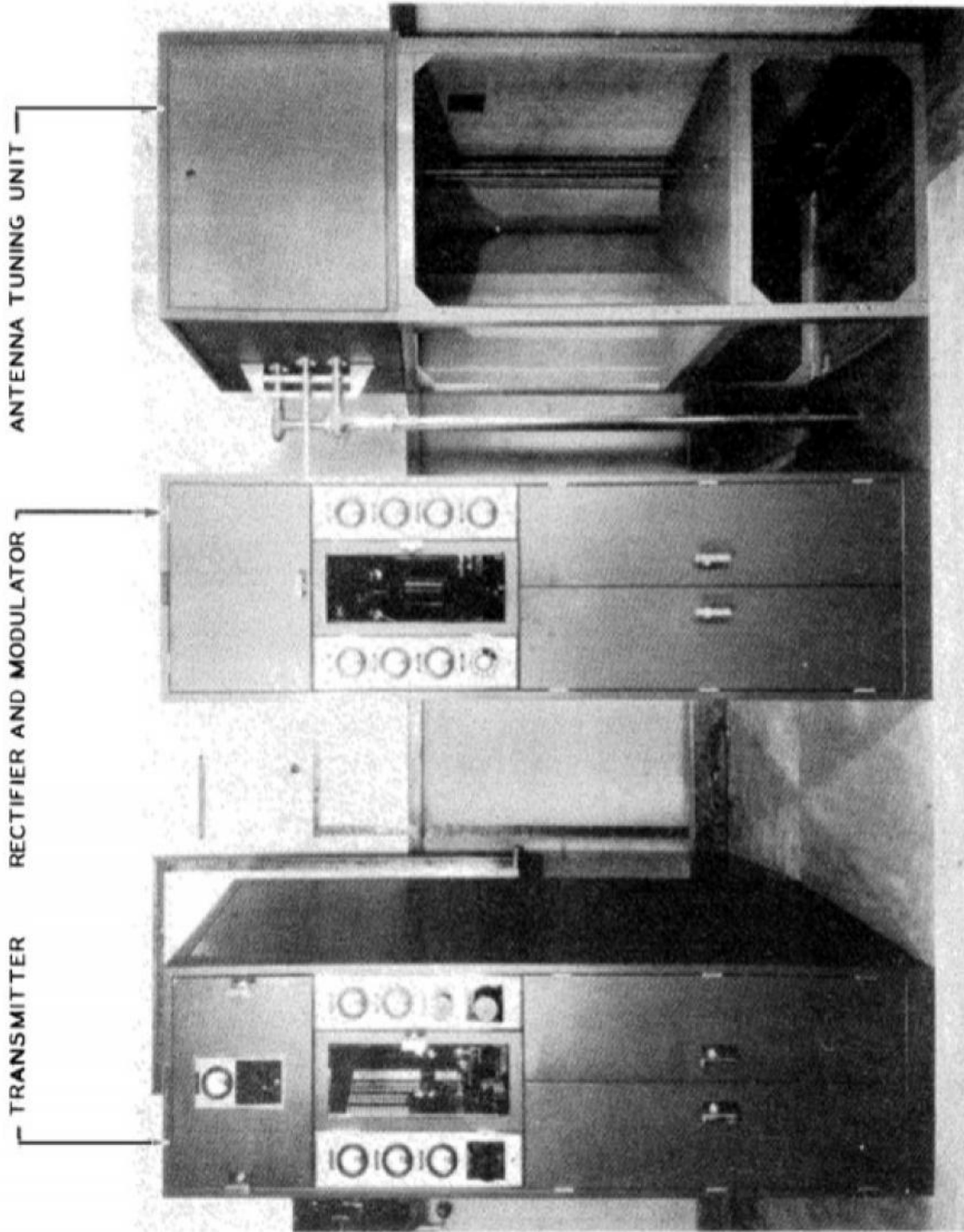

FIGURE 1496. Radio Transmitter BC-315

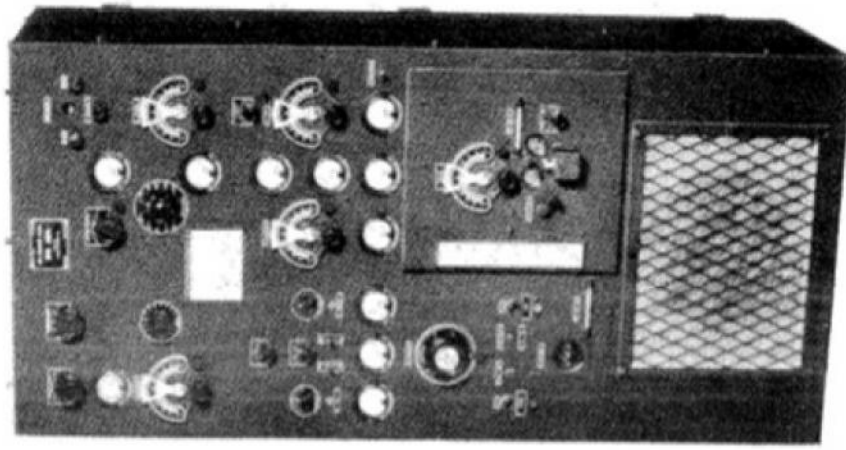

FIGURE 1497. Radio Transmitter BC-325-()

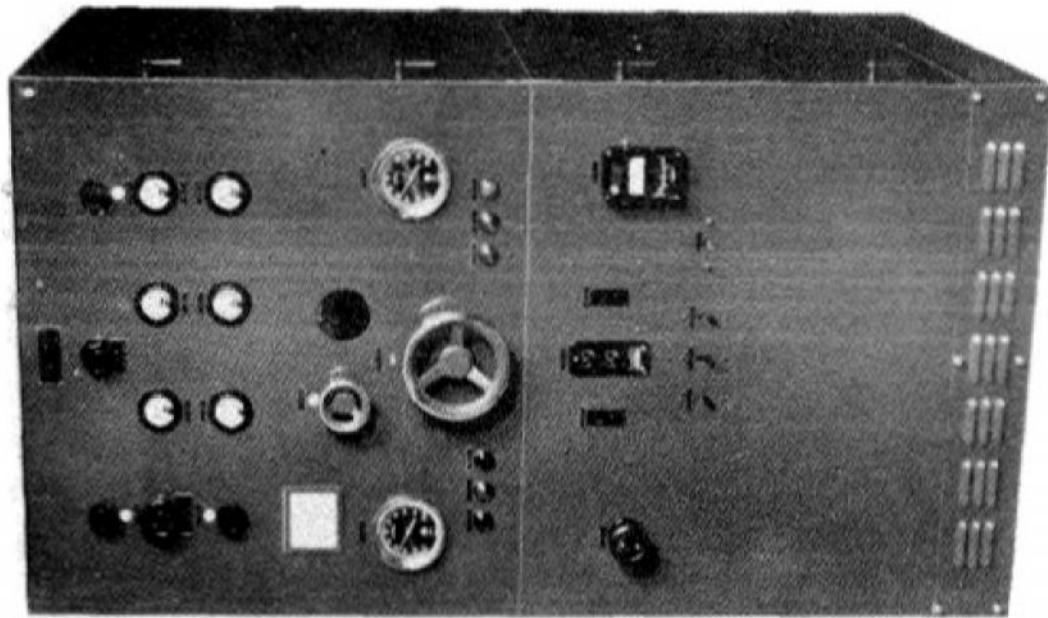

FIGURE 1498. Power Amplifier
BC-340-()

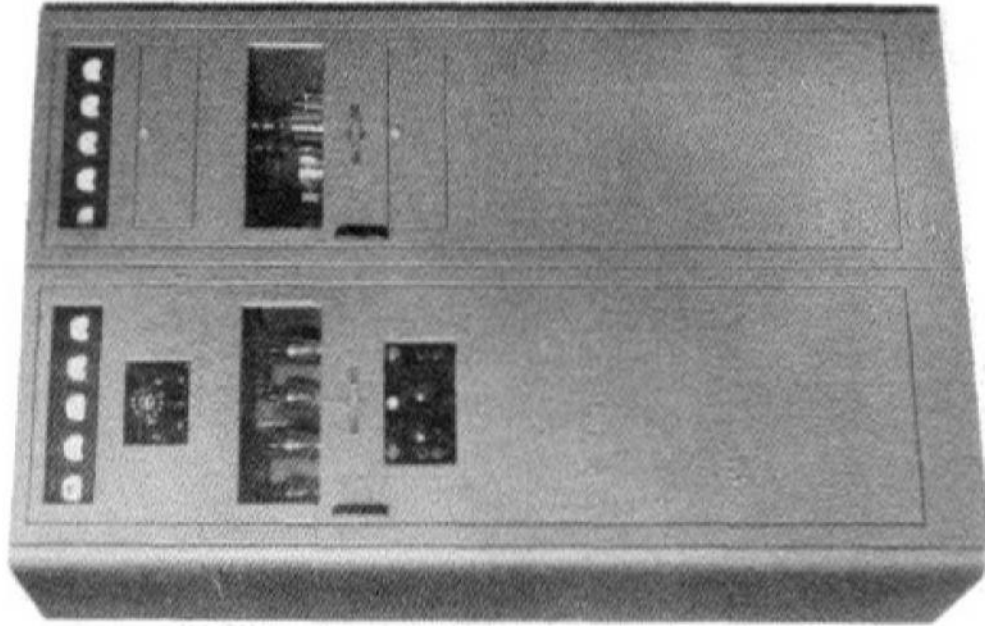

FIGURE 1499. Radio Transmitter BC-401

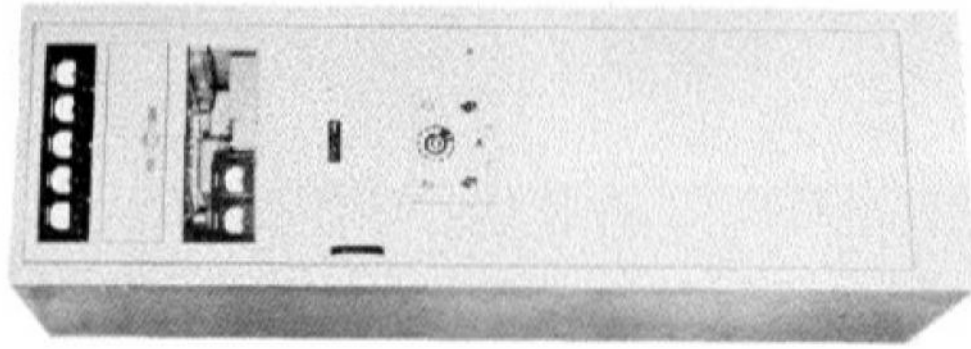

FIGURE 1500. Radio
Transmitter BC-460

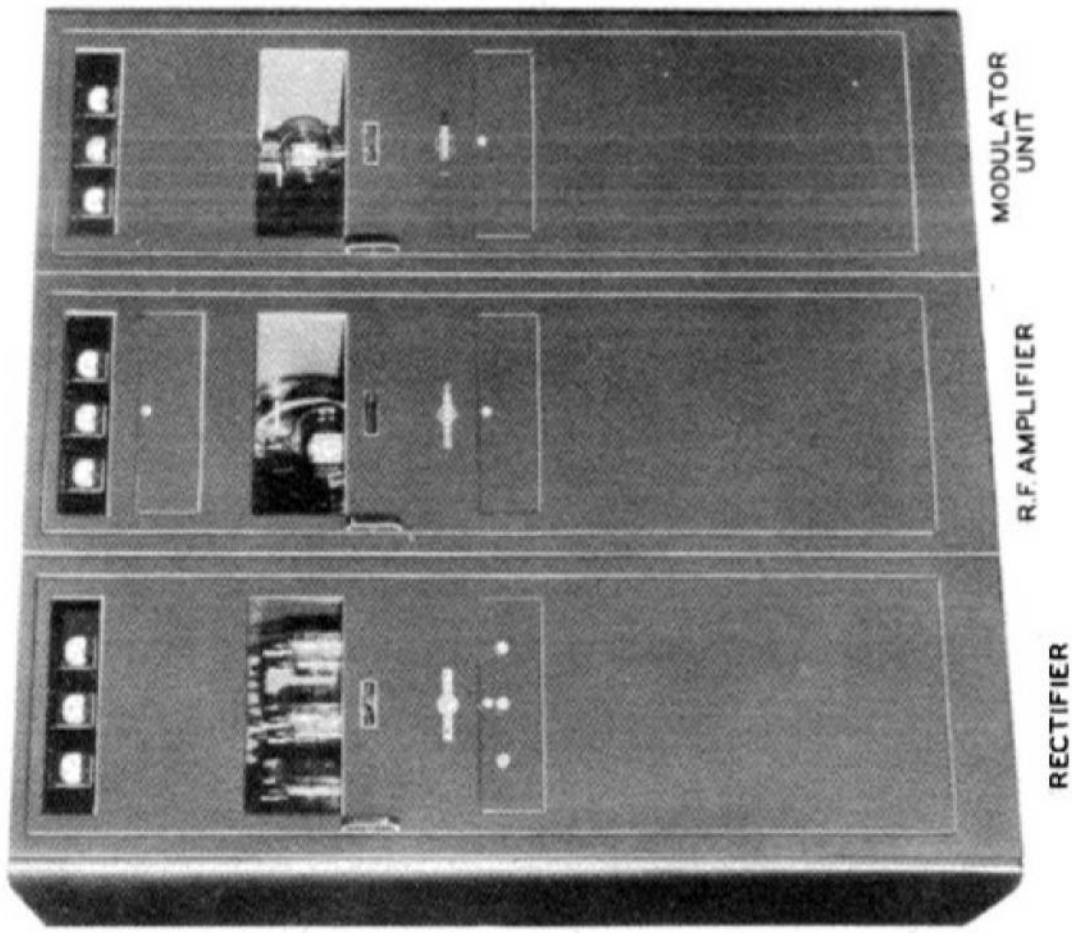

FIGURE 1502. Radio Transmitter BC-642

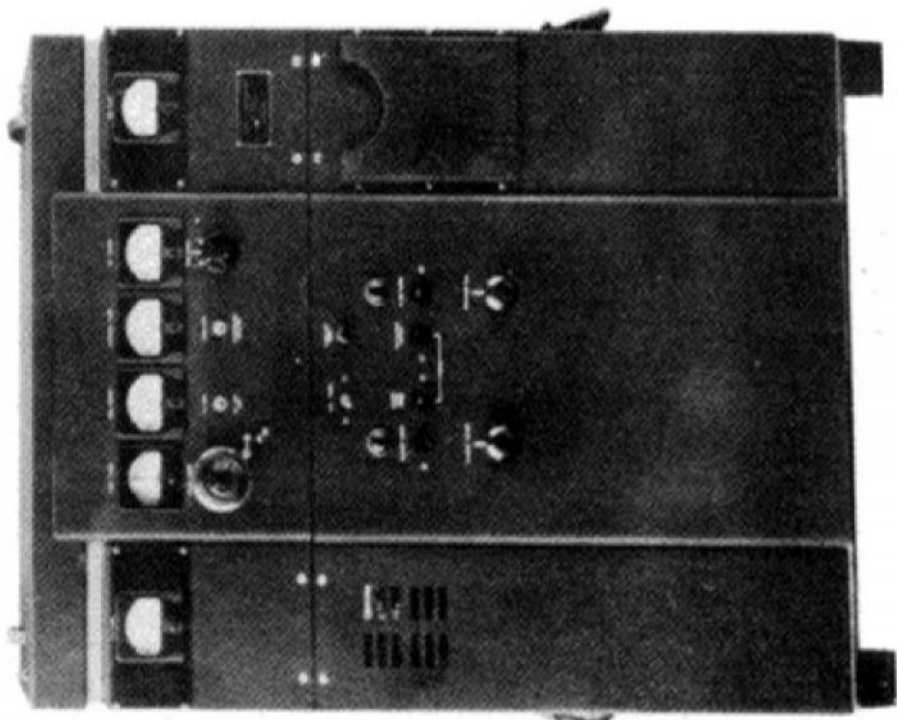
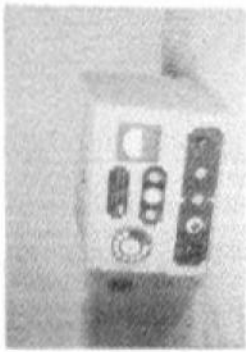
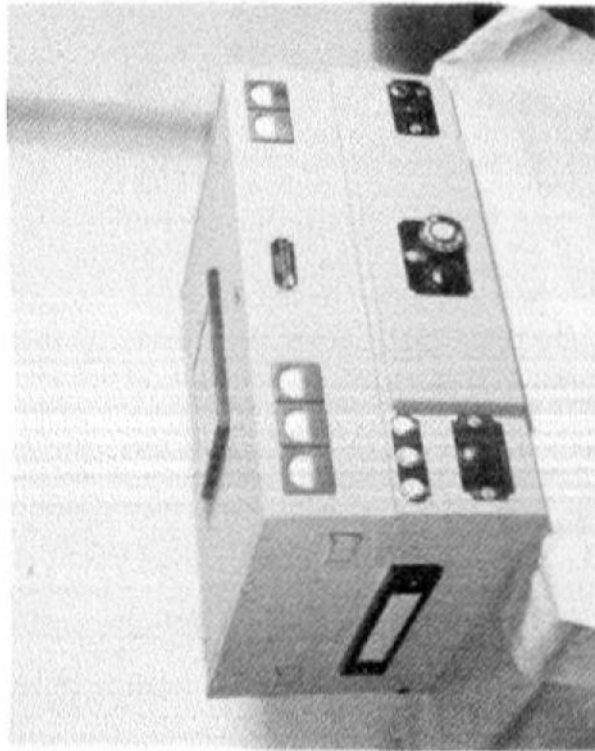

FIGURE 1501. Radio Transmitter BC-610



Remote Control Unit RM-40



Radio Transmitter

FIGURE 1503. Radio Transmitter BC-1100-()

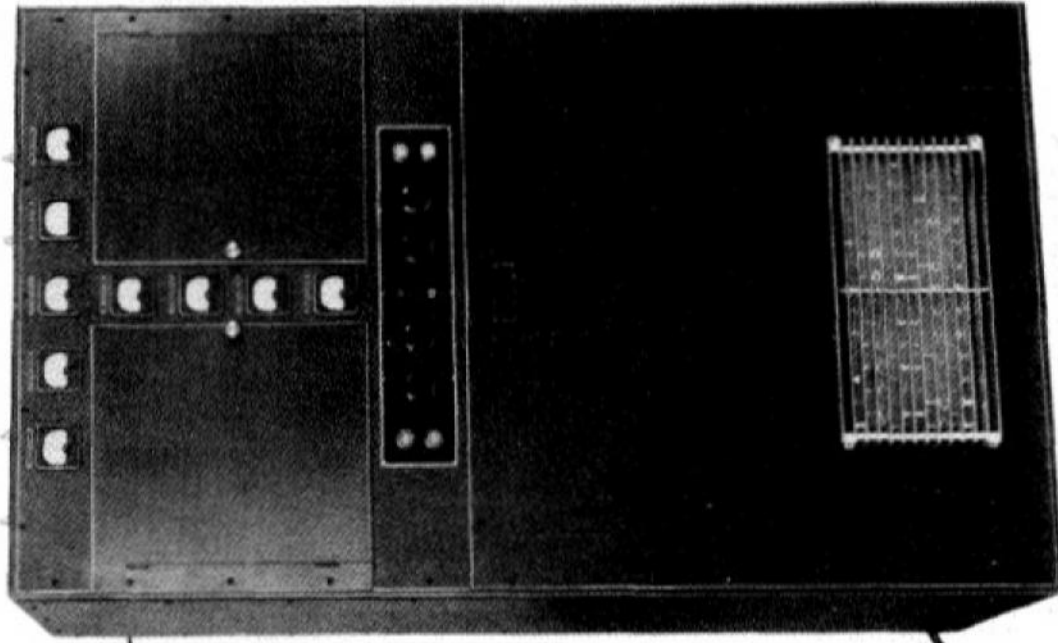

RADIO TRANSMITTER
BC-452-L ()

REMOTE CONTROL UNIT
RM-22-()

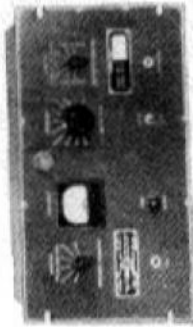

FIGURE 1504. Radio Transmitting Equipment RC-52-()

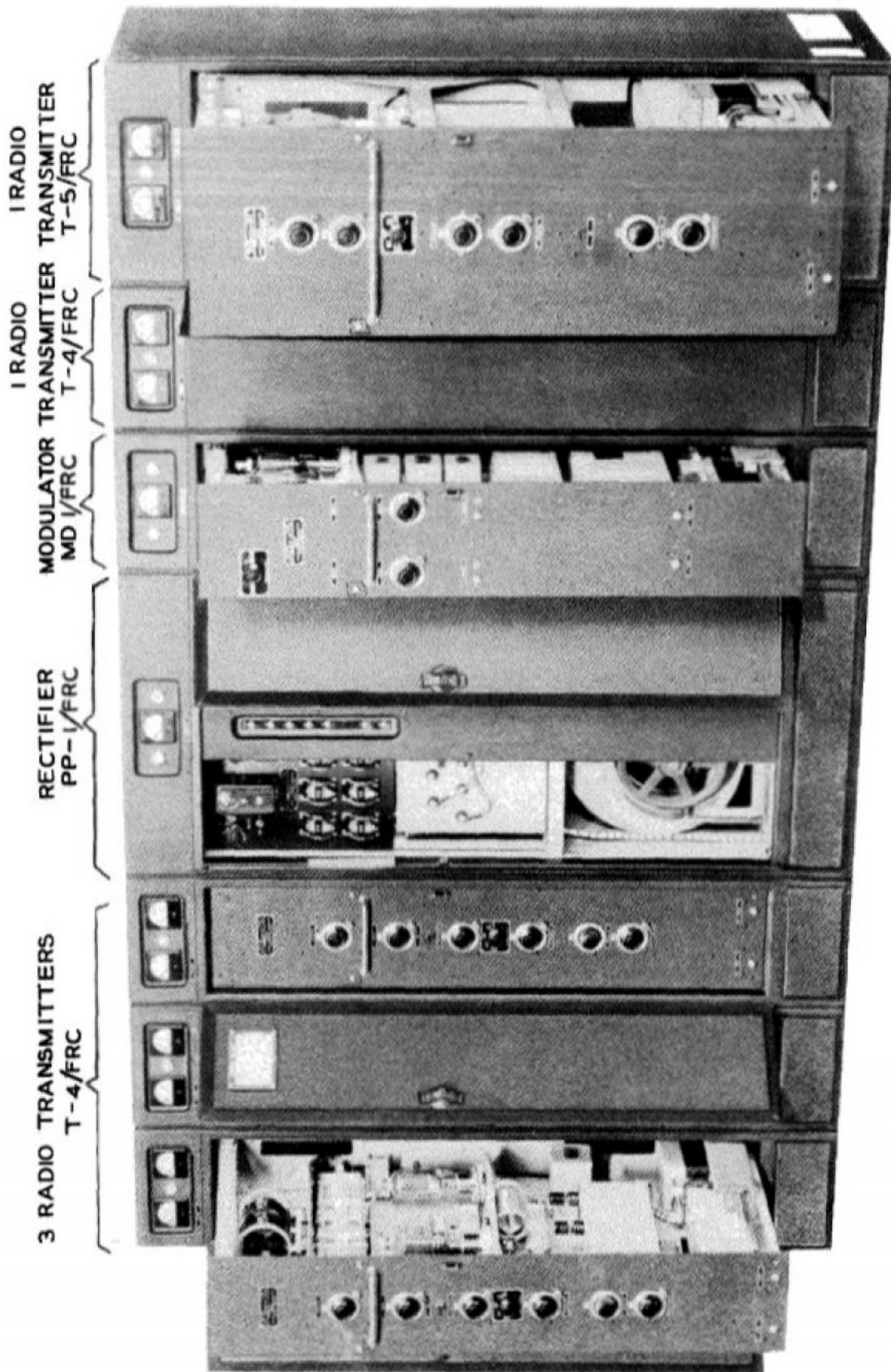

FIGURE 1505. Radio Transmitter T-4/FRC and T-5/FRC Installation

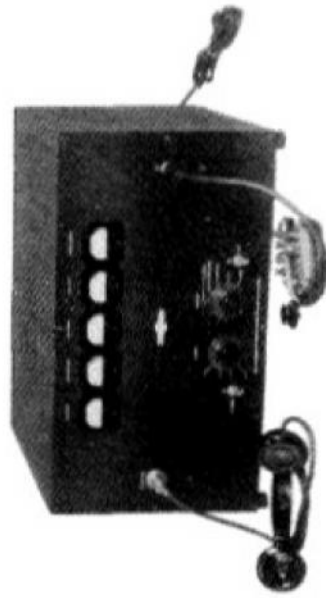

FIGURE 1507. Radio Transmitter
(Collins 32FA)

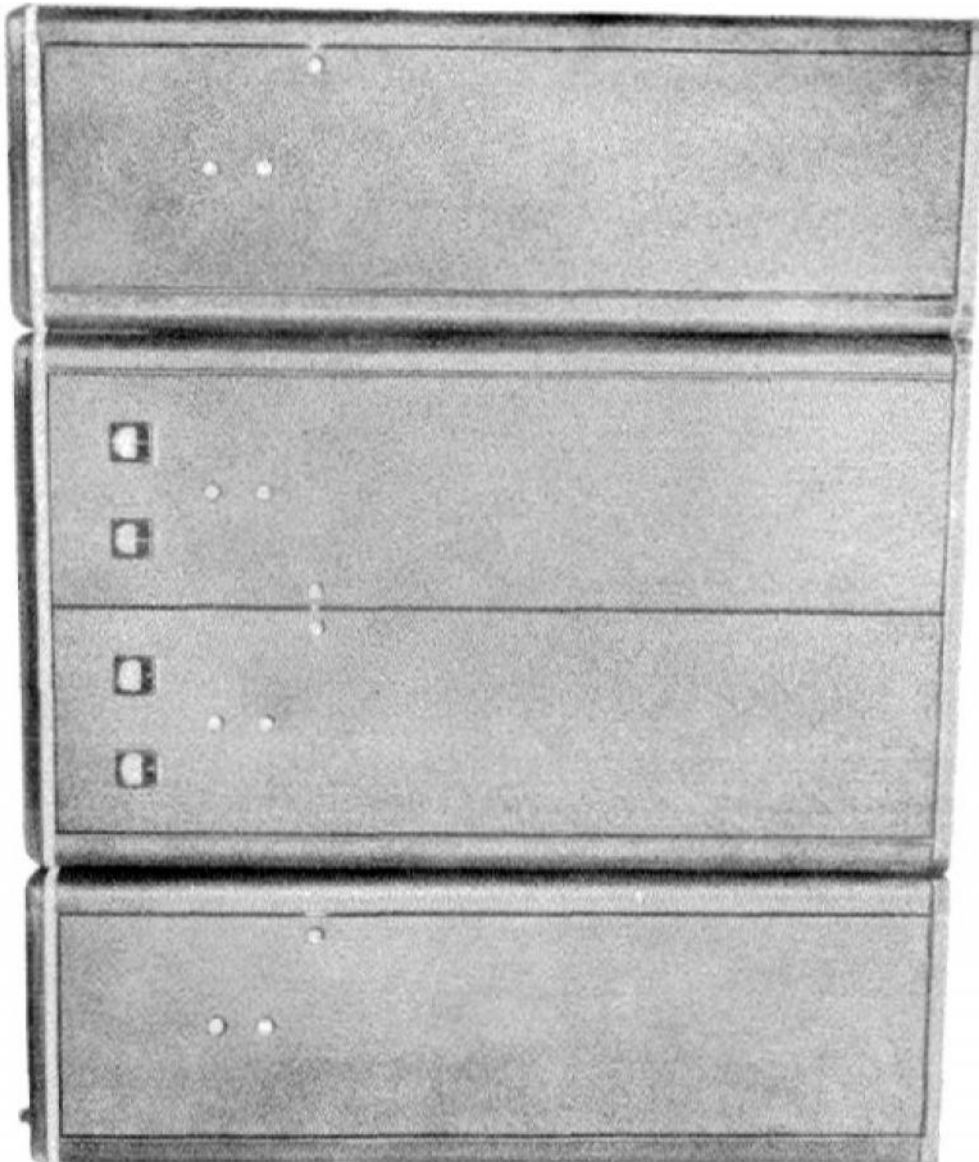

FIGURE 1506. Radio Transmitter (Aircraft Accessories Corp. 500B)

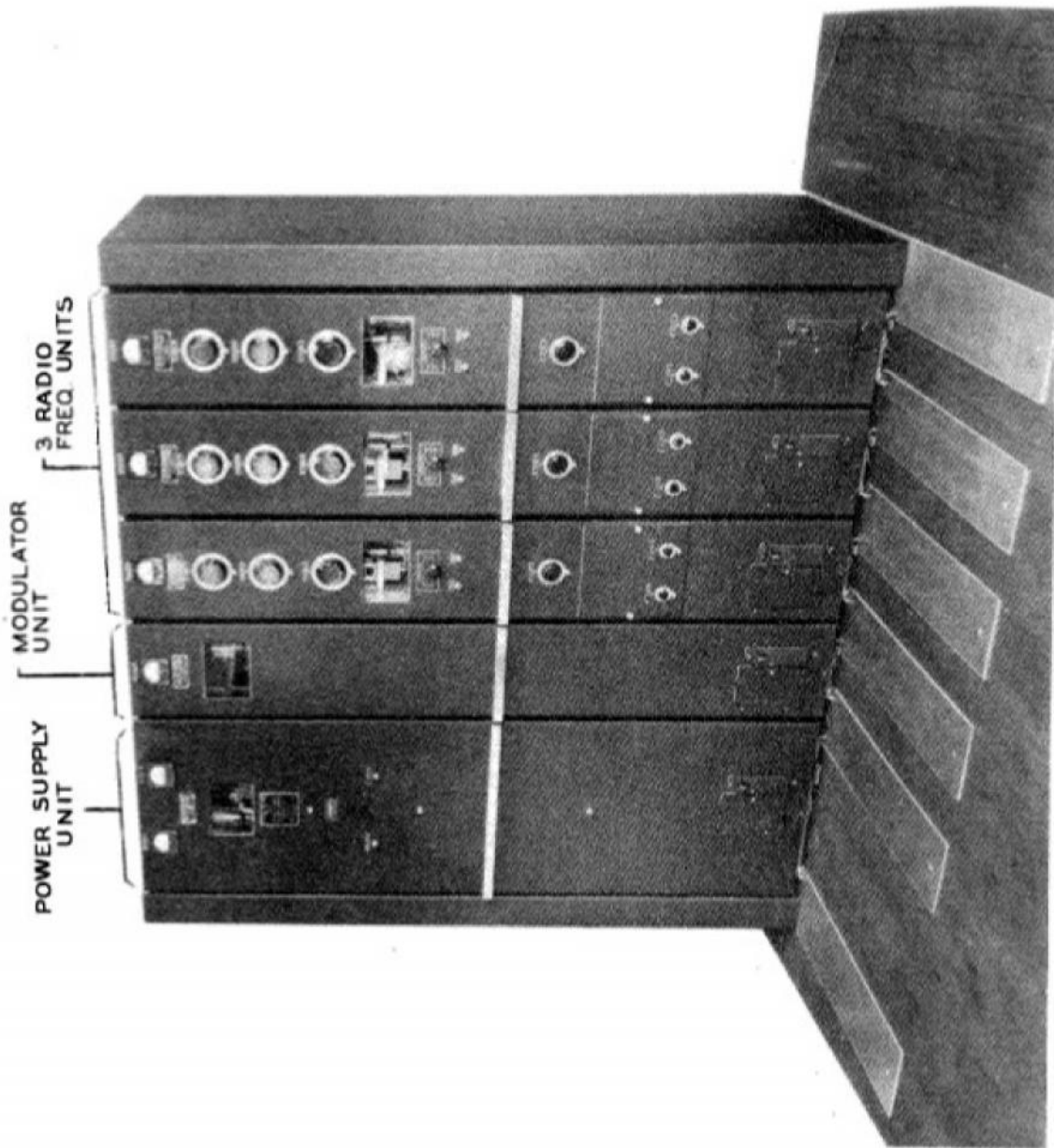

FIGURE 1508. Radio Transmitter (Federal FT-300)

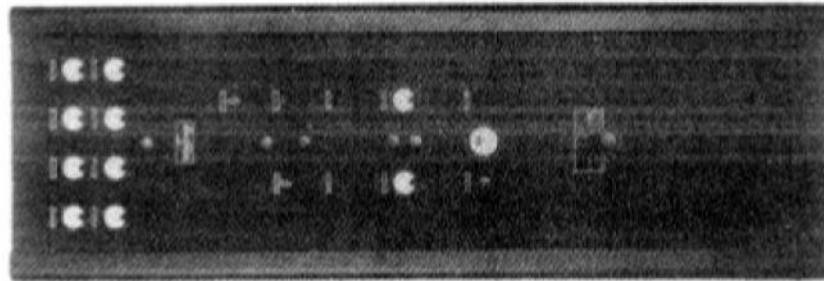
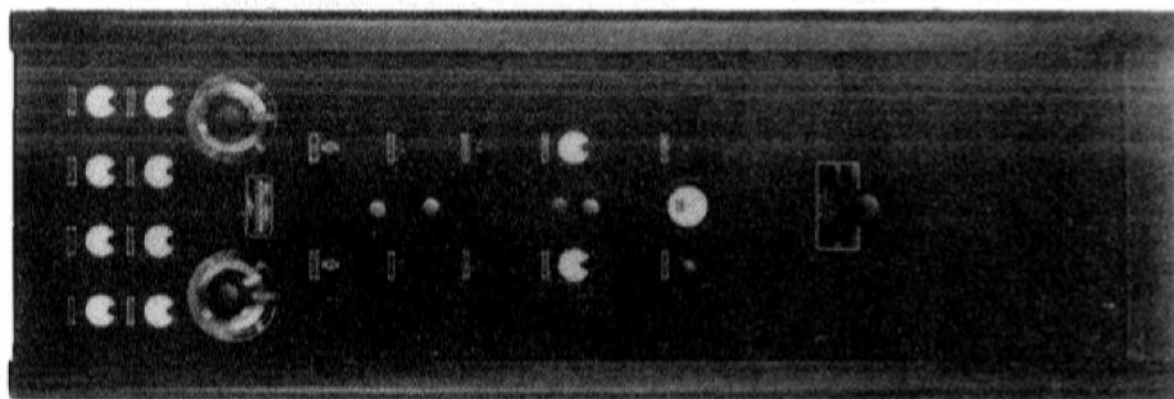
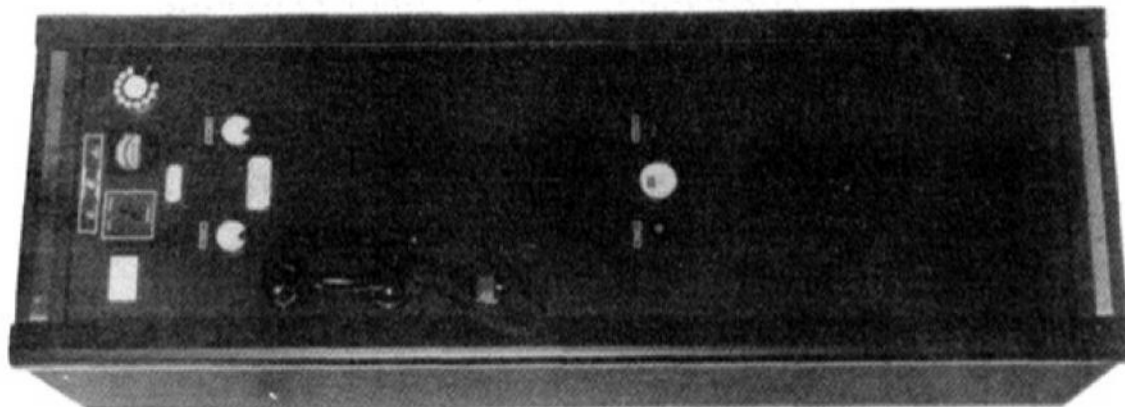

FIGURE 1509. Radio Transmitter (Pan American Airways 12ACX-2)



Transmitter 12 GLX-2



Modulator CM-8



Transmitter Control TMC-R

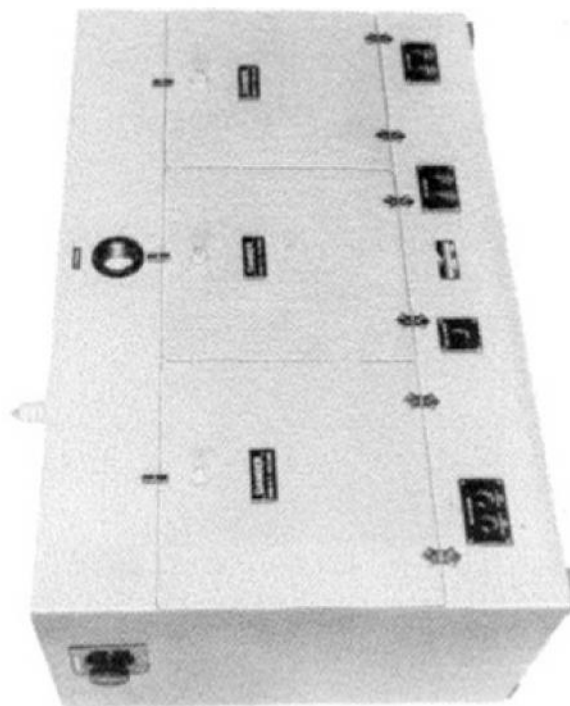

Antenna Tuning Unit ATU-12

FIGURE 1510. Radio Transmitter (Pan American Airways)

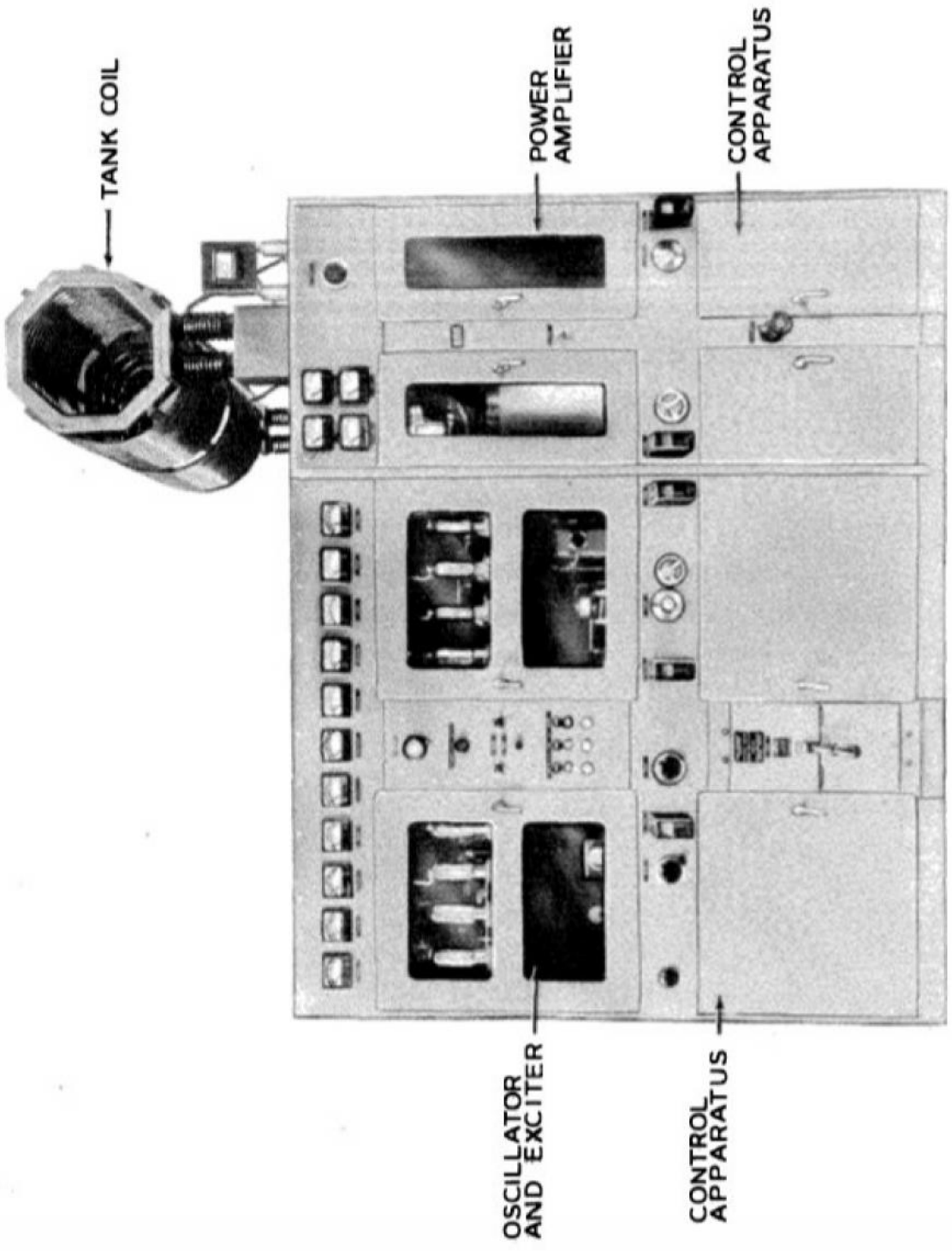

FIGURE 1512. Radio Transmitter (Press Wireless PW-10LP)

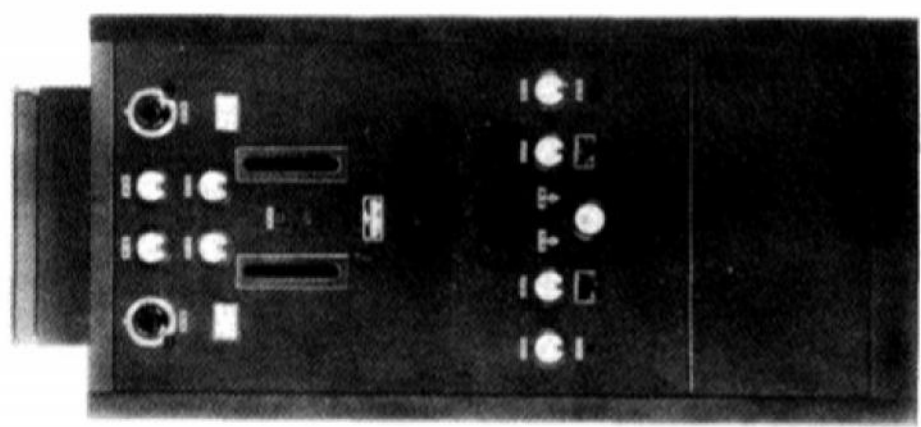

FIGURE 1511. Power Amplifier (Pan American Airways RFA-50)

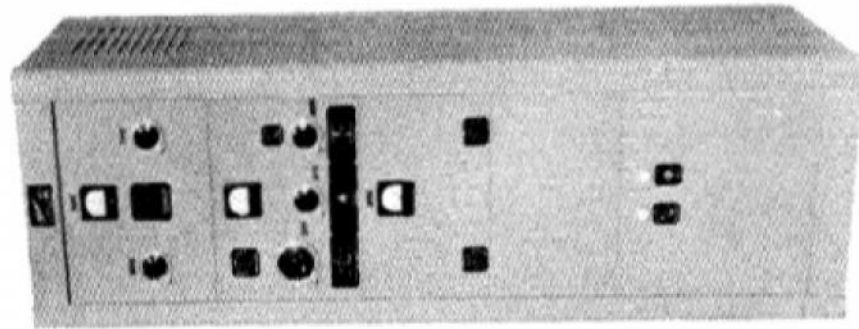

FIGURE 1513. Radio Transmitter
(Temco 250-GSC)

REMOTE CONTROL BOX

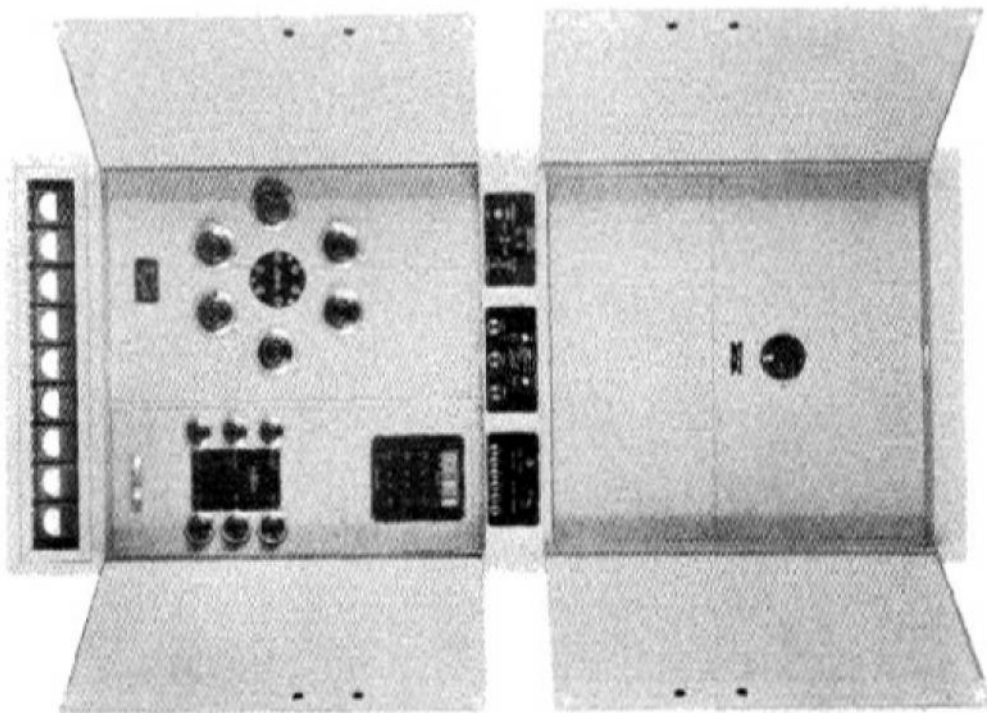
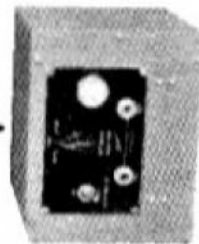

FIGURE 1514. Radio Transmitter (Temco 1000-AG-CW)

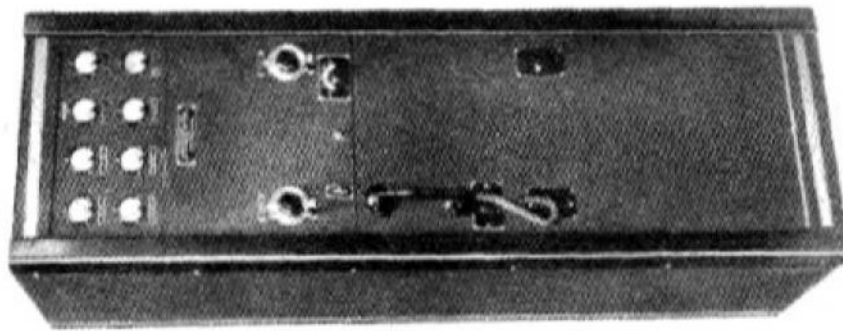
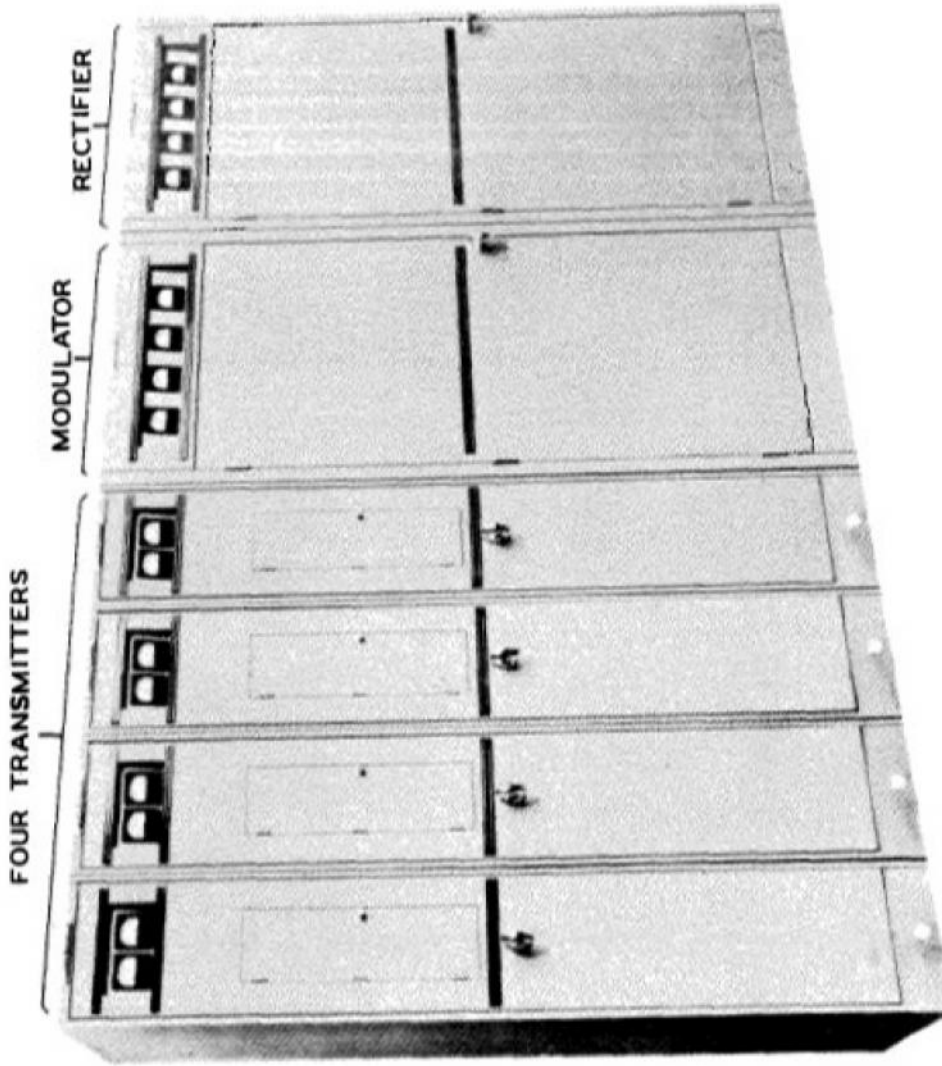

FIGURE 1515. Radio
Transmitter (Western
Electric Co. D-51249 or
Pan American Airways
4WTFA)



FOUR TRANSMITTERS

MODULATOR

RECTIFIER

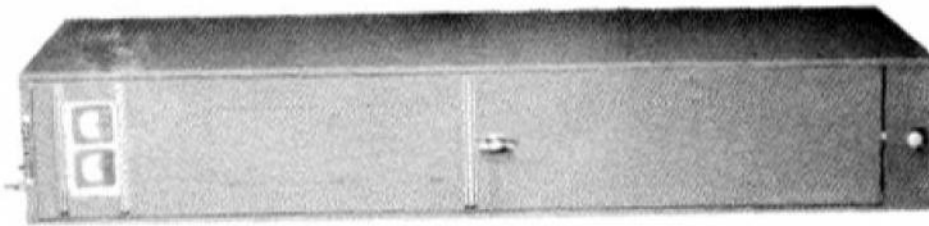

FIGURE 1517. Four Radio Transmitters (Wilcox 96C)
(With Modulator 50A and Rectifier 36A)

FIGURE 1516. Radio Transmitter
(Wilcox 96A)

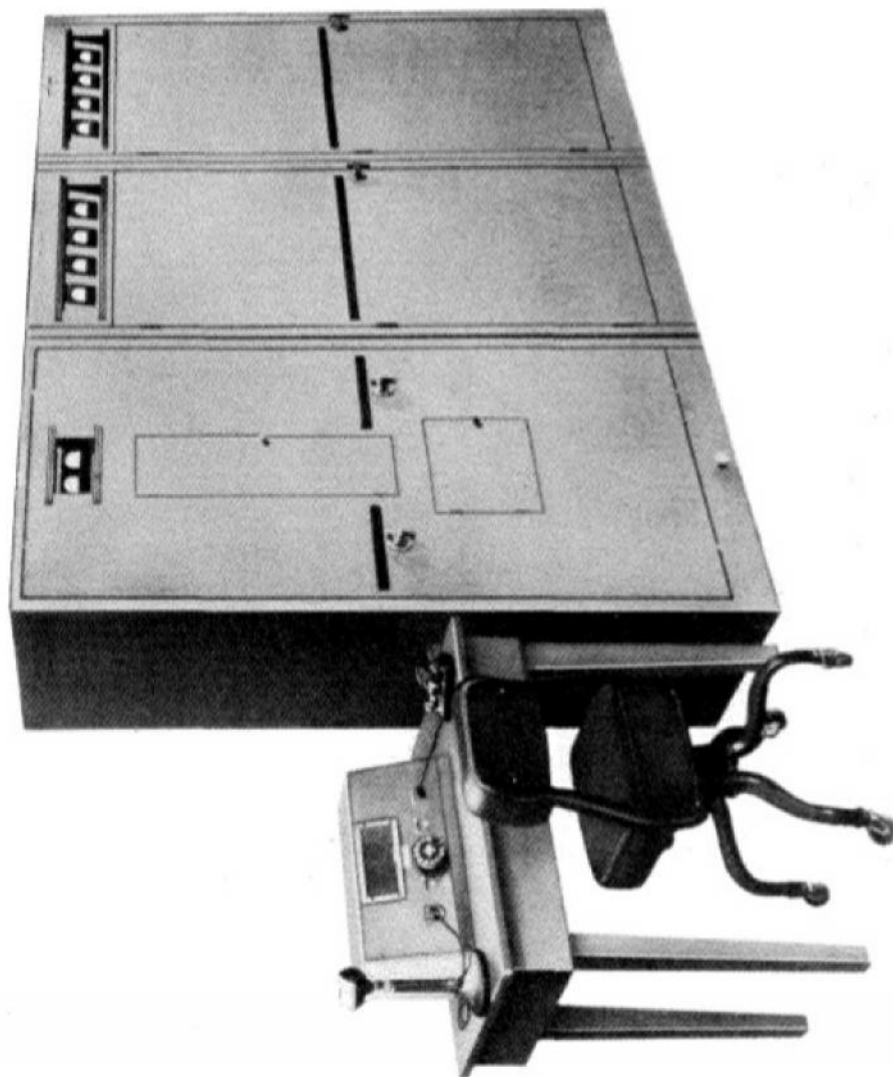

FIGURE 1518. Radio Transmitter (Wilcox 96-200-())

1427. RECEIVING EQUIPMENT COMMONLY USED BY AIRWAYS SECTION -- ARMY COMMUNICATIONS SERVICE -- DESCRIPTION.

Type No. ^a	Fig. No.	Type Emission Received ^b	Frequency Range - Mc	Freq. Control	Normal Antennae	Type Output	Power Required	Weight in Use (Lbs.)	Instr. Bk. or Manual	Remarks
AM/FCC-1 Radioteletype Terminal Eqpt.	-	See paragraph 1027								
AM/FR-3 Press Wireless Diversity	1492	A1,A2,A3 Special	2.4-26	Crystal (Holder FT-249)	Double Doublet or Rhombic (Figures 1540 & 1539)	Into Teletype Terminal Eqpt. AM/FCC-1	110/220V 50/60 cycles			Five preset channels. For point-to-point communication and radioteletype. Used with Radioteletype Terminal Unit AM/FCC-1.
Federal 120-A1	1519	A1,A2,A3	0.015-0.65	Manual	Single wire	Speaker or Headset	115V, 60 cycle AC or batteries	28	601947	Marine or fixed station service. Table model. Built-in power supply unit.
Hallcrafters S-22-R	1520	A1,A2,A3	0.11-1.54 1.7-18	Manual	Single wire or Double Doublet (Figure 1540)	Built-in Speaker, or Headset	115V, 60 cycle AC or DC	25	609461	Marine or fixed station service. Table model. Built-in power supply.
Hallcrafters S27	1521	A1,A2,A3 & FM	27-145	Manual	Single wire or Double Doublet (Figure 1540)	Speaker or Headset 500 ohms 5000 ohms	115V, 50/60 cycle AC	75	609462	Airport control and air warning. Table model. Built-in power supply.
Hallcrafters SI-28 AM/GER-3	1522	A1,A2,A3	0.55-42	Manual	Single wire or Double Doublet (Figure 1540)	Speaker or Headset 500 ohms 5000 ohms	110/125V 50/60 cycle AC	85	609471	Point-to-point and ground-to-air. Table model. Built-in power supply.
Hallcrafters S29	1523	A1,A2,A3	0.54-30.5	Manual	3 ft. Built-in telescopic whip	Built-in Speaker or Headset	110/125V AC or DC, or self-cont. batteries	18	609464	Highly portable for miscellaneous monitoring.

^aExcept for AM/FCC-1, AM/FR-3 and AM/GER-3 the type numbers are those assigned by the manufacturer.

^bA1 indicates continuous wave telegraphy; A2 indicates amplitude modulated tone telegraphy; A3 indicates amplitude modulated telephony; FM indicates frequency modulated telephony and tone telegraphy.

^cFigure numbers refer to sketches of representative antennas shown in paragraph 1428.

^dWhen no other identification is available for the instruction book, the stock number is given.

Type No. ^a	Fig. No.	Type Extension Received ^b	Frequency Range - Mc	Freq. Control	Normal Antennae ^c	Type Output	Power Required	Weight in Use (lbs.)	Instr. Bk. or Manual ^d	Remarks
Hallcrafters S-36	1594	A1, A2, A3 & FM	27.0-145	Manual	Single wire or Double Doublet (Figure 1540)	Speaker or Headset 500 or 5000 ohms	115V, 50/60 cycle AC	75	804557-56/51	Similar to Hallcrafters S-27 receiver except treated for tropical use. Airport control and air warning. Built-in power supply. Table model.
Hammarlund SP-110-LX (Super Pro)	1493	A1, A2, A3	0.1-0.4 & 2.5-80	Manual	Single wire or Double Doublet (Figure 1540)	Speaker or Headset 600 or 6000 ohms batteries	110/125V 25 cycle AC, or batteries	100	M-17275	Airport control, point-to-point and ground-to-air. Separate power supply included. Modified table model.
Hammarlund SP-210-LX (Super Pro)	1493	A1, A2, A3	0.1-0.4 & 2.5-80	Manual	Single wire or Double Doublet (Figure 1540)	Speaker or Headset 600 or 6000 ohms batteries	110/125V 60 cycle AC, or batteries	100	6D9450B1	Airport control, point-to-point and ground-to-air. Separate power supply included. Rack mounting.
National NC-100-A3C AM/CRR-2	1525	A1, A2, A3	0.2-0.4 & 1.5-80	Manual	Single wire or Double Doublet (Figure 1540)	Speaker or Headset	115V, 50/60 cycle AC or 115V, 25 cycle AC	65	6D96520	Point-to-point and ground-to-air. Table model. Built-in power supply. Separate loud speaker included.
National B10	1526	A1, A2, A3	1.7-80	Manual	Single wire or Double Doublet (Figure 1540)	Speaker or Headset	115V, 50/60 cycle AC or batteries	90	M-10986	Point-to-point and ground-to-air. Table model. Uses plug-in coils which are inserted as a unit. Coil sets must be procured separately. Separate power supply included.
Willcox QMS	1527	A1	1.15-25.5	Crystal (Holder FT-249)	Single wire or Double Doublet (Figures 1540 & 1539) or Rhombic (Figures 1540 & 1539)	Speaker or Headset	115V, 50/60 cycle AC	6D9695	Point-to-point and ground-to-air. Rack mounting. Uses plug-in coils and crystal which must be procured separately. Eight QMS Receivers, in a pre-wired rack, available as a unit (Willcox 113A Receiver Bay).	

^aExcept for AM/CRR-2 the type numbers are those assigned by the manufacturer.

^bA1 indicates continuous wave telegraphy; A2 indicates amplitude modulated tone telegraphy; A3 indicates amplitude modulated telephony; FM indicates frequency modulated telephony and tone telegraphy.

^cFigure numbers refer to sketches of representative antennas shown in paragraph 1429.

^dThe stock number is given for identification of the instruction book.

Table continued on next page

RECEIVING EQUIPMENT COMMONLY USED BY AIRWAYS SECTION -- ARMY COMMUNICATIONS SERVICE -- DESCRIPTION. (Continued)

Type No. ^a	Flg. No.	Type Emission Received ^b	Frequency Range - Mc	Freq. Control	Normal Antennae ^c	Type Output	Power Required	Weight in Use (Lbs.)	Instr. Bk. or Manual ^d	Remarks
Willcox 4 CWG-D	1528 (See Re- marks)	Special, A1	2.0-26	Crystal (Holder FT-249)	Double Doublet or Rhombic (Figures 1540 & 1539)	Into Teletype Terminal AM/FGC-1	115V, 50/60 cycle AC			Four preset channels. Radioteletype. Used with Radioteletype Terminal Unit AM/FGC-1. The 4 CWG-D is an assembly of four CWG-B units in a single cabinet. Figure 1528 depicts one CWG-B unit.
Willcox FS	1529	A2, A3	1.9-16.5	Crystal (Holder FT-249)	Single wire, Double Doublet or Rhombic (Figures 1540 & 1539)	Speaker or Headset	115V, 50/60 cycle AC		6012011-653	Point-to-point and ground-to-air. Airport control. Rack mounting.

^aThe type numbers are those assigned by the manufacturer.

^bA1 indicates continuous wave telegraphy; A2 indicates amplitude modulated tone telegraphy; A3 indicates amplitude modulated telephony.

^cFigure numbers refer to sketches of representative antennas shown in paragraph 1428.

^dThe stock number is given for identification of the instruction book.



FIGURE 1519. Radio Receiver (Federal 128AY)



FIGURE 1521. Radio Receiver (Hallcrafters S-27)

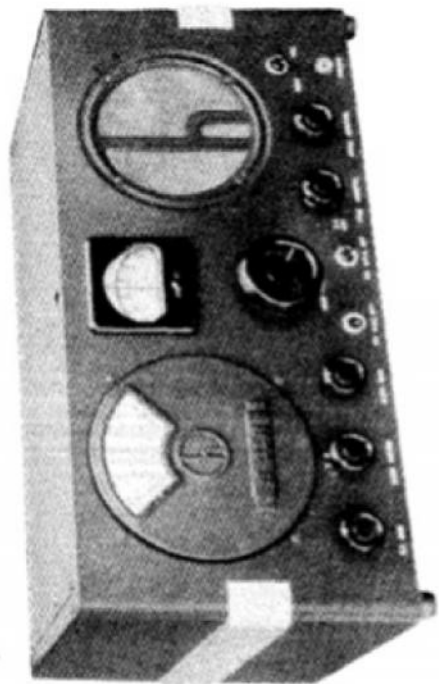

FIGURE 1520. Radio Receiver (Hallcrafters S-22-R)

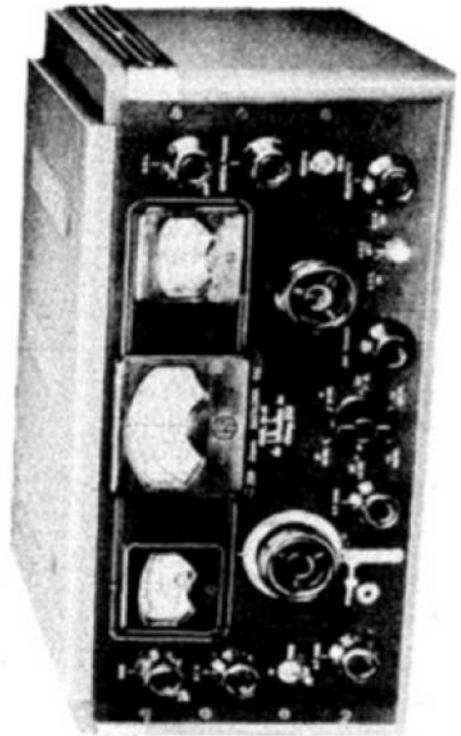

FIGURE 1522. Radio Receiver AN/CRR-3 (Hallcrafters SX-28)

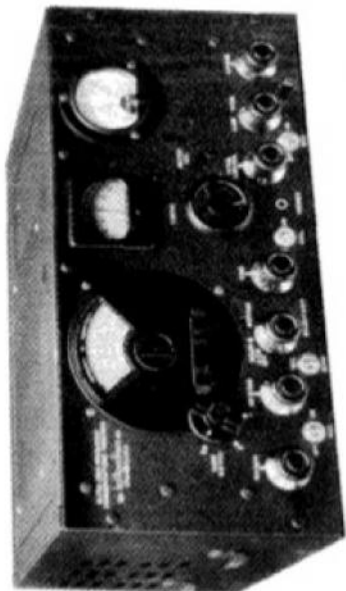

FIGURE 1524. Radio Receiver (Hallcrafters S-36)

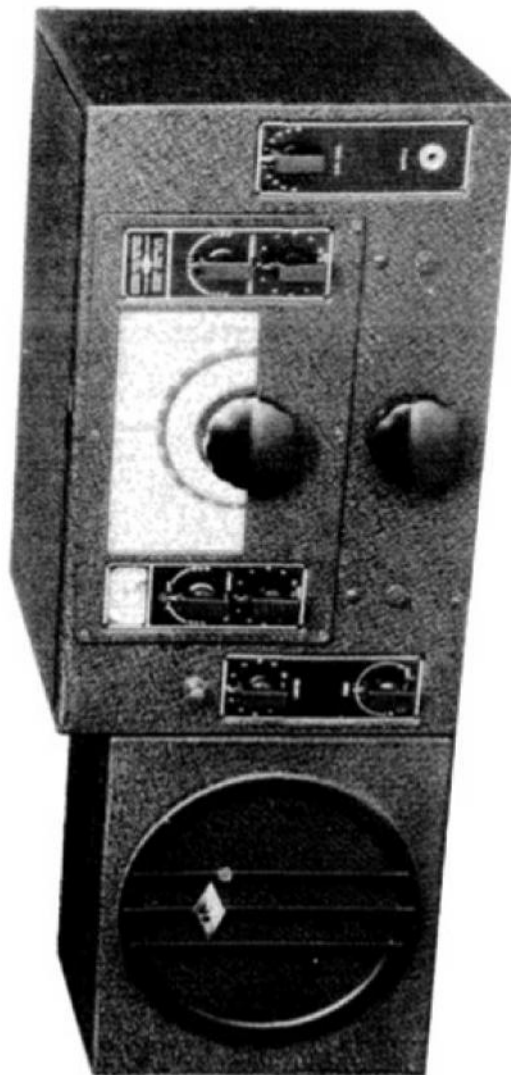

FIGURE 1525. Radio Receiver AN/GRR-2 (National NC-100-ASC)

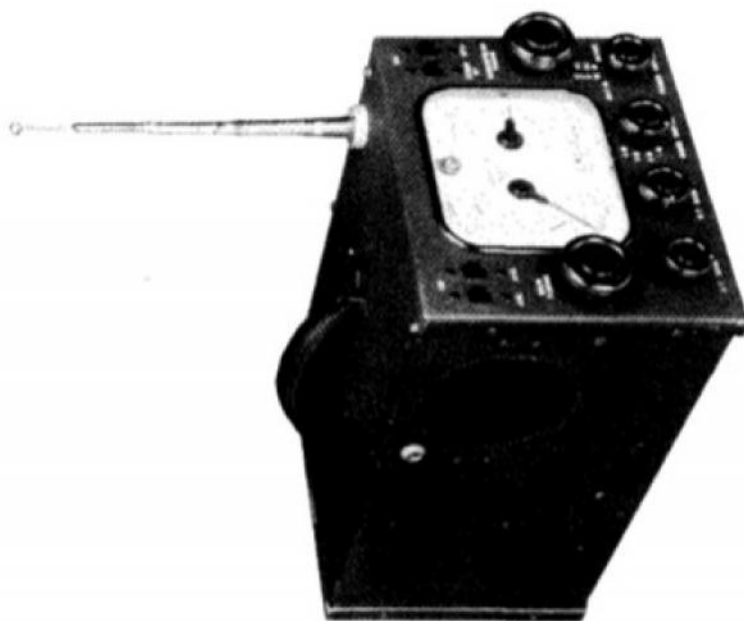

FIGURE 1523. Radio Receiver (Hallcrafters S-29)

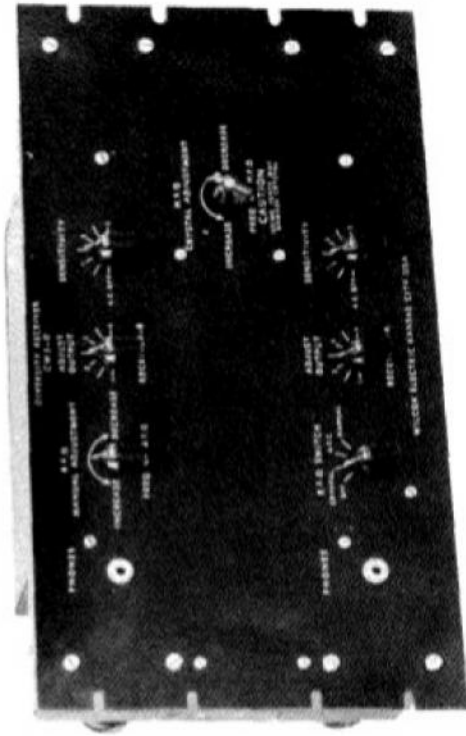

FIGURE 1528. Radio Receiver (Wilcox CW3-D)

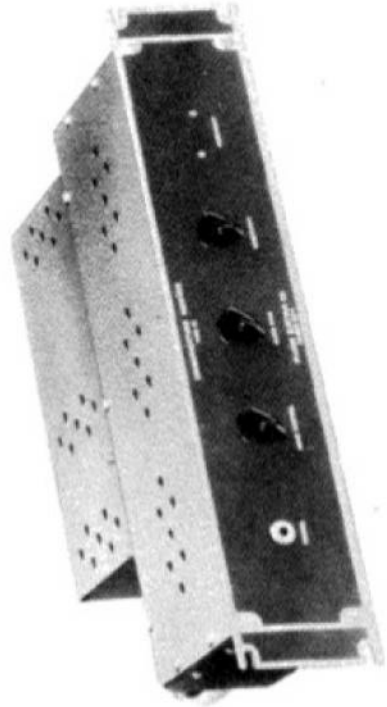

FIGURE 1529. Radio Receiver (Wilcox F3)

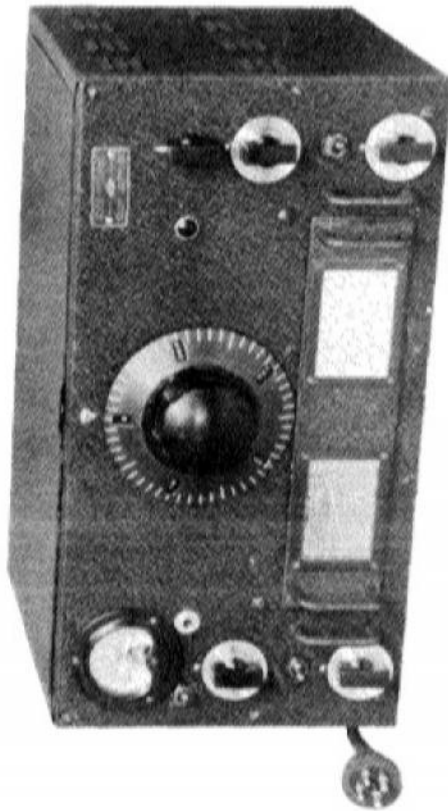

FIGURE 1526. Radio Receiver (National HR0)

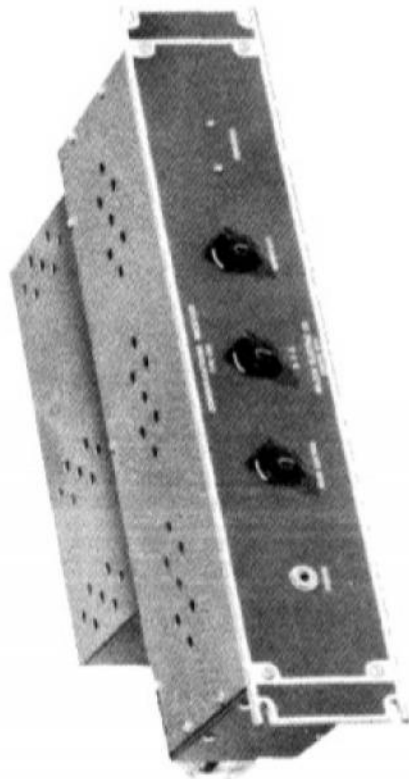

FIGURE 1527. Radio Receiver (Wilcox CW3)

1428. COMBINED TRANSMITTING AND RECEIVING EQUIPMENT COMMONLY USED BY AIRWAYS SECTION -- ARMY COMMUNICATIONS SERVICE -- DESCRIPTION.

Type No. ^a	Fig. No.	Power Output	Type of Emission ^b	Frequency Range - Mc	Freq. Control	Preset Channels	Normal Antenna ^c	Power Required	Dimensions in Feet ^e	Weight in Use (lbs.)	Instr. Book or Manual	Remarks
AM/CRC-3	See paragraph 1408											
Collins 1B-Q (Navy TCs)	1530	25 W 10 W	A1 A3	1.5-12.0	M.O. or Xtal (Holder FT-849 or Collins U3)	None (See Remarks)	25-ft. Whip (Figure 1460)	115V, 60 cycle AC or 12V DC	2 x 1 x 1			Transmitter and receiver. Point-to-point and ground-to-air. Switch selection of five crystal frequencies.
Jefferson Travis 350A	1531	50 W 40 W	A1 A3	1.5-12.0	M.O. or Xtal	None (See Remarks)	25-ft. Whip or 1/4-wave inverted L (Figures 1460 & 1458)	12V DC, 24V DC, 32V DC, 115V DC or 115V, 60 cycle AC	3 x 2 x 2	232 (Without Power Supply Equipment)		Transmitter-receiver equipment for fixed mobile communication. Switch selection of four crystal frequencies.
Link 25-FMTR	1420 par. 1408	25 W	FM	30-40	Xtal (Holder FT-171)	1	6-ft. Whip (Figure 1461b)	6V DC	3 x 1 x 1	65	608288	Commercial police car equipment for providing two-way mobile communication. Similar to SCR-298. Includes Transmitter 25-0FM, Receiver 11-0F, Vibrotor Power Supply VPA-3A and dash control unit.
Link 35-FMTR	1420 par. 1408	35 W	FM	30-40	Xtal (Holder FT-171)	1	6-ft. Whip (Figure 1461b)	6V DC	3 x 1 x 1	65	608288A	Commercial police car equipment for providing two-way mobile communication. Similar to SCR-298-C. Includes Transmitter 35-0FM, Receiver 11-0F, Vibrotor Power Supply VPA-3A and dash control unit.
Link 50UPS	1532	50 W	FM	50-60	Xtal (Holder FT-171)	1	(Non-Adjustable Coaxial Dipole (Figure 1468))	115V, 60 cycle AC	2 x 1 x 3	175		Self contained transmitter, receiver and power supply. For fixed control station in mobile net.
Link 1498	1533	50 W	FM	70-100	Xtal (Holders FT-171 & FT-243)	1	Adjustable Coaxial Half-Wave Dipole (Figure 1468)	115V, 50/60 cycle AC Xstr-210W. Rec.-75M.	2 x 1 x 3	151		Self contained transmitter, receiver and power supply. For providing radio telephone communication when essentially line-of-sight operation is possible. May be remotely controlled at distances up to 5 miles of Wire W-110-B by the addition of Remote Control Unit Type 1504.

^aExcept for AM/CRC-3 the type numbers are those assigned by the manufacturer.

^bA1 indicates continuous wave telegraphy; A3 indicates amplitude modulated telephony; FM indicates frequency modulated telephony.

^cM.O. is used to indicate Master Oscillator control and Xtal to indicate crystal control.

^dFigure numbers refer to sketches of representative antennas shown in paragraph 1408. Antennas are not normally included with the set unless so indicated.

^eThe dimensions are width, depth and height, respectively. The width and depth do not include space for opening of apparatus doors.

^fWhen other identification is not available for instruction books, the stock number is shown.

Type No. ^a	File No.	Power Output	Type of Excitation ^b	Frequency Range - Mc	Freq. Control ^c	Fuses Channels	Normal Antenna ^d	Power Requirements	Dimensions in Operation - ft. ^e	Weight in Use (lbs.) ^f	Instr. Book or Manual	Remarks
Link 1505	1554	250 W	FM	70-100	Xtal (Holder FT-171 & FT-283)	1	Adjustable Coaxial Half-Wave Dipole (Figure 1468)	115V, 50/60 cycle AC Inst-1300W. Rec - 70W.	2 x 1 x 6	558	TM 11-485	Self contained transmitter, receiver and power supply, similar to Link 1490 except provides approximately 7 db greater power output.
Motorola FM71-65VM	1555	85 W	FM	50-40	Xtal (Holder Billey 568)	1	Krip (Furnished) (Figure 1461b)	6V DC	2 x 1 x 1	203101/81		Commercial police car equipment for providing two-way mobile communication. Separate transmitter and receiver; each with built-in power supply.
Motorola FM71-62VM	1555	50 W	FM	50-40	Xtal (Holder Billey 568)	1	Non-Adjustable Coaxial Half-Wave Dipole (Furnished) (Figure 1461b)	115V, 60 cycle AC	2 x 1 x 1	203102/81		Transmitter-Receiver for fixed control station in mobile net. Transmitter and receiver each have built-in power supply.

^aThe type numbers are those assigned by the manufacturer.

^bFM indicates frequency modulated telephony.

^cXtal is used to indicate crystal control.

^dFigure numbers refer to sketches of representative antennas shown in paragraph 1458. Antennas are not normally included with the set unless so indicated.

^eThe dimensions are width, depth and height, respectively. The width and depth do not include space for opening of apparatus doors.

^fWhen other identification is not available for instruction books, the stock number is shown.

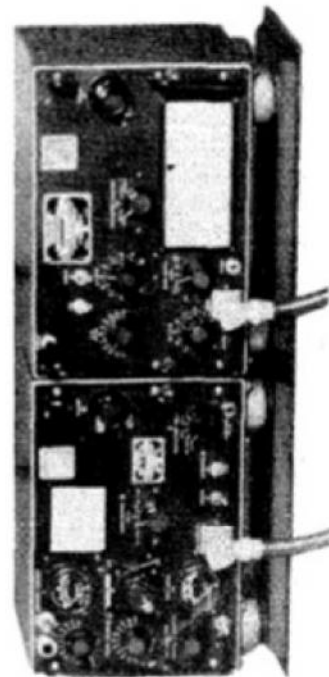

FIGURE 1530. Radio Receiver and Transmitter (Collins 1B-Q) (Navy TCS)

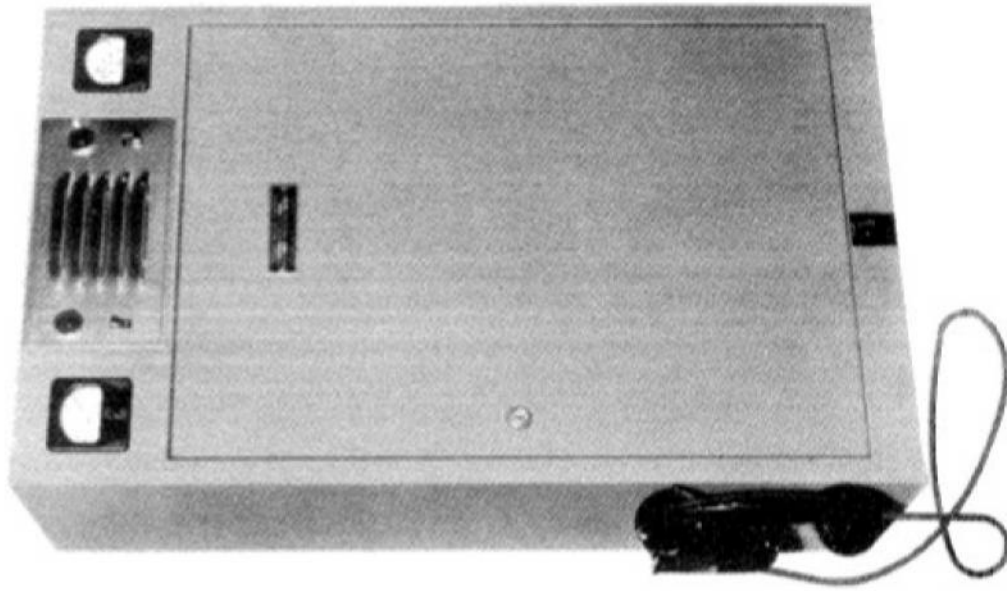

FIGURE 1532. Radio Receiver and Transmitter (LINK 50UFS)

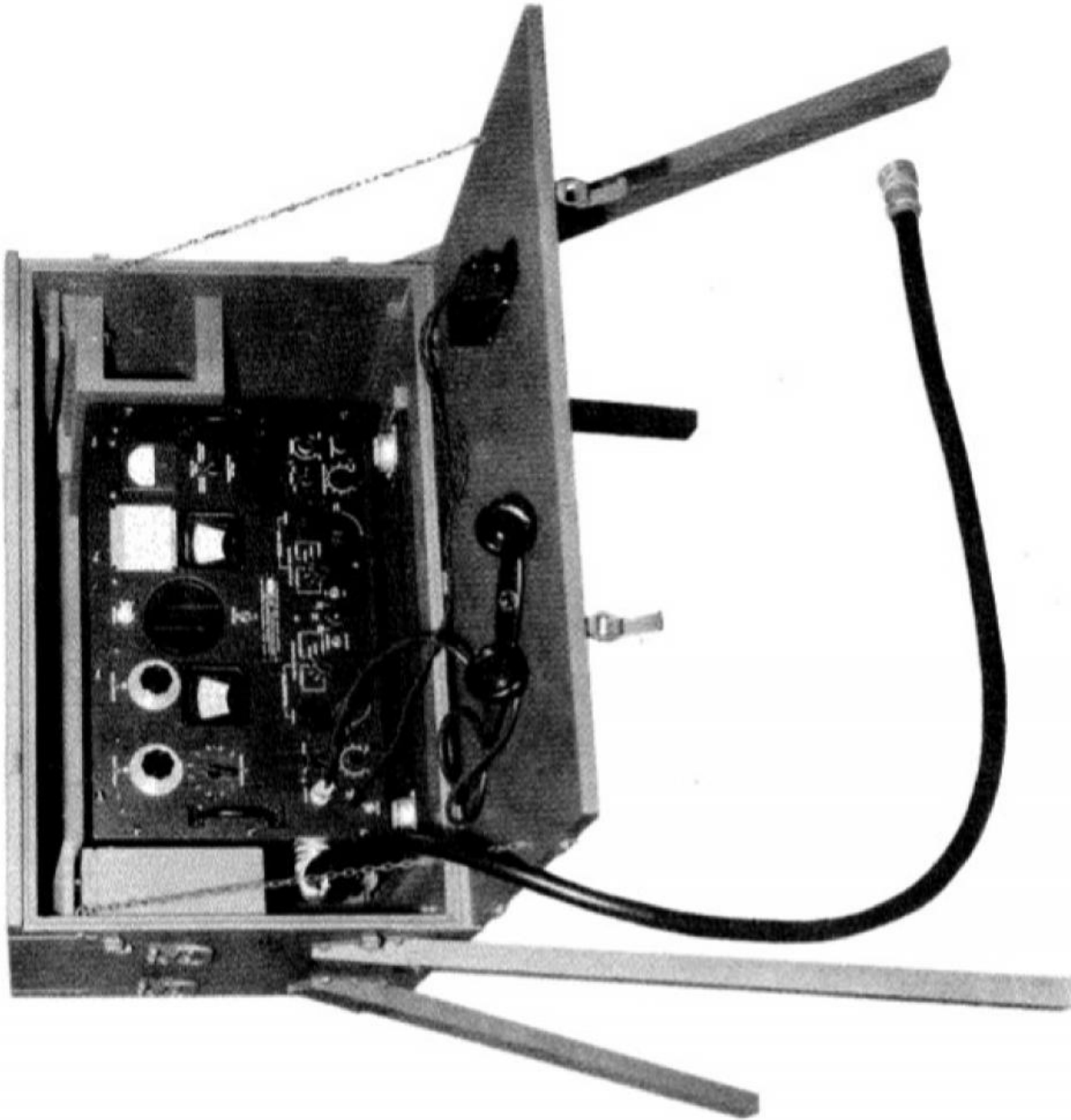

FIGURE 1531. Radio Receiver and Transmitter (Jefferson 350A)

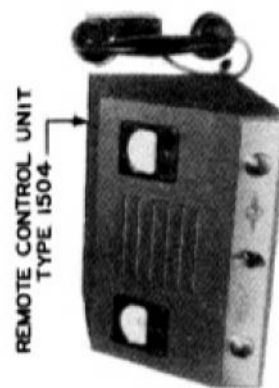
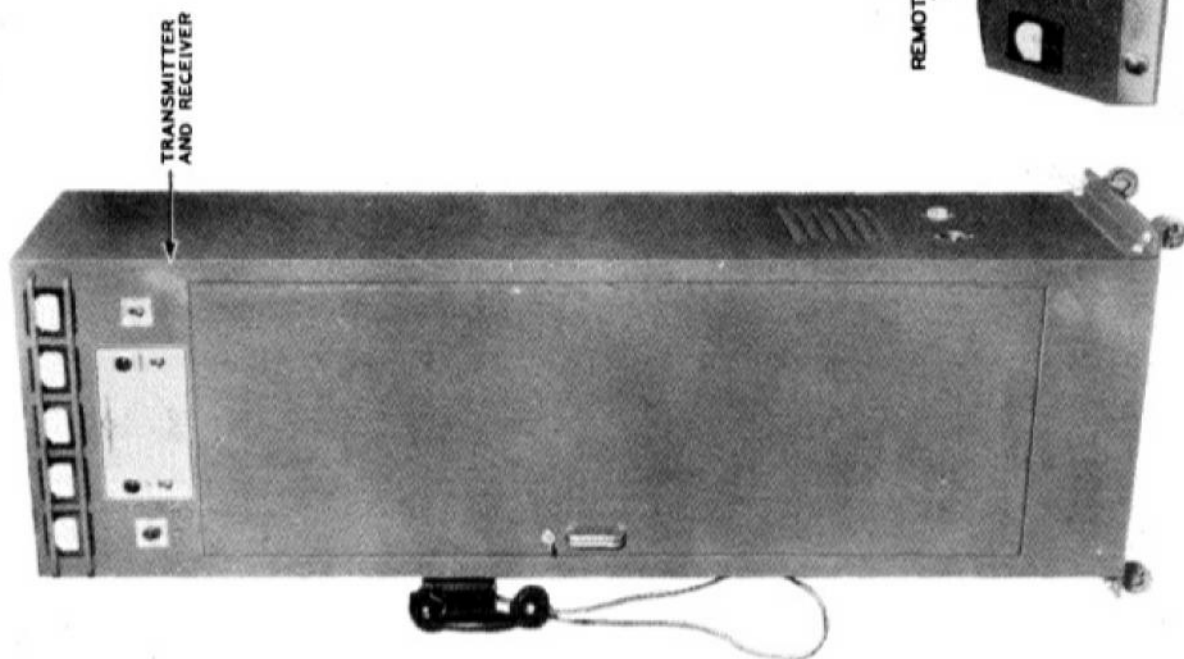

FIGURE 1534. Radio Set Type 1505 (LINK)

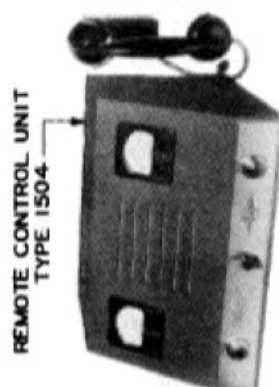
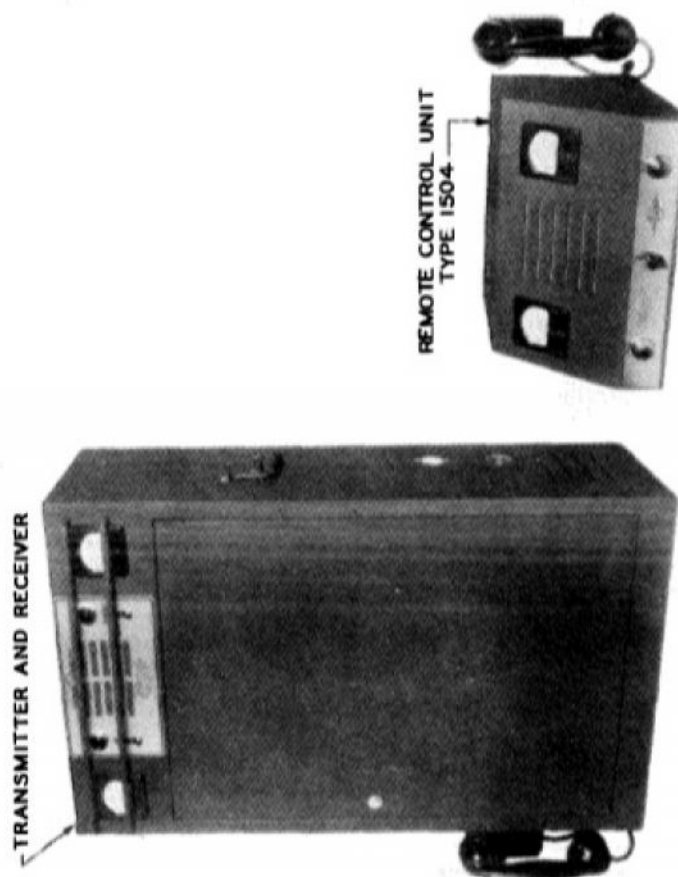

FIGURE 1533. Radio Set Type 1498 (LINK)

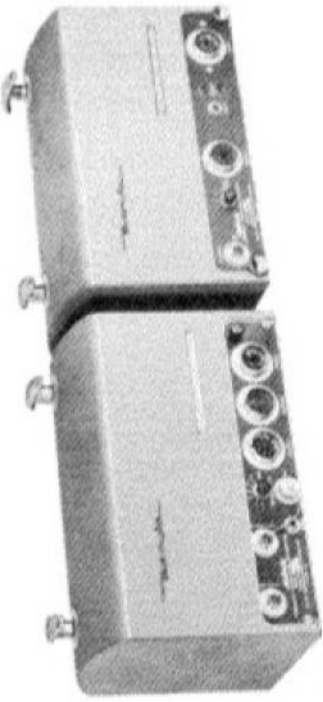

FIGURE 1535. Radio Receiver and Transmitter (Motorola FMTR 25VM and FMTR 50BW)

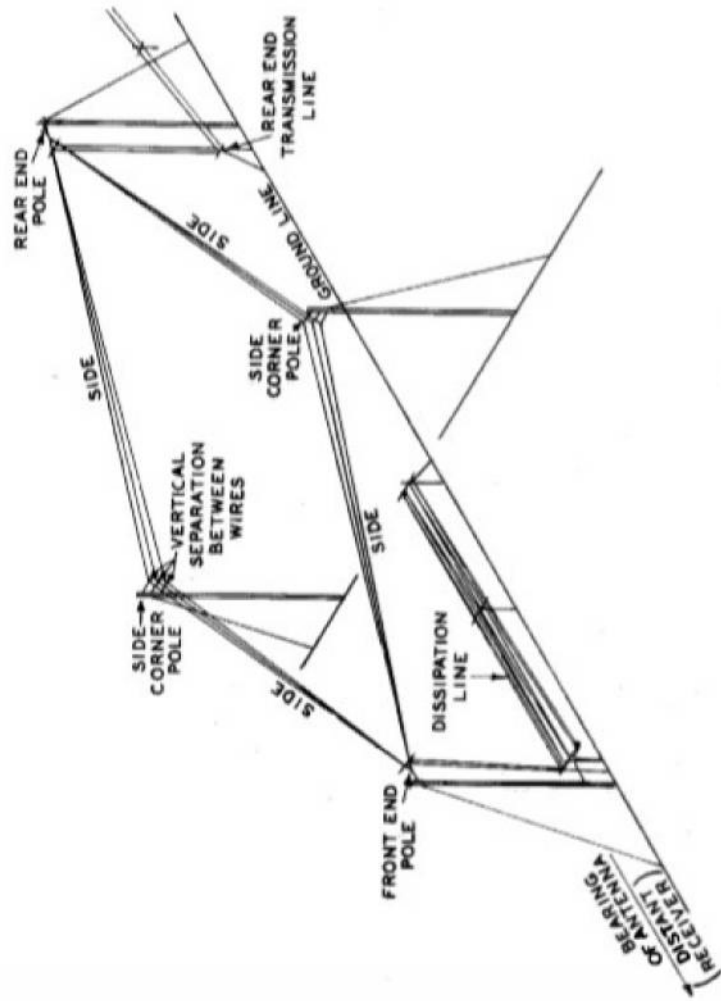

FIGURE 1536. Transmitting Horizontal Rhombic Antenna

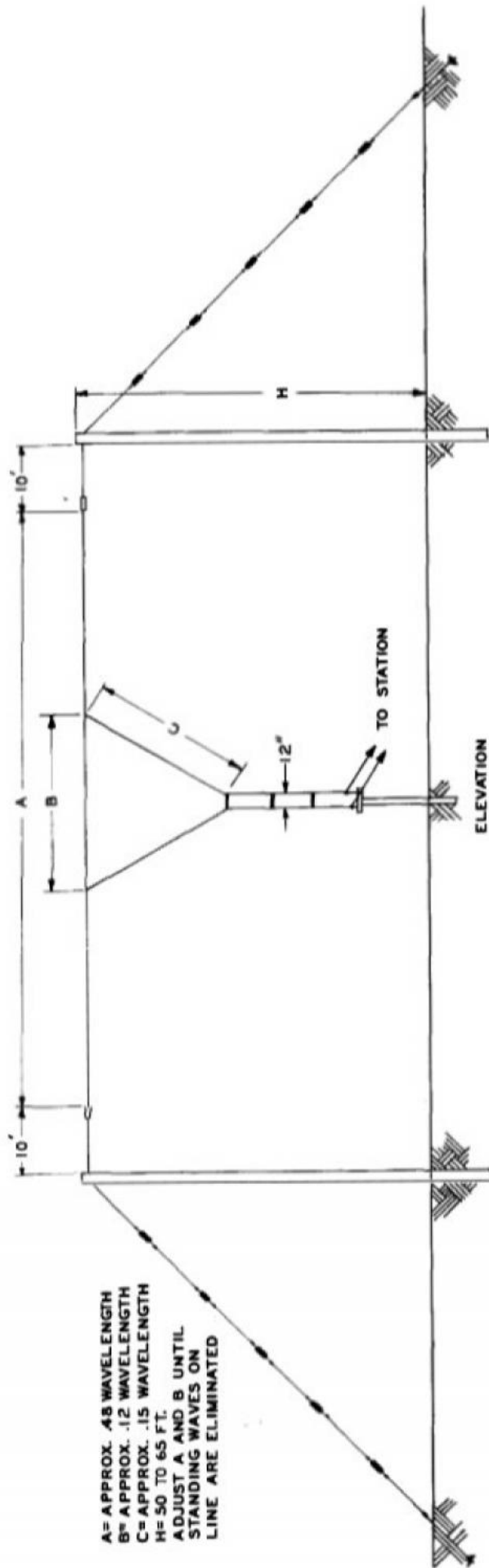
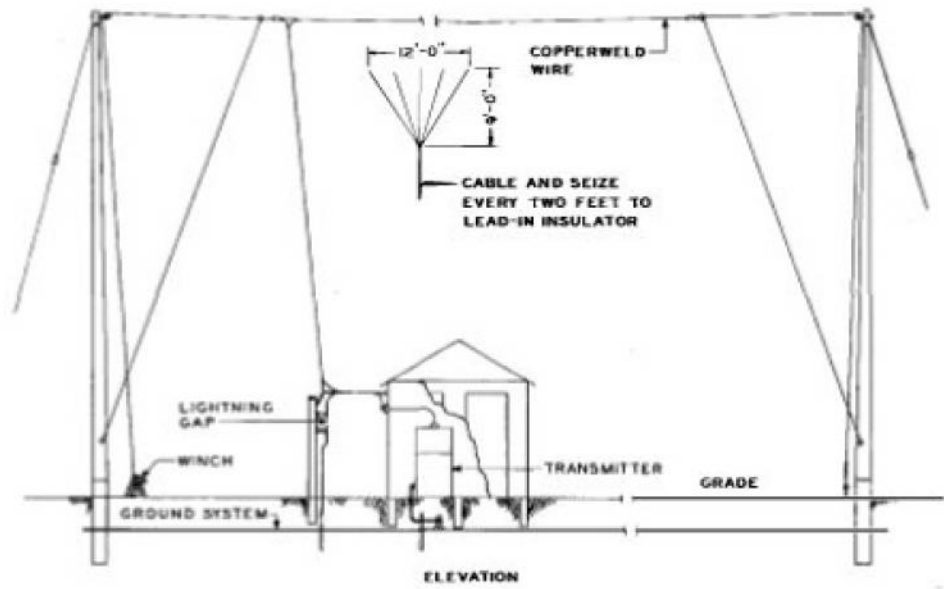
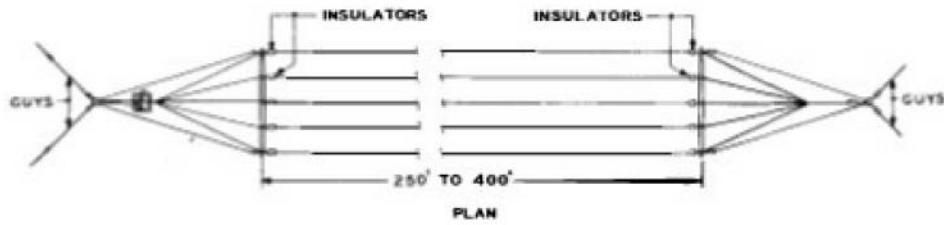

FIGURE 1537. Transmitting Doublet Antenna



INTERMEDIATE FREQUENCY FLAT TOP ANTENNA

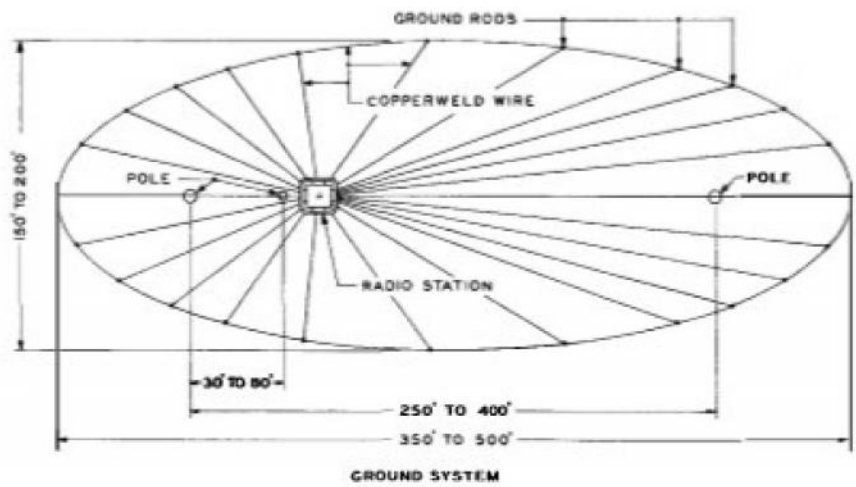

FIGURE 1538. Intermediate Frequency Flat Top Antenna

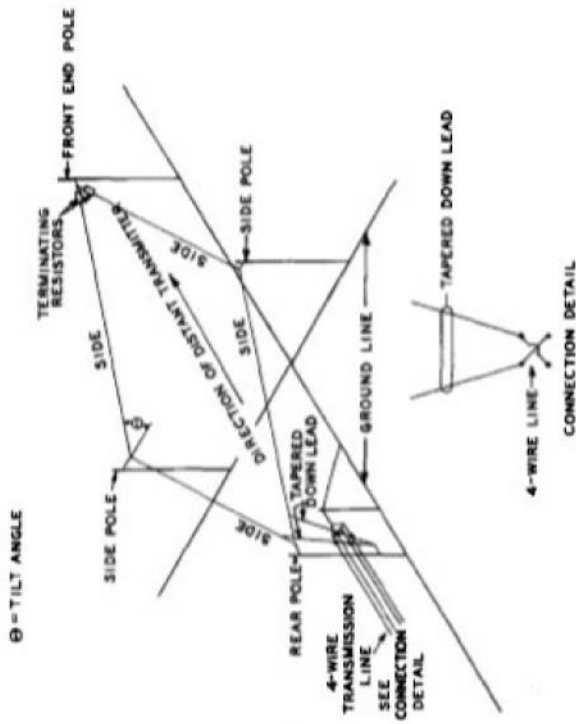

FIGURE 1539. Receiving Horizontal Rhombic Antenna

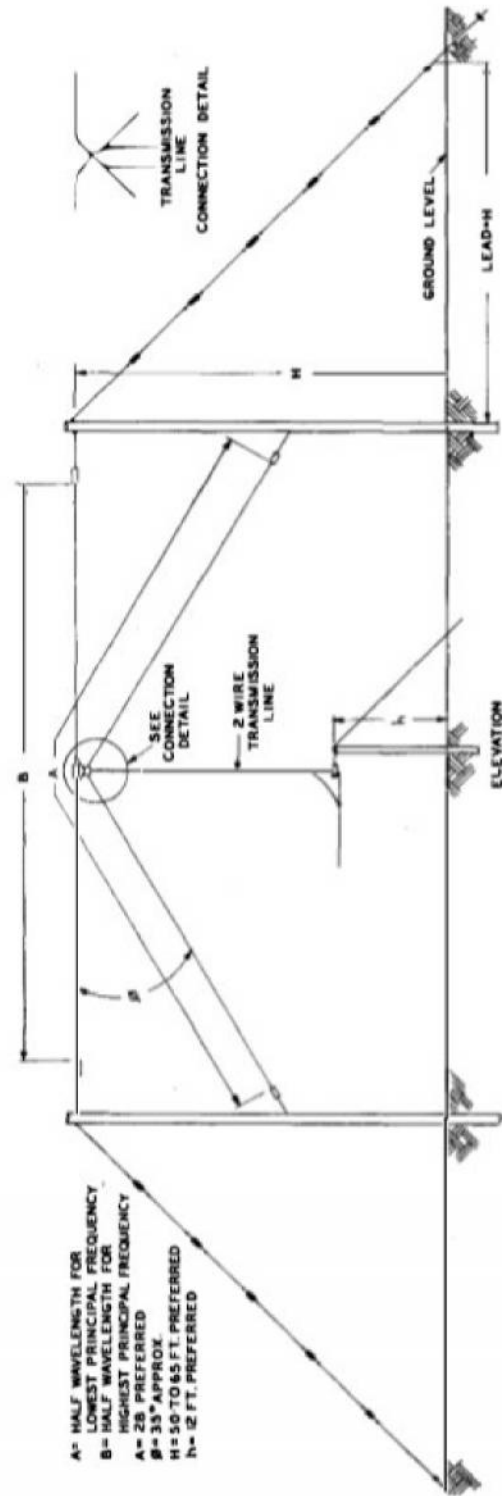
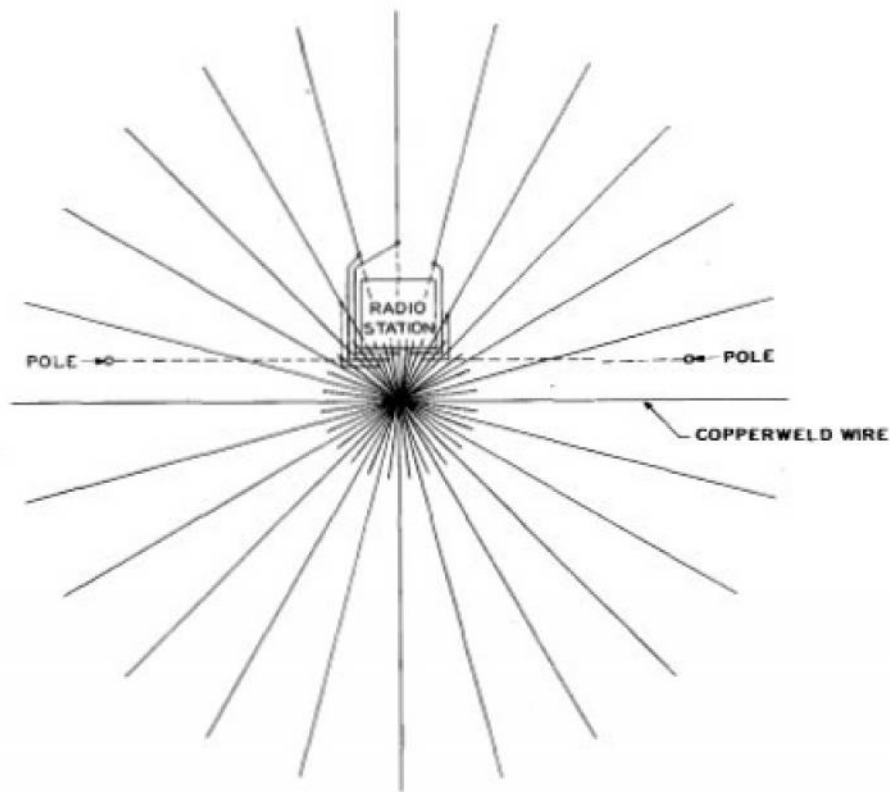
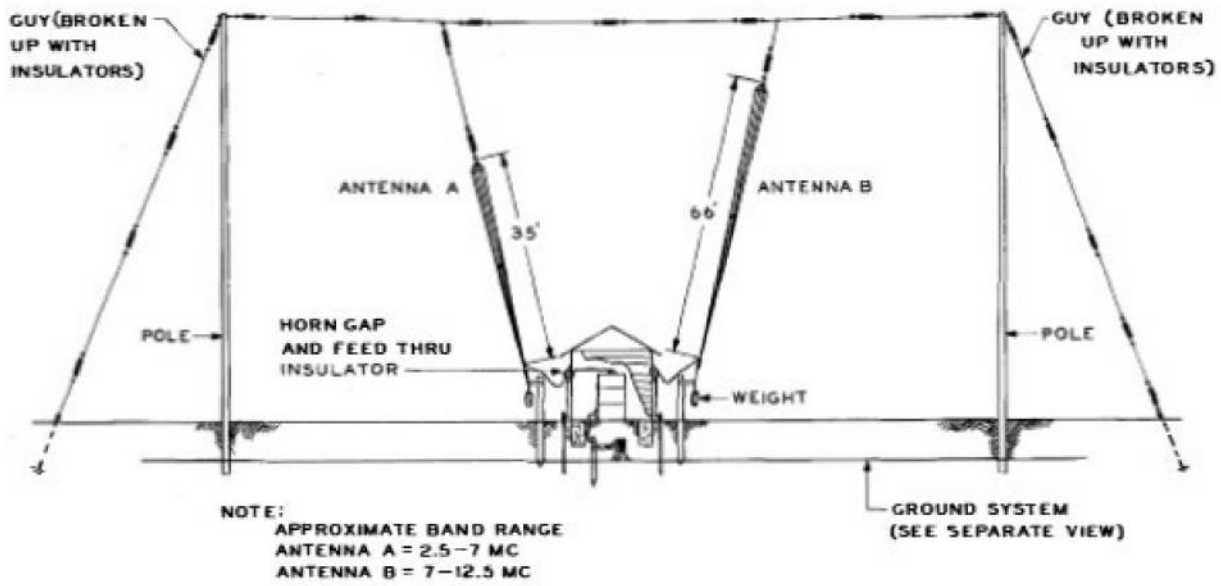

FIGURE 1540. Double Doublet Receiving Antenna



GROUND SYSTEM FOR
DOUBLE CAGE ANTENNA INSTALLATION

FIGURE 1541. Double Cage Antenna

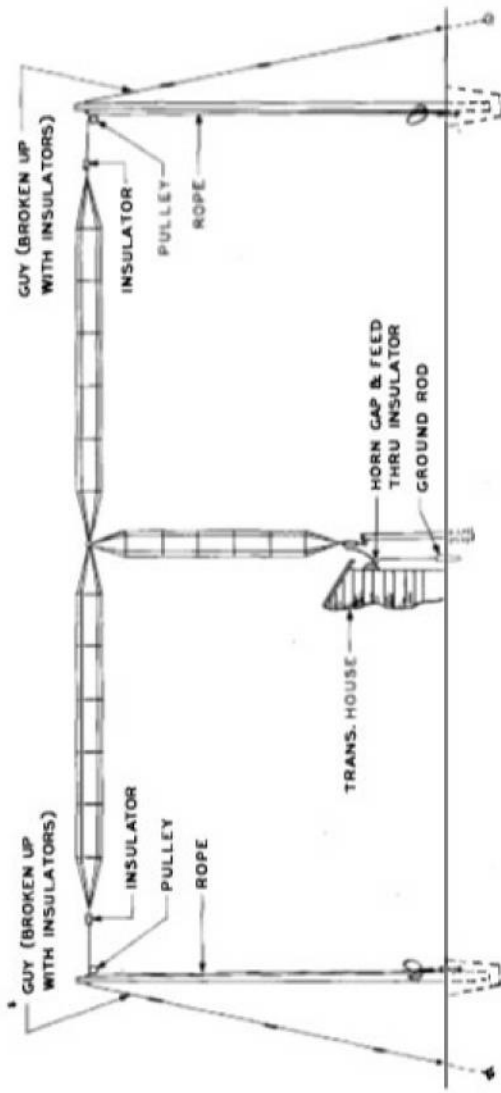
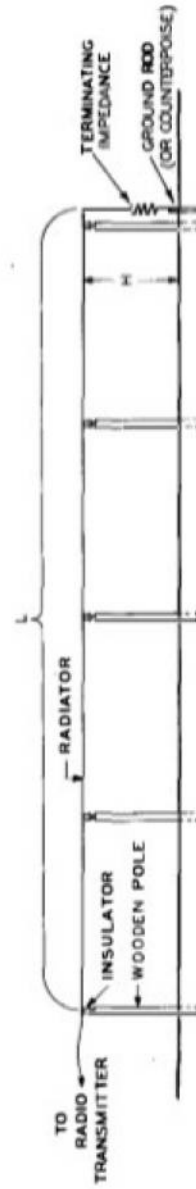

FIGURE 1543. T Cage Antenna



NOTE:
 L = FROM $\frac{1}{2}$ TO SEVERAL WAVE LENGTHS
 H = ANY CONVENIENT HEIGHT (10 TO 20 FT)

FIGURE 1544. Wave Antenna

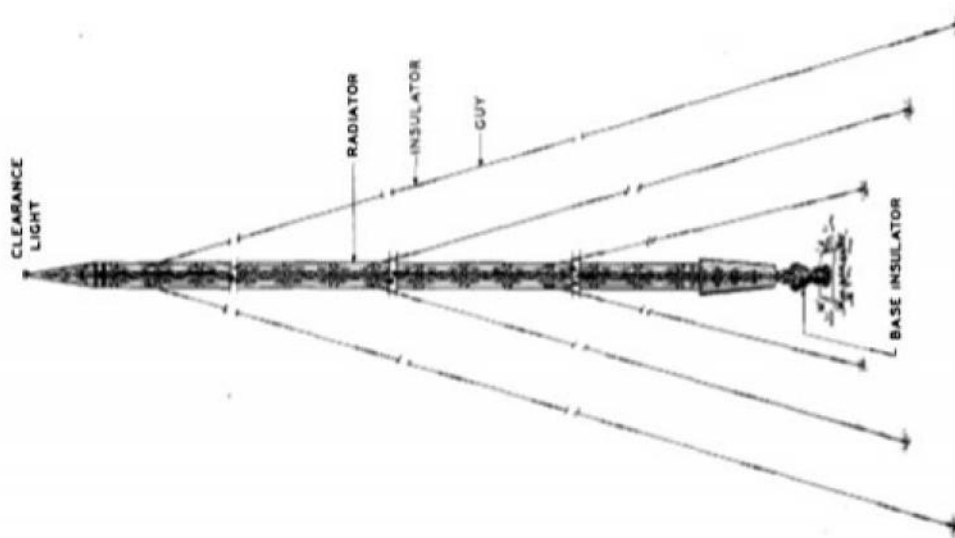

FIGURE 1542. Insulated Tower Antenna

1429. TRANSMITTING EQUIPMENT COMMONLY USED BY AIRWAYS SECTION - ARMY COMMUNICATIONS SERVICE - STOCK NUMBERS AND LOGISTICAL DATA

Type No.	Stock No.	Additional Equipment Required		Export Weight Lbs.	Export Volume Cu. Ft.	Ship Tons ^b
		Type No.	Stock No.			
BC-315	2C6315	Rect. & Modulator RA-18	227510			
		Ant. Tuning Unit BC-316	2C526			
		Rem. Control Unit RM-5	2C7605			
BC-325-()	2C6325()	Rem. Control Unit RM-7-()	2C677()			
BC-339-()	2C6339()			2173	153	3.8
BC-340-() (Amplifier)	2C2940()	Transmitter BC-339-()	2C6339()	3080	143	3.6
		Rect. RA-22-()	3H4662			
		Water Cooling Unit RU-2-()	27A1002			
BC-365-()	2C6355()	Remote Control Unit RM-10-()	2C7610()	965	84	2.1
BC-401-()	2C6381()	Rect. & Modulator RA-30-()	2C7030()			
		Rem. Control Unit RM-11-()	2C7611			
BC-460-()	2C6400()	Rem. Control Unit RM-20-()	2C7620()			
BC-610	2C6910			868	43.4	1.1
BC-642	2C242	Modulator BC-643	2C2500-643			
		Rectifier RA-44	3H4683-44			
		Transformer and Contactor BC-644	3H6500-644			
		Rem. Control Unit RM-15	2C7615			
BC-1100-()	2C6596-1100()			700	40	1.0
RC-52-()	2C6903-52()			1750	50	1.3
T-4/FRC	2C6900-4	Rect. PP-1/FRC	3H4698-1			
		Mod. MD-1/FRC	2C2537-1			
		Opr's. Control Console CY-161/FRC				
		(Formerly CS-212	2C7604-212)			
T-5/FRC	2C6900-5	Rect. PP-1/FRC	3H4698-1			
		Mod. MD-1/FRC	2C2537-1			
		Opr's. Control Console CY-161/FRC				
		(Formerly CS-212	2C7604-212)			
Aircraft Accessories Corp. ^a 500B	2C6609					

^aType numbers assigned by the manufacturer.

^b40 cu. ft. assumed equivalent to 1 ship ton.

Type No. ^a	Stock No.	Additional Equipment Required		Export Weight Lbs.	Export Volume Cu.Ft.	Ship Tons ^b
		Type No.	Stock No.			
Collins 32-RA	2C6632RA-()			237	18	0.5
Federal FT-300	2C6700			4333	305	7.6
Pan American Airways 12-ACX-2	2C6885			987	80	2.0
Pan American Airways 12-GLX-2	2C6908-1			2217	221	5.5
Pan American Airways RFA-50 (Amplifier)		Transmitter Pan American Airways 12-ACX-2	2C6885			
Press Wireless PW-1OLF	2C6888					
Temco 250-GSC	2C6825			773	35	0.9
Temco 1000-AG-CN	2C6800AG.1			3780	152	3.8
Western Electric Co. D-151249 (Pan American Airways 4WTFA)	2C6872			800 (Approx.)	33	0.8
Wilcox 96A	2C6840.1	Rect. & Modu- lator 26A or 26B Dialing Unit 168AB	2C7126() 2C7126B/P1			
Wilcox 96C and 96C-3	2C6840C	Rectifier 36A Modulator 50A Opr's. Control Console CY-161/FRC (Formerly CS-212)	3H4841 2C2510-50A 2C7604-212)			
Wilcox 96-200A	2C6845A	Rect. & Modula- tor 26A or 26B Opr's. Control Console CS-380	2C7126() 2C7604-380			
Wilcox 96-200B	2C6845B	Rect. & Modula- tor 26A or 26B Opr's. Control Console CS-380	2C7126() 2C7604-380			

^aType numbers assigned by the manufacturer.

^b40 cu. ft. assumed equivalent to 1 ship ton.

1430. RECEIVING EQUIPMENT COMMONLY USED BY AIRWAYS SECTION - ARMY COMMUNICATIONS SERVICE - STOCK NUMBERS AND LOGISTICAL DATA.

<u>TYPE No.^a</u>	<u>Stock No.</u>	<u>Export Weight Lbs.</u>	<u>Export Volume Cu. Ft.</u>	<u>Ship Tons^b</u>
AN/FRR-3 Press Wireless Diversity	2S2001-3	1200	57	1.4
Federal 128-AY	2C4498	74	6	0.2
Hallierafter S-22-R	2C4534.1	55	2	0.1
Hallierafter S-27	2C4537-27	110	4	0.1
Hallierafter SX-28 AN/GRR-3	2C4534-1	150	7	0.2
Hallierafter S-29	2C4537-29	48	2	0.1
Hallierafter S-36	2C4537-36	110	3.5	0.1
Hammarlund SP-110-LX	2C4528.4-1	130	6	0.2
Hammarlund SP-210-LX	2C4528.6	130	6	0.2
National NC-100-ASC AN/GRR-2	2C4529	125	6	0.2
National HRO	2C4529-21	100	4	0.1
Wilcox CW3	2C4547-2 2C5403 ^c	40 350	2.5 17	0.1 0.4
Wilcox 4 CW3-D	P4-31116	528	37	0.9
Wilcox F3	2C4547-1	40	2.5	0.1

^aExcept for AN/FRR-3, AN/GRR-2, and AN/GRR-3 the type numbers are those assigned by the manufacturer.

^b40 cu. ft. assumed equivalent to 1 ship ton.

^cWilcox 113A Receiver Bay consisting of eight CW3 Receivers.

**1431. COMBINED TRANSMITTING AND RECEIVING EQUIPMENT COMMONLY USED BY AIRWAYS
SECTION - ARMY COMMUNICATIONS SERVICE - STOCK NUMBERS AND LOGISTICAL DATA**

<u>Type No.^a</u>	<u>Stock No.</u>	<u>Export Weight Lbs.</u>	<u>Export Volume Cu. Ft.</u>	<u>Ship Tons^b</u>
AN/CRC-3	See paragraph 1413			
Collins 1B-Q (Navy TCS)		435	24	0.6
Jefferson Travis 350A	2C5516	425	13	0.3
Link 25-FMTR		165	14	0.4
Link 35-FMTR	2C5535	170	14	0.4
Link 50 UFS	2C5529	250	15	0.4
Link 1498	2C5520	250	15	0.4
Link 1505	2C5528	605	25	0.6
Motorola FMTR-25VM	2C5101	167	14	0.4
Motorola FMTR-50EW	2C5104()	167	14	0.4

^aExcept for AN/CRC-3 the type numbers are those assigned by the manufacturer.

^b40 cu. ft. assumed equivalent to 1 ship ton.

Section IV
Antennas and Associated Equipment

1432. GENERAL.

a. This section supplies descriptive information and stock numbers for antennas, masts, towers and miscellaneous materials which may be required to construct radio antenna systems. As presented, the data are divided into tactical and fixed plant categories. This has been done for convenience and not with any idea of limiting the field of use of these antenna equipments, as some may be suitable for either tactical or fixed plant installations. Reference should be made to sketches of typical antennas in paragraphs 1408 and 1428.

b. Complete tactical antenna systems which are available in kit form are

listed and described in paragraph 1433. Materials such as wire, coaxial cable and supporting masts, which are used in the construction of antenna systems primarily for tactical use, are listed in paragraphs 1434 to 1437, inclusive. Some of the coaxial cables listed in paragraph 1435 are also used for purposes other than radio communication, but are included for completeness.

c. Metallic mast sections which are available for assembling vertical radiators (whips) for tactical ground use and for vehicular mounting are covered in paragraphs 1438 and 1439, respectively.

d. Paragraph 1440 gives information on accessories which are required in the construction of tactical antenna systems. Items such as counterpoises, ground rods, insulators, etc. are covered.

e. Fixed plant antenna systems which are available in kit form are listed in paragraph 1441. Paragraph 1442 describes two antenna coupling units, one being for use primarily with rhombic antennas and the other being a multicoupler for feeding up to ten receivers from a single antenna.

f. Base insulated radio towers which are employed in the fixed plant as vertical radiators are covered in paragraph 1443, and towers which are employed as antenna supports are covered in paragraph 1444.

g. Materials employed in the construction of ground systems for fixed plant vertical antennas are listed in paragraph 1445.

h. Equipment required for lighting fixed plant radio towers and antenna supports is listed in paragraph 1446.

1433. ANTENNA KITS - TACTICAL.

a. Antenna Assembly AS-110()/TRC-7; Stock No. 2A289-293. This antenna assembly consists of a broad band, lightweight, vertical conical dipole Antenna AS-112/TRC-7 (figure 1471) for use in the frequency range of 100 to 156 Mc and includes two 37-1/2-foot lengths of standard 52-ohm solid dielectric radio frequency coaxial transmission cable equipped with standard coaxial fittings, and includes components for constructing and installing a 30-foot aluminum supporting mast consisting of ten 3-foot sections. The complete assembly weighs 26-1/2 pounds net and is normally furnished as a part of Radio Set AN/TRC-7.

b. Antenna Equipment RC-63; Stock No. 2A278-63. The antenna is a vertical half rhombic unidirectional antenna similar to that shown in figure 1469. The assembly is used with, but not part of, Radio Set SCR-194, covering a frequency range of 27.7 to 52.2 Mc, Radio Set SCR-195, covering a frequency range of 52.8 to 65.8 Mc and Radio Sets SCR-609 and SCR-610, covering a frequency range of 27.0 to 38.9 Mc. The over-all antenna wire length is 100 feet, and is equipped with a counterpoise 85 feet long and a 500-ohm, 1-watt resistance termination. The assembly weighs 57 pounds net, including materials for constructing and installing a 32-foot supporting mast, consisting of four 8-foot sections. The equipment may be carried and erected by one man.

c. Antenna Equipment RC-291; Stock No. 2A289-291. The antenna is a ground plane antenna (figure 1472) for use in the frequency range of 40 to 48 Mc. The assembly includes a 60-foot length of standard 52-ohm solid dielectric radio frequency coaxial cable terminated in standard coaxial cable fittings, a coupling network for matching the coaxial cable to the output of Radio Set SCR-300, and a universal mounting base for fastening the antenna to a tree or pole. No antenna supporting mast is provided in the kit at present. The equipment is

used with, but is not part of Radio Set SCR-300 and weighs 28 pounds net.

d. Antenna Equipment RC-293; Stock No. 2A289-293. This equipment contains material for constructing an end-fed three-quarter wave antenna and includes two telescoping aluminum masts (extended length 25 feet), two guy assemblies, each with its stakes and polystyrene insulator attached, 300 feet of Wire W-148 on spool, one 100-foot steel measuring tape and one Bag BG-193.

It is supplied as a part of Installation Kit MC-549 for mounting Radio Set SCR-499 in a 1/4-ton, 4 x 4 truck and is for use when at fixed locations. In this application, use is made of radial Counterpoise CP-15 which is normally furnished with the radio set.

e. Antenna System AS-19()/TRC-1; Stock No. 2A264-19. This antenna system contains all the equipment necessary to erect a three-element, horizontally polarized, directional array (figure 1470) for use in the 70-100 Mc range. It includes adjustable Antenna Array AS-20/TRC-1, eleven 5-foot steel sections and nylon guys for constructing, supporting and erecting a 40-foot 2-1/2 inch diameter, rotatable mast, four 50-foot lengths of 52-ohm solid dielectric coaxial cable RG-8/U terminated in standard coaxial cable fittings, and required installation equipment. The antenna array provides a forward gain of about 6 db and a front-to-back ratio of approximately 8 db. Two assemblies are normally furnished with Radio Set AN/TRC-1 and Radio Terminal Set AN/TRC-3, and four with Radio Relay Set AN/TRC-4. An Extension Kit MX-141/TRC-1 (Stock No. 2A1591-141) (consisting of five 60-foot guys and one guy plate) is available for raising the antenna from 40 to 50 feet when only one antenna of the two supplied with the AN/TRC-1 set is required. By lowering the antenna to the ground it may be readily readjusted to operate on any frequency between 70 and 100 Mc. The assembly is normally packed in two carrying chests, one of which weighs approximately 90 pounds and the other approximately 300 pounds packed.

f. Doublet Antenna Kit; Stock No. 2A1652. This is a half-wave doublet antenna kit per Specification 71-1683 for use with Radio Sets SCR-399 and SCR-499 for improving skywave transmission, thus increasing the range and reliability of operation of these radio sets.

Materials are provided for constructing a half-wave center-fed doublet antenna for use in the 2 to 18 Mc frequency range, including 50 feet of 72-ohm solid dielectric flexible coaxial transmission line, 250 feet of Wire W-28, twenty-one 5-foot steel tubing mast sections for constructing three 35-foot supports (one at each end and one in the middle to support the weight of the transmission line), necessary guys and insulators, and coils for coupling to the output tank circuit of Radio Transmitter BC-610.

(Another Doublet Antenna Kit, similar to that above except including variable

link tank coils for insertion in Radio Transmitter BC-610 instead of the old tank coils and coupling coils mentioned above, is now furnished with Radio Sets SCR-299, SCR-399, and SCR-499. When cir-

cumstances permit, Radio Sets SCR-399 and SCR-499 will be delivered equipped with these variable link tank coils and such coils will then no longer be included as a part of this Doublet Antenna Kit.)

1434. WIRE USED FOR ANTENNA EQUIPMENT - TACTICAL.

Type No.	Stock No.	Solid or Equiv. AWG (B&S) Gauge	No. of Strands and Gauge of Each Conductor	Material	Insulation	Breaking Load Lbs.	Wt. Per 1000 Ft. in Lbs.	Remarks
W-28	1A28	12	7/20	Bronze	Bare	550	23.5	Antenna
W-29	1B29	16	42/32	Bronze	Black Weather- proof Cotton Braid	200	14.4	Antenna
W-30	1B30	16	42/32	Bronze	Rubber	200	70	Counterpoise
W-120	1A120	16	42/32	Silicon Bronze	Bare		8	Conductor composed of 6 groups of 7 strands each twisted around a 5 ply cotton cord so as to make a solid cylindrical conductor. Same as Wire W-29, except without insulation.
W-128	1B128	14	41/30	Tinned Copper	Rubber			Aircraft ignition cable with ozone-resisting rubber insulation. Used for antenna and ground connections for vehicular radio sets.
W-140	1B140	18	16/30	Tinned Copper	Rubber and Black Cotton Braid			Extra flexible. Belden Mfg. Co.
W-146	1B146	12		Tinned Copper	Rubber and Black Cotton Braid			Flexible lead-in wire. Similar to Wire W-128 except improved for high frequency transmission
W-148	1A148	0.035	16/35	Phosphor Bronze	Bare	50		Antenna; 300 ft. length; used with, but not part of, Reel RL-48

1435. COAXIAL CABLES FOR RADIO FREQUENCY TRANSMISSION LINES.

Army Navy Type No.	Stock No.	Replaces Old Cable Number	Inner Conductor	Nominal Diameter of Dielectric ^a (in.)	Nominal Number of Shielding Braids	Protective Covering	Nominal Over-all Dia. (in.)	Nominal Weight Per Foot	Nominal Imped- ance	Nominal Capacitance Per Foot	Maximum Attenuation db/ft 100 MC	Max. Oper- ating Voltage RMS	Average Power Rating (Watts) ^b		Remarks	
													500 MC	5000 MC		
RG-5/U		BMA 16 ^c	16 A.W.G. Copper	0.185	2	Vinyl	0.332	0.087	51	30	0.04	0.28	5,000	510	65	Small microwave cable
RG-6/U		KS-9168 ^c KS-9226 ^c	21 A.W.G. Copperweld	0.185	2	Vinyl	0.332	0.082	75	20	0.037	0.26	2,700	-	-	Small size video and I.F. double shielded cable
RG-7/U		1F425-7 AS-48, WCS47 82064, K31 ^c , d 21B-226-7/50-1V ^c , d	19 A.W.G. Copper	0.250	1	Vinyl	0.370	0.080	85	14	0.030	-	-	-	-	Low capacitance air spaced dielectric cable
RG-8/U		1F425-8 PT5, WCS45 WCS49 CASSP-50-1	7/21 A.W.G. Copper	0.285	1	Vinyl	0.405	0.106	52	29	0.027	0.25	4,000	480	90	General purpose, medium size, flexible cable
RG-9/U		B452	7/21 A.W.G. Copper	0.280	2	Vinyl	0.420	0.150	52	29	0.027	0.25	4,000	480	90	Double shielded, medium size, low level circuit cable
RG-10/U		1F425-10 CASSP-50-1A	7/21 A.W.G. Copper	0.285	1	Vinyl and Armor	0.445	0.148	52	29	0.027	0.25	4,000	460	90	Same as RG-8/U armored for Naval equipment
RG-11/U		1F425-11 WCS52 WCS62 ^c CASSP-70-1 ^c	7/26 A.W.G. Copper	0.285	1	Vinyl	0.405	0.096	75	20	0.027	0.25	3,500	-	-	Medium size, flexible video and communication cable
RG-12/U		CASSP-70-1A ^c	7/26 A.W.G. Copper	0.285	1	Vinyl and Armor	0.445	0.141	75	20	0.027	0.25	3,500	-	-	Same as RG-11/U armored for Naval equipment
RG-13/U		1F425-13 21B-250-7/26-1XV B492	7/26 A.W.G. Copper	0.280	2	Vinyl	0.420	0.126	75	20	0.027	0.25	3,500	-	-	Double shielded I.F. cable
RG-14/U		1F425-14 BMA 10 KS-9269 ^c	10 A.W.G. Copper	0.370	2	Vinyl	0.545	0.216	51	30	0.022	0.20	6,000	730	135	General purpose semi-flexible power transmission cable
RG-15/U		1F425-15 KS-9220	15 A.W.G. Copperweld	0.370	2	Vinyl	0.545	0.197	75	20	0.022	0.20	5,500	650	115	Medium power cable designed for continuous flexing
RG-16/U		KS-9266	0.125 Copper Tubs	0.460	1	Vinyl	0.650	0.254	52	30	0.018	0.16	7,500	940	165	Medium power cable with hollow inner conductor for pressurization
RG-17/U		CASSP-50-2 KS-9256	0.188 Copper	0.680	1	Vinyl	0.870	0.460	51	30	0.014	0.15	11,000	1,460	225	Large, high power transmission cable
RG-18/U		1F425-18 CASSP-50-2A	0.188 Copper	0.680	1	Vinyl and Armor	0.910	0.585	51	30	0.014	0.15	11,000	1,460	225	Same as RG-17/U armored for Naval Equipment
RG-19/U		CASSP-50-3	0.25 Copper	0.910	1	Vinyl	1.12	0.740	51	30	0.012	0.125	14,000	2,050	285	Very large high power transmission cable
RG-20/U		1F425-20 CASSP-50-3A	0.25 Copper	0.910	1	Vinyl and Armor	1.16	0.925	51	30	0.012	0.125	14,000	2,050	285	Same as RG-19/U armored for Naval equipment.

Army Navy Type No.	Stock No.	Replaces Old Cable Number	Inner Conductor	Nominal Diameter of Dielectric ^a (In.)	Number of Shielding Braids	Protective Covering	Nominal Weight Over-all Dia. (In.)	Nominal Imped- ance Foot.	Nominal Capacitance Per Foot.	Maximum Attenuation db/ft 100 MC 5000 MC	Max. Oper- ating Voltage RMS	Average Power Rating (Watts) ^b 200 MC 5000 MC	Remarks	
														0.185
RG-21/U	1F425-21	KS-9820	16 A.W.G. Resistance Wire	0.185	2	Vinyl	0.332	51	30	0.16	0.93	-	Special attenuating cable with small temperature coefficient of attenuation	
RG-22/U	1F425-22	WC551	2 Cond. 7/28 A.W.G. Copper	0.265	1	Vinyl	0.405	95	17	0.04	-	-	Small size, twin conductor cable	
RG-23/U	1F425-23	B601 B602	2 Cond. 7/21 A.W.G. Copper	0.400	2	Vinyl	0.650 x 0.505	125	13	0.05	-	-	Balanced dual coaxial cable	
RG-24/U	1F425-24	B601A B602A	2 Cond. 7/21 A.W.G. Copper	0.400	2	Vinyl and Armor	0.715 x 1.010	125	15	0.05	-	-	Same as RG-23/U armored for Naval equipment	
RG-25/U	1F425-25	A2, 62101 KS-9823 ^f KS-9811	19/0.0117 Tinned Copper	0.308 ^f	2	Neoprene	0.565	50	60	1 MC 0.007	-	-	Medium size, pulse cable	
RG-26/U	1F425-26	A41 KS-9847	19/0.0117 Tinned Copper	0.308 ^f	1	Vinyl and Armor	0.475	50	60	1 MC 0.007	-	-	Similar to RG-25/U armored for Naval equipment	
RG-27/U	RG-27/U	B1, 62102 KS-9056	19/0.0185 Tinned Copper	0.455 ^f	1	Vinyl and Armor	0.650	50	60	1 MC 0.004	-	-	Large size pulse cable armored for Naval equipment	
RG-28/U	RG-28/U	B2 62103	19/0.0185 Tinned Copper	0.455 ^f	2	Neoprene	0.605	50	60	1 MC 0.004	-	-	Large size pulse cable	
RG-39/U	1F425-39	KS-9086	22 A.W.G. Copperweld	0.196 ^e	2	Waxed Cotton Braid	0.292	70	28	10 MC 0.018	-	-	Rubber cable to be used where high flexibility is required	
RG-41/U	1F425-41	68039 ^c KS-9498 ^c	16/30 A.W.G. Tinned Copper	0.250 ^e	1	Neoprene	0.425	70	28	10 MC 0.014	-	-	Rubber cable used for twisting applications	
RG-57/U	1F425-57	RG-43/U TCS3F-96-1 WC550	2 Cond. 7/21 A.W.G. Copper	0.472	1	Vinyl	0.617	95	17	0.04	-	-	Large size twin conductor cable	
RG-58/U	1F425-58	RG-4/U ^c	20 A.W.G. Copper	0.116	1	Vinyl	0.195	51	30	0.062	0.403	160	35	General purpose small size flexible cable
RG-59/U	RG-59/U	Uniradio 32 ^c XI-391c	22 A.W.G. Copperweld	0.146	1	Vinyl	0.242	70	22	0.050	0.33	225	45	General purpose small size video cable

^aAll cables have dielectric material of stabilized polyethylene unless noted otherwise.

^bAverage power rating calculated on basis of inner conductor having 70°F rise in temperature above ambient.

^cReplaces with minor mechanical variations.

^dReplaces with minor electrical variations.

^eDielectric material is synthetic rubber compound.

^fThe dielectric material is a synthetic rubber compound with layers of conducting rubber and the diameter is that over the second layer of conducting rubber.

1436. MAST ASSEMBLIES FOR SUPPORTING ANTENNAS - TACTICAL.

a. 50-Foot Plywood Mast AB-38/CR; Stock No. 2A2056. This lightweight mast (Maryland Engineering Company #3050) is composed of eight 6-foot 3-inch long cylindrical plywood sections fastened together by metal couplings and supported by 8 guy ropes. It may be assembled and raised by two men in about one hour and it is shipped in a single bundle 7 x 1 x 1 feet, weighing about 120 pounds, including complete accessories and tools. It is used with, but is not part of, Radio Set AN/CRC-3.

b. 30-Foot Plywood Mast; Stock No. #2630. This lightweight mast (Maryland Engineering Co. #2630) is composed of eight 45-inch long cylindrical plywood sections fastened together by metal couplings and supported by 8 guy ropes. It can be transported, assembled and erected in the field by one man. The entire mast, accessories and tools are packed into a canvas carrying bag 11 inches in diameter and 4 feet 9 inches long and weighs approximately 49 pounds.

1437. MAST SECTIONS FOR ANTENNA SUPPORTS.

a. General. This paragraph gives information on mast sections which may be employed in constructing masts for supporting antennas. In addition to the material listed, other items such as guy ropes, ground stakes and other rigging are required. See paragraph 1440.

b. Mast Sections MS-18 to MS-22 Incl.

(1) DESCRIPTION. Mast Sections MS-18 to 22 inclusive are 8-1/2 feet long spruce sections which may be joined to form a supporting mast 42 feet or more in height. The two upper sections are 2-1/2 inches in diameter and the three other sections are 3-1/4 inches in diameter. The intermediate sections have a hole in one end and a coupling tube projecting 12 inches on the other end. The top section has a hole in each end, one to fit Mast Cap MP-6 and the other to fit over the coupling tube of the next lower section. The bottom section has a coupling tube at each end, one to fit Insulator IN-4 and the other to fit into the hole of the next higher section.

(2) STOCK NUMBERS

Mast Section	Location	Supported by	Stock No.
MS-18	Top	MS-19	2A2318
MS-19	Intermediate	MS-19 or 20	2A2319
MS-20	Intermediate	MS-20 or 21	2A2320
MS-21	Intermediate	MS-21 or 22	2A2321
MS-22	Bottom	IN-4	2A2322

c. Mast Section MS-44; Stock No. 2A2314.

This is a 5-foot long aluminum alloy tube equipped with an aluminum alloy sleeve which protrudes an additional 6 inches. The outside diameter of sleeve is 1.355 inches. Sections may be fitted end to end to form an antenna supporting

mast 30 feet high. Normally used with Mast Base MP-19 (Stock No. 2A2079) and Guy Plate MP-20 (Stock No. 2A1350).

d. Mast Section MS-44-A; Stock No. 2A2344A. This is the same as MS-44 except that it is made of cold rolled electric welded steel tubing, SAE-1010 unannealed.

e. Mast Section MS-91 to MS-94 Incl.

(1) DESCRIPTION. Mast Sections MS-91 to MS-94 inclusive are straight grain fir sections 8 feet long x 1-19/32 inches in diameter which may be joined to form a 32-foot antenna support. Brass tubing and sleeves are fitted to the ends of the mast sections for making connections to other sections. They are a part of Antenna Equipment RC-63.

(2) STOCK NUMBERS.

Mast Section	Location	Supported by	Stock No.
MS-91	Top	MS-92	2A2391
MS-92	Intermediate	MS-93	2A2392
MS-93	Intermediate	MS-94	2A2393
MS-94	Bottom	-	2A2394

1438. METALLIC MAST SECTIONS FOR VERTICAL RADIATORS FOR GROUND USE.

a. Mast Sections MS-49 to MS-56 Incl.

(1) DESCRIPTION. Mast Sections MS-49 to MS-56 inclusive may be joined to form an antenna 25 feet high. They are made of chrome molybdenum steel tubing 37 inches long. The ends of the mast sections are painted different colors to facilitate the lining up of mast sections during assembly. They are a part of Radio Sets SCR-178, 179, 203 and 284-A.

(2) STOCK NUMBERS.

Mast Section	Location	Outside Diam. - Inches	Supported by	Stock No.
MS-49	Top	0.179	MS-50	2A2349
MS-50	Intermediate	0.265	MS-51	2A2350
MS-51 ^a	Intermediate	0.357	MS-52	2A2351
MS-52 ^{b,c}	Intermediate	0.438	MS-53	2A2352
MS-53	Intermediate	0.500	MS-54	2A2353
MS-54 ^b	Intermediate	0.562	MS-55	2A2354
MS-55	Intermediate	0.593	MS-56	2A2355
MS-56	Bottom	0.625	IN-85 or IN-91	2A2356

^aAlso fits Mast Base MP-22.

^bAlso fits Mast Bases MP-14, 14-A, 37, 48 and 57.

^cSeating plug and threads will also fit into upper end of MS-55.

b. Mast Sections MS-65 to 73 Incl.

(1) DESCRIPTION. Mast Sections MS-65 to MS-73 may be joined to form a 45-foot vertical antenna. They are made up of aluminum sections 66 inches long. These mast sections are a part of Radio Set SCR-197.

(2) STOCK NUMBERS.

Mast Section	Location	Outside Diam. - Inches	Supported by	Stock No.
MS-65	Bottom	2-1/4	Insulator IN-102 ^a	2A2365
MS-66	Intermediate	2-1/4	MS-65	2A2366
MS-67	Intermediate	2	MS-66	2A2367
MS-68	Intermediate	1-3/4	MS-67	2A2368
MS-69	Intermediate	1-1/2	MS-68	2A2369
MS-70	Intermediate	1-1/4	MS-69	2A2370
MS-71	Intermediate	1	MS-70	2A2371
MS-72	Intermediate	3/4	MS-71	2A2372
MS-73	Top	3/8	MS-72	2A2373

^a Part of MS-65.

1439. METALLIC MAST SECTIONS FOR VESICULAR RADIATORS.

a. Mast Sections MS-49 to 53, Incl.
These masts are commonly used with Mast Bases MP-37 or MP-57 on vehicular installations to form a 15-foot whip antenna. They are also used for ground installations as covered in paragraph 1438 a.

b. Mast Sections MS-116, 117 and 118.
(1) DESCRIPTION. These mast sections are copper plated seamless tubing 39-1/2 inches long. They are fastened together by female and male threads at the top and bottom respectively. A 6-foot whip antenna made up of two Mast Sections MS-117 and 118 with Mast Base AB-15/GR can be used to replace Mast Sections MS-52 and 53 with Mast Base MP-48. A 9-foot whip antenna made up of one each of Mast Sections MS-116, 117 and 118 with Mast Base AB-15/GR can be used to replace MS-51, 52 and 53 with Mast Base MP-48 or 48-A. A 15-foot whip made up of one each of Mast Sections MS-116, MS-117 and MS-118 with Mast Base MP-65 can be used to replace Mast Sections MS-49 to 53 inclusive with Mast Base MP-37 or MP-57.

(2) STOCK NUMBERS

Mast Section	Diameter - Inches	Supported by	Stock No.
MS-116	3/8	MP-65 or AB-15/GR	2A2416
MS-117	3/8 tapering to 1/4	MS-116	2A2417
MS-118	1/4 tapering to 1/8	MS-117	2A2418

1440. ACCESSORIES USED IN CONSTRUCTING TACTICAL ANTENNAS.

a. The following materials, listed alphabetically, are commonly used in constructing antennas for use with tactical radio sets.

Name and Description	Stock No.
Block FT-127: Single swivel eye; malleable iron, galvanized. Part of Radio Sets SCR-177-() and SCR-188-().	2A347
Counterpoise CP-12: Metal clamp bar with stud and wing nut and two 25-foot lengths of wire on each end. One end also has a 48-inch lead-in wire. Used with Counterpoise CP-13. Part of Radio Set SCR-284-A.	2A712
Counterpoise CP-13: Same as Counterpoise CP-12 except that it has no lead-in wire and clamp has a slot for slipping into place under the wing nut of Counterpoise CP-12. Part of Radio Set SCR-284-A.	2A713
Fastener FT-9: 5/8 x 3 inch cast iron slide adjuster for test and antenna guy ropes.	2Z4309
Fitting FT-128: Cadmium-plated steel, rope wedge. Part of Radio Sets SCR-177-() and SCR-188-().	2A1128
Fitting FT-148: Guy rope fitting; same as fitting FT-128 except one end enlarged to take a larger thimble measuring approximately 1/4 inch square at end. Part of Guys GY-22, GY-23 and GY-24.	2A1148
Ground Rod GP-16: A round galvanized iron rod, 1/2 inch diameter, 24 inches long, pointed at one end and equipped with a loose iron ring at the other end; the rod is slightly flattened 3/4 inch below the ring and a machine screw for making line connections is threaded through the rod. Formerly called "Type E". Net weight 1.5 pounds.	5B4416
Ground Rod GP-24: Hexagonal galvanized steel rod; 18 inches long; pointed on one end and bent in a goose-neck with 10 feet of insulated wire at the other end. Net weight 1 pound.	4G724
Ground Rod GP-26: Round galvanized iron rod; 1/2-inch diameter, 6 foot long; one end pointed; other end has copperwire with free end 5 inches long for attaching to ground wires. Hubbard No. 9506 or equal. Net weight 4 pounds.	5B4426

<u>Name and Description</u>	<u>Stock No.</u>	<u>Name and Description</u>	<u>Stock No.</u>
Ground Rod GP-28: Hubbard No. 9425 rod (modified); copper-weld, with clamp and 8 foot lead of No. 8 stranded wire. 4 feet long x 1/2 inch diameter. Used to ground Truck K-18-(). Part of Radio Set SCR-197-(). Net weight 4 pounds.	3Z3328	Rope RP-3: Sash cord; No. 5; white braided cotton, No. 12 yarn; 5/32 inch diameter to 11/64 inch diameter.	6Z7925
Ground Rod GP-29: Steel pipe, 33 inches long, with pointed end, a driving head and means for attaching ground lead. Net weight 8 pounds.	3Z3329	Rope RP-5: Sash cord; No. 6; white; 3/16 inch diameter, minimum breaking strength 200 pounds.	6Z7926
Hook FT-93: S shape, cold-rolled steel; cadmium-plated; with open links; over-all dimensions, 2-1/4 x 1 x 1/4 inches thick. Part of Ring FT-74. Net weight 1-1/4 ounce.	2A1493	Rope-Nylon: 1150 foot length, 3/16 inch diameter; olive drab, 3 strands; 650 pounds test, very slightly affected by moisture.	6Z7920
Hook FT-131: S shape, cold-rolled steel; cadmium-plated; with open links; over-all dimensions, 2 x 7/8 x 3/16 inches thick. Similar to Hook FT-93 except different dimensions. Part of Guy GY-34 and Radio Sets SCR-177-() and SCR-188-(). Net weight one ounce.	2A1501	Snap FT-126: Polo bit; steel; cadmium-plated. Part of Radio Sets SCR-177-() and SCR-188-().	2A3212
Insulator IN-55: Strain; hard-rubber; 3-1/2 inches long x 5/8 inch diameter; has a hole 7/32 inch diameter through each end.	3G555	Stake GP-2: Solid galvanized iron rod; 16 inches long x 3/4 inch diameter, head 1-1/8 inch diameter; used for fastening guy ropes and antennas.	2A3302
Insulator IN-86: Strain; Isolantite body 2 inches long x 3/4 inch diameter, with 9/16 inch eye bolt screwed into each end; Isolantite may be replaced if broken and eye bolts used again. Part of Radio Sets SCR-177-() and SCR-188-().	3G586	Stake GP-8: Ground; 18 inches long; 3/8 inch steel gas pipe with a rivet on the upper end; the lower end is pointed; binding post attached on one side, 2-3/4 inches from head.	2A3308
Insulator IN-87: Spreader; for transmission line to half-wave antenna; consists of Isolantite body 5/8 inch diameter x 2-3/4 inch long, with a catch at each end.	3G587	Twine RP-11: Braided; breaking strength, 70 to 80 pounds; treated with insulating compound.	6Z8811
Insulator IN-88: Strain, cylindrical; Grade G ceramic per spec. 71-229; 1/2 inch diameter x 2-3/4 inches long; an improvement over Insulators IN-78 and IN-78-A. For use in aircraft antennas where a small strain type may be required; test load 300 lbs.	3G588	<u>1441. ANTENNA KITS - FIXED PLANT.</u> a. <u>General.</u> Drawings accompany each of the antenna kits described below, giving design dimensions for the antennas for all frequencies within their range of usefulness. The materials provided in the antenna kit are sufficient to construct the largest antenna shown in these designs. b. <u>Rhombic Transmitting Antenna;</u> <u>Stock No.</u>	
Line Clamp: (Stanley Pull-Tite No. 7070) For use on 3/16 inch nylon rope in place of Fastener FT-9; causes less wear on the rope.		Antenna, Horizontal Rhombic, Transmitting; per Signal Corps drawing ES-E-368-C (less poles, guys, transmission line and dissipation line). Dissipation Line Kit, for Rhombic Transmitting Antenna, per Signal Corps drawing ES-E-368-C. Pole Guy Kit, type 75PXX, Signal Corps drawing ES-B-32502-A. Extra heavy duty. Two required for antenna supported with poles. For long diagonal. Pole Guy Kit, type 75PX, Signal Corps drawing ES-B-32500-A. Heavy duty. Two required for antenna supported with poles. For short diagonal. Transmission Line Kit, for Rhombic Transmitting Antenna, Signal Corps drawing ES-E-368-C.	

c. Doublet Transmitting Antenna, Delta; Stock No.

Antenna System, Doublet Transmitting Delta match, Signal Corps drawing ES-D-252-E, less supports.

Pole Guy Kit, type 75P, per Signal Corps drawing ES-D-252-E. (Light duty type. 2 required with each Doublet Antenna when used with poles.)

d. Intermediate Frequency Antenna; Stock No. 2A299-OP7.

Antenna, Intermediate Frequency, Transmitting, 5-wire flat-top, Signal Corps drawing ES-E-335-B.

e. Double Vertical Cage; Stock No. 2A299-QP2.

Antenna System, dual vertical cage, Signal Corps drawing ES-E-299-B (less supports and ground system).

f. Rhombic Receiving Antenna; Stock No.

Antenna Kit, Rhombic Receiving per Signal Corps drawing ES-E-386-C (less transmission line).

Transmission Line Kit, for Rhombic Receiving Antenna, per Signal Corps drawing ES-E-386-C (500 ft.)

Pole Guy Kit, type 75P, per Signal Corps drawing ES-B-19424-B. (Light duty type. 4 required for each Rhombic Receiving Antenna, when used with poles.)

g. Double-Doublet Receiving Antenna, Stock No.

Antenna Kit, Double-Doublet, Receiving per Signal Corps drawing ES-E-276 (less supports, but including 150 feet of transmission line).

Transmission Line Kit, per Signal Corps drawing ES-E-386-D. (1 required for each Double-Doublet Antenna if over 150-foot line is required.)

Pole Guy Kit, type 75P, per Signal Corps drawing ES-B-19424-C. (Light duty type. 2 required for each Double-Doublet when used with poles.)

h. Resonated Vertical Whip, Receiving; Stock No. 2A298.

Antenna, receiving vertical whip, adjustable, with resonating circuit box, less coils and condensers (Signal Corps drawing ES-D-348-C).

1442. ANTENNA COUPLING UNITS.

a. Antenna coupling transformer, Western Electric Co. D-163678 (Stock No. 2C471) is intended to operate over the frequency range of 4 to 20 Mc between a balanced horizontal rhombic receiving antenna and an unbalanced 72-ohm coaxial transmission line, or between a 200-ohm balanced line and an unbalanced 72-ohm coaxial transmission line. It is equipped with lightning protector gaps. The overall dimensions of the transformer are 12 x 11-3/8 x 14 inches.

b. Antenna Multicoupler, R.C.A. Model S-8853-1 (Stock No. 2A2698) for use in the frequency range of 4 to 24 Mc, provides facilities for feeding up to ten receivers from a single antenna. By its use, excessive loss due to the paralleling of numerous receiver input circuits is avoided. Crosstalk interference from

the high-frequency oscillators in the receivers is effectively reduced and radiation by the antenna minimized. The Antenna Multicoupler is supplied with two input transformers. One, with unbalanced input, is designed to work from a 75-ohm coaxial line and the other, with balanced input, has windings which are connected in parallel for input impedances between 75 and 300 ohms and in series for impedances between 300 and 1000 ohms. The output of the multicoupler appears as ten separate circuits, each being terminated in a Western Electric 75-ohm coaxial jack (WE-464A) which may be connected to the receivers through either 50 or 75-ohm coaxial cable. This multicoupler utilizes thirteen 6AC7 vacuum tubes for isolation purposes. An AC or DC filament supply of 6.3 volts and 5.9 amperes and a DC plate supply of 125 to 135 volts and about 0.13 ampere is required for operation. The multicoupler weighs 9 pounds without tubes and is arranged to mount on a standard 19-inch rack, occupying 5-1/4 inch of vertical space and a depth, including tubes, of 5-1/4 inch.

1443. BASE INSULATED TOWERS USED AS VERTICAL RADIATORS - FIXED PLANT.

a. 180-Foot Windcharger, Type 101.

(1) DESCRIPTION. The 180-foot Windcharger Type 101 tower is of the guyed vertical type with base insulation. It consists of nine 20-foot sections triangular in shape and lattice braced, with guys at 5 different levels, 3 to each level. Erection of the tower is accomplished by first setting up the bottom 20-foot section on the base insulator and then through use of a gin pole arrangement raising additional 20-foot sections, fitting each on top of the other until the tower is full height. The tower is supplied complete with all guys, plates, insulators, concrete for base, gin pole, and all tools and other accessories required for its erection. The base insulator supplied is Lapp Type 10027 or a Locke type 91439, which has a dry flashover of 75 KV and a wet flashover of 35 KV. If the tower is to be used at low frequencies (150 to 450 KC) with a power exceeding 2 KW, guy insulators suitable for the high voltage developed should be ordered separately. This tower is suitable for use with such transmitters as the T-5/FRC, Wilcox 96-200, BC-365, etc.

(2) MATERIAL LIST.

Quantity	Name	Stock No.
1	Windcharger tower, complete with base insulator, guys, anchors, etc.	2A3451
50	Suspension type insulators	3G1350-38
As Required	Pole Lighting Material	(par. 1446b)
As Required	Material for Ground or Counterpoise	(par. 1445b)
1	Transformer tower lighting unit, Type I	(par. 1446a)

b. 125-Foot Self-Supporting (BlawKnox)

(1) DESCRIPTION. 125-foot self-supporting insulated towers were procured on CAA Specification 98. The towers are of two types. Blaw Knox Type 9A is a heavy duty tower and the Blaw Knox Type 10 is the standard tower. The 9A should be specified where extreme wind and icing conditions prevail. Both are of the 5 point suspension type, having 4 compression type insulators supporting the corner members and 1 compression type for the center hold down. They are equipped with a ladder to the top and are furnished with standard CAA lighting which includes prismatic type fixtures. These towers are primarily intended for use with the CAA 400 watt SHA radio range. However, they are available for other uses such as homing or low frequency point-to-point communication installations. Base insulators have a dry flashover of 40 KV at 60 cycles and will withstand 12 KV unmodulated RF at 400 KC. The insulation is suitable for powers up to 1000 watts at low frequencies. The towers are supplied complete with lighting fixtures, a counterpoise system consisting of a steel mesh 50-foot square mounted on a steel frame, small tools and complete instructions for installation. No base material other than base steel members is furnished.

(2) MATERIAL LIST

Quantity	Name	Stock No.
1	Blaw Knox Type 10 (Standard)	2A3449
or 1	Blaw Knox Type 9A (Heavy Duty) (Both towers are complete except for isolating lighting transformer)	
1	Transformer, tower lighting unit Type II	(par. 1446a)

c. 90-Foot Insulated Tower.

(1) DESCRIPTION. This 90-foot guyed insulated tower is of triangular lattice construction. It is equipped with one set of guys located 30 feet from the top of the tower. The guys are attached to a special compression type insulator which simplifies greatly the guy insulation problem. The tower rests on a special compression type insulator. The sub-base is steel of pyramid design and is buried in the ground over most of its height and therefore requires no concrete. The tower is erected by fitting a section at a time on the bottom and jacking up the entire tower with a special jack arrangement. Complete erection details are furnished. The tower is normally used with a counterpoise system consisting of 36 radials extending out from the base of the tower for a distance of 65 feet and suspended 8 feet above ground for 50 feet of their length. When a radio range kit, is furnished, towers and counterpoise are included in the kit.

When towers are ordered as separate items and counterpoises are required, they must be ordered as separate items. These towers are intended for use with the Adcock Radio Range Assembly, but 500 extra towers were ordered for converting loop ranges and for other use. Erection equipment is not furnished, but is available to sectors for team use. Base insulator and primary guy insulators have a flashover rating of 40 KV and will withstand an RF unmodulated voltage of 12 KV at 400 KC. Insulation is suitable for power up to 1000 watts at low frequencies.

(2) MATERIAL LIST

Quantity	Name	Stock No.
1	Tower, complete with guys, anchors and hardware	2A3447.1
1	Counterpoise	2A736
As Required	Pole Lighting Kit 100 ft. Wraplock	(par. 1446 b) PA-30183
As Required	2-conductor underground cable (Parkway Cable No. 12 - 85-foot length)	1D662-1
1	Transformer, tower lighting unit, Type II	(par. 1446 a)

d. Light Duty 90-Foot Insulated Tower.

(1) DESCRIPTION. This 90-foot guyed tower is of the base insulated type for use as a vertical radiator. The tower is extremely light and is of triangular lattice braced design. It is air transportable and is designed to be assembled on the ground and raised as a unit. Except for the addition of a base insulator, the tower is similar to the 75- and 90-foot noninsulated light duty antenna supporting towers described in paragraph 1444 a. Complete instructions for erection are furnished with the tower. Each tower is supplied complete with gin pole for erection; blocks and rope are not supplied. Insulation of the tower is limited by the guy insulators which have a dry flashover voltage of 16 KV at 60 cycles. The tower should not be used as a radiator at powers exceeding 1000 watts at low frequencies.

(2) MATERIAL LIST.

Quantity	Name	Stock No.
1	90-Foot Tower, including base insulator	FTN-37577
As Required	Material for Ground System	(par. 1445 b)
1	Pole Lighting Kit	626934-90
1	Transformer, tower lighting unit Type II	(par. 1446 a)

1444. TOWERS FOR SUPPORTING ANTENNAS - FIXED PLANT.

a. 75- and 90-Foot Light Duty Towers.

(1) DESCRIPTION. These 75 and 90-foot guyed towers are of the noninsulated

type for use as antenna supports. They are extremely light, of triangular lattice braced design, and are suitable for supporting light receiving antennas; such as a single wire or doublet. They are designed for a 1000-pound head load and any load over this amount will greatly decrease their safety factor. They were originally procured as 90-foot towers. Some were shipped as 90-foot towers and were later furnished with a modification kit to reduce them to 75 feet. Except for the absence of base insulation, these towers are similar to the base-insulated 90-foot light duty tower described in paragraph 1443 d. They are air transportable and are designed to be assembled on the ground and raised as a unit. Complete instructions for erection are furnished with the towers. They are supplied complete, including a gin pole for erection; blocks and rope are not supplied.

(2) MATERIAL LIST.

Quantity	Name	Stock No.
1	90-Foot Tower, complete with erection system	2A3447
1	75-Foot Tower (same as 90-foot tower except shorter)	FIN-37699
1	Pole Lighting Kit	(par. 1446 b)
1	Transformer, tower lighting unit, Type II	(par. 1446 a)

b. 73-Foot 7-Inch Rhombic Tower.

(1) DESCRIPTION. The 73-foot 7-inch heavy duty tower is designed for supporting heavy Rhombics and similar applications. It is a fabricated, triangular, lattice braced, galvanized steel tower which is shipped knocked down for assembly in the field. The tower will withstand a horizontal load of 11,000 pounds at the center antenna attachment plate, or horizontal loads of 1,450 pounds at each of the three antenna attachment plates. The tower is designed for complete assembly on the ground and erection in one piece with a gin pole arrangement. The tower is complete with all guys, instruction books and anchors, but less erection equipment.

(2) MATERIAL LIST.

Quantity	Name	Stock No.
1	Tower, complete	2A3448
1	Shackle, galv. steel, 5/8" pin, 7/8" clevis	5B15414
2	Thimble PF-43, galv. iron, grooved for 3/8" opening	5B18043
As Required	Pole Lighting Kit. 90-foot	6Z6934-90 (par. 1446 b)
100 Ft.	Wraplock	P4-30183

The following items are to be supplied to each location for erection purposes only and are needed in addition to Tool Equipment TE-87-A.

1	Erection equipment kit consisting of:	
5	Anchor, Screw Type, 6"	FINP-2826
2	Clip, wire tape, 1/2"	5B4108
2	Thimble PF-44, galv. iron, grooved for 1/2" opening	5B18044
1	Pulley, for gin pole	6Q8806.1
1	Pole, wood 35-foot, class 6	P4-30543

1445. GROUND SYSTEM FOR RA IO TOWERS - FIXED PLANT.

a. Description. (1) A ground system to be used with the 90 or 180-foot vertical radiator may consist of 36 radials spaced 10 degrees apart extending outward from a common terminal at the base of the tower for at least 350 feet with each radial buried in a trench to a depth of 6 to 8 inches. Each radial ground wire should consist of copper or copperweld conductor not smaller than #12 B & S gauge, soldered at its free end to a ground rod driven to a depth of six feet. When the 180-foot vertical radiator is used where extensive snow storms or poor conducting soils are found, the ground screen described below may be furnished in addition to the ground system just outlined. If snow drifts do not form on the antenna site, the ground screen may be placed on the earth. If drifting occurs on the installation site, the ground screen should be suspended so as to be above the snow drifts.

(2) A ground screen support may be constructed as follows: The 4 x 4's furnished should be erected on 12-foot centers, connected at their tops with 2 x 6's to form a support frame for the screen mesh at the required height above the earth. The screen mesh should be stapled on top of this supporting frame and each adjacent sheet bonded together using No. 12 BWG wire (stock No. 1A812). Each joint should be soldered. The suspended ground screen should be connected to the buried ground system at the tower base and points on the outer edge of the screen should also be connected directly to the ground wire radial immediately beneath. A connection from the ground system to the antenna tuning house should be made at the tower base. This connection should be short and have a very low resistance. One hundred forty sheets of Econo mesh will cover an area of 96 feet x 96 feet with two sheets to spare.

b. Material List.

Quantity	Name	Stock No.
The following items are used to construct the ground system described in a (1) of this paragraph.		
12,000 ft.	Copperweld wire, .080", #12 gauge	1A153
2,640 ft.	Wire, #12 BWG, GI (1/2 mile coil)	1A812
40 ea.	Ground Rod GP-26	5B4426
5 gal.	Paint, black, ready mixed	6G1419
3 gal.	Preservative, wood	6G1624
1 keg	Nails, 20 d, 100 lbs.	6L1420
10 can	Paste, soldering 2 oz. can	GN4102
10 lbs.	Solder M-30	6N7530

The following items are used to construct the ground screen described in a (2) of this paragraph.

140 shts.	Econo mesh, United States Gypsum Co., style 3-9-175, mesh size 3 x 8, gauge 9, strand 5/32 x 9/64, width 6 ft., length 12 ft. galvanized or equal	6Z6988
100 pc.	Lumber, 4" x 4" x 12", #1 grade pine or equal	
250 pc.	Lumber, 2" x 6" x 12", #1 grade pine, or equal	
50 lbs.	Staples, 1-1/2" galvanized	

1446. TOWER LIGHTING EQUIPMENT - FIXED PLANT.

a. Transformers. (1) DESCRIPTION. Special transformers for lighting vertical radiator towers have been procured. These transformers are for the purpose of isolating the power source from the RF tower circuits. The transformers consist basically of one circular secondary winding connected to the tower circuit thus placing this winding assembly at the RF potential of the tower. The primary, circular in design, is completely isolated from the secondary and the entire assembly is immersed in oil. Two types are available; one is designed for a peak RF voltage of 45 KV and one for 90 KV, under wet conditions. The transformers are

designed for either 110 or 220-volt 60-cycle 1-phase input and have a tapped secondary for various loads. The transformers are intended for mounting on the tower base. Material for mounting transformers is available in set assembly 57A, drawing ES-D-32577. The transformer is equipped with a lightning gap and rain shield.

(2) STOCK NUMBERS.

Name	Stock No.
Type I Transformer, Tower lighting unit, in accordance with Spec. 171-229, 90 KV RF insulation.	3H5600A25
Type II Transformer, Tower lighting unit, in accordance with Spec. 171-229, 45 KV RF insulation	3H5600A25-1
As required, Plant Set Assembly 57A, material for mounting transformer (Dwg. ES-D-32577)	

b. Lighting Kits. (1) DESCRIPTION.

Four types of lighting kits have been procured for poles and can be adapted for towers. All kits have conduit, condulets, fixtures, connector blocks, wire, lamps, clamps, etc. and are complete for mounting the fixtures on the pole or tower. Three of the kits are for 90-foot poles and the other one is for a 60-foot pole. Two of the 90-foot pole kits have red prismatic fixtures as recommended by CAA, and the others have red vapor proof obstruction lights. Miscellaneous fixtures, blocks, straps and other material for pole or tower lighting are also available.

(2) STOCK NUMBERS.

Name	Stock No.
Pole Lighting Kit, complete with 80 feet of conduit, 4 sets of lamps and equipment for lighting a 60-foot pole. Includes 200 feet of 2-conductor underground cable.	6Z6934-60
As above, but for 90-foot pole.	6Z6934-90
Pole Lighting Kit, complete with 80 feet of conduit, fixtures, lamps and equipment for lighting a 90-foot pole. Includes 85 feet of 2-conductor underground cable (procured on order 1460-Ph-44)	
Lighting Kit, for lighting 90-foot pole or tower, complete with all fixtures, clamps, conduits, etc. Meets new AN Specifications. Does not include underground cable. (Ordered on PR-44-3564, Drawing ES-C-32578)	

INDEX

A

	<u>Paragraph</u>
AB-38/CR Mast, Antenna	1436
Adapter Plug, U-4/GT	406
ADW-EM-100, Observing Equipment	432, 433
Aerial Cable Lines - Materials for Construction	624
AH-, Anchors and Anchor Rods	607-609, 624
Aircraft Accessories Corp., Radio Transmitter 500B	1426, 1429
Air Warning Service Facilities	501-504
Airways Radio, AACS	1420, 1426-1431
Alignment Equipment, MB-73	1308, 1309
Alignment Indicator, I-210	1317, 1318
Amertype Recordgraph Co., Model A, Commando Amplifier, (W.E.Co. 108A)	432, 433
AN/CRC-3 and 3A Radio Sets	1317, 1318
AN/MGC-1 Radioteletype Terminal Equipment	1408, 1410, 1413
AN/YRR-3 Radio Receiver - Diversity	1027, 1028, 1031, 1032
AN/GRR-2 Radio Receiver (National)	1423, 1425, 1427, 1430
AN/GRR-3 Radio Receiver (Hallicrafters)	1427, 1430
AN/TGC-1 Teletypewriter Set	1427, 1430
AN/TRA-1 Radio Set (Amplifier)	1026, 1028
AN/TRA-2 Remote Control Equipment	1320, 1408, 1410
AN/TRC-1, 3, 4	1415, 1416
AN/TRC-2	1408, 1410
AN/TRC-7	1408, 1412
AN/TRC-8, 11, 12	1408, 1412
AN/TTQ-1 Operations Center	1408, 1410
AN/TXC-1 Page Facsimile Set	503, 1320
AN/VRC-1 Radio Set	1104-1106
AN/VRC-3 Radio Set	1408, 1414
Analyzer, I-153, etc.	1408, 1411
ANB-H-1 Receiver, Telephone	1317, 1318
ANB-M-C1 Microphone	307, 308
Antennas and Associated Equipment	304
Accessories	1432
Coaxial Cables for Transmission Lines	1440
Coupling Units, Antenna	1435
Kits, Antenna, Fixed Plant	1442
Kits, Antenna, Tactical	1441
Masts and Mast Sections	1433
Towers	1436-1439
Tuning Unit (BC-)	1443-1445
Typical Antenna - Sketches	1408
Vehicular	1404, 1408, 1428
Vertical Radiators	1408, 1439
Wire	1438, 1443
Army Publications	1434
AS- Antenna Kits	103
Attenuator (W.E.Co. 5A)	1433
Automatic Electric Co. Switchboard	1317, 1318
Automatic Morse	423-427
AWS Information Centers	1026, 1028
	501-504

B

BA- Dry Batteries	1225, 1226
Batteries, Dry	1220, 1225-1227
Commercial Equivalents	1227
Types	1225, 1226
Batteries, Lead Storage	1219, 1221-1224
Electrolyte	1223
Terminal Adapter	1224
Types	1221

B (Cont'd.)

	<u>Paragraph</u>
BB- Storage Batteries	1221, 1222
BC-148 to BC-1335 Tactical Radio Set Components	1408
BC-315 to BC-1100 Fixed Plant Transmitting Equipment	1422, 1424, 1426, 1429
BC-779, 794 Fixed Plant Radio Receiving Equipment	1423, 1425
BC-908-B, 918-B Facsimile Set Components	1105
BC-1052 Analyzer	1317, 1318
BD-9 to BD-120 Telephone Switchboards	410-414
BD-90, 98, 132 Power Panels	410
BD-100 Telegraph Switchboard	1006, 1010
BE-70 to BE-72 Cabinets (Test)	410, 429, 430, 1317, 1318
BE-77-() Line Unit (Teletypewriter)	1006, 1010
Bias Meter, I-97	1317, 1318
Elaw Knox Towers	1443
Boehme Equipment	1026, 1028
Runnell 6 KW Radio Amplifying Equipment	1422, 1424

C

C-114-A Loading Coil	614
C-144-A, etc. Coil Set for SCR-177-A	1408
C-144-A to C-152-A Coil Set for SCR-188	1408
C-161 Repeating Coil (Simplex)	906, 910
Cabinet, Apparatus, Telephone	920, 921
Cable:	
Aerial - Materials for Construction	624
Assemblies and Stubs	614, 615, 639
Equipment for Placing and Removing	635
European	702-707
Field	614, 615
International	705, 707
Lead-covered	618-623, 638
Entrance and Intermediate	710
Loading, European Systems	702-708
Loading, United States Systems	621-623, 709
Maintenance, Tool and Test Equipment	637-640, 1320
Protectors	808-810
Rubber-covered	614, 615, 639
Spiral-Four (CC-358)	612, 614-617
Submarine	641-643, 712-717
United States	708-710
Carrier Systems - Illustrative Equipment Problems:	
Interconnection of Tactical and Fixed Plant Telegraph	215-217
Open Wire Carrier System, Tactical	209-211
Open Wire Fixed Plant System	212-214
Carrier Telegraph Equipment:	
Fixed Plant	1025, 1028
Maintenance, Tool and Test Equipment	1320
Packaged Carrier Equipment	1025, 1028-1030
Single-Sideband	1025, 1422, 1425
Tactical	1007, 1010
Terminal, TH-1/TCC-1 (S + DX)	1025
Terminal Set, TC-22	1009, 1011
Terminals, CF-2-A & B and CF-6-A	1007, 1010
Carrier Telephone Equipment:	
C Carrier and H Carrier	919, 921
Converter, CF-4-()	908, 910
Filter, Line	919, 921
Fixed Plant (see "Packaged Telephone Equipment")	
Hybrid, CF-7	908, 910
Maintenance, Tool and Test Equipment	1320
Packaged Equipment	917-925
Repeater	908, 910, 917, 919, 921
Ringing Equipment	909, 910, 918, 921
Spiral-Four and Open Wire Systems	911-913
Terminal, CF-1-A	908, 910

C (Cont'd.)

	<u>Paragraph</u>
Catalog, Signal Supply	1304, 1305
CC-344 Cable Stub	614, 615, 639
CC-345 Cable Assembly	614, 615, 639
CC-355-A Cable Assembly	614, 615, 639
CC-356 Cable Stub	614, 639
CC-358 Cable Assembly	614, 615, 639, 641
CC-368 Cable Assembly	614, 639
CCIF Standard Loading Systems	706, 707
CK-11-() Reel Equipment	635
Central Office Sets, Telephone, Tactical	410-414
CF-1-A Telephone Terminal (Part of TC-21)	908, 910
CF-2-A and B Telegraph Terminal	1007, 1010
CF-3-A Repeater (Part of TC-25-())	908, 910
CF-4-() Converter (Part of TC-33-())	908, 910
CF-5-() Repeater (Part of TC-37-())	908, 910
CF-6-A Telegraph Terminal	1007, 1010
CF-7 Carrier Hybrid	908, 910
Chest Sets	312
Coaxial Cables for Antenna Transmission Lines	1435
Coil, Repeating, C-161	906, 910
Coil, Loading, C-114-A	614
Collins, 18-Q Radio Set (Navy TCS)	1428, 1431
Collins, 32-RA Transmitting Equipment	1426, 1429
Command Radio Sets, Fixed Plant	1418, 1422-1425
Commercial Power Services	1228-1232
Composite Equipment	917, 921
Construction Materials for:	
Aerial Cable Lines	624
Fixed Plant Open Wire Lines	609
Spiral-Four Cable	616
Tactical Open Wire Lines	606-608
Construction Time, Outside Plant	629
Converter, CF-4-()	908, 910, 1320
Converter, Facsimile, CV-2/TX	1103-1106
Converter, M-222	1217, 1218
Converter Set, TC-33-()	909, 910
Cook Protective Equipment	802, 803, 805, 808
Counterpoise, CP-12, 13	1440
Cross Reference Table of Maintenance Tools and Test Equipments and Sets	1319, 1320
CV-2/TX Converter, Facsimile	1103-1106

D

Diversity Telegraph Circuits:	
Frequency, Single-sideband	1025, 1422-1425
Space	1027, 1028, 1031, 1423, 1427, 1430
DR-4, 5, 7, 8 and 15 Reel (Drum)	635
DXD-1 and 4 (Teletype Corp) Test Sets	1317, 1318

E

Earthborer and Pole Setter (Model HD) on K-44	636, 1320
EE-8-() Telephone	315, 1320
EE-65 Test Set	1317, 1318
EE-89-A Telephone Repeater	906
EE-91to EE-93 Telephone Boxes	315
EE-97, 98, 102 Teletypewriter Sets	1009, 1011
EE-99-() Telephone Repeater (Part of TC-29-())	906, 910
EE-100-() Ringing Equipment	907, 910
EE-101-() Ringing Equipment (Part of TC-24-())	907, 910

E (Cont'd.)

	<u>Paragraph</u>
EE-105 Telephone Unit	908, 910, 921
Electrolyte	1223
Engine Driven Generator Sets (see "Generator Sets")
Entrance and Intermediate Cable Loading	710
European Cable Loading Systems	702-707
European Cable Map	718
Expendable Supplies	1303 _b , 1308

F

Facsimile Equipment:
Page and Tape	1102-1106
Supplies	1107
Federal, 123AY Radio Receiver	1427, 1430
Federal, FT-300 Transmitter Equipment	1426, 1429
Field Cables	614
Transmission Data	615
Field Strength Meter, I-95	1317, 1318
Field Wires & Cables, General	611-615
Construction	630
Rate of Construction	630
Transmission Data	615
Filter Center, TC-15	502-505, 1320
FM 11-5 Field Manual	103
FM 11-20 Field Manual	103
FM-19 Main Distributing Frame	410, 411
FM 21-6 Field Manual	104
FM 24-5 Field Manual	103
FM 24-18 Field Manual	103
FM-64 Cross Connecting Frame	410, 411
FM 101-10 Field Manual	103
42B1 (W.E.Co.) Carrier Telegraph	1025, 1028
Frequency Meter Set, I-129, SCR-211	1317, 1318
Frequency Range Chart, Tactical Ground Radio Sets	1405, 1409
Fuses, Telephone Line	803
FX-1, -A and -B Facsimile Transceiver	1105

G

Generator Sets, Engine Driven	1202
Arranged by Capacity	1208, 1211
Fixed Plant	1205, 1210-1212
Tactical	1203, 1207-1209
Groundman's Equipment, TG-23	1311, 1312
Ground Rods:
Outside Plant	609, 624
Radio	1440
Telegraph	1009, 1010
Ground System for Radio Towers	1445

H

	<u>Paragraph</u>
Hallcrafters Radio Receivers	1427, 1430
Hammarlund Radio Receivers (Super Pro)	1427, 1430
Handsets	313
Hardware, Pole	606-609, 616, 624
Head and Chest Sets	311
Headsets	310
Heat Coils	804
HS-- Headsets	310
HS-- Head and Chest Sets	311

I

I-23 to I-236 Test Sets	1317, 1318
IE-9 to IE-75 Test Equipment	1314, 1315
Illustrative Problems:	
Interconnection of Tactical and Fixed Plant Telegraph Equipment	215-217
Open Wire Carrier System, Tactical	209-211
Open Wire Communication System, Fixed Plant	212-214
Radio Relay Carrier Communication System	206-208
Spiral-Four System	203-205
Switchboard, Multiple Fixed Plant - Ordering	218-221
IN- Insulators	606-609, 1440
Information Centers, AWS	501-504
Installation Equipments, ME-58 and ME-60	1308, 1309
Instruction Books:	
Aircraft Accessories Corp. 500B Transmitting Equipment	1426
AN/CRC-3 and 3A	1408
AN/GRR-2 (National NC-100-ASC)	1427
AN/GRR-3 (Hallcrafters SX-28)	1427
AN-08-40 Control Set SCR-572-A	503
BC-339 Transmitting Equipment	1422
Bunnell 6 KW Radio Amplifier	1422
Federal 128-AY Radio Receiver	1427
General Electric Co. Rectifiers	1214
Hallcrafters Radio Receivers	1427, 1430
Hammarlund Radio Receivers	1427, 1430
HO-17 Shelter	1408
Lorain Instruction Form No. 130	1217
Motorola FMTR-25 VM & 50 BW	1428
National Radio Receivers	1427
Onan WSM-13	1212
PE-78 to PE-236	1212
Press Wireless PW-15-(.)	1422
PU-19/FRC Power Unit	1212
Recordgraph Commando (Amertype Recordgraph Co.)	432, 433
SCR-209	1408
SCR-293, 294, 298 and 694AW	1408
Shuttig Diversity Mixing Unit	1423
10 KW Transmitting Equipment	1422
W.E.Co. D-99945 Radio Receiver	1423
W.E.Co. D-156000 2 KW Transmitter	1422
Wilcox CW3 & F3 Radio Receivers	1427
X-61652 W.E.Co. Instr. Book, Portable Information Center	503
X-61684 W.E.Co. Instr. Book, Portable Filter Center	503
X-61757 W.E.Co. Instr. Book, 42B1 Carrier Telegraph Equipment	1025
X-61759 W.E.Co. Instr. Book, Single-sideband Carrier Telegraph	1025
X-61778 W.E.Co. Instr. Book, Test Set I-181	1317
X-61796 W.E.Co. Instr. Book, Test Set I-49	1317
X-61806 W.E.Co. Instr. Book, 67B Test Set	917, 1317
X-63634 W.E.Co. Instr. Book, Test Set I-193-A	1317
X-63641 W.E.Co. Instr. Book, VF Ringer Package	917, 918
X-63653 W.E.Co. Instr. Book, VF Carrier Telegraph Package	1025

I (Cont'd.)

	<u>Paragraph</u>
X-66038 W.E.Co. Instr. Book, DC Telegraph Repeater Package	1024
X-66039 W.E.Co. Instr. Book, DC Regenerative Repeater Package	1024
X-66147 W.E.Co. Instr. Book, VF Carrier Telegraph Package	1025
X-66150 W.E.Co. Instr. Book, Line Terminating and Composite Package	917, 919
X-66152 W.E.Co. Instr. Book, 133A1 Teletypewriter Tables, etc.	1027
X-66154 W.E.Co. Instr. Book, 132A2 Teletypewriter Subscriber Set, etc.	1027
X-66157 W.E.Co. Instr. Book, Vacuum Tube Tester, Hickok	1317
X-66208 W.E.Co. Instr. Book, Toll Line Observing Equipment	432
X-66209 W.E.Co. Instr. Book, Multi-Line Observing Equipment	432
X-66226 W.E.Co. Instr. Book, 32A Transmission Measuring Set	1317
X-66227 W.E.Co. Instr. Book, 51A Oscillator	1317
X-66228 W.E.Co. Instr. Book, "C" Carrier Telephone Package	919
X-66229 W.E.Co. Instr. Book, "C" Carrier Telephone Package	919
X-66230 W.E.Co. Instr. Book, VF Telephone Repeater Package	917
X-66231 W.E.Co. Instr. Book, VF Telephone Repeater Package	917
X-66232 W.E.Co. Instr. Book, 19C Oscillator	1317
X-66233 W.E.Co. Instr. Book, 13A Transmission Measuring Set	1317
X-66234 W.E.Co. Instr. Book, 5A Attenuator	1317
X-66247 W.E.Co. Instr. Book, Line Terminating and Simplex Package	917
X-66251 W.E.Co. Instr. Book, Mobile Toll Test Unit, Packaged	429
X-66259 W.E.Co. Instr. Book, Test and Control Board Package	429
X-66260 W.E.Co. Instr. Book, Volt-Ohm-Milliammeter & Volt-Ohmmeter	917, 1317
X-66307 W.E.Co. Instr. Book, Tools for Packaged Equipment	1311
X-66329 W.E.Co. Instr. Book, 5 Line Observing Cabinet	432
X-66330 W.E.Co. Instr. Book, Repeater and Control Unit for 132A2 Tty. Set	1027
X-66355 W.E.Co. Instr. Book, Two-Channel Start-Stop Transmitter-Distributor	1027
X-66413 W.E.Co. Instr. Book, Tool Equipment TK-123	1311
X-66464 W.E.Co. Instr. Book, Vacuum Tube Tester, Hickok (I-171)	1317
X-66520 W.E.Co. Instr. Book, Telegraph Switchboard SB-6/GG	1024
X-66578 W.E.Co. Instr. Book, Single-sideband Carrier Telegraph	1025
X-66616 W.E.Co. Instr. Book, Telegraph Terminal CF-6-() (Carrier)	1007
Instruction Manuals (Teletype Corp.)	1008, 1026, 1317
Instruments, Test	1317, 1318
Insulators	606-609, 1440
International Telephone Cable Loading Systems	702-707
Interrupters	1217, 1218

J

Jefferson-Travis 350A Radio Set	1428, 1431
---	------------

K

K-36, 37 Trailers	636
K-38 Trailer	636, 638
K-43 and 44-B Trucks	636
K-55 Trailer	503
Kellogg Switchboards	418-427
Kohler 1M21A Engine Generator Set	1210-1212

L

	<u>Paragraph</u>
LC-1 to LC-65 Line Construction Tools and Equipment	635, 637-640
LC-61 Plow	635
Lead-covered Cables	619
Construction Time	629
Splicers Tool Equipment	636
Splicing Materials	627
Transmission Data	623
VF Loading Equipment	620
Lead Sleeves	625, 626
Line Relays, Telegraph	1026
Line Unit, BE-77	1006, 1010, 1320
Lineman's Equipment, TE-21	637, 1311, 1312
Link (Fred M.) Radio Sets	1428, 1431
Loading Equipment, VF, for Lead-covered Cables	620-622
Loading, Storm	603
Loading Systems:	
CCIF Standard	706, 707
European and International	702-707
United States	708-710
Loop Lengths for Various Switchboard Limits	409
Loudspeakers	316, 317
LS-1 to LS-11	317

M

M409 ASF Manual - Logistical Planning and Reference Data	103
M-222 Converter	1217, 1218
Maintenance Cross Reference Table	1320
Maintenance Equipments and Kits	1306, 1308, 1309
Maintenance Parts - Supply Plan	1303
Maintenance Supply	1301
Maintenance System	1302
Masts, Radio Antenna (Also see "Towers").	1436-1439
MC-549	1433d
ME-4 to ME-114 Maintenance Equipments and Kits	1308, 1309
Messenger, Wire - Stock Numbers and Physical Data	604
Meters, Test	1317, 1318
Microphones (Telephone Transmitters)	302-305
Military Characteristic Range	1408
MK- Maintenance Equipments	1308, 1309
Mobile Operations Center, AWS	503, 504
Models 15 and 19 (Teletype Corp.) Teletypewriter Sets	1026, 1028
Monitoring Facilities, Telephone	405, 431-433
Motorola Radio Sets	1428, 1431
MS-18 to MS-118 Mast Sections	1436-1439
Multimeter	1317, 1318
MX-141/TRC-1	1433e

N

National Radio Receivers	1427, 1430
Neutral Line Transmission, Telegraph	1012
North Electric Switchboard	423-427

O

	<u>Paragraph</u>
O-5/YR, Oscillator Exciter (Press Wireless FSL2A)	1027, 1028
Observing Facilities, Telephone	405, 431-433
Onan W3M-13 Engine Generator Set	1210-1212
132A1, 133A1, 133A2 (W.E.Co.) Teletypewriter Sets	1027, 1028
Open Wire Lines:	
Construction Time	629
Fixed Plant - Materials for Construction	609
Shipping Data	610
Tactical - Materials for Construction	606-608
Stock Nos. and Physical Data	604
Transmission Data	605
Open Wire Line System Comparisons	224-229
Operations Center, AWS	503, 504
Oscillators, Test	1317, 1318
Oscillator Exciter, O-5/YR	1027, 1028
Outside Plant Construction Time	629

P

P-11 to P-23 Headsets	310
PA-8098 (Part of AN/CRC-3) Radio Receiver	1408
PA-8212 (Part of AN/CRC-3) Transmitter	1408
PA-8244 (Part of AN/CRC-3A) Transmitter	1408
PA-8245 (Part of AN/CRC-3A) Radio Receiver	1408
Packaged Telegraph Equipment	1024, 1025, 1028-1030
Packaged Telephone Equipment:	
Cabinets, Apparatus	920
Carrier, C and H	919
Ringers	918
Selection of	922-925
Stock Nos. and Logistical Data	921
Tool and Test Equipment	1311-1318
Voice Frequency - Description	917
Pan American Airways:	
4WTFA	1426, 1429
12-ACX-2 Transmitter	1426, 1429
12-GLX-2 Transmitter	1426, 1429
RFA-50 Amplifier	1426, 1429
PE-43- () to PE-236 Engine Generator Set	1207-1212
Perforators	1008, 1010, 1320
PF- , Pole Fixtures (Includes Hardware)	606-609, 616, 624
Photographs	102b
Plow, Cable, LC-61	635
Polarential Line Transmission (Telegraph)	1014
Pole Derrick (LM) on Truck K-43	636, 1320
Poles, Telephone	631-633
Portable Filter Center, AWS	503, 504
Power Amplifier, BC-340	1426, 1429
Power Distribution Data	1230-1232
Power Equipment	1201
Power Equipment Co. PEC-161, Rectifier	1214, 1215
Power Ringing Units	1216, 1218
Power Services, Commercial	1228-1232
Power Supply Units (PE--)	1207-1212
Press Wireless Co. Radio Transmitting Equipment	1422, 1424, 1426, 1429, 1430
Problems (see: "Illustrative Problems")	
Protection: Cable	806-810
Main Frame	811, 812
Switchboard	806, 807
Telephone	805-807
Protector Blocks	802
PU-19/FRC Engine Generator Set	1210, 1212
PU-8/TTQ-1 Engine Generator Set	1207-1209

Q

	<u>Paragraph</u>
Quadded Cable Loading Units	709

R

R-2 to R-30 Receivers, Telephone	307, 308
RA-36 to RA-91 Rectifiers	1214, 1215
Radiators (Antennas).	1438, 1439, 1443
Radio Equipment	1401
Combined Transmitting and Receiving	1428
Fixed Plant	1417-1431
Aircraft Accessories Corp.	1426, 1429
Army Airways Communication Service	1420, 1426-1431
Bunnell, J. H. Co.	1422, 1424
Collins Radio Co.	1426, 1428, 1429, 1431
Command	1418, 1422-1425
Federal Telephone and Radio Corp.	1426, 1427, 1429, 1430
Hallicrafters, Inc.	1427, 1430
Hammarlund Mfg. Co. Inc.	1427, 1430
Jefferson-Travis Radio Electric Corp	1428, 1431
Link (Fred M.) Co.	1428, 1431
Motorola (Galvin Mfg. Co.)	1428, 1431
National Co., Inc.	1427, 1430
Pan American Airways, Inc.	1426, 1429
Press Wireless, Inc.	1422, 1424, 1426, 1429, 1430
Radio Teletype Terminal, AN/FCC-1	1027, 1028
Shuttig & Co.	1423, 1425
Single-sideband	1422-1425
Temco	1426, 1429
10 KW Transmitting Equipment	1022, 1024
Western Electric Co.	1422-1426, 1429
Wilcox Electric Co.	1426, 1427, 1429, 1430
Maintenance Equipment	1308, 1309, 1408
Maintenance, Tool and Test, Cross Reference Table	1320
Photographs	1402
Receivers and Receiving Equipment	1408, 1423, 1425, 1427, 1428, 1430, 1431
Sets:	
Air Transportable	1413
Ground, Mobile	1414
Ground, Transportable	1410
Pack	1412
Remote Control Equipment	1415, 1416
Tactical	1404, 1408-1416
Vehicular	1411
Test Sets	1517, 1518
Tool and Test Equipments	1311, 1312, 1314, 1315
Transmitters and Transmitting Equipment	1408, 1422, 1424, 1426, 1428, 1429, 1431
Radio Frequency Range Chart	1405, 1409
Radio Relay Carrier Communication System:	
Comparison with Wire Systems	223-226
Illustrative Equipment Problem	206-208
Radio Teletype Terminal - Diagram	1031, 1032
Range, Military Characteristic	1408
RC-47, 261, 289, 290 Remote Control Equipment	1415, 1416
RC-52 Transmitting Equipment	1426, 1429
RC-58, 120 Facsimile Equipment	1102-1106
RC-63, 291, 293 Antenna Equipment	1433
RC-256, 257 Radio Sets	1406, 1410
Receivers, Telephone	302, 306-308, 310
Receiving Equipment, Radio	1408, 1423, 1425, 1427, 1428, 1430, 1431
Recording Facilities, Telephone	405, 431-433
Rectifiers (RA-).	1213-1215
Reel Units (RL--).	635, 1320
Regenerative Repeater	1024, 1028

R (Cont'd.)

	<u>Paragraph</u>
Reliable Electric Co. Protective Equipment	802, 803, 805, 808
Remote Control Equipment	1407, 1415, 1416
Repair Parts Kits, ME-111 to ME-114	1308, 1309
Repeater:	
Sets TC-	909, 910, 1009, 1011, 1320
Telegraph, DC	1006, 1009-1011, 1320
Telegraph, Regenerative	1024, 1028, 1320
Telephone, Carrier	908-910, 919, 921, 1320
Telephone Packaged	917, 919, 921, 1320
Telephone, VF	906, 910, 921, 1320
Reperforators	1008-1010, 1320
RG-5/U to RG-59/U Coaxial Cable RF Transmission Lines	1435
Ringer Set, TC-24	909, 910, 1320
Ringin Equipment, Telephone, Package	918, 1320
Ringin Equipment, Telephone, VF	907, 910, 918, 921, 1320
Ringin Units, Power	1216-1218
RL-16 to RL-45 Reel Carts, Units, Axles, etc.	635
RM-7 to RM-29 Remote Control Units	1415, 1416
Rubber Insulated Cables:	
Construction Time	629
Transmission Data	615
Vulcanizing Equipment	639
Rubber Insulated Wires	615
RY-30 (Teletype Corp) Line Relay	1026

S

S + DK (TH-1/TCC-1) Telegraph Terminal	1025, 1028
SB-5-()/PT Telephone Switchboard	410-414
SB-6-()/GG Telegraph Switchboard	1024, 1028
SB 11-6 Supply Bulletin, ASF	1220, 1225, 1226
SCR-131 to SCR-828 Tactical Radio Sets	1408, 1410-1414
SCR-211 Frequency Meter Set	1317, 1318
SCR-281 Radio Transmitter	1422, 1424
SCR-572-A Control Set	503, 504
SCS-3 Control Net System	502
SCS-5 Information Center System	503, 504, 1320
Shuttig Diversity Radio Receiver Mixing Unit	1423, 1425
SIG 1 to SIG 10	1305
Signal Generators, I-72, etc.	1317, 1318
Signal Supply Catalog	1304, 1305
Simplex Coil	906, 910
Simplex Equipment	917, 921
Single-Sideband, VF Carrier Telegraph	1025, 1422-1425
Sleeves	625, 626
Soldering Equipment, TE-26	1311, 1312
Spare Parts Kit, MK-11/TRA-1	1308, 1309
Speech Plus Duplex (TH-1/TCC-1)	1025, 1028
Spiral-Four Cable Lines:	
Construction Time	629
Materials for Construction	616
Messenger	612
Shipping Data	614, 617
Transmission Data	615
Spiral-Four Equipment (see "Telephone Line Transmission Equipment" and "Telegraph Equipment")
Spiral Four System:	
Comparison with Radio and Open Wire	223-228
Illustrative Problem	203-205
Splicers' Tool Equipment for Lead-covered Cable	638
Splicing Materials for Lead-covered Cable	625-627
Station Line Lengths for Various Switchboard Limits	409
Stromberg-Carlson Switchboards	418-427

S (Cont'd.)

	<u>Paragraph</u>
Subcycle Ringer, Model S (Lorain Products Corp.)	1217, 1218
Submarine Cables	641-643, 711-718
Baltic and North Seas	712, 714
British Isles	712, 713, 715, 716
Pacific Ocean	715
Telegraph	717
Types	712, 715
Super Pro Radio Receiver (Hansarlund)	1427, 1430
Supply Catalog, Signal	1304, 1305
Supply Plan for Maintenance Parts	1303
Survey Tools and Materials	640
Switchboard, Multiple, Fixed Plant Illustrative Equipment	218-221
Problem	218-221
Switchboards, Telegraph	1024, 1028
Fixed Plant	1006, 1010
Tactical
Switchboards, Telephone:
Common Battery and Magneto, Combined	408, 410
Description	411, 419, 424
Equipment Data	410, 418, 423
Fixed Plant	415-427
General	401-405
Limits vs Station Line Lengths	409
Magneto	407, 410
Multiple Position	417, 423-427
Protection	806, 807, 811, 812
Single Position	416, 418-422
Stock Numbers and Logistical Data	414, 422, 427
Tactical	406-414
Tool, Test and Maintenance Equipment	1320
Transmission Losses	413, 421, 426
Working Limits	403, 409, 412, 420, 425
System Comparisons, Radio and Wire	222-229

T

T-4/FRC, T-5/FRC	1426, 1429
T-17 to T-50 Microphones	304, 305
TA-3/FT Ringer Package, Telephone, VF	918, 921
TB SIG 3 Technical Bulletin, Wire W-143	614
TB SIG 6 Technical Bulletin, Dry Battery Life	1220
TB SIG 14 Technical Bulletin, Dry Battery Testing	1220
TB SIG 61 Technical Bulletin, U-4/GT	406
TB SIG 67 Technical Bulletin, Field Cables Under Water	641
TB 11-360-1 Technical Bulletin, RL-26	635
TB 11-362-2 Technical Bulletin, RL-31	635
TC- Telephone Central Office Sets	410, 414
TC-3 Telegraph Central Office Set	1009, 1011
TC-16, 17 Reperator Teletypewriter Sets.	1009, 1011
TC-18, 19 Repeater Sets, Telegraph.	1009, 1011
TC-21 Telephone Terminal Set	909, 910
TC-22 Telegraph Terminal Set, Carrier	1009, 1011
TC-23, 29, 37 Repeater Sets, Telephone.	909, 910
TC-24 Ringer Set	909, 910
TC-33 Converter Set	909, 910
TC-15 Filter Center	503, 504
TD-1 to TD-5 Chest Sets	312
TE-5 to TE-124 Tool Equipment	1311, 1312
Technical Manuals (see "TM")
Engineering References	104
Requisitioning	103
Telegraph Circuits, DC Loop Connections of CF-2-B - Diagrams	1018, 1019
Telegraph Circuits, Interconnection of Fixed Plant and Tactical Equipment	215-217

T (Cont'd.)

	<u>Paragraph</u>
Telegraph Equipment:	
Carrier	1007, 1010, 1025, 1028
DC, Wire	1006, 1010, 1024
Fixed Plant	1024-1028
Packaged	1024, 1025, 1028
Repeaters	1006, 1010, 1011, 1024, 1028
Single-Sideband	1025, 1422-1425
Switchboards	1006, 1010, 1024, 1028
Tactical	1006, 1010
Terminal, TH-1/TCC-1 (S + DX)	1025
Tool, Test and Maintenance Equipments	1308-1320
Voice Frequency	1025, 1028
Telegraph Sets	1006, 1010, 1011
Telephone	314, 315, 906, 910
Telephone Centrals	401
Telephone Central Office Sets	410-414, 909-913, 1320
Telephone Line Transmission Equipment:	
Carrier - Description	908, 919
Summary of Equipment for Carrier Systems	911-913
Repeaters	906, 910
Requirements per Circuit	923
Requirements per Office	924
Selection of Equipment	922-925
Sets	909, 910
Stock Numbers	910, 921
Tool, Test and Maintenance Equipments	1308-1318, 1320
Use of Equipment	925
Voice Frequency - Description	906, 917
Telephone Sets	309-313, 909
Telephone Station Equipment	301
Telephone Switchboards (see "Switchboards, Telephone")	
Telephone System Comparisons, Radio vs Wire	222-229
Telering	1217, 1218
Teletypewriter Circuits, Tactical, Typical Layouts	1012-1019
Teletypewriter Equipment:	
Fixed Plant	1026-1028
Tactical	1008, 1010
Tool, Test and Maintenance Equipment	1308-1320
Teletypewriter Sets	1009, 1011, 1026-1028
Teletypewriter Supplies	1034
Teletypewriter Switching Network - Diagram	1016, 1017
Temco Radio Transmitting Equipment	1426, 1429
10 KW Transmitting Equipment	1422, 1424
Terminal: Radioteletype	1027, 1028
Telegraph	1007, 1009-1011, 1025, 1028
Telephone	908-910, 917, 919, 921
Terminal Protection	806-810
Test Cabinets and Boards, Telephone Central Office	428-430
Test Equipments & Packages	1314, 1315
Test Equipment Cross Reference Table	1320
Test Meter, I-87	1317, 1318
Test Oscillators	1317, 1318
Test Sets	430, 1316-1318
Test Unit, I-135, etc.	1317, 1318
TG-5 Telegraph Set	1006, 1010
TG-7, 37 Teletypewriters	1008, 1010
TG-11, 23 Perforators	1008, 1010
TG-25, 26, 27 Reperforators	1008, 1010
TG-30, 31 Telegraph Repeaters	1006, 1010
TH-1/TCC-1 Telegraph Terminal (S + DX)	1025, 1028
Time, Construction, Outside Plant	629
TM 9-2800 Standard Military Motor Vehicles	636
TM 10-1202 Truck, 1-1/2 Ton Chevrolet, 4 X 4 (LC), Parts List	636
TM 10-1203 Truck, 1-1/2 Ton, 4 X 4, Maintenance Manual	636
TM 10-1414 Truck, Telephone Body or Earthborer, 1-1/2 Ton, 4 X 4	636
TM 11-230 Radio Set SCR-694	1408
TM 11-231 Radio Sets SCR-178 and SCR-179	1408
TM 11-232 Radio Set SCR-177-B	1408

T (Cont'd.)

	<u>Paragraph</u>	
TM 11-233	Radio Set SCR-188-A	1408, 1415
TM 11-235	Radio Sets SCR-536-A, -B, -C	1408
TM 11-237	Radio Sets SCR-131 and SCR-161	1408
TM 11-238	Radio Sets SCR-194 and SCR-195	1408
TM 11-239	Radio Set SCR-203	1408
TM 11-241	Radio Sets SCR-197-B, -C, -D, -E, -F	1408, 1415
TM 11-242	Radio Set SCR-300-A	1408
TM 11-244	Radio Set SCR-281-D	1422
TM 11-245	Radio Set SCR-511-A	1408
TM 11-250	Radio Set SCR-288	1408
TM 11-272	Radio Set SCR-210 and SCR-245	1408
TM 11-273	Radio Set SCR-193	1408
TM 11-275	Radio Set SCR-284-A	1408
TM 11-277	Radio Set AN/VRC-1	1408
TM 11-280	Radio Set SCR-299-A, -B, -C, -D	1408
TM 11-281	Radio Sets SCR-399-A and SCR-499-A	1408
TM 11-300	Frequency Meter Sets SCR-211-A, -B, -C	1317, 1408
TM 11-302H	Charging Set SCR-169 (PE-HH-43)	1207
TM 11-302K	Charging Set SCR-169 (PE-43-HK)	1207
TM 11-303	Test Sets I-56-C, -D, -H, -J	1317
TM 11-304	Frequency Meter Sets I-129-A, -B	1317
TM 11-306C	Maintenance Equipment ME-13-C	1308
TM 11-306D	Maintenance Equipment ME-13-D	1317
TM 11-307	Signal Generator I-72-G, -H	1317
TM 11-308	Remote Control Unit RM-29-()	1408, 1415
TM 11-311	Test Equipment IE-17-E	1314, 1317
TM 11-312	Remote Control Equipment RC-47-(), RM-12-() & RM-13-()	1415
TM 11-315	Maintenance Equipment ME-40 & ME-53	1308
TM 11-316	Alignment Indicator, I-210	1317
TM 11-317	Signal Generator, I-208	1314, 1317
TM 11-318	Alignment Equipment ME-73	1308
TM 11-321	Test Set I-56-E	1317
TM 11-330	Switchboards BD-71, -72, -72-A, and -72-B	410
TM 11-331	Switchboard BD-14	410
TM 11-332	Telephone Central Office Set TC-4	410
TM 11-333	Telephones EE-8-A and EE-8	314, 1408, 1415
TM 11-335	Telephone Central Office Set TC-1	410
TM 11-336	Telephone Central Office Set TC-12	410
TM 11-338	Telephone Central Office Set TC-10	410, 1214
TM 11-340	Telephone Central Office Set TC-2	410
TM 11-341	Telephone Terminal CF-1-A and Repeater CF-3-A	908
TM 11-342	Ringin Equipments EE-101-T1, EE-100-A & EE-101-A	907
TM 11-344	Converter M-222	1217
TM 11-345	Cabinet BE-70 (Wire Chiefs Testing)	429
TM 11-346	Test Sets I-61-A, -B, -C	1317
TM 11-348	Telephone Repeater Set TC-29-A	906
TM 11-349	Maintenance Equipment ME-22	1308
TM 11-351	Telegraph Sets TG-5 and TG-5-A	1006
TM 11-352	Printers TG-7-A, -B & TG-37-B	1008
TM 11-353	Telegraph Printer Equipment, Install. and Maint.	1008, 1026
TM 11-354	Telegraph Printer Sets EE-97, -A, EE-98, -A, & EE-102	1006
TM 11-355	Telegraph Terminal CF-2-A (Carrier)	1007
TM 11-355B	Telegraph Terminal CF-2-B (Carrier)	1007
TM 11-356	Radio Teletype Terminal Eqpt. AN/FGC-1 & AN/FGC-1X	1027
TM 11-357	Reperforator Transmitter TG-26	1008
TM 11-358	Telegraph Central Office Set TC-3	1006, 1214
TM 11-359	Line Unit BE-77, -A	1006
TM 11-360	Reel Units RL-26, -A	635
TM 11-361	Test Sets EE-65-A through -F	1314, 1317
TM 11-362	Reel Unit RL-31	635
TM 11-363	Pole Line Construction	618
TM 11-364	Truck K-44-B & Earth Borer Equipment HD	636
TM 11-366	Vulcanizing Equipments TE-54-A & TE-55-A	614
TM 11-368	Tactical Open-Wire Pole Line Construction	603, 606-608, 635, 636
TM 11-369	Spiral-Four Cable	612, 614, 616, 617, 635
TM 11-370	Plow LC-61 (Cable)	635

T (Cont'd.)

	<u>Paragraph</u>
TM 11-371 Cable Assemblies CC-345 (5 pair) & CC-355-A (10 pair)	614
TM 11-374 Tape Facsimile Equipment RC-58-B	1105
TM 11-375B Facsimile Equipment RC-120, -A, -B, & AN/TXC-1	1105
TM 11-377 Boehme Automatic Keying and Recording Equipment	1026
TM 11-379 Test Set I-51	1317
TM 11-430 Storage Batteries	1219
TM 11-438 Operations Center AN/TTQ-1	503
TM 11-457 Local Battery Telephone Equipment	315
TM 11-458 Common Battery Telephone Equipment	315
TM 11-486 Electrical Communication Systems Engineering	103
TM 11-600 Radio Sets SCR-508, SCR-528 & SCR-538	1408
TM 11-601 Radio Sets SCR-808 & SCR-828	1408
TM 11-605 Radio Sets SCR-509-A & SCR-510-A	1408
TM 11-609 Radio Set SCR-298	1408
TM 11-615 Radio Sets SCR-609-A & SCR-610-A	1408
TM 11-615A Radio Sets SCR-609-A & SCR-610-A	1408
TM 11-620 Radio Sets SCR-608-A & SCR-628-A	1408
TM 11-625 Radio Set SCR-543-A	1408, 1415
TM 11-630 Radio Set SCR-506-A	1408
TM 11-800 Radio Transmitters BC-191-A to -E and AA	1408
TM 11-805 Radio Set SCR-197-C, -D, -F, Transmitting Parts	1408, 1415
TM 11-813 Radio Transmitter BC-610-E	1426
TM 11-820 Radio Transmitter T-4/FRC	1426
TM 11-823 Radio Transmitter-Receiver Type 1505	1428
TM 11-825 Portable Radio Broadcast Transmitter TWT-PB50A	1422
TM 11-827 Transmitting Equipment BC-447	1422
TM 11-828 Transmitting Equipment BC-365	1422, 1426
TM 11-834 Radio Transmitter PW-981-()	1422
TM 11-850 Radio Receiver BC-312-(), BC-314-(), BC-342-(), BC-344-()	1408
TM 11-859 Radio Set SCR-593-A	1408
TM 11-866 Radio Receivers BC-779-B, BC-794-B, BC-1004-C	1423
TM 11-872 Radio Teletype Receiving Equipment AN/FRR-3	1423
TM 11-900 Power Units PE-75-G through T	1207, 1408
TM 11-903 Power Unit PE-77-()	1207
TM 11-904 Power Units PE-95-A, -B, -C	1207, 1210, 1408
TM 11-904H Power Units PE-95-G and H	1207
TM 11-911 Power Units PE-78-G and -H	1210
TM 11-912F Power Unit PE-79-F	1210
TM 11-913 Power Unit PE-214-A	1207
TM 11-916 Power Unit PE-85	1210
TM 11-916M Power Unit PE-85-M	1210
TM 11-920 Power Unit PE-49-F	1207
TM 11-923 Power Unit PE-99-A through -G	1207
TM 11-927 Power Unit PE-108-A through -E	1207
TM 11-932 Power Unit PU-8/TTQ-1	503, 1207
TM 11-935 1-1/2 KVA Kohler Power Unit Model LM21-A	1210
TM 11-940 Power Unit PE-197	1207
TM 11-941 Power Unit PE-215	1207, 1210
TM 11-942D Power Unit PE-142-D	1210
TM 11-942E Power Unit PE-142-E	1210
TM 11-946 Power Unit PE-167	1210
TM 11-951 Rectifier RA-36-J, -K, -L	1214
TM 11-951Q Rectifier RA-36-K, -Q & 6RB6B17	1214
TM 11-954 Rectifier RA-43	1214
TM 11-955 Rectifier RA-37	1214
TM 11-957 Rectifier RA-57	1214
TM 11-963 Rectifier RA-83-A	1214
TM 11-1041 Test Set I-76	1317
TM 11-2001 100-Mile Spiral-Four Carrier System	614
TM 11-2003 Carrier Hybrid CF-7	908
TM 11-2004 Repeater Set TC-18	1006
TM 11-2005 Repeater Set TC-19	1006
TM 11-2006 Telephone Repeater KE-89-A	906
TM 11-2008 Converter Set TC-33 & Repeater Set TC-37	908
TM 11-2011 Ringer Equipment KE-101-B	918
TM 11-2014 Telephone Unit KE-105	908
TM 11-2016 Switchboard SB-5()/PT	410

T (Cont'd.)

	<u>Paragraph</u>
TM 11-2017 Test Set TS-26/TSM	1317
TM 11-2019 Test Set I-49	1317
TM 11-2020 Line Terminating and Simplex Package	917
TM 11-2021 VF Ringer Package	917, 918
TM 11-2022 Packaged Equipment on Open Wire Lines	103, 914, 1001
TM 11-2023 C Carrier Telephone Package	919
TM 11-2024 VF Carrier Telegraph Package	1025
TM 11-2025 H Carrier Telephone Package	919
TM 11-2026 C Carrier Telephone Package	919
TM 11-2027 VF Telephone Repeater Package	917
TM 11-2028 VF Telephone Repeater Package	917
TM 11-2029 VF Carrier Telegraph Package	1025
TM 11-2030 Test and Control Board Package	429
TM 11-2031 Line Terminating and Composite Package	917, 919
TM 11-2032 DC Regenerative Repeater Package	1024
TM 11-2033 Mobile Toll Test Unit Package	429
TM 11-2034 DC Telegraph Repeater Package	1024
TM 11-2035 Telegraph Switchboard SB-6()/CG	1024
TM 11-2036 Test Set I-181	1317
TM 11-2037 Fixed Plant Telephone and Telegraph	1024, 1025
TM 11-2038 H Carrier Telephone Package	919
TM 11-2039 19C Oscillator	1317
TM 11-2040 51A Oscillator	1317
TM 11-2042 Volt-Ohm-Ammeter and Voltohmmeter	917, 1317
TM 11-2043 Sound Powered Telephone TP-3	315
TM 11-2044 5A Attenuator	1317
TM 11-2045 13A Transmission Measuring Set	1317
TM 11-2046 67B Test Set (TS-190/U)	917
TM 11-2047 Vacuum Tube Tester - Hickok	1317
TM 11-2048 32A Transmission Measuring Set	1317
TM 11-2058 Test Set TS-27/TSM	1317
TM 11-2059 Telephone TP-9	906
TM 11-2200 Bias Meter I-97-A	1317
TM 11-2201 Reperforator Teletypewriter Sets TC-16 & TC-17	1008
TM 11-2203 Telegraph Terminal Set AN/TCC-1	1026
TM 11-2205 Oscillator Exciter O-5/FR	1027
TM 11-2206 Telegraph Terminal TH-1/TCC-1	1025
TM 11-2207 Radio Teletype Code Room & Signal Center	1021
TM 11-2208 Test Set TS-2/TG	1317
TM 11-2210 Teletypewriter Set 132A2	1027
TM 11-2211 Teletypewriter Set 133A1	1027
TM 11-2214 Teletypewriter Set 133A2	1027
TM 11-2250 Reel Equipment CE-11	635
TM 11-2252 Converter CV-2/TX	1105
TM 11-2253 Open-Wire Construction for Fixed Plant	609
TM 11-2506 Test Sets I-83-A to -K	1317
TM 11-2513 Test Set I-193-A	1314, 1317
TM 11-2601 Radio Set AN/TRC-1, -3, -4	1408
TM 11-2603 Amplifier AN/TRA-2	1408
TM 11-2604 Test Set I-199	1317
TM 11-2613 Voltohmmeter I-166	1317
TM 11-2627 Tube Tester I-177	1317
T.O. (Technical Order) Army Air Forces
T.O. AN-08-10-185 Radio Set SCR-624-A	1408
T.O. AN-08-10-227 Radio Equip RC-256 & RC-257	1408
T.O. AN-08-40, Control Set SCR-572-2	503
Tool and Test Equipment Package	1311-1318
Tool Equipment	1310-1312
Tool Equipment, Cable Splicers	638
Tool Equipment, Line Construction	637
Tool Equipment, Vulcanizing	639
Tool Set Cross Reference Table	1320
Tool Sets	1311, 1312
Tools and Materials, Line Survey	640
Tower, Antenna	1443-1445
Tower Lighting Equipment	1446

T (Cont'd.)

	<u>Paragraph</u>
TF-3 and 6 Telephones	315
TP-9 Telephone	906, 910
TR (Technical Regulation) 1210-31 (SCR-171)	1408
Trailers	636
Transmission Data:	
Cables, Lead-covered	623
Cables, Rubber-covered	615
Open Wire Lines	605
Wires, Rubber-covered	615
Transmission Lines, Coaxial Cable	1435
Transmission Measuring Sets	1317, 1318
Transmitter-Distributor, XD-91	1027, 1028, 1032
Transmitters, Radio	1408, 1422, 1424, 1426, 1428, 1429, 1431
Transmitting Equipment, Radio, AACS	1426, 1428, 1429, 1431
Trucks	636, 1320
TS-2/TG Test Set	1317, 1318
TS-9 to TS-15 Handsets	304, 307, 308, 313
TS-26/TSM, 27/TSM Test Sets	1317, 1318
TS-32/TRC-1	1317, 1318
TS-190/U	1317, 1318
TU-6 to TU-25 Tuning Units	1408
TU-3-A to TU-10-A Tuning Units	1408
TU-AA-5 to TU-AA-10 Tuning Units	1408
Tube Testers, I-171 etc.	1317, 1318
Tuning Forks, TTY Motor Adjusting	1317, 1318
Two-Path Polar Line Transmission (Telegraph)	1014
255A (W.E.Co.) Line Relay	1026

U

U-4/GT Adapter Plug	406
United States Loading Systems	708-710

V

Voice Frequency Telegraph	1025, 1028
Voice Frequency Telephone Equipment	917-921
Repeaters	906, 917
Ringing Equipment	907, 918
Stock Numbers and Logistical Data	910, 921
Voltmeters, I-23, I-50	1317, 1318
Voltammeter, I-107, I-166	1317, 1318
Volt-ohm-milliammeter	1317, 1318
Vulcanizing Equipment, TE-55	639, 1311, 1312

W

W-28, 29, 30, 120, 128, 140, 146, 148 Wire, Antenna Equipment	1434
W-50, 108, 110, 130, 143 Wire, covered	614, 615
W-74, 75, 76, 90, 115, 116, 145, 153, 503 Wire, bare	604, 605
War Department Publications	104
WC-321 to WC-339 Submarine Cable	643
WC-548 Cable, Rubber-covered	615
WD-3/TF Assault Wire	614, 615
W.E.Co. D-99945 Radio Receiver	1423, 1425
W.E.Co. D-151249 Transmitting Equipment	1422, 1424, 1426, 1429
W.E.Co. Interrupters	1217, 1218
W.E.Co. Protective Equipment	802-812

W (Cont'd.)

	<u>Paragraph</u>
W.E.Co. Switchboards, Telephone	418-427
W.E.Co. X-Specification (see X-)
Wilcox Electric Co. Radio Equipment	1426, 1427, 1429, 1430
Windcharger	1443
Wire, Antenna	1434
Wire, Assault, W-130 and WD-3/TT614, 615
Wire, Bare (also see "Open Wire Lines")	601, 604, 605
Wire, Field	613-615
Wire, Messenger	604
Wire, Messenger for Spiral-Four Cable	612
Wire, Open (see "Open Wire Lines")
Wire, Placing and Recovering Equipment	635
Wire, Rubber-covered:
Construction Time629, 630
Transmission Data	615
Wire, Station Length for Various Switchboard Limits	409
Wire Systems, Comparisons	227-229
Wire, Tactical, Long Range, W-143	605, 613-615

X

X-61652 W.E.Co. Instr. Book, Portable Information Center	503
X-61684 W.E.Co. Instr. Book, Portable Filter Center	503
X-61757 W.E.Co. Instr. Book, 42B1 Carrier Telegraph Equipment	1025
X-61759 W.E.Co. Instr. Book, Single-sideband Carrier Telegraph	1025
X-61778 W.E.Co. Instr. Book, Test Set I-181	1317
X-61796 W.E.Co. Instr. Book, Test Set I-49	1317
X-61806 W.E.Co. Instr. Book, 67B Test Set	917, 1317
X-61819P Terminal Package, Telephone, C Carrier, East	919, 921
X-61819R Terminal Package, Telephone, C Carrier, West	919, 921
X-61819S Repeater Package, Telephone, C Carrier	919, 921
X-61819T Testing Package, Telephone, C Carrier	1314, 1315
X-61820A Ringer Package, Voice Frequency, 4 Circuits	918, 921
X-61820B Ringer Package, Voice Frequency, 2 Circuits	918, 921
X-61821J Repeater Package, Telephone, VF, Single	917, 921
X-61821K Repeater Package, Telephone, VF, Triple	917, 921
X-61821L Testing Package, Telephone, VF	1314, 1315
X-61822A Telegraph Carrier Package, VF, 6 Channel	1025, 1028
X-61822B Telegraph Carrier Package, VF, 6 Channel	1025, 1028
X-61822C Test Package, Telegraph, VF, Carrier	1314, 1315
X-61823E Panel, Transfer, C Carrier, Package	919, 921
X-61823C Panel, Line Terminating and Composite, Telephone	917, 921
X-61823D, E, F Cabinet, Telephone, Apparatus	920, 921
X-61823H Panel, Line Terminating and Simplex, Telephone	917, 921
X-61824A Repeater Package, Telegraph, DC	1024, 1028
X-63634 W.E.Co. Instr. Book, Test Set I-193-A	1317
X-63641 W.E.Co. Instr. Book, VF Ringer Package	917, 918
X-63653 W.E.Co. Instr. Book, VF Carrier Telegraph Package	1025
X-63699A Mobile Test Unit	429, 430
X-66031A Repeater Package, Telegraph, Regenerative	1024, 1028
X-66031B Test Package, Regenerative Repeater	1314, 1315
X-66034A or B Test and Control Board	429, 430
X-66038 W.E.Co. Instr. Book, DC Telegraph Repeater Package	1024
X-66039 W.E.Co. Instr. Book, DC Regenerative Repeater Package	1024
X-66086 Tool Set, Telephone and Telegraph Installation and Maintenance, Small Office	1311, 1312
X-66087 Tool Set, Telephone and Telegraph Installation and Maintenance, Medium Office	1311, 1312
X-66088 Tool Set, Telephone and Telegraph Installation and Maintenance, Large Office	1311, 1312
X-66106A Repeater and Control Unit	1027, 1028
X-66147 W.E.Co. Instr. Book, VF Carrier Telegraph Package	1025
X-66150 W.E.Co. Instr. Book, Line Terminating and Composite Package	917, 919

X (Cont'd.)

	<u>Paragraph</u>
X-66152 W.E.Co. Instr. Book, 133A1 Teletypewriter Tables, etc.	1027
X-66154 W.E.Co. Instr. Book, 132A2 Teletypewriter Subscriber Set, etc.	1027
X-66157 W.E.Co. Instr. Book, Vacuum Tube Tester, Hickok	1317
X-66208 W.E.Co. Instr. Book, Toll Line Observing Equipment	432
X-66209 W.E.Co. Instr. Book, Multi-Line Observing Equipment	432
X-66217A Terminal Package, Telephone, H Carrier	919, 921
X-66217B Repeater Package, Telephone, H Carrier	919, 921
X-66217C Panel, Line Filter and Balancing, Telephone	919, 921
X-66226 W.E.Co. Instr. Book, 32A Transmission Measuring Set	1317
X-66227 W.E.Co. Instr. Book, 51A Oscillator	1317
X-66228 W.E.Co. Instr. Book, "C" Carrier Telephone Package	919
X-66229 W.E.Co. Instr. Book, "C" Carrier Telephone Package	919
X-66230 W.E.Co. Instr. Book, VF Telephone Repeater Package	917
X-66231 W.E.Co. Instr. Book, VF Telephone Repeater Package	917
X-66232 W.E.Co. Instr. Book, 19C Oscillator	1317
X-66233 W.E.Co. Instr. Book, 13A Transmission Measuring Set	1317
X-66234 W.E.Co. Instr. Book, 5A Attenuator	1317
X-66247 W.E.Co. Instr. Book, Line Terminating and Simplex Package	917
X-66251 W.E.Co. Instr. Book, Mobile Toll Test Unit, Package	429
X-66259 W.E.Co. Instr. Book, Test and Control Board Package	429
X-66260 W.E.Co. Instr. Book, Volt-Ohm-Milliammeter & Volt-Ohmmeter	917, 1317
X-66307 W.E.Co. Instr. Book, Tools for Packaged Equipment	1311
X-66329 W.E.Co. Instr. Book, 5 Line Observing Cabinet	432
X-66330 W.E.Co. Instr. Book, Repeater and Control Unit for 132A2 Tty. Set	1027
X-66355 W.E.Co. Instr. Book, Two-Channel Start-Stop Transmitter- Distributor	1027
X-66413 W.E.Co. Instr. Book, Tool Equipment TE-123	1311
X-66464 W.E.Co. Instr. Book, Vacuum Tube Tester, Hickok (I-171).	1317
X-66520 W.E.Co. Instr. Book, Telegraph Switchboard SB-6/GG	1024
X-66578 W.E.Co. Instr. Book, Single-sideband Carrier Telegraph	1025
X-66616 W.E.Co. Instr. Book, Telegraph Terminal CF-6-() (Carrier)	1007
ID-91 (Teletype Corp) Transmitter-Distributor	1027, 1028, 1032