

146d

# TM 11-1211

WAR DEPARTMENT TECHNICAL MANUAL

U113  
.2  
Tm 11:  
1211  
1945

## TEST SET AN/MPM-2

Classification changed from CONFIDENTIAL to RESTRICTED by  
authority of WDCi 366 1945

UNIVERSITY OF CALIFORNIA  
LIBRARY  
NOV 5 1948  
SERIES DIVISION



WAR DEPARTMENT

24 FEBRUARY 1945

Digitized by Google

Original from  
UNIVERSITY OF CALIFORNIA

**THIS ADDENDA WILL REMAIN IN EFFECT ONLY UNTIL THE INFORMATION IS PUBLISHED IN AN OFFICIAL WAR DEPARTMENT PUBLICATION.**

# **ADDENDA**

**26 FEBRUARY 1945**

---

## **ADDENDA TO**

# **TM 11-1211**

### **TEST SET AN/MPM-2**

The following information is published on Order No. 896-MPD-45, TM 11-1211, 24 February 1945. The serial numbers of the units covered in this addenda are:

<b>NAME</b>	<b>SERIAL NO.</b>
TEST SET AN/MPM-2	1 to 16 incl

**Personnel using the equipment and having custody of this technical manual will enter suitable notations beside each affected paragraph and figure in the technical manual to indicate the presence of this supplementary information.**

---

Signal Generator TS-224A/UP is provided in place of Signal Generator TS-155B/UP. Two copies of Handbook of Maintenance Instructions for Field Test Set TS-14/AP are packed with each Signal Generator TS-224A/UP.

**CONFIDENTIAL**

*WAR DEPARTMENT TECHNICAL MANUAL*

*TM 11-1211 CONFIDENTIAL*

---

**TEST SET  
AN/MPM-2**



*WAR DEPARTMENT*

*24 FEBRUARY 1945*

---

**M609736**

WAR DEPARTMENT,  
WASHINGTON 25, D. C., 24 February 1945.

TM 11-1211, Test Set AN/MPM-2, is published for the information and guidance of all concerned.

[A. G. 300.7 (26 Oct 44).]

BY ORDER OF THE SECRETARY OF WAR:

G. C. MARSHALL,  
*Chief of Staff.*

OFFICIAL:

J. A. ULIO,  
*Major General,*  
*The Adjutant General.*

DISTRIBUTION:

AAF (5); AGF (5); ASF (2); T of Opn (5); Dept (5); Base Comd (5); Def Comd (2); Arm & Sv Bd (2); S Div ASF (1); SvC (5); Air Tech SvC (5); PE (Sig Sec) (2); ASF Dep (Sig Sec) (2); Dep 11 (Overseas) (10); Gen Overseas SOS Dep (Sig Sec) (10); Pro Dist 11 (2); USMA (10); WDGS Lib (2); Lab 11 (2); Rep Shop 11 (2); Inspection 2 11 (2); A (5); CHQ (5); Three (3) copies to each of the following: T/O & E 4-157; 4-232; 4-240-1S; 4-260-1; 11-107; 11-357; 11-500, Sig Sv Orgn: (CC), (EC), (EG), (GQ); 11-587; 11-592; 11-597; 11-617; 44-16; 44-17; 44-116; 44-117.

Refer to FM 21-6 for explanation of distribution formula.



U113  
 .2  
 TM11:1211  
 1945

# TABLE OF CONTENTS



	<i>Paragraph</i>	<i>Page</i>
<b>SECTION I. Description.</b>		
General .....	1	1
Power .....	2	1
List of components.....	3	1
Echo Box TS-207/UP.....	4	3
Fluxmeter TS-15A/AP .....	5	4
Power Meter TS-125/AP.....	6	6
Range Calibrator I-223-A.....	7	6
Signal Generator TS-343/U.....	8	7
Signal Generator TS-155B/UP.....	9	8
Wavemeter Test Set TS-117/GP.....	10	8
Receiver Rectifier RA-66-B.....	11	9
Plan Position Rectifier RA-69-B.....	12	11
Altitude Converter Rectifier	—	
RA-70-A .....	13	12
Range Rectifier RA-72-B.....	14	12
Cords .....	15	14
Adapters .....	16	24
Antenna Assembly AS-23/AP.....	17	26
Cabinet BE-96 .....	18	26
Neon lamps and case.....	19	27
Chest CH-273 .....	20	27
Dummy Antenna TS-208/MPM.....	21	28
Plug PL-258 .....	22	28
Radio-Frequency Jack UG-30/U.....	23	28

Generated on 2015-11-25 15:44 GMT / http://hdl.handle.net/2027/uc1.b3245468  
 Public Domain, Google-digitized / http://www.hathitrust.org/access\_use#pd-google

# TABLE OF CONTENTS

	<i>Paragraph</i>	<i>Page</i>
SECTION I. Description (contd).		
Tools .....	24	28
Terminal Box J-74/MPM.....	25	29
Test Antenna TS-210/MPM.....	26	30
Thermometer and case.....	27	31
II. Installation and operation.		
General .....	28	32
Echo Box TS-207/UP.....	29	32
Fluxmeter TS-15A/AP .....	30	37
Power Meter TS-125/AP .....	31	39
Range Calibrator I-223-A.....	32	41
Signal Generator TS-343/U.....	33	45
Signal Generator TS-155B/UP.....	34	47
Wavemeter Test Set TS-117/GP.....	35	51
Test Antenna TS-210/MPM and Dummy Antenna TS-208/MPM...	36	53
III. Preventive maintenance.		
General .....	37	55
Preventive maintenance techniques	38	55
Materials needed .....	39	56
Preventive maintenance instruc- tions .....	40	56
Cords .....	41	57
Tools .....	42	58
IV. Functioning of parts.		
General .....	43	59
Echo Box TS-207/UP.....	44	59
Fluxmeter TS-15A/AP .....	45	60

# TABLE OF CONTENTS

---

	<i>Paragraph</i>	<i>Page</i>
<b>SECTION IV. Functioning of parts (contd).</b>		
Power Meter TS-125/AP.....	46	62
Range Calibrator I-223-A .....	47	63
Signal Generator TS-343/U.....	48	64
Signal Generator TS-155B/UP.....	49	66
Wavemeter Test Set TS-117/GP.....	50	68
 <b>V. Repairs.</b>		
Servicing .....	51	71
General repair .....	52	71
Mechanical repairs .....	53	72
Echo Box TS-207/UP.....	54	72
Fluxmeter TS-15A/AP .....	55	73
Power Meter TS-125/AP .....	56	73
Range Calibrator I-223-A.....	57	74
Signal Generator TS-343/U.....	58	75
Signal Generator TS-155B/UP.....	59	76
Wavemeter Test Set TS-117/GP.....	60	77
 <b>VI. Supplementary data.</b>		
Maintenance parts list for Test Set AN/MPM-2 .....	61	79

## **LIST OF ILLUSTRATIONS**

<i>Fig. No.</i>	<i>Title</i>	<i>Page</i>
1	Echo Box TS-207/UP and associated parts.....	4
2	Fluxmeter TS-15A/AP, front view.....	5
3	Power Meter TS-125/AP and associated equipment.....	6
4	Range Calibrator I-223-A.....	7
5	Signal Generator TS-343/U, front view.....	8
6	Signal Generator TS-155B/UP, front view.....	9
7	Wavemeter Test Set TS-117/GP.....	10
8	Receiver Rectifier RA-66-B, front view.....	11
9	Plan Position Rectifier RA-69-B, front view.....	12
10	Altitude Converter Rectifier RA-70-A.....	13
11	Range Rectifier RA-72-B, front view.....	13
12	Typical coaxial cords used with Test Set AN/MPM-2.....	14
13	Details of Cords CG-70/MPM, CG-71/MPM, CG-135/UP, and CG-136/UP.....	15
14	Details of Cords CX-245/UP, CX-246/UP, CX-247/UP, and CX-248/UP.....	17
15	Details of Cords CX-249/UP, CX-250/UP, CX-251/UP, and CX-252/UP.....	19
16	Details of Cords CX-253/UP, CX-254/UP, CX-255/UP, and CX-256/UP.....	21
17	Details of Cords CX-257/UP, CX-258/UP, CX-259/UP, and CX-260/UP.....	23
18	Details of Cords CX-261/UP, CX-262/UP, and CX-263/UP.....	25
19	R-f and video adapters and connectors.....	26

## LIST OF ILLUSTRATIONS

<i>Fig. No.</i>	<i>Title</i>	<i>Page</i>
20	Cabinet BE-96 .....	27
21	Typical neon lamp.....	27
22	Carrying case for neon lamps.....	28
23	Chest CH-273.....	29
24	Dummy Antenna TS-208/MPM.....	29
25	Tools used with Test Set AN/MPM-2.....	30
26	Terminal Box J-74/MPM .....	30
27	Terminal Box J-74/MPM, cover removed.....	31
28	Test Antenna TS-210/MPM.....	31
29	Antenna Assembly AS-23/AP mounted on van.....	33
30	Use of Fluxmeter TS-15A/AP.....	37
31	Connection of Signal Generator TS-155B/UP, Wave- meter Test Set TS-117/GP, and test oscilloscope.....	47
32	Antenna Assembly AS-23/AP connected to Wavemeter Test Set TS-117/GP.....	51
33	Test Antenna TS-210/MPM and Dummy Antenna TS-208/MPM mounted on Radio Receiver and Trans- mitter BC-1267-A .....	54
34	Echo Box TS-207/UP, simplified schematic diagram.....	60
35	Fluxmeter TS-15A/AP, schematic diagram.....	61
36	Power Meter TS-125/AP, schematic diagram.....	62
37	Range Calibrator I-223-A, block diagram.....	64
38	Signal Generator TS-343/U, schematic diagram.....	65
39	Signal Generator TS-155B/UP, block diagram.....	67
40	Wavemeter Test Set TS-117/GP, interior view (crystal holder open) .....	69
41	Resonant cavity, simplified schematic diagram.....	69

# **WARNING**

## **HIGH VOLTAGE**

is used in the operation  
of the radio equipment.

## **DEATH ON CONTACT**

may result if personnel fail  
to observe safety precautions.

---

Be careful to avoid contact with high-voltage circuits or 115-volt a-c input connections while checking or servicing the radio equipment. The major components of the radio equipment are contained within shielded cases with access doors which, when opened, automatically remove dangerous voltages from within the units. Remember that in several of the tests for which this equipment is used safety interlocks must be short-circuited in order to make the necessary tests. Consequently, extreme caution must be exercised during these tests, since these safety devices have been placed in the units specifically to protect operating personnel. Make certain that the power is turned off before disassembling any part of the radio equipment.

Dangerously high voltages are present in the power supplies of the radio equipment. Before making any service checks, manually discharge all high-voltage capacitors in these circuits after the a-c power has been removed from the components.

---

# FIRST AID TREATMENT FOR ELECTRIC SHOCK

## I. FREE THE VICTIM FROM THE CIRCUIT IMMEDIATELY.

Shut off the current. If this is not immediately possible, use a dry nonconductor (rubber gloves, rope, board) to move either the victim or the wire. Avoid contact with the victim. If necessary to cut a live wire, use an axe with a dry wooden handle. Beware of the resulting flash.

## II. ATTEND INSTANTLY TO THE VICTIM'S BREATHING.

Begin resuscitation at once on the spot. Do not stop to loosen the victim's clothing. Every moment counts. Keep the patient warm. Wrap him in any covering available. Send for a doctor. Remove false teeth or other obstructions from the victim's mouth.

# Resuscitation

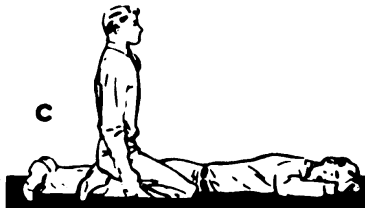

### POSITION

1. Lay the victim on his belly, one arm extended directly overhead, the other arm bent at the elbow, the face turned outward and resting on hand or forearm so that the nose and mouth are free for breathing (fig. A).
2. Straddle the patient's thighs, or one leg, with your knees placed far enough from his hip bones to allow you to assume the position shown in figure A.
3. Place your hands, with thumbs and fingers in a natural position, so that your palms are on the small of his back, and your little fingers just touch his lowest ribs (fig. A).

### FIRST MOVEMENT

4. With arms held straight, swing forward slowly, so that the weight of your body is gradually brought to bear upon the victim. Your shoulders should be directly over the heels of your hands at the end of the forward swing (fig. B). Do not bend your elbows. The first movement should take about 2 seconds.

### SECOND MOVEMENT

5. Now immediately swing backward, to remove the pressure completely (fig. C).
6. After 2 seconds, swing forward again. Repeat this pressure-and-release cycle 12 to 15 times a minute. A complete cycle should require 4 or 5 seconds.

### CONTINUED TREATMENT

7. Continue treatment until breathing is restored or until there is no hope of the victim's recovery. Do not give up easily. Remember that at times the process must be kept up for hours.
8. During artificial respiration, have someone loosen the victim's clothing. Wrap the victim warmly; apply hot bricks, stones, etc. Do not give the victim liquids until he is fully conscious. If the victim must be moved, keep up treatment while he is being moved.
9. At the first sign of breathing, withhold artificial respiration. If natural breathing does not continue, immediately resume artificial respiration.
10. If operator must be changed, the relief operator kneels behind the person giving artificial respiration. The relief takes the operator's place as the original operator releases the pressure.
11. Do not allow the revived patient to sit or stand. Keep him quiet. Give hot coffee or tea, or other internal stimulants.

## HOLD RESUSCITATION DRILLS REGULARLY

TL37451A

## **DESTRUCTION NOTICE**

**WHY** —To prevent the enemy from using or salvaging this equipment for his benefit.

**WHEN**—When ordered by your commander.

- HOW**
1. Smash—Use sledges, handaxes, pickaxes, hammers, crowbars, heavy tools.
  2. Cut—Use axes, handaxes, machetes.
  3. Burn—Use gasoline, kerosene, oil, flame throwers, incendiary grenades.
  4. Explosives—Use firearms, grenades, TNT.
  5. Disposal—Bury in slit trenches, fox holes, other holes. Throw in streams. Scatter.

### **USE ANYTHING IMMEDIATELY AVAILABLE FOR DESTRUCTION OF THIS EQUIPMENT.**

- WHAT**
1. Smash—Controls, dials, switches, tubes, coils, assemblies, meters, tuning capacitors, cabinets.
  2. Cut—Cables, wiring, coil windings.
  3. Burn—Technical manuals, schematic diagrams, cable and wiring insulation, all inflammable parts.
  4. Bend—Panels, chassis, assemblies, cabinets.
  5. Bury or scatter—All of the above pieces after destroying their usefulness.

## **DESTROY EVERYTHING**



# **CONFIDENTIAL**

## **SECTION I**

### **DESCRIPTION**

---

#### **1. GENERAL.**

Test Set AN/MPM-2 consists of the special test equipment for Radio Set SCR-584 and Radio Equipment RC-184. When the equipment included in this test set is used in conjunction with Test Set AN/GPM-1, all equipment necessary for third echelon maintenance is available. The test equipment is carried in Truck M-30. Part of the equipment is contained in a wooden chest mounted on a shock-mounted base in the center of the van. Complete information on the major test instruments included in the set may be found in the technical manuals covering those instruments. Further information on the use of some of the instruments with Radio Set SCR-584 and Radio Equipment RC-184 may be found in the technical operations and service manuals for the two sets.

#### **2. POWER.**

The power for operating the test equipment can be obtained either from Power Unit PE-95 or from a commercial source. Outlet boxes for 110 volts are arranged conveniently on both sides of the van. There is also 6-volt, 12-volt and 24-volt d-c power supplied by batteries located in the front of the van. These batteries are charged by Rectifier Power Unit PP-34( )/MSM. The details of the wiring inside the van and the location of the various items of equipment included are covered in TM 11-1080 on Test Set AN/GPM-1.

#### **3. LIST OF COMPONENTS.**

The components of Test Set AN/MPM-2 are as follows:

<i>Quantity</i>	<i>Article</i>
1	Echo Box TS-207/UP.
1	Fluxmeter TS-15A/AP.
1	Power Meter TS-125/AP.
1	Range Calibrator I-223-A.
1	Signal Generator TS-343/U.

<i>Quantity</i>	<i>Article</i>
1	Signal Generator TS-155B/UP.
1	Wavemeter Test Set TS-117/GP.
1	Receiver Rectifier RA-66-B.
1	Plan Position Rectifier RA-69-B.
1	Altitude Converter Rectifier RA-70-A.
1	Range Rectifier RA-72-B.
1	Cord CG-70/MPM.
1	Cord CG-71/MPM.
1	Cord CG-135/UP.
1	Cord CG-136/UP.
1	Cord CX-245/UP.
1	Cord CX-246/UP.
1	Cord CX-247/UP.
1	Cord CX-248/UP.
1	Cord CX-249/UP.
2	Cord CX-250/UP.
1	Cord CX-251/UP.
2	Cord CX-252/UP.
1	Cord CX-253/UP.
6	Cord CX-254/UP.
1	Cord CX-255/UP.
2	Cord CX-256/UP.
1	Cord CX-257/UP.
1	Cord CX-258/UP.
1	Cord CX-259/UP.
2	Cord CX-260/UP.
1	Cord CX-261/UP.
1	Cord CX-262/UP.
1	Cord CX-263/UP.
2	Adapter M-358.
2	Adapter M-359.
1	Adapter U-18/UP.
1	Crystal Adapter UG-119/UP.
1	Antenna Assembly AS-23/AP.
4	Cabinet BE-96.
10	Lamp LM-54.
1	Case, for neon lamps.
2	Chest CH-273.
1	Dummy Antenna TS-208/MPM.
2	Plug Pl-258.
2	Radio-Frequency Jack UG-30/U.
1	Terminal Box J-74/MPM.

<i>Quantity</i>	<i>Article</i>
1	Test Antenna TS-210/MPM.
1	Thermometer, No. 213.
1	Thermometer case, No. 600.
10	Tube 1N21-B.
1	Spanner Wrench MX-219/UP (supplied with Echo Box TS-207/UP).
1	Handle, for spinner motor shaft seal nut wrench, Miller Tool & Mfg Co MTM-SL-15, or equal.
1	Wrench, elevation adjusting arm nut, Miller Tool & Mfg Co MTM-SL-12, or equal.
1	Wrench, elevation, potentiometer gear, Miller Tool & Mfg Co MTM-SL-20, or equal.
1	Wrench, elevation, potentiometer gear nut, Miller Tool & Mfg Co MTM-SL-21, or equal.
1	Wrench, spinner motor flange, Miller Tool & Mfg. Co MTM-SL-19, or equal.
1	Wrench, spinner motor seal, Miller Tool & Mfg Co MTM-SL-18, or equal.
1	Wrench, spinner motor shaft seal nut, Miller Tool & Mfg Co MTM-SL-15, or equal.
1	Puller, universal coupling, Miller Tool & Mfg Co MTM-SL-22, or equal.
1	Pliers, ring, Forged Steel Products Co Vacuum Grip No. 70-A or equal; Chrysler dwg No. 1061644.
1	Wrench, spinner motor locknut, Miller Tool & Mfg Co MTM-SL-14 or equal; Chrysler dwg No. 1061625.

#### **4. ECHO BOX TS-207/UP (fig. 1).**

**a.** The echo box is used to check over-all performance of Radio Set SCR-584. It consists of a cylindrical cavity resonator approximately 6 inches in diameter and 5½ inches long. A piston or plunger inside the cylinder moves axially to vary the length of the cavity. When the knob in the end of the echo box is turned clockwise, the plunger is moved into the cavity and the length of the cavity is decreased. Energy from the radar set is picked up by Antenna Assembly AS-23/AP and coupled to the cavity. Some of the energy from the cavity is coupled to a crystal rectifier and a microammeter. The echo-box knob is turned until maximum deflection is obtained on the meter. The reading indicated on the echo-box scale and the position of the calibrated tuning knob are used with a calibration chart to determine the resonant frequency of the cavity.

b. Radio-frequency (r-f) energy from the pick-up dipole antenna is inductively coupled to the cavity by means of a coupling loop in one side of the box. A similar coupling loop on the opposite side of the box is used to feed r-f energy from the cavity to the crystal rectifier and microammeter. The inside of the cavity is silver-plated and highly polished to increase efficiency. Complete information on Echo Box TS-207/UP is given in TM 11-1212 and TM 11-1524.

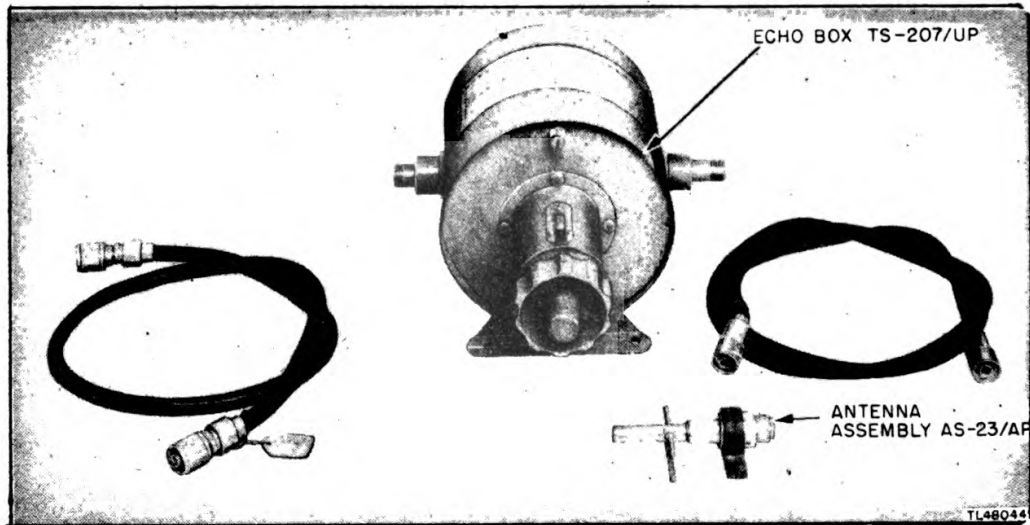

Figure 1. Echo Box TS-207/UP and associated parts.

**NOTE:** On later models Echo Box TS-270/UP may be supplied instead of Echo Box TS-207/UP. In this case Terminal Box J-74/MPM will not be supplied, since Echo Box TS-270/UP has its own indicating meter.

## 5. FLUXMETER TS-15A/AP (fig. 2).

This fluxmeter is a portable self-contained test instrument designed to measure the magnetic flux densities between the poles of magnets used with the magnetrons in X-band and S-band transmitters. The instrument is calibrated to indicate the magnetic flux density in gaussses over a range of 1,200 to 9,600 gaussses. A probe meter is inserted between the pole faces of the magnet and is adjusted to a calibration mark. The flux density of the magnet under test is indicated on a gauss meter located in a rectangular wooden case containing the controls and other electrical components. A removable cover protects the instrument panel when the instrument is not in use. The probe meter is permanently connected to the test set by a shielded cable. Storage space for the probe meter and cable is provided in one end of the wooden

case. A 1.5-volt battery supplies power for the instrument. Complete information on Fluxmeter TS-15A/AP is given in TM 11-2559.

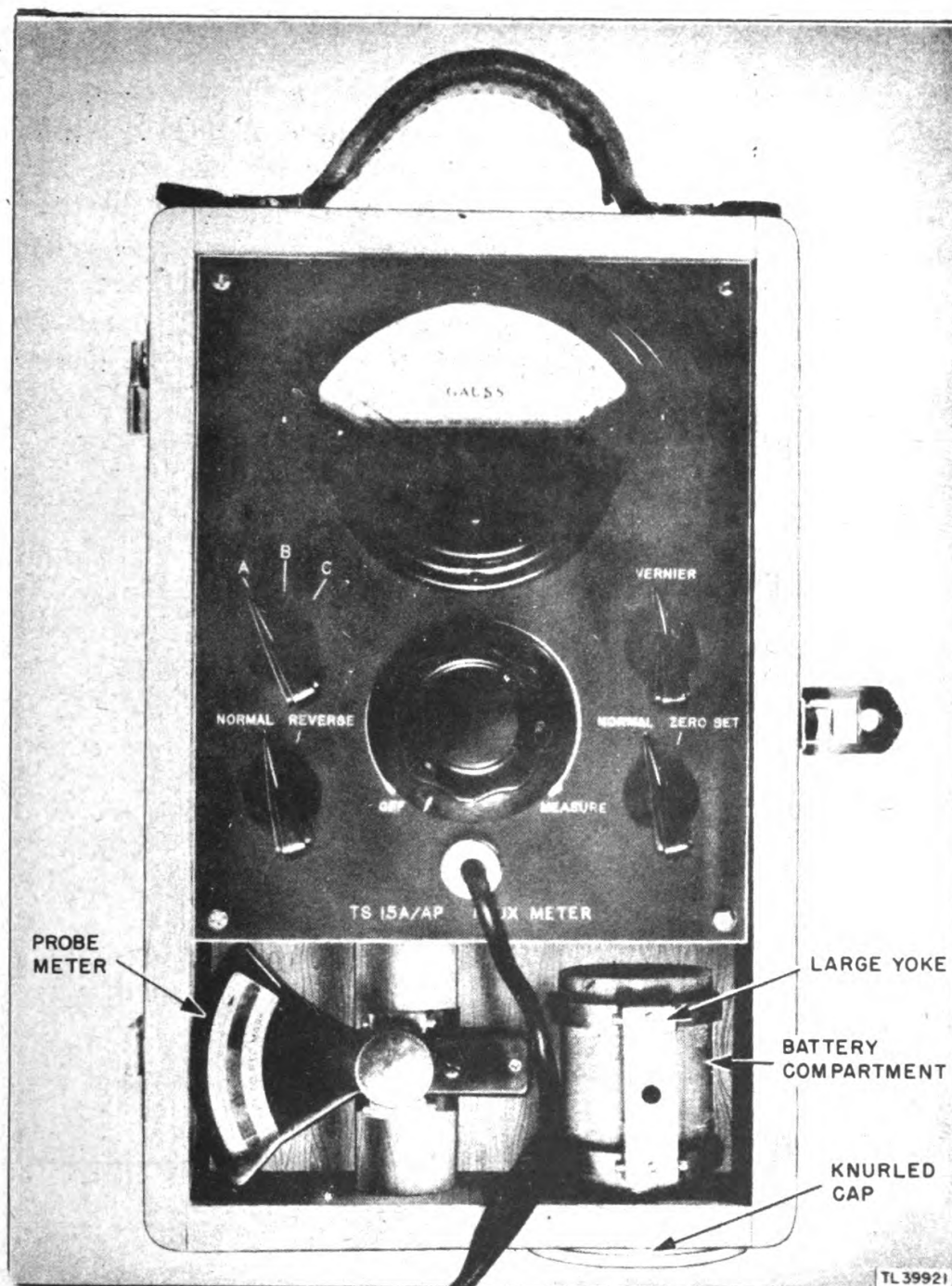

Figure 2. Fluxmeter TS-15A/AP, front view.

## 6. POWER METER TS-125/AP (fig. 3).

Power Meter TS-125/AP is a compact battery-operated watt-meter for measuring r-f power in the S-band system. The watt-meter consists of a cast aluminum box containing a thermistor mount, temperature compensating thermistor disks, a bridge with a meter and a balancing potentiometer, and three standard flashlight batteries. Storage space is provided in the meter for a 10-decibel attenuator and a 16-decibel attenuator. A pick-up horn antenna and a length of r-f cable are provided for use with the instrument. The meter reading is directly proportional to the average r-f power fed into the power meter. The meter is calibrated to read full scale when 2 milliwatts of r-f power are applied. The meter also has a dbm scale, on which zero db equals 1 milliwatt; hence the name *dbm scale* (decibels above or below 1 milliwatt). Complete information on Power Meter TS-125/AP is given in TM 11-1217.

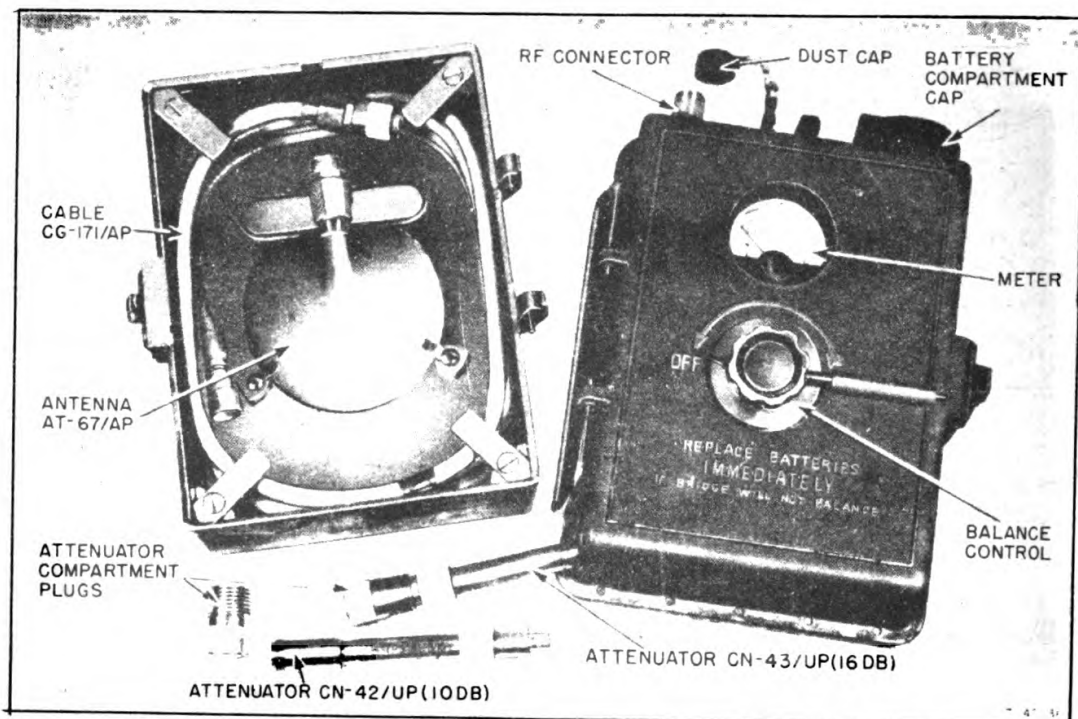

Figure 3. Power Meter TS-125/AP and associated equipment.

## 7. RANGE CALIBRATOR I-223-A (fig. 4).

The range calibrator is used to calibrate the range indications of Radio Equipment RC-184. The calibrator produces three outputs: a sine-wave output at 163.94 kilocycles per second, a synchronizing pulse with a repetition rate of approximately 240 pulses



per second, and pulses having a rising edge of approximately  $\frac{1}{4}$  microsecond and a repetition rate of 163,940 times per second. The latter pulse corresponds to a range separation of 1,000 yards between pulses. The range calibrator is housed in a separate metal case and is designed to operate from a 115/120-volt, 60-cycle, a-c line. The panel cover contains three cables, each 6 feet long, which are used to connect the calibrator to the control unit under observation and also to an oscilloscope. Complete information on Range Calibrator I-223-A is given in TM 11-2528.

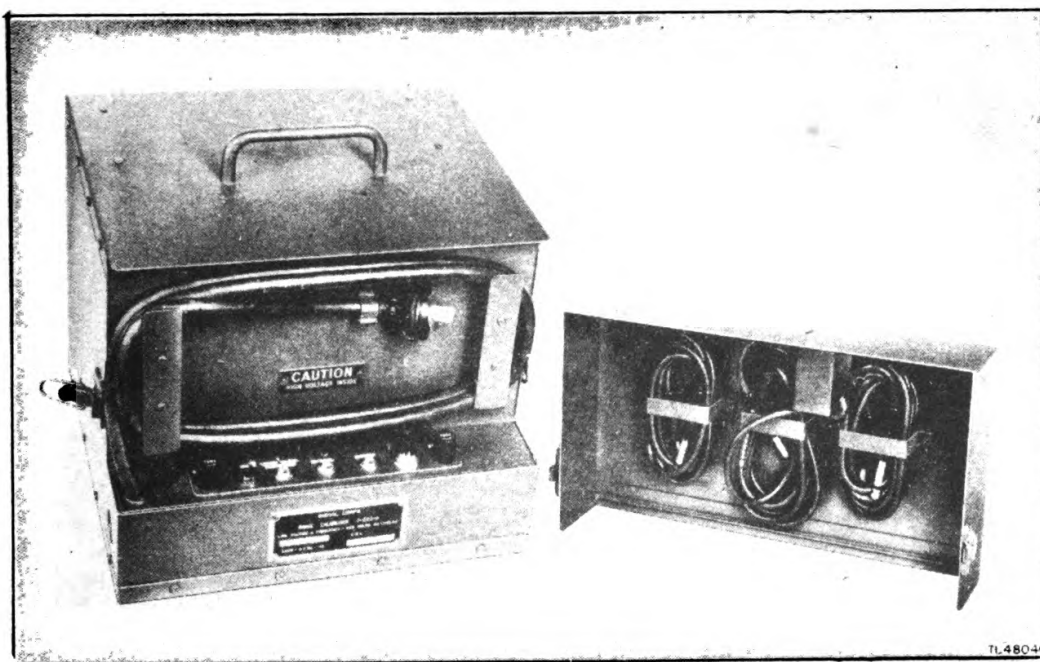

Figure 4. Range Calibrator I-223-A.

### **8. SIGNAL GENERATOR TS-343/U (fig. 5).**

Signal Generator TS-343/U is a precision instrument which provides radio-frequency oscillations in two frequency ranges, 15 to 28 megacycles and 27 to 50 megacycles. The r-f output may be sine-wave modulated at 400 or 8,200 cycles or may be unmodulated. The instrument is self-contained, portable, and can be operated from any 115/120-volt, 25/60-cycle, a-c power source. In Test Set AN/MPM-2 the signal generator is used for aligning the intermediate-frequency (i-f) stages of the receiver of Radio Set SCR-584. Complete information on Signal Generator TS-343/U is given in TM 11-1233.

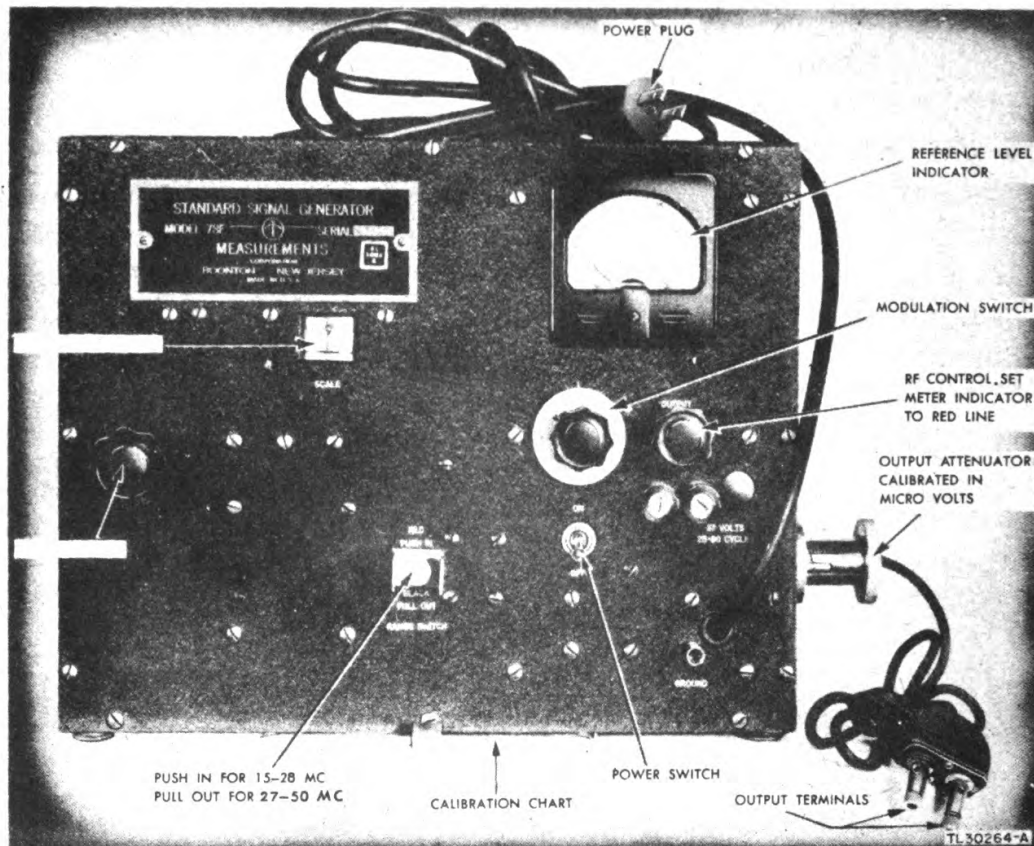

Figure 5. Signal Generator TS-343/U, front view.

## 9. SIGNAL GENERATOR TS-155B/UP (fig. 6).

This test instrument is a generator of calibrated radio-frequency signals which are pulse modulated. The signal generator is designed for operation over the frequency range from 2,700 to 2,900 megacycles. The instrument can be used to measure the power output of radar transmitters, the sensitivity of radar receivers, and the over-all performance of both transmitters and receivers. The output trigger pulse has a repetition rate which is variable from 120 to 2,000 cycles per second, and an amplitude of at least 100 volts. The instrument can be powered by a line voltage of 105/125 volts a-c with a line frequency from 50 to 1,200 cycles per second. Complete information on Signal Generator TS-155B/UP is given in TM 11-2657B.

## 10. WAVEMETER TEST SET TS-117/GP (fig. 7).

This instrument is designed to make frequency measurements of radar systems operating in the frequency band from 2,400 to 3,400 megacycles. The test set can be used to measure the frequency of a radar system by placing it in the field of microwave energy radiating from the antenna of the system. The frequencies





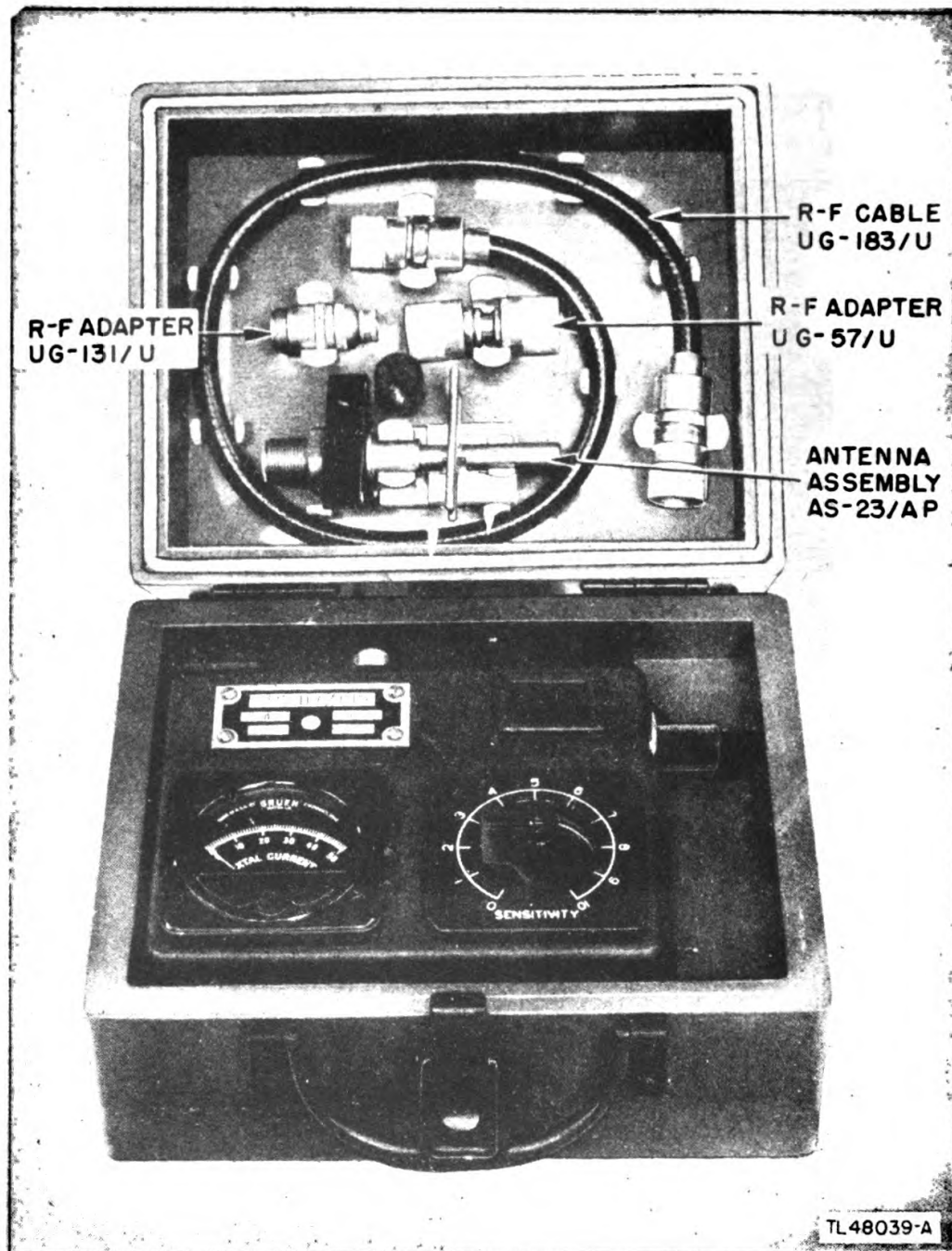

*Figure 7. Wavemeter Test Set TS-117/GP.*

5U4G tube as a full-wave rectifier. After being smoothed by an L-C filter, the output from this tube is applied through a series resistor across a voltage regulator tube. This tube (VR105-30) is a cold-cathode voltage regulator and maintains a constant drop of 105 volts across its terminals. Complete information on Receiver Rectifier RA-66-B is given in TM 11-1524.

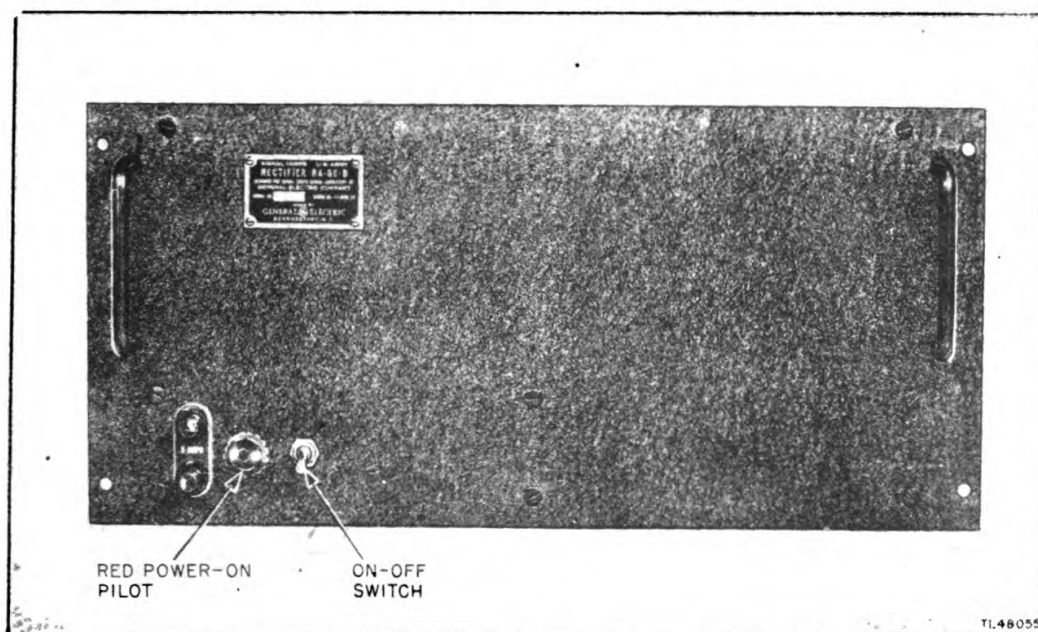

Figure 8. Receiver Rectifier RA-66-B, front view.

## 12. PLAN POSITION RECTIFIER RA-69-B (fig. 9).

Plan Position Rectifier RA-69-B provides power for the PPI unit and the PPI indicator of Radio Set SCR-584. It contains three power supplies as follows:

**a.** A high-voltage power supply using half-wave rectification which furnishes + 4,500 volts to the anode of the PPI oscilloscope.

**b.** A + 300-volt unregulated power supply which feeds the four sawtooth output amplifiers, the clamping tubes, and the range marker tubes and supplies current for the focus coil. This power supply uses full-wave rectification.

**c.** A + 270-volt regulated power supply using full-wave rectification which supplies all of the tubes in the PPI unit except those indicated in subparagraph b above.

**d.** Complete information on Plan Position Rectifier RA-69-B is given in TM 11-1524.

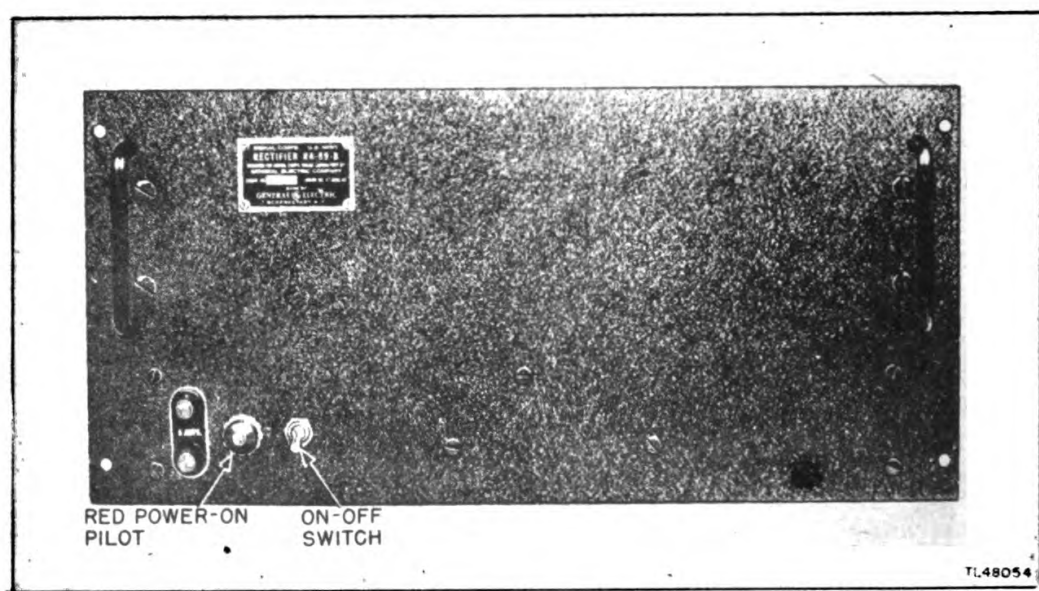

Figure 9. Plan Position Rectifier RA-69-B, front view.

### 13. ALTITUDE CONVERTER RECTIFIER RA-70-A (fig. 10).

Altitude Converter Rectifier RA-70-A which supplies power for the altitude converter, is a well-regulated power supply having a low output impedance and a small ripple voltage. This power supply furnishes power for the altitude converter of Radio Set SCR-584. The output voltage is maintained at a constant 300 volts. The advantage of a low-impedance power supply is that coupling is reduced to the minimum between various sections of the circuits to which power is supplied. When one tube suddenly draws a large amount of current the voltages on the other tubes in the circuit are not decreased, and voltage surges through the equipment are prevented. Because the regulating tubes in the power supply tend to maintain the output voltage constant, the small ripple obtained from the output of the rectifier filter is also smoothed to a very high degree. Complete information on Altitude Converter Rectifier RA-70-A is given in TM 11-1524.

### 14. RANGE RECTIFIER RA-72-B (fig. 11).

Range Rectifier RA-72-B provides power for the range unit and the range indicator unit of Radio Set SCR-584. It contains three separate power units as follows:

- a. Rectifiers for the field and armature circuits of the range motors are included in one section.



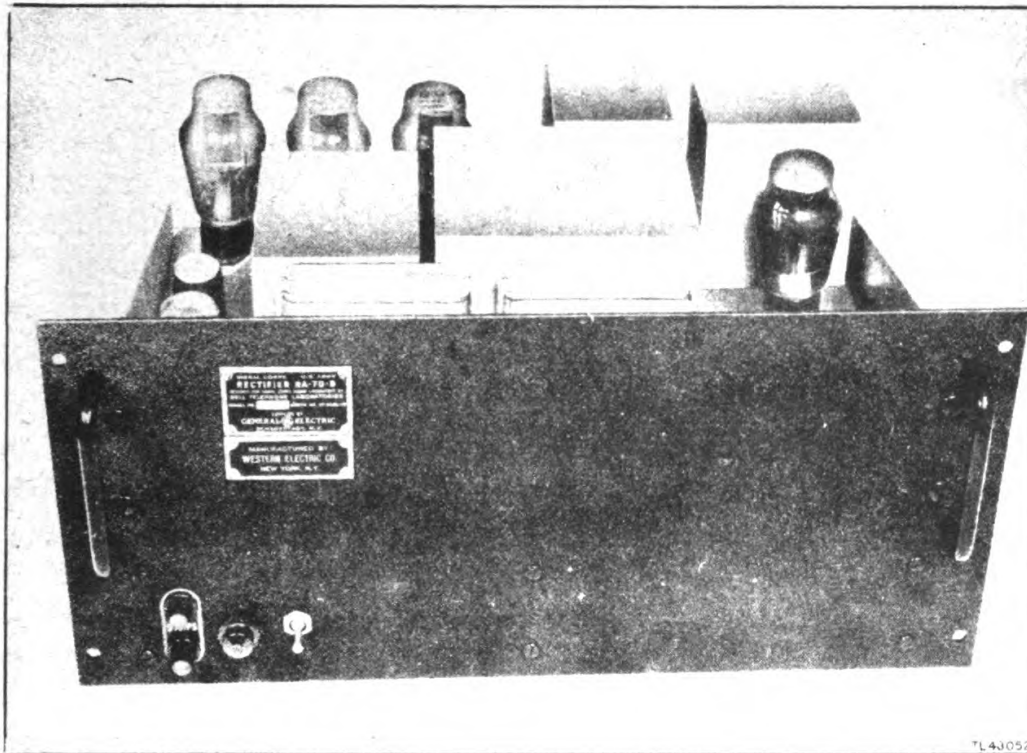

Figure 10. Altitude Converter Rectifier RA-70-A.

**b.** A low-voltage power supply for the range unit supplies + 400 volts unregulated and + 250 volts regulated.

**c.** A high-voltage supply provides — 2,000 volts for the oscilloscopes in the range indicator and bias voltages for circuits in the range unit.

**d.** Complete information on Range Rectifier RA-72-B is given in TM 11-1524.

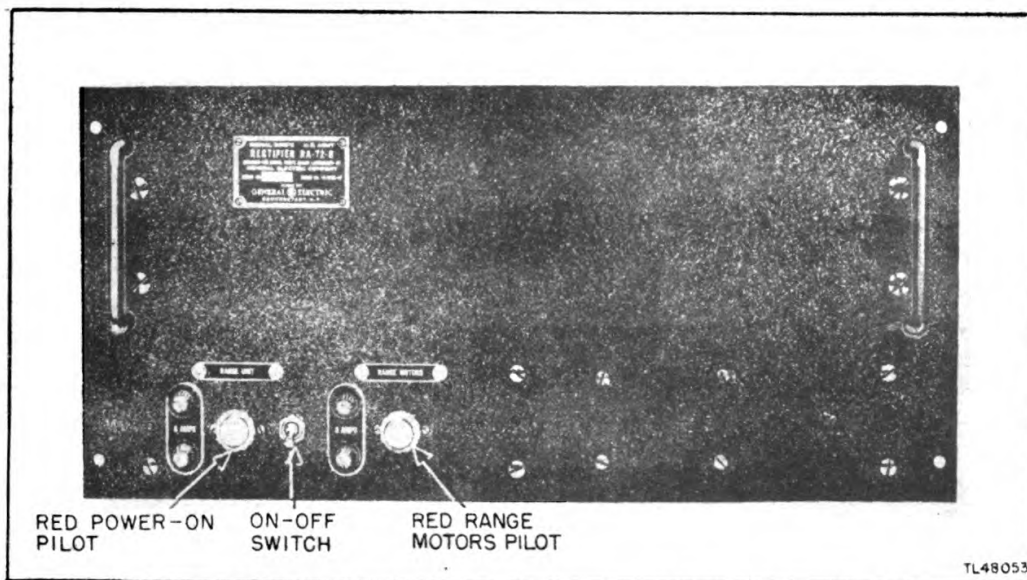

Figure 11. Range Rectifier RA-72-B, front view.

## 15. CORDS.

The following coaxial cords are included in this test set:

**a. Cord CG-70/MPM (figs. 12 and 13-A).** This cord is a 15-foot length of Cable RG-9/U terminated at each end with Plug UG-24/U. Cable RG-9/U is a stranded, single-conductor, double-shielded r-f cable. The cable is of medium size and has a vinyl covering. It is used to connect Echo Box TS-207/UP or Signal Generator TS-155B/UP to the dipole of Antenna Assembly AS-23/AP.

**b. Cord CG-71/MPM (figs. 12 and 13-B).** This cord is a 6-foot length of Cable RG-13/U terminated at each end with Plug PL-259. Cable RG-13/U is a stranded, single-conductor, double-shielded r-f cable with a vinyl protective covering. It is used to connect the output of Echo Box TS-207/UP to Terminal Box J-74/MPM and Signal Generator TS-155B/UP to Driver Unit BC-1080.

**c. Cord CG-135/UP (fig. 13-C).** This cord is a 25-foot length of Cable RG-9/U terminated at each end with a plug type UG-24/U (as made by Selectar Manufacturing Company) or an equivalent plug. This cord is used to connect Echo Box TS-207/UP to the dipole of Antenna Assembly AS-23/AP.

**d. Cord CG-136/UP (fig. 13-D).** This cord is a 3-foot length of Cable RG-9/U terminated at each end with a plug type UG-24/U (as made by Selectar Manufacturing Company) or an equivalent plug. The cord is used to connect Echo Box TS-207/UP to Antenna Assembly AS-23/AP.

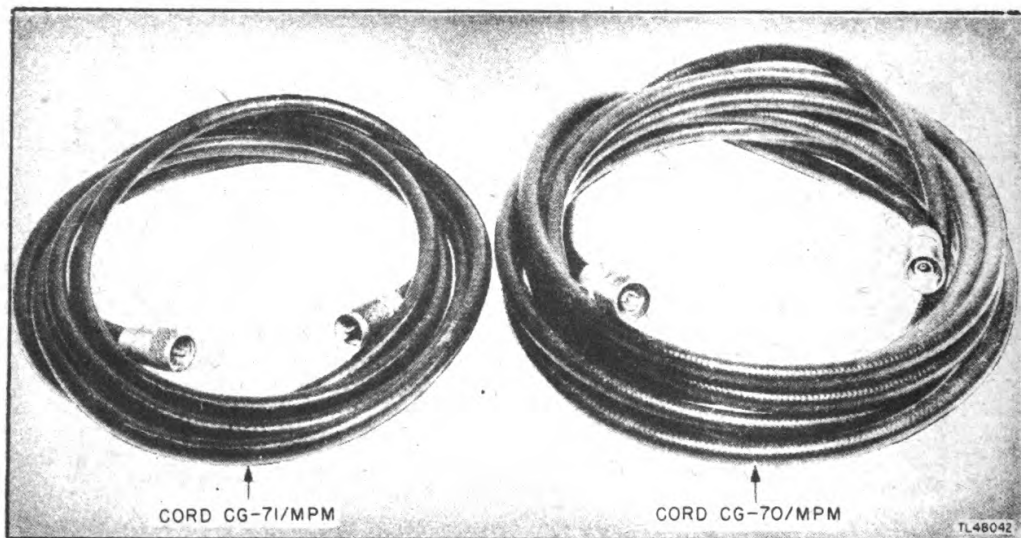
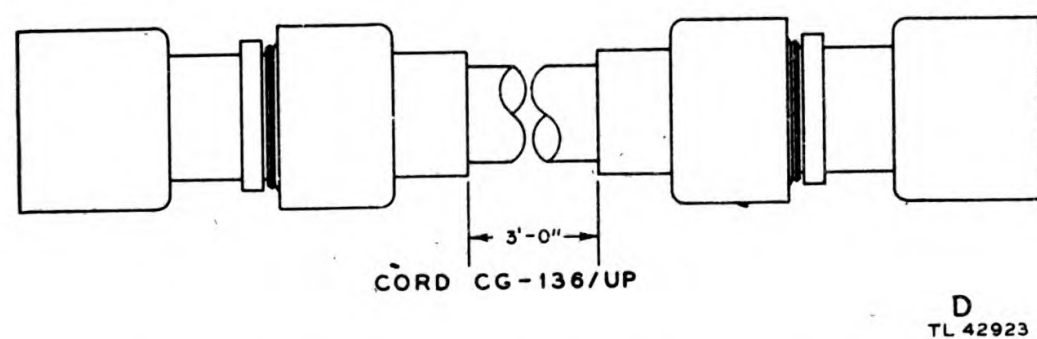
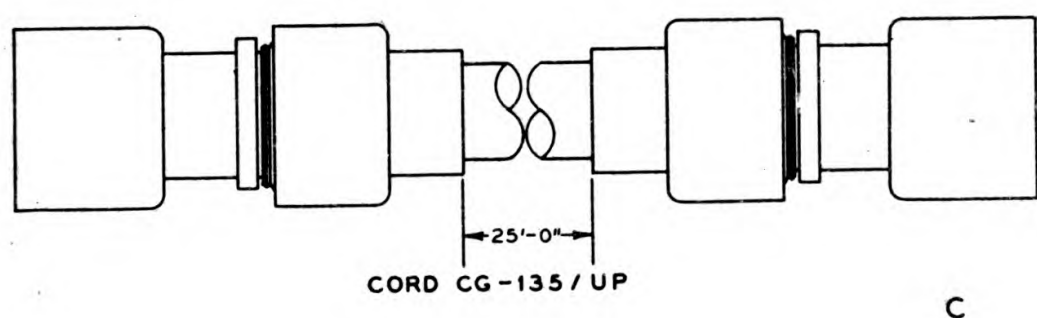
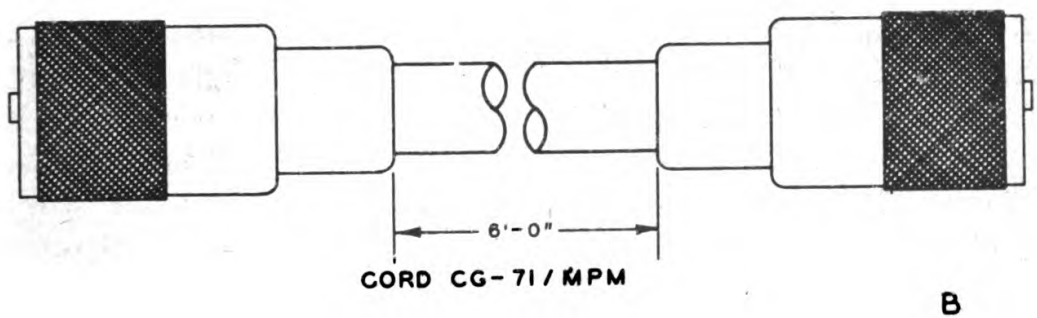
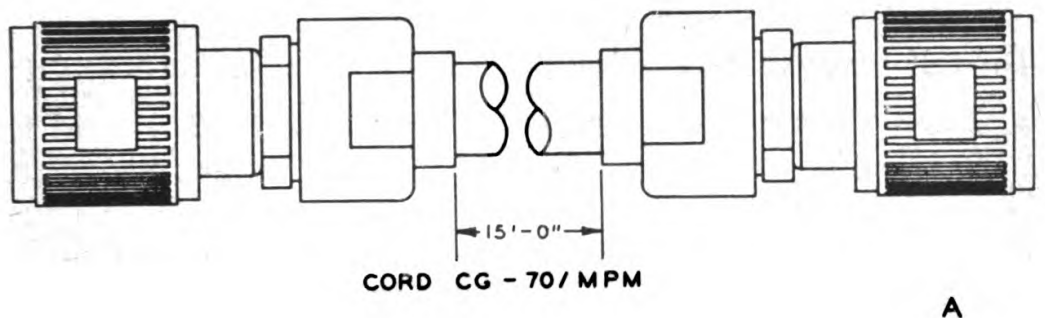

Figure 12. Typical coaxial cords used with Test Set AN/MPM-2.



*Figure 13. Details of Cords CG-70/MPM, CG-71/MPM, CG-135/UP, and CG-136/UP.*

**e. Cord CX-245/UP (fig. 14-A).** This cord is an 8-foot 2½-inch length of General Electric type CW-1273, 10-conductor cable. It is terminated at one end with a plug Amphenol AN-3106-20-7S type 102 and at the other end with a receptacle Amphenol 97-5103-20-7P. Only eight of the conductors are used; the ends of the other two conductors are taped and unattached. The cord is used to connect the following components:

- (1) Automatic Tracking Unit BC-1086 to azimuth and elevation Tracking Unit BC-1090.
- (2) Radio Receiver BC-1056 to Pre-I.F. Amplifier BC-1078.
- (3) Range Rectifier RA-72-B to Range Unit BC-1062.
- (4) Receiver Rectifier RA-66-B to Radio Receiver BC-1056.
- (5) Position Indicator BC-1076 to Data Panel PN-22.
- (6) Altitude Converter BC-1094 to Altitude Converter Rectifier RA-70-A.
- (7) Altitude Converter BC-1094 to Data Panel PN-22.
- (8) Plan Position Unit BC-1058 to Junction Box JB-71.

**f. Cord CX-246/UP (fig. 14-B).** This cord is an 8-foot 2½-inch length of General Electric type CW-1273, 10-conductor cable. It is terminated at one end with a plug Amphenol AN-3106-20-7P type 102 and at the other end with a receptacle Amphenol 97-5103-20-7S. Only eight of the conductors are used; the ends of the other two conductors are taped and unattached. This cord is used to connect the following components:

- (1) Azimuth and Elevation Tracking Unit BC-1090 to Automatic Tracking Unit BC-1086.
- (2) Automatic Tracking Unit BC-1086 to Control Panel PN-24.
- (3) Range Unit BC-1062 to Range Rectifier RA-72-B.
- (4) Radio Receiver BC-1056 to Receiver Rectifier RA-66-B.
- (5) Range Indicator BC-1088-A to Data Panel PN-22.
- (6) Receiver Rectifier RA-66-B to Remote Video Amplifier BC-1074.
- (7) Position Indicator BC-1076 to Data Panel PN-22.
- (8) Altitude Converter BC-1094 to Altitude Converter Rectifier RA-70-A.
- (9) Pre-I.F. Amplifier BC-1078 to Radio Receiver BC-1056.

**g. Cord CX-247/UP (fig. 14-C).** This cord is an 8-foot 1½-inch length of three-conductor Cordex type S cable as made by General Electric Company, or the equivalent. It is terminated



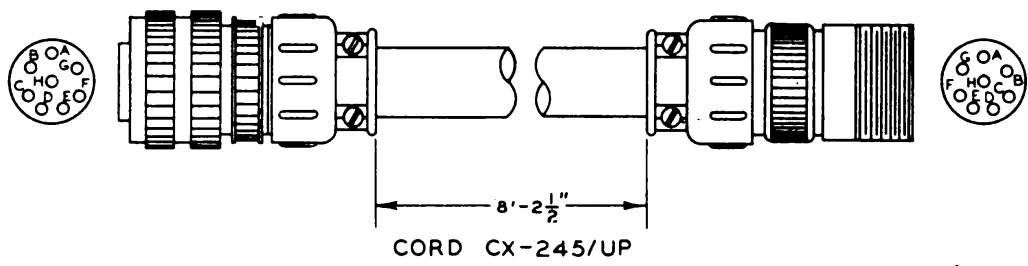

A

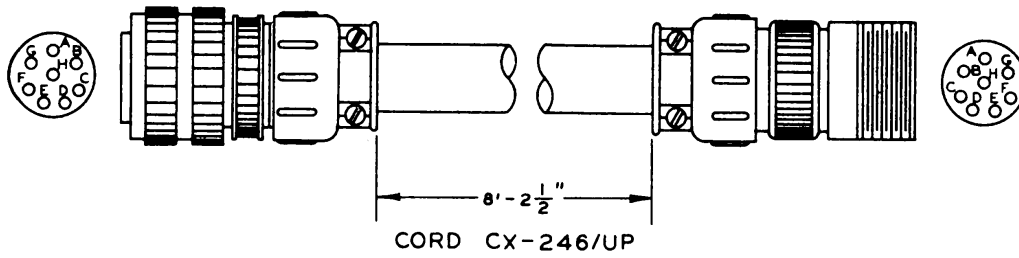

B

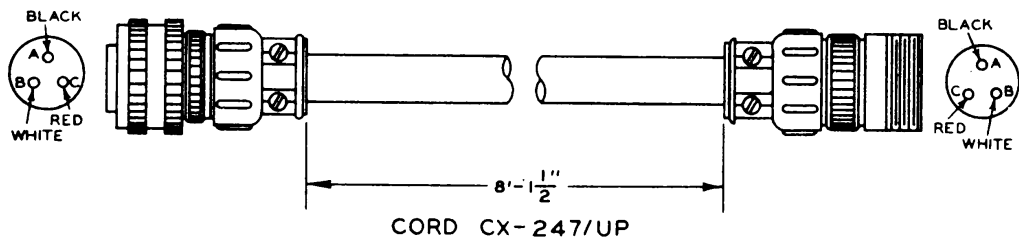

C

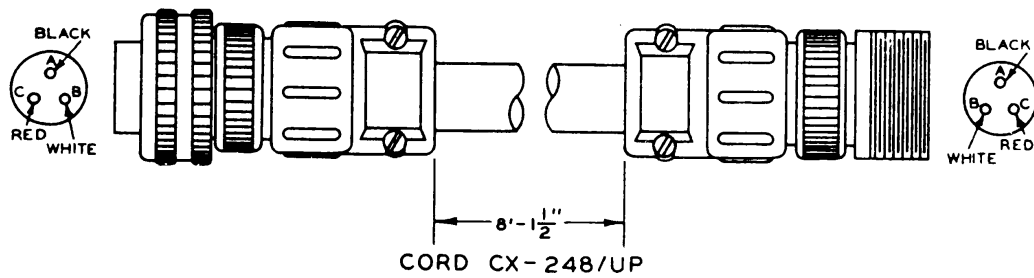

D  
TL 42924

Figure 14. Details of Cords CX-245/UP, CX-246/UP, CX-247/UP, and CX-248/UP.

at one end with a plug Amphenol AN-3106-16S-5S type 102 and at the other end with receptacle Amphenol 97-5103-16S-5P. This cord is used to connect Radio Receiver BC-1056 to Control Panel PN-24.

**h. Cord CX-248/UP (fig. 14-D).** This cord is an 8-foot 1½-inch length of three-conductor type S cable, or the equivalent. It is terminated at one end with a plug Amphenol AN-3106-16S-5P type 102 and at the other end with receptacle Amphenol 97-5103-16S-5S. This cord is used to connect the following components:

- (1) Range Unit BC-1062 to Range Indicator BC-1088.
- (2) Field Rectifier RA-71-B to Junction Box JB-71.

**i. Cord CX-249/UP (fig. 15-A).** This cord is an 8-foot 3-inch length of four-conductor cable, type M.C.S.-4 as made by General Electric Company, or the equivalent. It is terminated at one end with a plug Amphenol AN-3106-18-4P type 102 and at the other end with a receptacle Amphenol 97-5103-18-4S type 102. This cord is used to connect the following components:

- (1) Range Unit BC-1062 to Range Indicator BC-1088.
- (2) Plan Position Indicator BC-1092 to Plan Position Unit BC-1058.

**j. Cord CX-250/UP (fig. 15-B).** This cord is an 8-foot 3-inch length of four-conductor cable, type M.C.S.-4 as made by General Electric Company, or the equivalent. It is terminated at one end with a plug Amphenol AN-3106-18-4S type 102 and at the other end with a receptacle Amphenol 97-5103-18-4P type 102. Two of these cords are provided to connect the following components:

- (1) Range Unit BC-1062 to Range Indicator BC-1088.
- (2) Plan Position Unit BC-1058 to Plan Position Indicator BC-1092.

**k. Cord CX-251/UP (fig. 15-C).** This cord is a 5-foot length of No. 20 AWG, 26/34T, two-conductor shielded cable as made by the General Cable Company, or the equivalent. It is terminated at one end with a connector No. 80M and at the other end with two spade terminals colored red and black. This cord is used with the test oscilloscope.

**l. Cord CX-252/UP (fig. 15-D).** This cord is an 8-foot 2½-inch length of General Electric type CW-1273, 14-conductor cable, or the equivalent. It is terminated at one end with a plug Amphenol AN-3106-28-8P and at the other end with receptacle Amphenol 97-5103-28-8S. Only 12 of the conductors are wired to

the connectors. Two of these cords are provided to connect the following components:

(1) Position Indicator BC-1076 to Azimuth and Elevation Tracking Unit BC-1090.

(2) Position Indicator BC-1076 to Control Panel PN-24.

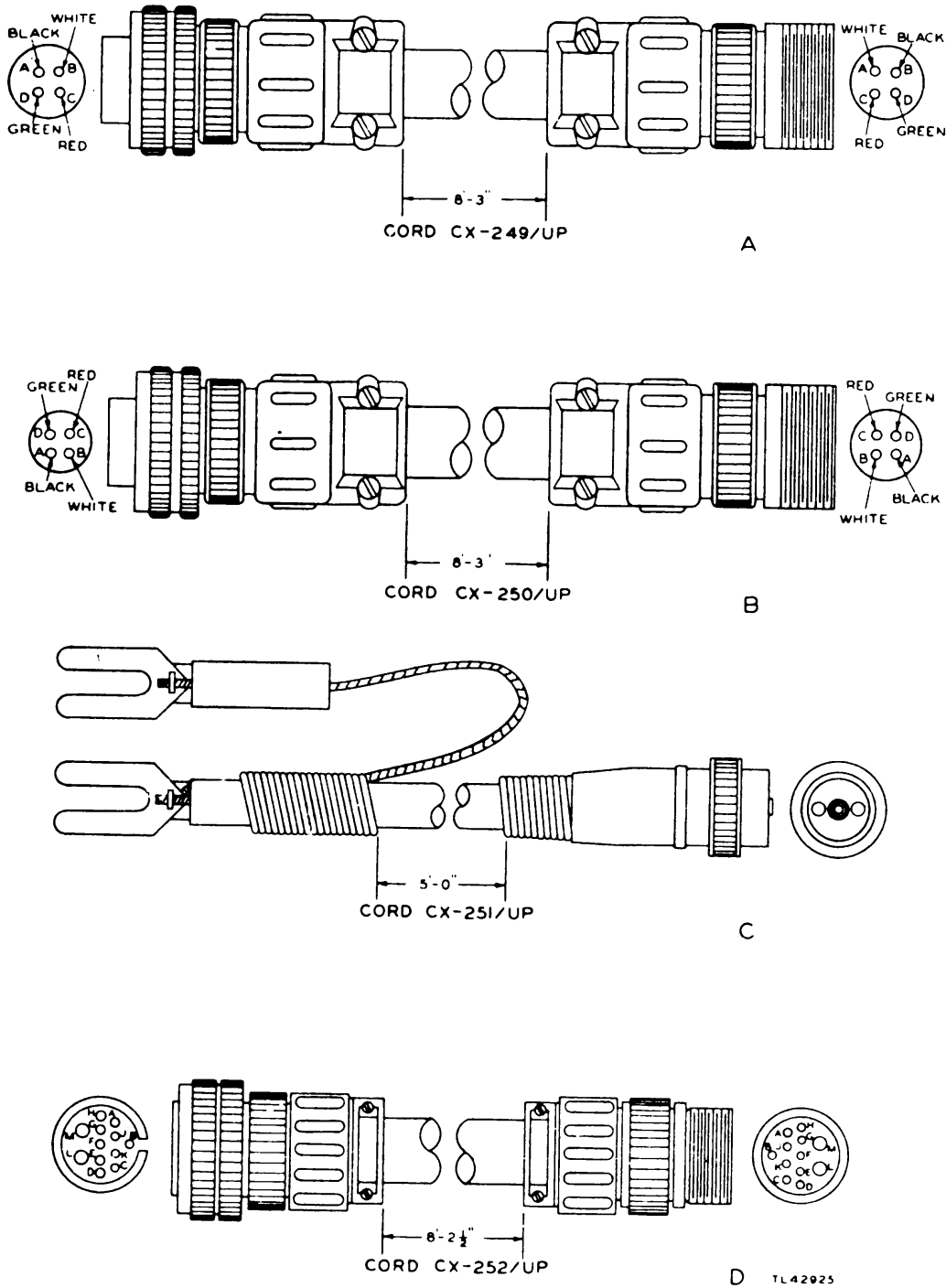

Figure 15. Details of Cords CX-249/UP, CX-250/UP, CX-251/UP, and CX-252/UP.

(3) Altitude Converter BC-1094 to Data Unit (Altitude) BC-1075.

(4) Plan Position Rectifier RA-69-B to Plan Position Unit BC-1058.

(5) Plan Position Unit BC-1058 to Plan Position Indicator BC-1092.

**m. Cord CX-253/UP (fig. 16-A).** This cord is an 8-foot 2½-inch length of General Electric type CW-1273, 14-conductor cable, or the equivalent. It is terminated at one end with a plug Amphenol AN-3106-28-8S and at the other end with receptacle Amphenol 97-5103-28-8P. This cord is used to connect the following components:

(1) Tracking Unit BC-1090 to Position Indicator BC-1076.

(2) Plan Position Unit BC-1058 to Plan Position Rectifier RA-69-B.

(3) Plan Position Indicator BC-1092 to Plan Position Unit BC-1058.

**n. Cord CX-254/UP (fig. 16-B).** This cord is an 8-foot length of single-conductor cable type CW-1125 as made by General Electric Company, or the equivalent. It is terminated at one end with a plug Amphenol AN-3106-14S-4S type 102 and at the other end with a receptacle Amphenol 97-5103-14S-4P. Six of these cords are provided to connect the following components:

(1) Automatic Tracking Unit BC-1086 to Radio Receiver BC-1056.

(2) Range Unit BC-1062 to Driver Unit BC-1080.

(3) Range Unit BC-1062 to Plan Position Unit BC-1058.

(4) Range Unit BC-1062 to Indicator BC-1088.

(5) Range Unit BC-1062 to Radio Receiver BC-1056.

(6) Radio Receiver BC-1056 to Amplifier BC-1078.

(7) Radio Receiver BC-1056 to Amplifier BC-1074.

(8) Indicator BC-1088 to Data Panel PN-22.

(9) Altitude Converter Rectifier RA-70-B to Altitude Converter BC-1094.

(10) Altitude Converter BC-1094 to Data Panel PN-22.

(11) Altitude Converter BC-1094 to Data Unit BC-1075.

**o. Cord CX-255/UP (fig. 16-C).** This cord is a 5-foot 2-inch length of single-conductor cable type CW-1115A as made by General Electric Company, or the equivalent. It is terminated at one end with a plug Amphenol AN-3157-6 and at the other end with two spade terminals. This cord is used with the test oscilloscope.

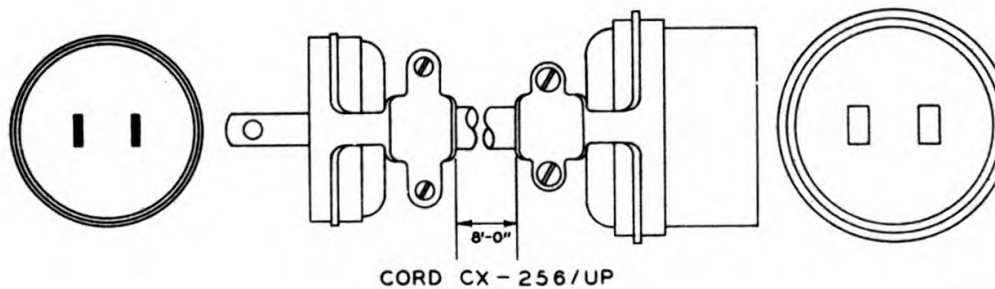
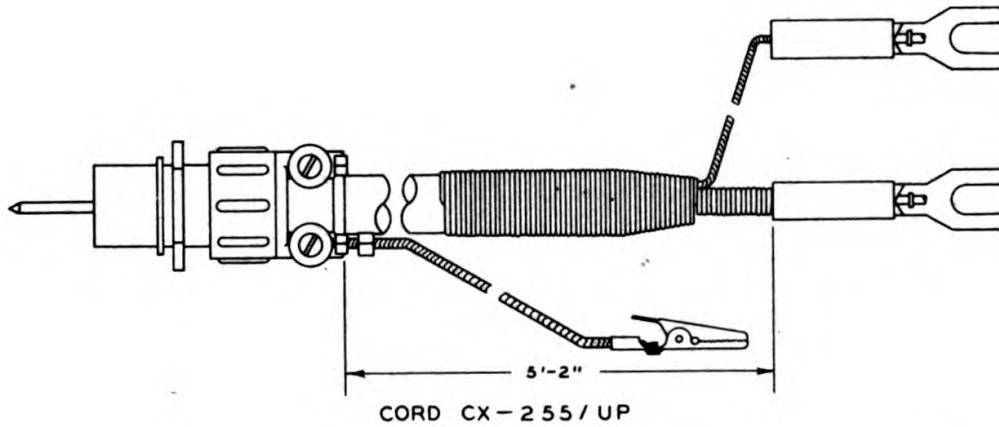
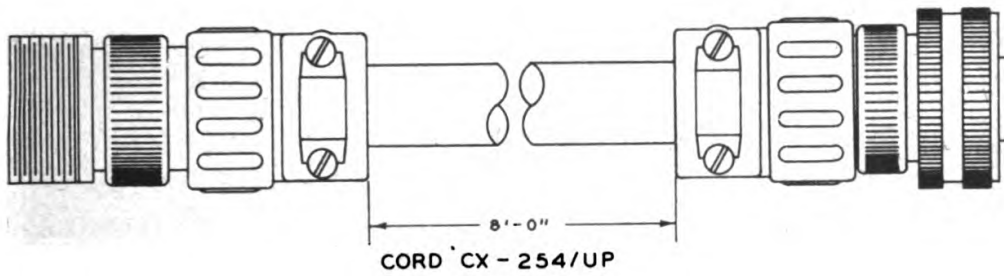
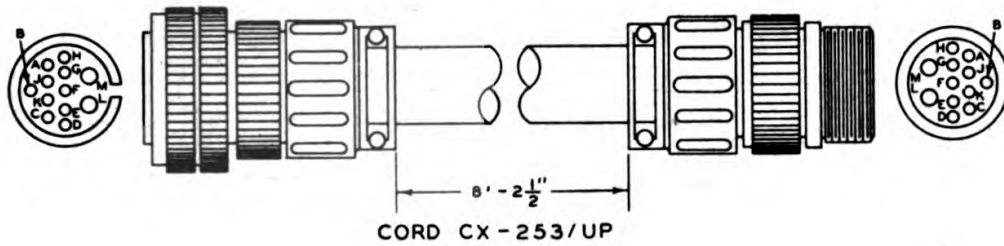

TL 42926

**Figure 16. Details of Cords CX-253/UP, CX-254/UP, CX-255/UP, and CX-256/UP.**

**p. Cord CX-256/UP (fig. 16-D).** This cord is an 8-foot length of two-conductor Cordex type S cable as made by General Electric Company, or the equivalent. It is terminated at one end with a General Electric plug No. 2720 and at the other end with a General Electric plug No. 2721. Two of these cords are provided to connect the following components:

- (1) Range Rectifier RA-72-B to the a-c source of power.
- (2) Receiver Rectifier RA-66-B to the a-c source of power.
- (3) Altitude Converter Rectifier RA-70-A to the a-c source of power.
- (4) Field Rectifier RA-71-B to the a-c source of power.
- (5) Plan Position Rectifier RA-69-B to the a-c source of power.
- (6) Local Oscillator BC-1096 to Modulator BC-984.

**q. Cord CX-257/UP (fig. 17-A).** This cord is an 8-foot 2½-inch length of 22-conductor cable type CW-1273 as made by General Electric Company, or the equivalent. It is terminated at one end with a plug Amphenol AN-3106-36-1P type 102 and at the other end with receptacle Amphenol 97-5103-36-1S. This cord is used to connect the following components:

- (1) Azimuth and Elevation Tracking Unit BC-1090 to Junction Box JB-71.
- (2) Range Indicator BC-1088 to Range Rectifier RA-72-B.
- (3) Position Indicator BC-1076 to Positioning Control Unit BC-1085.

**r. Cord CX-258/UP (fig. 17-B).** This cord is an 8-foot 2½-inch length of 22-conductor cable type CW-1273 as made by General Electric Company, or the equivalent. It is terminated at one end with a plug Amphenol AN-3106-36-1S type 102 and at the other end with a receptacle Amphenol 97-5103-36-1P. This cord is used to connect the following components:

- (1) Range Rectifier RA-72-B to Range Indicator BC-1088.
- (2) Position Indicator BC-1076 to Junction Box JB-71.

**s. Cord CX-259/UP (fig. 17-C).** This cord is an 8-foot 3-inch length of single-conductor cable type CW-1115A as made by General Electric Company, or the equivalent. It is terminated at one end with a plug Amphenol AN-3106-18-16P type 102 and at the other end with a receptacle Amphenol AN-5103-18-16S type 102. This cord is used to connect the following components:

- (1) Range Rectifier RA-72-B to Range Indicator BC-1088.
- (2) Plan Position Rectifier RA-69-B to Plan Position Indicator BC-1092.

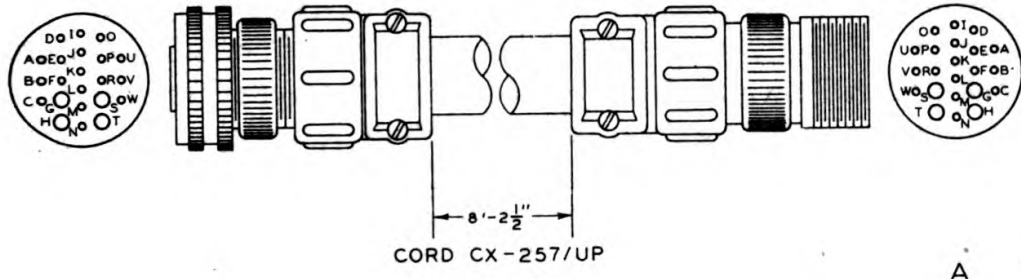

A

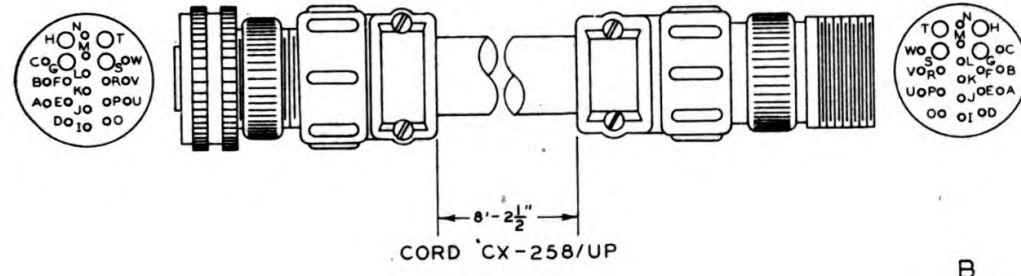

B

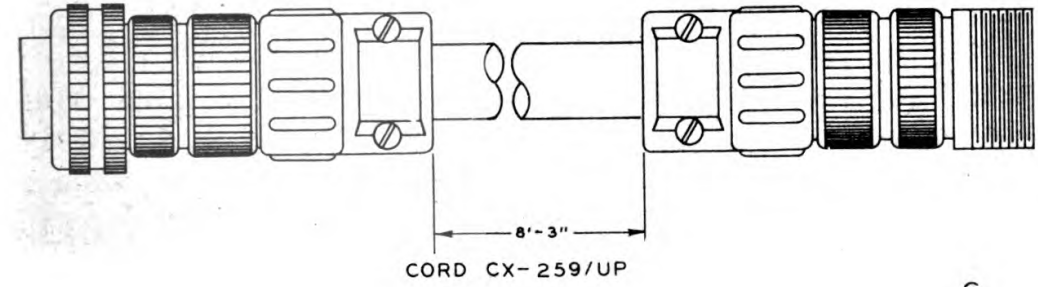

C

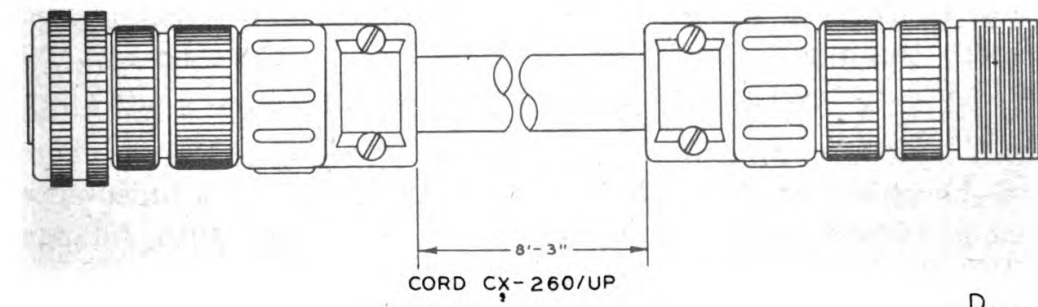

D  
TL 42927

Figure 17. Details of Cords CX-257/UP, CX-258/UP, CX-259/UP, and CX-260/UP.

**t. Cord CX-260/UP (fig. 17-D).** This cord is an 8-foot 3-inch length of single-conductor cable type CW-1115A as made by General Electric Company, or the equivalent. It is terminated at one end with a plug Amphenol AN-3106-18-16S type 102 and at the other end with a receptacle Amphenol AN-5103-18-16P type 102. Two of these cords are provided to connect the following components:

- (1) Range Indicator BC-1088 to Range Rectifier RA-72.
- (2) Range Indicator BC-1088 to Data Panel PN-22.
- (3) Plan Position Indicator BC-1092 to Plan Position Rectifier RA-69.

**u. Cord CX-261/UP (fig. 18-A).** This cord is a 6-foot 10-inch length of single-conductor cable type CW-1125 as made by General Electric Company, or the equivalent. It is terminated at one end with a test prod ICA No. 390B and at the other end with a special connector assembly. This cord is used with the test oscilloscope.

**v. Cord CX-262/UP (fig. 18-B).** This cord is an 8-foot length of single-conductor cable type 8421 as made by Belden Manufacturing Company, or the equivalent. It is terminated at one end with a plug Amphenol No. 80M and at the other end with a plug Amphenol No. 80F. This cord is used to connect Remote Video Amplifier BC-1074 to Range Indicator BC-1088.

**w. Cord CX-263/UP (fig. 18-C).** This cord is an 8-foot length of single-conductor cable type 8421 as made by Belden Manufacturing Company, or the equivalent. It is terminated at one end with a plug Amphenol No. 80M1 and at the other end with a plug Amphenol No. 80F1. This cord is used to connect Field Rectifier RA-71-B to Plan Position Unit BC-1058.

## **16. ADAPTERS.**

**a. Adapter M-358 (fig. 19).** This adapter is a T-type connector as made by Selectar Manufacturing Company. It is used to connect Dummy Antenna TS-208/MPM and Test Antenna TS-210/MPM to the receiver of Radio Equipment RC-184 for alignment purposes.

**b. Adapter M-359 (fig. 19).** This adapter is a video-type, male to female, right-angled connector. It is used with Adapter M-358 for alignment of the radio receiver. It connects Socket SO-239 and Plug PL-259. The male portion of the adapter has a coupling unit to fit Socket SO-239.

**c. Adapter U-18/UP.** This adapter has a male plug on one end and a female receptacle having 19 contacts on the other end.



It plugs into either the A- or B-receptacle on Data Panel PN-22-A or PN-22-B in order to connect the selsyn excitation jumper cable to the data panel when the radar set is operated without a gun director.

**d. Crystal Adapter UG-119/UP (fig. 19).** The crystal adapter has a type N plug on one end and a Socket SO-239 on the other end. The adapter serves as a holder for crystal 1N21-B which is used in Echo Box TS-207/UP.

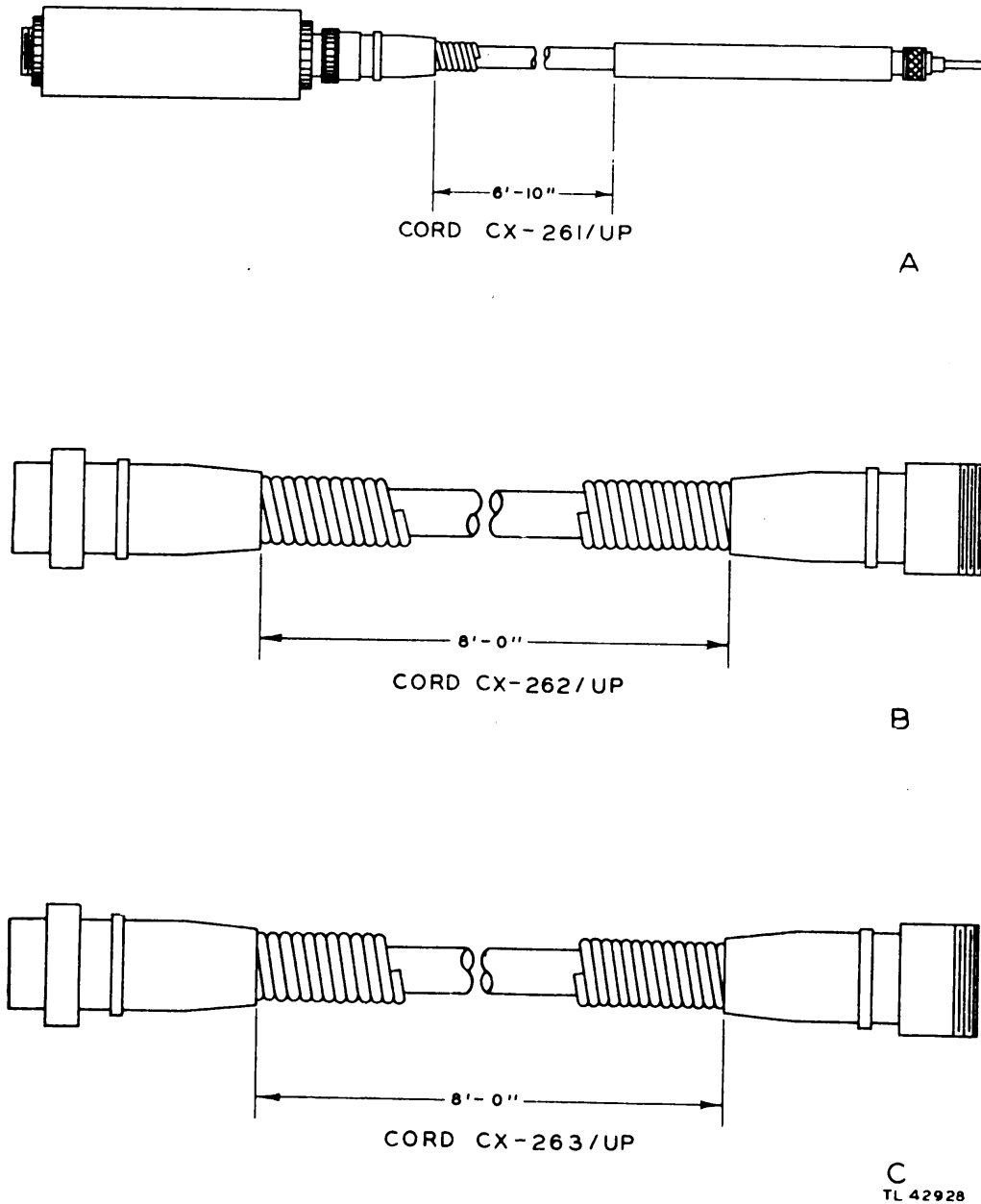

Figure 18. Details of Cords CX-261/UP, CX-262/UP, and CX-263/UP.

**e. Adapter for I-f Alignment.** The adapter supplied for use with the signal generator for i-f alignment has a type N jack UG( ) connector on one end and two binding posts on the other end. One binding post is red, marked 'SIGNAL INPUT'; the other is black, marked GROUND. The type N jack is marked OUTPUT. Inside (cover removable) are two 1-watt resistors in series with the center tap connected to the red binding post. One resistor is 17 ohms and is connected between the black binding post and ground. The other resistor is 300 ohms and is connected to the center contact of the type N jack. A 12-mmf fixed bypass capacitor is connected between the center contact and ground. This adapter is necessary to match the low-impedance output of the signal generator to the higher impedance of approximately 300 ohms of the i-f input circuit.

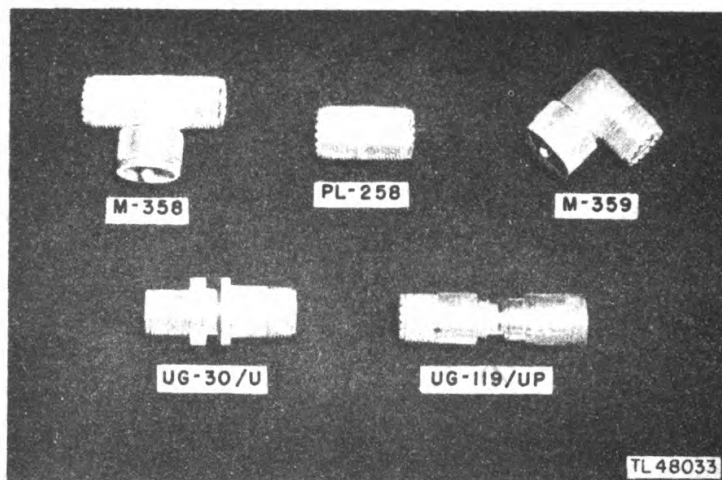

Figure 19. R-f and video adapters and connectors.

### 17. ANTENNA ASSEMBLY AS-23/AP (fig. 1).

Antenna Assembly AS-23/AP is an S-band dipole antenna with a type N receptacle at the base. It consists of two quarter-wave length rods connected to a coaxial line, with a half-wavelength reflector rod mounted behind the dipole. It is used with Echo Box TS-207/UP, Signal Generator TS-155B/UP, and Wavemeter Test Set TS-117/GP.

### 18. CABINET BE-96 (fig. 20).

Cabinet BE-96 is a universal steel cabinet for carrying Rectifiers RA-66-B, RA-69-B, RA-70-A, and RA-72-B. Four of these cabinets are provided.

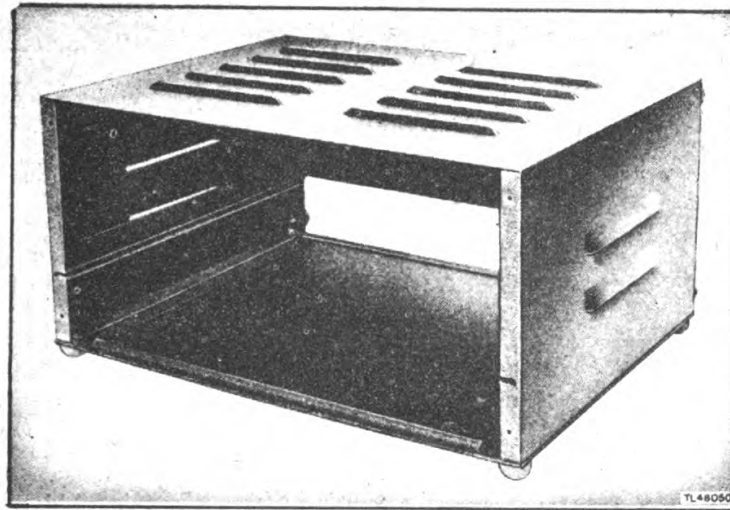

*Figure 20. Cabinet BE-96.*

### **19. NEON LAMPS AND CASE (figs. 21 and 22).**

The neon lamps are general utility lamps used to detect the presence of radio-frequency power in the various circuits of the radio set under test. Ten of these lamps are provided in a plastic carrying case.

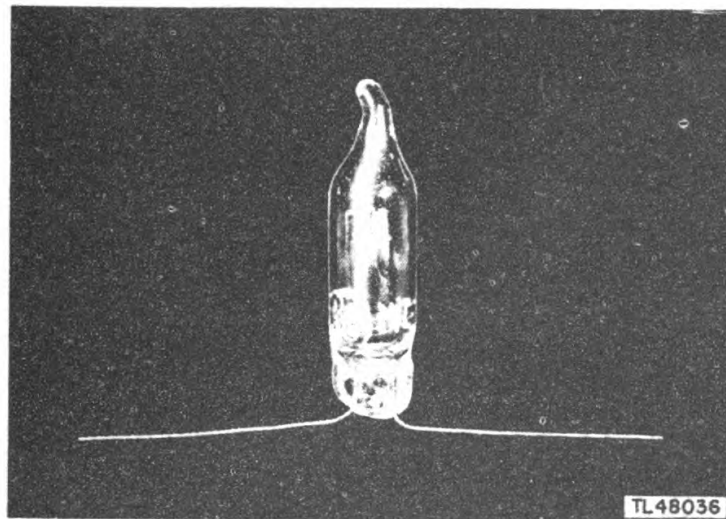

*Figure 21. Typical neon lamp.*

### **20. CHEST CH-273 (fig. 23).**

Two of these chests are provided for carrying the test equipment and for storing it when it is not in use. They are large wooden chests 42½ inches long, 22¼ inches wide, and 20¾ inches high.

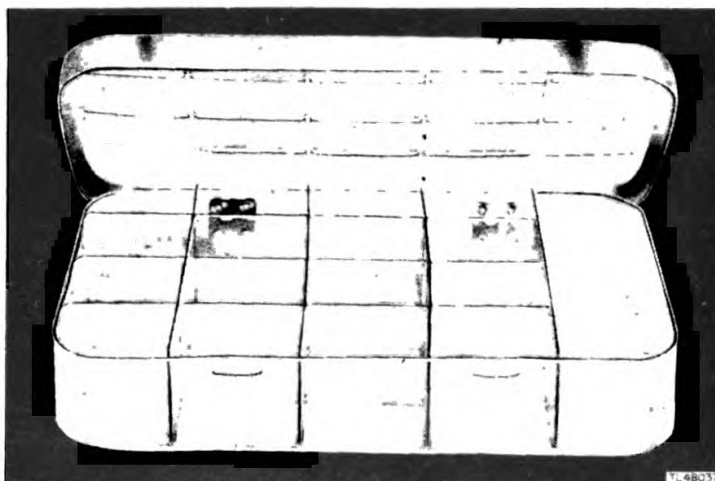

Figure 22. Carrying case for neon lamps.

**21. DUMMY ANTENNA TS-208/MPM (fig. 24).**

The dummy antenna is a connector Plug PL-259-A with a 47-ohm, 1-watt resistor soldered between the center pins and the shell inside of the connector. It is used in the alignment of Radio Receiver and Transmitter BC-1267-A of Radio Equipment RC-184.

**22. PLUG PL-258 (fig. 19).**

Plug PL-258 is a video-type cable connector with two female sockets. It fits the male portion of plug PL-259 and permits inter-connecting of cables fitting into Plug PL-259.

**23. RADIO-FREQUENCY JACK UG-30/U (fig. 19).**

This jack has a brass, silver-plated body, a type N receptacle at each end a  $\frac{5}{8}$  inch by 24, class 2 thread for panel mounting, and an impedance of 50 ohms. It is a pressurized jack which may be used to connect two r-f cables in order to provide increased cable length. Two jacks are supplied.

**24. TOOLS (fig. 25).**

The special tools are supplied for Pedestal MP-61; they are used as follows:

<i>Mfr No.</i>	<i>Purpose .</i>
SL-12	Open-end thin wrench for elevation adjustment arm nut.
SL-14	Wrench for spinner motor locknut.
SL-15	Special pronged wrench for spinner motor and generator seal nut.
SL-18	Special wrench for spinner motor bellows assembly.

<i>MJR No.</i>	<i>Purpose</i>
SL-19	Special wrench for spinner motor flange and longer screws.
SL-20	Special wrench for potentiometer gear holder.
SL-21	Special wrench for potentiometer gear nut.
SL-22	Coupling puller for power motor.

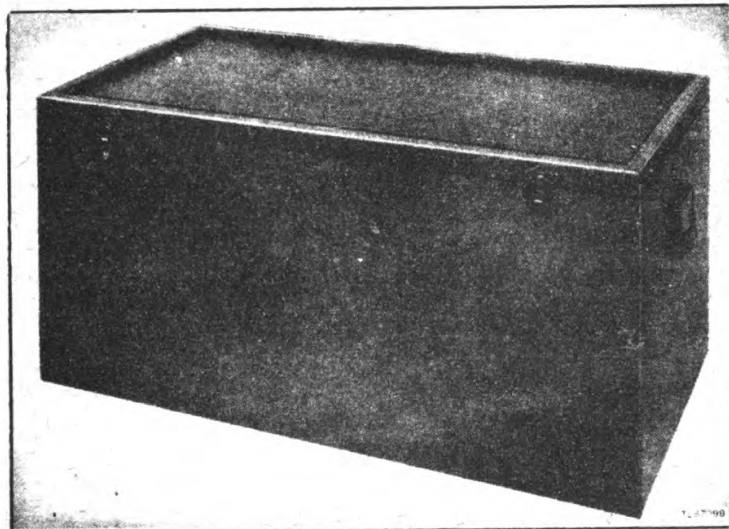

*Figure 23. Chest CH-273.*



*Figure 24. Dummy Antenna TS-208/MPM.*

## **25. TERMINAL BOX J-74/MPM (figs. 26 and 27).**

Terminal Box J-74/MPM is a small steel box containing a 2-microfarad, 600-volt, oil-filled capacitor shunted across the input connector. At one end of the box is a video-type Socket SO-239 and at the other end are two thumbscrew-type terminals. This terminal box is used to connect the output of the Crystal Adapter UG-119/UP used with Echo Box TS-207/UP to a universal-type test meter.

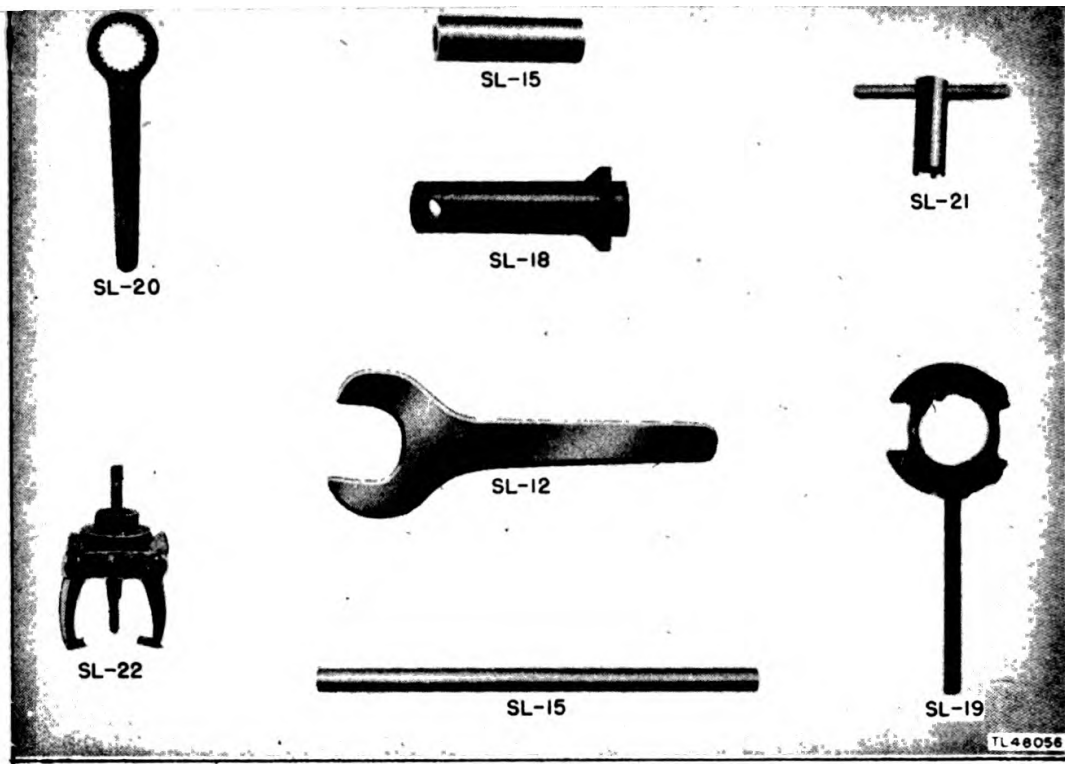

Figure 25. Tools used with Test Set AN/MPM-2.

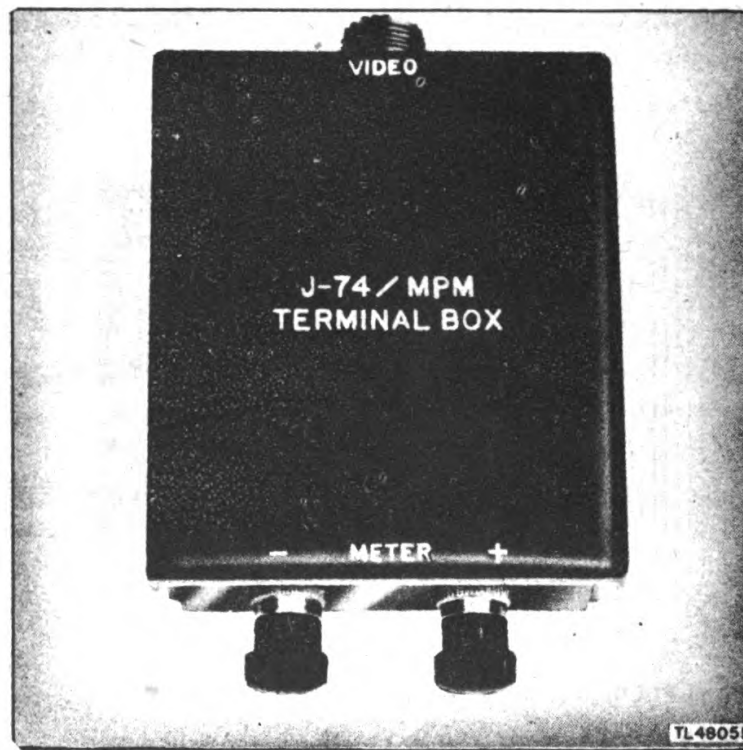

Figure 26. Terminal Box J-74/MPM.

## 26. TEST ANTENNA TS-210/MPM (fig. 28).

This antenna consists of an Adapter M-359 with a cap on the female end, and a silver-plated steel rod 4 inches long with a phenolic knob 5/16 inch in diameter cemented on one end. The



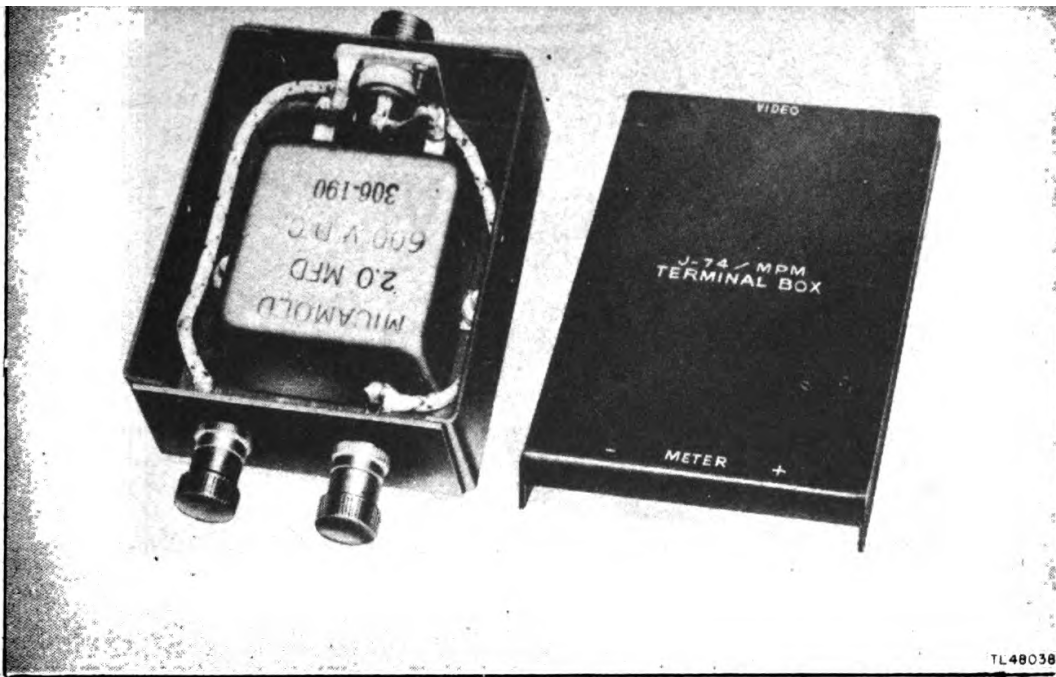

Figure 27. Terminal Box J-74/MPM, cover removed.

other end of the rod goes through a hole drilled in the cap and is soldered to the center contact of the adapter. The antenna is used in conjunction with Adapter M-358 and Dummy Antenna TS-208/MPM to align Radio Receiver and Transmitter BC-1267-A.

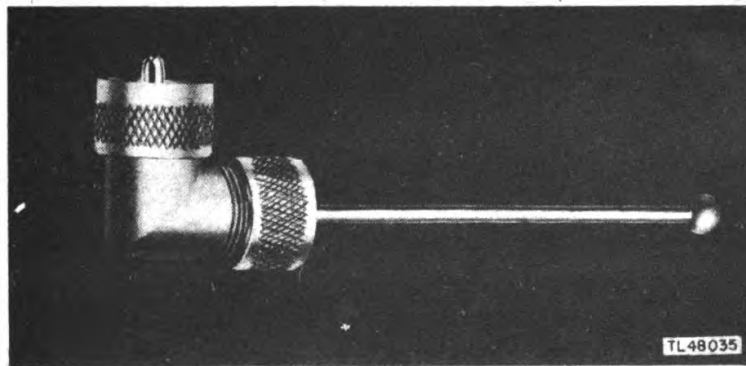

Figure 28. Test Antenna TS-210/MPM.

## 27. THERMOMETER AND CASE.

The thermometer consists of a glass tube with a mercury element which is contained in a metallic case 14 inches long and approximately  $\frac{3}{8}$  inch in diameter. The metal case has an aperture to enable temperature readings over the range of  $-40$  to  $120^{\circ}$  F. The glass tube is replaceable by unscrewing the cap from the end of the case. This cap is lined with a special shock-absorbing material.

## **SECTION II**

# **INSTALLATION AND OPERATION**

---

### **28. GENERAL.**

A description of the installation and operation of the test equipment contained in Test Set AN/MPM-2 is given in this section. The procedures relate to use of the test equipment with Radio Set SCR-584 and Radio Equipment RC-184. Refer to the technical manual for additional information about specific test instruments or to the technical operations or service manual for the equipment being tested.

### **29. ECHO BOX TS-207/UP.**

**NOTE:** Complete information on the use of Echo Box TS-207/UP is given in TM 11-1212 and TM 11-1524.

#### **a. Installation of Antenna Assembly AS-23/AP (fig. 29).**

- (1) Mount the antenna assembly on its support rod.
- (2) Mount the rod and antenna on the bracket on the left wall near the top rear corner, outside of the trailer, with the reflector rod (the T-section fastened to the outer conductor) away from the radar antenna. There must be no conducting material between the pick-up antenna and the radar antenna.
- (3) Turn the radar antenna until it directly faces the pick-up antenna.
- (4) With the SPINNER MOTOR switch OFF, rotate the radar antenna by hand until the dipole inside is horizontal. The unpainted section of the plastic cap around the dipole should be uppermost, and inspection through this clear section should reveal the dipole in a horizontal plane. When the set-up is completed, the radar antenna dipole and the pick-up antenna dipole should be exactly parallel.

**b. Operation.** Before making any measurements, operate the radar set for at least 10 minutes.



(1) *Preparation for use.*

(a) Connect the echo box to the pick-up antenna support rod, using Cord CG-70/MPM or Cord-135/UP.

(b) Connect Crystal Adapter UG-119/UP directly to the output connector of the echo box, and to Terminal Box J-74/MPM with Cord CG-71/MPM.

(c) Connect a universal test meter supplied with Radio Set SCR-584 to the thumbscrew terminals on the terminal box and adjust the meter to read current.

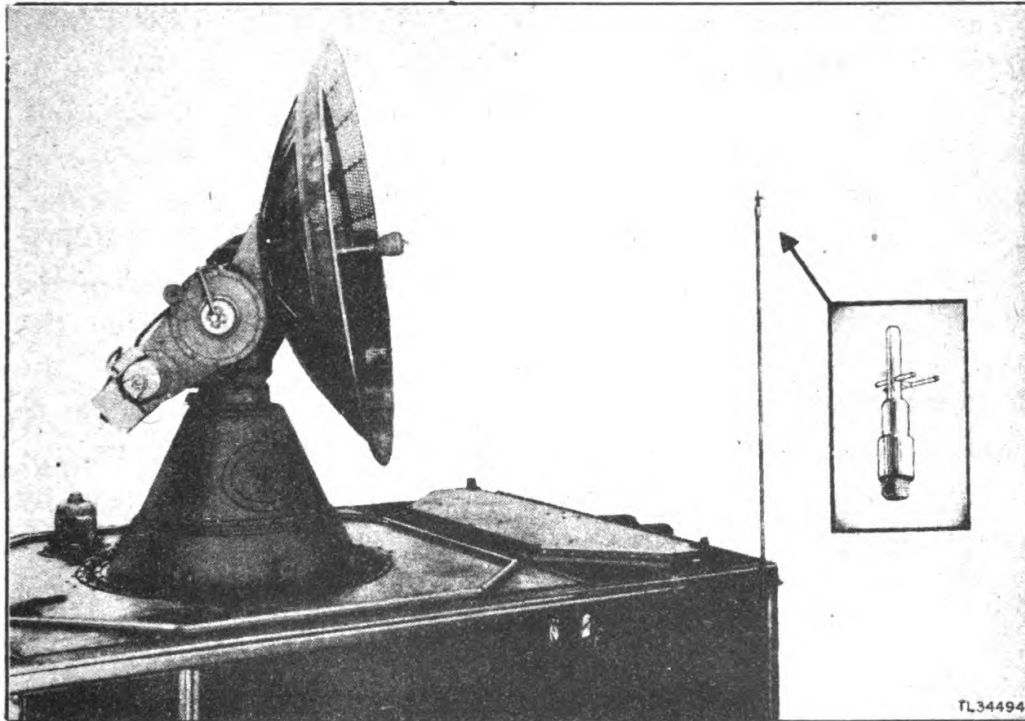

Figure 29. Antenna Assembly AS-23/AP mounted on van.

(2) *R-f System Tune-up Procedure.*

(a) With the pick-up dipole installed as outlined in subparagraph a and the radio set operating with the spinner motor switch OFF, tune the echo box until a deflection is observed on the echo-box indicator meter.

(b) Tune the echo box until this deflection is at maximum. This tunes the echo box to the frequency of the transmitter.

(c) Note and record the scale and tuning knob readings of the echo box. The first two significant figures of the reading (0-25) are found by the position of the indicator under the lucite scale on the tuning-knob barrel. Fractional divisions are read from the circumference of the tuning knob. Determine the frequency by using the dial division calibration-factor chart. The correct fre-

quency may be found by adding the constant 2,700 to the calibration factor as follows:

$$\text{Correct frequency} = 2,700 + \text{calibration factor.}$$

(d) With the receiver gain high enough so that noise may be seen on the range oscilloscopes, and with the receiver AGC switch in the OFF position, observe the ringing time of the echo box on the 32,000- and 2,000-yard range oscilloscopes. Even with the radio set completely out of tune, some apparent widening of the main pulse should be observed as the echo box is tuned to resonance. Move the parabola in azimuth and elevation by manual control until this ringing time is at maximum.

(e) Adjust the local oscillator tuning and the local oscillator reflector voltage for maximum ringing time as observed on the range oscilloscopes. Loosen the T/R box tuning screw locknut and tune the T/R box for maximum ringing time. Lock the T/R box tuning screw in place carefully using a wrench to tighten the locknuts. They must be more than fingertight. Be sure that the ringing time stays at the maximum obtainable value after the T/R box tuning screws have been locked. It may be possible to retune the local oscillator slightly to increase the ringing time.

(f) If it is possible to obtain a still longer ringing time by retuning the echo box, the following investigation should be made. The maximum ringing time observed on the range scopes should coincide with the maximum deflection of the echo-box indicator meter. This may be checked by slowly tuning the echo box through resonance. If the two maxima do not coincide, the system is not tuned for best performance. This may be explained as follows: With the box tuned for maximum deflection of the indicator meter, it is tuned to the transmitter frequency. If, however, the receiving system—principally the T/R box and local oscillator—is not tuned to the transmitter frequency, the longest ringing time observable on the range tubes will occur when the box is tuned to a frequency between that of the transmitting and receiving systems. When the box is slightly off resonance, the oscillations cannot build up to the highest value during the pulse and the indicator meter reading is less. However, the frequency that is sent back to the radar set during the ringing time is more nearly that which the receiver is tuned to accept.

(g) Tune the system until the two maxima mentioned in subparagraph (f) above coincide.

(h) Determine the ringing time by measuring the range to the point where the echo-box signal just begins to unite with the

noise. This measurement is independent of the receiver gain as long as sufficient noise is visible.

(i) In measuring the echo-box ringing time, make sure that it is the echo-box ringing time and not a signal or block of signals that is being checked. This can be determined by tuning the local oscillator and noting whether or not the ringing time goes back and forth. Signals change in amplitude but not in range when this is done. The echo-box signal changes in range.

(j) To obtain an accurate result make four measurements of the ringing time and average them. By this method ringing time can be measured to at least  $\pm 100$  yards. If more than one person will be using an echo box and its accessories, these persons should practice together so that their measurements of ringing time will agree. Since the receiver gain must be standardized for accurate measurements, ringing time should not be observed on the PPI scope.

(k) Before proceeding with normal operation of the radio set, detune the echo box so that no ringing time shows on the range scope. If this is not done, the set will be blocked in the azimuth direction of the echo-box dipole and out of the range of the maximum ringing time.

### (3) *Measurement of R-f System Performance.*

(a) Set up the echo-box dipole as outlined in subparagraph a above.

(b) Tune the echo box and position the reflector of the radio set until the maximum ringing time is obtained.

(c) Record the value of this ringing time in the log book and check it against values previously obtained.

(d) Repeat the measurement several times, noting each reading.

(e) If the average of these readings is not within 100 yards of the average of previous readings, the system performance has changed.

### (4) *Measurement of Transmitter Frequency.*

(a) Set up the echo box with the dipole antenna as previously outlined in subparagraph a above.

(b) Tune the echo box and position the antenna of the radio set until maximum deflection is obtained on the echo-box indicator meter. Be sure that the center of strongest maximum is read. Two small peaks are customarily found close on either side of the main peak.

(c) Note and record the scale and tuning-knob readings of the echo box (subpar. (1)(c) above).

(5) *Measurement of Transmitter Frequency Spectrum.*

(a) Align the echo-box dipole with the dipole of the radar antenna and position the reflector for maximum ringing time as outlined previously.

(b) With the system tuned, record the echo-box dial reading and the meter reading as the echo box is tuned slowly through the transmitter spectrum.

(c) Plot the meter reading against the dial reading.

(d) In a continuous-wave transmitter the oscillations are at one frequency—the carrier frequency. Since the radar transmitter output is modulated in the form of pulses, however, energy will be transmitted in the side bands, that is, in frequencies above and below the carrier frequency.

**NOTE:** For additional information on the measurement of the transmitter frequency spectrum, refer to TM 11-1524, appendix D.

(6) *Measurement of Local Oscillator Frequency.*

**NOTE:** It is recommended that the Wavemeter Test Set TS-117/GP be used for measuring local oscillator frequency (par. 35).

(a) In general, measurement of the local oscillator frequency is unnecessary. The tubes are preset to operate within the bandwidth of Radio Set SCR-584. If it is desired to measure the frequency, take care that the echo box does not “pull” the frequency of the local oscillator. Use a long piece of test cable or join two lengths so that there is considerable attenuation between the local oscillator and the echo box. It may be necessary to use a short cable to determine the approximate frequency or to determine whether or not the tube is oscillating; then change to the longer length of cable for actual measurement. In any case, the deflection on the echo-box meter should be in the order of one-quarter of full scale, or less when the meter switch is in the most sensitive position and the echo box is tuned for maximum deflection.

(b) Connect the input of the echo box to the MONITOR jack on the front of the local oscillator panel using Cord CG-70/MPM. Be sure that the connector behind the local oscillator panel is fastened to the local oscillator tube.

(c) Tune the echo box for maximum deflection on the echo-box meter.

(d) Note and record the scale and the tuning-knob read-

ings and determine the wavelength by consulting the chart as previously outlined.

(e) When this operation has been completed, remove the connection that couples the local oscillator klystron tube to the output jack on the front of the local oscillator panel.

### 30. FLUXMETER TS-15A/AP (fig. 30).

**NOTE:** Complete information on the use of Fluxmeter TS-15A/AP is given in TM 11-2559.

**a Preparation for use.** Make the following adjustments on the gauss meter and the probe meter (fig. 2) before any measurements are made with the instrument.

(1) Remove the probe unit from the storage recess and place it on a flat surface.

(2) Align the probe meter pointer with the black mark on the meter scale by adjusting the zero-set screw. The probe meter pointer and its image in the mirror scale will coincide when the pointer is directly above the black mark. The zero-set screw is located beneath the knurled mounting bolt for the yoke.

**CAUTION:** Never make the above adjustment of the probe meter pointer with the probe unit in a magnetic field.

(3) Set the range selector switch to the C position.

(4) Set the NORMAL-ZERO SET switch in the NORMAL position.

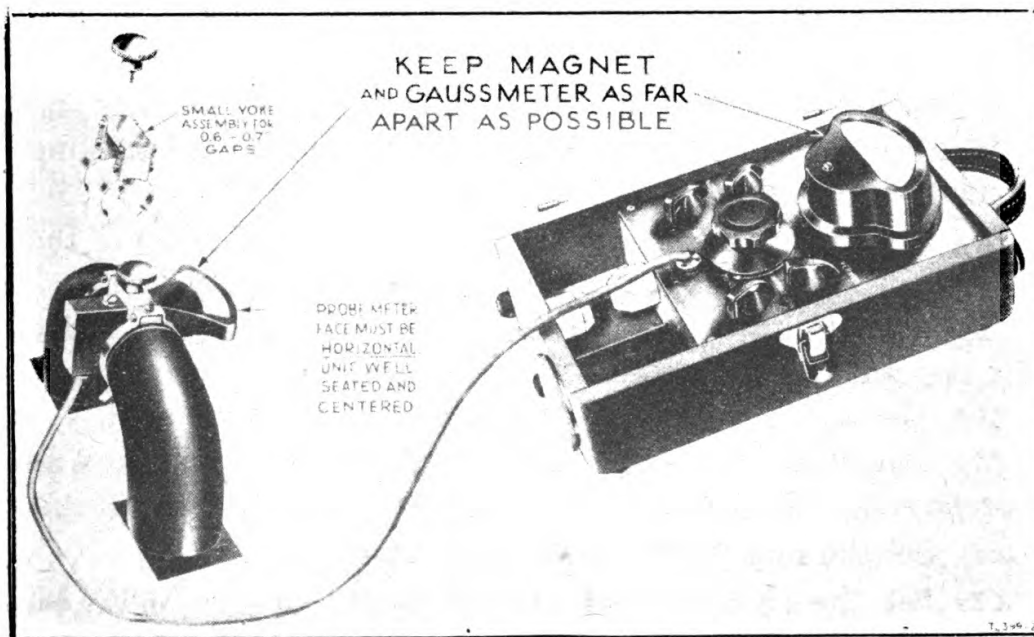

Figure 30. Use of Fluxmeter TS-15A/AP.

(5) Turn the instrument on by rotating the OFF-MEASURE control and continue turning this control in a clockwise direction until the gauss meter pointer is aligned with the mark at 48 on the C scale.

(6) Turn the NORMAL-ZERO SET switch and hold it to the ZERO SET position. The gauss meter pointer should be aligned with the mark at 96 on the C scale.

(7) If the gauss meter pointer is not aligned with the mark at 96 on the C scale, note the position of the pointer in respect to the mark at 96. Then, turn the zero-adjusting screw on the front of the gauss meter to displace the pointer an equal amount on the opposite side of the 96 mark.

(8) Release the NORMAL-ZERO SET switch and readjust the OFF-MEASURE control to return the meter pointer to the mark at 48 on the C scale.

(9) Repeat steps (6) and (7) above until the gauss meter pointer is aligned with marks 48 and 96 on the C scale for the two positions of the NORMAL-ZERO SET switch.

**b. Operation (fig 30).** Instructions for measuring the flux density of the oscillator field magnet are given below:

(1) Open the modulator and remove the transmitting oscillator. See TM 11-1524, paragraph 917.

**CAUTION:** Avoid jarring the magnet or allowing it to come in contact with any magnetic material. The magnetic field may be distorted enough to impair the performance of the oscillator and make it necessary to send the magnet to a higher echelon to be remagnetized.

(2) Remove the field magnet from the modulator case and set it upright on two blocks on the work bench. Avoid striking or turning the spacing adjustment knob.

(3) Attach the large mounting yoke to the probe meter of the fluxmeter and fasten it with the nickel-plated mounting bolt.

(4) With the OFF-MEASURE control in the OFF position insert the probe unit between the pole faces of the magnet; be sure that the unit is well seated, well centered, and horizontal.

(5) Place the fluxmeter cabinet as far from the magnet as the probe cable will permit.

(6) Set the range selector switch on A.

(7) Set the NORMAL-REVERSE switch to the NORMAL position.

(8) Turn the instrument on and rotate the OFF-MEASURE

control slowly in the clockwise direction. At the same time watch the probe meter.

(9) If the pointer of the probe meter deflects backward, turn the OFF-MEASURE control to the OFF position, set the NORMAL-REVERSE switch to the REVERSE position, and repeat the operation described in step (6) above.

(10) Advance the OFF-MEASURE control until the pointer of the probe meter is aligned with the red mark on its scale or until the gauss meter pointer reaches full-scale deflection. If the latter occurs, return the OFF-MEASURE control to the OFF position, set the range selector switch to the next lower range, and repeat the operation. Use the VERNIER control to obtain finer adjustment of the probe meter pointer.

(11) With the probe meter pointer set accurately to the red mark on its scale, the flux density in gaussses can be read directly on the gauss meter scale. Read the value of the flux density on the A scale and multiply the reading by 100.

(12) After all measurements have been made, turn the OFF-MEASURE control fully counterclockwise until the switch snaps in the OFF position. Be sure that the instrument is turned off; otherwise, there will be a constant drain on the battery, which will soon destroy its usefulness. Remove the probe unit from the magnet and store the unit and cable in the recess provided in the fluxmeter case. Replace the cover and return the instrument to its proper place.

(13) Replace the magnet and the magnetron in the modulator. See TM 11-1524, paragraph 917.

### **31. POWER METER TS-125/AP.**

**NOTE:** Complete information on the use of Power Meter TS-125/AP is given in TM 11-1217.

#### **a. Installation of Antenna AT-67/AP.**

**CAUTION:** Radio-frequency coupling between the power meter and the radar system must be done through high attenuation, such as is obtained with the pick-up antenna furnished with the meter. NEVER CONNECT THE INPUT CABLE DIRECTLY TO THE R-F PLUMBING.

(1) Connect the pick-up antenna to the support rod used for the echo-box pick-up dipole (subpar. 29a).

(2) Mount the rod and antenna on the bracket on the outside of the left wall of the trailer near the top rear corner with

the front of the pick-up antenna facing the radar antenna. There must be no conducting material between the pick-up antenna and the radar antenna.

(3) Turn the radar antenna until it faces the pick-up antenna directly.

(4) With the SPINNER MOTOR switch OFF, rotate the radar antenna by hand until the dipole, inside is horizontal. The unpainted section of the plastic cap around the dipole should be uppermost, and inspection through this clear section should reveal the dipole in a horizontal plane.

### **b. Operation.**

#### *(1) Placing Power Meter in Operation.*

(a) Turn the switch ON by turning the balancing control clockwise.

(b) Advance the balancing control slowly until the meter needle moves up scale.

(c) Balance the meter to zero.

(d) Connect the 16-db attenuator to the r-f connector of the meter and to the cable connector at the bottom end of the pick-up antenna support rod. If more attenuation or length of cable is needed, connect the r-f cable furnished with the power meter between the attenuator and the antenna rod using Radio-Frequency Jack UG-30/U as an adapter (fig. 19).

**CAUTION:** Never connect both attenuator pads together or they will be damaged when sufficient power is introduced to cause full-scale deflection of the meter.

(e) If the power reading is below  $-7$  dbm, replace the 16-db attenuator with the 10-db attenuator.

(f) If the reading is still below  $-7$  dbm, remove the attenuator and connect directly to the power meter r-f connector.

#### *(2) Measuring Power Output.*

(a) Place the meter in operation as explained in subparagraph (1) above.

(b) Read the meter.

(c) Disconnect the meter from the r-f cable and check to see if the meter is still zeroed. If it is not, readjust the balance control and repeat the reading.

(d) Add the db attenuation of the pad and the 7 db attenuation of the r-f cable to the dbm reading obtained from the meter.



(e) For converting the average power in dbm to average power in watts, see TM 11-1217.

**NOTE:** This method of power measurement gives relative readings only on the average power output of the radar set. Readings should be taken when the set is known to be operating properly and at regular intervals. They should always be taken with the same power meter mounted in the same position, at the same time of day, and as nearly as possible under the same atmospheric conditions.

(3) *Measuring Antenna Pattern.*

(a) Place the meter in operation as explained in subparagraph (1) above.

(b) Rotate the antenna in steps of a few degrees at a time and record the meter reading in milliwatts at each step. The meter readings can then be plotted against the angle in degrees from the axis of the beam. This shows the variations between the power of radiation and the direction of the antenna. For further details and a sample diagram see TM 11-1217.

(4) *Measuring Local Oscillator Output.*

**NOTE:** The best method of determining the normal power output of the local oscillator is to make this measurement when the set is known to be operating properly.

(a) Balance the power meter.

(b) Using the 10-db attenuator and the r-f cable supplied with the power meter, connect the meter to the MONITOR jack on the front panel of the local oscillator.

(c) If the meter reading is below  $-7$  dbm, remove the attenuator and connect the cable directly to the r-f connector of the meter.

(d) If the radar crystal current is abnormally low and the local oscillator coupling is normal, a poor crystal detector is indicated.

## **32. RANGE CALIBRATOR I-223-A.**

**NOTE:** Information on the use of Range Calibrator I-223-A is given in TM 11-2528, TM 11-1332, and TM 11-1532.

### **a. Range Calibration of Control Unit BC-1268-A.**

(1) Set up the range calibrator and plug its a-c cord into the a-c line.

(2) Using one output cable, Cord CD-1101, connect the SYNCH jack of the calibrator to the SYNCH INPUT jack of the control unit.

(3) Using the second Cord CD-1101, connect the 1000 YD MARKERS jack of the calibrator to the VERTICAL INPUT jack of the control unit.

(4) Turn the STANDBY-OPERATE switch of the control unit to the STANDBY position.

(5) Turn on the power switch of the calibrator.

**NOTE:** If the crystal oscillator of the calibrator fails to start at extremely low temperatures, the calibrator case or the crystal holder should be jarred to start oscillation.

(6) Turn the INTERNAL-EXTERNAL switch to the EXTERNAL position.

(7) Turn the PULSE-SINE switch to the PULSE position.

(8) Rotate the SYNCH, PHASE, and DIVISION controls to their extreme clockwise positions.

(9) Turn the SWEEP RANGE switch to the 20K position.

(10) Turn the SENSITIVITY control to minimum.

(11) Adjust the SWEEP RANGE, HORIZONTAL GAIN, and HORIZONTAL CENTERING controls in the 20K YDS column until there are 15 range markers to the right of the range step, 4 or 5 markers to the left of the range step, and the ends of the sweep are about  $\frac{1}{8}$  inch from the edges of the mask.

(12) Rotate the RANGE control to zero range, then a little to the right to line up the *first* marker with the range step.

(13) Enter the number 0 in the first space of column 1 and the RANGE counter reading in the first space of column 2 in a table similar to table I below.

(14) Rotate the RANGE control farther to the right to line up the second marker with the range step.

(15) Enter the number 1 in the second space of column 1 and the RANGE counter reading in the second space of column 2 in the table.

(16) Continue taking readings and recording them in the table in the same manner throughout the range of the RANGE control.

(17) If it is desired, as indicated in the example, to skip readings of some of the markers, column 1 must show a jump of one for every marker omitted. In table I, for example, between 10 and 20 of column 1 there were nine markers for which no readings were taken.

(18) Fill in column 3 with the figures obtained by subtracting the first entry of column 2 from each succeeding entry of column 2. For example, 1,100 is derived by subtracting 400 from 1,500; 2,050 is derived by subtracting 400 from 2,450; etc.

(19) Fill in column 4 with the figures obtained by multiplying each of the readings in column 1 by 1,000.

(20) Fill in column 5 with the figures obtained by subtracting each entry in column 4 from the corresponding entry in column 3. This column shows the errors in the range measurements of the control unit at each range checked.

(21) If the error at any point exceeds 200 yards plus 0.3 percent of the range, the control unit needs adjustment. See TM 11-1532.

**TABLE I. EXAMPLE OF RANGE CALIBRATION.**

<i>Marker passed</i>	<i>Range (yards)</i>	<i>Range between initial and following markers</i>		<i>Error (yards)</i>
		<i>Measured</i>	<i>Exact</i>	
<i>1</i>	<i>2</i>	<i>3</i>	<i>4</i>	<i>5</i>
0	400	0	0	0
1	1,500	1,100	1,000	100
2	2,450	2,050	2,000	50
3	3,300	2,900	3,000	-100
4	4,200	3,800	4,000	-200
5	5,400	5,000	5,000	0
10	10,350	9,950	10,000	-50
20	20,300	19,900	20,000	-100
30	30,300	29,900	30,000	-100
40	40,200	39,800	40,000	-200
50	50,250	49,850	50,000	-150
60	60,300	59,900	60,000	-100
70	70,100	69,700	70,000	-300
80	80,200	79,800	80,000	-200
90	90,100	89,700	90,000	-300
99	99,000	98,600	99,000	-400

**b. Adjustment of Timing Coil in Control Unit BC-1268-A.**

(1) Set up the range calibrator and plug its a-c cord into the a-c line.

(2) With the output cable, Cord CD-1099, connect the SWEEP jack of the calibrator to the X-axis amplifier of the test oscilloscope.

(3) Turn on the power switches of the calibrator and the test oscilloscope.

(4) Turn on the BEAM switch of the oscilloscope.

(5) After the warm-up period, turn the COARSE FREQUENCY control of the oscilloscope to the OFF position and advance the X-axis amplifier VERNIER GAIN control to produce a trace about 3 inches long. If a trace 3 inches long cannot be obtained, advance the VERNIER GAIN control to maximum.

(6) Turn the SYNCH, PHASE, and DIVISION controls of the control unit to their extreme clockwise positions and turn the INT-EXT switch to the EXT position and the PULSE-SINE switch to the PULSE position.

(7) Connect the TIMING PULSES jack on the control unit to the Y-axis amplifier of the oscilloscope.

(8) Turn the Y-GAIN switch to the UNDER 25 V RMS position.

(9) Apply power to Radio Equipment RC-184.

(10) Rotate the RANGE controls to a range of about 90,000 yards.

(11) A pattern consisting of groups of similar curves above and below the sweep line should appear. The appearance of these curves should be as follows:

(a) If the RANGE control of the control unit is turned, the pattern should move in such a way that it appears to be a side view of a three-dimensional figure rotating about a vertical axis. The upper and lower portions of the pattern should move in opposite directions along the baseline. The appearance of the lower portion of the pattern is unimportant.

(b) The curves in the upper portion of the pattern should be combined into two fairly well-defined groups having the same shape and length and starting at the same place on the baseline, but having different amplitudes.

(c) A few of the curves in the upper portion of the pattern may be separated from the others in a horizontal direction along the baseline, but none should be farther away from the main groups than 8 to 10 divisions on the scale of the oscilloscope screen.

(12) If the pattern deviates from the description given in subparagraph (11) above, adjust the timing coil. For further details and illustrations of the oscilloscope patterns, see TM 11-1532.

(13) Turn the RANGE control to bring the pattern to a position with respect to the scale in front of the screen which can be observed and repeated easily.

(14) Observe the reading of the microseconds scale on the RANGE control dial.

(15) Turn the RANGE controls slowly in either direction counting the cycles of motion of the pattern until 10 cycles have occurred and reset the pattern at the position selected in subparagraph (13) above.

(16) The microsecond scale on the RANGE control dial should now read the same as before.

### **33. SIGNAL GENERATOR TS-343/U.**

**NOTE:** Complete information on installation and operation of Signal Generator TS-343/U is given in TM 11-1233.

The procedure for aligning the i-f sections of the receiving system of Radio Set SCR-584 is as follows:

#### **a. Setting up the Equipment.**

(1) Remove the receiver, local oscillator, remote video amplifier units, and their interconnecting cables from the control rack and set them on the test bench.

(2) Set up the signal generator, Receiver Rectifier RA-66-B, and the test oscilloscope on the test bench.

(3) Plug the power cords of the signal generator and the test scope into the a-c line and turn the power switches ON.

(4) On the receiver unsolder the end of resistor R713 which is connected to the small terminal strip and disconnect it from the terminal (TM 11-1524, fig. 235 or 238).

(5) Temporarily connect the free end of R713 to the terminal strip end of resistor R710 with a short jumper.

(6) Close the AGC on-off relay (K701) manually and wedge it in the closed position with a folded piece of paper or by some other convenient means (TM 11-1524, fig. 235 or 238).

(7) Make the following interconnections between the units:

(a) Connect the rectifier, receiver, preamplifier, and remote video amplifier units together using the cables from the control rack. If extra length is required in any case, use the proper cable from the test set (par. 15). No connection need be made to J1801 on the local oscillator chassis because the local oscillator is not used in the alignment procedure.

(b) Connect the rectifier to the a-c line using Cord CX-256/UP.

(c) Turn on the power switch on the rectifier and allow at least 15 minutes for the equipment to warm up.

(d) Connect the signal generator output cable to input plug P1951 on the i-f preamplifier using the special adapter provided for use with the signal generator.

(e) Using Cord CX-251/UP, connect the vertical input of the test scope to the output jack J702 on the receiver.

(f) All the other connectors on the units which normally connect to other chassis in the control rack are left unconnected.

(g) Interconnect all of the chassis and test instruments with a suitable ground wire and ground the wire securely to a convenient point.

### **b. Adjustment of Controls.**

(1) Pull the RANGE SWITCH on the signal generator all the way out and adjust the OUTPUT control to bring the pointer on the output meter to the red mark.

(2) Find the correct scale reading for a frequency of 30 megacycles on the calibration chart at the bottom of the instrument and set the tuning scale to the correct reading by turning the tuning knob.

(3) Turn the modulation switch to 400 or 8,200 for the modulation frequency desired.

(4) Turn the receiver VOLUME control completely clockwise. If the signal strength needs adjusting, slide the ATTENUATOR control on the signal generator in or out.

(5) Adjust the controls of the oscilloscope until a steady picture is obtained showing several cycles of the modulation waveform from the signal generator.

(6) Check the output meter on the signal generator to see that the pointer is adjusted to the red line.

### **c. Alignment Procedure.**

(1) Adjust the i-f tuning coils in the following order for maximum video signal on the test scope: L706, L705, L704, L703, L702, L701 in the receiver; L1856, L1853, T1852 in the preamplifier. Increase the attenuation by sliding the ATTENUATOR control on the signal generator out as far as necessary to keep the signal below saturation.

(2) Change the oscilloscope cable from jack J702 on the receiver to J1102 on the remote video amplifier.

(3) Tune L1102 in the remote video amplifier and L708 in the receiver for maximum signal on the test scope. Adjust the ATTENUATOR to keep the signal below saturation.

### 34. SIGNAL GENERATOR TS-155B/UP.

**NOTE:** Complete information on the use of Signal Generator TS-155B/UP is given in TM 11-2657B.

#### a. Installation.

- (1) Install Antenna AT-67/AP as explained in paragraph 31a.
- (2) Using the r-f cable supplied, connect the r-f connector of the signal generator to the pick-up antenna support rod. The signal generator must be placed so that it is out of the r-f field from the radar antenna.

**CAUTION:** The test set must never be connected directly to the r-f plumbing. If this is done, damage to the test set will result.

#### b. Preparation for Use.

- (1) Connect the power cable of the signal generator to the a-c line.
- (2) Turn the POWER switch to ON and the R.F. OSC switch to OFF. Wait 3 minutes for the signal generator to warm up.
- (3) Set the R.F. ATTENUATOR between — 35 dbm and — 40 dbm (set dial between 35 and 40).

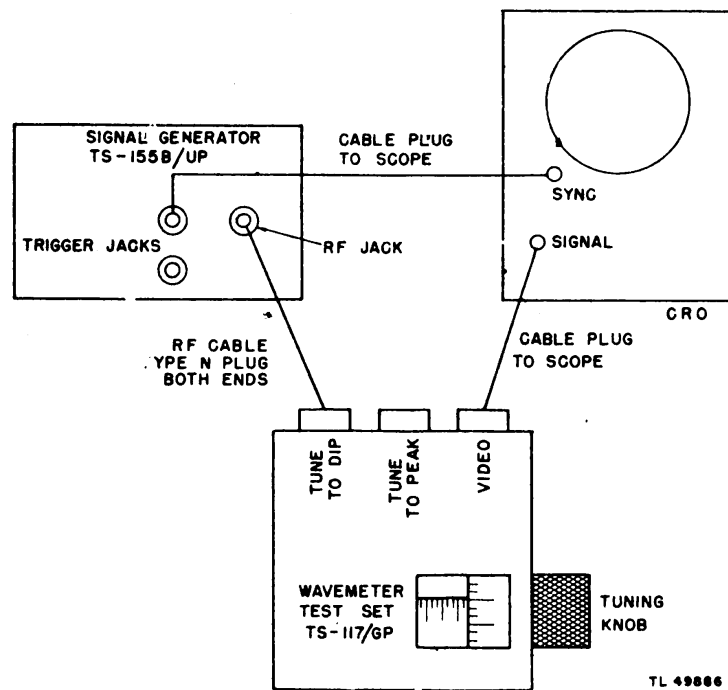

Figure 31. Connection of Signal Generator TS-155B/UP, Wavemeter Test Set TS-117/GP, and test oscilloscope.

(4) Adjust the R.F. OSC OUTPUT control to midposition.

(5) Set the selector switch to CALIB.

(6) Turn the METER ZERO SET control until the power monitor meter reads zero.

(7) Turn the R.F. OSC switch to ON. The power monitor meter should now indicate that r-f power is being generated. If no output is indicated, increase the R.F. OUTPUT control setting. The amount of power may be varied by the R.F. OSC OUTPUT control.

(8) Connect one of the trigger jacks on the signal generator to the trigger monitor jack J103 on the front of the driver unit of radar set.

(9) Turn the selector switch to EXT TRIG and the INPUT TRIGGER switch to — (minus).

### **c. Testing Over-all Performance of Radar System.**

(1) *Measuring Transmitter Power Output.*

(a) Place the signal generator in operation as explained in subparagraph b above.

(b) Turn the R.F. OSC switch to OFF.

(c) Turn the METER ZERO SET knob to adjust the power monitor meter to zero.

(d) Connect the signal generator to the pick-up antenna as explained in subparagraph a above.

(e) Turn the radar set on.

(f) Turn the R.F. ATTENUATOR knob clockwise to the red reference mark.

(g) Check installation of Antenna AT-67/AP to see that it is positioned in the plane of polarization of the radar antenna.

(h) Adjust the elevation and azimuth of the radar antenna for maximum reading of the power monitor meter on the signal generator.

(i) Turn the R.F. TUNING knob very slowly from one end of its range to the other while watching the power monitor meter. As the radar transmitter frequency is reached, a sharp dip will be observed.

(j) Read and record the R.F. TUNING dial scale position at the minimum power monitor meter reading.

(k) Turn the R.F. TUNING dial to 0 or 100, whichever is farther away from the reading found in (j) above.



(l) Read and record the maximum reading on the power monitor meter. This meter reading is proportional to the radar transmitter power output. If readings are taken at different times with the pick-up antenna in the same place and under the same conditions, comparisons of the transmitter power output can be made (TM 11-2657B).

(2) *Measuring Receiver Sensitivity.*

(a) Follow the procedure of subparagraph (1) above.

(b) Turn the selector switch to CALIB and turn the R.F. ATTENUATOR dial to approximately —40 dbm.

(c) Turn the R.F. OSC switch to ON and turn the R.F. OSC OUTPUT control until the monitor meter reads 200.

(d) Set the PULSE DELAY and PULSE WIDTH to the center of their scales.

(e) Adjust the hairlines on the range scopes to approximately 22,000 yards range by means of the slewing handwheel.

(f) Turn the R.F. TUNING dial counterclockwise three divisions from the reading found in subparagraph (1)(j) above.

(g) Set the R.F. ATTENUATOR dial to the calibration reference mark (red line) to provide a large signal.

(h) Tune the radar receiver local oscillator until a signal appears on the screen at approximately 22,000 yards range.

(i) Identify the signal by turning the PULSE DELAY control back and forth about midposition. The signal from the signal generator will move in synchronism with the PULSE DELAY control. Set the PULSE DELAY control so that the signal from the signal generator does not interfere with any other signals.

(j) Tune the T/R box and the mixer for a maximum signal. If necessary, turn the R.F. ATTENUATOR dial counterclockwise to bring the signal below saturation; then complete the tuning operation.

(k) Set the R.F. ATTENUATOR dial to approximately — 40 dbm.

(l) Turn the R.F. OSC switch to OFF.

(m) Turn the selector switch to CALIB.

(n) Readjust the METER ZERO SET control for zero reading of the meter.

(o) Turn the R.F. OSC switch to ON and turn the R.F. OSC OUTPUT control until the power monitor meter reads 200. This standardizes the signal generator for measuring receiver sensitivity.

(p) Turn the R.F. ATTENUATOR dial counterclockwise until the signal is equal to the height of the grass. Move the signal in range by means of the PULSE DELAY control while attenuating so that it can be followed up to the point where it disappears in the grass.

(q) Record the R.F. ATTENUATOR dial reading. This reading is a relative measure of the sensitivity of the radar receiver, expressed in terms of watts peak power measured at the R.F. jack of the signal generator. The greater the R.F. ATTENUATOR dial reading, the greater the receiver sensitivity.

**NOTE:** If the radar set was badly out of tune before this procedure was started, it may not be precisely tuned for maximum performance. It may be necessary to retune the set slightly, using actual signals or the echo box (par. 29).

#### **d. Adjustment of Signal Generator to a Desired Frequency with Wavemeter Test Set TS-117/GP.**

(1) Connect the power cables of the signal generator and the test oscilloscope to the a-c line.

(2) Turn the power switches to ON and the R.F. OSC switch to OFF: Wait 3 minutes for the signal generator and oscilloscope to warm up.

(3) Set the selector switch to CALIB.

(4) Balance the monitoring meter reading to zero by adjusting the METER ZERO SET control.

(5) Throw the R.F. OSC switch to the ON position.

(6) Rotate the R.F. OSC OUTPUT potentiometer until the monitoring meter reads approximately 160.

(7) Connect the signal generator, the wavemeter, and the test oscilloscope as shown in figure 31. Adjust the scope controls to give a steady picture showing several cycles of the triggering pulse.

(8) Obtain the dial reading for the desired frequency from the calibration chart on the back of the wavemeter.

(9) Set the micrometer adjustment to the correct reading.

(10) Turn the R.F. TUNING knob on the signal generator until a dip occurs in the signal on the test oscilloscope.

(11) Change the r-f cable to the TUNE TO PEAK receptacle on the wavemeter.

(12) Adjust the R.F. TUNING dial on the signal generator to give maximum amplitude of the signal on the oscilloscope. The

signal generator is now adjusted to the same frequency as the wavemeter.

### **35. WAVEMETER TEST SET TS-117/GP (fig. 32).**

**NOTE:** Complete information on the use of Wavemeter Test Set TS-117/GP is given in TM 11-2538.

#### **a. Preparation for Use.**

(1) To make frequency measurements in the microwave field of the radar antenna connect the directive Antenna Assembly AS-23/AP to the receptacle marked TUNE TO PEAK by using Radio-Frequency Adapter UG-57/U.

(2) To measure the frequency of the local oscillator klystron, attach one end of Adapter UG-183/U to the MONITOR jack on the front of the local oscillator chassis. Attach the other end of the cable to the TUNE TO DIP receptacle.

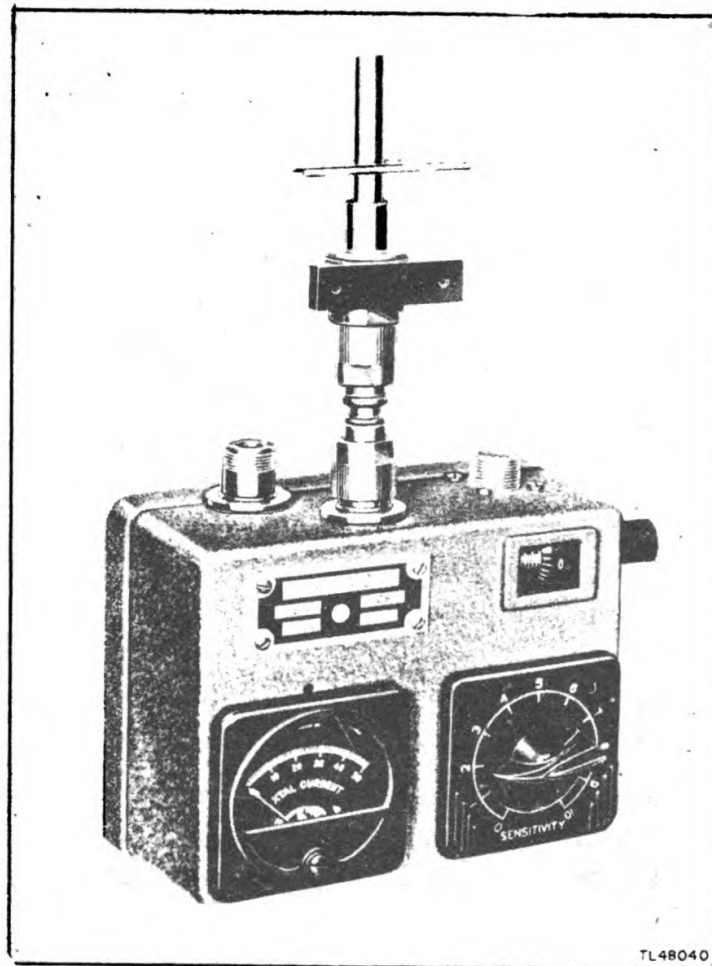

*Figure 32. Antenna Assembly AS-23/AP connected to Wavemeter Test Set TS-117/GP.*

(3) To measure the frequency of Signal Generator TS-155B/UP, attach the signal generator, wavemeter, and test oscilloscope together as shown in figure 31. Set the selector switch on the signal generator to CALIB. Adjust the scope controls to give a steady picture on the screen, showing several cycles of the triggering pulse.

## **b. Operation.**

### *(1) Frequency Measurement of Radar System.*

(a) Set up the wavemeter as outlined in subparagraph a(1) above.

(b) Place the unit in the microwave field with the bottom of the unit (calibration plate) facing the origin of the field and the pick-up dipole parallel to the plane of polarization of the radar antenna.

(c) Rotate the micrometer handle to give a peak in the meter reading.

(d) The sensitivity of the meter can be varied by the SENSITIVITY control.

(e) Frequency and wavelength can be obtained by converting the micrometer reading with the aid of the calibration chart on the bottom plate of the wavemeter.

### *(2) Frequency Measurement of Local Oscillator Klystron.*

(a) Set up the wavemeter as outlined in subparagraph a(2) above.

(b) Obtain a coarse adjustment of the micrometer by rotating the micrometer handle to give a dip in the meter reading.

(c) Change the connection to the wavemeter from the TUNE TO DIP receptacle to the TUNE TO PEAK receptacle and rotate the micrometer handle slightly to give a peak in the meter reading.

(d) Sensitivity of the meter can be varied by the SENSITIVITY control.

(e) Frequency and wavelength can then be obtained by converting the micrometer reading with the aid of the calibration chart on the bottom plate of the wavemeter.

### *(3) Frequency Measurement of Signal Generator TS-155B/UP.*

(a) Set up the wavemeter as outlined in subparagraph a(3) above.

(b) Obtain a coarse adjustment of the micrometer by rotating the micrometer handle to give a dip in the signal on the oscilloscope screen.

(c) Change the connection to the wavemeter from the TUNE TO DIP receptacle to the TUNE TO PEAK receptacle and rotate the micrometer handle slightly to give a maximum signal on the scope screen.

(d) Frequency and wavelength can then be obtained by converting the micrometer reading with the aid of the calibration chart on the bottom plate of the wavemeter.

### **36. TEST ANTENNA TS-210/MPM and DUMMY ANTENNA TS-208/MPM (fig. 33).**

Test Antenna TS-210/MPM and Dummy Antenna TS-208/MPM are used in the alignment and tuning procedure for Radio Transmitter and Receiver BC-1267-A. The procedure for installing the test and dummy antennas is as follows:

**a.** Disconnect Cord CD-1008 and the right-angle connector to which it is connected from the ANTENNA connector on the transmitter.

**b.** Connect the T-shaped connector, Adapter M-358, to the ANTENNA connector as shown in figure 33.

**c.** Connect Test Antenna TS-210/MPM to the upper branch of the adapter.

**d.** Connect Dummy Antenna TS-208/MPM to the lower branch.

**e.** For the complete alignment and tuning procedure, see TM 11-1332 or TM 11-1532.

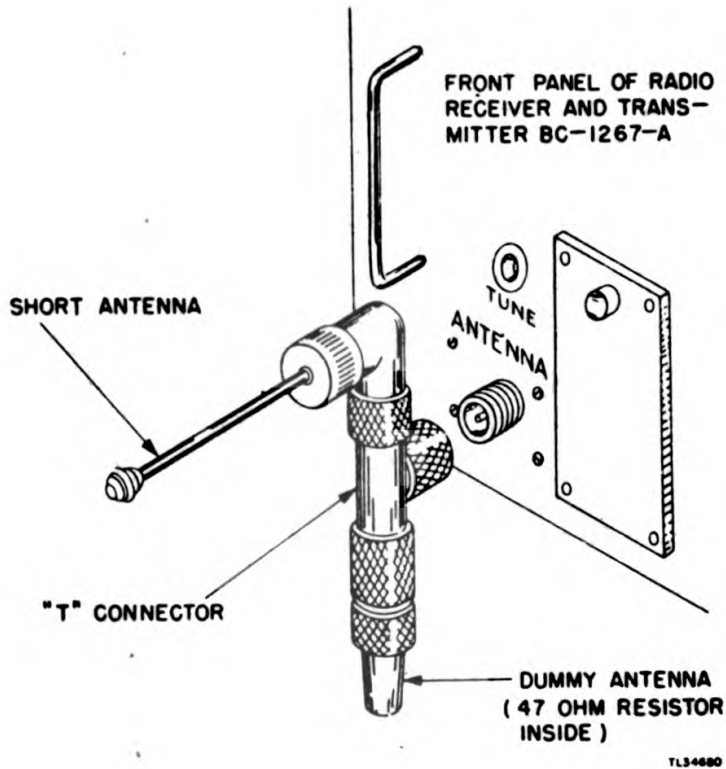

**Figure 33. Test Antenna TS-210/MPM and Dummy Antenna TS-208/MPM mounted on Radio Receiver and Transmitter BC-1267-A.**

## **SECTION III**

# **PREVENTIVE MAINTENANCE**

---

### **37. GENERAL.**

**a.** Preventive maintenance is a systematic series of operations performed at regular intervals on equipment, when not in use, to prevent major break-downs and to keep the equipment operating at top efficiency. Test Set AN/MPM-2 requires routine maintenance at regular intervals so that the equipment can be kept in excellent condition at all times. This section of the manual contains general instructions and serves as a guide for personnel assigned to perform the four basic maintenance operations: inspect, tighten, clean, and adjust.

**b.** The *inspect* operation establishes the need for the other three. The selection of operations is based upon a general knowledge of field requirements. For example, the dust of dirt roads during cross-country travel filters into the equipment in spite of all precautions. Rapid changes in weather (such as heavy rain followed by blistering heat), excessive dampness, snow, and ice tend to cause corrosion of exposed surfaces and parts. Without frequent inspections and the necessary performance of tightening, cleaning, and adjusting, equipment becomes undependable and subject to break-down when it is most needed.

**c.** Scheduling of the preventive maintenance operations contained in this section will be determined by the local commander.

### **38. PREVENTIVE MAINTENANCE TECHNIQUES.**

**a. Inspect.** Inspection consists of carefully observing all parts of the equipment and noting any signs of overheating, loose or broken connections or loose mountings, state of cleanliness, proper positioning of wiring, etc.

**b. Tighten.** This operation consists of tightening loose mounting bolts, screws, setscrews, and loose or broken connections. Do not overtighten any mountings or terminals.

**c. Clean.** Remove all corrosion, dust, dirt, and other foreign matter from all parts of the equipment. Use a small clean paint

brush and cleaning cloths to remove dust and dirt. Moisten the cloth with a dry-cleaning solvent, when required. Crocus cloth or fine sandpaper is used to remove corrosion. Repaint any exposed metal surfaces to match the surroundings.

**d. Adjust.** This operation as applied to preventive maintenance means primarily the adjustment of meter pointers to the zero mark on the meter scale. Before deciding that a meter needs re-adjusting, tap the meter case lightly with the finger tips to overcome the slight friction which sometimes exists at the bearings and prevents an otherwise normal unit from coming to rest at zero. If adjustment is necessary, insert the tip of a small screwdriver into the zero-adjusting screw located on the case below the meter face. Slowly turn the adjusting screw until the pointer is at the zero mark. View the meter face and pointer *full on* to avoid the error caused by parallax. Avoid turning the screw too far; otherwise the pointer may be bent or the spring damaged.

### **39. MATERIALS NEEDED.**

The following materials are needed in performing preventive maintenance on the equipment:

Paint brush, small.

Cleaning cloths.

Crocus cloth.

Sandpaper, #0000.

Solvent, Dry-cleaning, Federal Spec P-S-661a.

Common hand tools.

**NOTE:** Leaded gasoline is not recommended as a cleaning fluid for any purpose. Solvent, Dry-cleaning, Federal Spec P-S-661a, is available as a cleaning fluid, through established supply channels. Oil, Fuel, Diesel, U. S. Army Spec 2-102B, may be used for cleaning purposes when dry-cleaning solvent is not at hand. Since unleaded gasoline is available only in limited quantities, and only in certain locations, it should be used for cleaning purposes only when no other agent is suitable. Carbon tetrachloride, or fire-extinguishing liquid (carbon tetrachloride base), will be used, if necessary, *only on contact parts of electronic equipment.*

### **40. PREVENTIVE MAINTENANCE INSTRUCTIONS.**

General instructions are given below for the application of preventive maintenance operations on the various components of



Test Set AN/MPM-2. All work is to be performed with the power removed from the equipment. After the completion of the work, the equipment should be put into operation and checked for satisfactory performance.

**a. Inspect.** Observe all parts of the equipment carefully and note any signs of overheating as indicated by discoloration of the affected parts. Note the general condition of tubes, coils, transformers, capacitors, controls, and switches on the various units. Look for loose or broken connections, loose mountings and parts, and cut or frayed insulation on the wiring. Examine all recesses in the units for accumulation of dust and dirt, especially between connecting terminals. Parts, connections, and terminals must be free of rust and corrosion. In tropical and high-humidity locations, look for fungus growth and mildew.

**b. Tighten.** All loose mountings must be securely tightened in place. If the connections are dirty or corroded, clean them before tightening. When tightening locknuts that hold leads to insulator bushings, do not apply excessive pressure or the bushings will crack. Tighten all loose terminals and resolder or repair any faulty or broken connections.

**c. Clean.** All dirt and other foreign matter must be removed from the equipment. Clean all tubes, capacitors, transformers, and other parts of the equipment with a cleaning cloth. When it is necessary to use a cloth moistened with dry-cleaning fluid, always wipe the surfaces thoroughly dry with a clean cloth. Do not displace any of the wiring when cleaning within the components. Remove all signs of fungus, mildew, and corrosion.

**d. Adjust.** Adjust the tension on all loose spring clips. Do not flatten the connector clips on the tubes during the adjustment. If the clip is made of thin metal, it can be adjusted by gently pressing it with the fingers. If it is made of heavy metal, suitable pressure can be applied with a pair of long-nose pliers. When zero-adjustment on the meters is required, refer to paragraph 38d for the proper method of adjustment.

#### **41. CORDS.**

The cords supplied with Test Set AN/MPM-2 are subject to damage from accidents, weather, and deterioration. If proper measures are taken, however, the useful life of these cords can be greatly extended.

**a.** Inspect the cords regularly for worn and damaged places in the insulation. Repair or replace a damaged cord immediately. Since some of the cords carry very high voltages, severe physical injury may result unless this is done.

**b.** When using the test equipment, arrange it so that the cords are not resting on any sharp objects or stretched tightly over the edges of the bench or any of the other test equipment. Avoid making sharp bends in the cord since these may result in kinks, causing damage to the insulation or shielding.

**c.** Regularly inspect the plugs and fittings on the ends of the cords for corrosion, loose connections, and damaged plug pins. Make sure that the pins are clean and making good contact; otherwise, a high-resistance connection or an open circuit will result.

## **42. TOOLS.**

**a.** Proper care and use of the tools is necessary at all times. All tools should be kept clean, oiled, and free from rust to provide ease of operation. Remove all excess oil with a clean cloth.

**b.** Do not attempt to use a tool for another purpose than that for which it is intended. Damage to the tool or the equipment will result.

## **SECTION IV**

### **FUNCTIONING OF PARTS**

---

#### **43. GENERAL.**

A brief explanation of the functioning of major test instruments furnished with Test Set AN/MPM-2 is contained in this section. This information is given to the repairman in locating and eliminating troubles in the various circuits of the component parts. If any information on a particular test instrument not included here is desired, refer to the technical manual for that instrument.

#### **44. ECHO BOX TS-207/UP (fig. 34).**

**NOTE:** Complete information on the functioning of parts of Echo Box TS-207/UP is given in TM 11-1212.

**a.** The echo-box cavity is electrically equivalent to a sharply tuned L-C resonant circuit. The frequency to which the box is resonant is dependent upon the position of an adjustable plunger which determines the relative size of the resonant cavity. When the length of the cavity is decreased, the resonant frequency is raised; when the length of the cavity is increased, the resonant frequency is lowered.

**b.** Radio-frequency energy from the radar antenna is picked up by a small test dipole and is fed into the echo-box cavity through the r-f cable and a coupling loop. During the radar pulse, the resonant cavity of the echo box accepts r-f energy and oscillations build up for the duration of the radar pulse. After the radar pulse, the oscillations in the echo box gradually die out because some of the energy is dissipated in the resonant cavity, some is coupled out to the crystal rectifier and microammeter, and some is coupled out to the pick-up dipole. The energy radiated from the pick-up dipole is detected in the radar receiver and appears on the range scopes. The echo box therefore acts as a miniature transmitter which begins to transmit immediately after the radar pulse has been transmitted. Because of the large amount of power received and returned by the echo box, the received signals will, for the

most part, appear on the range indicators as a solid block with a flat top at the receiver-saturation amplitude. The oscillations die out exponentially and this portion of the curve can be seen from the end of the flat top to the noise or "grass" level. The time from the beginning of the transmitted pulse to the point where the signal from the echo box fades into the noise level is known as the ringing time. The ringing time is measured in terms of range in yards on the range scopes. It is affected by changes in temperature. Refer to the correction table in TM 11-1524, appendix D.

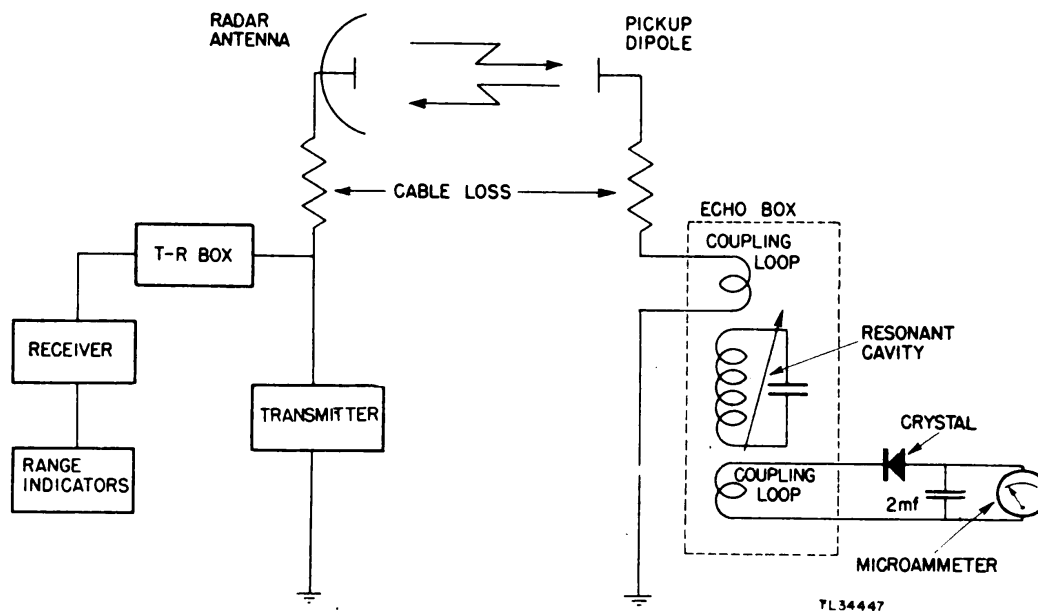

Figure 34. Echo Box TS-207/UP, simplified schematic diagram.

c. When the box is tuned to resonance, energy may be coupled out and into the crystal rectifier. The crystal current, filtered by a capacitor and measured by a microammeter, indicates the amount of energy absorbed by the echo box. Thus the microammeter reading serves to indicate the tuning condition and the power output of the radar set.

#### 45. FLUXMETER TS-15A/AP (fig. 35).

**NOTE:** Complete information on the functioning of parts of Fluxmeter TS-15A/AP is given in TM 11-2559.

a. The essential parts of the fluxmeter are two milliammeters (probe meter and gauss meter) in series with a 1.5-volt battery and a rheostat to control the battery current. The gauss meter measures the current through the circuit and is accurately cali-

brated to give readings directly in gaussses on three scales. The probe meter has no internal magnet but is actuated by the magnetic flux in the gap of the magnet under test. The deflection of the probe meter pointer is dependent upon two properties; namely, the amount of current through the probe meter coil, and the flux density in the magnet gap. The torque is kept at constant value by setting the probe meter pointer to the red mark for each

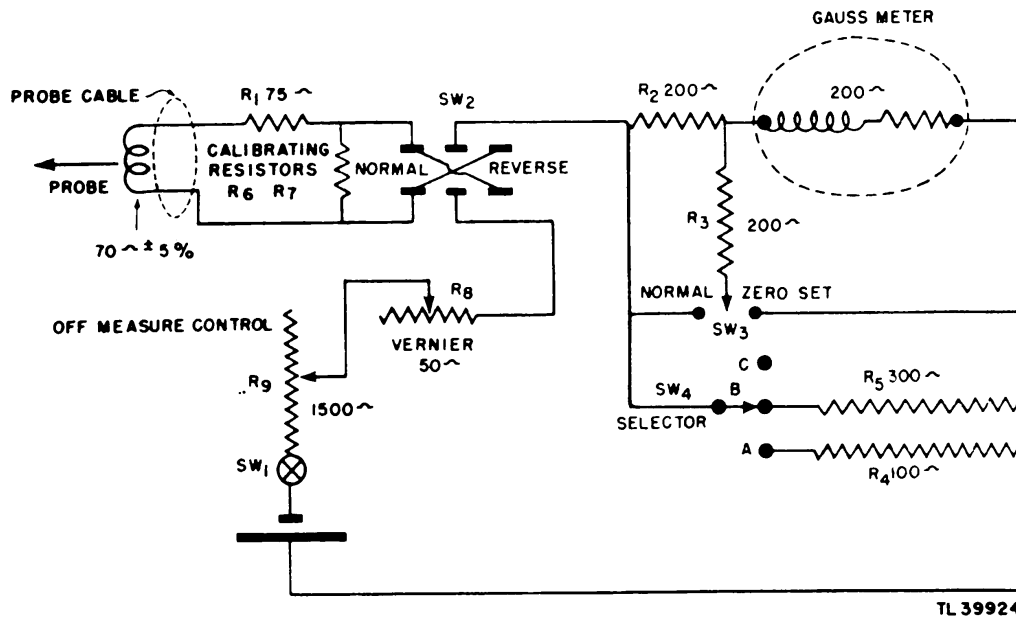

Figure 35. Fluxmeter TS-15A/AP, schematic diagram.

measurement. The current and flux density vary inversely with each other, the probe meter requiring less current through its coil in strong magnetic fields and more current in weak magnetic fields for the fixed amount of deflection.

**b.** To extend the range of the fluxmeter, two values of resistance can be shunted across the gauss meter by rotating the range selector switch. When the low range of the fluxmeter is used, the lowest value of resistance is placed in shunt with the gauss meter. This allows the maximum amount of current to pass through the probe meter coil and permits full-scale deflection of the probe meter pointer with small values of flux density. With the selection of the larger value of shunt resistance and finally with the removal of the shunt, the current through the probe meter is proportionately decreased and greater flux densities are required to give full-scale deflection of the probe meter pointer.

## 46. POWER METER TS-125/AP (fig. 36).

**NOTE:** Complete information on functioning of parts of Power Meter TS-125/AP is given in TM 11-1217.

**a.** The power meter operates on the bead-thermistor bridge principle. A thermistor is a circuit element having a negative resistance coefficient; that is, an increase in thermistor temperature causes a decrease in its resistance, and vice versa. Variations in thermistor temperature, and consequently the resistance, may be caused by temperature changes in the thermistor environment, by direct current flowing through the thermistor, or by absorbed r-f power. All these changes occur in the power meter.

**b.** Resistors R1, R2, R3, and thermistor TH1 form the arms of a bridge circuit (fig. 36). The normal or cold resistance of the thermistor is above 250 ohms; therefore, the bridge is unbalanced. When switch SW1 is closed, a current flows from the battery through variable resistor R9 to the bridge where it divides: part of the current flows through R2 and R3, then back to the battery; the other portion of current flows through R1, TH1, and back to the battery. Point C is now positive with respect to point D and the meter will read backwards. The current flowing through TH1 causes TH1 to heat, thereby reducing its value of resistance. When the resistance of TH1 decreases to 250 ohms, the meter will read zero because points C and D are at the same potential.

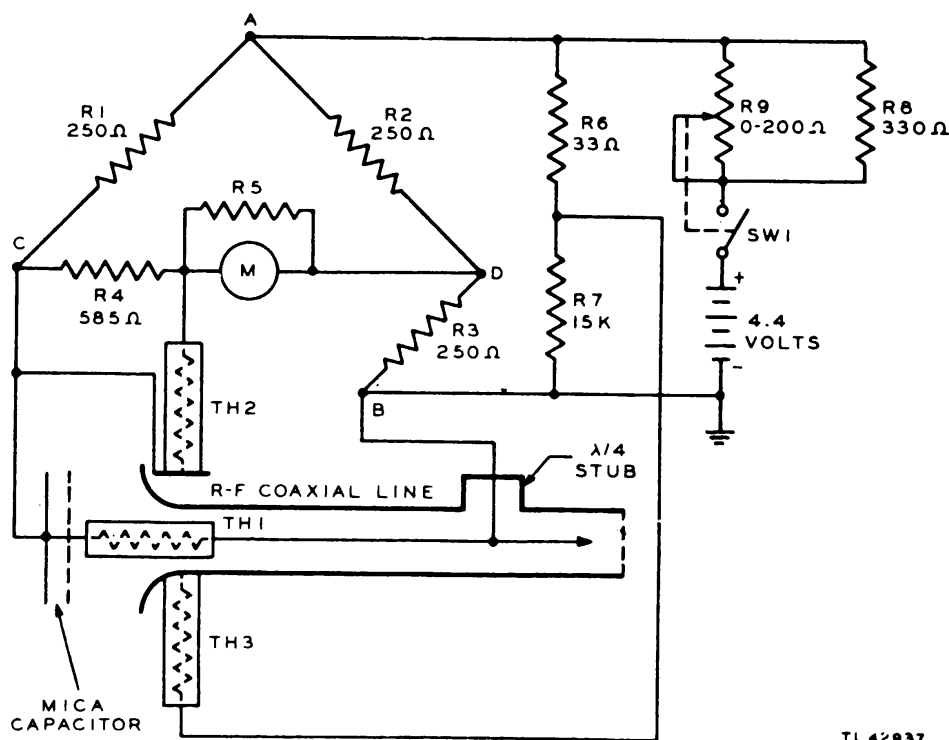

Figure 36. Power Meter TS-125/AP, schematic diagram.

Current through the bridge is adjusted by resistor R9 to a value which heats TH1 just enough to cause its resistance to remain at 250 ohms. When this condition exists, the bridge is balanced.

c. The thermistor is mounted in a section of r-f coaxial line inside the instrument. When r-f power is fed into the coaxial section, a small amount of power is absorbed by TH1. This absorbed power causes the resistance of TH1 to decrease further, which unbalances the bridge. This unbalance is in the opposite direction from that when TH1 is cold. Point C now becomes negative with respect to point D; therefore the meter will read directly the amount of bridge unbalance. The resulting unbalanced current flowing through the meter is nearly proportional to the r-f power causing the unbalance.

d. The thermistor is also subject to resistance changes due to variations in ambient temperature and in the voltage applied to the bridge. Temperature compensating elements TH2 and TH3 are mounted near TH1 but on the outside of the r-f coaxial line. If the temperature at TH1 should change after the bridge has been balanced, the resistance of TH3 will also vary inversely with the temperature change. TH3 is connected across resistor R7, which with resistor R6 constitutes a variable shunt across points A and B of the bridge. The change in load, due to variation in resistance, across points A and B causes a proportional change in current through TH1. This action tends to hold the bridge balanced for small temperature changes in the environment of TH1. Resistor R5 is used to calibrate the meter. A spare thermistor bead TH1 and matching meter shunt R5 are supplied with the instrument. Disk thermistor TH2, which is in parallel with R4 and is connected in series with the meter, tends to reduce fluctuations in the meter reading caused by temperature changes.

#### **47. RANGE CALIBRATOR I-223-A (fig. 37).**

**NOTE:** Detailed information on the functioning of parts of Range Calibrator I-223-A is given in TM 11-2528 and TM 11-1532.

The purpose of the range calibrator is to provide means for adjusting and checking the range measuring circuits of a pulse-operated radar apparatus. The calibrator provides two separate and distinct methods for meeting this requirement. One of them gives an over-all check of the entire range circuit, and the other gives a check on the adjustment of the timing coil. These methods require three output voltages, as follows:

**a.** A crystal-controlled sine wave of appropriate frequency. The frequency used is one in which the period (time required for one cycle) is the time required for electromagnetic waves to travel 1,000 yards and return. This frequency is 163.94 kilocycles per second. This output is used for a sweep for the test oscilloscope in the timing coil check.

**b.** A marker-pulse wave exactly synchronous with the sine wave. This pulse wave is obtained directly from the sine wave by a waveshaping process. The pulses are of positive polarity and not more than 1 microsecond in width. These are the markers with which the range of the radar set is calibrated.

**c.** A synchronizing-pulse wave similar to the marker-pulse wave but with a repetition frequency of 240 cycles per second. Although these pulses occur relatively infrequently, they must remain in exact synchronism with the sine wave and also with the marker wave. The synchronizing-pulse wave is obtained from the marker wave by a selection process whereby one wave is allowed to pass out of approximately 685 marker waves. This pulse is used to trigger the control unit during tests.

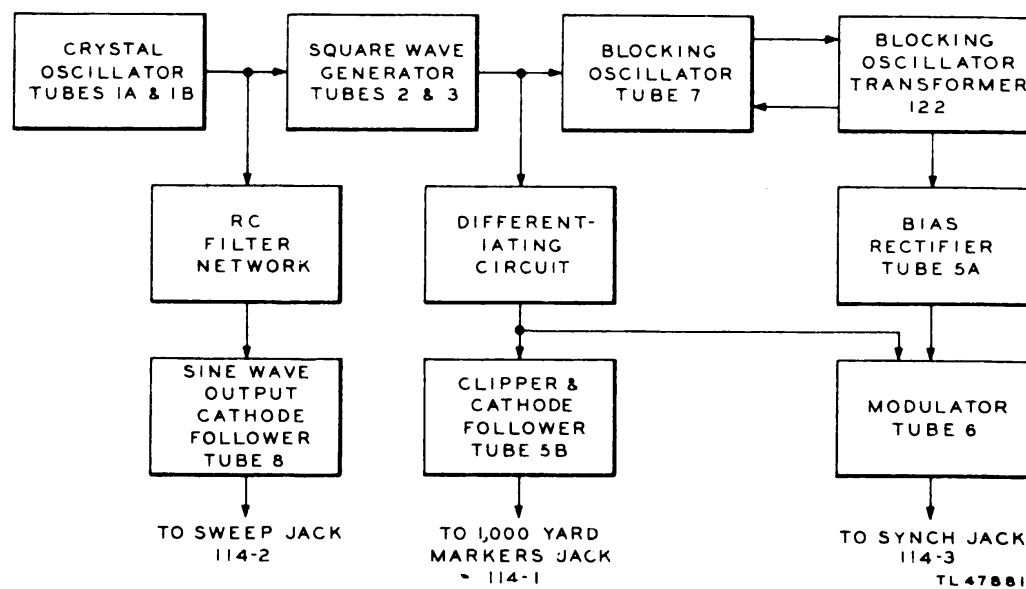

Figure 37. Range Calibrator I-223-A, block diagram.

#### 48. SIGNAL GENERATOR TS-343/U (fig. 38).

**NOTE:** Complete information on functioning of parts of Signal Generator TS-343/U is given in TM 11-1233.

The major components of the signal generator circuit and their functions are as follows:



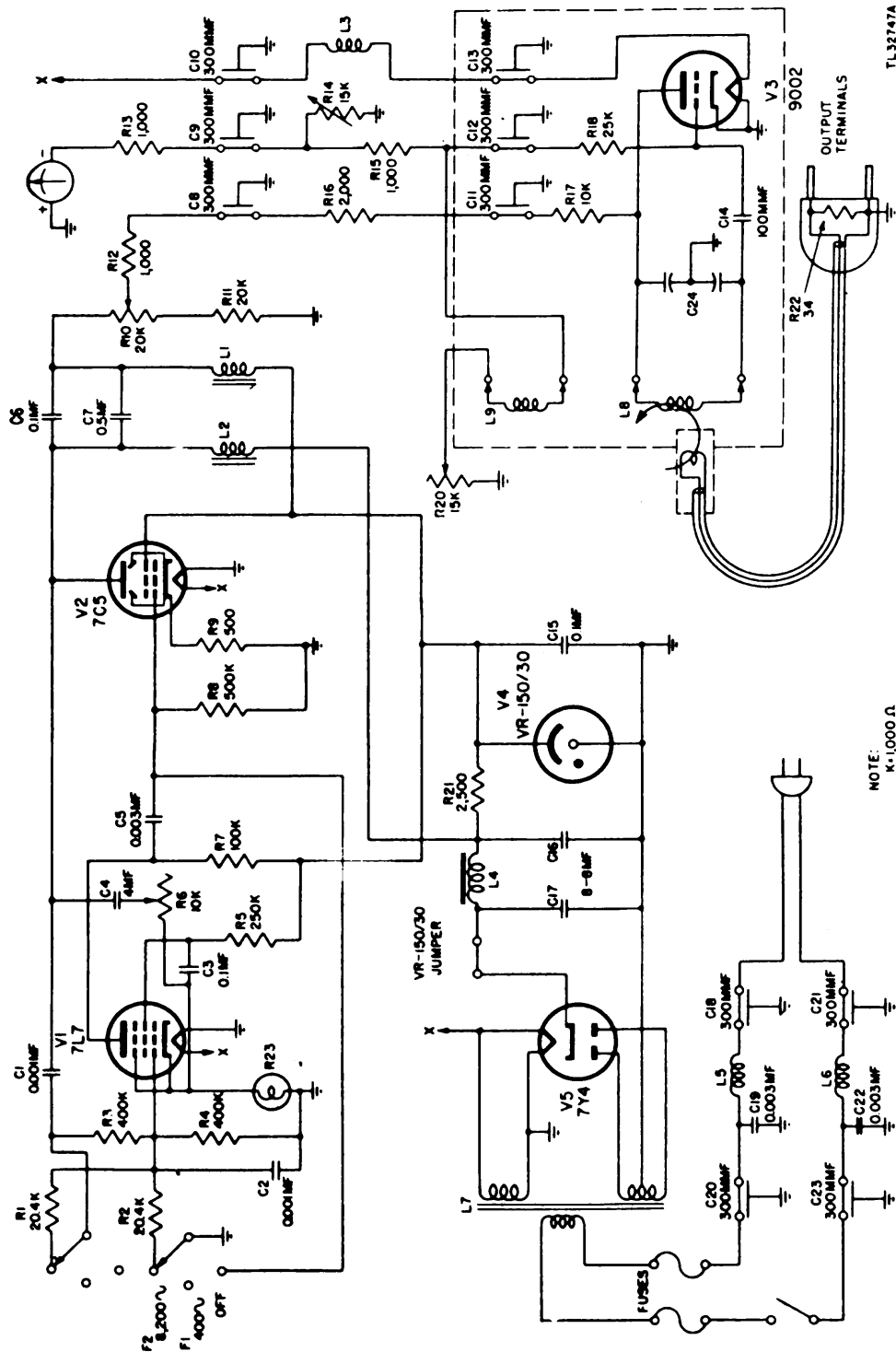

TL32747A

NOTE:  
K=1,000 Ω

Figure 38. Signal Generator TS-848/U, schematic diagram.

**a. R-f Oscillator.** The r-f oscillator uses a type 9002 tube in a Colpitts circuit. It is tuned by a split-stator tuning capacitor which is driven by the tuning knob. The tuning scale is mounted on a drum which rotates with the tuning capacitor shaft. The actual frequency indication is given by a calibration chart which plots frequency against tuning scale divisions. Two frequency ranges are obtainable by the range switch which selects one of two different coils in the oscillator circuit.

**b. Modulator.** The audio signal used for modulation is supplied by a resistance-tuned audio oscillator having low distortion, stable frequency, and constant output voltage. The oscillator consists of a two-stage resistance-coupled audio amplifier which has a portion of its output fed back to its input through a frequency-selective network in such manner that oscillation occurs at one frequency. The amplitude of oscillation is controlled by a degenerative network in the cathode circuit of the first amplifier. The correct amount of negative feedback to give steady, undistorted output is obtained by adjustment of the degenerative feedback control rheostat. The circuit is adjusted to give 45 peak volts or 30 percent modulation. The modulation switch changes the time constant of the frequency-selective circuit to produce frequencies of 400 or 8,200 cycles per second or cuts off the oscillator entirely. The audio signal is applied to the plate of the r-f oscillator.

**c. Attenuator.** The attenuator consists of a movable metal tube with a pick-up coil coupled loosely to the oscillator coil. Moving the tube in or out varies the coupling and the output. A transmission line connects the pick-up coil to the output terminals and is terminated in its characteristic impedance.

**d. Output Meter.** The output meter indicates the oscillator grid current. The OUTPUT control controls the plate voltage supplied to the oscillator so that the grid current can be adjusted to a standard value and a standard output can be obtained. The range switch places the correct shunt across the meter so that it can be set to the same red mark on both tuning ranges.

**e. Power Supply.** The power supply, which supplies all the d-c voltages necessary for the instrument, uses one rectifier tube and a gaseous voltage regulator.

#### **49. SIGNAL GENERATOR TS-155B/UP (fig. 39).**

**NOTE:** Complete information on functioning of parts of Signal Generator TS-155B/UP is given in TM 11-2657B.

The simplified block diagram (fig. 39) shows the relationship between the principal component circuits of the signal generator circuit and their functions are as follows:

**a. Blocking Oscillator.** The blocking oscillator provides a signal for triggering the signal generator internally. Its frequency is continuously variable from 120 to 2,000 cycles per second by the OUTPUT TRIGGER FREQUENCY control when the selector switch is in the INT TRIG position. In the CALIB position the frequency of the oscillator is fixed at approximately 650 cycles per second; in the EXT TRIG position the oscillator is inoperative.

**b. Trigger Generator.** The trigger inverter is an amplifier which takes a positive or negative external signal, depending on the setting of the INPUT TRIGGER switch. The signal is applied to the delay multivibrator with proper polarity for triggering the signal generator from an external source.

**c. Delay Multivibrator.** This stage is triggered by a signal from either the trigger inverter or the blocking oscillator, depending on the setting of the selector switch. It provides a square or rectangular pulse whose length is variable by means of the PULSE DELAY control. The length of the pulse determines the time delay between the triggering signal and the final r-f pulse.

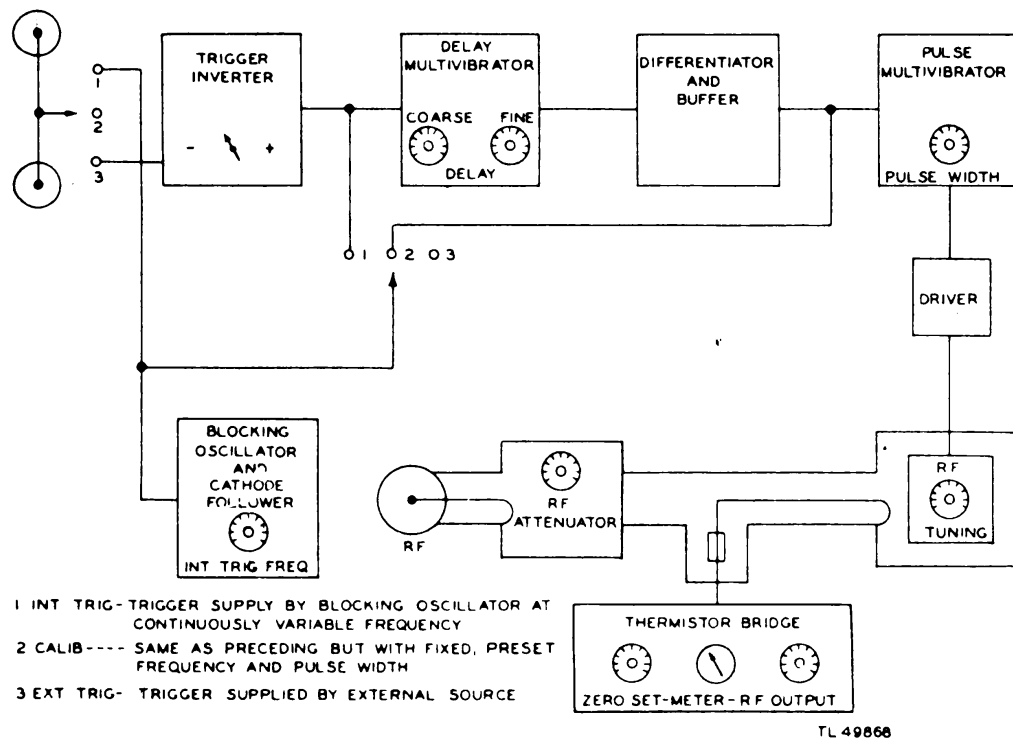

Figure 39. Signal Generator TS-155B/UP, block diagram.

**d. Differentiator and Buffer.** This part of the circuit converts the trailing edge of the delay multivibrator pulse into a signal for triggering the pulse multivibrator.

**e. Pulse Multivibrator.** When triggered, this stage produces a pulse for keying the cavity oscillator. The pulse width is continuously variable from 0.75 to 5.75 microseconds by the PULSE WIDTH control.

**f. Driver.** This stage amplifies and shapes the pulse developed in the pulse multivibrator so that it may properly key or modulate the cavity oscillator.

**g. Cavity Oscillator.** The cavity oscillator is an r-f oscillator which operates in the frequency band from 2,700 to 2,900 megacycles. It is tuned by the R.F. TUNING control. It oscillates only when keyed by the driver stage, thus putting out pulses of r-f energy.

**h. Thermistor Bridge.** The thermistor bridge and its associated meter constitute the power-monitoring part of the signal generator. It consists of a Wheatstone bridge with a thermistor (variable-resistance unit) as one of the elements. Power for the bridge is supplied by the power supply and the power monitor meter is connected across the bridge. The bridge is initially balanced by the METER ZERO SET control. R-f power from the r-f attenuator applied to the thermistor then unbalances the bridge, and the meter gives a reading proportional to the r-f power fed in. The circuit is compensated for temperatures. The functioning of this circuit is similar to that of the thermistor bridge in the Power Meter TS-125/AP (par. 46).

**i. R-f Attenuator.** The r-f attenuator controls the output power from the cavity oscillator. It is also used to pass power from an external source to the thermistor bridge for measurement. The attenuation is varied by the R.F. ATTENUATOR control.

**j. Power Supply.** The power supply furnishes all the voltages necessary for energizing the circuits of the signal generator. The voltage supplied to the r-f oscillator tube is varied by the R.F. OSC OUTPUT control.

## **50. WAVEMETER TEST SET TS-117/GP (figs. 40 and 41).**

**NOTE:** Complete information on functioning of parts of Wavemeter Test Set TS-117/GP is given in TM 11-2538.

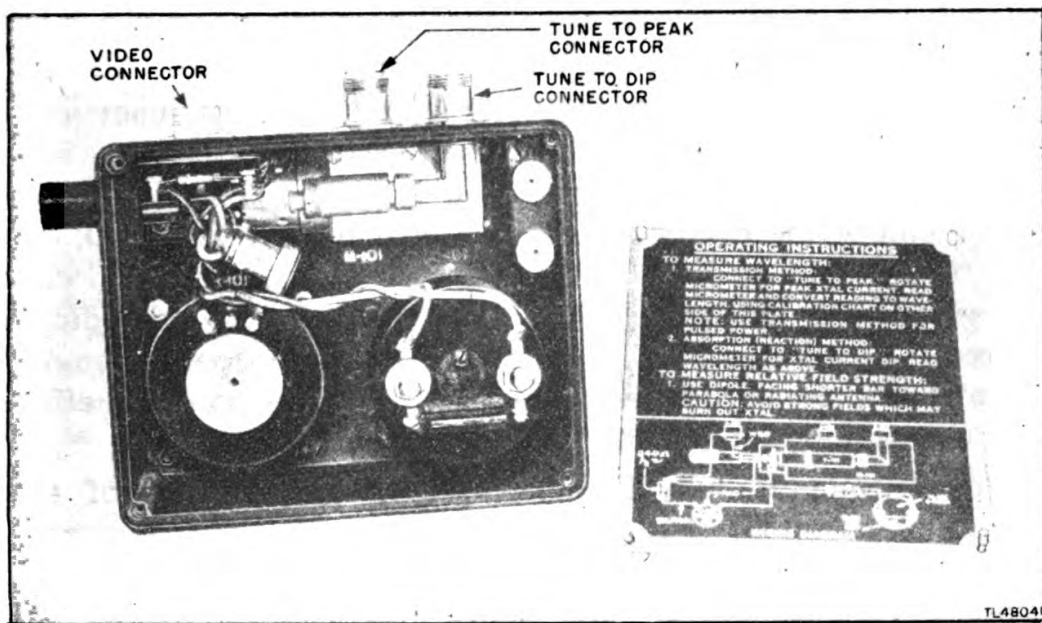

Figure 40. Wavemeter Test Set TS-117/GP, interior view (crystal holder open).

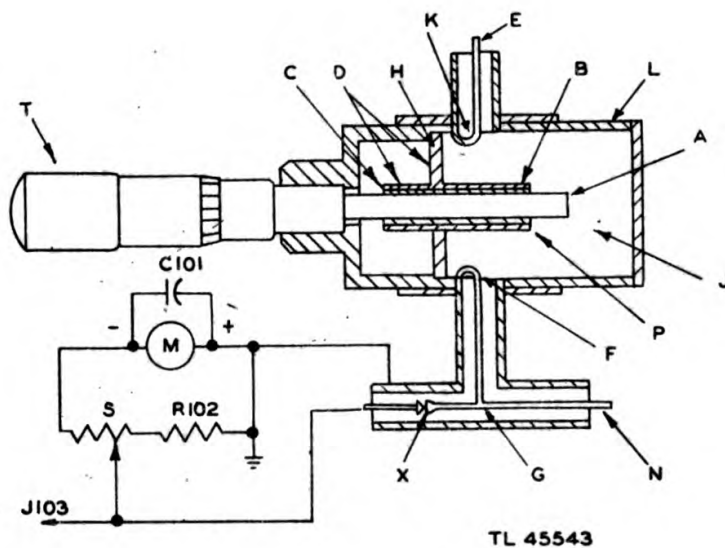

Figure 41. Resonant cavity, simplified schematic diagram.

### **a. Wavemeter Resonant Cavity.**

(1) The wavemeter utilizes a resonant cavity which is a quarter-wave long (fig. 41). The cavity consists of an outer conductor, L, with an inner conductor, B. The inner conductor has an extension, A, and is shorted to the outer conductor at H.

(2) Since the cross-hatched section between the inner conductor, B, and its extension, A, is a dielectric, an electrical connection must be made between A and B at the point P. In the thimble end of the cavity the path from point C through D, the outer conductor L, and the inner conductor A, and back to C constitutes a folded half-wavelength. This places a high impedance between A and B at point C. From C to P is a quarter-wavelength. This places a low impedance between A and B at point P, effectively connecting inner conductor B and its extension A.

(3) Turning thimble T changes the shape and size of the cavity and therefore changes the resonant frequency. Turning thimble T so that extension A projects farther into the cavity, decreases the size of the cavity and decreases the frequency. A calibration chart shows the effective frequency range obtained by varying the size of the cavity by means of the extension. Two methods of frequency measurement are possible, the transmission method and the absorption method.

**b. Transmission Method.** When the wavemeter is used for the transmission method of measurement (TUNE TO PEAK), the unknown signal is coupled into the wavemeter by means of jack E and loop K and (when the wavemeter is tuned to resonance) passes through loop F to the T-section, G, and thence to the crystal detector X (standard 1N21 or 1N22). The rectified signal is indicated on meter M. The sensitivity of the meter is controlled by potentiometer S. When the wavemeter is correctly tuned, the meter gives a peak reading.

**c. Absorption Method.** When the absorption method of measurement (TUNE TO DIP) is used, the unknown signal is fed into the T-section through jack N and thence to the crystal rectifier. When the wavemeter is tuned to the frequency of the unknown signal, a dip in the meter reading will occur because of the absorption of power by the wavemeter through loop F from the T-section.

# **SECTION V**

## **REPAIRS**

---

**NOTE:** Failure or unsatisfactory performance of equipment used by Army Ground Forces and Army Service Forces will be reported on W.D., A.G.O. Form No. 468 (Unsatisfactory Equipment Report.) If Form No. 468 is not available, see TM 38-250. Failure or unsatisfactory performance of equipment used by Army Air Forces will be reported on Army Air Forces Form No. 54 (Unsatisfactory Report).

### **51. SERVICING.**

Use care in maintaining and servicing this equipment. Servicing and repair other than the replacement of tubes and batteries should be performed only by competent personnel supplied with adequate tools and instruments. An inexperienced operator attempting to locate and repair troubles may damage the equipment to such an extent that shipment to a higher repair echelon will be necessary. This is particularly true of indiscriminate adjustment of some of the frequency-alignment capacitors.

### **52. GENERAL REPAIR.**

Removal and replacement of defective parts or circuit elements in this equipment are very difficult; great care must be taken to avoid further damage to the equipment or to the part being replaced. Before attempting repairs, make every effort to obtain the proper tools for the job.

**a. Identification of Leads.** It is often necessary to remove other circuit elements to gain access to the defective part. To insure proper reinstallation, make a record of the connections to each removed element and of the position of the element in the equipment.

**b. Electrical Connections.** When replacing leads, clip them as short as possible for satisfactory connection. Avoid using more solder than necessary to make a secure connection. A very slight amount of excess solder dropped accidentally inside the equip-

ment may short other circuits or circuit elements. Some clearances are very small, and extreme care must be exercised in soldering. Do not heat the lug or connection more than is absolutely necessary because of possible damage to near-by elements, such as chokes, capacitors, coil forms, resistors, and wiring. When a wire is connected to a tube socket, the connecting wire should be long enough to prevent pull on the socket. Save time and trouble by making a thorough electrical check of any part that appears to be defective *before* removing it from the equipment.

**CAUTION:** Never change the location of parts or wiring leads. Such a change may necessitate complete recalibration of the equipment. Never change the original length of wiring leads. •

### **53. MECHANICAL REPAIRS.**

When replacing mechanical parts in the equipment, use care in disassembling and reassembling any mechanical units. Use screwdrivers and other tools that fit the job at hand. Secure bolts snugly, but do not overtighten them.

### **54. ECHO BOX TS-207/UP.**

**NOTE:** Complete information on trouble shooting and repair of Echo Box TS-207/UP is given in TM 11-1212 and TM 11-1524.

**a. General.** It is desirable that the dipole and dipole mounting rod and bracket be stowed when not in use. This prevents deterioration of the cable external to the trailer. Install the cap for the feed-through connector when the dipole is stowed.

#### **b. Echo Box.**

(1) If the echo box fails to ring, make the following examinations:

(a) Check cables for continuity and shorting; check center conductor fingers of cable connectors for spreading.

(b) Check the coupling loop at the end of the cable from the pick-up dipole. Use the special wrench to remove the loop. *Do not remove unless necessary* and be careful that no moisture, sand, or grit enters the echo-box cavity.

(2) If the echo box rings and shows customary deflection on the range tubes, but the indicator meter does not operate, proceed as follows:

(a) Remove Crystal Adapter UG-119/UP from echo box



connector. Unscrew crystal adapter at the center and replace crystal IN21B.

(b) Examine connections between crystal adapter and terminal box and from terminal box to indicator meter.

**c. Crystal.** A 1N21B crystal, mounted in Crystal Adapter UG-119/UP, is used with the echo box. Whenever the crystal is being installed, or is out of its holder, it must be kept away from the transmitting antenna if the latter is radiating. It is best to have the radio set off the air whenever crystals are removed from their capsules. Crystals are quite delicate and should always be wrapped in tinfoil to protect them from burnout. If possible they should be kept in metal boxes. When inserting crystals in dry climates or in cold weather it is advisable to ground out any static electricity by touching the finger to the echo box before the crystal makes contact.

## **55. FLUXMETER TS-15A/AP.**

**NOTE:** Complete information on trouble shooting and repair of Fluxmeter TS-15A/AP is given in TM 11-2559.

**a.** Maintenance work on the fluxmeter is restricted to routine inspection and battery replacement as described below. When the fluxmeter develops a major defect, the entire unit must be replaced.

**b.** Install a new battery (Battery BA-30) when full-scale deflection of the gauss meter pointer can no longer be obtained with the measure control (and vernier) turned completely clockwise. For this test on the battery, the range selector switch is set to the A position. If the readings are unsteady, clean the battery terminals. Replace the battery as follows:

(1) Unscrew the knurled cap on the battery compartment on the lower end of the instrument case (fig. 2).

(2) Remove the old battery and replace it with the new one.

(3) Screw the knurled cap firmly into place.

**c.** If the fluxmeter fails to operate, make an inspection of all wiring and connections. An analyzer may be used to check continuity. Before using the analyzer, disconnect the gauss meter and the probe meter from the circuit. *Do not attempt to measure the resistance of the meters or they will be damaged.*

## **56. POWER METER TS-125/AP.**

**NOTE:** Complete information on trouble shooting and repair of Power Meter TS-125/AP is given in TM 11-1217.

**a.** If the power meter will not balance or slowly drifts off balance, new batteries should be installed.

**CAUTION:** Never make any resistance measurements within the power meter while the bridge meter is connected in the circuit. Always disconnect the bridge meter first.

**b.** The power meter is mounted in a watertight case; therefore the back of the case should not be removed unless absolutely necessary. If a resistor is to be replaced, the new part should have the same resistance value and wattage rating as the part being replaced.

**c.** The bridge meter should not be replaced in the field since this operation requires a recalibration of the meter. When thermistor bead TH1 is replaced, the meter shunt R5 must also be replaced with a resistor which matches the new bead.

## **57. RANGE CALIBRATOR I-223-A.**

**a. Mechanical Disassembly and Replacement of Parts.** The top and bottom covers of the calibrator are removed easily by removing the sheet metal screws which hold them in place. The schematic diagram and legend are mounted on the inside of the top cover. Tubes are removable in the usual manner except for the 6L6-GA tubes (or 6L6-G, Tube VT-115-A). These tubes are held by spring clamps. To remove one of these tubes, press down on the two bowed-up portions of the clamp and remove the tube in the usual way. In replacing power transformer 120, the filter choke 121-A, B, or the blocking-oscillator transformer 122, use the following procedure for handling the wire connections.

### **b. Wire Connections.**

(1) Holding the lugs with pliers to keep them from turning, loosen the nuts which hold the lugs to the old transformer or chokes, and lift the lugs off the transformer terminals without disconnecting them from the wires. One exception is the ground lug connection of power transformer 120, which must be unsoldered.

(2) Similarly, remove the lugs from the new unit. Make sure that the lugs and the nuts underneath do not turn; otherwise, entire terminal assemblies may be loosened and the seals broken.

(3) After mounting the new unit, replace the old lugs with wires attached and replace and tighten the nuts. In the case of power transformer 120 connect the ground lead to the ground lug on the transformer case and solder it.

## **58. SIGNAL GENERATOR TS-343/U.**

### **a. General.**

(1) If no reading is obtained on the output meter, inspect the fuses. They are located on the front panel below the OUTPUT control and are easily removed by unscrewing them from their holders. When a fuse blows, replace it with a standard 1-ampere, type 3AG fuse. If the fuses continue to blow, check the power supply source to determine whether or not the correct type (a-c or d-c) and rated value of voltage is being supplied. If the fuses are not defective, the trouble may be caused by a short circuit in the power supply, possibly in the power transformer or in the line filter. If the instrument does not operate and the correct reading cannot be obtained on the output meter, an inspection of the VR-150/30 voltage regulator tube, which is visible through the louvers on the right-hand side of the case, will disclose whether or not the power supply is functioning. The absence of a purple glow in this tube indicates a likelihood of trouble in the rectifier tube, power transformer, filter capacitors, or the line filter. If the regulator tube glows normally but proper indication cannot be obtained on the output meter, the trouble may be in the r-f oscillator unit or its supply leads.

(2) To locate and repair defects inside the signal generator, the instrument must be removed from its case by removing the 12 mounting screws around the edge of the panel. The front panel, to which all the components are attached, can then be lifted from the case. To inspect the r-f unit, remove the black, r-f shield cover. After the cover is removed the various supply voltages to the oscillator can be checked and the type 9002 tube can be removed and tested. It may be well to insert a new 9002 tube, since some tube tests will not adequately indicate the usefulness of the tube as a high-frequency oscillator. This tube should have a mutual conductance of at least 1,800 micromhos as measured on a dynamic mutual-conductance tester. The voltage on the oscillator varies with the frequency range selected and also with the setting of the OUTPUT control.

(3) If the trouble is localized to the power unit, this unit can be removed from the front panel in the following manner:

(a) Unsolder the wires leading from the terminal strip located just above the drum dial.

(b) Unsolder the twisted red and black leads from the power line bypass capacitors located on the front panel directly under the power transformer.

(c) Remove the knobs marked OUTPUT and MODULATION on the front of the panel and remove the 1/2-inch nuts underneath them.

(d) Remove the six screws that hold the power unit in place and lift the entire unit from the front panel. Make sure that only the correct screws are removed when doing this; loosening the wrong screws may cause trouble.

(e) After the trouble has been located and the repair effected, the instrument can be reassembled by reversing the order of the above operations. Do not disturb the adjustment of the three variable rheostats unless recalibration is necessary.

**b. Recalibration Procedures.** A detailed description of the recalibration procedures for percentage of modulation and attenuator output is given in TM 11-1233, Signal Generator TS-343/U. Should the instrument require recalibration, refer to that manual for complete instructions.

## **59. SIGNAL GENERATOR TS-155B/UP.**

**a. General.** The principal parts of the instrument that may require servicing are:

- (1) Cavity.
- (2) Thermistor bridge monitoring system.
- (3) Attenuator.
- (4) Pulsing and internal trigger circuits.
- (5) Power supply.

**NOTE:** The theory of operation of these circuits should be understood before investigating their performance. For a detailed discussion of the theory and trouble-shooting procedures involved in servicing Signal Generator TS-155B/UP, see TM 11-2657B.

**b. Adjustment of Cavity Oscillator for Optimum Operation with Wavemeter Test Set TS-117/GP.**

(1) Connect the power cables of the signal generator and the test oscilloscope to the a-c line.

(2) Turn the POWER switches to ON and the R.F. OSC switch to OFF. Wait 3 minutes for the signal generator and scope to warm up.

- (3) Set the selector switch to CALIB.
- (4) Turn the METER ZERO SET control until the power monitor meter reads zero.
- (5) Turn the R.F. OSC switch to ON.
- (6) Turn the R.F. OSC. OUTPUT potentiometer until the monitoring meter reads approximately 160.
- (7) Turn the R.F. TUNING dial to read 45.
- (8) Adjust the cavity oscillator until the monitor meter reading is a maximum. For the method of tuning and adjusting the cavity, see TM 11-2657B.
- (9) Measure the frequency of the signal generator output at the r-f jack as explained in paragraph 34.
- (10) If the frequency is not in the range from 2,795 to 2,810 megacycles, adjust the cavity oscillator as explained in TM 11-2657B.
- (11) Measure the frequency at 0 and at 100 on the R.F. TUNING to see that the entire band from 2,700 to 2,900 megacycles is covered. If it is not, adjust the cavity oscillator further.
- (12) Turn the R.F. TUNING dial slowly from 5 to 95 while watching the monitoring meter. With the R.F. OSC OUTPUT control on full, a full-scale meter reading should be obtainable over the entire range.

## **60. WAVEMETER TEST SET TS-117/GP.**

**NOTE:** Complete information on trouble shooting and repair of Wave-meter Test Set TS-117/GP is given in TM 11-2528.

**a.** If the meter becomes defective, it may be replaced by an MR258050 d-c microammeter. Mounting holes for this replacement meter are provided in addition to the mounting holes for the existing meter.

**CAUTION:** Never make any resistance measurements within the wavemeter circuit with the microammeter connected. First disconnect the meter.

**b.** If the meter capacitor C-101 becomes shorted, remove it from the circuit and replace it with a good capacitor. If a replacement is not available, however, it may be omitted entirely. A shorted capacitor is indicated when current through the crystal does not cause a deflection of the meter pointer.

**c.** If the meter pointer does not deflect and the cause is not a shorted capacitor, the sensitivity potentiometer or the resistor

in series with it may be defective. If the meter pointer deflects and the sensitivity cannot be controlled, the potentiometer should be checked and replaced if necessary. If the resistor in series with the potentiometer is defective, it may be replaced by any resistor in the range of 200 to 500 ohms.

**d.** Handle crystals with care. In dry climates handle a crystal as little as possible, because static discharges from the fingers will burn it out. Never allow a crystal to be left unshielded when near fields of microwave energy; such fields also burn out crystals.

**e.** To make a qualitative test on a crystal, measure its resistance with a high range of the ohmmeter. Connect the ohmmeter test prods across the crystal terminals and note the resistance reading. Then reverse the test prods and note the resistance reading in the opposite direction. If the ratio of the two resistance values is not greater than 1:1, the crystal is worthless. However, a ratio as low as 3:1 or even 2:1 does not necessarily indicate a useless crystal. The sure way to determine the worth of a crystal is to compare its operation in the wavemeter with that of a crystal known to be good.

**f.** To replace a crystal, remove the wavemeter backplate, unscrew the knurled nut on the TUNE TO DIP plumbing, and remove the defective crystal and its holder (fig. 40). Install a new crystal and holder. If a supply of crystals is at hand, a new crystal can be placed in the removed holder. Install the crystal and holder and tighten the knurled nut into place. Replace the wavemeter backplate.

## SECTION VI SUPPLEMENTARY DATA

### 61. MAINTENANCE PARTS LIST FOR TEST SET AN/MPM-9.

<i>Ref symbol</i>	<i>Signal Corps stock No.</i>	<i>Name of part and description</i>	<i>Mfr's part and code No.</i>
	2Z299-358	ADAPTER M-358: SC-D-5889.	
	2Z299-359	ADAPTER M-359: SC-D-5890.	
	2Z296-18	ADAPTER U-18/UP: SC-D-12055.	
	2A264-23	ANTENNA ASSEMBLY AS-23/AP: SC-D-12021.	
	3A30	BATTERY BA-30.	
	3H672-96	CABINET BE-96: SC-D-13655.	
	2Z1800.30	CASE, neon lamp: acetate; 6" x 3½" x 1"; Shoe Form Co Inc Series #20.	
	2Z2599-273	CHEST CH-273: SC-D-11848.	
	1F430-70	CORD CG-70/MPM: 15' lg; SC-D-11881, group 2.	
	1F430-71	CORD CG-71/MPM: 6' lg; SC-D-11881, group 1.	
	1F430-135	CORD CG-135/UP: 25' lg; SC-D-12052, group 2.	
	1F430-136	CORD CG-136/UP: 36' lg; SC-D-12052, group 3.	
	3E6000-245	CORD CX-245/UP: 8' 2½" lg; SC-D-12049, group 1.	
	3E6000-246	CORD CX-246/UP: 8' 2½" lg; SC-D-12049, group 2.	
	3E6000-247	CORD CX-247/UP: 8' 1½" lg; SC-D-12049, group 3.	
	3E6000-248	CORD CX-248/UP: 8' 1½" lg; SC-D-12050, group 1.	
	3E6000-249	CORD CX-249/UP: 8' 3" lg; SC-D-12050, group 2.	
	3E6000-250	CORD CX-250/UP: 8' 3" lg; SC-D-12050, group 3.	

**61. MAINTENANCE PARTS LIST FOR TEST SET AN/MPM-2 (contd).**

Ref symbol	Signal Corps stock No.	Name of part and description	Mfr's part and code No.
	3E6000-251	CORD CX-251/UP: 5' lg; SC-D-12051, group 1.	
	3E6000-252	CORD CX-252/UP: 8' 2½" lg; SC-D-12051, group 2.	
	3E6000-253	CORD CX-253/UP: 8' 2½" lg; SC-D-12051, group 3.	
	3E6000-254	CORD CX-254/UP: 8' 2" lg; SC-D-12052, group 1.	
	3E6000-255	CORD CX-255/UP: 5' 2" lg; SC-D-12053.	
	3E6000-256	CORD CX-256/UP: 8' lg; SC-D-12054, group 1.	
	3E6000-257	CORD CX-257/UP: 8' 2½" lg; SC-D-12054, group 2.	
	3E6000-258	CORD CX-258/UP: 8' 2½" lg; SC-D-12054, group 3.	
	3E6000-259	CORD CX-259/UP: 8' 3" lg; SC-D-12056, group 1.	
	3E6000-260	CORD CX-260/UP: 8' 3" lg; SC-D-12056, group 2.	
	3E6000-261	CORD CX-261/UP: 6' 10" lg; SC-D-12056, group 3.	
	3E6000-262	CORD CX-262/UP: 8' lg; SC-D-12075, group 1.	
	3E6000-263	CORD CX-263/UP: 8' lg; SC-D-12075, group 2.	
	2J1N21B	TUBE, crystal rectifier 1N21-B.	
	2Z308-119	CRYSTAL ADAPTER UG-119/UP: SC-D-12024.	
	3F4325-208	DUMMY ANTENNA TS-208/MPM: SC-D-12010.	
	3F4325-207	ECHO BOX TS-207/UP: SC-D-12015.	
	3F4325-15A	FLUXMETER TS-15A/AP: Marion Elec Inst Co type #MFM-2.	
	6Q51211	HANDLE: for spinner motor shaft seal nut wrench; Miller Tool & Mfg Co type #MTM-SL-15.	
	2Z5954	LAMP LM-54.	
	2Z7226-258	PLUG PL-258: SC-D-5887.	
	3F4325-125	POWER METER TS-125/AP: Cover Dual Signal System Corp.	
	6R7396-1	PULLER, universal coupling: Miller Tool & Mfg Co type #MTM-SL-22.	
	2Z7390-30	RADIO-FREQUENCY JACK UG-30/U.	



**61. MAINTENANCE PARTS LIST FOR TEST SET AN/MPM-2 (contd).**

<i>Ref symbol</i>	<i>Signal Corps stock No.</i>	<i>Name of part and description</i>	<i>Mfr's part and code No.</i>
	3F2440-223A	RANGE CALIBRATOR I-223-A.	
	3H4691-66B	RECTIFIER RA-66-B.	
	3H4691-69B	RECTIFIER RA-69-B.	
	3H4691-70A	RECTIFIER RA-70-A.	
	3H4691-72B	RECTIFIER RA-72-B.	
	3F4325-343B	SIGNAL GENERATOR TS-343/UP; Measurements model 78F.	
	3F4325-155B	SIGNAL GENERATOR TS-155B/UP.	
	3F4325-224A	SIGNAL GENERATOR TS-224A/UP.	
	6R57585-219	SPANNER WRENCH MX-219/UP; SC-B-12027.	
	2Z9323-74	TERMINAL BOX J-74/MPM; SC-D-12045.	
	3F4325-210	TEST ANTENNA TS-210/MPM; SC-B-12009.	
	6Z8648-3	THERMOMETER; Henry J Green type #213.	
	6Z1744	THERMOMETER CASE; Henry J Green type #600.	
	3F4325-117	WAVEMETER TEST SET TS-117/GP.	
	6R57080	WRENCH: elevation adjusting nut; Miller Tool & Mfg Co type #MTM-SL-12.	
	6R57105-3	WRENCH: spinner motor shaft seal nut; Miller Tool & Mfg Co type #MTM-SL-15.	
	6R57105-2	WRENCH: spinner motor seal; Miller Tool & Mfg Co type #MTM-SL-18.	
	6R57105	WRENCH: spinner motor flange; Miller Tool & Mfg Co type #MTM-SL-19.	
	6R57449	WRENCH: elevation; potentiometer gear; Miller Tool & Mfg Co type #MTM-SL-20.	
	6R57105-1	WRENCH: elevation; potentiometer gear nut; Miller Tool & Mfg type #MTM-SL-21.	