

MIL-HDBK-161A

DEPARTMENT OF THE ARMY TECHNICAL MANUAL
DEPARTMENT OF THE NAVY PUBLICATION
DEPARTMENT OF THE AIR FORCE TECHNICAL ORDER

TM 11-487A-3
NAVEXOS P-2058
TO 31-31-3-73

MILITARY STANDARDIZATION HANDBOOK

ELECTRONIC COMMUNICATION EQUIPMENT



Third and Final Increment to MIL-HDBK-161A, 12 March 1964

FSC MISC

DEPARTMENTS OF THE ARMY AND NAVY
WASHINGTON, D.C, 12 March 1964

This Military Handbook is issued for the use of all concerned

By Order of the Secretaries of the Army and the Navy:

HAROLD K. JOHNSON,
General, United States Army,
Chief of Staff.

Official:

J. C. LAMBERT,
Major General, United States Army,
The Adjutant General.

W. A. SCHOECH,
Vice Admiral, United States Navy,
Chief of Naval Material.

Distribution:

Active Army:

CNGB (3)
CC-E (5)
Dir of Trans (5)
CofEngrs (5)
USAADEA (1)
USACDCARMSA (1)
USACDCIA (1)
USACDCINTA (1)
USACDCEA (2)
USACDCCBRA (1)
USACDCCEA (1)
USACDCOA (2)
USACDCQMA (1)
USACDCTA (1)
USACDCADA (1)
USACDCARMA (1)
USACDCAVNA (1)
USACDCARTYA (3)
USACDCSWA (1)
USAMC (10)
USAECOM (50)
USAMUCOM (10)
USAWECOM (10)
USATECOM (10)
USAMOCOM (10)
USAAVNC (4)
USAADCEN (1)
USAAESWBD (2)
USARADB (2)
USAATC (1)
USAMB (2)

USAIB (1)
USCONARC (2)
ARADCOM (2)
OS Maj Comd (4)
LOGCOMD (2)
USAMICOM (10)
USASMC (20)
USASCC (2)
MDW (1)
Armies (2) except
 First US Army (4)
USMA (2)
USACGSC (4)
USAAMS (6)
USAADS (4)
USAIS (6)
USASCS (10)
USASESCS (6)
USAARMS (6)
WRAMC (1)
BAMC (1)
Fort Mason (2)
Fort McClellan (2)
Fort Ord (2)
Fort Bragg (2)
Fort Shafter (1)
WSMR (2)
Army Dep (1) except
 LXAD (2)
 SAAD (2)
 TOAD (2)

FTWOAD (2)
LEAD (2)
SHAD (2)
APG (2)
YTS (2)
USA Elct PG (6)
DPG (1)
JPG (1)
EPGA (1)
Army Tml (1)
Arsenals (1)
Sig Fld Maint Shops (2)
Proc Dist (1)
Harry Diamond Lab (2)
Natick Lab (2)
USA CBR Lab (1)
Units org under fol TOE:
(1 copy each)
11-5
11-15
11-22
11-55
11-95
11-155
11-555
11-558
11-587
11-592
11-597

NG: State AG (3).

USAR: None.

For explanation of abbreviations used, see AR 320-50.

MILITARY STANDARDIZATION HANDBOOK

ELECTRONICS COMMUNICATION EQUIPMENT

TO ALL ACTIVITIES:

1. The following pages of MIL-HDBK-161A are to be added:

<i>Categories</i>	<i>Pages</i>	<i>Date</i>
List of Type Indicators.....	i	12 March 1964
Item Descriptions.....	595	12 March 1964
Appendix B.....	971	12 March 1964

2. Retain this notice and insert before the Table of Contents.

(THIRD INCREMENT)

LIST OF TYPE INDICATORS

<i>Type Indicator</i>	<i>Page</i>	<i>Type Indicator</i>	<i>Page</i>
AN/TGC -----	595	AN/UIC -----	781
AN/TIP -----	611	AN/UNH -----	783
AN/TIQ -----	613	AN/URA -----	787
AN/TRA -----	619	AN/URC -----	811
AN/TRC -----	633	AN/URR -----	825
AN/TRQ -----	685	AN/URT -----	861
AN/TRR -----	689	AN/USA -----	883
AN/TRT -----	693	AN/USM -----	885
AN/TSA -----	701	AN/UXH -----	887
AN/TTC -----	703	AN/VIA -----	891
AN/TTQ -----	705	AN/VIC -----	893
AN/TXA -----	709	AN/VRC -----	895
AN/TXC -----	713	AN/VRQ -----	947
AN/TXR -----	723	AN/VRR -----	953
AN/UGA -----	725	AN/WRA -----	959
AN/UGC -----	727	AN/WRC -----	965
AN/UGR -----	777	AN/WRR -----	967
AN/UGT -----	779	AN/WRT -----	969



TELETYPEWRITER SET

AN/TGC-1()

FUNCTIONAL DESCRIPTION:

Teletypewriter Set AN/TGC-1() is an automatic, high-speed, multichannel, teletypewriter station equipment used for sending, receiving, or monitoring, by means of typed and perforated paper tape.

This equipment consists of a single operating assemblage composed of a multiple transmitter-distributor (which provides one number transmitter and two message transmitters) and two typing reperforators. It can be used for conventional duplex make-and-break, duplex polar, single, split duplex make-and-break, split duplex polar, or split single operation.

Several of these equipments may be installed side by side for handling large traffic loads. It can be used for tape-relay operation, and is designed for continuous operation.

It operates on 115-volt ac or dc; the tapewinder motor operates on ac only.

RELATIONSHIP TO SIMILAR EQUIPMENT:

TECHNICAL DESCRIPTION:

Operating Functions: No keyboard; number release key; message release key; tape feed key; break key; alarm switch.

Operating Speed: 368.1 or 600.0 opm.

Motor Characteristics: Series-governed motor, tuning fork adjustable to 2,102 rpm, or a synchronous motor requiring no adjustment.

Power Requirements: 115-v dc; or 115-v 50/60-cycle ac.

Major Units:

1	Cabinet	24" x 24" x 65"	250 lbs
1	54A	5" x 15 ³ / ₄ " x 6 ³ / ₄ "	35 lbs
1	Distributor-transmitter (multiple)	15 ¹ / ₄ " x 16 ³ / ₄ " x 5 ³ / ₄ "	90 lbs
2	Reperforators	13" x 12" x 8"	34.25 lbs

TUBES, CRYSTALS, TRANSISTORS:

REFERENCE DATA AND LITERATURE:

TM 11-2203
(USA) SC-D-31245

TELETYPEWRITER SET
AN/TGC-3

1 March 1964

Cog. Serv: USA FSN: 5815-198-9035

USA Line Item No.: 680840

	USA	USN	USAF	USMC
STATUS OR TYPE CLASS.:	Std B		Std	

Manufacturer: Western Electric Co

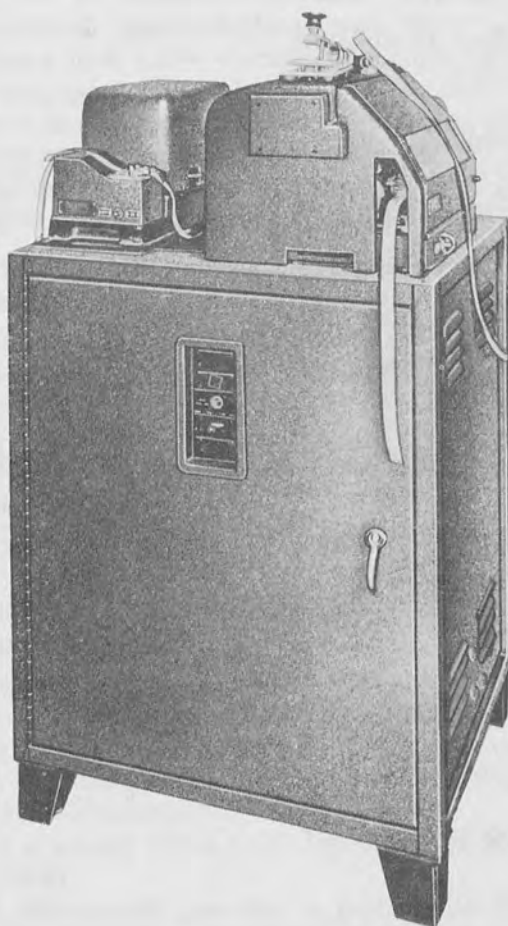

AN/TGC-3

FUNCTIONAL DESCRIPTION:

Teletypewriter Set AN/TGC-3 is an automatic transmitting and receiving unit used for torn-shape switching or teletypewriter relay applications of by means of typed and perforated paper tape.

TELETYPEWRITER SET

AN/TGC-3

This equipment consists essentially of a transmitter-distributor and a receiving-only typing reperforator. It includes an operating table and related accessories. Tape received by means of the reperforator unit can be used to transmit through the transmitter-distributor.

The set operates in neutral or polar channels and can be used with telegraph terminal equipment and with Teletypewriter Repeater-Mixer AN/FGQ-1.

RELATIONSHIP TO SIMILAR EQUIPMENT:

TECHNICAL DESCRIPTION:

Transmission and Reception: Polar or neutral
Tape:

Width: $1\frac{1}{16}$ "

Type: Perforated, chad, or chadless

Operating Speed: 368 opm

Motor Characteristics:

Type: Series-governed

Cycles per Second: 87.6

Revolutions per Minute: 2,100

Power Requirements:

With Power Unit: 300 w; 95-, 125-, 190-, or 250-, 25- or 60-cycle, ac

Without Power Unit:

dc Supply: 120 v (3), 0.8 amp drain

ac Supply: 115-v 60-cycle ac

Major Units:

1 TT-52/FG

9" x $9\frac{3}{8}$ " x $15\frac{1}{2}$ "

33 lbs

1 PP-748/U

$13\frac{5}{16}$ " x $11\frac{7}{8}$ " x $20\frac{3}{4}$ "

89 lbs

1 TT-53/FG

$11\frac{3}{4}$ " x $13\frac{1}{2}$ " x $16\frac{3}{4}$ "

62.25 lbs

1 Table

34" x 22" x 26"

205 lbs

TUBES, CRYSTALS, TRANSISTORS:

REFERENCE DATA AND LITERATURE:

TM 11-2214

TELETYPEWRITER SET
AN/TGC-14(V)

October 1, 1961
 Cog. Serv: Marine Corps FSN:
 USA Line Item No.: 968078

	USA	USN	USAF	USMC
STATUS OR TYPE CLASS:				Std
Manufacturer:	09083, 26344			

No Illustration Available

FUNCTIONAL DESCRIPTION:

This unit is a miniaturized, portable, self-contained sending and receiving teletypewriter housed in a rugged, water-resistant, shock-resistant, glass fibre carrying case. It provides for continuous printing of messages over radio circuits, wire lines, and other communications links. It is capable of transmitting and receiving a 64-character alphabet and has the capacity of remote turn-on and turn-off thus permitting unattended operation in fixed, mobile, vehicular or airborne installations. The equipment can operate in both extreme cold and heat and under conditions of severe shock, vibration, humidity, salt atmosphere, and sand and dust; and is unaffected by altitude. It is compatible with conventional nontactical teletypewriter sets and associated equipment.

RELATIONSHIP TO SIMILAR EQUIPMENT:

Similar to Airborne Teletypewriter TT-264/AG
 Similar to Shipboard Teletypewriter TT-299/UG and Shipboard Teleprinter TT-298/UG.

TECHNICAL DESCRIPTION:

Power Requirements: 28 v dc or 115 v 60 cy 1 phase ac or 115 v 400 cy 1 phase ac, depending on motor and electronics used.

Signal Line Requirements: 3 v 1-5 ma in low range. 20-80 ma in high range. Non-polarity sensitive input.

Service Cable input receptacle: Amphenol Type 165-11

Units of major importance:

TT-297/UG Teletypewriter (FSN 5815-798-0351)

TT-318/UG Keyboard Transmitter (FSN 5815-798-3856)

Carrying Case CY-2976/PG (FSN 5815-798-0344) or Case CY-2977/PG

Power Supply Kit, ac MK-539/UG (FSN 5815-798-0345) or Power Supply Kit, dc, MK-540/UG (FSN 5815-798-0346)

Motor, ac, PD-82/U (60 cps) (FSN 6105-798-0347) or Motor, ac, PD-83/U (400 cps) (FSN 6105-798-0350)

CY-2976/UG Case. Equipment mounted in position by 4 $\frac{1}{4}$ " x 20 screws secured into steel inserts set in rubber feet affixed to bottom of case. When used with shockmounts equipment mounted in position by 6 $\frac{1}{4}$ " x 28 screws secured into threaded inserts in shockmounts.

CY-2977/PG Case. Airborne type shockmounts mounted in position by 8 $\frac{1}{4}$ " x 28 screws. Mount hooks into rear of case with thumb screws holding front thus permitting quick release and removal without unscrewing 8 screws in shockmounts.

Major Units: 19 $\frac{1}{4}$ " x 16 $\frac{1}{4}$ " x 8"

39 lbs

TELETYPEWRITER SET

AN/TGC-14(V)

TUBES, CRYSTALS, TRANSISTORS:

REFERENCE DATA AND LITERATURE:

Specification—Marine Corps CSY-3-FY60-12A

Technical Manual TM 03315-15

Repair Parts List SL-4-00315

Outline and Installation Drawings:

Case, CY-2976/PG, MITE Corporation No. D617-104

Shockmounts, MITE Corporation No. 5060-2

Case, CY, 2977/PG, MITE Corporation No. D618-104

Shockmounts, MITE Corporation No. 5060-3

AN/TGC-type
TELETYPEWRITER SET

EE-98-()

1 March 1964

Cog. Serv: USA FSN: 5815-164-7113

USA Line Item No.: 680960

USA

USN

USAF

USMC

STATUS OR TYPE CLASS.:

L/Std

Manufacturer:

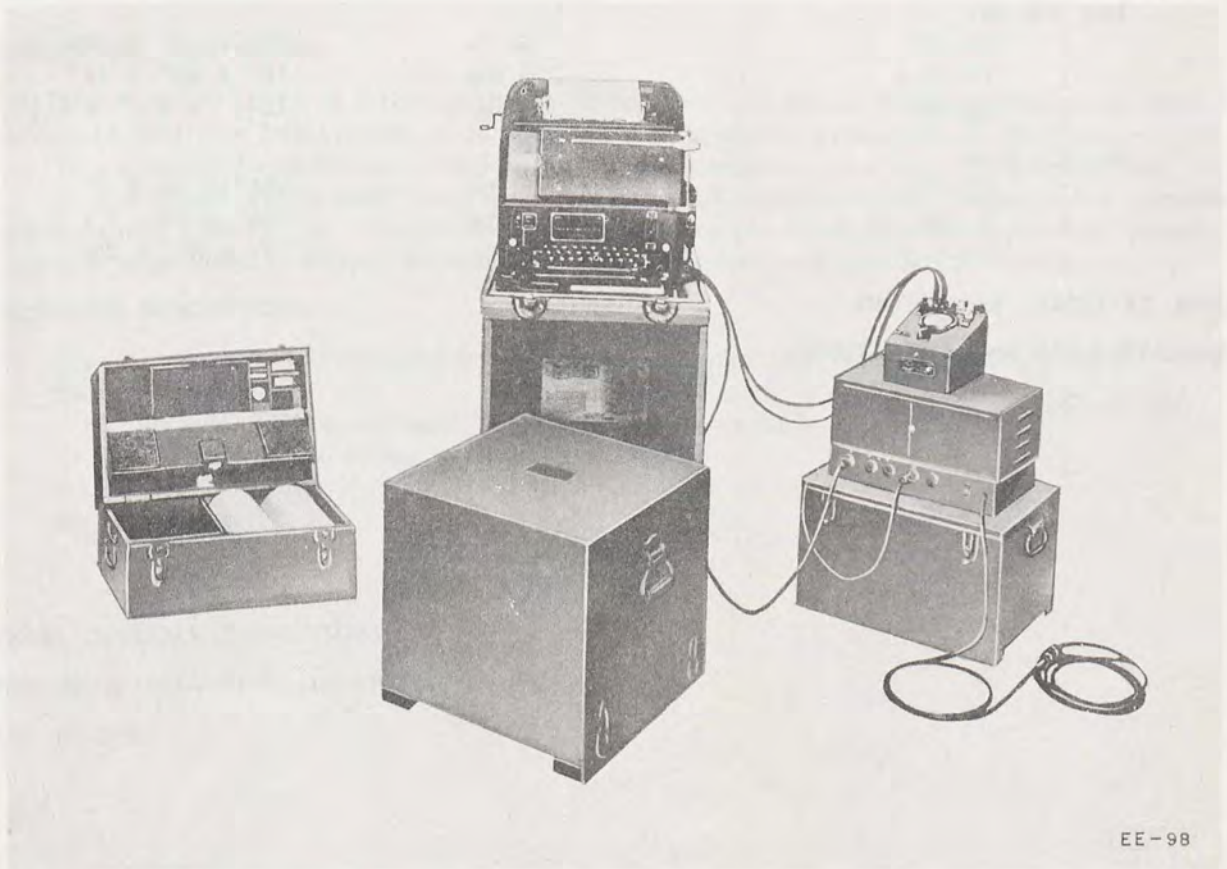

EE-98

FUNCTIONAL DESCRIPTION:

Teletypewriter Sets EE-98 and EE-98-A are complete, transportable, field teletypewriter stations which require only connection to power and communication lines in order to operate.

This equipment consists of a conventional page-printing teletypewriter, line control unit, rectifier, and related accessories contained in carrying cases. It can be used in conjunction with carrier terminal facilities and at teletypewriter centrals and radio terminals.

The equipment is designed for quick installation in the open or under shelter. It is connected for operation by means of cords and plug connectors.





MIL-HDBK-161A/TM11-487A-3/NAVEXOS P-2058/TO 31-3-73

AN/TGC-type
REPEATER SET

TC-18



AN/TGC-type
TELETYPEWRITER SET

TG-7-B

1 March 1964

Cog. Serv: USA FSN: 5815-198-9029

USA Line Item No.: 680180

USA

USN

USAF

USMC

STATUS OR TYPE CLASS.:

L/Std

Manufacturer: Teletype Corp

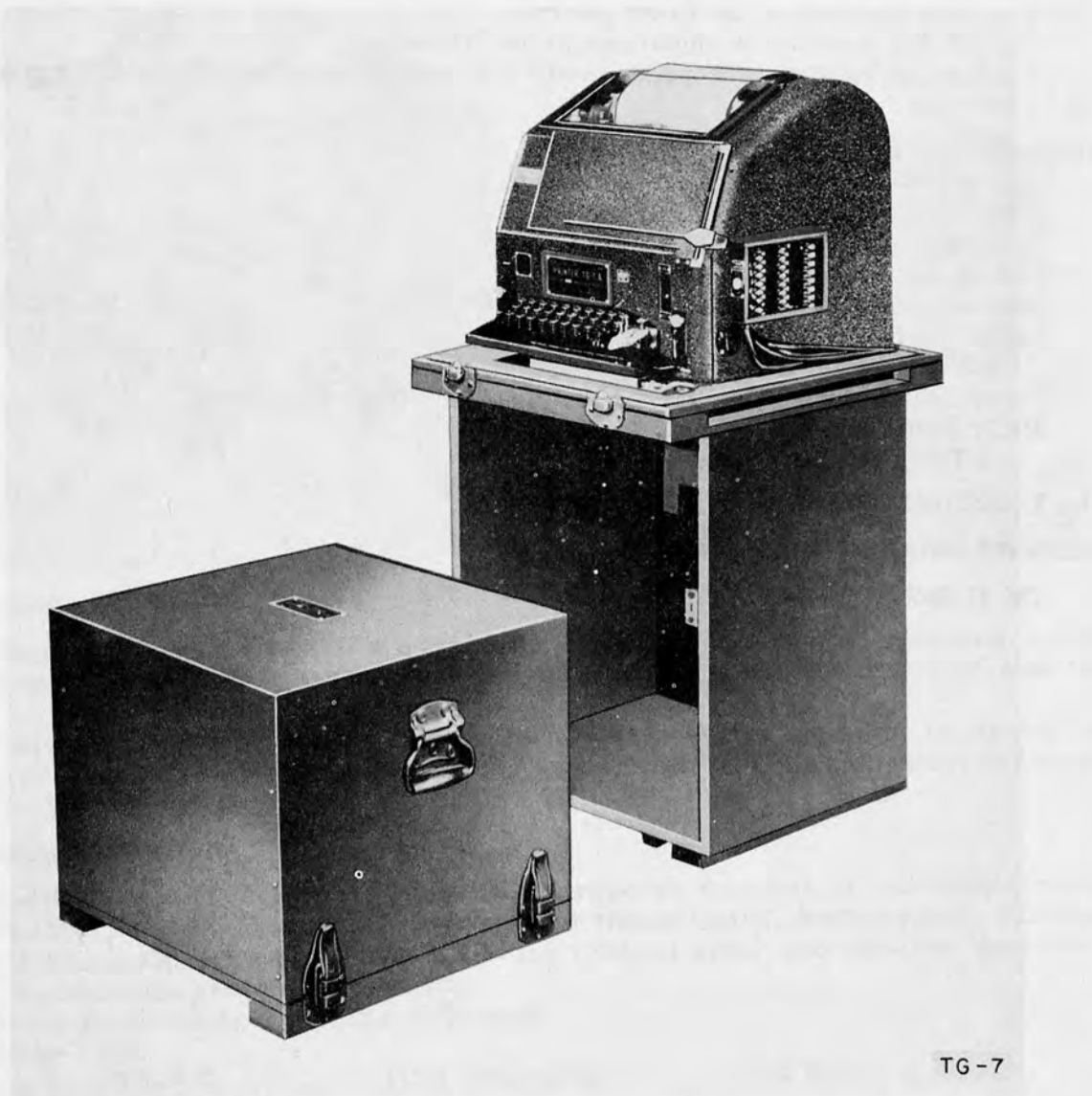

TG-7

AN/TGC-type
TELETYPEWRITER SET

TG-7-B

FUNCTIONAL DESCRIPTION:

Teletypewriter TG-7-B is portable, page-printing sending and receiving teletypewriter station equipment designed for the interchange of typewritten messages between two or more points connected by telegraph communication channels.

The equipment consists essentially of a modified commercial teletypewriter (Teletype Corp Model 15) and two chests. One chest serves as a seat for the operator; the other is used as an operating table for the teletypewriter.

The TG-7-B may be adjusted to operate at 404 operations per minute (67 words per minute) for interoperation with British equipment by increasing the speed of the motor. This is done by changing the adjustment of the motor governor.

The TG-7-B is similar in appearance to the TG-7-A.

The B model, however, will operate on 115-v, 40-cy ac in addition to 115-v, 25-cy ac or 115-v, 50- to 60-cy ac.

TECHNICAL DESCRIPTION:

Type Keyboard: Standard communications

Characters per Line: 72

Operating Speed: 368 opm, 60 wpm

Code: 5-unit, start-stop

Transmission Pattern: 7.5-unit

Number of Channels: 1

Type Motor: Series-governed

Power Requirements: 95 w, 115-v 25/50- to 60-cy 1-phase ac; 115-v dc

Major Units:

1 Teletypewriter (Teletype Mode 15)

TUBES, CRYSTALS, TRANSISTORS:

REFERENCE DATA AND LITERATURE:

TM 11-352

AN/TGC-type
TELEGRAPH TERMINAL

TH-5/TG

1 March 1964

Cog. Serv: USA FSN: 5805-240-6225

USA Line Item No.: 681702

	USA	USN	USAF	USMC
STATUS OR TYPE CLASS.:	Std A		Std	

Manufacturer:

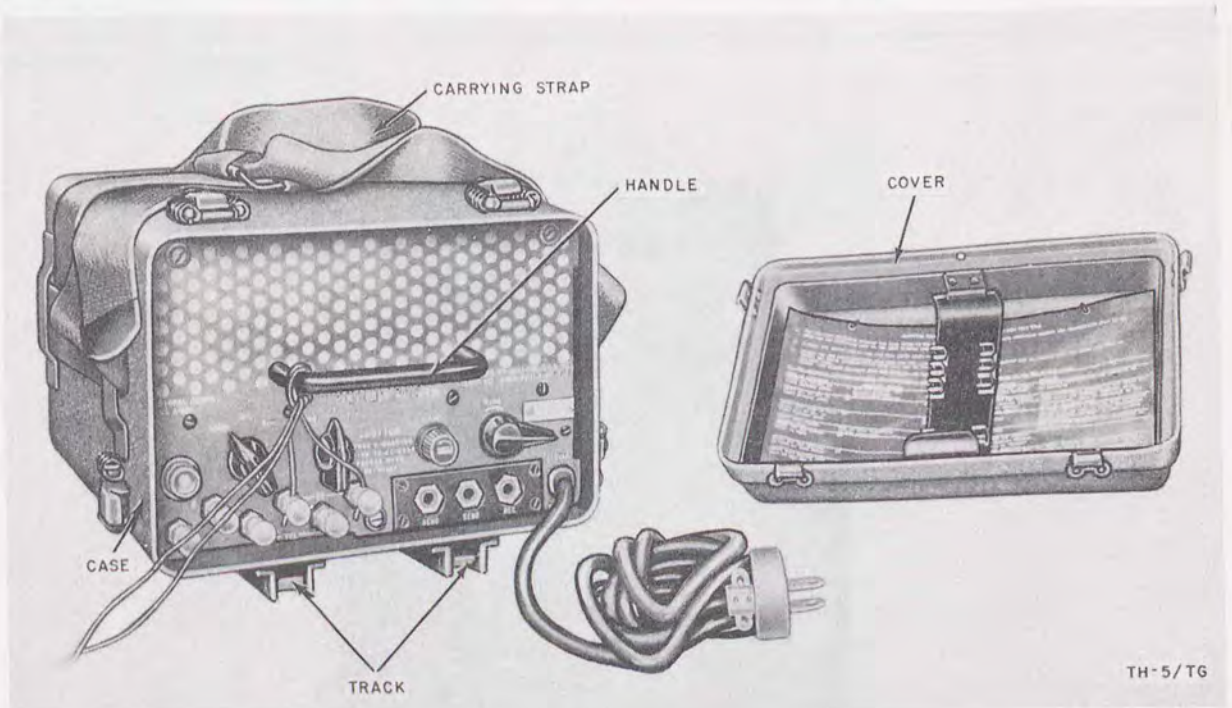

TH-5/TG

FUNCTIONAL DESCRIPTION:

Telegraph Terminal TH-5/TG is a small, transportable, frequency-shift modulator and demodulator equipment used in one-way reversible operation of teletypewriter circuits over two-wire, four-wire, or radioteletype facilities.

This equipment can be operated in conjunction with associated equipment in circuits controlled by either local-battery or common-battery switchboards. It can also transmit and receive 20-cycle signaling current.

TECHNICAL DESCRIPTION:

Facilities Required: Teletypewriter equipment; two-wire, four-wire, or radioteletype circuits

Facilities Provided: Translates dc teletypewriter signals into vf, frequency-shift, 1,225- and 1,325-cps signals; or demodulates 1,225- and 1,325-cps signals and translates them into dc impulses; also provides 20-cps ringing

Power Requirements: 60 w, 115-v 40/60-cy ac

Major Units:

1 TH-5/G

11" x 10½" x 7½"

18.5 lbs

AN/TGC-type
TELEGRAPH TERMINAL

TH-5/TG

TUBES, CRYSTALS, TRANSISTORS:

REFERENCE DATA AND LITERATURE:

TM 11-2239

AN/TGC-type
TELETYPEWRITER

TT-4()/TG

1 March 1964

Cog. Serv: USA FSN: 5815-198-4433

USA Line Item No.: 680180

	USA	USN	USAF	USMC
STATUS OR TYPE CLASS.:	Std A		L/Std	

Manufacturer: Kleinschmidt, Inc



TT-4/TG

FUNCTIONAL DESCRIPTION:

Teletypewriter TT-4()/TG is a portable, lightweight, page-printing teletypewriter for the transmission, monitoring, and reception of messages at battalion headquarters and communications centers of higher headquarters. It is immersionproof and may be floated during amphibious operations and can be carried on a standard packboard.

Normally used in neutral circuits only, this equipment may be adapted to receive and transmit polar signals. It can be connected to distant teletypewriters in field wire or cable, open wire,

AN/TGC-type
TELETYPEWRITER

TT-4()/TG

carrier or radio systems. It can be arranged for half-duplex, full-duplex, receiving only, or sending-only operation.

When suitable power for the motor and line is available, two or more Teletypewriters TT-4()/TG may be connected directly and operated without associated line equipment.

This teletypewriter is the major operating component of tactical Teletypewriter Set AN/PGC-1 and fixed station Teletypewriter TT-61/FG.

TECHNICAL DESCRIPTION:

Operating Functions: Keyboard operation; remote motor stop; break-in facilities

Operating Speed: 368.1 opm (60 wpm); gears furnished for 600 opm (100 wpm)

Motor Characteristics: Universal (ac or dc) series type

Motor Speed: Tuning fork adjusted to 180 vps; 3,600 rpm

Power Requirements: 105-125-vdc; or 150 w, 105-125-v 50/60-cy 1-phase ac

Major Units:

1	TT-4/TG	22½" x 18⅞" x 11¼"	43 lbs
---	---------	--------------------	--------

TUBES, CRYSTALS, TRANSISTORS:

REFERENCE DATA AND LITERATURE:

TM 11-2234

MIL-T-14579

PUBLIC ADDRESS SET

AN/TIP-2

1 December 1958

Cog. Serv: USN FSN: 5830-511-4448

USA Line Item No.: 633525

USA

USN

USAF

USMC

STATUS OR TYPE CLASS.:

Std

Manufacturer:

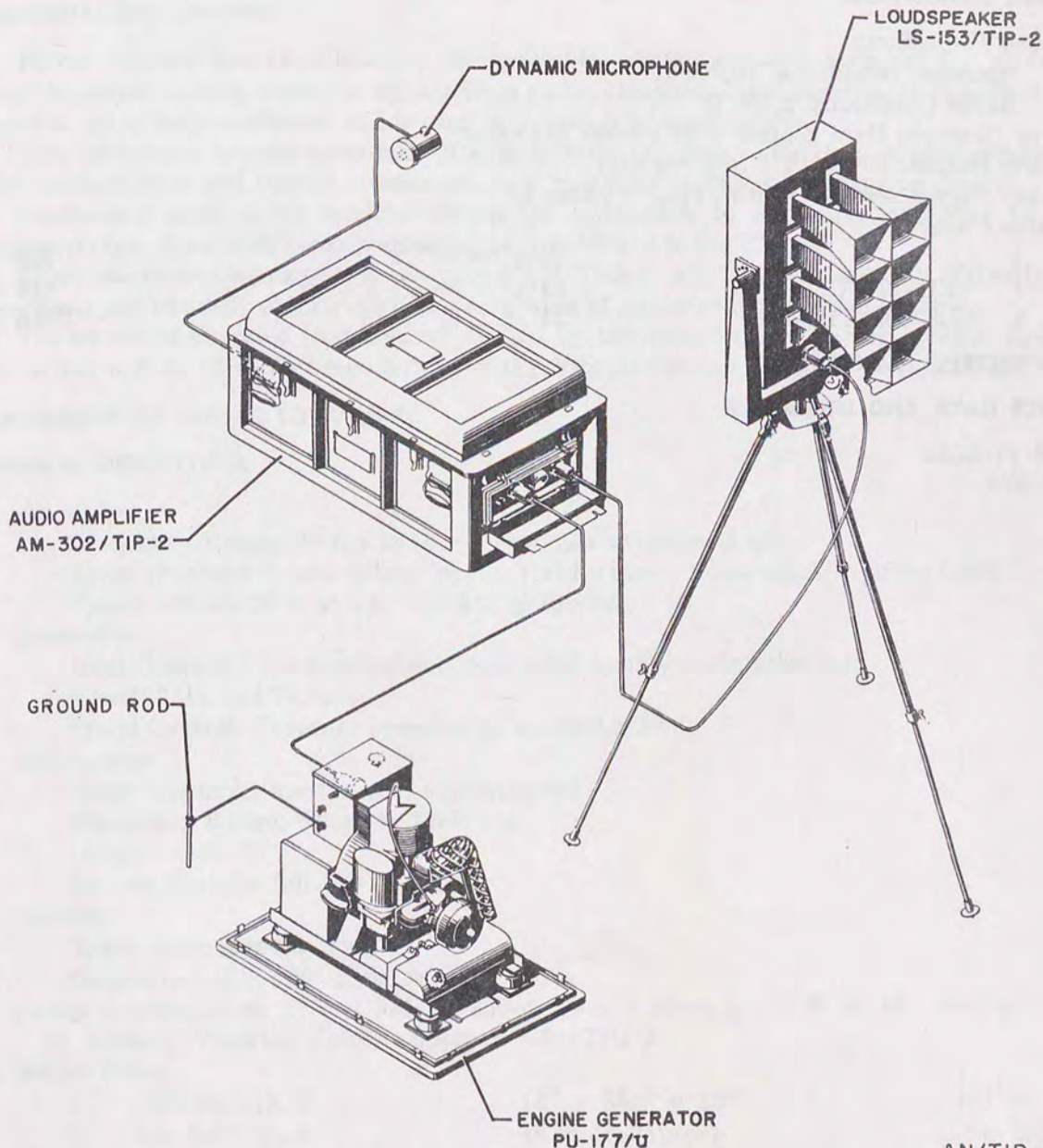

AN/TIP-2

PUBLIC ADDRESS SET

AN/TIP-2

FUNCTIONAL DESCRIPTION:

Public Address Set AN/TIP-2 is a transportable, high-level, high-gain system used for the distant projection of a signal during landing operations.

This equipment can be operated from a microphone or telephone-line signal input over a wide temperature range and under adverse weather conditions.

RELATIONSHIP TO SIMILAR EQUIPMENT:

TECHNICAL DESCRIPTION:

Sound Projection:

Optimum conditions: 10,000 ft

Battle Conditions: 2,500 ft

Type Controls: Gain control with volume indicator

Power Output: 500 w (350 to 5,000 cps)

Power Requirements: 1,100 w, 115-v 1-phase ac

Major Units:

1		74 $\frac{1}{4}$ " x 34" x 19 $\frac{3}{4}$ "	220 lbs
1	PU-177/U	24 $\frac{1}{4}$ " x 28 $\frac{1}{4}$ " x 20 $\frac{5}{8}$ "	615 lbs
1	LS-153/TIP-2	24" x 17 $\frac{1}{4}$ " x 13"	106.5 lbs

TUBES, CRYSTALS, TRANSISTORS:

REFERENCE DATA AND LITERATURE:

TM 11-5554

CS-276

PUBLIC ADDRESS SET

AN/TIQ-2()

1 March 1964

Cog. Serv: USA FSN: 5830-164-6618

USA Line Item No.: 633540

	USA	USN	USAF	USMC
STATUS OR TYPE CLASS.:	Std A	Used by	L/Std	

Manufacturer:

FUNCTIONAL DESCRIPTION:

Public Address Set AN/TIQ-2() is a portable, electrical sound amplification system designed to project speech, music, or signals from radio, communication circuits, or records. It is intended to serve large audiences and is used in a variety of applications.

This equipment consists essentially of a medium-power audio amplifier, a phonograph turntable, loudspeakers, and related accessories. It is contained in field-type carrying cases.

Provision is made in the amplifier output for connection to a booster amplifier to obtain added coverage. A suitable booster amplifier is Amplifier AN-20/TIQ-2.

There are three models of this equipment AN/TIQ-2, AN/TIQ-2A, and AN/TIQ-2B; all of these items are basically similar with the exception of minor changes in components.

The set can be operated from sources of 115- or 230-volts of alternating-current power, or from either a 6- or 12-volt storage battery using Vibrator Power Supply PP-31/TIQ-2.

RELATIONSHIP TO SIMILAR EQUIPMENT:**TECHNICAL DESCRIPTION:***Amplifier:*

Frequency Range: 50 cps to 10,000 cps; max variation 3 db

Input channels: 5 microphone inputs, 1 radio input, 1 line input, 1 phone input

Power Output: 20 w at less than 5% distortion

Turntable:

Heat Control: 75 w heating unit controlled by thermostatic switch

Speed: 33 $\frac{1}{3}$ and 78 rpm

Speed Control: Governor operated by accessible lever

Microphone:

Type: Dynamic, moving coil, unidirectional

Frequency Range: 60 cps to 7,500 cps

Output: -56 db

Swivel: Permits full 180° travel

Speaker:

Type: Permanent magnet

Impedance: 250, 500, 1,000 or 2,500 ohms

Power Requirements: 275 w; 115- or 230-v, 60-cy 1-phase ac; or 6- or 12-v storage battery dc through Vibrator Power supply PP-31/TIQ-2

Major Units:

1	AM-20/TIK-2	14" x 8 $\frac{3}{4}$ " x 19"	151 lbs
2	LS-103/TIQ-2	48 lg (collapsed)	18.5 lbs

PUBLIC ADDRESS SET

AN/TIQ-2()



- | | | |
|---|---------------|-------------------------------|
| 1 | MX-39/TIQ-2 | 19" x 15" x 6" |
| 1 | AM-20A/TIQ-2 | 19" x 14" x 8 $\frac{3}{4}$ " |
| 2 | LS-103A/TIQ-2 | 48 lg (collapsed) |
| 1 | MX-39A/TIQ-2 | 19" x 15" x 6" |

18.5 lbs

PUBLIC ADDRESS SET

AN/TIQ-2()

1 AM-20B/TIQ/2
2 LS-103B/TIQ-2
1 MX-39A/TIQ-2

1^o x 14" x 8³/₄"
3 lg (collapsed)
19" x 15" x 16"

18.5 lbs

TUBES, CRYSTALS, TRANSISTORS:

REFERENCE DATA AND LITERATURE:

TM 11-2586
7-3023

THE UNIVERSITY OF CHICAGO

PHYSICS DEPARTMENT

PHYSICS DEPARTMENT
5712 S. DICKINSON ST.
CHICAGO, ILL. 60637



PHYSICS DEPARTMENT
5712 S. DICKINSON ST.
CHICAGO, ILL. 60637

PUBLIC ADDRESS SET

AN/TIQ-3()

1 March 1964

Cog. Serv: USA FSN: 5830-164-6619

USA Line Item No.: 633550

USA

USN

USAF

USMC

STATUS OR TYPE CLASS.:

Std A

Manufacturer:

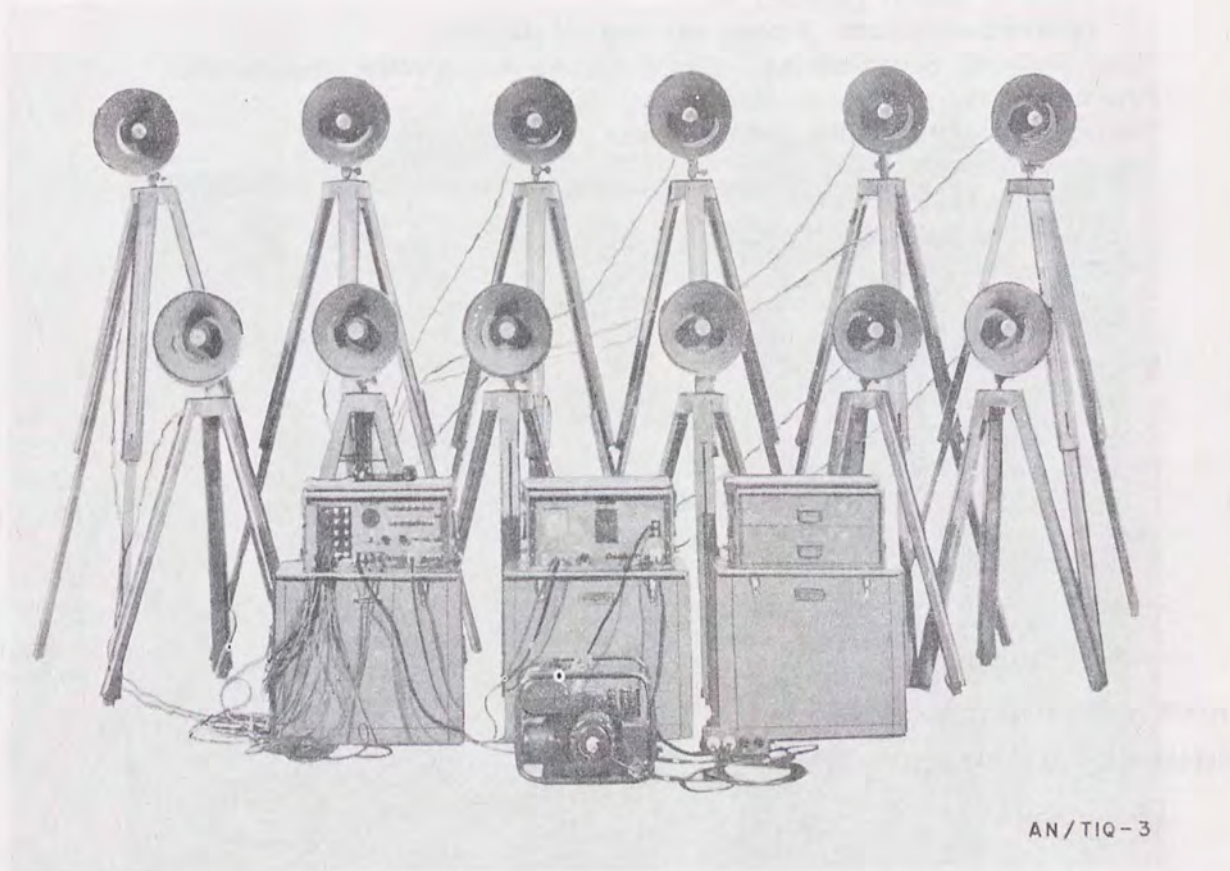

AN/TIQ-3

FUNCTIONAL DESCRIPTION:

Public Address Set AN/TIQ-3() is a portable, sound amplifying, and projecting equipment used in delivering commands or briefing instructions, or in the control of personnel at airfields and at division and higher headquarters.

This equipment consists essentially of an amplifier, a control unit, loudspeakers, and power unit, and accessories.

The set can be modulated by a handset or microphone and by its loudspeaker components, such as the phonograph or similar pick-up devices. It has a tone generator for signaling over the system.

PUBLIC ADDRESS SET

AN/TIQ-3()

Power is supplied by its power unit or an equivalent source of 115 or 230 volts alternating current.

There are two models of this equipment Public Address Set AN/TIQ-3 and AN/TIQ-3A. Both of these are basically similar, differing only in details of the components.

TECHNICAL DESCRIPTION:

Facilities:

- Loudspeakers: 12
- Tone Generator: For signaling over system
- Piped in Sound: Provided for
- Intercommunication: Among any and all stations

Type Controls: Sound-mixing, volume, loudspeaker selector, press-to-talk

Frequency Range: 50 cps to 10,000 cps

Power Output: 50 w \pm 10% distortion max

Power Input:

- Amplifier: 255 w, 2.2 amp
- Control Unit: 20 w, 0.2 amp

Power Requirements:

- Available Source: 275 w; 115- or 23-v, 50- to 60-cy, 1 phase ac
- Power Unit PE-214-B, or equal: 300 w; 120- or 240-v, 60-cy, 1-phase ac

Major Units:

1	AM-34/TIQ-3	18" x 15" x 8"	
1	C-104/TIQ-3	18" x 15" x 8"	65 lbs
12	LS-104/TIQ-3	19 ⁹ / ₁₆ " x 13 ¹ / ₄ " dia	40.75 lbs
1	PE-214, PE-21A, -B, or -C	17 ³ / ₄ " x 14 ¹ / ₈ " x 12 ³ / ₁₆ "	20.25 lbs
1	AM-700/TIQ-3	18" x 15" x 8"	60.75 lbs
1	C-1090/TIQ-3A	18" x 15" x 8"	
12	LS-104/TIQ-3	19 ⁹ / ₁₆ " x 13 ¹ / ₄ " dia	20.25 lbs
12	MT-12A/TIQ-2	53 min, 90 max	19 lbs
1	PE-214, PE-214A, -B, -C	17 ³ / ₄ " x 14 ¹ / ₈ " x 12 ³ / ₁₆ "	60.75 lbs

TUBES, CRYSTALS, TRANSISTORS:

REFERENCE DATA AND LITERATURE:

TM 11-2531

AMPLIFIER EQUIPMENT

AN/TRA-1()

1 March 1964

Cog. Serv: USA FSN: 5820-164-7146

USA Line Item No.: 602520

USA

USN

USAF

USMC

STATUS OR TYPE CLASS.: Std A

Manufacturer: F. M. Link Radio Co

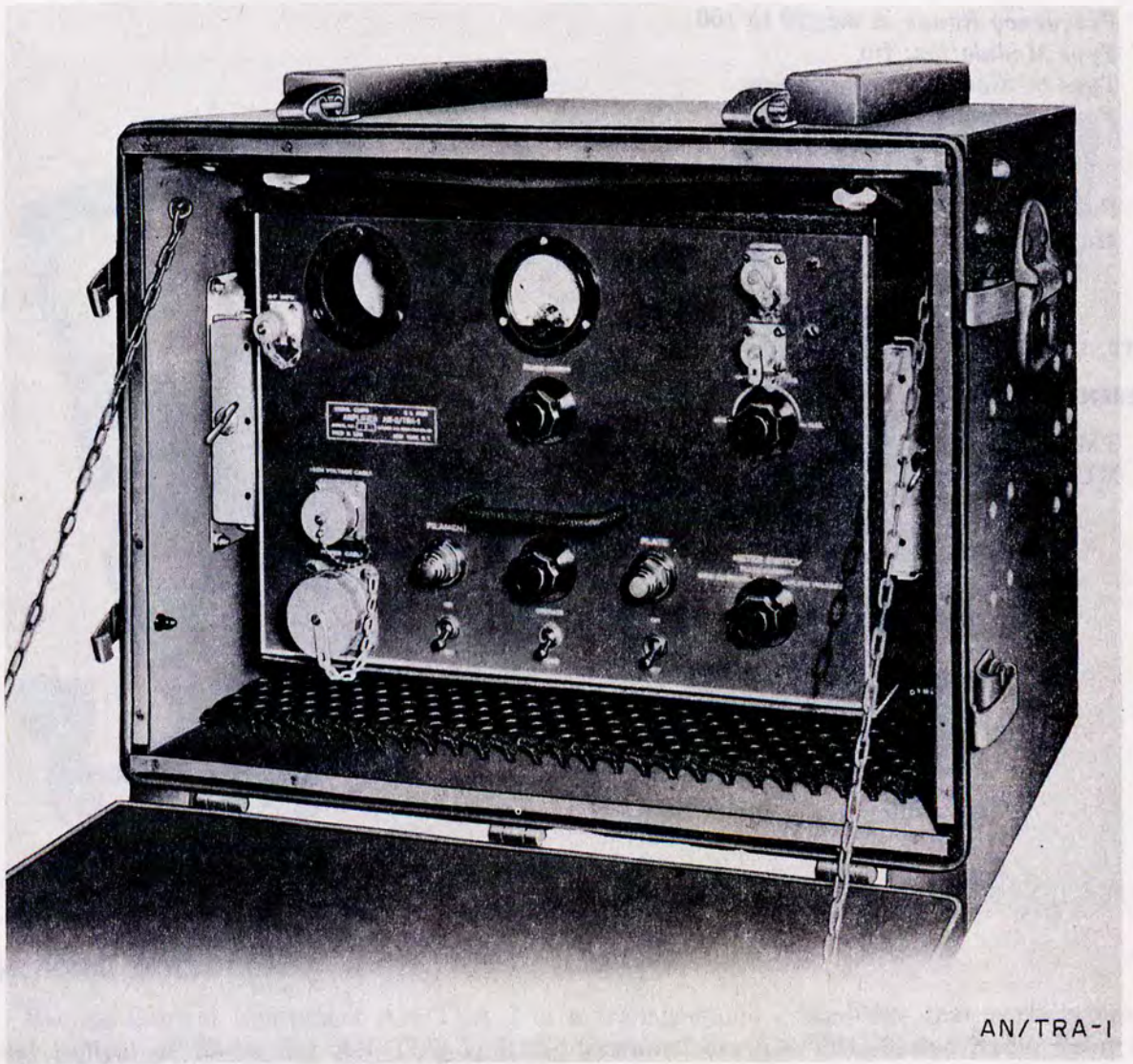

AN/TRA-1

AMPLIFIER EQUIPMENT

AN/TRA-1()

FUNCTIONAL DESCRIPTION:

Amplifier Equipment AN/TRA-1() is a transportable, fm, high-power amplifier used to increase the power output and range of Radio Set AN/TRC-1, Radio Terminal Set AN/TRC-3, and Radio Relay Set AN/TRC-4.

The frequency range and power output of the various models of the amplifier are the same; it can be used with all models of Radio Transmitter T-14/TRC-1 (part of the AN/TRC-1, -3, and -4).

RELATIONSHIP TO SIMILAR EQUIPMENT:

TECHNICAL DESCRIPTION:

Frequency Range in mc: 70 to 100

Type Modulation: fm

Type of Signal: Voice

Power Output:

AN/TRA-1: 250 w

AN/TRA-1A, -1B, -1C, -1D: 200 w

Power Requirements: 800 w, 115-v 50/60-cy ac (from Power Supply PP-13/TRA-1)

Major Units:

1 AM-8/TRA-1

10 $\frac{3}{4}$ " x 12 $\frac{3}{4}$ " x 19 $\frac{1}{8}$ "

48 lbs

1 PP-13/TRA-1

9 $\frac{3}{8}$ " x 14" x 25"

130 lbs

TUBES, CRYSTALS, TRANSISTORS:

REFERENCE DATA AND LITERATURE:

TM 11-2601

MIL-A-10725

REMOTE CONTROL EQUIPMENT
AN/TRA-2

1 March 1964

Cog. Serv: USA FSN: 5820-324-8744

USA Line Item No.: 660300

USA

USN

USAF

USMC

STATUS OR TYPE CLASS.:

Std A

Manufacturer: Scott Radio Laboratories Inc.



AN/TRA-2

FUNCTIONAL DESCRIPTION:

Remote Control Equipment AN/TRA-2 is a transportable assemblage that permits operational control of Radio Set AN/TRC-1, Radio Terminal Set AN/TRC-3, and Radio Relay Set AN/TRC-4 from distances up to 2 miles. This equipment also enables automatic radio-relay operation when the transmitter and receiver of the radio set are more than 10 feet apart, and provides intercommunication between local and remote operating locations.

REMOTE CONTROL EQUIPMENT

AN/TRA-2

RELATIONSHIP TO SIMILAR EQUIPMENT:

TECHNICAL DESCRIPTION:

Power Requirements: 115/230-v 50/60-cy ac

Major Units:

1	C-113/TRA-2	9" x 12" x 12"	20 lbs
1	C-112/TRA-2	9" x 12" x 12"	20 lbs

TUBES, CRYSTALS, TRANSISTORS:

REFERENCE DATA AND LITERATURE:

TM 11-2621
(USA)271-3086

PULSE FORM RESTORER GROUP
AN/TRA-10

1 March 1964

Cog. Serv: USA FSN: 5820-510-1600

USA Line Item No.: 660940

USA

USN

USAF

USMC

STATUS OR TYPE CLASS.: Std A

Manufacturer: International Tel & Tel Corp

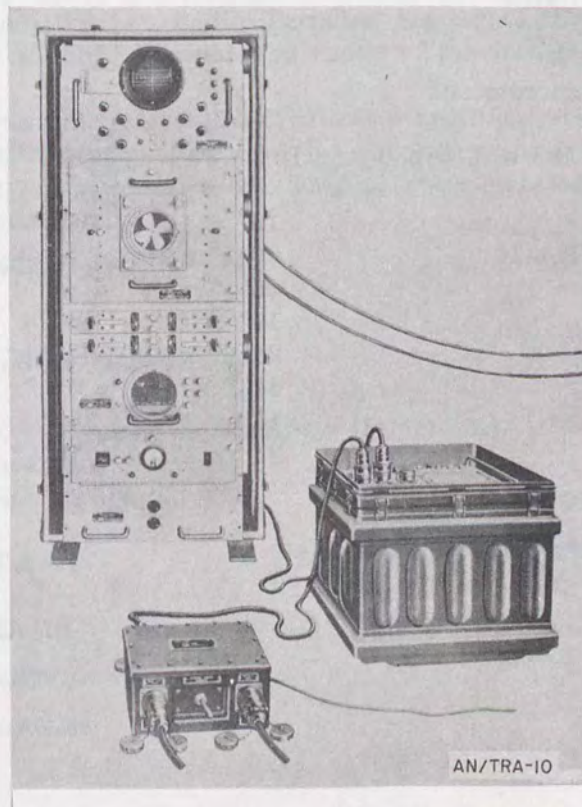
**FUNCTIONAL DESCRIPTION:**

Pulse Form Restorer Group AN/TRA-10 reshapes the 23- or 45-channel pulse train received from microwave radio receiving equipment into a standard wave shape before it is fed to the radio transmitter at a microwave radio relay system.

This equipment is inserted into the system once every four or five hops.

In addition to reshaping the video signal, this equipment provides communication at the relay station by two drop-and-insert channels.

This set is a major component of Radio Repeater Set AN/TRC-40.

PULSE FORM RESTORER GROUP

AN/TRA-10

RELATIONSHIP TO SIMILAR EQUIPMENT:

TECHNICAL DESCRIPTION:

Facilities Required: Radio Set AN/TRC-29 or equivalent

Facilities Provided: Restores pulse train or 23- or 45-channel voice system, and allows for two drop-and-insert voice channels.

Type of Signal: Pulse position, time-division multiplex

Frequency (each of channel):

Modulating Bandwidth: 300 to 3,500 cps

Signaling: 20 cps

Video Signal Characteristics:

Pulse Rate: 192 kc

Pulse Width: 192 kc

Pulse Width: 0.6 microsecond

Bandwidth: 1 mc

Power Requirements: 785 w, 115/230-v ($\pm 10\%$) 47.3-63-cy ac

Major Units:

1	C-1151/TC	19" x 19" x 10 $\frac{1}{2}$ "	
1	MT-1434/TRA-10	20 $\frac{3}{4}$ " x 19" x 24 $\frac{3}{8}$ "	
1	CY-1719/G	26 $\frac{1}{2}$ " x 27" x 60"	595 lbs
1	PP-691/G	19" x 19" x 12"	
1	TD-68/G	23 $\frac{3}{4}$ " x 19" x 15 $\frac{5}{8}$ "	
2	C-1509/TC	4 $\frac{1}{2}$ " x 2 $\frac{3}{4}$ " x 5 $\frac{1}{2}$ "	
4	MD-179/TC	16" x 2 $\frac{1}{2}$ " x 8 $\frac{1}{2}$ "	5.5 lbs
1	CN-236/G	23" x 17 $\frac{1}{2}$ " x 19 $\frac{1}{2}$ "	215 lbs

TUBES, CRYSTALS, TRANSISTORS:

REFERENCE DATA AND LITERATURE:

TM 11-2141

TM 11-2682

MIL-M-10615

AMPLIFIER-POWER SUPPLY GROUP

AN/TRA-19

1 March 1964

Cog. Serv: USA FSN: 5820-503-3282

USA Line Item No.: 602530

	USA	USN	USAF	USMC
STATUS OR TYPE CLASS.:	Std-B		L/Std	

Manufacturer: Lewyt Mfg Corp

FUNCTIONAL DESCRIPTION:

Amplifier-Power Supply Group AN/TRA-19 is auxiliary equipment used with such vhf radio equipment as Radio Set AN/TRC-8, Radio Terminal Set AN/TRC-11, and Radio Relay Set AN/TRC-12 to extend the effective transmission range of the transmitter components of these equipments.

This group consists essentially of a Class C rf power amplifier and a power-supply unit contained in a standardized equipment cabinet.

It can be used to improve transmission over long distances, grazing paths, and shadow areas, and to overcome other adverse conditions.

RELATIONSHIP TO SIMILAR EQUIPMENT:**TECHNICAL DESCRIPTION:***Frequency Range in mc:* 230 to 250*Type Modulation:* fm*Type of Signal:* Voice, teletypewriter, facsimile (composite)*Power Output:* 75 w (nominal)*Power Requirements:* 400 w, 115/230-v ac*Major Units:*

1	CY-1204/TRA-19	26 $\frac{1}{2}$ " x 18 $\frac{3}{8}$ " x 17 $\frac{3}{4}$ "	53 lbs
1	PP-840/TRA-19	10 $\frac{1}{2}$ " x 12 $\frac{7}{8}$ " x 14 $\frac{3}{4}$ "	64 lbs
1	AM-456/TRA-19	11" x 12 $\frac{7}{8}$ " x 13 $\frac{1}{16}$ "	46 lbs

TUBES, CRYSTALS, TRANSISTORS:**REFERENCE DATA AND LITERATURE:**

TM 11-618A

MIL-A-0010489B

MIL-HDBK-161A/TM11-487A-3/NAVEXOS P-2058/TO 31-3-73

AMPLIFIER-POWER SUPPLY GROUP

AN/TRA-19

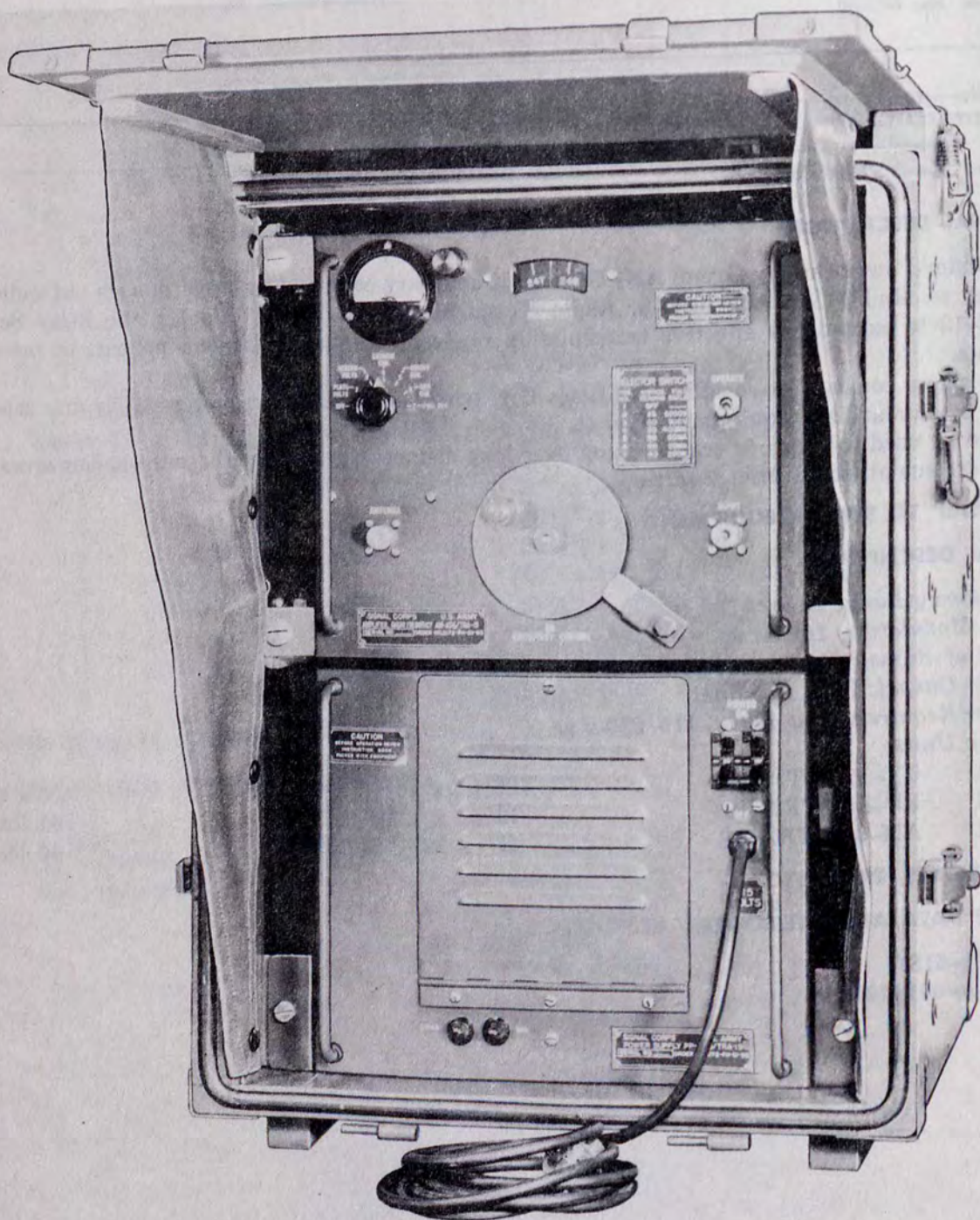

AN/TRA-19

AN/TRA-type
CONTROL UNIT

C-292()/TRA-7

1 March 1964

Cog. Serv: USA FSN: 5815-162-8257

USA Line Item No.: 611325

USA

USN

USAF

USMC

STATUS OR TYPE CLASS.:

Std A

Manufacturer: Barker & Williamson, Inc, Stelma, Inc

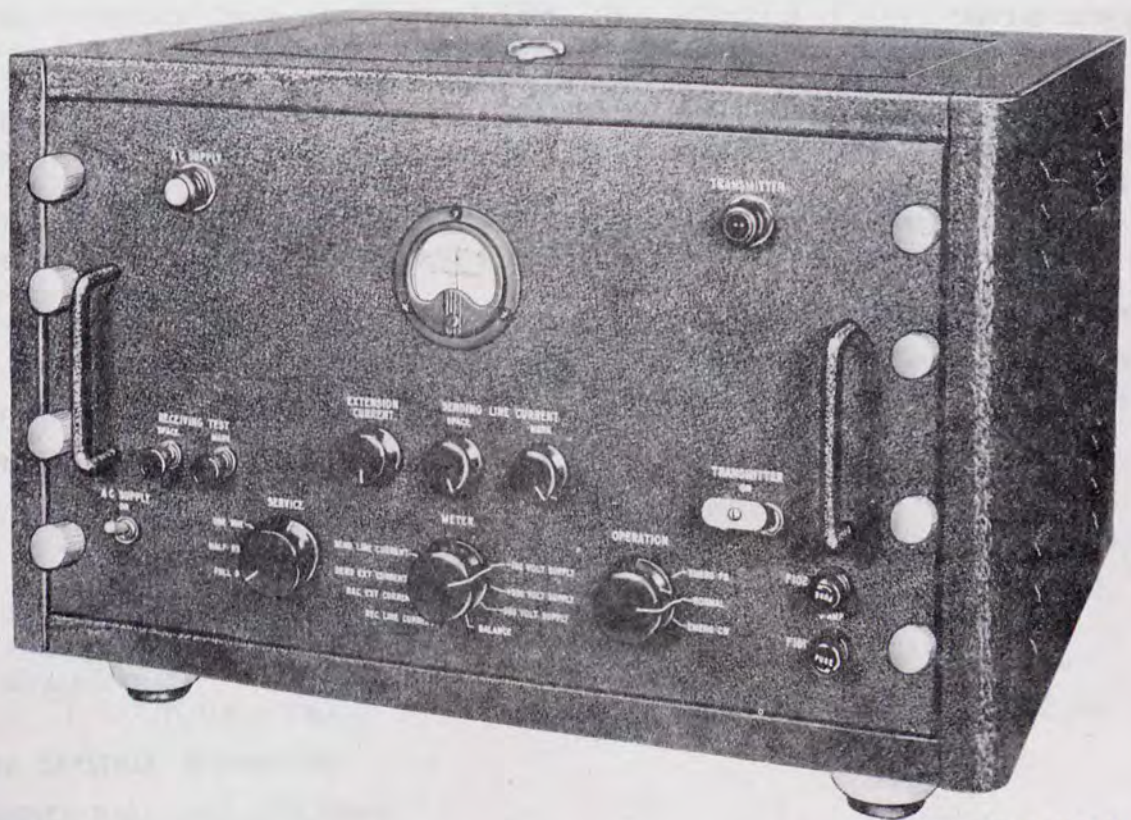

C-292()/TRA-7

FUNCTIONAL DESCRIPTION:

Control Unit C-292()/TRA-7, together with other components of a radioteletype system, provides facilities for establishing radioteletype full-duplex, half-duplex, one-way reversible, emergency cw, or frequency-shift transmission and reception.

This equipment is a single component containing an integral power supply and may be used in several different systems such as those using Radio Set AN-GRC-26 or AN/MRC-2.

AN/TRA-type
CONTROL UNIT**C-292()/TRA-7**

It is an electronic repeater of polar and neutral teletypewriter signals and converts polar telegraph signals received from a dual-diversity converter into neutral signals to operate a receiving teletypewriter. This control unit also translates neutral signals from a sending teletypewriter into polar signals for transmission over a wire line to control a frequency-shift exciter.

When not used in a specific system, this control unit may be located at the receiving station, the transmitting station, or any desired location within 10 miles of the two.

The C-292/TRA-7, C-292A/TRA-7, and C-292B/TRA-7 are functionally interchangeable and differ from each other in design details only.

RELATIONSHIP TO SIMILAR EQUIPMENT:**TECHNICAL DESCRIPTION:***Type of Signal:*

Polar input: Mark, +0.025 amp; space, -0.025 amp

Polar output: Mark, +0.020 amp; space, -0.025 amp

Neutral input and output: Mark, +0.060 amp; space, 0 amp

Power Requirements: 170 w, 115-v 50-60-cy ac

Major Units:

1 C-292()/TRA-7

12 $\frac{1}{4}$ " x 16 $\frac{7}{8}$ " x 21 $\frac{1}{2}$ "

100 lbs

TUBES, CRYSTALS, TRANSISTORS:**REFERENCE DATA AND LITERATURE:**

TM 11-262

MIL-R-13172

AN/TRA-type
DUAL DIVERSITY CONVERTER

CV-31()/TRA-7

1 March 1964

Cog. Serv: USA FSN: 5815-503-2602

USA Line Item No. 614330

	USA	USN	USAF	USMC
STATUS OR TYPE CLASS.:	Std A		L/Std	

Manufacturer: Barker & Williamson, Inc

FUNCTIONAL DESCRIPTION:

Dual Diversity Converter CV-31()/TRA-7 is a component of a radioteletype system that provides full-duplex, half-duplex, or one-way reversible, frequency-shift transmission and reception. In an emergency, it also can provide the same service in a cw system.

This equipment consists of one component that contains its own meters, power supply, and oscillator. The oscillator provides an audible means of indicating mark and space signals when required.

The output of each of the two receivers is applied to the, dual-diversity converter to combine the received frequency-shifted signals and to convert the stronger receiver output into dc neutral and polar signals.

The CV-31/TRA-7, CV-31A/TRA-7, CV-31B/TRA-7, CV-31C/TRA-7, and CV-31D/TRA-7 are identical except for minor electrical and mechanical differences.

RELATIONSHIP TO SIMILAR EQUIPMENT:**TECHNICAL CHARACTERISTICS:***Frequency Range in Mc:*

CV-31, -31A, early -31C/TRA-7: 0.400 to 0.470

CV-31C, -31D/TRA-7: 0.440 to 0.510

Type of Communication Circuit: Radioteletype*Power Requirements:* 175 w, 115-v 50/60-cy ac*Major Units:*

1 CV-31()/TRA-7

25 1/4" x 20 5/8" x 22"

220 lbs

TUBES, CRYSTALS, TRANSISTORS:**REFERENCE DATA AND LITERATURE:**

TM 11-261

TM 11-264

TM 11-278

MIL-R-13172

AN/TRA-type
DUAL DIVERSITY CONVERTER

CV-31()/TRA-7

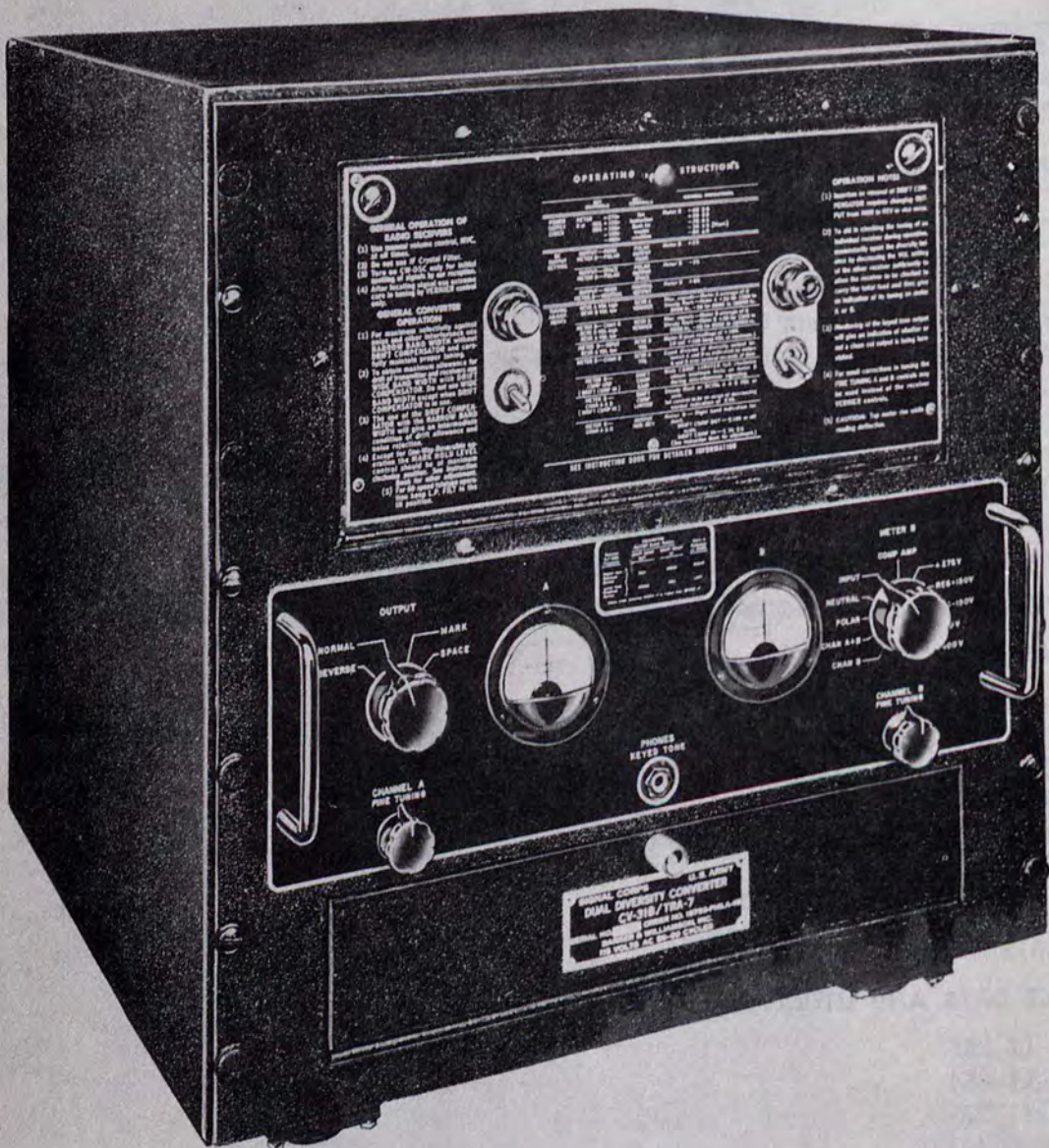

CV-31()/TRA-7

AN/TRA-type
FREQUENCY SHIFT EXCITER

O-39()/TRA-7

1 March 1964

Cog. Serv: USA FSN: 5815-224-5287

USA Line Item No.: 617104

USA

USN

USAF

USMC

STATUS OR TYPE CLASS.: Std A

Manufacturer: Barker & Williamson, Inc

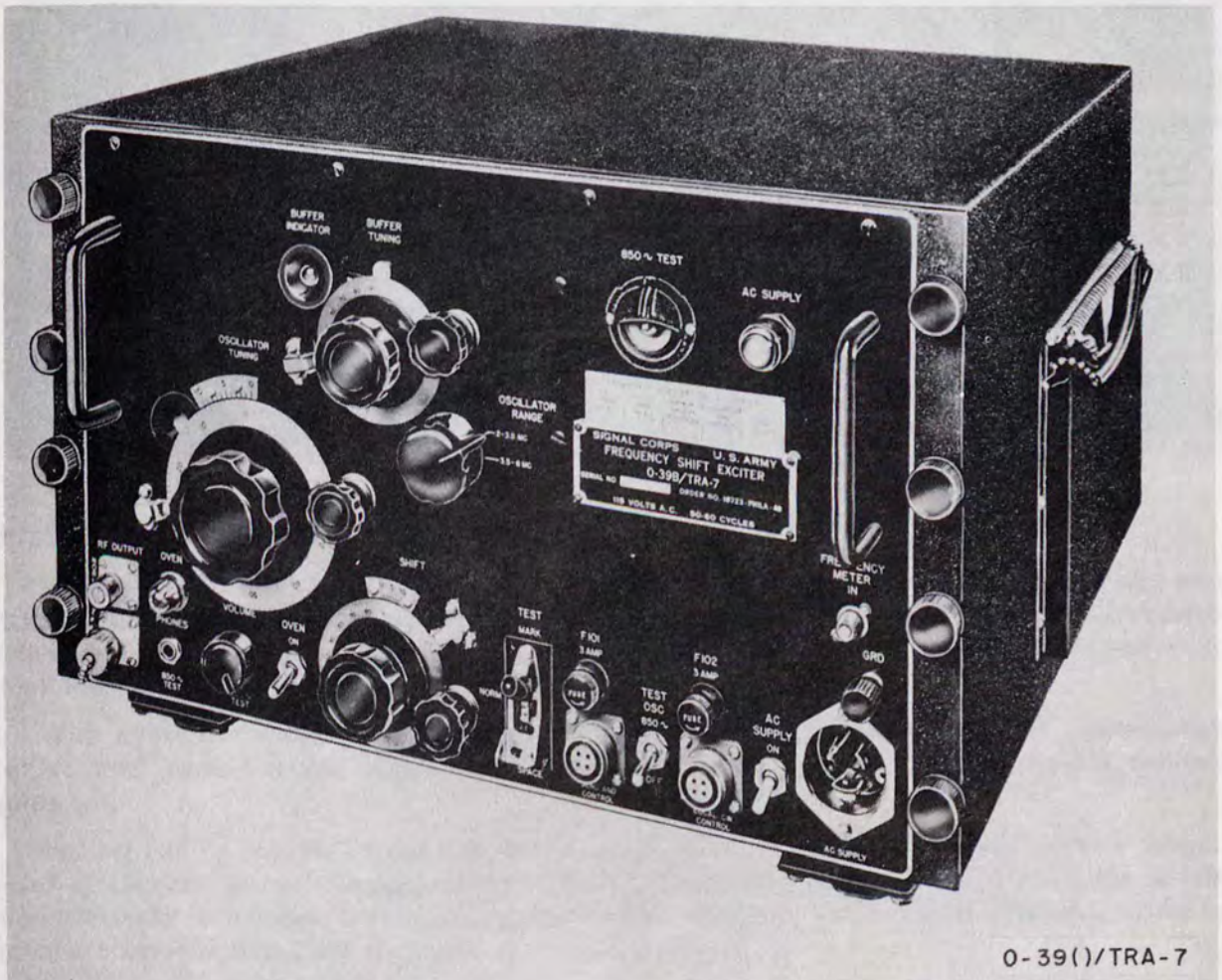
**FUNCTIONAL DESCRIPTION:**

Frequency Shift Exciter O-39()/TRA-7 functions as the oscillator of the radio transmitter with which it is associated. It translates a teletypewriter signal into low-power, frequency-shift keyed, rf signals.

AN/TRA-type

FREQUENCY SHIFT EXCITER

O-39()/TRA-7

The O-39/TRA-7, O-39A/TRA-7, and O-39B/TRA-7 and O-39C/TRA-7 are identical except for minor electrical and mechanical differences.

TECHNICAL DESCRIPTION:

Type of Signal:

Dc Input: Mark, +0.02 amp; space, -0.025

Frequency shift: 212.5 to 850 cy, depending on frequency multiplication of associated radio transmitter

Output Frequency: 2 to 6 mc

Power Requirements: 185 w, 115-v 50/60-cy ac

Major Units:

1 O-39()/TRA-7

16 $\frac{7}{8}$ " x 21 $\frac{1}{2}$ " x 13"

125 lbs

TUBES, CRYSTALS, TRANSISTORS:

REFERENCE DATA AND LITERATURE:

TM 11-257

TM 11-264

TM 11-278

TM 11-624

MIL-R-13171

RADIO SET
AN/TRC-1()

1 March 1964

Cog. Serv: USA FSN: 5820-186-9245

USA Line Item No.: 645500

USA

USN

USAF

USMC

STATUS OR TYPE CLASS.: Std C

Manufacturer: The Hallicrafters Co

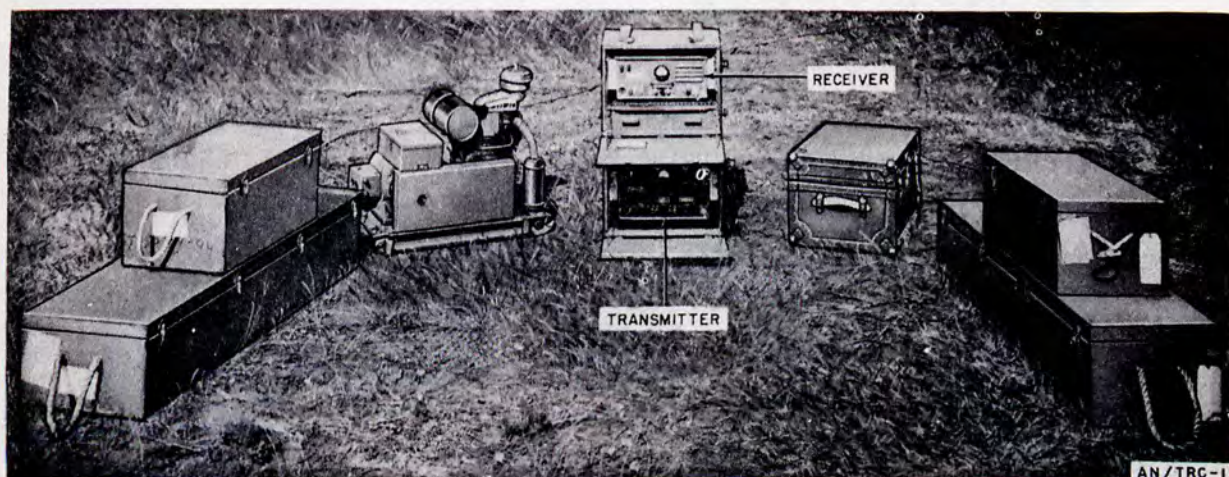
**FUNCTIONAL DESCRIPTION:**

Radio Set AN/TRC-1() is a transportable, crystal-controlled, fm radio receiving and transmitting equipment for radio-relay or point-to-point communication in the vhf band. When operated as the terminal of a radio-relay link in a tactical communication system, it provides one-way or simultaneous two-way facilities.

With appropriate auxiliary equipment, four channels of voice signals can be accommodated. Multichannel radio-teletype signals or a facsimile signal can be with appropriate additional equipment.

The set can be operated from a distant control point on a two-wire or four-wire basis by means of Remote Control Equipment AN/TRA-2. Amplifier Equipment AN/TRA-1 can be added when necessary to increase transmitter power output. Antenna tower, dipole elements, power supply, and accessory items are included.

This equipment is intended for operation on an intermittent or prescheduled basis only. It does not include spare operating components.

For continuous operation, Radio Terminal Set AN/TRC-3, composed essentially of two Radio Sets AN/TRC-1(), is available. In addition, two AN/TRC-1() sets (including necessary spares) operating back-to-back at an intermediate point in a system constitute Radio Relay Set AN/TRC-4.

RADIO SET

AN/TRC-3()

TECHNICAL CHARACTERISTICS:

Frequency Range in mc: 70.0 to 99.9

Type Modulation: fm

Type of Signal: Voice, teletypewriter (with additional equipment)

Power Output:

High Power: 50 w

Low Power: 10 w

Power Requirements:

Transmitter: 250 w, 115-v 50/60 cy ac

Receiver: 110 w, 115-v 50/60 cy ac

Major Units:

AS-19/TRC-1

470 lbs

PE-75

26½" x 19½" x 36"

330 lbs

R-19/TRC-1

22½" x 16" x 17¾"

95 lbs

T-14/TRC-1

22½" x 16" x 17¾"

108 lbs

TUBES, CRYSTALS, TRANSISTORS:

REFERENCE DATA AND LITERATURE:

TM 11-2601

MIL-R-10174

**RADIO TERMINAL SET
AN/TRC-3()**

1 March 1964

Cog. Serv: USA FSN: 5820-193-7107

USA Line Item No.: 657230

USA

USN

USAF

USMC

STATUS OR TYPE CLASS.: Std C

Manufacturer: American Machine & Foundry Co

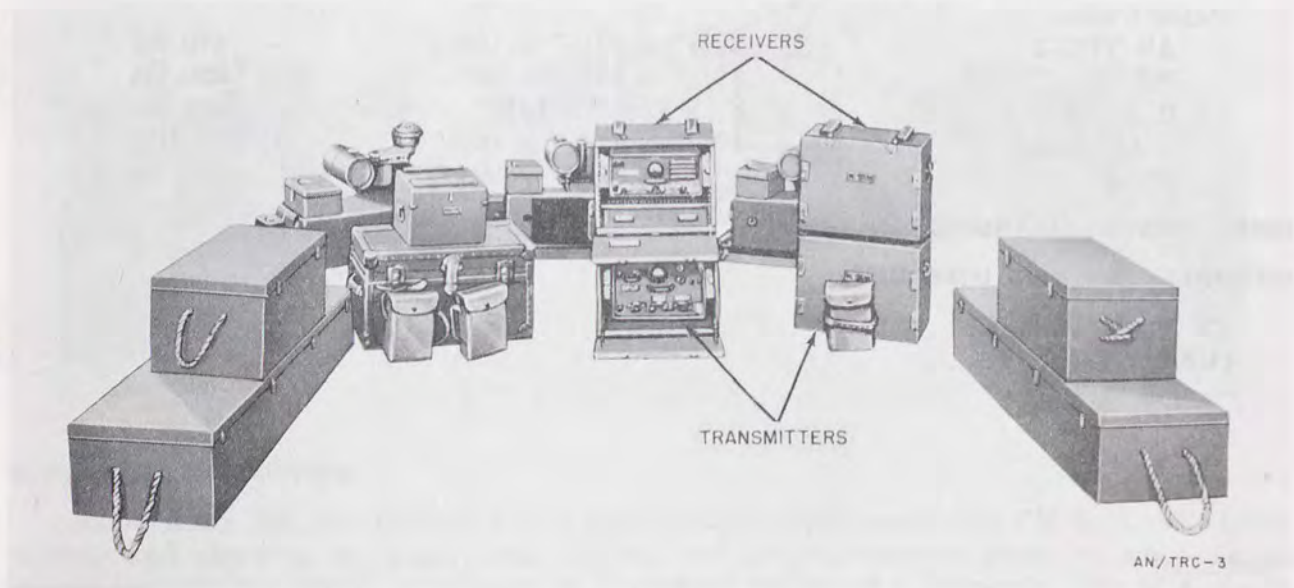
**FUNCTIONAL DESCRIPTION:**

Radio Terminal Set AN/TRC-3() is a transportable, crystal-controlled, FM, field, radio transmitting and receiving equipment that can be used in point-to-point, single or multi-channel communication or as the terminal or a radio relay system.

This equipment consists essentially of two Radio Sets AN/TRC-1, one of which is a spare, assuring continuous operation. It can be used in conjunction with telephone and telegraph equipment to provide various combinations of voice, telegraph or teletypewriter, and facsimile communication.

It can operate in a system in which the remote terminal consists of another Radio Terminal Set AN/TRC-3(), or Radio Set AN/TRC-1(), and in which Radio Relay Set AN/TRC-4() may be used as the intermediate repeater facility.

When it is necessary to increase power output of the transmitter, Amplifier Equipment AN/TRA-1 (not a component of this equipment) can be used.

RADIO TERMINAL SET

AN/TRC-3()

TECHNICAL DESCRIPTION:

Frequency Range in mc: 70.0 to 99.9

Type Modulation: fm

Type of Signal: Voice, teletypewriter (with additional equipment)

Power Output: High power, 50 w; low power, 10 w

Power Requirements:

Commercial power source, Power Unit PE-75 or equivalent

Transmitter: 250 w, 115-v 50/60 cy ac

Receiver: 100 w, 115-v 50/60 cy ac

Major Units:

AS-TRC-1	26 ³ / ₈ " x 33 ¹ / ₂ " x 105 ¹ / ₂ "	470 lbs
PE-75	26 ¹ / ₂ " x 19 ¹ / ₂ " x 36"	330 lbs
R-19/TRC-1	8" x 12 ³ / ₄ " x 19 ¹ / ₈ "	43 lbs
T-14/TRC-1	10 ³ / ₄ " x 12 ³ / ₄ " x 19 ¹ / ₈ "	66 lbs
EE-8	9 ⁹ / ₁₆ " x 3 ¹ / ₂ " x 7 ¹¹ / ₁₆ "	9.75 lbs

TUBES, CRYSTALS, TRANSISTORS:

REFERENCE DATA AND LITERATURE:

TM 11-2601

(USA) 71-3010

RADIO RELAY SET
AN/TRC-4()

1 March 1964

Cog. Serv: USA FSN: 5820-186-9253

USA Line Item No.: 636300

USA

USN

USAF

USMC

STATUS OR TYPE CLASS.: Std A

Manufacturer: American Machine & Foundry Co

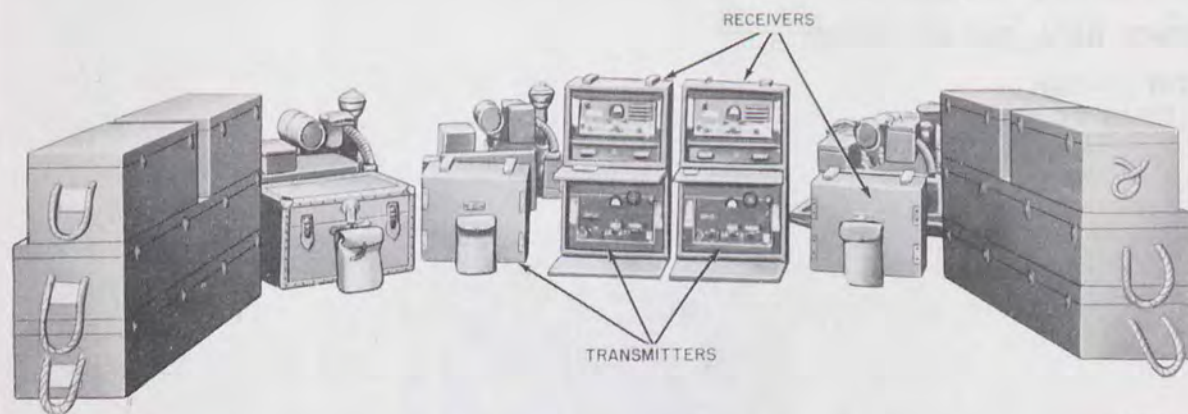

AN/TRC-4

FUNCTIONAL DESCRIPTION:

Radio Relay Set AN/TRC-4() is a transportable, crystal-controlled FM, field, radio transmitting and receiving equipment that can be used in point-to-point single or multi-channel communication, but which is designed as a repeater facility of a radio-relay link of a system using Radio Terminal Set AN/TRC-3.

This equipment consists essentially of two Radio Sets AN/TRC-1, operating back-to-back at intermediate points of a radio-relay facility terminated by Radio Set AN/TRC-1 or Radio Terminal Set AN/TRC-3. It can accommodate various combinations of voice, telegraph, teletypewriter, and facsimile channels. It includes spare operating components antenna, power, and accessory items.

Amplifier Equipment AN/TRA-1 may be used to increase the transmitter output power of this radio-relay set.

RELATIONSHIP TO SIMILAR EQUIPMENT:

None

TECHNICAL DESCRIPTION:*Frequency Range in mc:* 70.0 to 99.9*Type Modulation:* fm*Type of Signal:* Voice, teletypewriter (with additional equipment)

RADIO RELAY SET

AN/TRC-4()

Power Output: 10 w or 50 w

Power Requirements:

Transmitter: 250 w, 115-v 50/60 cy ac

Receiver: 100 w, 115-v 50/60 cy ac

Major Units:

AS-19/TRC-1	26 ³ / ₈ " x 33 ¹ / ₂ " x 105 ¹ / ₂ "	470 lbs
PE-75	26 ¹ / ₂ " x 19 ¹ / ₂ " x 36"	330 lbs
R-19/TRC-1	8" x 12 ³ / ₄ " x 19 ¹ / ₈ "	43 lbs
T-14/TRC-1	10 ³ / ₄ " x 12 ³ / ₄ " x 19 ¹ / ₈ "	60 lbs

TUBES, CRYSTALS, TRANSISTORS:

REFERENCE DATA AND LITERATURE:

TM 11-2601
(USA) 71-3010

RADIO SET

AN/TRC-7, -7A, -7B

1 December 1958

Cog. Serv: USAF FSN: 5820-537-4006

USA Line Item No.: 646000

	USA	USN	USAF	USMC
STATUS OR TYPE CLASS.:	Std C			
Manufacturer:	Andrea Radio Corp			

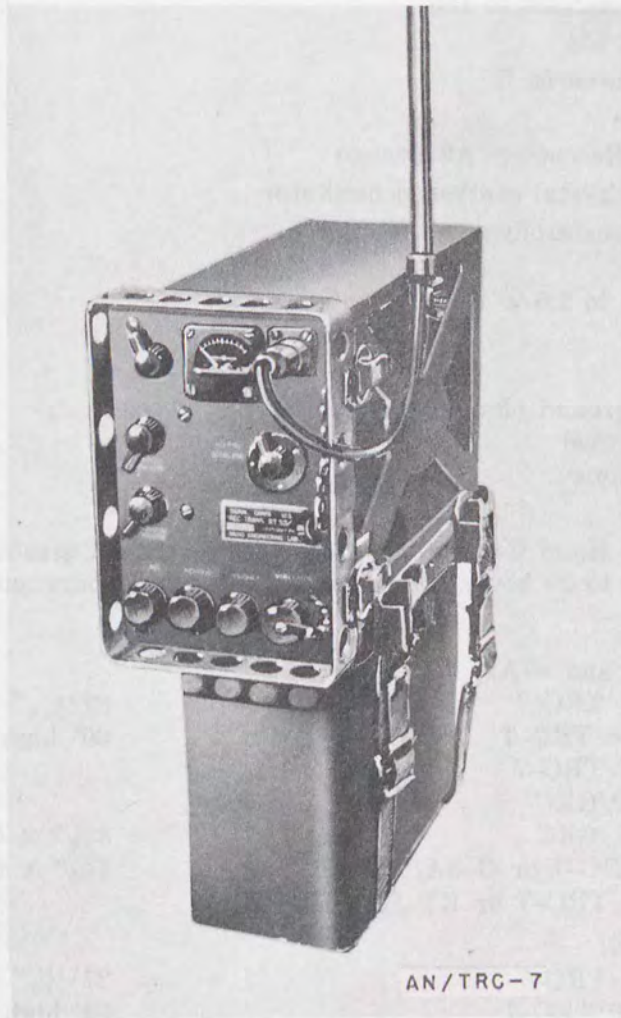

AN/TRC-7

FUNCTIONAL DESCRIPTION:

Radio Sets AN/TRC-7, AN/TRC-7A, and AN/TRC-7B are portable, low-power, two-way receiver-transmitter units used for ground-to-air and point-to-point communication. The radio sets are designed for short distance operation in the very high frequency range.

RADIO SET

AN/TRC-7, -7A, -7B

Normally, these equipments are controlled locally but can be controlled from remote point as far as 2 miles by means of Remote Control Equipment RC-261.

Power may be supplied either from a Battery BA-70 or from handcranked Generator G-3()/TRC-7, or both. Battery life is a minimum of 4 hours for continuous transmission, and 20 hours maximum for continuous reception.

These sets are basically similar, differing only in details of the various components.

RELATIONSHIP TO SIMILAR EQUIPMENT:

TECHNICAL DESCRIPTION:

Frequency Range in mc: 100 to 156

Number of Channels: 561

Number of Preset Channels: 2

Type Modulation: am

Type Emission and Reception: A3 (voice)

Frequency Control: Crystal controlled oscillator

Type Receiver: Superheterodyne

Power Output:

Transmitter: 0.4 to 1.5 w

Receiver: 60 mw

Antenna:

Type: Whip or ground plane conical

Polarization: vertical

Impedance: 50 ohms

Power Requirements:

Battery B-70 or Hand Generator G-3/TRC-7 or both: Current drain 1.106 amp (max)

Battery Life: 20 to 25 hours on reception only; 4 to 5 hours continuous transmission.

Major Units:

For AN/TRC-7 and -7A:

1	AT-59/TRC-7	27 ¹¹ / ₁₆ " x 5 ¹ / ₂ " dia
1	AS-110/TRC-7	30' high
1	AB-37/TRC-7	
1	C-1200/GRC	
1	C-1201/GRC	3 ¹ / ₂ " x 4 ³ / ₁₆ " x 7 ¹ / ₂ "
1	G-3/TRC-7 or G-3A/TRC-7	7 ¹ / ₄ " x 6 ³ / ₈ " x 7 ¹ / ₄ "
1	RT-53/TRC-7 or RT-53A/TRC-7	

For AN/TRC-7B:

1	AT-59/TRC-7	27 ¹¹ / ₁₆ " x 5 ¹ / ₂ " dia
1	AS-110/TRC-7	30' high
1	AB-37/TRC-7	
1	C-1200/GRC	
1	C-1201/TRC	3 ¹ / ₂ " x 4 ³ / ₁₆ " x 7 ¹ / ₂ "
1	G-3B/TRC-7	8 ⁷ / ₈ " x 6 ¹ / ₂ " x 10"
1	RT-53B/TRC-7	

AN/TRC-7, -7A, -7B

TUBES, CRYSTALS, TRANSISTORS:

REFERENCE DATA AND LITERATURE:

AN/TRC-7, AN/TRC-7A: TM 11-617

AN/TRC-7B:

TO 31R2-2TRC7-14

TO 16-30TRC7-3

TO 16-30TRC7-2

271-3103

RADIO SET
AN/TRC-8

1 March 1964

Cog. Serv: USA FSN: 5820-193-7106

USA Line Item No.: 646100

	USA	USN	USAF	USMC
STATUS OR TYPE CLASS.:	Std C		L/Std	

Manufacturer: Espey Mfg Co Inc

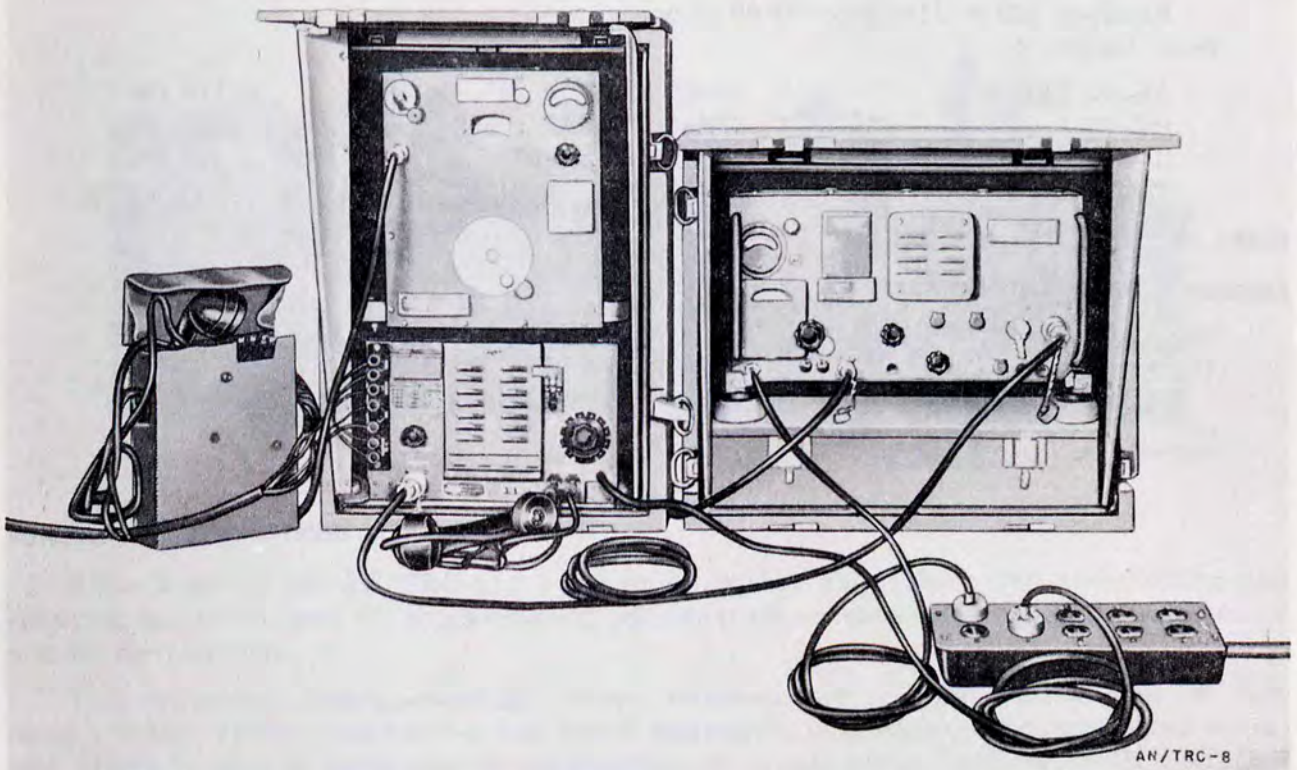
**FUNCTIONAL DESCRIPTION:**

Radio Set AN/TRC-8 is a transportable, vhf, fm, single-channel radio receiving and transmitting equipment used for point-to-point or radio relay applications.

This equipment consists of a radio transmitter, a radio receiver, an antenna, and power accessories but does not include spare operating components. It is intended for use on an intermittent or prescheduled basis. It is designed for communication by voice signals and, in conjunction with additional equipment, for radioteletype applications.

For continuous operation, spare operating components are added (constituting Radio Terminal Set AN/TRC-11). For radio relay use, the same primary operating components back-to-back at intermediate points of a system.

RADIO SET

AN/TRC-8

RELATIONSHIP TO SIMILAR EQUIPMENT:

None

TECHNICAL DESCRIPTION:

Frequency Range in mc: 230 to 250

Type Modulation: fm

Type of Signal: Voice, TTY (with additional equipment)

Power Output: 5 w

Power Requirements: Commercial power source, power Unit PE-75, or equivalent

Transmitter: 350 w, 115/230-v 50/60 cy ac

Receiver: 120 w, 115/230-v 50/60 cy ac

Major Units:

AS-52/TRC-8	33½" x 14" x 24"	110 lbs
PE-75	26½" x 19½" x 36"	330 lbs
R-48/TRC-8	23" x 16" x 19"	126 lbs
T-30/TRC-8	17½" x 16" x 24½"	135 lbs

TUBES, CRYSTALS, TRANSISTORS:

REFERENCE DATA AND LITERATURE:

TM 11-618A

(USA) 71-3244

RADIO TERMINAL SET

AN/TRC-11

1 March 1964

Cog. Serv: USA FSN: AN/TRC-11,-11A: 5820-192-7149

AN/TRC-11B: 5820-503-1717

USA Line Item No.: 657250

	USA	USN	USAF	USMC
STATUS OR TYPE CLASS.:	Std C		L/Std	

Manufacturer: American Machine & Foundry Co
Espey Mfg Co

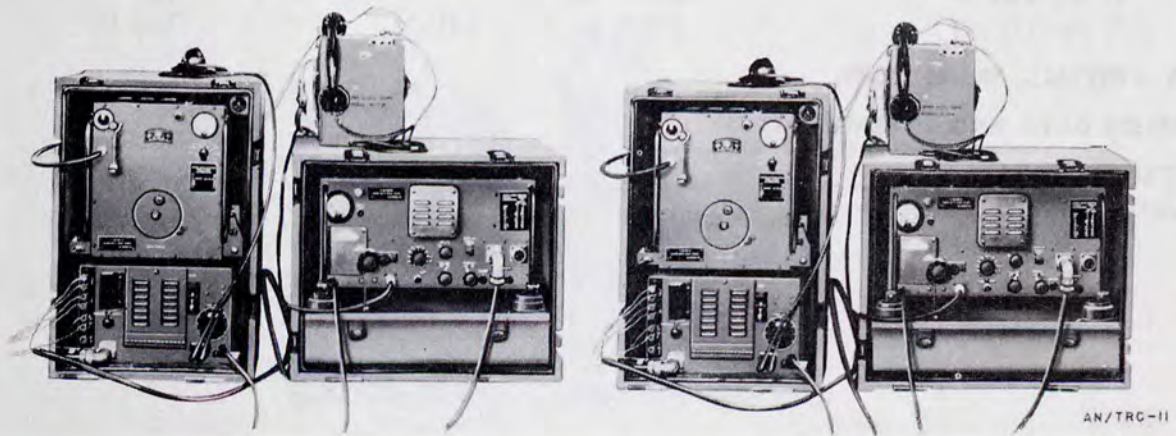
**FUNCTIONAL DESCRIPTION:**

Radio Terminal Set AN/TRC-11() is a transportable, fm (voice), vhf, transmitting and receiving equipment used for single-channel, point-to-point communication or as the terminal of a radio relay system.

This equipment consists essentially of two receivers and two transmitters (one of each being a spare), antenna components, and power equipment. It is designed for continuous operation. It can be used in single-channel applications on a half-duplex basis or, with additional equipment, for full-duplex radioteletype communication as the terminal or a radio link in a wire or cable system.

It is designed primarily to operate continuously as the terminal of a radio relay system in which the opposite or remote terminal equipment consists of Radio Set AN/TRC-8, or another AN/TRC-11, and in which Radio Relay Set AN/TRC-12 is used at intermediate points of the system as may be required to extend the distance range between terminals.

It requires 115/230 v ac to operate and can be powered by its power unit component or an equivalent source.

RELATIONSHIP TO SIMILAR EQUIPMENT:

None

RADIO TERMINAL SET

AN/TRC-11**TECHNICAL DESCRIPTION:***Frequency Range in mc:* 230 to 250*Type Modulation:* fm*Type of Signal:* Voice; TTY or composite (with additional equipment)*Power Output:* 5 w*Power Requirements:*

Transmitter: 350 w, 115/230-v 50/60-cy ac

Receiver: 120 w, 115/230-v 50/60-cy ac

Major Units:

AS-52/TRC-8	33½" x 14" x 24"	110 lbs
PE-75	26½" x 19½" x 36"	330 lbs
R-48/TRC-8	23" x 16" x 19"	126 lbs
T-30/TRC-8	17½" x 16" x 24½"	135 lbs

TUBES, CRYSTALS, TRANSISTORS:**REFERENCE DATA AND LITERATURE:**

TM 11-618A

MIL-R-12887

RADIO RELAY SET
AN/TRC-12()

1 March 1964

Cog. Serv: USA FSN: 5820-192-7147

USA Line Item No.: 636320

USA

USN

USAF

USMC

STATUS OR TYPE CLASS.:

STD-C

L/Std

Manufacturer: American Machine & Foundry Co, Electronics Division
Espey Mfg Co, Inc

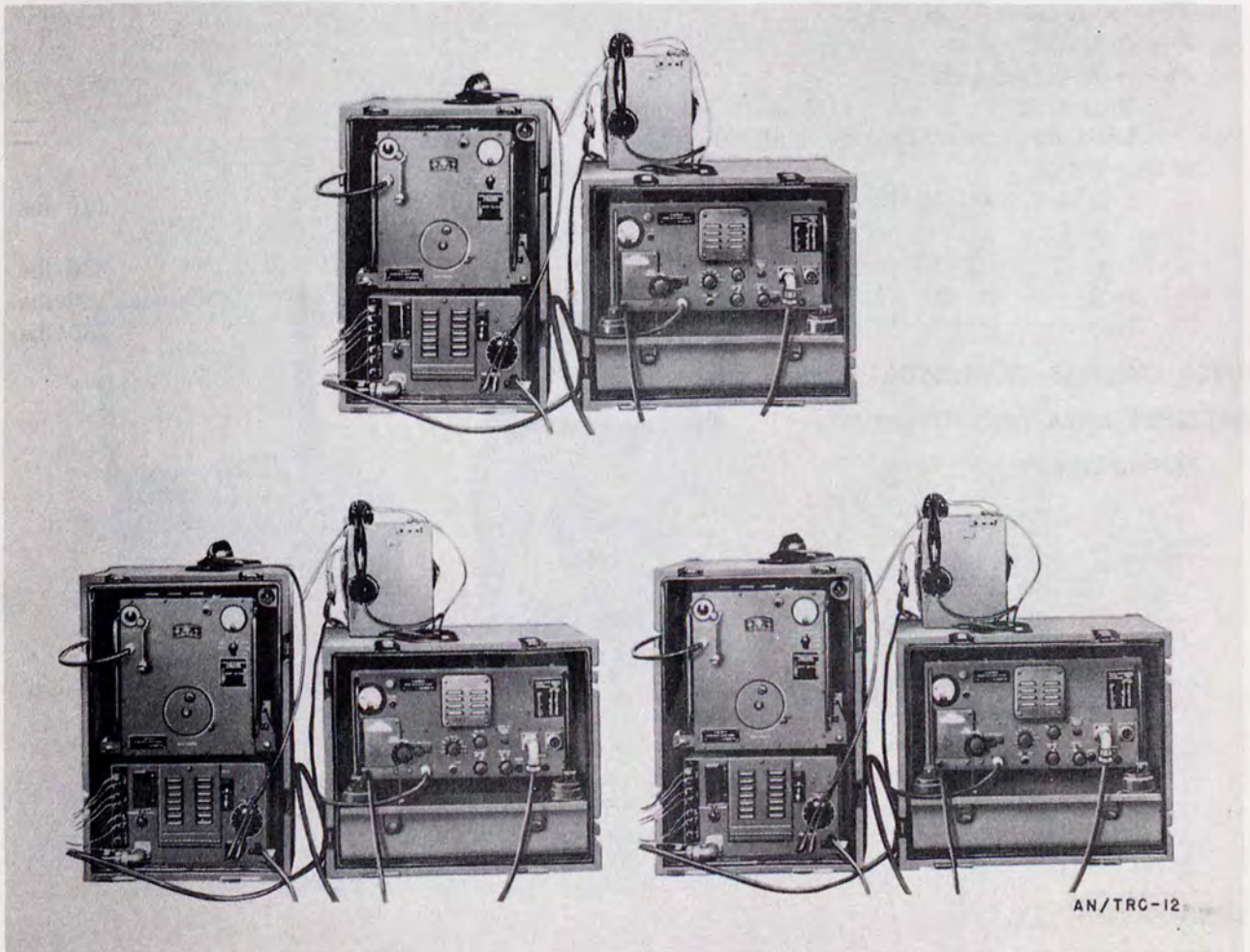

AN/TRC-12

FUNCTIONAL DESCRIPTION:

Radio Relay Set AN/TRS-12() is a transportable, fm (voice), vhf transmitting and receiving equipment used for single-channel, point-to-point communication or as a repeater station at intermediate points of a radio-relay system.

RADIO RELAY SET

AN/TRC-12()

This equipment consists essentially of three or four radio transmitters and three or four radio receivers (two of each in operation), antenna components, and power equipment. It is designed to be used primarily on a continuous basis for half-duplex or full-duplex communication in a system terminated by Radio Set AN/TRC-8 or Radio Terminal Set AN/TRC-11 or as a single-channel voice communication facility.

RELATIONSHIP TO SIMILAR EQUIPMENT:

TECHNICAL DESCRIPTION:

Frequency Range in mc: 230 to 250

Type Modulation: fm

Type of Signal: Voice, TTY

Power Output: 5 w

Power Requirements:

Transmitter: 350 w, 115/230-v 50/60-cy ac

Receiver: 120 w, 115/230-v 50/60-cy ac

Major Units:

4 or 6	AS-52/TRC-8	33½" x 14" x 24"	110 lbs
4 or 5	AB-33B/TRC-1		
2 or 3	PE-75-()	26½" x 19½" x 36"	330 lbs
3 or 4	R-48()/TRC-8	23" x 16" x 19"	126 lbs
3 or 4	T-30()/TRC-8	17½" x 16" x 24½"	135 lbs

TUBES, CRYSTALS, TRANSISTORS:

REFERENCE DATA AND LITERATURE:

MIL-R-12887

RADIO SET
AN/TRC-20

1 March 1964

Cog. Serv: USA FSN: 5820-519-4106

USA Line Item No.: 646400

USA

USN

USAF

USMC

STATUS OR TYPE CLASS.: Std-A

Manufacturer:

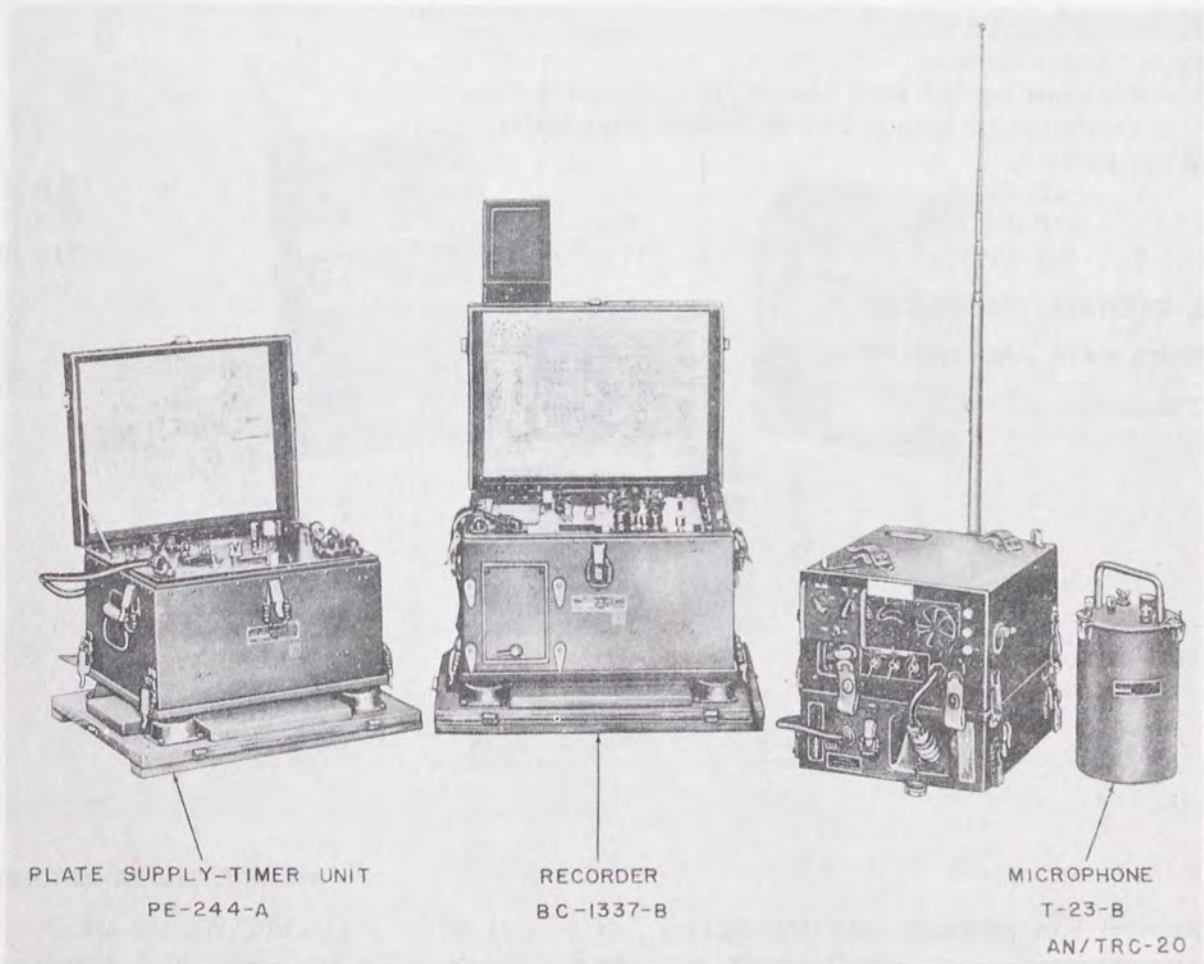
**FUNCTIONAL DESCRIPTION:**

Radio Set AN/TRC-20 is a low power, short-range, fm (voice), transmitting and receiving equipment. It is used as part of a sound ranging system to detect low-frequency artillery reports or shell explosions in the field, and to relay this information to a central location for plotting purposes.

RADIO SET

AN/TRC-20

This set consists of the basic components of Radio Set SCR-610-(), which have been modified for use in the AN/TRC-20. The modified components have been assigned new type numbers (see MAJOR COMPONENTS), but are capable of performing the same functions as the SCR-610.

RELATIONSHIP TO SIMILAR EQUIPMENT:**TECHNICAL DESCRIPTION:**

Frequency Range in mc: 27.0 to 38.9

Type of Modulation: fm

Type of Signal: Voice

Power Output: 1.3 w

Power Requirements:

Transmitting: 2.0 amp, 24-v dc from storage battery

Receiving: 1.5 amp at 24-v dc from storage battery

Major Units:

1 AN-29-C

2.0 lbs

1 PP-1067/GR

8 $\frac{7}{8}$ " x 16 $\frac{1}{2}$ " x 18 $\frac{7}{8}$ "

33.8 lbs

1 RT-111

11 $\frac{7}{8}$ " x 16 $\frac{3}{8}$ " x 21 $\frac{1}{2}$ "

35.13 lbs

TUBES, CRYSTALS, TRANSISTORS:**REFERENCE DATA AND LITERATURE:**

TM 11-615

RADIO SET
AN/TRC-22

1 March 1964

Cog. Serv: USA FSN: 5820-503-1129

USA Line Item No.: 646600

	USA	USN	USAF	USMC
STATUS OR TYPE CLASS.:	Std-A			
Manufacturer:	Motorola, Inc			

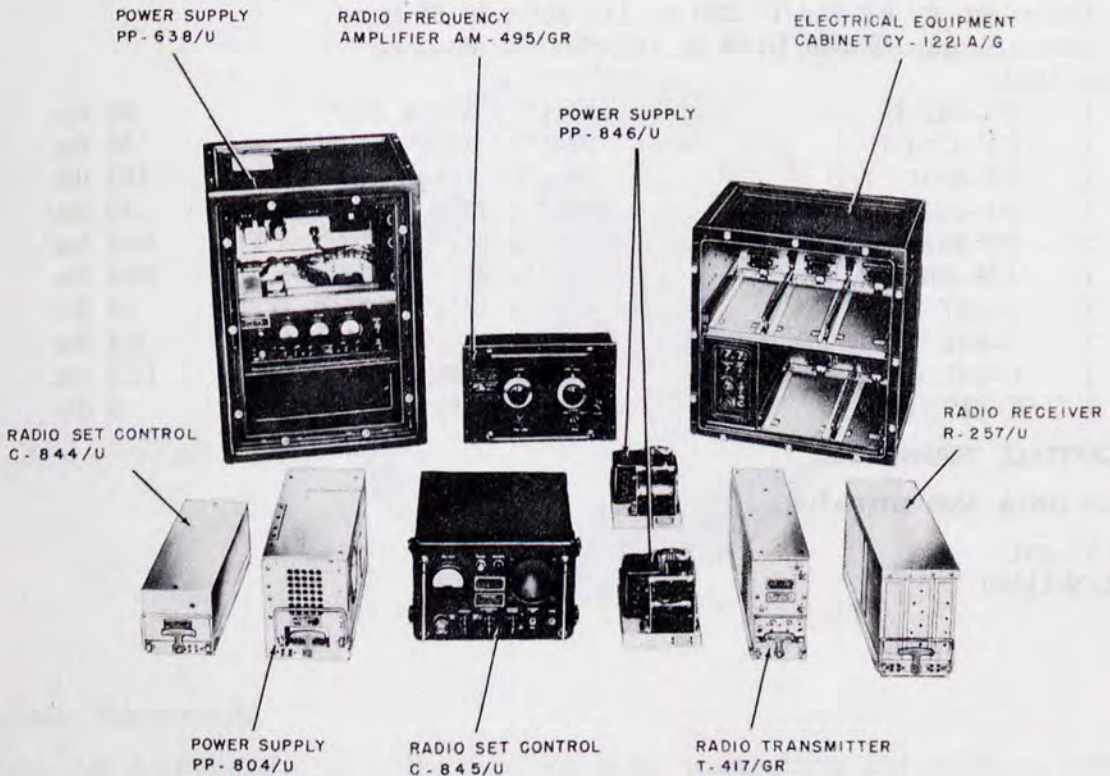

AN/TRC-22

FUNCTIONAL DESCRIPTION:

Radio Set AN/TRC-22 is an fm (voice) vhf, crystal-controlled receiving and transmitting equipment, used by military police, guard, and security organizations.

This equipment consists of a radio transmitter, power amplifier, receiver, and auxiliary components.

It is normally operated in a simplex basis but can be arranged for duplex operation by the addition of another receiver and an extra antenna. It can also provide automatic retransmission service between two stations too distant from each other for direct communication.

Remote control with intercommunication between the local and distant operating locations is provided by means of the radio set controls supplied.

RADIO SET

AN/TRC-22

RELATIONSHIP TO SIMILAR EQUIPMENT:

TECHNICAL DESCRIPTION:

Frequency Range in mc: 25 to 50

Type of Modulation: fm

Type of Signal: Voice

Power Output: 45 w without amplifier: 250 w with amplifier

Power Requirements:

Power Supply PP-638/U: 660 w, 115/230-v 60-cy ac

Power Supply PP-804/U: 230 va, 115/230-v 50/65-cy ac

Power Supply PP-846/U: 46 va, 115/230-v 50/65-cy ac

Major Units:

1	AS-612/U	11½" x 41" x 5¼"	30 lbs
1	CY-1221/G	21¼" x 16⅞" x 20½"	58 lbs
1	PP-638()/U	26¾" x 16½" x 20¼"	187 lbs
1	PP-804/U	8⅝" x 7" x 14½"	40 lbs
2	PP-846/U	5⅛" x 6¼" x 7¼"	10.5 lbs
1	AM-495/GR	9¾" x 9½" x 15"	13.5 lbs
1	R-257/U	8½" x 14½" x 5¾"	19 lbs
1	C-844/U	8¾" x 14¾" x 5⅞"	6.5 lbs
1	C-845/U	8⅞" x 13¾" x 13½"	17.5 lbs
1	T-417/GR	8½" x 14½" x 4½"	9 lbs

TUBES, CRYSTALS, TRANSISTORS:

REFERENCE DATA AND LITERATURE:

TM 11-691

MIL-N-11539

RADIO SET

AN/TRC-24()

1 March 1964

Cog. Serv: USA FSN: 5820-503-1133

USA Line Item No.: 646800

	USA	USN	USAF	USMC
STATUS OR TYPE CLASS.:	Std-A		Std	
Manufacturer:	Western Electric Co, Inc			



AN/TRC-24,-35,-36

FUNCTIONAL DESCRIPTION:

Radio Set AN/TRC-24() is the basic fm radio transmitting and receiving equipment used in Radio Terminal Set AN/TRC-35() and Radio Relay Set AN/TRC-36() and in such equipment as AN/GRC-75, -76, -77 (Band A); AN/GRC-78, -79, -80 (Bands B and D); AN/GRC-81, -82, -83 (Band C) and shelter-housed AN/MRC-54(V), -69(V).

This basic set comprises all components necessary for simultaneous point-to-point transmission and reception of a maximum of 12 or 24 multiplexed telephone channels. The channel multiplexing equipment is not included in this equipment, which is designed to accommodate baseband signals generated by Telephone Terminal AN/TCC-7 or similar telephone carrier equipment.

RELATIONSHIP TO SIMILAR EQUIPMENT:**TECHNICAL DESCRIPTION:**

Frequency Range in mc:

Band A: 50 to 100

RADIO SET

AN/TRC-24()

Band B: 100 to 225

Band C: 225 to 400

Band D: 400 to 600

Band F: 790-915 (low)

Band F: 840-925 (high)

Band J: 1350-1525 (low)

Band J: 1525-1700 (med)

Band J: 1700-1875 (high)

Type Modulation: fm*Type of Signal:* Voice (up to 12 or 24 channels with additional equipment)*Baseband Frequency Range:* 250 to 68,000 cps*Power Output:* 50 to 120 w*Power Requirements:*

Transmitter: 875 va, 115-v 50-60-cycle ac

Receiver: 185 w, 115-v 50/60-cycle ac

Major Units:

1	OA-482/TRC	18 $\frac{1}{4}$ " x 12 $\frac{1}{4}$ " x 20 $\frac{1}{2}$ "	
1	OA-483/TRC		
	AM-913/TRC		
	AM-914/TRC		
	TF-167/TRC		
	CY-1338/TRC	18 $\frac{3}{8}$ " x 17 $\frac{1}{8}$ " x 20 $\frac{5}{8}$ "	39 lbs
	PP-685/TRC		
	CY-1340/TRC	17 $\frac{1}{8}$ " x 18 $\frac{3}{8}$ " x 20 $\frac{5}{8}$ "	115 lbs
	AM-912/TRC		
	AM-915/TRC		
	R-417/TRC		
	T-302/TRC		
	T-302/TRC	18 $\frac{1}{2}$ " x 22" x 20 $\frac{5}{8}$ "	120.75 lbs
	R-417/TRC	17 $\frac{1}{2}$ " x 18 $\frac{1}{4}$ " x 20 $\frac{5}{8}$ "	96.5 lbs
	PP-685/TRC	17 $\frac{1}{2}$ " x 18 $\frac{3}{8}$ " x 20 $\frac{5}{8}$ "	115 lbs

TUBES, CRYSTALS, TRANSISTORS:

REFERENCE DATA AND LITERATURE:

TM 11-5820-203-15

TM 11-5820-287-10

TO 31R2-2TRC24-11

MIL -R-10616

RADIO SET
AN/TRC-27

1 March 1964

Cog. Serv: USN FSN: 5820-564-2504

USA Line Item No.: 647089

USA

USN

USAF

USMC

STATUS OR TYPE CLASS.:

Std-A

Manufacturer: CRP (49956)

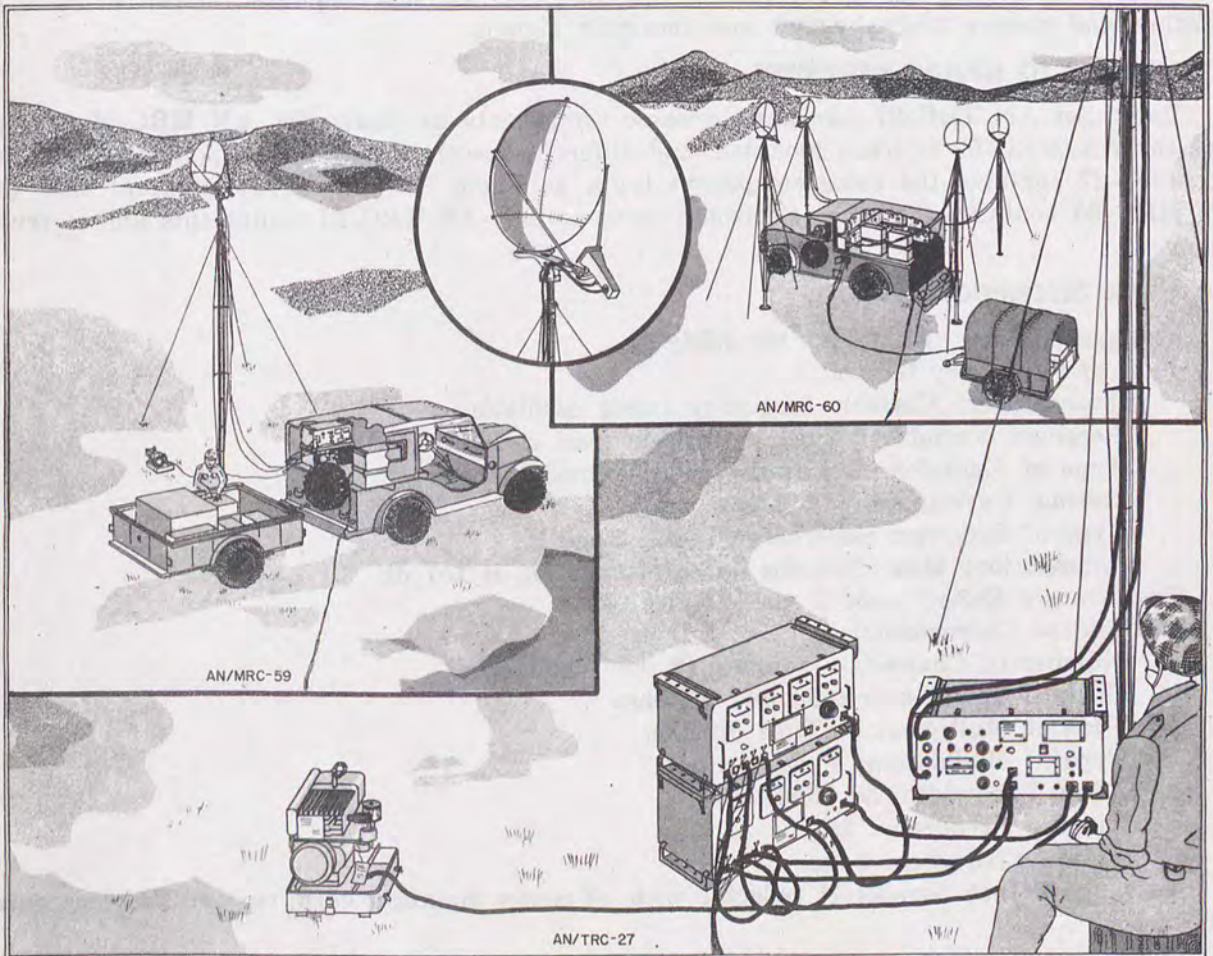
**FUNCTIONAL DESCRIPTION:**

Radio Set AN/TRC-27 is a small, light weight, portable radio communications set. A communications system of two AN/TRC-27 terminals provides two-way microwave radio transmission for eight telephone channels. The radio set is for operation in forward areas. It will operate with a 26 db fade margin over a 10 mile line-of-sight path, or with a 10 db fade mar-

RADIO SET

AN/TRC-27

gin over a 60 mile line-of-sight path, (a 26 db fade margin permits a reliability of 99.7 percent, while a 10 db fade-margin permits a reliability of 90 percent). Line-of-sight ranges up to 200 miles are theoretically possible, with corresponding decreases in fade margin and reliability. The equipment operates on any one of 30 suggested channels using pulse position modulation.

The AN/TRC-27, AN/MRC-59, and AN/MRC-60 equipments may be used in a multi-hop radio relay link consisting of two terminal stations and up to three repeater stations spaced 10 miles or more apart, depending on terrain and propagation conditions. These equipments may also be used in a network with 24-channel Omnidirectional Radio Set AN/GRC-37. By using additional multiplexing equipment such as the AN/TCC-14, these equipments can be used to transmit and receive teletypewriter and facsimile signals.

RELATIONSHIP TO SIMILAR EQUIPMENT:

Radio Set AN/TRC-27 contains the same components as Radio Set AN/MRC-59, except that the AN/MRC-59 is truck mounted, and different power sources are supplied. Radio Set AN/TRC-27 contains the same component types as Radio Set AN/MRC-60 except that the AN/MRC-60 contains the same electronic units as four AN/TRC-27 equipments and is truck mounted.

TECHNICAL DESCRIPTION:

Frequency Range: 4400-5000 mc (shf)

Type of Frequency Control:

Transmitter: Variable frequency triode oscillator

Receiver: Variable frequency klystron local oscillator

Type of Emission: P3f (pulse position modulation)

Normal Carrier Output: 1.5 w, peak

Type of Receiver: Superheterodyne, 60 mc If

Attenuation: Max allowable space attenuation is 157 db

Temperature Range: -54 C to +65 degrees C

Multiplexer Characteristics:

Number of Channels: 4 duplex (8 per installation)

Channel Termination: 2-wire, 600-ohm

Type of Multiplexing: Time division

Type of Modulation: Pulse position

Audio Bandwidth: 30-35000 cps

Ring Frequency: 25 cps

Frame Frequency: 8 kc

Antenna: 30-inch paraboloid reflector with off-center diplexing horn, vertical and horizontal polarization

Power Supplies: Self contained in receiver-transmitter and multiplexer units.

Primary Power Sources: 400-cy Generator Set, Gasoline Engine PU-278/TRC-27 (2 supplied)

Major Units:

1	RT-252/TRC-27	14 $\frac{5}{16}$ " x 25 $\frac{5}{16}$ " x 11 $\frac{3}{8}$ "	61 lbs
2	TD-101/TRC-27	14 $\frac{5}{16}$ " x 25 $\frac{5}{16}$ " x 9 $\frac{7}{8}$ "	55 lbs
2	PU-278/TRC-27	17 $\frac{5}{16}$ " x 13 $\frac{1}{4}$ " x 12 $\frac{5}{8}$ "	51 lbs
1	OA-2123/GRC	27" x 17" x 9"	58 lbs

RADIO SET
AN/TRC-27

TUBES, CRYSTALS, TRANSISTORS:

REFERENCE DATA AND LITERATURE:

NAVSHIPS 93098(A)

10-10-10

REPRODUCTION OF THIS DOCUMENT IS UNLAWFUL
WITHOUT THE WRITTEN PERMISSION OF THE
OFFICE OF THE SECRETARY OF DEFENSE

1. The purpose of this report is to provide a comprehensive overview of the current state of the defense industry and its impact on national security. The report is intended for use by policymakers and the general public.

2. The defense industry is a complex and multi-faceted sector that plays a critical role in the nation's defense capabilities. It encompasses a wide range of activities, from the design and development of new technologies to the production and distribution of military equipment.

3. The industry is characterized by a high degree of technological sophistication and a strong emphasis on innovation. This is reflected in the rapid pace of research and development, as well as the significant investment in new technologies.

4. The industry is also characterized by a high degree of competition, with a number of major players vying for market share. This competition has led to a number of significant advances in technology and the development of new products.

5. The industry is a major source of employment, providing a significant number of jobs for the nation's workforce. It is also a major source of revenue for the government, through the sale of military equipment and services.

6. The industry is a key component of the nation's defense capabilities, and its health and vitality are essential for the nation's security. It is therefore important to ensure that the industry is able to continue to innovate and develop new technologies, and to provide the nation with the equipment and services it needs to defend itself.

7. The industry is a complex and multi-faceted sector that plays a critical role in the nation's defense capabilities. It encompasses a wide range of activities, from the design and development of new technologies to the production and distribution of military equipment.

8. The industry is characterized by a high degree of technological sophistication and a strong emphasis on innovation. This is reflected in the rapid pace of research and development, as well as the significant investment in new technologies.

9. The industry is also characterized by a high degree of competition, with a number of major players vying for market share. This competition has led to a number of significant advances in technology and the development of new products.

10. The industry is a major source of employment, providing a significant number of jobs for the nation's workforce. It is also a major source of revenue for the government, through the sale of military equipment and services.

11. The industry is a key component of the nation's defense capabilities, and its health and vitality are essential for the nation's security. It is therefore important to ensure that the industry is able to continue to innovate and develop new technologies, and to provide the nation with the equipment and services it needs to defend itself.

RADIO SET
AN/TRC-28

1 March 1964

Cog. Serv: USA FSN: 5820-503-1130

USA Line Item No.: 647090

	USA	USN	USAF	USMC
STATUS OR TYPE CLASS.:	Std-A		Std	

Manufacturer: Motorola, Inc

FUNCTIONAL DESCRIPTION:

Radio Set AN/TRC-28 is vhf, fm voice communication equipment designed for fixed-station operation, with remote control facilities up to 10 miles. It is used primarily by military police, guard and security organizations.

Operation is primarily simplex; duplex operation is possible with two frequency assignments and additional equipment.

This equipment may also be used as an automatic relay station (retransmission) to extend the distance between terminal stations.

Remote control with intercommunication between the local and distant operating locations is provided; local start-stop operation must be used.

RELATIONSHIP TO SIMILAR EQUIPMENT:**TECHNICAL DESCRIPTION:***Frequency Range in mc:* 152 to 174*Type Modulation:* fm*Type of Signal:* Voice*Power Output:* 45 w without amplifier; 250 w with amplifier*Power Requirements:*

Power Supply PP-638/U: 660 w, 115/230-c 60-cy ac

Power Supply PP-804/U: 230 va, 115/230-v 50-65 cy ac

Power Supply PP-846/U: 46 va, 115/230-v 50-65 cy ac

Major Units:

1	AT-438/GR	6 $\frac{1}{2}$ " x 31" x 5 $\frac{1}{2}$ "	10 lbs
1	CY-1221()/G	21 $\frac{1}{4}$ " x 16 $\frac{7}{8}$ " x 20 $\frac{1}{2}$ "	58 lbs
1	PP-638()/U	26 $\frac{3}{4}$ " x 16 $\frac{1}{2}$ " x 20 $\frac{1}{4}$ "	187 lbs
1	PP-804/U	8 $\frac{5}{8}$ " x 7" x 14 $\frac{1}{2}$ "	40 lbs
2	PP-846/U	5 $\frac{1}{8}$ " x 6 $\frac{1}{4}$ " x 7 $\frac{1}{16}$ "	10 lbs
1	AM-494/GR	9 $\frac{3}{4}$ " x 9 $\frac{1}{2}$ " x 15"	13.5 lbs
1	R-394/U	8 $\frac{1}{2}$ " x 14 $\frac{1}{2}$ " x 5 $\frac{3}{4}$ "	19 lbs
1	C-844/U	8 $\frac{3}{4}$ " x 14 $\frac{3}{4}$ " x 5 $\frac{7}{8}$ "	10 lbs
1	C-845/U	8 $\frac{7}{16}$ " x 13 $\frac{3}{4}$ " x 13 $\frac{1}{2}$ "	17.5 lbs
1	T-416/GR	8 $\frac{1}{2}$ " x 14 $\frac{1}{2}$ " x 4 $\frac{1}{2}$ "	9 lbs

TUBES, CRYSTALS, TRANSISTORS:**REFERENCE DATA AND LITERATURE:**

TM 11-252

MIL-N-115399

RADIO SET

AN/TRC-28

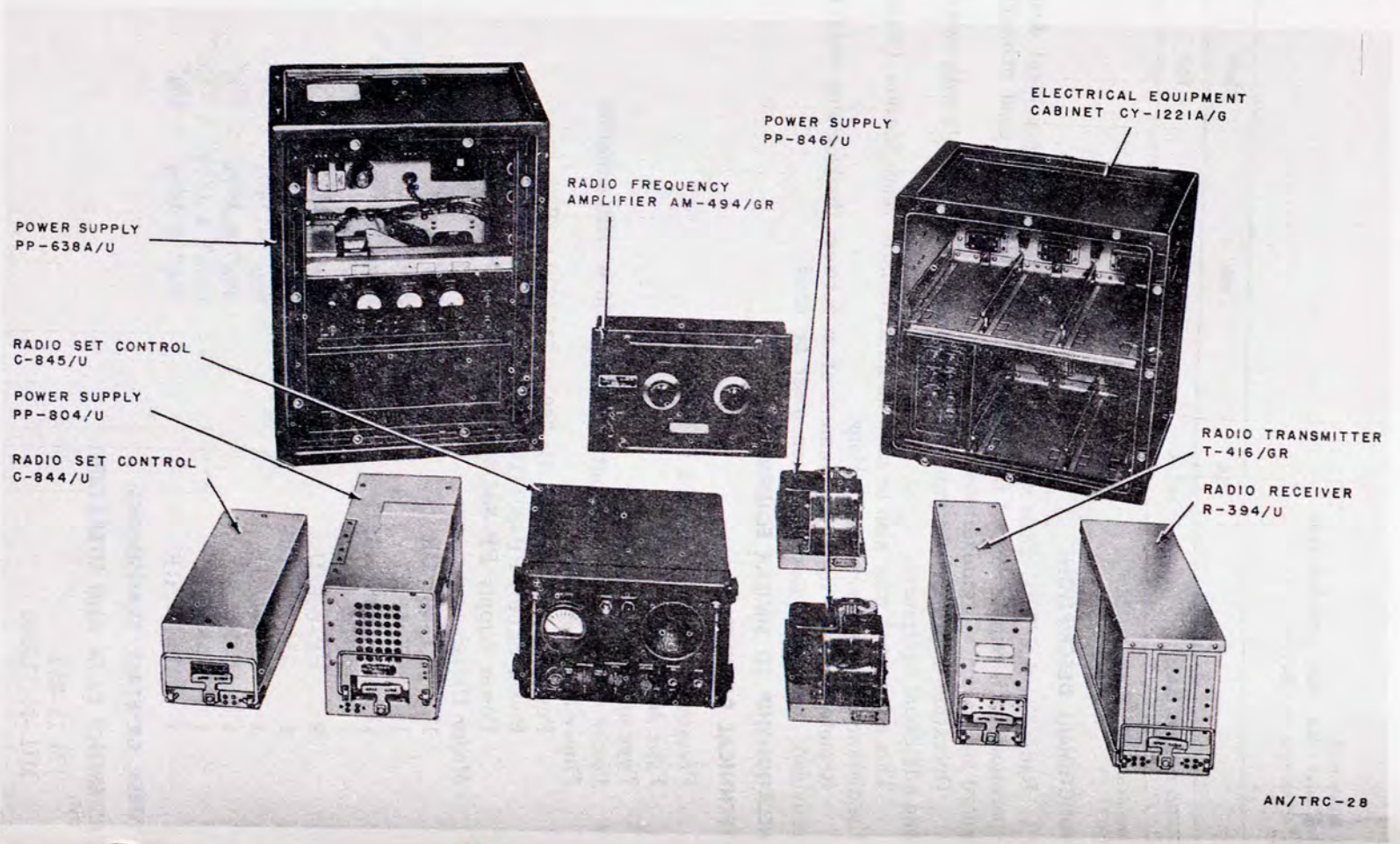

AN/TRC-28

RADIO SET
AN/TRC-29

1 March 1964

Cog. Serv: USA FSN: 5820-503-2581

USA Line Item No.: 647100

	USA	USN	USAF	USMC
STATUS OR TYPE CLASS.:	Std-A		Std	
Manufacturer:	International Tel & Tel Corp, Radio Receptor Co, Inc			

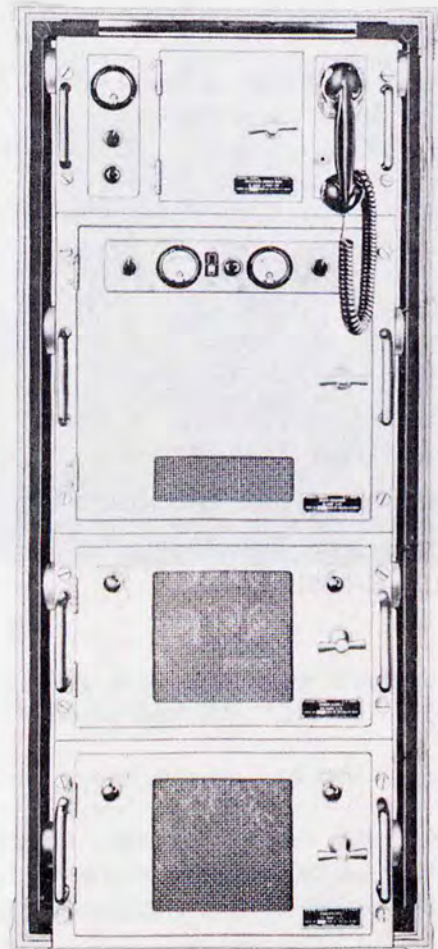
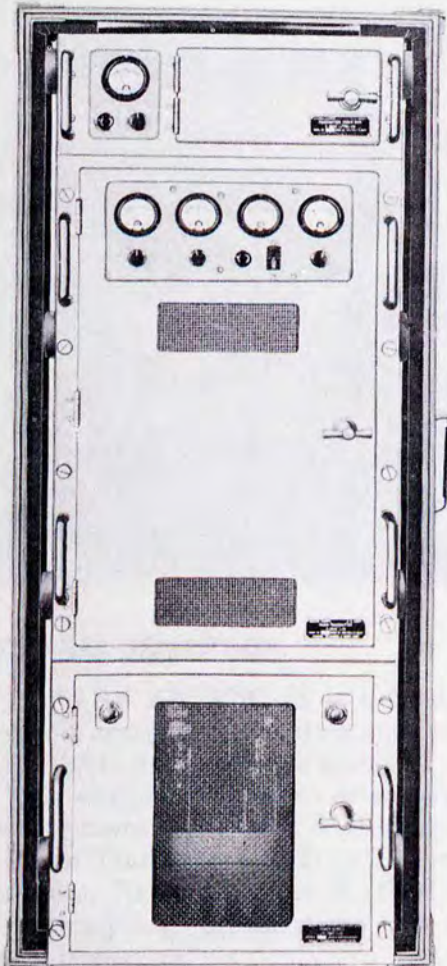

AN/TRC-29

FUNCTIONAL DESCRIPTION:

Radio Set AN/TRC-29 is a two-way, multichannel fm, microwave receiving and transmitting equipment used in radio-relay systems. Although normally used in a rear area radio-relay

RADIO SET

AN/TRC-29

system, it is built to satisfy full field service handling requirements. It is contained in equipment transit cases and can be transported by suitable military vehicles, or it can be mounted in standard relay racks.

This equipment consists of receivers, transmitters, and associated components for handling multichannel telephone, facsimile, telegraph, radar data, or television signals. It can be arranged in a radio-relay system as a terminal or as repeater stations with additional equipment.

This set is designed to operate continuously for long periods of time. It will provide communication trunk service over as many as 20 tandem hops to form circuits up to 600 miles in length.

This equipment is used as a major component of Radio Terminal Set AN/TRC-38 and Radio Repeater Sets AN/TRC-39 through -41.

RELATIONSHIP TO SIMILAR EQUIPMENT:

TECHNICAL DESCRIPTION:

Frequency Range in mc: 1,700 to 2,400

Type Modulation: fm

Type of Signal: Fsk, voice, facsimile, TV, composite

Power Output: 4 to 10 w

Power Requirements: 2,300 w, 115/230-v 50/60 cy ac

Major Units:

1	PP-689/G	21" x 19 $\frac{3}{8}$ " x 21 $\frac{1}{4}$ "
1	PP-690/G	21 $\frac{5}{8}$ " x 19 $\frac{3}{8}$ " x 12 $\frac{1}{4}$ "
1	PP-764/G	21" x 19 $\frac{3}{8}$ " x 17 $\frac{1}{2}$ "
1	R-418/G	21 $\frac{5}{8}$ " x 19 $\frac{3}{8}$ " x 19 $\frac{1}{4}$ "
1	T-303/G	21" x 19 $\frac{3}{8}$ " x 17 $\frac{1}{2}$ "

TUBES, CRYSTALS, TRANSISTORS:

REFERENCE DATA AND LITERATURE:

TM 11-689

MIL-R-10615

RADIO SET
AN/TRC-32

1 December 1958

Cog. Serv: USAF FSN:

USA Line Item No.:

USA

USN

USAF

USMC

STATUS OR TYPE CLASS.:

A/Std

Manufacturer:

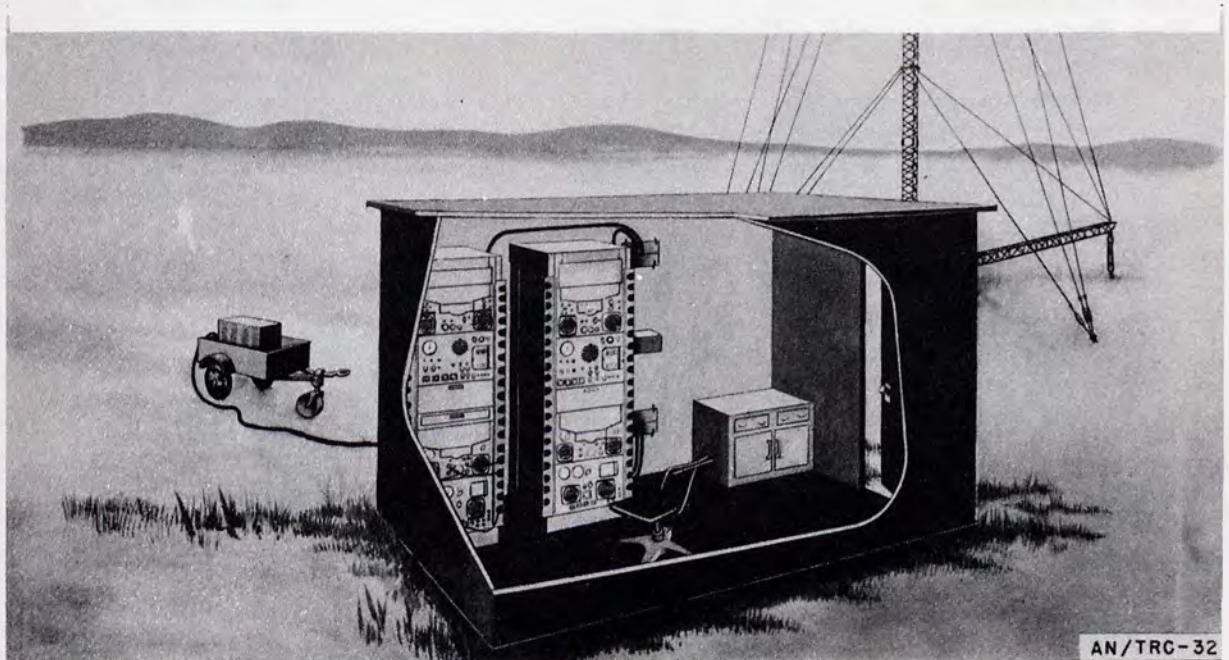
**FUNCTIONAL DESCRIPTION:**

Radio Set AN/TRC-32 is a fixed, ground or mobile, ultra high frequency communication equipment designed for contact with aircraft equipped with Radio Sets AN/ARC-27, AN/ARC-33, AN/ARC-34, or similar units.

This equipment consists essentially of two transmitters, two receivers, and two units of all necessary items required in dual operation.

Radio Transmitter T-217/GR operates on any 10 present channels between 225 and 399.9 megacycles. Radio Receiver R-278/GR operates on any 10 preset channels between 225 and 399.9 megacycles, including any two crystal-controlled guard frequencies in the 238 or 248 megacycle frequency range.

The set matches 53-ohm coaxial cable, such as RG-8/U. A total of three antennas are supplied as part of the set.

All equipment, with the essential operating accessories, is normally transported in 2½ ton truck (modified K-53) and a ½ ton trailer for the power unit.

Remote control operation is possible for a maximum distance of 10 miles over a single field wire pair.

RADIO SET

AN/TRC-32

Radio Set AN/TRC-32 is intended to replace Radio Set AN/MRC-21.

RELATIONSHIP TO SIMILAR EQUIPMENT:**TECHNICAL DESCRIPTION:**

Frequency Range in mc: 225 to 399.9.

Number of Channels: 1,750

Channel Separation: 100 kc

Range of Guard Frequency: 238 to 248 mc

Type Modulation: am

Type Emission and Reception: Voice, cw, mcw

Power Output:

Transmitter: 100 w each

Receiver: 3 w each (max)

Power Requirements: 115- or 230-v, 50- to 60-cy, 1-phase ac (commercial power) or power unit, approximately 4.5 kw

Major Units:

2	MD-129/GR	19" x 12 $\frac{1}{4}$ " x 22 $\frac{3}{8}$ "	180 lbs
2	C-565/GR	19" x 12 $\frac{1}{4}$ " x 11 $\frac{1}{2}$ "	90 lbs
2	R-278/GR	19" x 12 $\frac{1}{4}$ " x 22 $\frac{3}{8}$ "	144 lbs
2	OA-193/GR	23" x 13 $\frac{1}{2}$ " x 21"	105 lbs
2	T-217/GR	19" x 12 $\frac{1}{4}$ " x 22 $\frac{3}{8}$ "	150 lbs
1	K-53 (Modified)	130" x 96" x 256"	11,575 lbs

TUBES, CRYSTALS, TRANSISTORS:**REFERENCE DATA AND LITERATURE:**

Eng-283 and 284

RADIO SET
AN/TRC-34()

1 March 1964

Cog. Serv: USA FSN: 5820-503-1128

USA Line Item No.: 647150

	USA	USN	USAF	USMC
STATUS OR TYPE CLASS.:	Std-A		Std	

Manufacturer: Great American Industries, Inc
Motorola, Inc

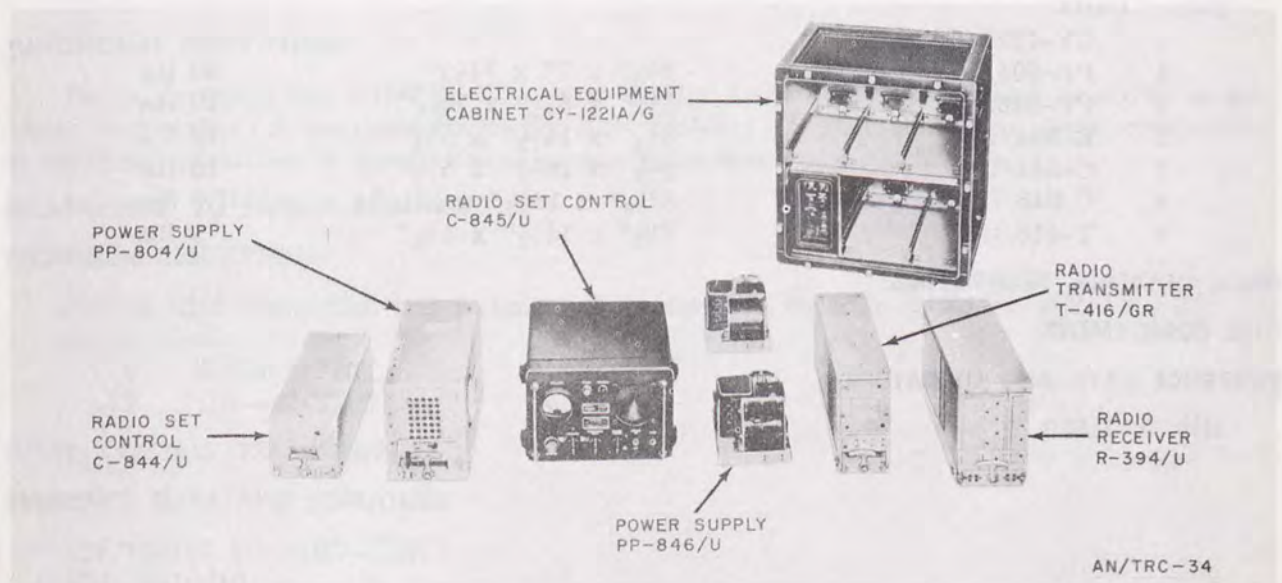
**FUNCTIONAL DESCRIPTION:**

Radio Set AN/TRC-34 () is a vhf, fm, low-powered radio receiving and transmitting equipment used in various communication applications. It is transportable. Its fixed-plant counterpart is Radio Set AN/FRC-27.

This equipment consists of receiver and transmitter components, local- and remote-control units, equipment cabinet, power supplies, and accessories.

It can be operated in simplex, duplex, and retransmission applications. Push-to-talk operation over either of two preset frequency channels is provided either locally or at a maximum distance of 10 miles from the transmitter site. Duplex operation requires an additional antenna and can be conducted from the local operating site only. The remote control unit can be used to transmit tone signals for signaling and for transmitter adjustment, to monitor reception, and to intercommunicate between the remote point and the set.

Radio Sets AN/TRC-34 and AN/TRC-27 are identical, except for a base stand supplied only with the latter.

RADIO SET

AN/TRC-34()

RELATIONSHIP TO SIMILAR EQUIPMENT:

TECHNICAL DESCRIPTION:

Frequency Range in mc: 152 to 174

Type Modulation: fm

Type of Signal: Voice

Transmitter Power Output: 50 w

Power Requirements:

PP-804/U: 230 va, 115/230-v 50/60-cy ac

PP-846/U: 46 va, 115/230-v 50/60-cy ac

Major Units:

1	CY-1221/G		
1	PP-804/U	8 $\frac{5}{8}$ " x 7" x 14 $\frac{1}{2}$ "	40 lbs
2	PP-846/U	5 $\frac{1}{8}$ " x 6 $\frac{1}{4}$ " x 7 $\frac{1}{16}$ "	10 lbs
1	R-394/U	8 $\frac{1}{2}$ " x 14 $\frac{1}{2}$ " x 5 $\frac{3}{4}$ "	19 lbs
1	C-844/U	8 $\frac{3}{4}$ " x 14 $\frac{3}{4}$ " x 5 $\frac{7}{8}$ "	10 lbs
1	C-845/U	8 $\frac{7}{16}$ " x 13 $\frac{3}{4}$ " x 13 $\frac{1}{2}$ "	17.5 lbs
1	T-416/GR	8 $\frac{1}{2}$ " x 14 $\frac{1}{2}$ " x 4 $\frac{1}{2}$ "	9 lbs

TUBES, CRYSTALS, TRANSISTORS:

TUBE COMPLEMENT:

REFERENCE DATA AND LITERATURE:

MIL-N-11539

RADIO TERMINAL SET
AN/TRC-35()

1 March 1964

Cog. Serv: USA FSN: 5820-503-2578

USA Line Item No.: 657255

	USA	USN	USAF	USMC
STATUS OR TYPE CLASS.:	Std-A		Std	

Manufacturer: Philco Radio Corp
 Western Electric Co, Inc

For Illustration see AN/TRC-24, page 653.

FUNCTIONAL DESCRIPTION:

Radio Terminal Set AN/TRC-35() is an fm radio transmitting and receiving equipment. It includes one complete Radio Set AN/TRC-24() plus additional spare components in sufficient quantities to insure 24-hour-a-day radio terminal operation.

RELATIONSHIP TO SIMILAR EQUIPMENT:**TECHNICAL DESCRIPTION:**

For detailed description and technical characteristics, refer to Radio Set AN/TRC-24().

Major Units:

- 1 OA-482/TRC
- 2 OA-483/TRC

TUBES, CRYSTALS, TRANSISTORS:**REFERENCE DATA AND LITERATURE:**

TM 11-787 TO 31R2-2TRC24-11
 MIL-R-10616

ANALYSIS

THESE ARE THE RESULTS OF THE ANALYSIS

DATE: 1944
BY: [illegible]

NO.	DESCRIPTION	QTY.	UNIT	REMARKS
1	[illegible]	[illegible]	[illegible]	[illegible]
2	[illegible]	[illegible]	[illegible]	[illegible]

STRUCTURAL DESCRIPTION

The device is a radio receiver and recording unit. It consists of a vacuum tube radio receiver with a recording mechanism. The receiver is of the superheterodyne type and is capable of receiving signals in the frequency range of 500 to 1500 kc. The recording mechanism is of the magnetic type and is capable of recording signals for a period of 10 minutes.

RELATIONSHIP TO OTHER EQUIPMENT

The device is designed to be used in conjunction with a recording unit. It is capable of receiving signals from a variety of sources, including radio stations and recording units.

TECHNICAL DESCRIPTION

For detailed description and technical characteristics, refer to Radio Set No. 100-201. The device is a vacuum tube radio receiver and recording unit. It consists of a vacuum tube radio receiver with a recording mechanism. The receiver is of the superheterodyne type and is capable of receiving signals in the frequency range of 500 to 1500 kc. The recording mechanism is of the magnetic type and is capable of recording signals for a period of 10 minutes.

TEST CRISTALS, TRANSISTORS

REFERENCE DATA AND LITERATURE

US TM 11-20 TO BUREAU ST-11

MIL-8-10018

RADIO RELAY SET
AN/TRC-36()

1 March 1964

Cog. Serv: USA FSN: 5820-569-0031

USA Line Item No.: 636330

	USA	USN	USAF	USMC
STATUS OR TYPE CLASS.:	Std-A		Std	

Manufacturer: Philco Radio Corp
 Western Electric Co, Inc

For Illustration see AN/TRC-24, page 653.

FUNCTIONAL DESCRIPTION:

Radio Relay Set AN/TRC-36() is an fm radio repeater station used to extend the range of systems using Radio Terminal Set AN/TRC-35(). It includes one complete Radio Set AN/TRC-24() plus two additional sets of radio components and sufficient accessories to insure 24-hour-a-day, radio-relay operation. Two sets of radio transmitting and receiving equipment are in operation at all times, with the third group of equipment as standby.

Multiplexing equipment is not included as part of this equipment, but may be separately provided to permit partial channel dropoff at any of the relay points using this equipment.

RELATIONSHIP TO SIMILAR EQUIPMENT:**TECHNICAL DESCRIPTION:**

For detailed description and technical characteristics, refer to Radio Set AN/TRC-24().

Major Units:

3 OA-483/TRC

TUBES, CRYSTALS, TRANSISTORS:**REFERENCE DATA AND LITERATURE:**

TM 11-687/TO 31R2-2TRC24-11

RADIO TERMINAL SET
AN/TRC-38

1 March 1964

Cog. Serv: USA FSN: 5820-545-7292

USA Line Item No.: 657219

	USA	USN	USMC	USAF
STATUS OR TYPE CLASS.:	Std-A			Std

Manufacturer:

For illustration see AN/TRC-29, page 661.

FUNCTIONAL DESCRIPTION:

Radio Terminal Set AN/TRC-38 consists of two Radio Sets AN/TRC-29 and one Multiplexer Set AN/TCC-13.

It provides microwave radio-relay terminal facilities for 23 voice channels.

RELATIONSHIP TO SIMILAR EQUIPMENT:**TECHNICAL DESCRIPTION:**

For technical characteristics of this equipment, see the entry under individual components, pages 572 and 661, respectively.

Major Units:

1	AN/TCC-13	60" x 64" x 26½"	1,284 lbs
2	AN/TRC-29	60" x 64" x 26½"	1,051 lbs

TUBES, CRYSTALS, TRANSISTORS:**REFERENCE DATA AND LITERATURE:**

TM 11-689

TM 11-2141

RADIO REPEATER SET

AN/TRC-39

1 March 1964

Cog. Serv: USA FSN: 5820-501-3618

USA Line Item No.: 636360

	USA	USN	USAF	USMC
STATUS OR TYPE CLASS.:	Std-A		Std	

Manufacturer:

For Illustration see AN/TRC-29, page 661.

FUNCTIONAL DESCRIPTION:

Radio Repeater Set AN/TRC-39 consists of three Radio Sets AN/TRC-29.

It provides microwave radio-relay repeater facilities for the composite radio signals transmitted by Radio Terminal Set AN/TRC-38; Radio Repeater Set AN/TRC-40 or -41; or another AN/TRC-39. No facilities are provided by this equipment for translation of the composite signal, which consists of 23 voice channels.

RELATIONSHIP TO SIMILAR EQUIPMENT:**TECHNICAL DESCRIPTION:**

For technical characteristics of this equipment, see the entry for Radio Set AN/TRC-29, page 661.

Major Units:

3	AI/TRC-29	60" x 64" x 26½"	1,051 lbs
---	-----------	------------------	-----------

TUBES, CRYSTALS, TRANSISTORS:**REFERENCE DATA AND LITERATURE:**

TM 11-689

AMTIX-33

FORM NO. 100
MAY 1962 EDITION
GSA GEN. REG. NO. 27

CLASSIFICATION	GROUP	SECTION	SUBSECTION	ITEM
----------------	-------	---------	------------	------

1. TITLE AND SYNOPSIS

FUNCTIONAL DESCRIPTION

This document describes the functional characteristics of the AMTIX-33 crystal, which is used in the AMTIX-33 crystal oscillator. The AMTIX-33 crystal is a quartz crystal resonator with a fundamental frequency of 10.000 MHz. It is designed to operate in the fundamental mode and is suitable for use in a wide range of electronic equipment. The crystal is mounted on a ceramic carrier and is protected by a metal shield. The carrier is designed to provide mechanical support and electrical connections for the crystal. The shield is designed to protect the crystal from external magnetic fields and to provide a controlled environment for the crystal. The AMTIX-33 crystal is a high-quality, precision component that is suitable for use in a wide range of electronic equipment.

RELATIONSHIP TO SIMILAR EQUIPMENT

The AMTIX-33 crystal is similar to other quartz crystal resonators used in electronic equipment. It is designed to provide a stable and accurate frequency reference for a wide range of electronic equipment. The AMTIX-33 crystal is a high-quality, precision component that is suitable for use in a wide range of electronic equipment.

TECHNICAL DESCRIPTION

The AMTIX-33 crystal is a quartz crystal resonator with a fundamental frequency of 10.000 MHz. It is designed to operate in the fundamental mode and is suitable for use in a wide range of electronic equipment. The crystal is mounted on a ceramic carrier and is protected by a metal shield. The carrier is designed to provide mechanical support and electrical connections for the crystal. The shield is designed to protect the crystal from external magnetic fields and to provide a controlled environment for the crystal. The AMTIX-33 crystal is a high-quality, precision component that is suitable for use in a wide range of electronic equipment.

1.1 TECHNICAL CHARACTERISTICS OF THE EQUIPMENT

The AMTIX-33 crystal is a high-quality, precision component that is suitable for use in a wide range of electronic equipment. It is designed to provide a stable and accurate frequency reference for a wide range of electronic equipment. The AMTIX-33 crystal is a high-quality, precision component that is suitable for use in a wide range of electronic equipment.

1.2 MATERIALS

The AMTIX-33 crystal is made of quartz, which is a natural mineral. The quartz is cut into a specific shape and is then polished to a high degree of accuracy. The AMTIX-33 crystal is a high-quality, precision component that is suitable for use in a wide range of electronic equipment.

1.3 CRYSTAL TRANSDUCER

The AMTIX-33 crystal is a quartz crystal resonator with a fundamental frequency of 10.000 MHz. It is designed to operate in the fundamental mode and is suitable for use in a wide range of electronic equipment. The crystal is mounted on a ceramic carrier and is protected by a metal shield. The carrier is designed to provide mechanical support and electrical connections for the crystal. The shield is designed to protect the crystal from external magnetic fields and to provide a controlled environment for the crystal. The AMTIX-33 crystal is a high-quality, precision component that is suitable for use in a wide range of electronic equipment.

REFERENCE DATA AND LITERATURE

The AMTIX-33 crystal is a high-quality, precision component that is suitable for use in a wide range of electronic equipment. It is designed to provide a stable and accurate frequency reference for a wide range of electronic equipment. The AMTIX-33 crystal is a high-quality, precision component that is suitable for use in a wide range of electronic equipment.

RADIO REPEATER SET
AN/TRC-40

1 March 1964

Cog. Serv: USA FSN: 5820-646-4759

USA Line Item No.: 636361

	USA	USN	USAF	USMC
STATUS OR TYPE CLASS.:	Std-A		Std	

Manufacturer:

For illustration see AN/TRC-29, page 661.

FUNCTIONAL DESCRIPTION:

Radio Repeater Set AN/TRC-40 consists of three Radio Sets AN/TRC-29 and one Pulse Form Restorer Group AN/TRA-10.

It provides microwave radio-relay repeater facilities for the composite radio signals transmitted by Radio Terminal Set AN/TRC-38; Radio Repeater Set AN/TRC-39 or -41; or another Radio Repeater Set AN/TRC-40. It also provides facilities to reshape the 23- or 45-channel pulse train received from the radio receiver into a standard wave shape before inserting the signal into the radio transmitter. This equipment (or Radio Repeater Set AN/TRC-41) is used once every four or five jumps throughout the system to increase the maximum number of jumps. In addition, this set provides for dropout and reinsertion of channels 1 and 2 of the 23-channel composite signal.

RELATIONSHIP TO SIMILAR EQUIPMENT:**TECHNICAL DESCRIPTION:**

For technical characteristics of this equipment, see the entries for Radio Set AN/TRC-29 and Pulse Form Restorer AN/TRA-10, pages 661 and 623, respectively.

Major Units:

1	AN/TRA-10	26½" x 27" x 60"	810 lbs
3	AN/TRC-29	60" x 64" x 26½"	1,051 lbs

TUBES, CRYSTALS, TRANSISTORS:**REFERENCE DATA AND LITERATURE:**

TM 11-689

TM 11-2141

RADIO REPEATER SET

AN/TRC-41

1 March 1964

Cog. Serv: USA FSN: 5820-646-4760

USA Line Item No.: 636362

	USA	USN	USAF	USMC
STATUS OR TYPE CLASS.:	Std-A		Std	

Manufacturer:

For illustration see AN/TRC-29, page 661.

FUNCTIONAL DESCRIPTION:

Radio Repeater Set AN/TRC-41 consists of three Radio Sets AN/TRC-29 and one Multiplexer Group AN/TCA-1.

It provides microwave radio-relay repeater facilities for the composite radio signals transmitted by Radio Terminal Set AN/TRC-38; Radio Repeater Set AN/TRC-39 or AN/TRC-40; or another Radio Repeater Set AN/TRC-41.

It provides the same pulse restoration facilities as provided by Pulse Form Restorer Group AN/TRA-10 in Radio Repeater Set AN/TRC-40. In addition, the AN/TRC-41 provides for drop-out of channels 1 to 8 of the 23-channel composite signal.

RELATIONSHIP TO SIMILAR EQUIPMENT:**TECHNICAL DESCRIPTION:**

For technical characteristics of this equipment, see the entries for Radio Set AN/TRC-29 and Multiplexer Group AN/TCA-1, pages 661 and 558, respectively.

Major Units:

1	AN/TCA-1	60" x 64" x 26½"	
3	AN/TRC-29	60" x 64" x 26½"	1.051 lbs

TUBES, CRYSTALS, TRANSISTORS:**REFERENCE DATA AND LITERATURE:**

TM 11-689
TM 11-2141

RADIO SET
AN/TRC-42()

1 March 1964

Cog. Serv: USA FSN: 5820-503-2582

USA Line Item No.: 647300

USA

USN

USAF

USMC

STATUS OR TYPE CLASS.: Std-B

Manufacturer: Varo Mfg Co Inc, Schuttig & Co Div

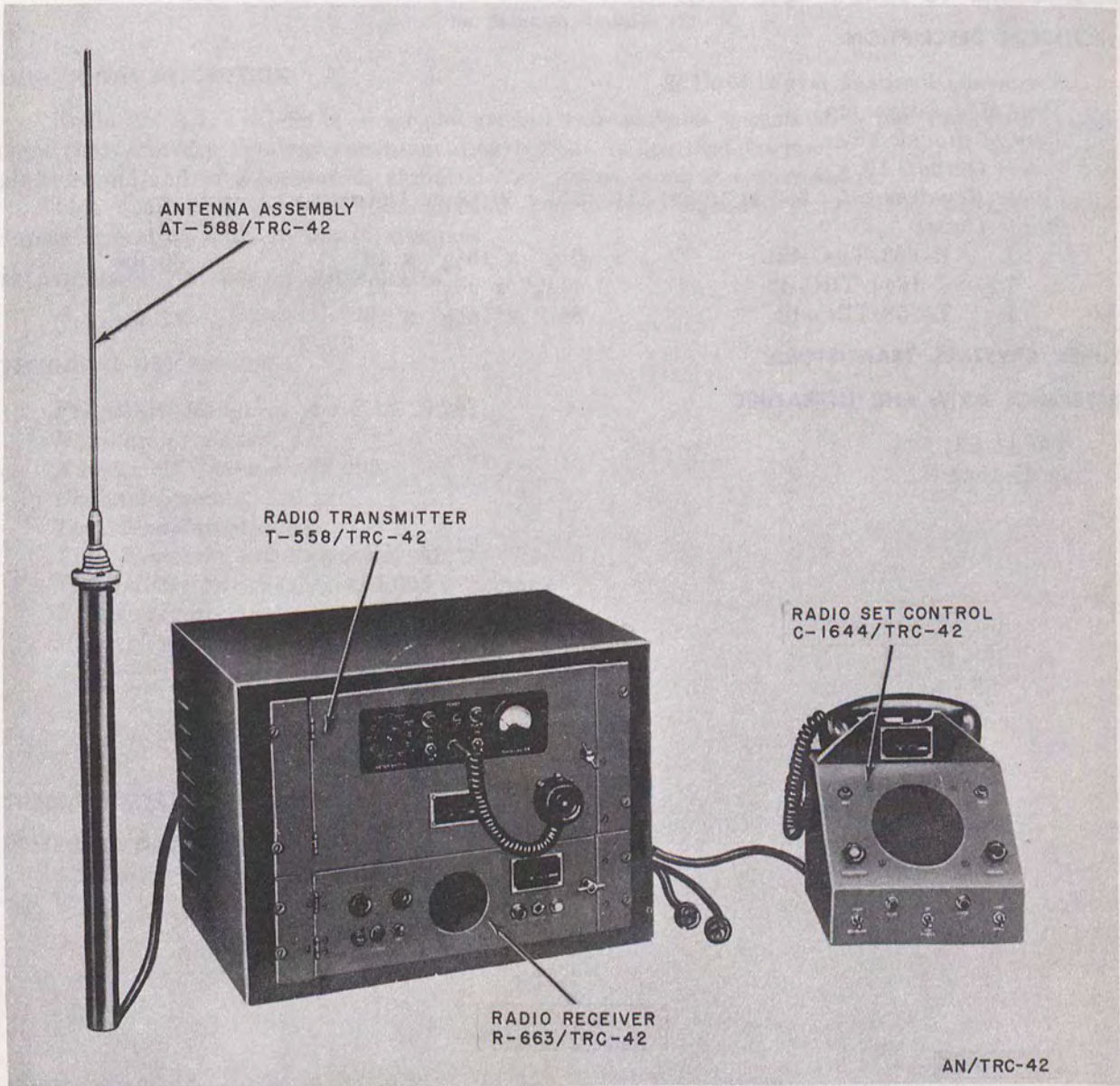

RADIO SET

AN/TRC-42()**FUNCTIONAL DESCRIPTION:**

Radio Set AN/TRC-42() is a transportable vhf single-channel, two-way radio equipment used for ground-to-air communication.

This equipment consists of a radio receiver and a transmitter housed in a single cabinet, and includes a radio set control with handset and accessory items.

It may be operated in the cabinet supplied, or mounted on a standard 19-inch rack.

The radio set control enables operation of the radio equipment from a remote point.

RELATIONSHIP TO SIMILAR EQUIPMENT:**TECHNICAL DESCRIPTION:**

Frequency Range in mc: 116 to 132

Type Modulation: am

Type of Signal: Voice

Power Output: 10 w

Power Requirements: 350 w (max), 115/230-v 50/60-cy 1-phase ac

Major Units:

1	R-663/TRC-42	5 $\frac{1}{4}$ " x 15 $\frac{1}{2}$ " x 19"	30 lbs
1	C-1644/TRC-42	11 $\frac{3}{4}$ " x 9 $\frac{5}{8}$ " x 11"	
1	T-558/TRC-42	8 $\frac{3}{4}$ " x 14 $\frac{1}{2}$ " x 19"	47 lbs

TUBES, CRYSTALS, TRANSISTORS:**REFERENCE DATA AND LITERATURE:**

TM 11-221

RAC-1548 B

RADIO SET
AN/TRC-69

1 March 1964

Cog. Ser: USAF FSN:

USA Line Item No.:

USA

USN

USAF

USMC

STATUS OR TYPE CLASS.:

L/Std

Manufacturer: Collins Radio Co

No Illustration Available

FUNCTIONAL DESCRIPTION:

Radio Set AN/TRC-69 is an air and ground transportable transmitting and receiving equipment that provides two-way communication within its specified frequency range. It utilizes single sideband and/or a compatible amplitude modulated mode of transmission.

This equipment provides air-to-ground and ground-to-ground communications and allows duplex operation with 10 preset channels.

RELATIONSHIP TO SIMILAR EQUIPMENT:

None

TECHNICAL DESCRIPTION:*Frequency Range in mc: 2 to 29.999**Numbers of Bands: 4**Number of Channels: 28,000**Channel Spacing: 100 kc**Type Modulation: am**Type Emission and Reception: A3**Transmitter Power Output: 1,000 w nominal**Power Requirements: 115-v, 400 cy, 3-phase ac**Major Units:*

- 1 F-355/UR()
- 1 PU-419/TRC-69()
- 2 R-761/ARC-58()
- 1 T-605/ARC-58()

TUBES, CRYSTALS, TRANSISTORS:**REFERENCE DATA AND LITERATURE:**

SECRET

... ..
... ..
... ..
... ..
... ..
... ..
... ..
... ..
... ..
... ..

GENERAL DESCRIPTION

The AN/TTC-10 is an air and ground transportable, wide area, two-way communication system. It is a tactical, mobile, two-way communication system. It is designed for use in the tactical environment. It is a tactical, mobile, two-way communication system. It is designed for use in the tactical environment. It is a tactical, mobile, two-way communication system. It is designed for use in the tactical environment.

GENERAL DESCRIPTION

The AN/TTC-10 is an air and ground transportable, wide area, two-way communication system. It is a tactical, mobile, two-way communication system. It is designed for use in the tactical environment. It is a tactical, mobile, two-way communication system. It is designed for use in the tactical environment. It is a tactical, mobile, two-way communication system. It is designed for use in the tactical environment.

- 1. AN/TTC-10 (A)
- 2. AN/TTC-10 (B)
- 3. AN/TTC-10 (C)
- 4. AN/TTC-10 (D)

GENERAL DESCRIPTION

GENERAL DESCRIPTION

RADIO SET
AN/TRC-type

SCR-499-()

1 March 1964

Cog. Serv: USA FSN: 5820-186-3550

USA Line Item No.: 652600

USA

USN

USAF

USMC

STATUS OR TYPE CLASS.: L/Std

Manufacturer: The Hallicrafter Co

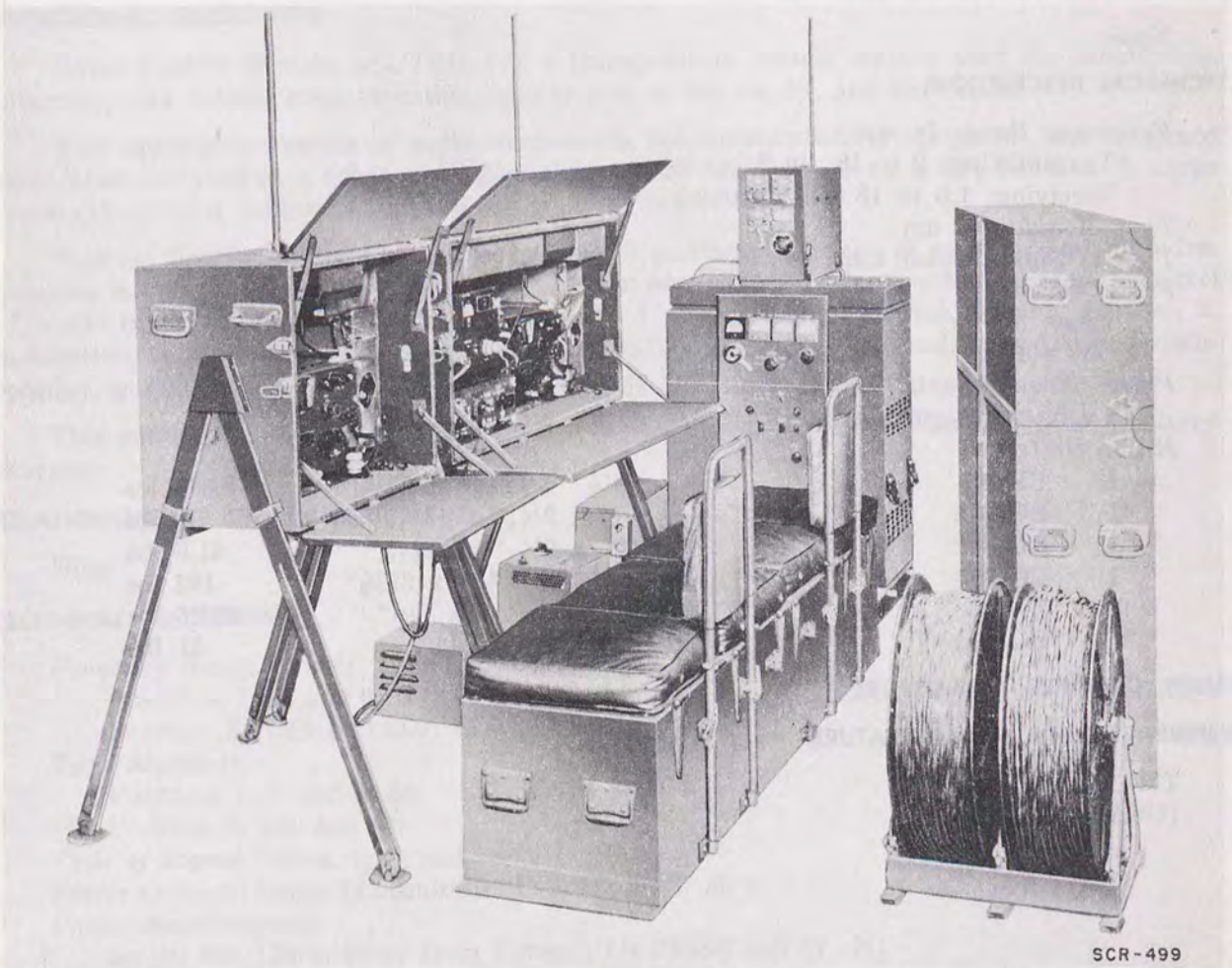

SCR-499

FUNCTIONAL DESCRIPTION:

Radio Set SCR-499-() is the air transportable version of Radio Set SCR-399 and is a medium power, field radio station for AM (voice, tone, and cw) communication over intermediate and long distance in semipermanent or fixed station applications.

RADIO SET
AN/TRC-type

SCR-499-()

This equipment consists of radio receiving and transmitting components plus associated power and control accessories, and is designed for installation in a sheltered or semipermanent location.

By means of standard remote control equipment this radio set can be operated from a distance of about 2 miles over a field telephone pair.

It can be arranged to operate in the 1-mc range by the addition of Frequency Conversion Kit MC-509.

It uses a long-wire or doublet antenna and includes a 5-kw field power unit.

RELATIONSHIP TO SIMILAR EQUIPMENT:

None

TECHNICAL DESCRIPTION:

Frequency Range in mc:

Transmitting: 2 to 18 (in 3 bands)

Receiving: 1.5 to 18 (in 6 bands)

Type Modulation: am

Type of Signal: voice, tone, or cw

Power Output:

Voice: 300 w

Cw: 400 w

Power Requirements: Power Unit PE-95 and 12-v storage battery; or 2,500 w (min), 115-v 60-cy ac commercial power

Major Units:

1	PE-95	75½" x 28½" x 38½"	1,545 lbs
1	BC-312	10" x 9½" x 18½"	58 lbs
1	BC-342	10" x 9½" x 18½"	61.5 lbs
1	BC-610	32⅝" x 21⅜" x 39⅞"	452 lbs
1	RA-63	13½" x 9½" x 7½"	29.25 lbs
1	BC-614	16" x 9¼" x 11"	31 lbs

TUBES, CRYSTALS, TRANSISTORS:

REFERENCE DATA AND LITERATURE:

TM 11-281

(USA) 71-1683A

RADIO CONTROL CENTRAL

AN/TRQ-1

1 March 1964

Cog. Serv: USA FSN: 5820-243-3288

USA Line Item No.: 634700

	USA	USN	USAF	USMC
STATUS OR TYPE CLASS.:	Std-C			

Manufacturer:

FUNCTIONAL DESCRIPTION:

Radio Control Central AN/TRQ-1 is a transportable control station used for monitoring, intercept, and mobile communication applications in the mf, hf, and vhf bands.

This equipment consists of radio components, telephone switching equipment, test items and accessories installed in a field-type shelter that can be transported on a 2½-ton 6 x 6, cargo truck. It includes necessary types of antenna equipment.

This set has four operating positions. At all positions coverage of medium and high frequencies is maintained, and provision is made for wire communication, with and remote control of, radio transmitters located at distances up to 1 mile from the control central. Position 3, in addition, communicates with similar control centrals by means of fm radio and 12-line switchboard.

This equipment derives its power from a trailer-drawn power unit and includes a battery charger.

RELATIONSHIP TO SIMILAR EQUIPMENT:

None

TECHNICAL DESCRIPTION:*Frequency Range in mc:*

Positions 1, 2, and 4: 0.15 to 18.0

Position 3: 1.25 to 143.0; 27.0 to 38.9 (fm)

Type Modulation:

Positions 1, 2, and 4: am

Position 3: am and fm

Type of Signal: Voice, tone, and cw*Power Output* (Radio Transmitter BC-924): 30 to 35 w*Power Requirements:*

ac: 10 kw, 115 v, 60 cy from Power Unit PE-95 (-G or -H)

dc: 12-v storage battery; 10 Batteries BA-30; and 6 Batteries BA-2

Major Units:

1	SCR-211	9¼" x 13¼" x 9"	38 lbs
1	Unit RA-84		
1	PE-95-G	72½" x 28½" x 38½"	1,545 lbs
3	BC-342	10" x 9½" x 18½"	61.5 lbs
3	BC-344	10" x 9½" x 18½"	61.5 lbs

RADIO CONTROL CENTRAL

AN/TRQ-1

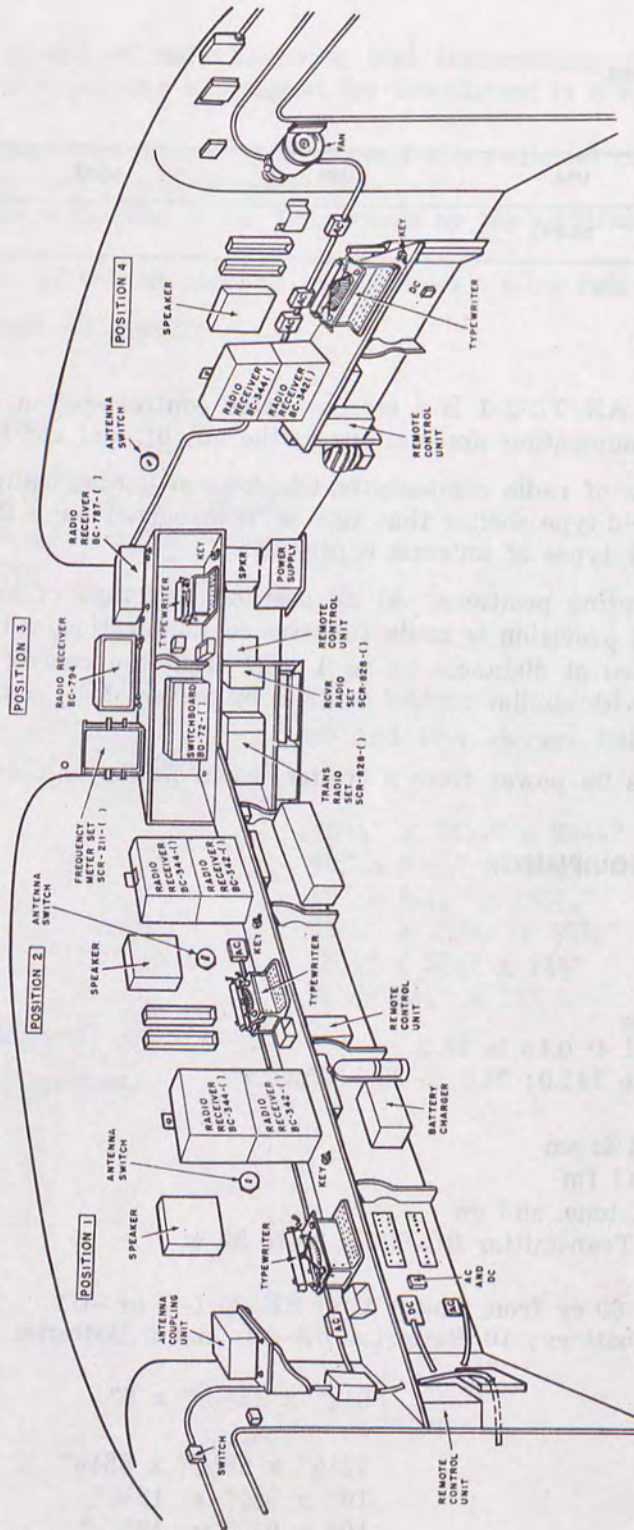

AN/TRQ-1

RADIO CONTROL CENTRAL

AN/TRQ-1

1	BC-794	10½" x 19" x 15¾"	55 lbs
1	S-36		
1	SCR-828-A		373.5 lbs
4	C-103/TRQ-1		
1	BD-72		72 lbs

TUBES, CRYSTALS, TRANSISTORS:

REFERENCE DATA AND LITERATURE:

TM 11-2619
(USA) 271-3081

THE UNIVERSITY OF MICHIGAN LIBRARY

ANN ARBOR, MICHIGAN

1950

1950

1950

1950



1	IN-798
2	2-32
3	SCR-202
4	C-10/TING
5	RD-72

SYSTEM TRANSMITTER
 SYSTEM DATA AND MEASURE

1950-11-20
 1950-11-20

RADIO SET
AN/TRR-2

1 March 1964

Cog. Serv: USA FSN: 5820-221-0176

USA Line Item No.: 647600

USA

USN

USAF

USMC

STATUS OR TYPE CLASS.:

Std-A

Manufacturer: Submarine Signal Co

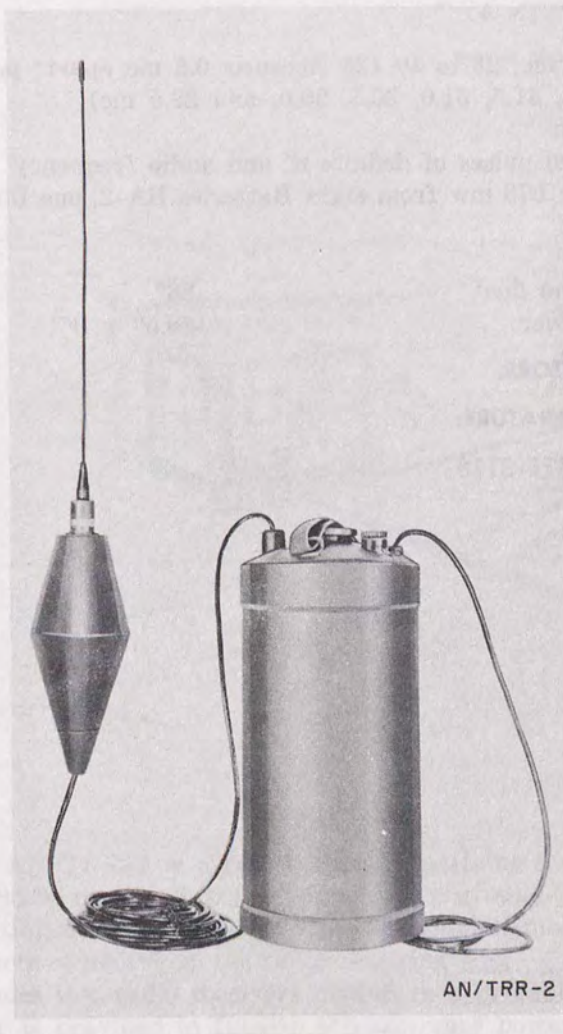

AN/TRR-2

FUNCTIONAL DESCRIPTION:

Radio Set AN/TRR-2 is a radio receiver used in conjunction with Radio Set AN/TRT-1 to comprise a remote detonating system for land and water mines.

RADIO SET

AN/TRR-2

This receiving set is connected to the detonating device and is left in operation. Selective detonating of any one, or group, of mines is available in this system by selection of coded signal combinations of radio frequency, audio tone signals, and pulse code groups. A total of 21,600 different code combinations is available.

This equipment is installed in a waterproof container, and the antenna can be mounted on a float and connected to the receiver through coaxial cable for underwater operation.

RELATIONSHIP TO SIMILAR EQUIPMENT:

None

TECHNICAL DESCRIPTION:

Frequency Range in mc: 28 to 40 (25 channels 0.5 mc apart; presently available for operation on only 32.0, 31.5, 31.0, 30.5, 30.0, and 29.5 mc)

Type Modulation: am

Type of Signal: Coded pulses of definite rf and audio frequency

Power Requirements: 570 mw from eight Batteries BA-2, one Battery BA-34, and two Batteries BA-35

Major Units:

1	Antenna and float	38"	4 lbs
1	Radio receiver	20.5" x 9"	51 lbs

TUBES, CRYSTALS, TRANSISTORS:**REFERENCE DATA AND LITERATURE:**

TM 11-269 (USA) 471-2118

RADIO RECEIVING SET

AN/TRR-7

1 March 1964

Cog. Serv: USAF FSN:

USA Line Item No.:

	USA	USN	USAF	USMC
STATUS OR TYPE CLASS.:			Std	

Manufacturer:

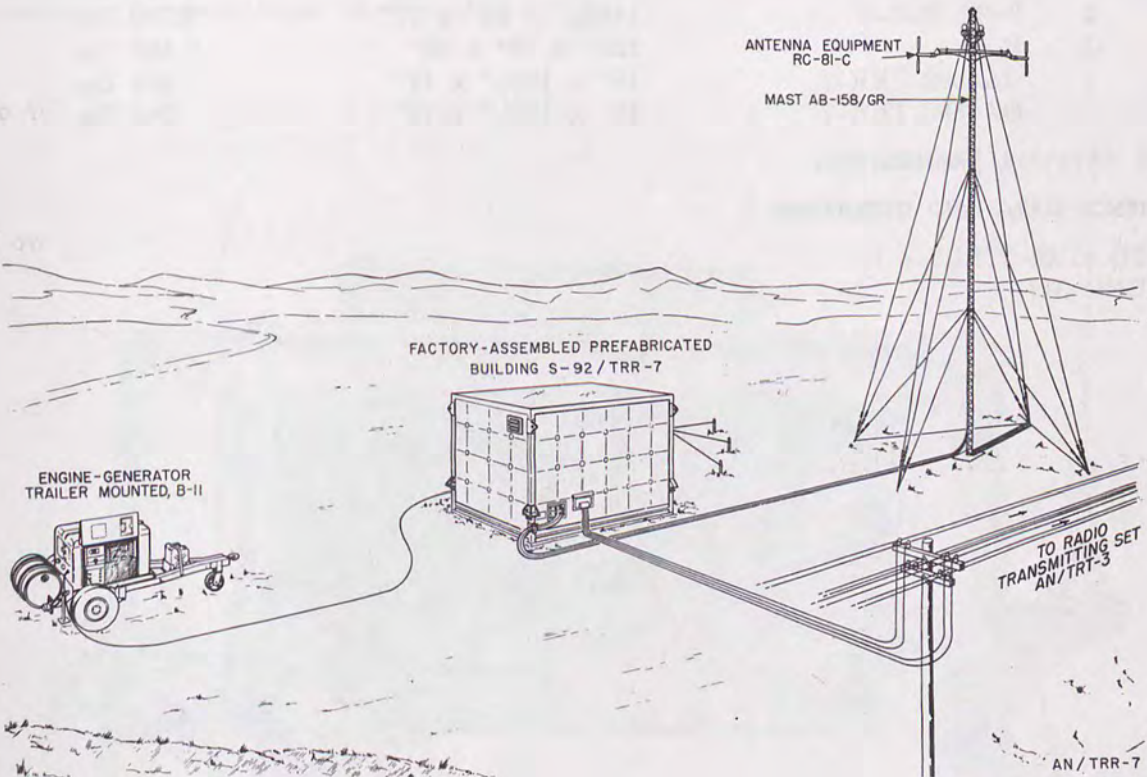
**FUNCTIONAL DESCRIPTION:**

Radio Receiving Set AN/TRR-7 is a complete radio receiving station used for air-to-ground communication. It may also be employed to provide two-way ground-to-air communication when used with Radio Transmitting Set AN/TRT-3, which is a complete mobile radio transmitting station operable through remote control from the radio receiving site.

This equipment includes two radio receivers housed in a prefabricated building. A trailer-mounted engine generator is provided to furnish the necessary power when a suitable commercial power source is not available.

The set is intended to replace Radio Set SCR-574-A.

RELATIONSHIP TO SIMILAR EQUIPMENT:

None

RADIO RECEIVING SET

AN/TRR-7

Frequency Range in mc: 100 to 156

Type Modulation: am

Type Reception: Ad, A3 (cw, voice)

Power Output: 1.2 w

Power Requirements: 6.3 v, 3.5 amp ac; 115-v 1-phase ac (for lighting and ventilation blower motors); 60 ma dc at 210 v

Major Units:

2	RC-81-C		6.75 lbs
1	S-92/TRR-7	140 $\frac{3}{4}$ " x 84" x 77"	3,300 lbs
1	B-11	125" x 63" x 65"	2,450 lbs
1	OA-582/TRR-7	19" x 12 $\frac{7}{8}$ " x 11"	394 lbs
1	OA-583/TRR-7	19" x 12 $\frac{7}{8}$ " x 11"	268 lbs

TUBES, CRYSTALS, TRANSISTORS:**REFERENCE DATA AND LITERATURE:**

TO 31R2-2TRR7-()

ENG-317

RADIO SET
AN/TRT-1

1 March 1964

Cog. Serv: USA FSN: 5820-164-7144

USA Line Item No.: 647700

	USA	USN	USAF	USMC
STATUS OR TYPE CLASS.:	Std-A			
Manufacturer:	Submarine Signal Co			

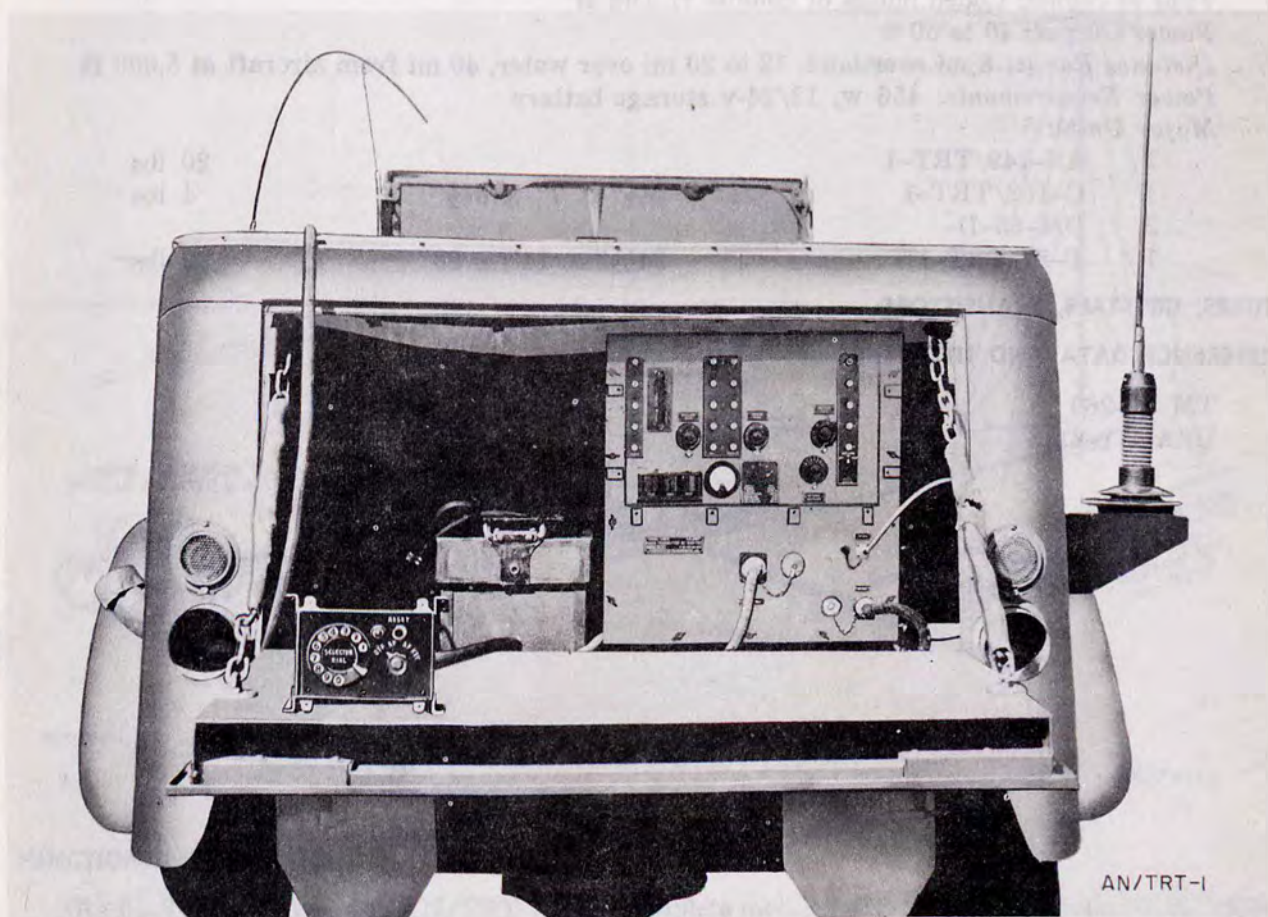
**FUNCTIONAL DESCRIPTION:**

Radio Set AN/TRT-1 is a radio transmitter used in conjunction with Radio Set AN/TRR-2 to comprise a remote detonating system for land and water mines.

Selective detonation is available by adjustment of transmitter RF, audio frequency tone, and coded pulses to correspond with the preset code in the desired Radio Set AN/TRR-2. A total of 21,600 different code combinations are presently available.

RADIO SET

AN/TRT-1

This equipment can be installed in a vehicle, an aircraft or placed on the ground. An external source of 12- or 24-v dc power is required.

RELATIONSHIP TO SIMILAR EQUIPMENT:

None

TECHNICAL DESCRIPTION:

Frequency Range in mc: 28 to 40 (25 channels 0.5 mc apart; presently available for operation on only 32.0, 31.5, 31.0, 30.5, 30.0, and 29.5 mc)

Type Modulation: am

Type of Signal: Coded pulses of definite rf and af

Power Output: 40 to 50 w

Distance Range: 8 mi over land, 12 to 20 mi over water, 40 mi from aircraft at 5,000 ft

Power Requirements: 456 w, 12/24-v storage battery

Major Units:

1	AS-149/TRT-1		20 lbs
1	C-152/TRT-1	5 1/2" x 7" x 5 1/2"	4 lbs
2	DM-35-D		
1	T-87/TRT-1	24 1/2" x 14" x 23"	99 lbs

TUBES, CRYSTALS, TRANSISTORS:

REFERENCE DATA AND LITERATURE:

- TM 11-269
- USA 471-2118

RADIO TRANSMITTER SET

AN/TRT-3

1 March 1964

Cog. Serv: USAF FSN:

USA Line Item No.:

USA

USN

USAF

USMC

STATUS OR TYPE CLASS.:

Std

Manufacturer:

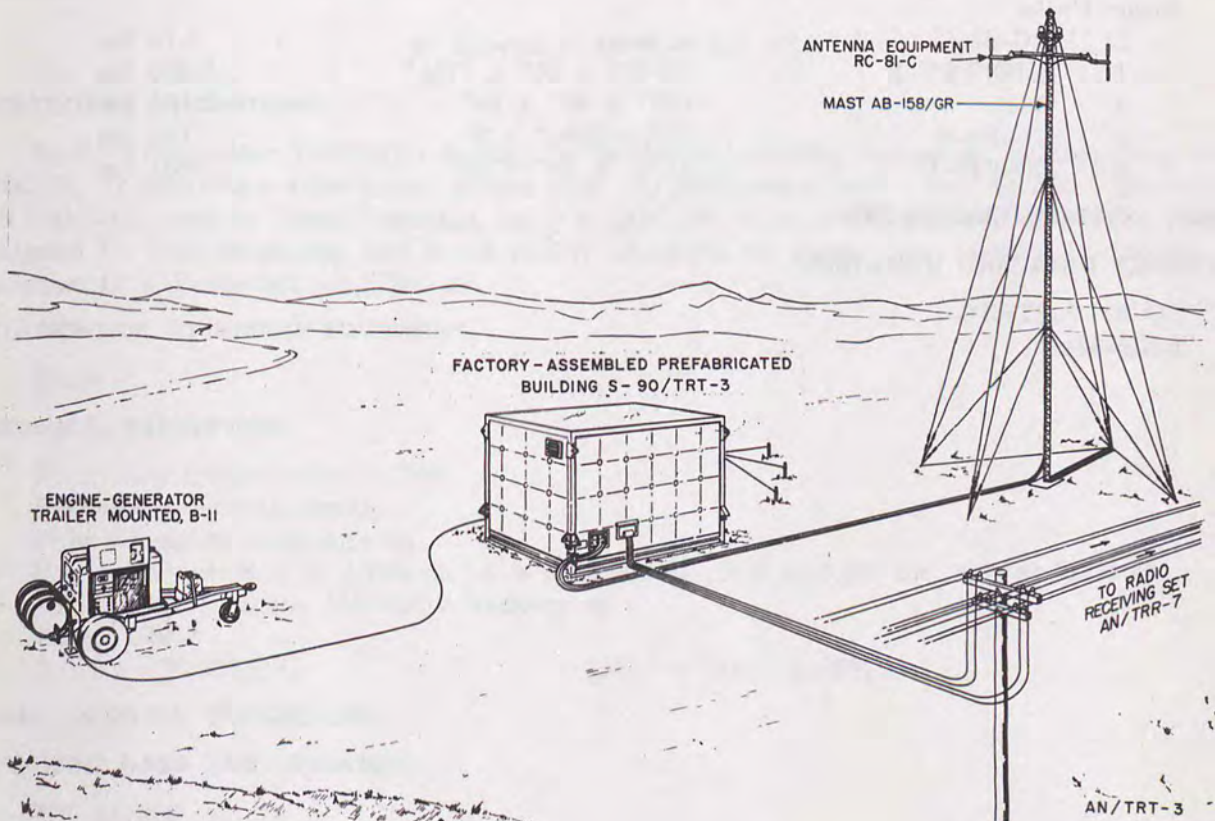
**FUNCTIONAL DESCRIPTION:**

Radio Transmitting Set AN/TRT-3 is a complete mobile radio transmitting station equipped for local or remote radiotelephone and radiotelegraph operation in ground-to-air communication.

The set has two transmitters that can be operated simultaneously on any two desired channels. Operated in conjunction with Radio Receiving Set AN/TRR-7, two-way communication with aircraft or remote radiotelephone and radiotelegraph operation is possible.

This equipment consists essentially of two transmitters housed in a prefabricated building. The building is equipped with alternating current power. Monitoring equipment provides facilities for local and remote operation of the transmitters, and also makes possibly two-way telephone communication with as many as five mobile radio stations.

RADIO TRANSMITTER SET

AN/TRT-3

RELATIONSHIP TO SIMILAR EQUIPMENT:

None

TECHNICAL DESCRIPTION:

Frequency Range in mc: 100 to 156*Type Modulation:* aM*Type Emission:* A2, A3 (tone, voice)*Power Output:* 50 w*Power Requirements:* 4.5 kw, 115- or 230-v, 50- to 60-cy, 1-phase ac*Major Units:*

2	RC-81-C		6.75 lbs
1	S-90/TRT-3	140 $\frac{3}{4}$ " x 84" x 77 $\frac{3}{4}$ "	3,300 lbs
1	B-11	125" x 63" x 65"	2,450 lbs
1	RC-80-A	72" x 20 $\frac{1}{2}$ " x 3"	163 lbs
2	BC-640-D	21 $\frac{1}{4}$ " x 20" x 72"	601 lbs

TUBES, CRYSTALS, TRANSISTORS:

REFERENCE DATA AND LITERATURE:

TO 31R2-2TRT3-()

ENG-322

RADIO TRANSMITTER
AN/TRT-type

T-303A/G

1 March 1964

Cog. Serv: USA FSN: 5820-503-3422

USA Line Item No.:

	USA	USN	USAF	USMC
STATUS OR TYPE CLASS.:	Std-A			

Manufacturer:

For Illustration see AN/TRC-29, page 661.

FUNCTIONAL DESCRIPTION:

Radio Transmitter T-303A/G is designed as the transmitting component of Radio Set AN/TRC-29. It converts a video signal output from the multiplexer unit (such as Multiplexer Set AN/TCC-13, used in Radio Terminal Set AN/TRC-38) into an fm microwave carrier. It is designed for rack mounting, and is not readily adaptable for general use without its companion components in Radio Set AN/TRC-29.

RELATIONSHIP TO SIMILAR EQUIPMENT:

None

TECHNICAL DESCRIPTION:*Frequency Range in mc:* 1,7000*Frequency Control:* crystal*Type Emission:* composite fm*Power Output:* 8 w at 1,700 mc; 6 w at 2,000 mc; 5 w at 2,200 mc; 4 w at 2,400 mc*Power Requirements:* 115/230-v 50-60-cy ac*Major Units:*

1 T-303A/G

19³/₈" x 21⁵/₈" x 29³/₄"**TUBES, CRYSTALS, TRANSISTORS:****REFERENCE DATA AND LITERATURE:**

TM 11/689

UNITED STATES DEPARTMENT OF THE ARMY
OFFICE OF THE CHIEF OF STAFF
WASHINGTON, D. C.

FORM 101 (Rev. 1-25-60)

1. NAME OF THE ORGANIZATION OR AGENCY TO WHICH THIS REPORT IS BEING SUBMITTED
2. TITLE OF THE REPORT

3. AUTHOR(S)

4. SUMMARY OF THE REPORT
The report describes the results of a study conducted to determine the effect of various factors on the performance of a certain system. The study was conducted over a period of six months and involved the use of a large number of test subjects. The results of the study indicate that the performance of the system is significantly affected by the factors mentioned above.

5. ABSTRACT

6. INTRODUCTION

7. GENERAL DESCRIPTION

8. SPECIFIC DESCRIPTION

9. CONCLUSIONS

10. REFERENCES

11. DISTRIBUTION STATEMENTS

12. SECURITY CLASSIFICATION

13. OTHER NOTES

ORDER WIRE TRANSMITTER AN/TRT-type

T-389A/TRC-29

1 March 1964

Cog. Serv: USA FSN:

USA Line Item No.:

USA

USN

USAF

USMC

STATUS OR TYPE CLASS.: Std-A

Manufacturer:

For illustration see AN/TRC-29, page 661.

FUNCTIONAL DESCRIPTION:

Order Wire Transistor T-389A/TRC-29 is the transmitting component of the separate order-wire facilities incorporated into Radio Set AN/TRC-29. This equipment provides low-quality voice facilities for transmission within the system of engineering and operational orders and information from one fixed installation to another fixed installation using certain microwave equipment.

It is designed for installation in the cabinet of the transmitting section of AN/TRC-29, and is not readily adaptable for general use without its companion components in Radio Set AN/TRC-29.

RELATIONSHIP TO SIMILAR EQUIPMENT:

None

TECHNICAL DESCRIPTION:*Transmitting Frequency Range in mc: 5.5 to 6.5**Order-Wire Frequency Range: 300 to 3,450 cps**Keyed Carrier Signaling: 400 mc/500 ohms impedance power output**Power Requirements: 115-v, 50-60-cy 1-phase, ac**Major Units:*

1

7" x 19³/₈" x 21⁵/₈"**TUBES, CRYSTALS, TRANSISTORS:****REFERENCE DATA AND LITERATURE:**

TM 11-689

ORDER YOUR TRANSMITTER...

T-382A/TBC-29

AN...
...

...
...

...

TECHNICAL DESCRIPTION

The transmitter T-382A/TBC-29 is a portable transmitter designed for use in the field. It is a vacuum tube transmitter and is capable of transmitting on the 160, 80, 40, and 20 meter bands. The transmitter is designed for use in the field and is capable of transmitting on the 160, 80, 40, and 20 meter bands. It is a vacuum tube transmitter and is capable of transmitting on the 160, 80, 40, and 20 meter bands. It is a vacuum tube transmitter and is capable of transmitting on the 160, 80, 40, and 20 meter bands.

FOR USE TO SIMILAR EQUIPMENT

TECHNICAL DESCRIPTION

The transmitter T-382A/TBC-29 is a portable transmitter designed for use in the field. It is a vacuum tube transmitter and is capable of transmitting on the 160, 80, 40, and 20 meter bands. The transmitter is designed for use in the field and is capable of transmitting on the 160, 80, 40, and 20 meter bands. It is a vacuum tube transmitter and is capable of transmitting on the 160, 80, 40, and 20 meter bands. It is a vacuum tube transmitter and is capable of transmitting on the 160, 80, 40, and 20 meter bands.

T x 1000 x 1000

SEE CRYSTAL TRANSMITTER

PERFORMANCE DATA AND MEASUREMENTS

...

CONSOLE, COMMUNICATION CONTROL

AN/TSA-16

1 March 1964

Cog. Serv: USMC FSN: 5895-841-5856

USA Line Item No.:

USA

USN

USAF

USMC

STATUS OR TYPE CLASS.:

Manufacturer: Siltronics, Inc

No Illustration Available

FUNCTIONAL DESCRIPTION:

The AN/TSA-16 is a field communication unit designed to receive, monitor and transmit both radio and telephone signals in conjunction with Combat Information Centrals AN/TSQ-5 and AN/TSQ-6. The console will receive and transmit with a 600-ohm impedance when connected to an external, single-phase, 108 to 121-v ac source at an operative frequency of from 58 to 420 cps.

RELATIONSHIP TO SIMILAR EQUIPMENT:

The AN/TSA-16 is used in conjunction with Combat Information Centrals AN/TSQ-5 and AN/TSQ-6.

TECHNICAL DESCRIPTION:

Frequency range: 58 to 420 cps

Power input: 108 to 121 v ac, single phase, three-wire NEMA cable six ft long, three-pin locking receptacle

Audio output: at 400 to 3500 cps

Radio transmitter—72 mw

Radio receiver—1 w to speaker, 150 mw to handset

Major Units:

20 $\frac{1}{4}$ " x 26 $\frac{1}{4}$ " x 30 $\frac{5}{8}$ "

137 lbs

TUBES, CRYSTALS, TRANSISTORS:**REFERENCE DATA AND LITERATURE:**

TM 03059A-15

CLASSIFICATION: UNCLASSIFIED

DATE: 08-14-2001

NO.	DESCRIPTION	DATE	INITIALS

NO. OF PAGES: 10

GENERAL DESCRIPTION:

The AN-124 is a field communication unit designed to receive, transmit and process signals in a field environment. It is capable of receiving signals from a distance of 100 miles and transmitting signals to a distance of 100 miles. The unit is designed to be used in a field environment and is capable of being used in a field environment.

FUNCTIONS TO BE PERFORMED:

The AN-124 is used to communicate with ground stations and other units in the field.

OPERATIONAL DATA:

Weight: 100 lbs
 Dimensions: 10" x 10" x 10"
 Power: 100 W
 Frequency: 100 MHz
 Range: 100 miles
 Accuracy: 100 ft
 Reliability: 100%

104-10

REFERENCES:

1. MILITARY TRANSMITTERS
 2. MILITARY RECEIVERS
 3. MILITARY COMMUNICATIONS

FORM 104-10

MANUAL TELEPHONE CENTRAL OFFICE

AN/TTC-7

1 March 1964

Cog. Serv: USA FSN: 5805-503-1210

USA Line Item No.: 609536

	USA	USN	USAF
STATUS OR TYPE CLASS:	Std-A		Std

Manufacturer: General Dynamics Corp

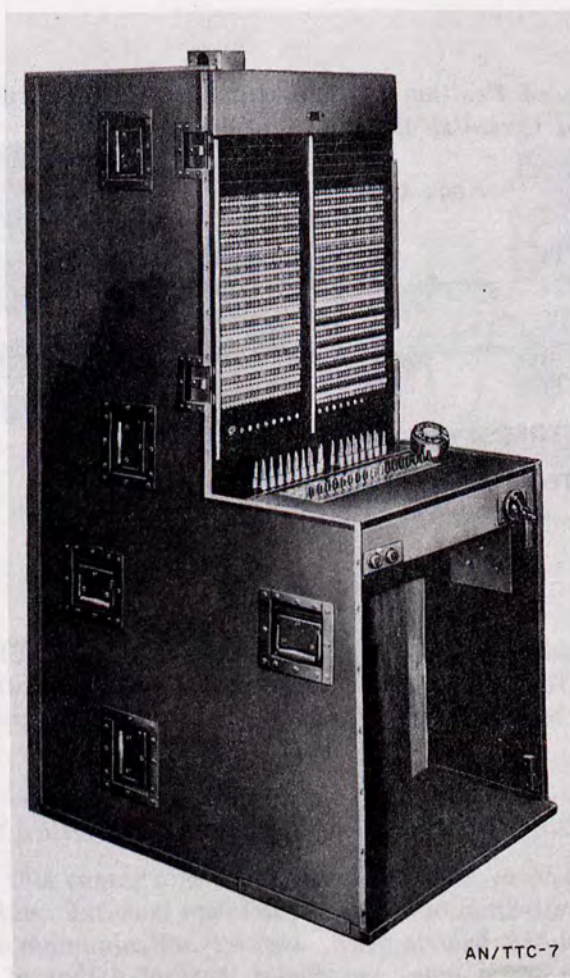

AN/TTC-7

FUNCTIONAL DESCRIPTION:

Manual Telephone Central Office AN/TTC-7 is a complete, transportable, three-position multiple field telephone exchange designed for rapid installation. It can handle local or common battery lines.

MANUAL TELEPHONE CENTRAL OFFICE

AN/TTC-7

This equipment consists essentially of three two-panel manual switchboards connected in multiple, each board with a maximum capacity of 200 lines and 20 trunks. It includes power and accessory components.

Each position is equipped with 15 cord circuits, thus giving a maximum capacity of 45 simultaneous calls. The face equipment of each position is wired to accommodate 500 lines and 80 trunks. For each additional 200 lines, three more switchboard positions are required.

To handle more than 400 lines, multiplying on a four-panel basis is recommended; in this manner, the exchange may be expanded to accommodate 1,000 lines and 160 trunks.

RELATIONSHIP TO SIMILAR EQUIPMENT:

None.

TECHNICAL DESCRIPTION:

Number of Switchboard Positions: 3 min expandable in multiples of 3 or 4

Number and Type of Circuits: 45 cord; 200 line; 20 trunk

Ringling: 20 cps at 90 v

Power Requirements: 110-v ac; 48-v dc

Major Units:

1	TA-223/TTC	26 $\frac{5}{8}$ " x 31 $\frac{5}{16}$ " x 17"	230 lbs
1	TA-224/TTC	26 $\frac{5}{8}$ " x 31 $\frac{5}{16}$ " x 17"	275 lbs
3	SB-249/TTC	72" x 26 $\frac{3}{16}$ " x 26 $\frac{1}{2}$ "	850 lbs
1	TA-257/TTC	26 $\frac{5}{8}$ " x 31 $\frac{5}{16}$ " x 17"	150 lbs
	TA-226/TTC		

TUBES, CRYSTALS, TRANSISTORS:

REFERENCE DATA AND LITERATURE:

TM 11-2146

MIL-C-14255

OPERATIONS CENTER

AN/TTQ-2

1 March 1964

Cog. Serv: USA FSN: 5895-171-2682

USA Line Item No.: 628830

USA

USN

USAF

USMC

STATUS OR TYPE CLASS.:

Std

Manufacturer: Western Electric Co

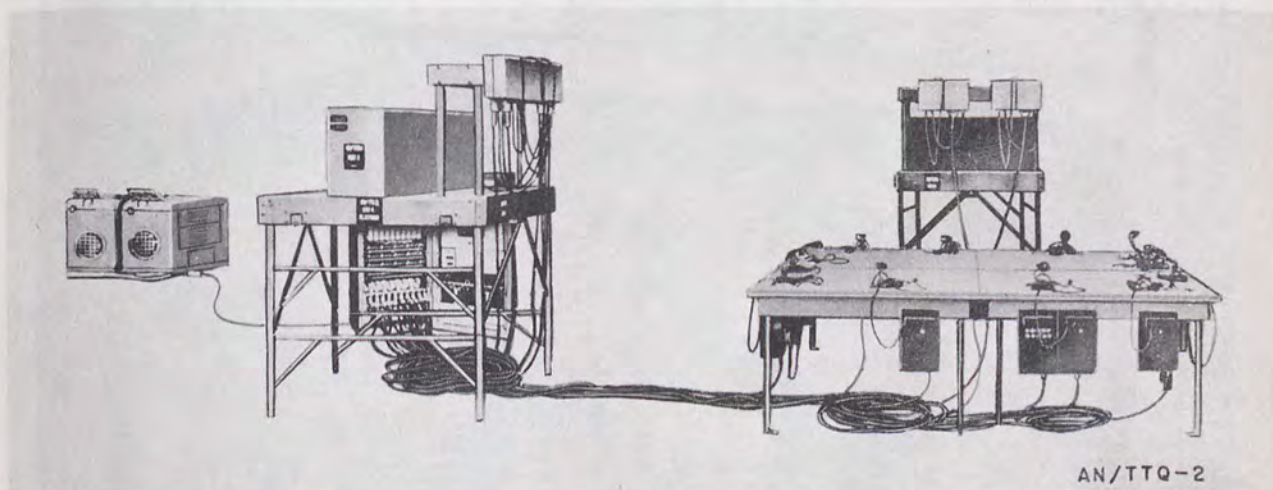
**FUNCTIONAL DESCRIPTION:**

Operations Center AN/TTQ-2 is a complete, transportable assemblage of items that can be rapidly erected to serve as an antiaircraft operations room, an aircraft warning center or similar control center. It is designed to be used as the headquarters of an antiaircraft control system.

This equipment consists essentially of telephone, line switching, lighting, and plotting equipment and includes items of furniture, a power supply, control components, and supplies.

Communication between this center and other military units or installations is maintained by radio and telephone facilities. Internal operational and administrative communication is conducted by means of an intercommunication system. Switchboard BD-95 is used to connect to incoming wire facilities and to switch internal telephones serving the center.

RELATIONSHIP TO SIMILAR EQUIPMENT:**TECHNICAL DESCRIPTION:**

Type Communication Circuits: Conventional wire and radio circuits

Controls: 8 radio channel control circuits

Power Requirements: 115-v 60-cy ac

OPERATIONS CENTER

AN/TTQ-2

Major Units:

14	TA-10/TTQ	41½" x 5⅞" x 9"	
2	PE-197	44" x 31" x 22"	790 lbs
1	RE-24()/TTQ-1	48" x 24" x 12"	220 lbs
1	SB-26/TTQ	48" x 24" x 12"	298 lbs
20	TA-9/TTQ	9" x 7⅝" x 4½"	

TUBES, CRYSTALS, TRANSISTORS:

REFERENCE DATA AND LITERATURE:

TM 11-448
(USA) 71-3170

RADIO INTERCEPT CONTROL SET

AN/TTQ-3

1 March 1964

Cog. Serv: USA FSN: 5825-333-9687

USA Line Item No.: 634875

USA

USN

USAF

USMC

STATUS OR TYPE CLASS.: Std-B

Manufacturer: Emerson Radio & Phonograph Corp

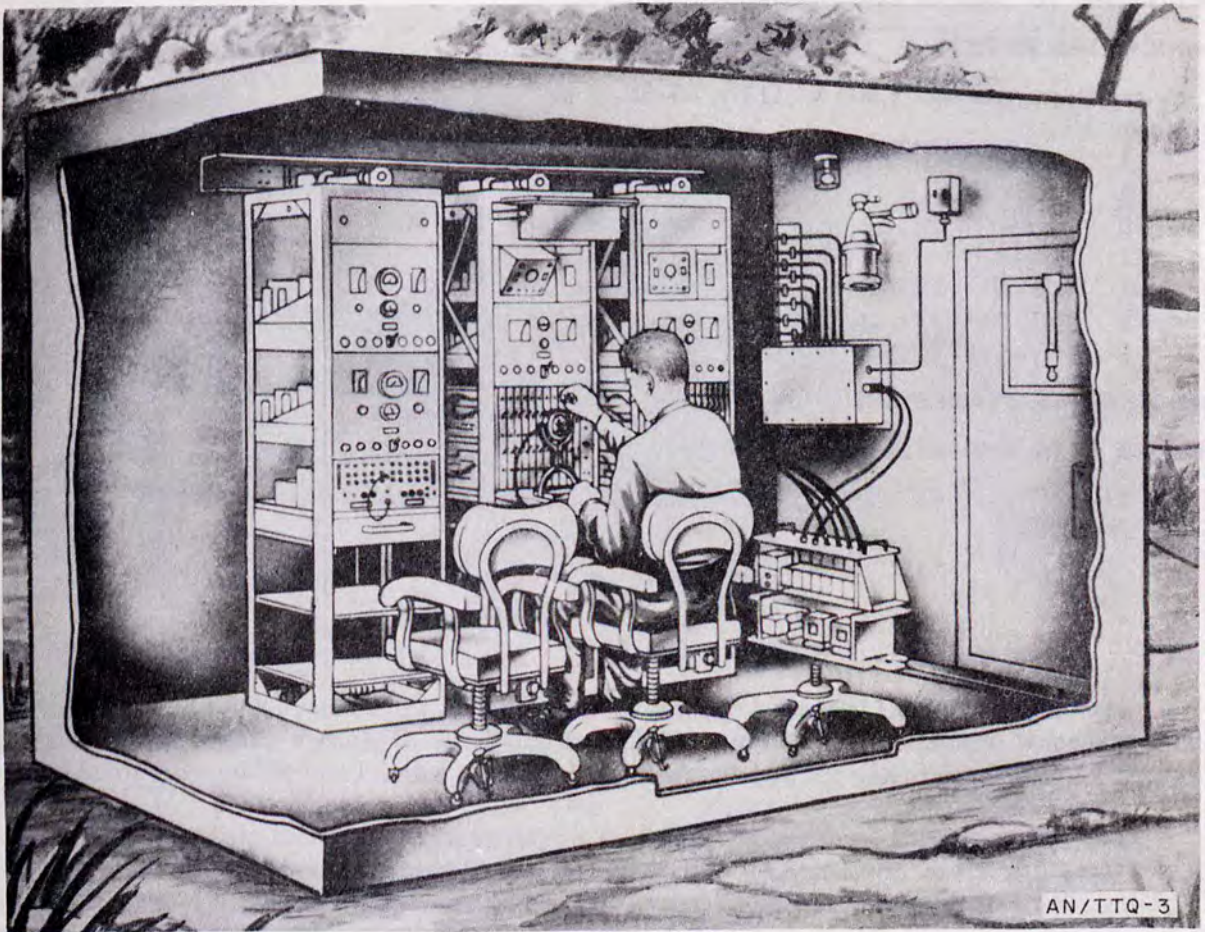
**FUNCTIONAL DESCRIPTION:**

Radio Intercept Control Set AN/TTQ-3 provides facilities for the supervision and control of a number of such equipment as Radio Intercept Group OA-596-TTQ-3. In a complete radio intercept system, the AN/TTQ-3 can supervise and control eight such groups.

Operating in such a system, it provides monitoring of radio signals intercepted by the operating positions located at the remote groups; local monitoring of intercepted radio signals;

RADIO INTERCEPT CONTROL SET

AN/TTQ-3

wire communication with all operating positions; establishment of conference calls between all intercept operator positions that are connected through one control position; and coordination of direction-finding operations.

The components of this set are grouped into three operating positions. Two identical control operator positions provide communication and monitoring facilities for supervisory personnel. The third position provides similar facilities for the coordination of direction-finding operations. Wiring within the AN/TTQ-3 is such that each control operator position controls and supervises half the remote groups; the df tracker position can receive signals from all intercept operator positions.

RELATIONSHIP TO SIMILAR EQUIPMENT:

TECHNICAL DESCRIPTION:

Power Requirements: 1,500 w, 115-v, 55-65-cy ac

Major Units:

1	OA-323/G		128 lbs
1	PU-236/G		
2	RA-133-B		
1	S-44/G	136" x 71" x 74"	2,127 lbs
1	SB-214/TTQ-3	20 $\frac{1}{4}$ " x 23 $\frac{1}{4}$ " x 71 $\frac{1}{2}$ "	145 lbs
2	SB-213/TTQ-3	20 $\frac{1}{4}$ " x 23 $\frac{1}{4}$ " x 71 $\frac{1}{2}$ "	1,166 lbs
2	TS-725/TTQ-3		46 lbs

TUBES, CRYSTALS, TRANSISTORS:

REFERENCE DATA AND LITERATURE:

TM 11-5067
MIL-I-10768

AN/TXA-type
FREQUENCY SHIFT CONVERTERCV-172/U
CV-172A/U

26 November 1958

Cog. Serv: USN FSN: CV-172/U: 5815-665-1995
CV-172A/U: 5815-096-6992

USA Line Item No.: 617090

USA

USN

USAF

USMC

STATUS OR TYPE CLASS.:

L/Std(CV-172/U)
Std(CV-172A/U)

Manufacturer: Times Facsimile Corp

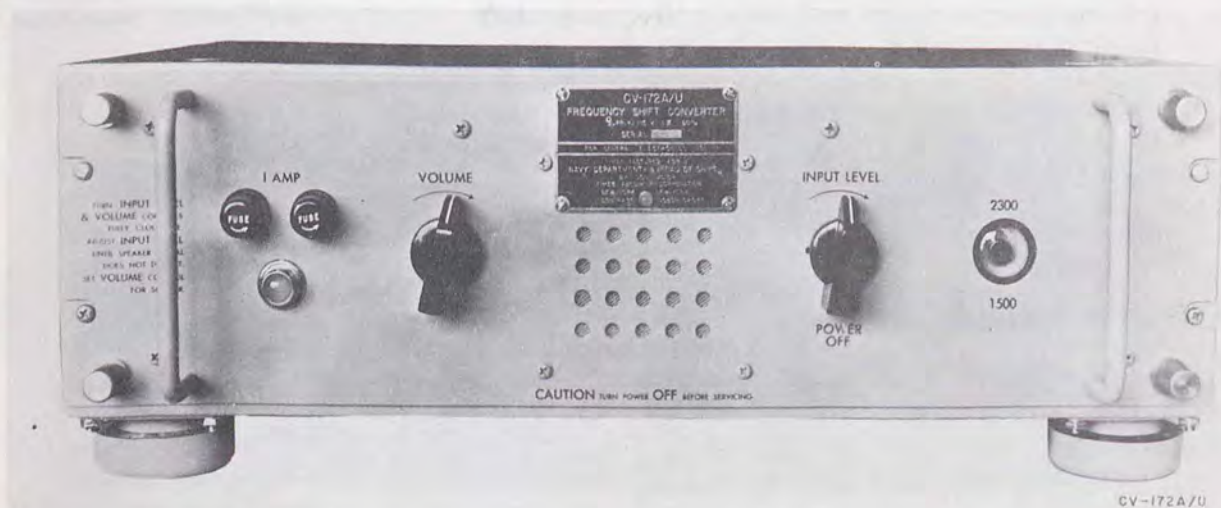
**FUNCTIONAL DESCRIPTION:**

Frequency Shift Converters CV-172/U and CV-172A/U convert 1,500- and 2,300-cps audio-frequency-shift facsimile signals to amplitude-modulated signals for a facsimile recorder. Provisions are made for audible monitoring of the incoming signal and for visual checking of frequency limits.

The input signal is fed through an amplifier to a limiter and then through a frequency discriminator. A loudspeaker is connected to the output of the amplifier and has a separate volume control. The output of the limiter is also fed to two tuned circuits, resonated at 1,500 and 2,300 cycles per second respectively, to operate the tuning eye.

Frequency Shift Converters CV-172/U and CV-172A/U are used as part of terminal equipment at the receiving end of a radio facsimile circuit of the audio-frequency-shift or radio-frequency-shift type. The signal from the radio receiver with either system is an audio-frequency-shifted signal in which 1,500 cps represents maximum signal (black) and 2,300 cycles per second represents minimum signal output (white) from the facsimile transmitter at the sending terminal. The amplitude of the signal to the converter may vary as much as 50 decibels due to transmission effects of the radio circuit.

AN/TXA-type
FREQUENCY SHIFT CONVERTER

CV-172/U
CV-172A/U

These converters are used primarily with Facsimile Recorder RD-92/UX, and may be installed in shore or shipboard stations.

The CV-172/U and CV-172A/U are electrically and mechanically interchangeable but the CV-172A/U is an improved design.

RELATIONSHIP TO SIMILAR EQUIPMENT:

TECHNICAL DESCRIPTION:

Frequency Range: 1,500 to 2,300 cps, frequency swing ± 400 cps

Input Data:

Impedance: 500 ohms, balanced

Facsimile Signal: 1,500 to 2,300 cps, frequency shift

Level: 0 to -40 dbm

Output Data:

Impedance: 500 ohms, balanced

Facsimile Signal: 1,500 cps at .25-v ac; 2,300 cps at 0.01-v ac

Power Requirements: 30 w 100-130-v 50-60-cy ac

Major Units:

1	CV-172/U	5 $\frac{5}{8}$ " x 16 $\frac{1}{2}$ " x 19 $\frac{3}{16}$ "	
1	CV-172A/U	6 $\frac{3}{4}$ " x 16 $\frac{1}{2}$ " x 19 $\frac{1}{8}$ "	56 lbs

TUBES, CRYSTALS, TRANSISTORS:

REFERENCE DATA AND LITERATURE:

NAVSHIPS 91394

TM 11-5105

SHIPS-F-264; Dwg: 45C-00-00-00

AN/TXA-type
ADAPTER KEYERKY-44/FX
KY-44A/FX
KY-44B/FX
KY-44C/FX

25 November 1958

Cog. Serv: USN FSN: KY-44/FX: 5815-372-3043

USA Line Item No.: 622080

USA

USN

USAF

USMC

STATUS OR TYPE CLASS.:

Std

Manufacturer: Times Facsimile Corp

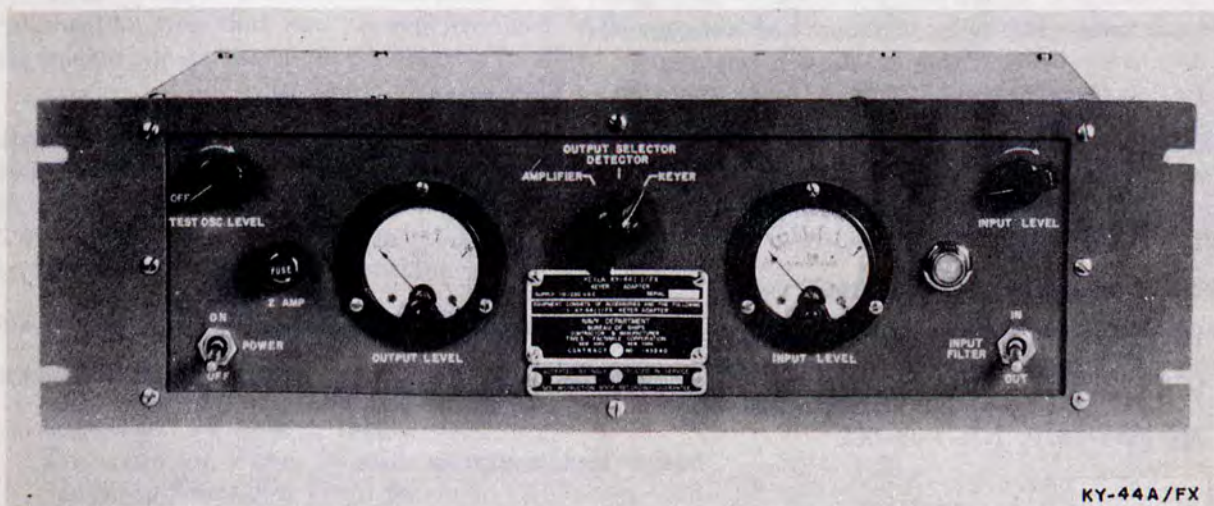

KY-44A/FX

FUNCTIONAL DESCRIPTION:

Adapter Keyers KY-44/FX, KY-44A/FX, KY-44B/FX, and KY-44C/FX are primarily used to convert facsimile signals to direct current. They simplify and rectify amplitude-modulated facsimile signals to provide a variable direct current voltage for the control of frequency-shift exciter units in radio transmitting equipment. They can also be used as unfiltered detectors of amplitude-modulated filters or as line amplifiers.

Meters are provided to monitor the input and output signals. Controls are available for adjusting the output level and for selecting the type of output signal.

The KY-44/FX, KY-44A/FX, KY-44B/FX, and KY-44C/FX are interchangeable with each other and are similar except for changes in design and component parts. They may be installed at shore or shipboard stations.

These equipments are used in conjunction with Keyers KY-30/GRT, KY-58/GRT, KY-75/SRT; Frequency Shift Keyer Equipment FSA; Radio Transmitting Set AN/URT-2, AN/URT-3, AN/URT-4; and similar types of frequency-shift keyers.

AN/TXA-type
ADAPTER KEYS

KY-44/FX
KY-44A/FX
KY-44B/FX
KY-44C/FX

TECHNICAL CHARACTERISTICS:

Frequency Range: 100 to 7,000 cps

Type Modulation: am

Type Signal:

Input: Facsimile

Output: Keying signals, dc; detected signals, unfiltered; amplified signals

Signal Level:

Input: -20 to + 6 dbm

Output: Linear within $\pm 5\%$ to 20 v dc or ac

Impedance: 600 ohms, balanced or unbalanced

Mounting Data: Table or 19-inch relay rack

Power Requirements: 40 w, 115- or 230-v 60-cy 1-phase ac

Major Units:

1 KY-44/FX, KY-44A/FX, 6 1/2" x 15" x 19 3/4" 40 lbs
KY-44B/FX, or KY-44C/FX

TUBES, CRYSTALS, TRANSISTORS:

REFERENCE DATA AND LITERATURE:

For KY-44A/FX: NAVSHIPS 91441

For KY-44B/FX: NAVSHIPS 91877

For KY-44C/FX: NAVSHIPS 91627

NE-634-2810, NE-P08-002

FACSIMILE SET
AN/TXC-1()

1 March 1964

Cog. Serv: USA FSN: 5815-356-3753

USA Line Item No.: 615550

	USA	USN	USAF	USMC
STATUS OR TYPE CLASS.:	Std-A		Std	

Manufacturer: Time Telephoto Equipment, Inc

FUNCTIONAL DESCRIPTION:

Facsimile Set AN/TCX-1(), is a transmitting and receiving equipment for communication of graphic material, such as documents, photographs, drawings, and charts, over conventional communication channels.

This equipment consists essentially of a rotating drum, an optical system, and related control mechanisms that can be synchronized with compatible transmitting or receiving facsimile sets operating on the same connecting facility.

This set can be used in wire lines by coupling directly to such facilities through input and output terminals provided on the equipment, or through a coil magnetically coupled to the receiver of a handset, or inductively to certain types of wire lines. It can also be used on radio circuits by using Converter CV-2()/TX to convert to subcarrier frequencies, and by means of one model of this converter (CV-2C/TX) in conjunction with Exciter Unit O-5/FR to operate in frequency shift transmission.

RELATIONSHIP TO SIMILAR EQUIPMENT:**TECHNICAL DESCRIPTION:***Page Size:* 12 x 18 $\frac{1}{4}$ inches*Transmission Time:* 20 min; 40 min at half speed*Scanning Lines Per Inch:* 96*Keying Frequency:* 900 cps*Carrier Frequency:* 1,800 cps*Signal Band Required:* 900 to 2,700 cps*Diametral Index of Cooperation:* 576*Speed of Drum Rotation:* 60 rpm; 30 rpm also available in AN/TXC-1D, -IE, and -IF*Power Requirements:* 250 w, 100-130-v 50-65-cy ac*Major Units:*

1	TT-1/TXC-1	10 $\frac{3}{4}$ " x 17 $\frac{5}{8}$ " x 34 $\frac{5}{8}$ "	85 lbs
1	PH-549/TXC-1		83 lbs
1	PP-86/TXC-1	9" x 10" x 12"	84 lbs
1	MT-252/TXC-1	32" x 22" x 37"	86 lbs

TUBES, CRYSTALS, TRANSISTORS:

TM 11-489

TM 11-2258

(USA) 71-3107

-HDBK-161A/TM11-487A-3/NAVEXOS P-2058/TO 31-3-73

CSIMILE SET
AN/TXC-1()

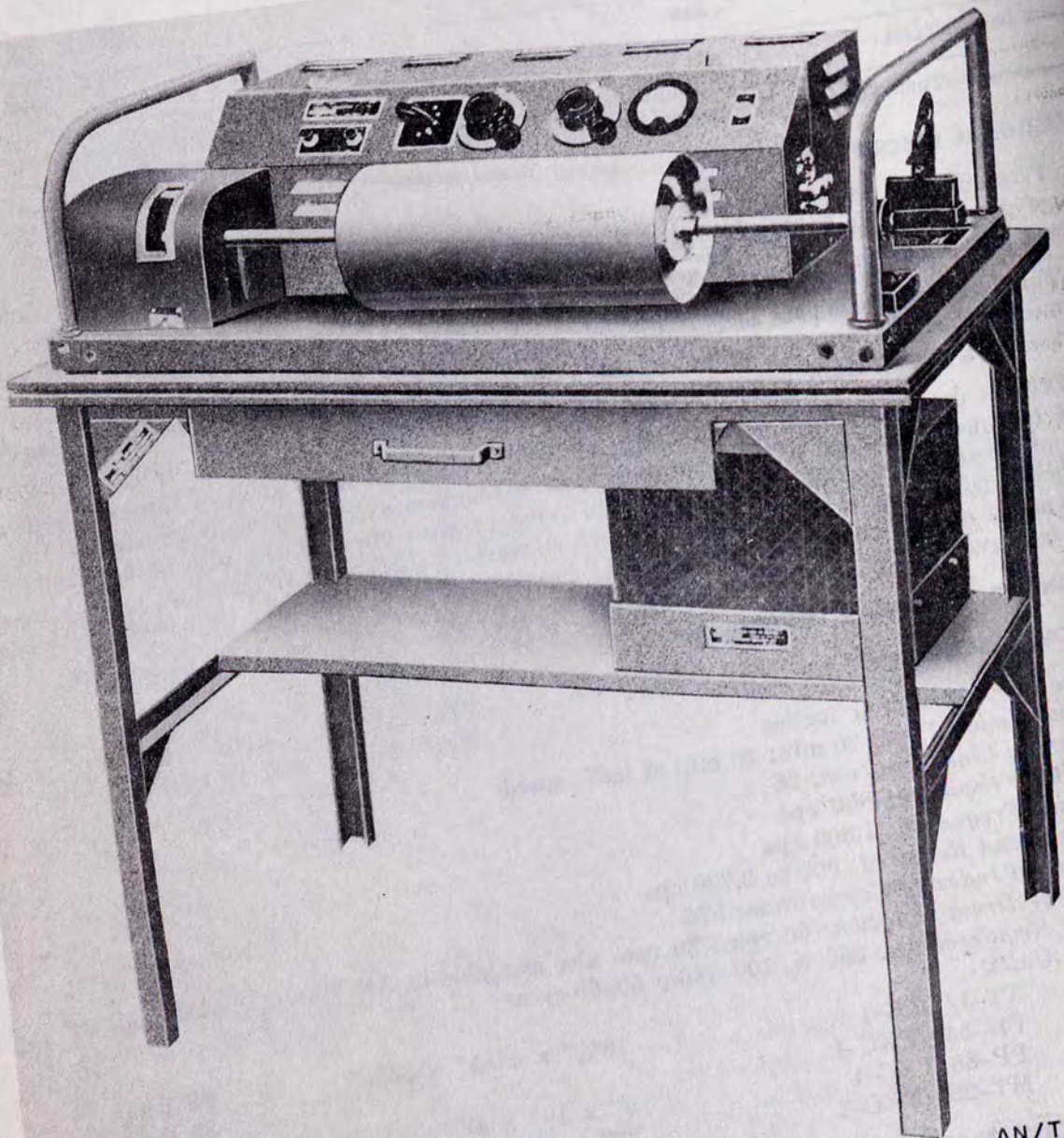

AN/TXC-1

AN/TXC-type
CONVERTER

CV-2/TX, -2A/TX, -2B/TX

1 March 1964

Cog. Serv: USA FSN: CV-2/TX: 5815-243-4494

USA Line Item No.: 611390

	USA	USN	USAF
STATUS OR TYPE CLASS.:	Std-A		L/Std
Manufacturer:	Rudolph Wurlitzer Co		

For illustration see CV-2C/TX, page 717.

FUNCTIONAL DESCRIPTION:

Converters CV-2/TX, CV-2A/TX, and CV-2B/TX are used with facsimile equipments to translate their normal am signal output into fm facsimile signals for use over radio systems, or to reconvert received fm signals into am signals to operate the facsimile receiver. These sets produce only one type of fm signal, ranging from 1,800 to 3,000 cps. They have no provisions for take-off of dc signals for operation of fsk radio transmitters.

RELATIONSHIP TO SIMILAR EQUIPMENT:**TECHNICAL DESCRIPTION:***Type of Signal:* fm to am; am to fm*Signal Frequency:*

am: 1,800 cps

fm: 1,800 to 3,000 cps

Power Requirements: 100-130-v 54-65-cy 1-phase ac; or 5.6-6.3-v dc (unlettered model only)*Major Units:*

1 Converter

9 $\frac{1}{2}$ " x 11 $\frac{1}{16}$ " x 13 $\frac{5}{8}$ "

35 lbs

TUBES, CRYSTALS, TRANSISTORS:**REFERENCE DATA AND LITERATURE:**

TM 11-489

TM 11-2252

(USA) 71-3055

MIL-C-13928

AN/TXC-type
CONVERTER
CV-2C/TX

1 March 1964

Cog. Serv: USA FSN: 5815-503-2598

USA Line Item No.:

	USA	USN	USAF
STATUS OR TYPE CLASS.:	Std-A		Std
Manufacturer:	Wilcox-Gay Corp		

**FUNCTIONAL DESCRIPTION:**

Converter CV-2C/TX is similar to the earlier models, except that provisions have been included for a dc signal output, and a choice of fm signal frequencies is available.

AN/TXC-type
CONVERTER

CV-2C/TX

RELATIONSHIP TO SIMILAR EQUIPMENT:

TECHNICAL DESCRIPTION:

Type of Signal: fm to am; am to fm

Signal Frequency:

am: 1,800 cps

fm: 1,800 to 3,000 cps or 1,500 to 2,300 cps

Power Requirements: 100-130-v 54-65-cy 1-phase ac

Major Units:

1 CV-2C/TX

9½" x 11¼" x 13⅝"

35 lbs

TUBES, CRYSTALS, TRANSISTORS:

REFERENCE DATA AND LITERATURE:

TM 11-489

TM 11-2252A

(USA) 71-3055

MIL-C-13928

AN/TXC-type
FACSIMILE TRANSCEIVER

FX-1, -1A, -1B

1 March 1964

Cog. Serv: USA FSN: FX-1: 5815-401-3794
 FX-1A: 5815-665-3140
 FX-1B: 5815-665-1092

USA Line Item No.: 615552

USA

USN

USAF

STATUS OR TYPE CLASS.: Std-A

Manufacturer: Times Telephoto Equipment, Inc

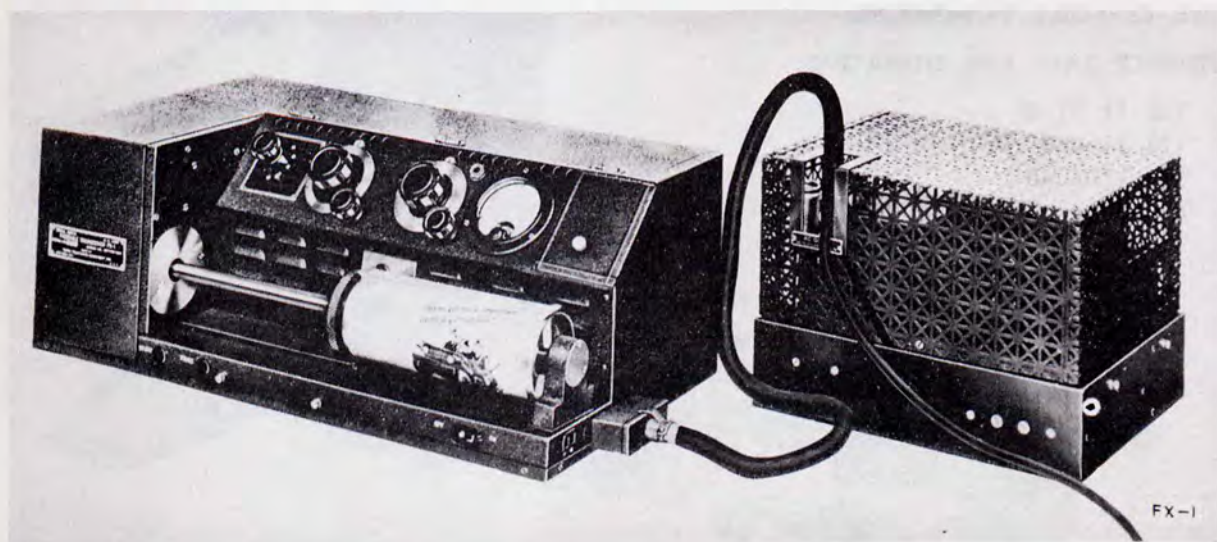
**FUNCTIONAL DESCRIPTION:**

Facsimile Transceivers FX-1, FX-1A, and FX-1B are the basic operating components in corresponding Facsimile Equipments RC-120, RC-120-A, and RC-120-B. With their power supplies and accessories, they provide for the transmission and reception of printed, written, drawn, or photographic copy over regular voice communication channels (radio or wire). Copy 7 by $7\frac{3}{8}$ inches can be transmitted in 7 minutes. The copy can be recorded on material requiring no further processing or on material that must be photographically processed.

Facsimile Transceivers FX-1, FX-1A, and FX-1B become Facsimile Equipment RC-120- () with addition of the following equipment: one Power Supply PE-140, PE-140-A, PE-140-B, or PE-150; one Photographic Equipment PH-411; one Chest CH-117; one Chest CH-116; one Bag BG-124.

RELATIONSHIP TO SIMILAR EQUIPMENT:**TECHNICAL DESCRIPTION:**

Keying Frequency: 900 cps
Carrier Frequency: 1,800 cps

**AN/TXC-type
FACSIMILE TRANSCEIVER**

FX-1, -1A, -1B

Signal Band Required: 900 to 2,700 cps

Page Size: 7" x 8⁵/₈"

Transmission Time: 7.5 min

Scanning Lines per Inch: 96

Allowable Delay Distortion: $\pm 278 \mu\text{sec}$

Diametral Index of Cooperation: 264

Speed of Drum Rotation: 90 strokes per minute

Power Requirements: 250 w, 100-130-v 50-60-cy 1-phase ac; or 25 amp at 6-v dc

Major Unit:

1 FX-1, 1A, or 1B

10" x 12" x 22"

60 lbs

TUBES, CRYSTALS, TRANSISTORS:

REFERENCE DATA AND LITERATURE:

TM 11-375B

TM 11-489

TM 11-4038

71-1679

AN/TXC-type
FACSIMILE EQUIPMENT

RC-120-()

1 March 1964

Cog. Serv: USA FSN: 5815-164-7106

USA Line Item No.: 615530

USA

USN

USAF

STATUS OR TYPE CLASS.:

Std-A

Manufacturer:

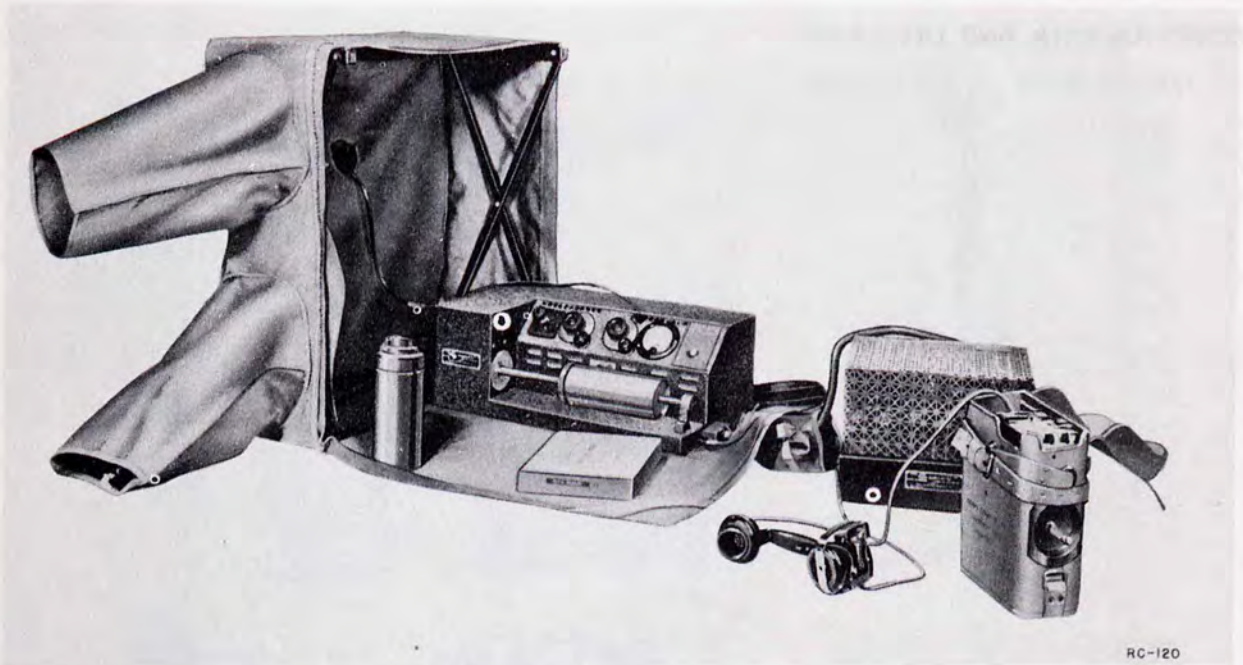
**FUNCTIONAL DESCRIPTION:**

Facsimile Equipment RC-120-() is a transmitting and receiving set used for communicating graphic copy. It will receive positive and negative photographs, printed or written copy, and similar material on film or direct special papers. It is used in fixed or field stations.

This equipment consists of a receiver-transmitter unit, power supply, and associated accessories. A portable darkroom tent is included for field use.

RELATIONSHIP TO SIMILAR EQUIPMENT:**TECHNICAL DESCRIPTION:**

Maximum Page Size: 7" x 8⁵/₈"

Transmission Time: 7 min

Drum Speed: 90 rpm

Diametral Index of Cooperation: 264

**AN/TXC-type
FACSIMILE EQUIPMENT**

RC-120-()

Scanning Lines Per Inch: 96

Carrier Frequency: 1,800 cps

Power Requirements: 100-130-v 50-60-cy ac

Major Units:

1	FX-1-()	22" x 12" x 10"	60 lbs
1	PH-411		
1	PE-140-()	10" x 12" x 12"	50 lbs
1	PE-150	8 ³ / ₄ " x 11" x 14"	60 lbs

TUBES, CRYSTALS, TRANSISTORS:

REFERENCE DATA AND LITERATURE:

TM 11-375B

AN/TXR-type
FACSIMILE RECORDER
RD-92A/UX

1 March 1964

Cog. Serv: USN FSN: 5815-665-3146

USA Line Item No.:

USA

USN

USAF

STATUS OR TYPE CLASS.:

Std

Manufacturer: Times Facsimile Corp

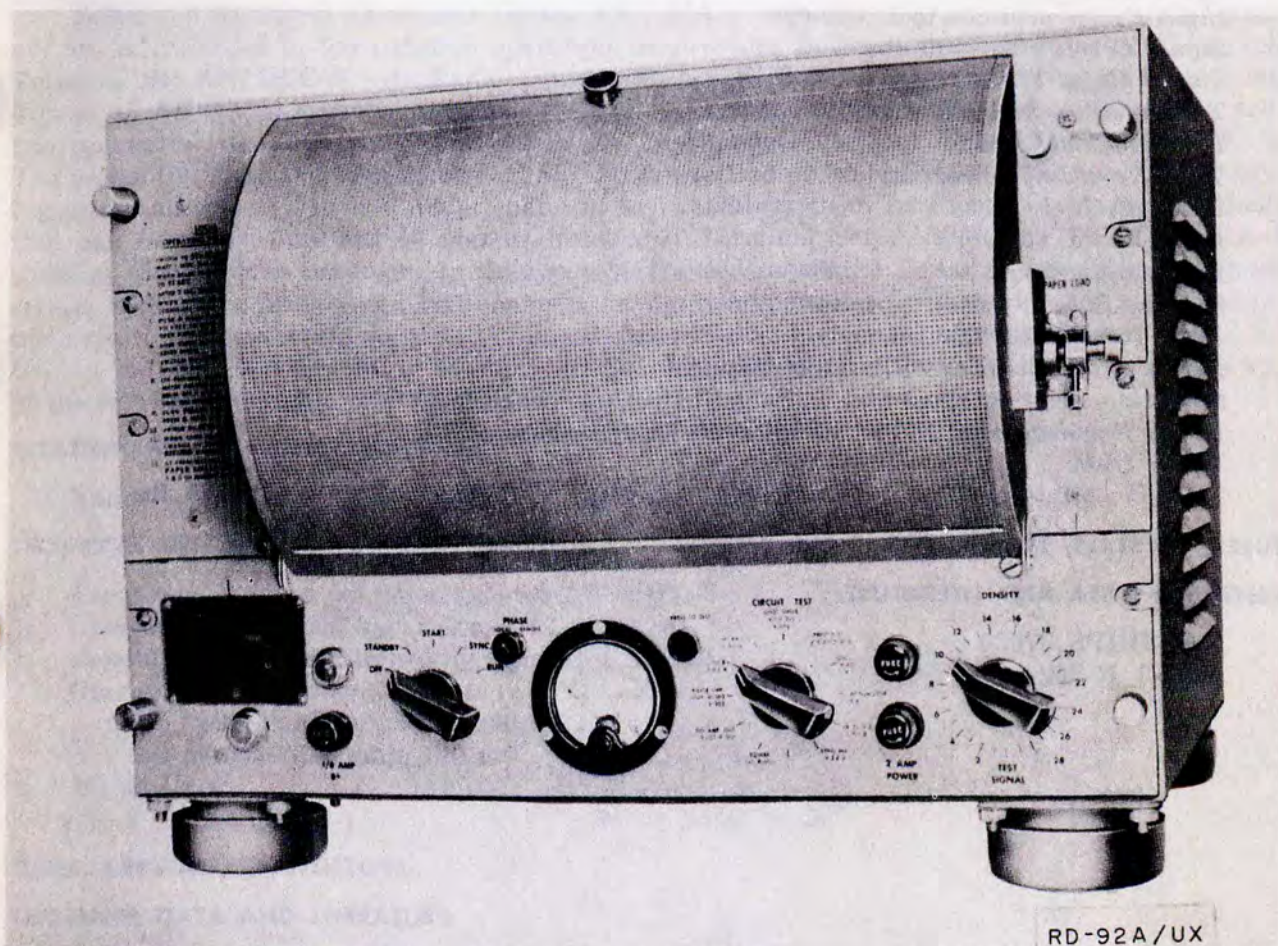
**FUNCTIONAL DESCRIPTION:**

Facsimile Recorder RD-92A/UX is similar to the unlettered model, the major difference being in the required input impedance. This equipment makes direct recordings of copy transmitted by Facsimile Set AN/TXC-1 or its equivalent. The recorded image may be pictures, maps, sketches, typewritten or printed text, or handwriting. When used with wire lines, the recorder is

**AN/TRX-type
FACSIMILE RECORDER**

RD-92A/UX

connected directly to the line. Or it may be connected to an am receiver, provided that the received facsimile signal is am. Other types of modulation must be converted to am facsimile signal by use of Frequency Shift Converter CV-172/U or converter CV-2()/TX.

It is a self-contained unit which may be mounted on a standard 19-inch relay rack. The rack may be equipped with shock mounts for bench use or with rollers to permit use as a file drawer.

RELATIONSHIP TO SIMILAR EQUIPMENT:

TECHNICAL DESCRIPTION:

Type: rotating drum

Input Frequency: 500 to 10,000 cps

Signal Level: 9 to -40 dbm

Size of Copy: 12" x 18³/₄"

Transmission Time: 20 min

Type Modulation: am

Type Recording: direct stylus

Lines per Inch: 96

Drum Speed: 60 rpm

Drum Diameter: 6"

Phasing Signal: pulses, 1 per sec

Input Impedance: 2,000 ohms

Index of Cooperation: 576 (International Index)

Mounting: self-contained unit, suitable for rack or bench mounting

Power Requirements: 150 w, 90-130-v 55-65-cy 1-phase ac

Major Unit:

1 RD-92A/UX

14" x 19¹/₈" x 17²/₃₂"

75 lbs

TUBES, CRYSTALS, TRANSISTORS:

REFERENCE DATA AND LITERATURE:

NAVSHIPS 91630
(USN) F-262

TELEGRAPH TERMINAL TRANSLATOR GROUP

AN/UGA-1

1 March 1964

Cog. Serv: USN F5N:

USA Line Item No.:

USA

USN

USAF

USMC

STATUS OR TYPE CLASS.:

Manufacturer: CTT (59433)

FUNCTIONAL DESCRIPTION:

Telegraph Terminal Translator Group AN/UGA-1 is for specific use with Telegraph Terminal Set AN/UGC-3 in fixed station operation. It provides facilities for operation of Telegraph Terminal Set AN/UGC-3 with Radio Equipment AN/FCC-29. The transmitting and receiving groups of AN/UGA-1 perform complementary functions. The transmitting group accepts a neutral sequential signal such as provided by the 16-channel Telegraph Terminal Set AN/UGC-3. The sequential signal is then converted and retransmitted on 16 individual channels. The receiving group accepts the 16 individual channels and combines them into neutral sequential signals that can be utilized by the 16-channel Telegraph Terminal Set AN/UGC-3. The AN/UGA-1 contains the facilities necessary to change a high speed sequential signal into multiple low speed signals that can be transmitted over conventional radio-teletypewriter facilities, in addition to receiving circuits for converting multiple low speed signals into a high speed sequential signal. The AN/UGA-1 is transistorized. Siting of the AN/UGA-1 should be near the AN/UGC-3 to permit use of the test equipment built in the AN/UGC-3.

RELATIONSHIP TO SIMILAR EQUIPMENT:

None

TECHNICAL DESCRIPTION:

Frequency Control: by the associated AN/UGC-3*Operation:* start-stop apparatus, 7.42 unit code*Repetition Rate:* determined by associated AN/UGC-3*Operating Power Requirements:*115 volts, ± 10 percent, 50/60 cy ± 5 percent, 1.6 amp, 140 w*Major Unit:*

1 AN/UGA-1

84" x 23 $\frac{3}{8}$ " x 24"

550 lbs

TUBES, CRYSTALS, TRANSISTORS:

REFERENCE DATA AND LITERATURE:

Manuscript of Preliminary Instruction Manual

TELEGRAPH TERMINAL TRANSLATOR GROUP

AN/UGA-1

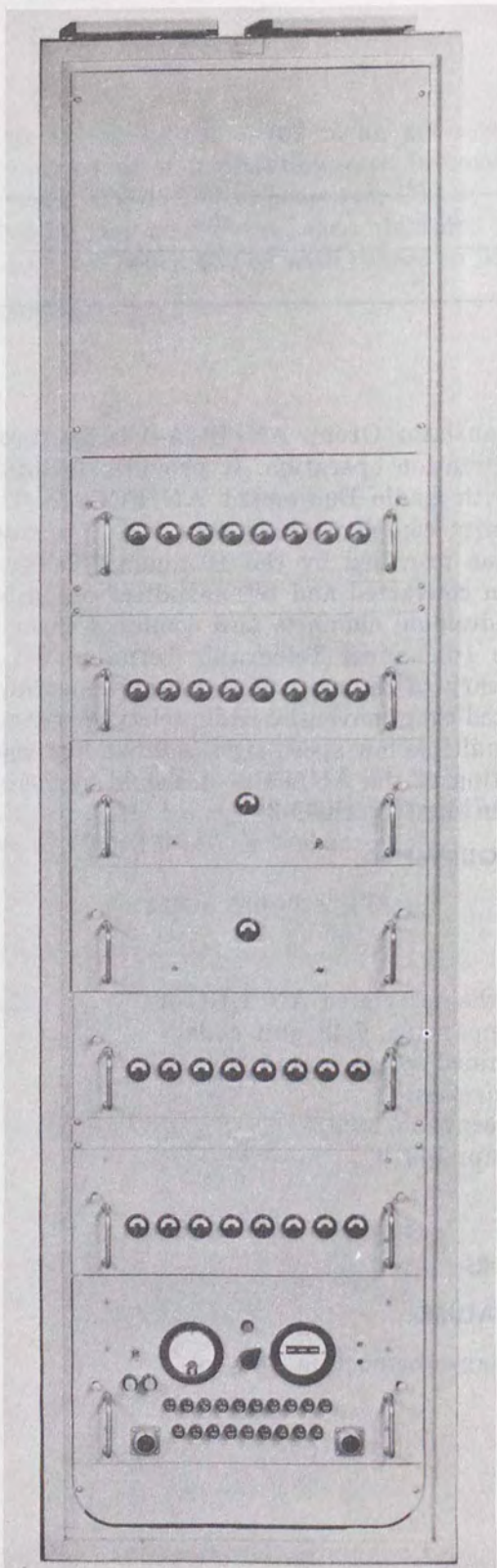

TELEGRAPH TERMINAL SET

AN/UGC-3

1 March 1964

Cog. Serv: USN FSN:

USA Line Item No.:

USA

USN

USAF

USMC

STATUS OR TYPE CLASS.:

Manufacturer: CTT (59433)

FUNCTIONAL DESCRIPTION:

Telegraph Terminal Set AN/UGC-3 is a transistorized, 16-channel, time division, multiplex equipment for fixed station installation. A complete set consists of a transmitting and receiving group. The transmitting group accepts neutral, start-stop signals from up to 16 separate circuits and assembles them in sequential order for multiplex signals from a distant source, converts them to start-stop form, and distributes them to 16 separate circuits. Signals are received from a number of start-stop teletypewriter circuits, stored, and transmitted over the common channel. In this process, the message characters from the start-stop circuits are compressed in time so that a character from each of these circuits is transmitted in the time normally required to send one character from a single circuit. The receiving multiplex terminal sorts the compressed signals into their respective circuits and regenerates them into normal length start-stop characters. Adjacent siting of the receiver and transmitter groups permits use of the built-in test equipment in both.

RELATIONSHIP TO SIMILAR EQUIPMENT:

In four channel operation, the multiplex signals of the AN/UGC-3 are completely compatible with those of AN/UGC-1 at all speeds and with the AN/FGC-5 at 60 and 75 words per minute. Any standard apparatus using a 7.42 unit code may be employed in the start-stop circuits. All start-stop equipment must have the same operating speeds of 60, 75, or 100 words per minute. The AN/UGC-3 is used with the AN/UGA-1.

TECHNICAL DESCRIPTION:

Repetition Rate: 60 wpm-440 pps, 74 wpm-562.5 pps, 100 wpm-733.69 pps

Frequency Control: temperature controlled crystal oscillator

Number of Channels: 4, 8, 12, or 16

Operating Power Requirements:

115 v \pm 10 percent, 50/60 cy

\pm 1 cy, single phase, 4 am, 361w

Major Unit:

1 OA-2994/UGC-3

84" x 23 $\frac{3}{8}$ " x 24"

556 lbs

1 OA-2995/UGC-3

84" x 23 $\frac{3}{8}$ " x 24"

601 lbs

TUBES, CRYSTALS, TRANSISTORS:

REFERENCE DATA AND LITERATURE:

Manuscript of Preliminary Instruction Book (Teletypewriter Bulletin 265B)

TELEGRAPH TERMINAL SET

AN/UGC-3

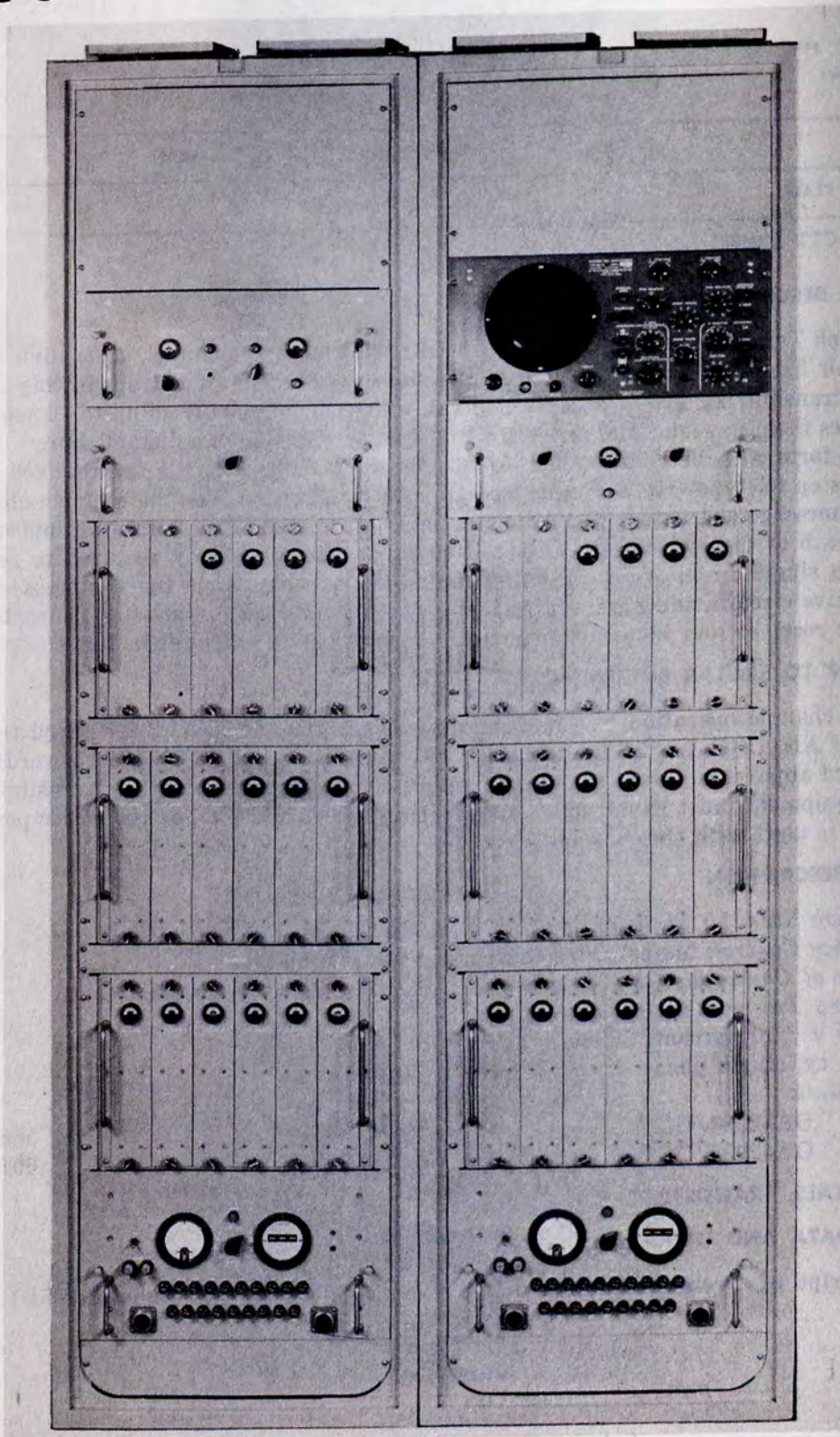

AN/UGC-type
AUDIO FREQUENCY AMPLIFIER

AM-2731/UGC

1 March 1964

Cog. Serv: USN FSN:

USA Line Item No.:

USA

USN

USAF

USMC

STATUS OR TYPE CLASS.:

Std-A

Std

Manufacturer: Tele-Signal Corporation

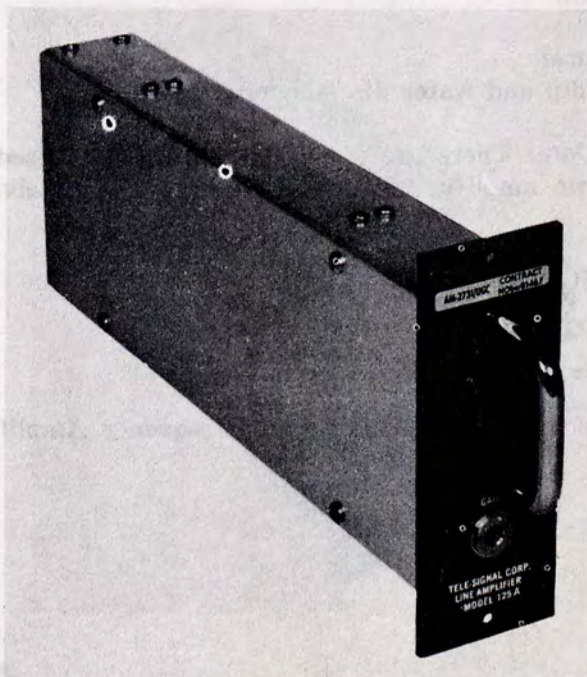
**FUNCTIONAL DESCRIPTION:**

Audio Frequency Amplifier AM-2731/UGC is a transistorized push-pull amplifier capable of delivering +20 dbm, which is used as an input line amplifier in Telegraph Terminal AN/FGC-60(V).

RELATIONSHIP TO SIMILAR EQUIPMENT:

None

TECHNICAL DESCRIPTION:*Amplification Data:*

Nominal power output: +4 dbm

Minimum voltage gain: 36 db

Operating Power Requirements: -15 v dc

AN/UGC-type

AUDIO FREQUENCY AMPLIFIER

AM-2731/UGC

Frequency Response:

Normal operating range: 300 to 10,000 cps.

Variation in output over operating range: ± 2 db

Input Channel Data: quantity—16 channels supplied by frequency shift keyers or the output from a radio receiver or wire link.

Input Impedance: 600 ohms

Output Impedance: 600 ohms

Installation: mounted on Tele-Signal Model 139, Equipment Shelf, which fits directly into standard 19" rack.

Construction: aluminum

Finish:

Front panel—enamel

Chassis—caustic dip and water dip lacquer spray

Heat Dissipation: $\frac{3}{4}$

Specific Application Data: There are three audio amplifiers used in Telegraph Terminal AN/FGC-60(V); two amplify the input from two radio receivers and the third is used as a spare.

Major Unit:

1 AM-2731/UGC

5 $\frac{1}{4}$ " x 2" x 11"

1 $\frac{1}{4}$ lbs

TUBES, CRYSTALS, TRANSISTORS:

REFERENCE DATA AND LITERATURE:

NAVSHIPS 93854, Technical Manual for Audio Frequency Amplifier AM-2731/UGC

AN/UGC-type
 SIGNAL COMPARATOR
CM-185/UGC

15 March 1962

Cog. Serv: USN FSN:

USA Line Item No.:

	USA	USN	USAF	USMC
STATUS OR TYPE CLASS.:	Std-A	Std		
Manufacturer:	Tele-Signal Corp			

**FUNCTIONAL DESCRIPTION:**

Signal Comparator CM-185/UGC is used in a dual diversity system Telegraph Terminal AN/FGC-60(V). It compares the signal outputs of two frequency shift converters and then returns the signal which exhibits the better signal-to-noise ratio to one of the frequency shift converters for final shaping to drive the output load.

It is intended for use on frequency shift circuits where the additional reliability of receiver diversity is required, such as long distance hf circuits and scatter communication links.

The signal comparator may be used with any of the conventional diversity methods such as frequency, space, or polarization diversity. The two diversity channels may operate either on the same or at different frequencies.

RELATIONSHIP TO SIMILAR EQUIPMENT:**TECHNICAL DESCRIPTION:**

Frequency Range: 0 to 100 dot-cps

Type of Indicator: meter

**AN/UGC-type
SIGNAL COMPARATOR**

CM-185/UGC

External Controls: dc Balance, Gain Balance, Sense Switch, Channel A input, Channel B input

Operating Power Requirements: dc, 8v

Impedance Data: 10,000 ohms input, 10,000 ohms output

Installation: Installed by plugging into Tele-Signal Model 139 Equipment Shelf, which mounts directly into standard 19-inch rack. A shelf accepts four comparators.

Construction: aluminum

Finish:

Front panel—enamel

Chassis—caustic dip and water dip lacquer spray

Head Dissipation: approximately 1/4 w

Major Units:

1 CM-185/UGC

5 1/4" x 4" x 11"

4 lbs

TUBES, CRYSTALS, TRANSISTORS:

REFERENCE DATA AND LITERATURE:

NAVSHIPS 93849

AN/UGC-type
 FREQUENCY SHIFT CONVERTER
CV-972(P)/UGC

15 March 1962

Cog. Serv: USN FSN:

USA Line Item No.:

	USA	USN	USAF	USMC
STATUS OR TYPE CLASS.:	Std-A	Std		

Manufacturer: Tele-Signal Corp

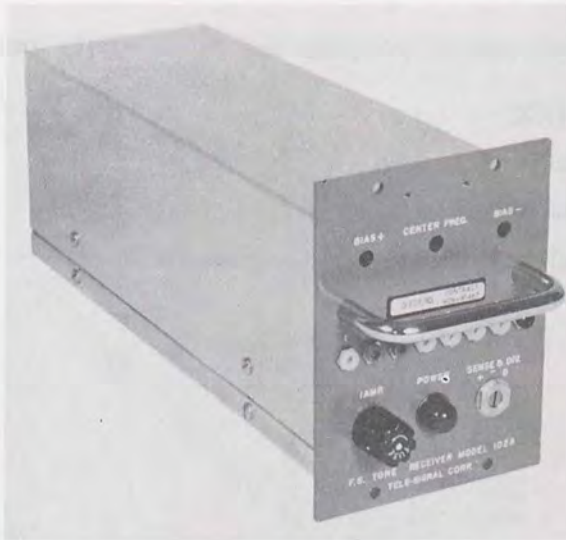
**FUNCTIONAL DESCRIPTION:**

Frequency Shift Converter CV-972(P)/UGC is used on communication circuits such as tone telegraph systems, telemetering circuits, and single side band radio links. In these applications, it accepts frequency shifted signals in the audio spectrum from the receiving terminal and demodulates them with great precision, converting them into a digital code (e.g. teletypewriter).

It can be paralleled with other such converters on the same audio circuit, resulting in a multi-channel frequency shift tone system.

The converter is a completely transistorized unit, including a self-contained power supply and monitoring facilities. It has provision for operation in conjunction with a dual diversity comparator.

RELATIONSHIP TO SIMILAR EQUIPMENT:**TECHNICAL DESCRIPTION:***Frequency Data:*

Frequency Range—425 to 2,975 cps, special frequencies on request

Quantity—16 channels

Operating Power Requirements: 115v, 50/60 cps, single phase, can be strapped for 230 v

**AN/UGC-type
FREQUENCY SHIFT CONVERTER**

CV-972(P)/UGC

Impedance Data:

Input—600 ohms balanced

Output—Less than 200 ohms

Installation: Mounting frame for standard 19" rack opening. Frame will accept up to 4 converters. For less than 4, blank masking panels supplied.

Construction: aluminum

Finish:

Front panel—enamel

Chassis—caustic dip and water dip lacquer spray

Heat Dissipation: 1 w

Special Features: sensing switch, self-contained power supply and diversity capabilities.

Major Units:

CV-972(P)/UGC

5¼" x 4" x 11"

5½ lbs

TUBES, CRYSTALS, TRANSISTORS:

REFERENCE DATA AND LITERATURE:

NAVSHIPS 93847, Technical Manual for Frequency Shift Converter CV-972(P)/UGC

AN/UGC-type
 FREQUENCY SHIFT CONVERTER
KY-346(P)/UGC

15 March 1962

Cog. Serv: USN FSN:

USA Line Item No.:

	USA	USN	USAF	USMC
STATUS OR TYPE CLASS.:	Std-A	Std		

Manufacturer: Tele-Signal Corp

**FUNCTIONAL DESCRIPTION:**

Frequency Shift Keyer KY-346(P)/UGC is used in communication circuits such as telegraph systems, telemetering circuits, and single sideband radio links. In these applications, it provides the transmitting terminal with frequency shifted signals in the audio spectrum. This unit operates by accepting a digital code from an external source (e.g. teletypewriter) and converting it into two-tone frequencies. One frequency will indicate mark bits while the other will indicate space bits.

It can be paralleled with other such keyers on the same audio circuit, resulting in a multi-channel frequency shift tone system.

This keyer is a completely transistorized unit, including internal power supply and monitoring facilities, which are front panel accessible.

RELATIONSHIP TO SIMILAR EQUIPMENT:**TECHNICAL DESCRIPTION:***Type of Emission:* fsk*Power Output (max):* +3 dbm

AN/UGC-type
FREQUENCY SHIFT KEYS

KY-346(P)/UGC

Frequency Deviation: +42.5 cy; special deviations on request

Frequency Data:

Frequency Range—425 to 2975 cps; special frequencies on request.

Quantity of Channels—16 channels normal; additional channels on request

Operating Power Requirements: 115v, 50/60 cps, single phase, can be strapped for 230 v

Installation: Installed by plugging into Tele-Signal Model 139 Equipment Shelf, which mounts directly into standard 19" mounting rack. This shelf will accept up to 4 keyers.

Construction: aluminum

Finish:

Front Panel—enamel

Chassis—caustic dip and water dip lacquer spray

Heat Dissipation: 1 w

Special Features: Self contained power supply; mark and space frequency self-test.

Major Units:

1 KV-346(P)/UGC

5¼" x 4" x 11"

5½ lbs

TUBES, CRYSTALS, TRANSISTORS:

REFERENCE DATA AND LITERATURE:

NAVSHIPS 93846

AN/UGC-type
POWER SUPPLY

PP-2713/UGC

15 March 1962

Cog. Serv: USN FSN:

USA Line Item No.:

	USA	USN	USAF	USMC
STATUS OR TYPE CLASS.:	Std-A	Std		

Manufacturer: Tele-Signal Corp

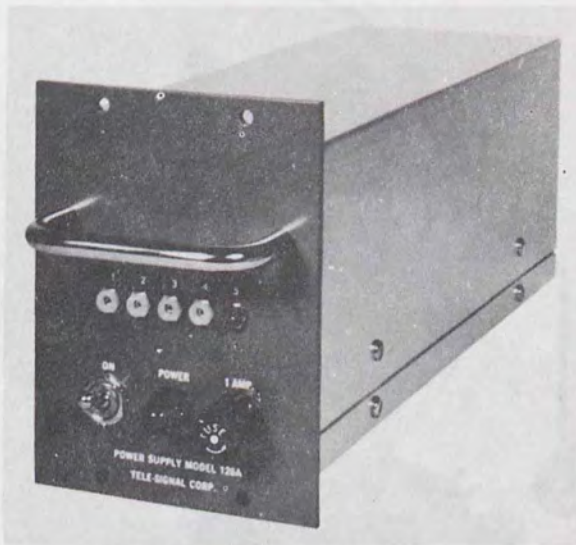
**FUNCTIONAL DESCRIPTION:**

Power Supply PP-2713/UGC provides the dc voltage required for three Audio Frequency Amplifiers AM-2731/UGC and Meter Panel SB-1178/UGC in Telegraph Terminal AN/FGC-60 (V). It employs a bridge type rectifier circuit and a filter circuit.

RELATIONSHIP TO SIMILAR EQUIPMENT:**TECHNICAL DESCRIPTION:**

Rectification Data: electronic type, full wave rectification

Output Data: dc, -15 v, 300 ma

Operating Power Requirements: 115/230 v, 50/60 cps, single phase; 3 w

Major Units:

1 PP-2713/UGC

5 $\frac{1}{4}$ " x 4" x 11"4 $\frac{9}{16}$ lbs**TUBES, CRYSTALS, TRANSISTORS:****REFERENCE DATA AND LITERATURE:**

NAVSHIPS 93855

TOP SECRET
SECRET

1. Introduction
2. Objectives
3. Scope
4. Methodology
5. Results
6. Discussion
7. Conclusions
8. References
9. Appendixes
10. Glossary
11. Bibliography



12. Acknowledgments
13. Distribution Statement
14. Security Classification

15. Summary
16. Executive Summary
17. Abstract
18. Introduction
19. Objectives
20. Scope
21. Methodology
22. Results
23. Discussion
24. Conclusions
25. References
26. Appendixes
27. Glossary
28. Bibliography

29. Distribution Statement
30. Security Classification
31. Summary
32. Executive Summary
33. Abstract
34. Introduction
35. Objectives
36. Scope
37. Methodology
38. Results
39. Discussion
40. Conclusions
41. References
42. Appendixes
43. Glossary
44. Bibliography

AN/UGC-type
RECORDING TAPE REWINDER

RL-177A/UG

15 March 1962

Cog. Serv: USN FSN:

USA Line Item No.:

USA

USN

USAF

USMC

STATUS OR TYPE CLASS.:

Manufacturer: CCBF (92239)

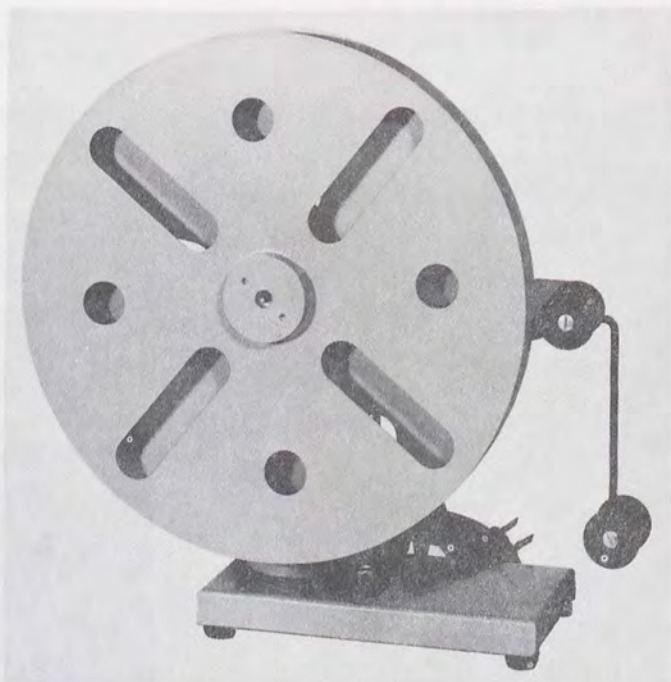
**FUNCTIONAL DESCRIPTION:**

Recording Tape Rewinder RL-177A/UG is a device for rewinding and storing recorded tape. It consists of a geared drive motor and a direct shaft extension that mounts a pair of 12-inch reels. The inner reel mounts permanently on the shaft by means of set screws. The outer reel, which also includes a hub, is threaded to allow its removal when required. The hub on the outer reel extends on both sides of the reel face, so that by mounting the reel in its reversed position, tapes of different widths may be accommodated.

Tape snubbing action is provided by means of two neoprene guides which reduce tape winding pull to one-half ounce at the input.

RELATIONSHIP TO SIMILAR EQUIPMENT:**TECHNICAL DESCRIPTION:**

Operating Power Requirements: 115 v ac, 60 cps, 1 phase; 0.2 amp

Heat Dissipation: 25 w

RECORDING TAPE REWINDER

RL-177A/UG

Winding Direction: counterclockwise

Major Units:

1 RL-177A/UG

14" x 14" x 6"

12 lbs

TUBES, CRYSTALS, TRANSISTORS:

REFERENCE DATA AND LITERATURE:

Technical Manual for Recording Tape Rewinder, NAVSHIPS 94126

AN/UGC-type
TELEGRAPH CODE TAPE RECORDER

RO-135/FRR

15 March 1962

Cog. Serv: USN FSN:

USA Line Item No.:

USA

USN

USAF

USMC

STATUS OR TYPE CLASS.:

Manufacturer:

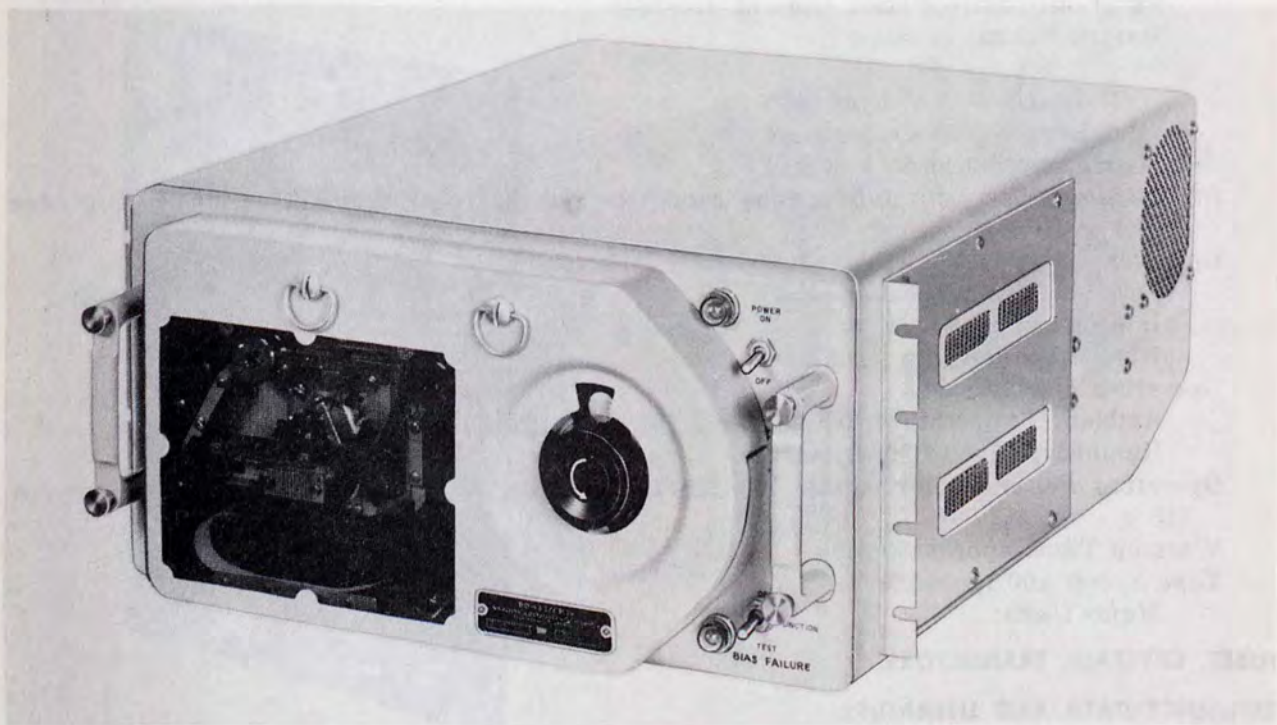
**FUNCTIONAL DESCRIPTION:**

Telegraph Code Tape Recorder RO-135/FRR provides a means of converting the on-off periods of six separate trains of dc pulses, (five information pulse trains, one rog pulse train) to 10-kc envelope-type pulses, and recording each on a separate track on a single, narrow, dry-type electrosensitive paper tape. The recorder contains a tape drive mechanism for moving the tape, and electronic circuits to control tape motion and writing. Writing on the tape is accomplished by passing the tape under styli which are fixed in position. Accordingly, the information recorded is in the form of short dashes burned on the upper surface of the tape.

AN/UGC-type
TELEGRAPH CODE TAPE RECORDER

RO-135/FRR

RELATIONSHIP TO SIMILAR EQUIPMENT:

TECHNICAL DESCRIPTION:

Inputs:

Information Signals:

Pulse Repetition Rate: 0 to 200 pps

Pulse Duration: 200 μ sec to 4.7 ms

"Off" Level: +70 v dc or less

"On" Level: +135 v dc or more

Source Impedance: 33 k or less

Positive Signal Gate:

Function: controls start time of recorder

Duration: 5 ms or more

Shape: rectangular

"Off" Level: +70 v dc or less

"On" Level: +135 v dc or more

Source Impedance: 33 k or less

Information Time Lag: Information cannot be recorded until 5 ms after the leading edge of the positive signal gate

Outputs:

Level: 850 v ac peak-to-peak

Impedance: 10 k

Number: 6 marking signals

Operating Limitations:

Ambient Temperature: 0°C to 50°C (33°F to 122°F)

Humidity: 40% to 90 % relative

Operating Power Requirements: 105/115/125 v \pm 10%, 60 cps \pm 5%, 1 phase 3.8 amp at 115 v

Warmup Time: approx 30 sec

Tape Speed: 100 ips \pm 1%

Major Units:

TUBES, CRYSTALS, TRANSISTORS:

REFERENCE DATA AND LITERATURE:

NAVSHIPS 94312

FREQUENCY SHIFT KEYER
ELECTRONIC SWITCH
SA-733/UGC

15 March 1962
Cog. Serv: USN FSN:
USA Line Item No.:

USA

USN

USAF

USMC

STATUS OR TYPE CLASS.:

Std

Manufacturer: Tele-Signal Corp

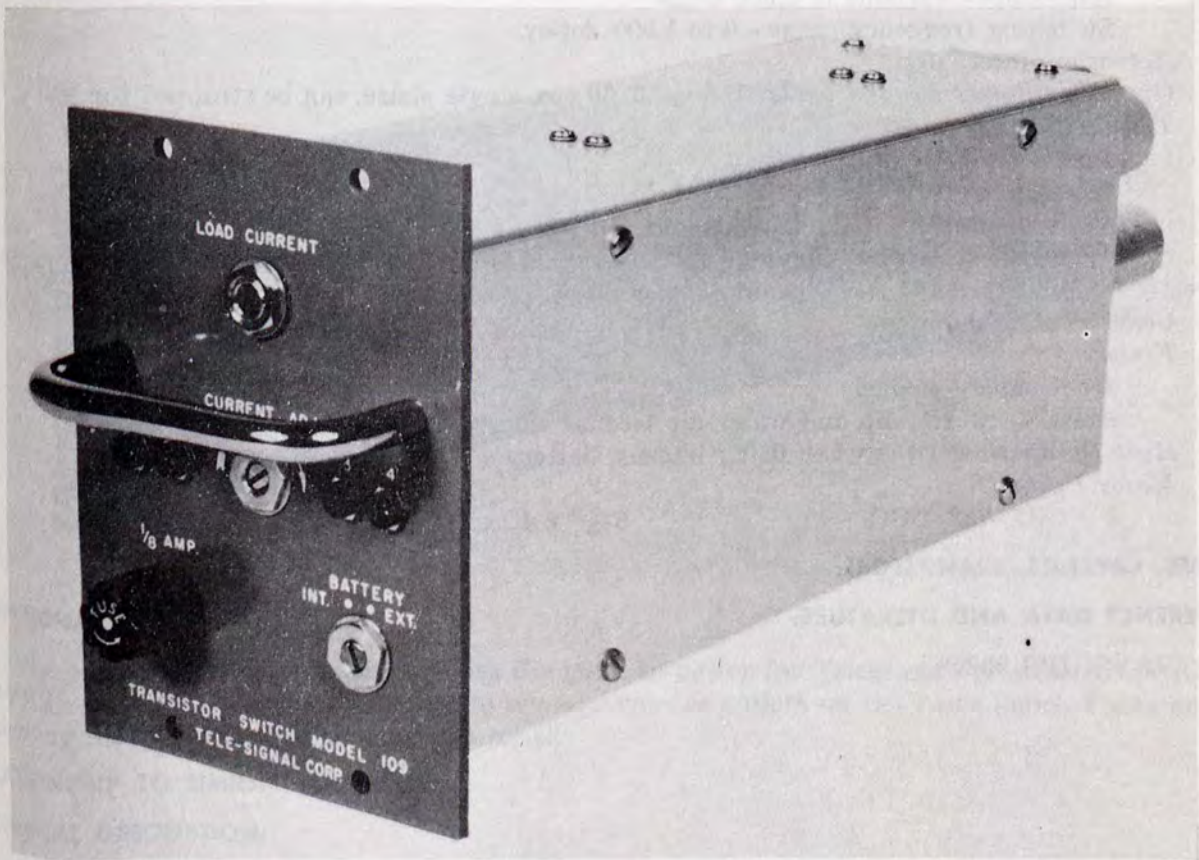
**FUNCTIONAL DESCRIPTION:**

Electronic Switch SA-733/UGC isolates the output of a frequency shift converter from receive terminal equipment (e.g. teletypewriter). The switch accepts a signal from the converter and controls the ON-OFF condition of a transistor. It is capable of accepting signals of over 2000 bits per second.

It is used where complete isolation is required, such as is normally provide by an electro-mechanical relay, but where there are objections to the use of such a relay because of speed limitations or maintenance requirements and where it is necessary to operate into lines equipped with 120 v line batteries.

AN/UGC-type
ELECTRONIC SWITCH

SA-733/UGC

In addition, a self contained line battery is provided, which may or may not be utilized. This unit is completely protected against accidental faulty connections in the output circuit.

RELATIONSHIP TO SIMILAR EQUIPMENT:

TECHNICAL DESCRIPTION:

Output Circuit: single ended

Input Data: 2500 ohms impedance, 0 to 1,000 dot-cps

Output Data:

Impedance—variable to 2,500 ohms

Switching frequency range—0 to 1,000 dot-cy

Actuation: internally

Operating Power Requirements: 115 v, 50/60 cps, single phase, can be strapped for 230 v.

Terminal Data:

quantity—1

type—plug

location—located at the back of unit

Installation: Installed by plugging into Tele-Signal Model 139 Equipment Shelf, which mounts directly into standard 19" rack opening.

Construction: aluminum

Finish:

front panel—enamel

chassis—caustic dip and water dip lacquer spray

Heat Dissipation: 20 w when using internal battery.

Major Units:

1 SA-733/UGC

5¼" x 4" x 11"

1½ lbs

TUBES, CRYSTALS, TRANSISTORS:

REFERENCE DATA AND LITERATURE:

NAVSHIPS 93848

AN/UGC-type
POWER DISTRIBUTION PANEL

SB-1177/UGC

15 March 1962

Cog. Serv: USN FSN:

USA Line Item No.:

	USA	USN	USAF	USMC
STATUS OR TYPE CLASS.:	Std-A	Std		

Manufacturer: Tele-Signal Corp

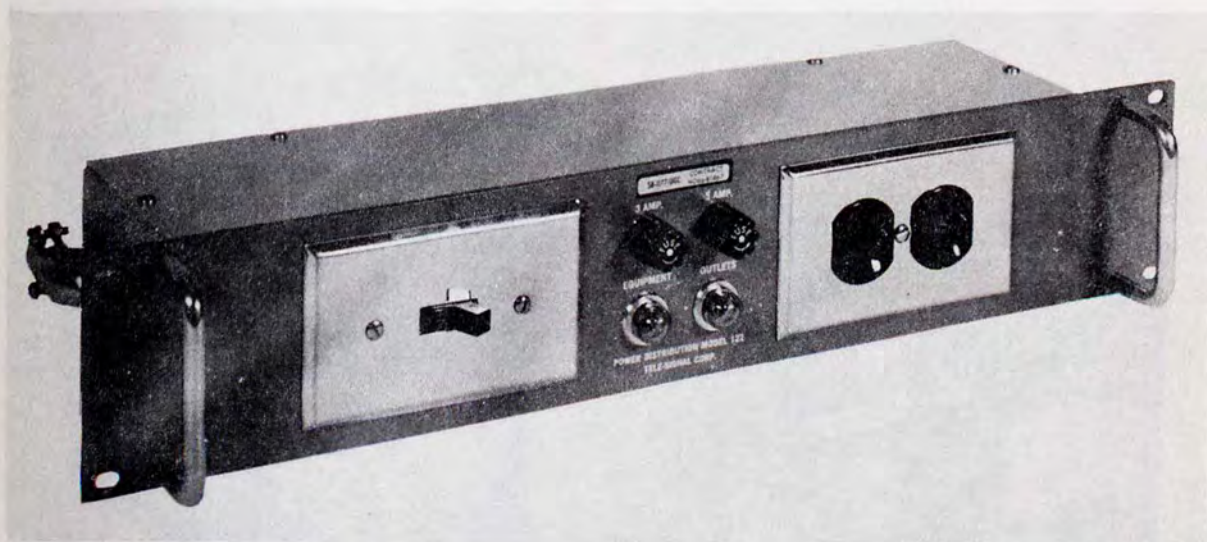
**FUNCTIONAL DESCRIPTION:**

The power distribution panel supplies the main ac power for Telegraph Terminal AN/FGC-60(V). In addition, it supplies as power to two convenience outlets on the front panel. Fuses and indicating lights are located on the front panel.

RELATIONSHIP TO SIMILAR EQUIPMENT:**TECHNICAL DESCRIPTION:**

Input Data: 115/230 v ac, 8 amp, 50/60 cps, single phase

Output Data: Two outputs: 115/230 v ac, 3 amp, 50/60 cps, single phase
115/230 v ac, 5 amp, 50/60 cps, single phase

Major Units:

1 SB-1177/UGC

3½" x 19" x 5"

3¼ lbs

TUBES, CRYSTALS, TRANSISTORS:**REFERENCE DATA AND LITERATURE:**

NAVSHIPS 93852

UNITED STATES DEPARTMENT OF THE INTERIOR
BUREAU OF RECLAMATION

POWER DIVISION

52-177-100

DATE OF REPORT: 1952
PROJECT: ...

NO.	DESCRIPTION	AMOUNT
1
2

DESCRIPTION OF WORK
The work under this item was to install and test the ...
The power supply unit was installed in the ...
The output of the unit was tested and found to be ...

REMARKS
The work was completed on ...

POWER DIVISION
BUREAU OF RECLAMATION

52-177-100
1952

AN/UGC-type
METER PANEL

SB-1178/UGC

15 March 1962

Cog. Serv: USN FSN:

USA Line Item No.:

USA

USN

USAF

USMC

STATUS OR TYPE CLASS.:

Std-A

Std

Manufacturer: Tele-Signal Corp

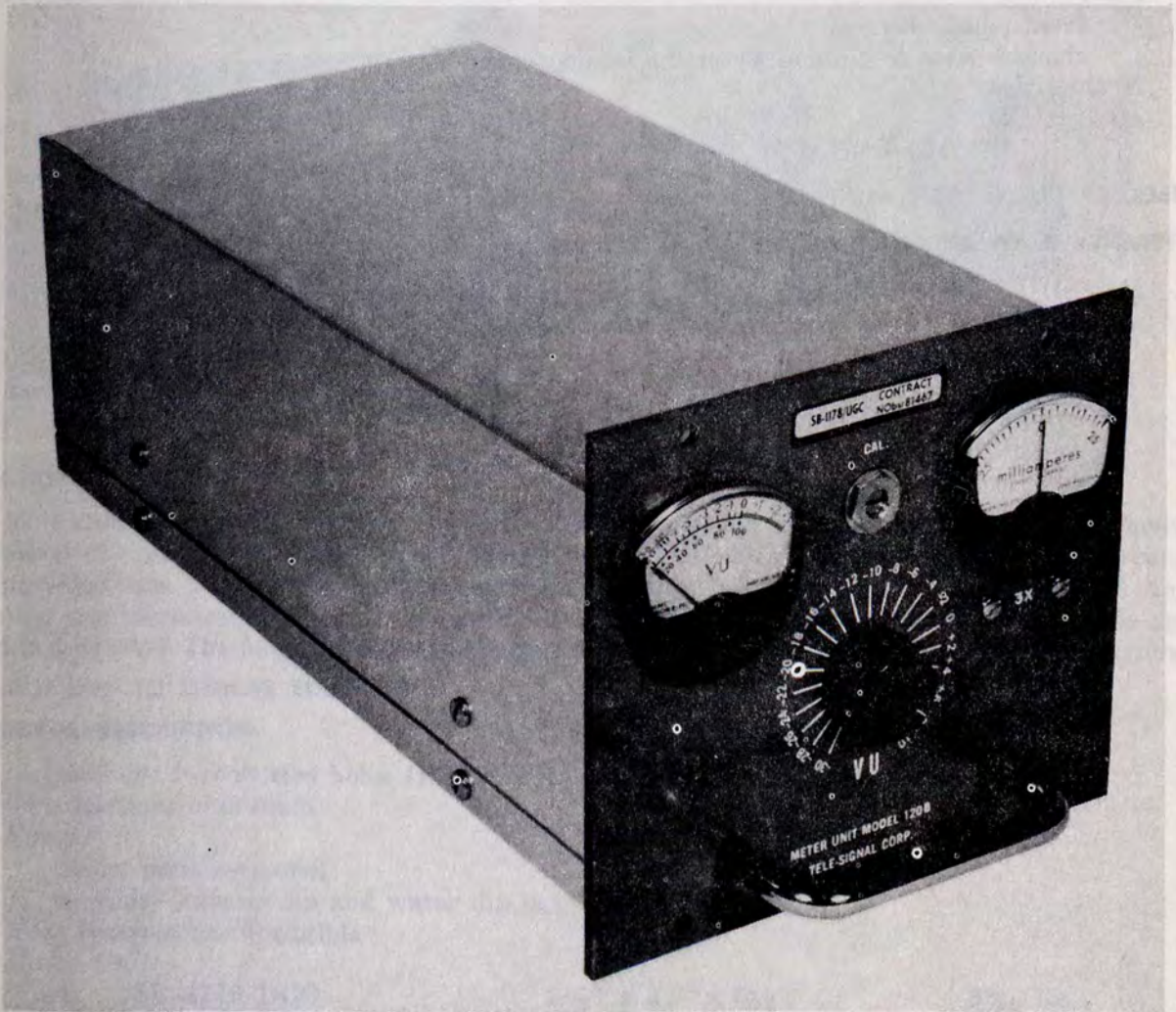
**FUNCTIONAL DESCRIPTION:**

Meter Panel SB-1176/UGC is used as a monitoring station for Telegraph Terminal AN/FGC-60(V). The signals applied to the meters are patched ccrded via the patch field.

AN/UGC-type
METER PANEL

SB-1178/UGC

RELATIONSHIP TO SIMILAR EQUIPMENT:

TECHNICAL DESCRIPTION:

VU Range of Measurement: —40 dbm to +20 dbm

DC Range of Measurement: —75 ma to +75 ma

Calibration Accuracy: 300 cps to 10 KC ± 2 db

Installation: Installed by plugging into Tele-Signal Model 139 Equipment Shelf, which mounts directly into standard 19" rack.

Construction: aluminum

Finish:

front panel—enamel

chassis—caustic dip and water dip lacquer spray

Heat dissipation: $\frac{3}{4}$ w

Major Units:

1 SB-1178/UGC

5 $\frac{1}{4}$ " x 6" x 11"

3 $\frac{3}{8}$ lbs

TUBES, CRYSTALS, TRANSISTORS:

REFERENCE DATA AND LITERATURE:

NAVSHIPS 93851

AN/UGC-type
SIGNAL DISTRIBUTION PANEL
SB-1179/UGC

15 March 1962
Cog. Serv: USN FSN:
USA Line Item No.:

	USA	USN	USAF	USMC
STATUS OR TYPE CLASS.:	Std-A	Std		
Manufacturer:	Tele-Signal Corp			

**FUNCTIONAL DESCRIPTION:**

This unit provides the terminal connection and distribution facilities for 16-channel transmit-dual diversity receive tone in Telegraph Terminal AN/FGC-60(V). Three separate tone circuits are provided, one transmitting and two receiving circuits; all tone lines are equipped with line isolation transformers. The transmitting circuit is equipped with an attenuator to adjust the aggregate tone level. The panel connects 16 frequency shift keyers and 16 frequency shift converters.

RELATIONSHIP TO SIMILAR EQUIPMENT:**TECHNICAL DESCRIPTION:**

Installation: four slotted holes (RETMA standard) for 19" rack mounting

Construction: aluminum

Finish:

front panel—enamel

chassis—caustic dip and water dip lacquer spray

Heat Dissipation: negligible

Major Unit:

1 SB-1179/UGC

3½" x 19" x 6½"

3¼ lbs

TUBES, CRYSTALS, TRANSISTORS:**REFERENCE DATA AND LITERATURE:**

NAVSHIPS 93853

AN/UGC-type
CHANNEL SELECTOR PANEL

SB-1180/UGC

15 March 1962

Cog. Serv: USN FSN:

USA Line Item No.:

USA

USN

USAF

USMC

STATUS OR TYPE CLASS.:

Std

Manufacturer: Tele-Signal Corp

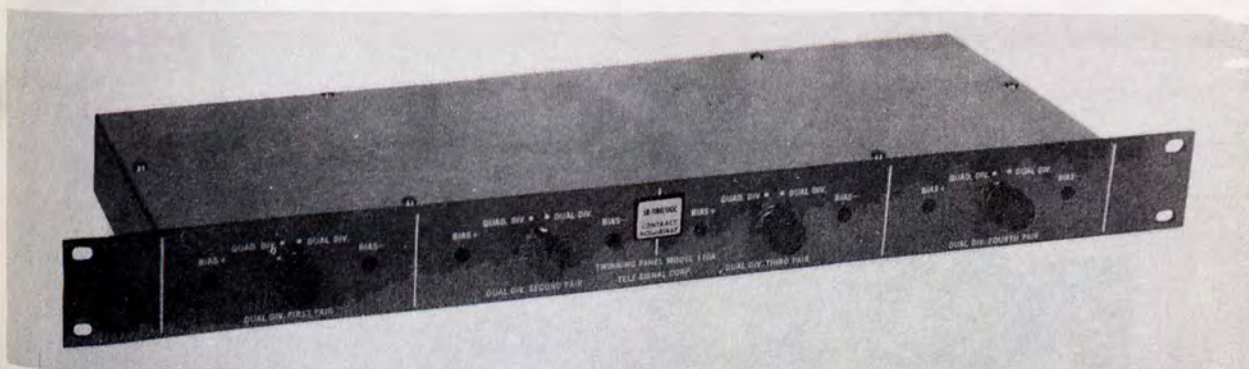
**FUNCTIONAL DESCRIPTION:**

This unit is used for combining the output of eight dual diversities into four quadruple diversities into four quadruple diversities.

This unit consists of four combiners. The inputs to each combiner are the outputs of two dual diversity comparators. A switch is provided for the selection of either quadruple or dual diversity system operation.

RELATIONSHIP TO SIMILAR EQUIPMENT:**TECHNICAL DESCRIPTION:**

Construction: aluminum

Finish:

front panel—enamel

chassis—caustic dip and water dip laquer spray

Installation: four slotted holes (RETMA standard) for 19" rack mounting

Major Units:

1 SB-1180/UGC

1 3/4" x 19" x 4 1/2"

3 lbs

TUBES, CRYSTALS, TRANSISTORS:**REFERENCE DATA AND LITERATURE:**

NAVSHIPS 93850

AN 800-415
CRANKIN SELECTOR PANEL
28-1180-1000

FIGURE 1
MIL-HDBK-145
PART 1 - NAVY OF 1-65

NO.	DESCRIPTION	QTY	UNIT
1	CRANKIN SELECTOR PANEL	1	EA

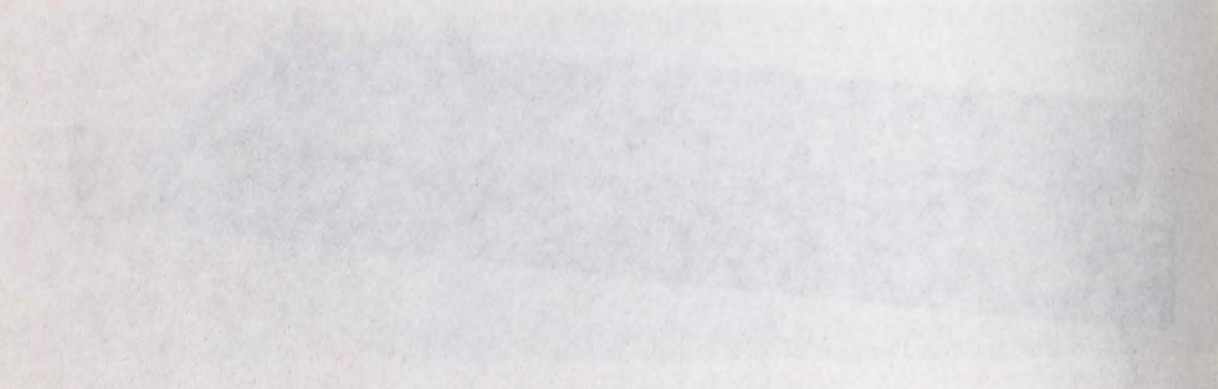

TECHNICAL DESCRIPTION
 This unit is used for controlling the output of eight dual in-line diodes and two four-quadrant diodes. The unit consists of four channels. The inputs to each channel are the outputs of two diodes. A control signal is provided for the selection of either quadrant of dual in-line diodes for operation.

REQUIREMENTS TO SUPPLIER EQUIPMENT

GENERAL EXPLANATION
 The schematic diagram shows the internal wiring of the unit. It includes a front panel with control elements, a chassis with electronic components, and a terminal block for external connections. The unit is designed for rack mounting.

TEST DATA AND DRAWINGS

ASSEMBLY DATA

AN/UGC-type
MULTIPLEXER

TD-410/UGC

15 March 1962

Cog. Serv: USN FSN:

USA Line Item No.:

	USA	USN	USAF	USMC
STATUS OR TYPE CLASS.:	Std-A	Std		

Manufacturer: Tele-Signal Corp

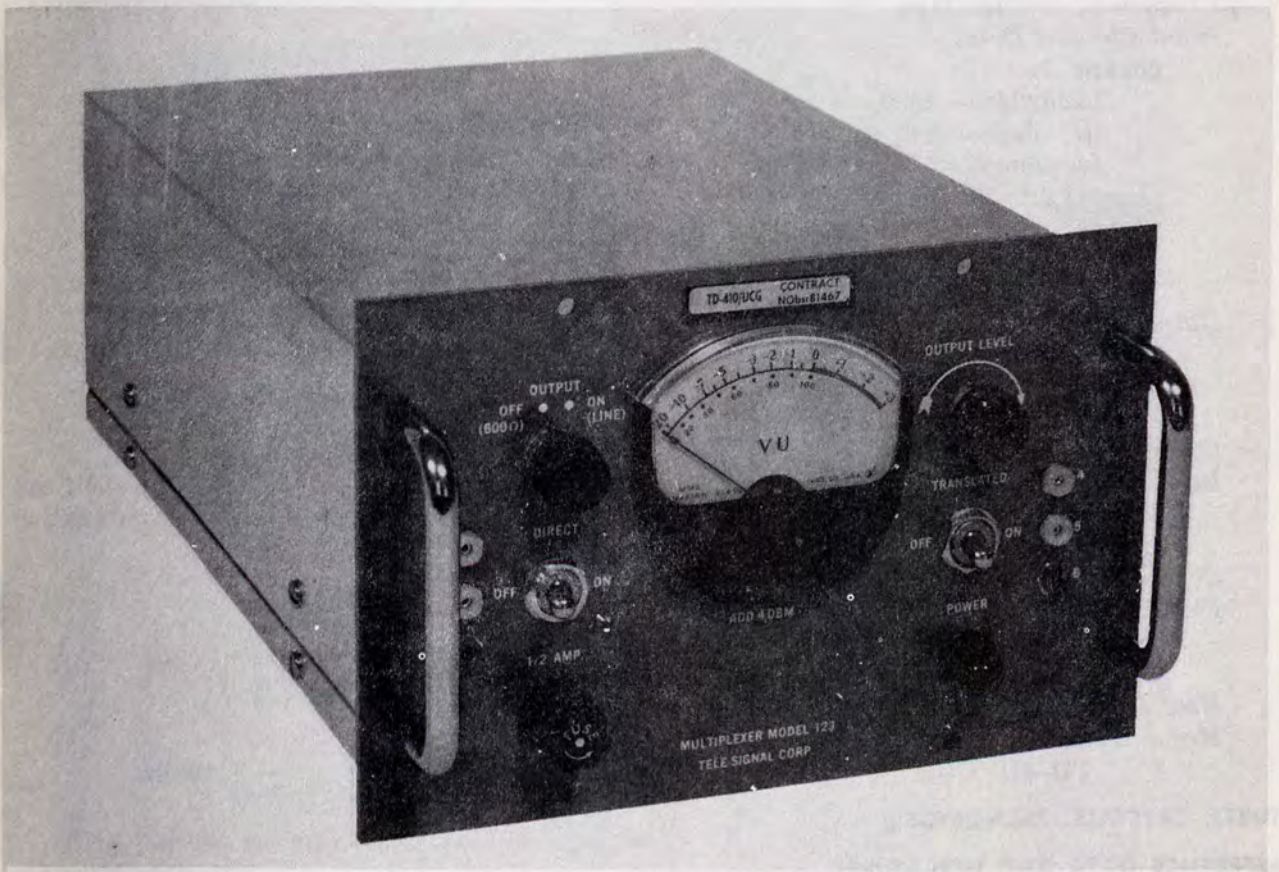

FUNCTIONAL DESCRIPTION:

Multiplexer TD-410/UGC combines two voice frequency circuits into one channel for transmission over a radio link. The radio bandwidth required is 6 kilocycles.

This equipmet, which is completely transistorized, consists of two (twin) channels with each channel covering a moninal 375 to 3035 cps voice band. One channel, known as the direct channel, passes the input signal unchanged. The second channel, known as the translated channel, heterodynes the input signal with an internal carrier so that the input signal is changed from the nomi-

**AN/UGC-type
MULTIPLEXER**

TD-410/UGC

nal 375 to 3025 cps voice band to a band of 3265 to 5915 cps. The two channels are then combined and passed as one 6 kc channel.

The multiplexer is a self contained unit including its own power supply and crystal controlled oscillator.

When used with independent sideband transmitters (twin channel), two multiplexers and two demultiplexers TD-411/UGC are needed to provide four independent voice frequency circuits.

RELATIONSHIP TO SIMILAR EQUIPMENT:

TECHNICAL DESCRIPTION:

Frequency: division type

Input Channel Data:

channel 1:

bandwidth—2650 cps
impedance—600 ohms
frequency—375 to 3025 cps

channel 2:

bandwidth—2650 cps
impedance—600 ohms
frequency—375 to 3025 cps

Output Data:

bandwidth—5540 cps
impedance—600 ohms
frequency—375 to 5915 cps

Operating Power Requirements: 115/230 v, 50/60 cps, single phase

Installation: Installed by plugging into Tele-Signal Model 139 Equipment Shelf. One shelf can accommodate two units (either multiplexers or demultiplexers or a mixed combination thereof).

Construction: aluminum

Finish:

front panel—enamel
chassis—caustic dip and water dip laquer spray

Heat Dissipation: 4 w

Major Units:

1 TD-410/UGC

5 $\frac{1}{4}$ " x 8" x 11"

10 lbs

TUBES, CRYSTALS, TRANSISTORS:

REFERENCE DATA AND LITERATURE:

NAVSHIPS 93856

TM for Multiplexer TD-410/UGC

AN/UGC-type
DEMULPLEXER
TD-411/UGC

15 March 1962

Cog. Serv: USN FSN:

USA Line Item No.:

	USA	USN	USAF	USMC
STATUS OR TYPE CLASS.:	Std-A	Std		

Manufacturer: Tele-Signal Corporation, Hicksville, N. Y.



FUNCTIONAL DESCRIPTION:

Demultiplexer TD-411/UGC is a receiving terminal equipment and operates in conjunction with a Multiplexer TD-410/UGC which is located at the transmitting terminal. The demultiplexer separates the unchanged voice channel from the translated voice channel and converts the latter back to its original voice channel. These two voice channels are separately amplified and fed to external equipments.

The demultiplexer is a completely transistorized, self-contained unit including its own power supply and crystal controlled oscillator.

**AN/UGC-type
DEMULTIPLEXER**

TD-411/UGC

The independent voice frequency circuits handled by a multiplexer—demultiplexer combination can be utilized for telephony, facsimile, or general data transmission.

RELATIONSHIP TO SIMILAR EQUIPMENT:

TECHNICAL DESCRIPTION:

Frequency: division type

Output Channel Data:

channel 1:

bandwidth—2650 cps

impedance—600 ohms

frequency—375–3025 cps

channel 2:

bandwidth—2650 cps

impedance—600 ohms

frequency—375 to 2025 cps

Input Data:

bandwidth—5540 cps

impedance—600 ohms

frequency—375 to 5915 cps

Operating Power Requirements: 115/230 v, 50/60 cps, single phase

Installation: Installed by plugging into Tele-Signal Model 139 Equipment Shelf. One shelf can accommodate two units (either multiplexers or demultiplexers or a mixed combination thereof).

Construction: aluminum

Finish:

front panel—enamel

chassis—caustic dip and water dip lacquer spray

Heat Dissipation: 4 w

Specific Application Data: Used whenever the received signal has been multiplexed at the transmitting terminal.

Major Units:

1 TD-411/UGC

5 $\frac{1}{4}$ " x 8" x 11"

10 lbs

TUBES, CRYSTALS, TRANSISTORS:

REFERENCE DATA AND LITERATURE:

NAVSHIPS 93857

AN/UGC-type
TELEGRAPH REPEATER

TH-42/UG

15 March 1962

Cog. Serv: USN FSN:

USA Line Item No.:

USA

USN

USAF

USMC

STATUS OR TYPE CLASS.:

Manufacturer: CBVV (96238), Stelma Inc

No Illustration Available

FUNCTIONAL DESCRIPTION:

Telegraph Repeater TH-42/UG is an in-line device used to regenerate a signal or signals in telegraph loops. It is designed for one-way reversible operation; it may also be connected for 4-wire (4W) to 4-wire, or 2-wire (2W) to 4-wire operation. The repeater can be used in either 20-ma or 60-ma neutral telegraph loops. The input and output circuits are isolated from each other.

The repeater uses tone couplers for isolation on the input sides, and low resistance vacuum tube keying on the output sides. The chassis is electrically isolated from the circuits. For in-line, 2-wire service, the two one-way repeaters are connected in cascade. The repeaters are coupled so that: (1) the output keying tube on one repeater, in series with the input circuits of the other, is continuously on "MARK" during transmission; and (2) an open circuit on the receiving end puts the sending end on "SPACE."

RELATIONSHIP TO SIMILAR EQUIPMENT:

Telegraph Repeater TH-42/UG is identical to Stelma Model TR-2B.

TECHNICAL DESCRIPTION:*Impedance:*

425 ohms, input and output, 2 wire

270 ohms, input, 20-ma loop, 4-wire

90 ohms, input, 60-ma loop, 4-wire

330 ohms, output, MARK, 4-wire

Keying Speed: up to 150 cps (300 baud)*Distortion:* under 2 percent*Operating Power Requirement:* 105-125 vac, 50/60 cps, 1 phase, 50 w*Major Units:*

1 TH-42/UG

31½" x 19" x 10"

12 lbs

TUBES, CRYSTALS, TRANSISTORS:**REFERENCE DATA AND LITERATURE:**

NAVSHIPS 93742

TM for Telegraph Repeater TH-42/UG

CHAPTER I
THE EARLY PERIOD

Year	Event
1776	Declaration of Independence
1781	Treaty of Paris
1787	Constitution
1791	Bill of Rights

THE HISTORY OF THE UNITED STATES

CHAPTER II
THE EARLY PERIOD

CHAPTER III
THE EARLY PERIOD

CHAPTER IV
THE EARLY PERIOD

AN/UGC-type
TELETYPEWRITER

TT-47/UG
TT-48/UG

23 October 1958

Cog. Serv: USN FSN: TT-47/UG, 5815-546-6789
TT-48/UG, 5815-665-2070

USA Line Item No.: 680385
680387

	USA	USN	USAF	USMC
STATUS OR TYPE CLASS.:	Std-B		Std (TT-47/UG) only	

Manufacturer:

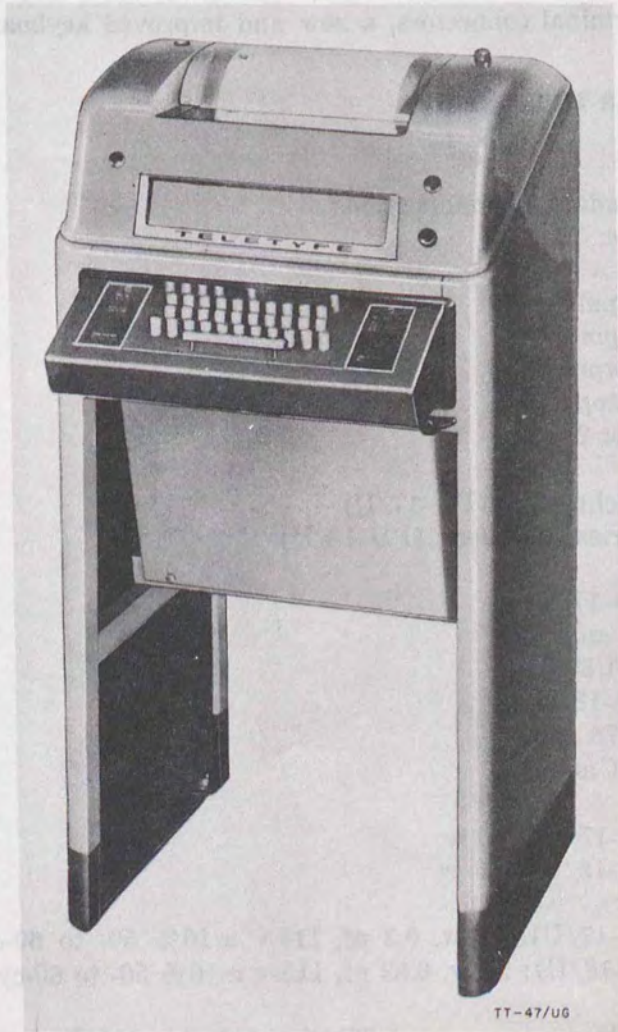

TT-47/UG

AN/UGC-type
TELETYPEWRITER

TT-47/UG
TT-48/UG

FUNCTIONAL DESCRIPTION:

Teletypewriters TT-47/UG and TT-48/UG are sending and receiving page-printing teletypewriter sets used for the transmission and reception of teletypewriter messages over wire or radio communication circuits. The signals transmitted and received are of the open-and-closed dc type. The equipments are adjustable to speeds of 460 and 600 operations per minute in addition to their regular speed of 368 operations per minute.

The TT-47/UG and TT-48/UG are electrically and mechanically interchangeable with the exception of their motors. The TT-47/UG is equipped with synchronous ac Motor PD-17/U; the TT-48/UG is equipped with series-governed ac Motor PD-18/U. The cabinet supplied with either unit is suitable for deck mounting.

Teletypewriter TT-47/UG and TT-48/UG differ from the TT-47A/UG and TT-48A/UG in several respects. In addition to electrical and mechanical differences, the "A" models have an increased number of terminal connectors, a new and improved keyboard, and an increase to 85 characters per line.

RELATIONSHIP TO SIMILAR EQUIPMENT:

TECHNICAL DESCRIPTION:

Type Keyboard: standard communications

Characters Per Line: 72

Operating Speed:

368 opm, 60 wpm

460 opm, 75 wpm

600 opm, 100 wpm

Code: 5 unit, start-stop

Number of Channels: 2

Type Motor:

TT-47/UG: synchronous (PD-17/U)

TT-48/UG: series-governed (PD-18/U)

Current Rating:

TT-47/UG (PD-17/U):

Starting: 9 amp

Operating: 1.85 amp

TT-48/UG (PD-18/U):

Starting: 1.75 amp

Operating: 1 amp

Heat Dissipation:

TT-47/UG (PD-17/U): 50 w

TT-48/UG (PD-18/U): 75 w

Power Requirements:

TT-47/UG (PD-17/U): 65 w, 0.3 pf, 115-v $\pm 10\%$ 50- to 60-cy ± 0.5 cy 1-phase ac

TT-48/UG (PD-18/U): 95 w, 0.83 pf, 115-v $\pm 10\%$ 50- to 60-cy 1-phase ac

Major Units:

1 CY-870/UG

39 $\frac{1}{2}$ " x 20 $\frac{1}{2}$ " x 18 $\frac{1}{4}$ "

81 lbs

AN/UGC-type
TELETYPEWRITER

TT-47/UG

TT-48/UG

TUBES, CRYSTALS, TRANSISTORS:

REFERENCE DATA AND LITERATURE:

NAVSHIPS 91393

AN/UGC-type
TELETYPEWRITER

TT-47A/UG
TT-48A/UG

23 October 1958

Cog. Serv: USN FSN: TT-47A/UG, 5815-644-3407

TT-48A/UG, 5815-665-2070

USA Line Item No.:

USA

USN

USAF

USMC

STATUS OR TYPE CLASS.:

Std-B

Manufacturer: Teletype Corp



**AN/UGC-type
TELETYPEWRITER**

**TT-47A/UG
TT-48A/UG**

FUNCTIONAL DESCRIPTION:

Teletypewriter TT-47A/UG and TT-48A/UG are sending and receiving page-printing teletypewriter sets used for the transmission and reception of teletypewriter messages over wire or radio communication circuits. Signaling between stations is accomplished by the five-unit, start-stop permutation code and utilizes the 7.42-unit transmission pattern. The operating speed of 60 words per minute may be increased to 75 or 100 words per minute by changing to other gears that are available as optional equipment.

The TT-47A/UG and TT-48A/UG are electrically and mechanically interchangeable with the exception of their motors. The TT-47A/UG is equipped with synchronous ac Motor PD-17A/U; the TT-48A/UG is equipped with series-governed ac Motor PD-18/U. The cabinet supplied with either unit is suitable for deck mounting.

Teletypewriters TT-47A/UG and TT-48A/UG differ from the TT-47/UG and TT-48/UG in several respects. In addition to electrical and mechanical differences, the later types have an increased number of terminal connectors, a new and improved keyboard, and an increase to 85 characters per line.

The TT-47A/UG and TT-48A/UG are identical with the TT-128A/UG and TT-129A/UG, respectively, except for their keyboards. The keyboards of the TT-128A/UG and TT-129A/UG have weather symbols instead of the standard communications keyboards on the TT-47A/UG and TT-48A/UG. The TT-47A/UG also is similar to Teletypewriter TT-171/UG except for the sending keyboard.

RELATIONSHIP TO SIMILAR EQUIPMENT:

TECHNICAL DESCRIPTION:

Type Keyboard: improved communications

Characters Per Line: 85

Operating Speed:

368 opm, 60 wpm

460 opm, 75 wpm

600 opm, 100 wpm

Code: 5-unit, start-stop

Transmission Pattern: 7.42-unit

Signaling Frequency:

60 wpm: 22.8 dot-cy

75 wpm: 37.1 dot-cy

Output Signal: on-off dc, 0.06 amp nominal from external 115-v source, either positive or negative polarity

Input Signal: on-off dc, 0.06 amp nominal from external source, either positive or negative polarity

Type Motor:

TT-47A/UG: synchronous (PD-17A/U)

TT-48A/UG: series-governed (PD-18/U)

Power Requirements:

TT-47A/UG (PD-17A/U): 65 w, 0.3 pf, 115-v $\pm 10\%$ 60-cy $\pm .5$ cy, 1-phase ac

TT-48A/UG (PD-18/U): 95 w, 0.83 pf, 115-v $\pm 10\%$ 50- to 60-cy 1-phase

AN/UGC-type
TELETYPEWRITERTT-47A/UG
TT-48A/UG*Major Units:*

MX-1114A/UG	4 $\frac{3}{4}$ " x 15 $\frac{1}{2}$ " x 17 $\frac{1}{2}$ "	11 lbs
MX-1115A/UG	9 $\frac{3}{4}$ " x 10 $\frac{1}{2}$ " x 15 $\frac{1}{2}$ "	19 lbs
SB-154A/UG	8 $\frac{1}{8}$ " x 4 $\frac{5}{8}$ " x 15"	5 lbs

TUBES, CRYSTALS, TRANSISTORS:**REFERENCE DATA AND LITERATURE:**

NAVSHIPS 91713

AN/UGC-type
TELETYPEWRITER

TT-69/UG
TT-70/UG

24 October 1958

Cog. Serv: USN FSN: TT-69/UG, 5815-503-2766

TT-70/UG, 5815-370-0074

USA Line Item No.: 680410

	USA	USN	USAF	USMC
STATUS OR TYPE CLASS.:	Std-B			
Manufacturer:	Teletype Corp			

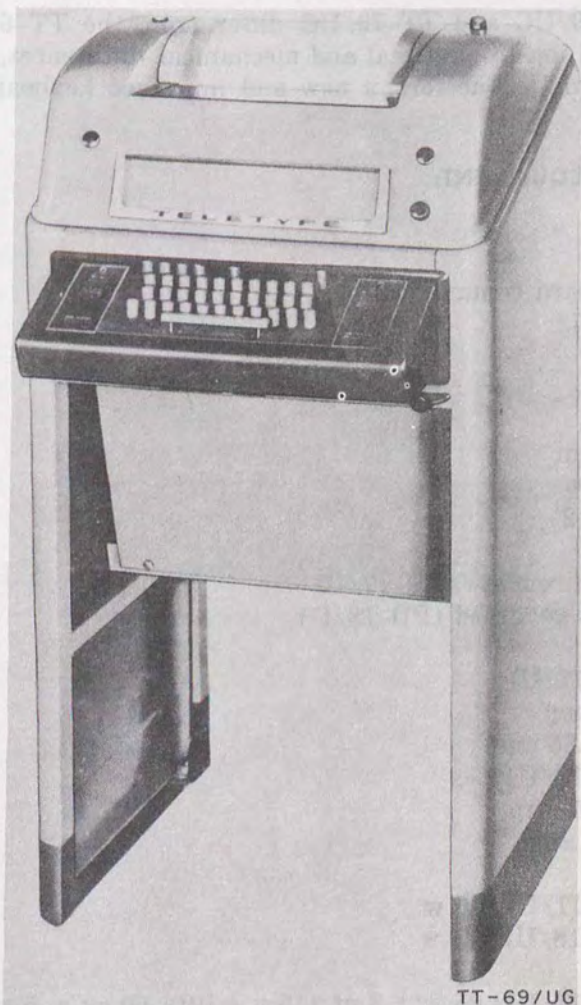

TT-69/UG

AN/UGC-type
TELETYPEWRITER

TT-69/UG
TT-70/UG

FUNCTIONAL DESCRIPTION:

Teletypewriters TT-69/UG and TT-70/UG are sending and receiving page-printing teletypewriter sets used for the transmission and reception of teletypewriter messages over wire or radio communication circuits. The signals transmitted and received are of the open-and-closed dc type. The equipments are adjustable to speeds of 460 to 600 operations per minute in addition to their regular speed of 368 operations per minute.

The TT-69/UG and TT-70/UG are electrically and mechanically interchangeable with the exception of their motors. The TT-69/UG is equipped with synchronous ac Motor PU-17/U; the TT-70/UG is equipped with series-governed ac Motor PU-18/U. The cabinet supplied with either unit is suitable for bulkhead mounting.

Teletypewriters TT-69/UG and TT-70/UG differ from the TT-69A/UG and TT-70A/UG in several respects. In addition to electrical and mechanical differences, the "A" models have an increased number of terminal connectors, a new and improved keyboard, and an increase to 85 characters per line.

RELATIONSHIP TO SIMILAR EQUIPMENT:

TECHNICAL DESCRIPTION:

Type Keyboard: standard communications

Characters Per Line: 72

Operating Speed:

268 opm, 60 wpm

460 opm, 75 wpm

600 opm, 100 wpm

Code: 5-unit, start-stop

Number of Channels: 2

Type Motor:

TT-69/UG: synchronous (PD-17/U)

TT-70/UG: series-governed (PD-18/U)

Current Rating:

TT-69/UG (PD-17/U):

Starting: 9 amp

Operating: 1.85 amp

TT-70/UG (PD-18/U):

Starting: 1.75 amp

Operating: 1 amp

Heat Dissipation:

TT-69/UG (PD-17/U): 50 w

TT-70/UG (PD-18/U): 75 w

Power Requirements:

TT-69/UG (PD-17/U): 65 w, 0.3 pf 115-v $\pm 10\%$ 60-cy $\pm .5$ cy 1-phase ac

TT-70/UG (PD-18/U): 95 w, 0.83 pf, 115-v $\pm 10\%$ 50- to 60-cy 1-phase ac

AN/UGC-type
TELETYPEWRITERTT-69/UG
TT-70/UG*Major Units:*

1 MX-1115A/UG
1 MX-1114A/UG
1 SB-154A/UG

9 $\frac{3}{4}$ " x 10 $\frac{1}{2}$ " x 15 $\frac{1}{2}$ "
4 $\frac{3}{4}$ " x 15 $\frac{1}{2}$ " x 17 $\frac{1}{2}$ "
8 $\frac{1}{8}$ " x 4 $\frac{5}{8}$ " x 15"

19 lbs
11 lbs
5 lbs

TUBES, CRYSTALS, TRANSISTORS:**REFERENCE DATA AND LITERATURE:**

NAVSHIPS 91393
Spec No. CS-898

AN/UGC-type
TELETYPEWRITERTT-69A/UG
TT-70A/UG

28 October 1958

Cog. Serv: USN FSN: TT-69A/UG, 5815-503-2766
5815-644-4705
TT-70A/UG, 5815-665-2068

USA Line Item No.:

	USA	USN	USAF	USMC
STATUS OR TYPE CLASS.:	Std-B		L/Std (TT-70A/UG) only	

Manufacturer: Teletype Corp

No Illustration Available

FUNCTIONAL DESCRIPTION:

Teletypewriters TT-69A/UG and TT-70A/UG are sending and receiving page-printing teletypewriter sets used for the transmission and reception of teletypewriter messages over wire or radio communication circuits. Signaling between stations is accomplished by the five-unit, start-stop permutation code and utilizes the 7.42-unit transmission pattern. The operating speed of 60 words per minute may be increased to 75 or 100 words per minute by changing to other gears that are available as optional equipment.

The TT-69A/UG and TT-70A/UG are electrically and mechanically interchangeable with the exception of their motors. The TT-69A/UG is equipped with synchronous ac Motor PD-17A/U; the TT-70A/U is equipped with series-governed ac Motor PD-18/U. The cabinet supplied with either unit is suitable for bulkhead mounting.

Teletypewriters TT-69A/UG and TT-70A/UG differ from the TT-69/UG and the TT-70/UG in several respects. In addition to electrical and mechanical differences, the later types have an increased number of terminal connectors, a new and improved keyboard, and an increase to 85 characters per line.

The TT-69A/UG and TT-70A/UG are identical with the TT-130A/UG and TT-131A/UG, respectively, except for their keyboards. The keyboards of the TT-130A/UG and TT-131A/UG have weather symbols instead of the standard communications keyboards on the TT-69A/UG and TT-70A/UG. The TT-69A/UG also is similar to Teletypewriter TT-171/UG except for the sending keyboard.

RELATIONSHIP TO SIMILAR EQUIPMENT:**TECHNICAL DESCRIPTION:***Type Keyboard:* improved communications*Characters Per Line:* 85*Operating Speed:*

368 opm, 60 wpm

460 opm, 75 wpm

600 opm, 100 wpm

Code: 5-unit, start-stop

AN/UGC-type
TELETYPEWRITER

TT-69A/UG TT-70A/UG

Transmission Pattern: 7.42-unit

Signaling Frequency:

60 wpm: 22.8 dot-cy

75 wpm: 28.5 dot-cy

100 wpm: 37.1 dot-cy

Output Signal: On-off dc, 0.06 amp nominal from external 115-v source, either positive or negative polarity

Input Signal: On-off dc, 0.06 amp nominal from external source, either positive or negative polarity

Type Motor:

TT-69A/UG: synchronous (PD-17A/U)

TT-70A/UG: series-governed (PD-18/U)

Power Requirements:

TT-69A/UG (PD-17A/U): 65 w, 0.3 pf, 115-v $\pm 10\%$ 60-cy $\pm .5$ cy 1-phase ac

TT-80A/U (PD-18/U): 95 w, 115-v $\pm 10\%$ 50- to 60-cy 1-phase ac

Major Units:

1	MX-1115/UG	9 $\frac{3}{4}$ " x 10 $\frac{1}{2}$ " x 15 $\frac{1}{2}$ "	19 lbs
1	MX-1114/UG	4 $\frac{3}{4}$ " x 15 $\frac{1}{2}$ " x 17 $\frac{1}{2}$ "	11 lbs
1	SB-154/UG	8 $\frac{1}{8}$ " x 4 $\frac{5}{8}$ " x 15"	5 lbs

TUBES, CRYSTALS, TRANSISTORS:

REFERENCE DATA AND LITERATURE:

NAVSHIPS 91713

Spec No. CS-989

AN/UGC-type
TELETYPEWRITERTT-128A/UG
TT-129A/UG

28 October 1958

Cag. Serv: USN FSN:

USA Line Item No.: 680458 (TT-128A/UG)

	USA	USN	USMC	USAF
STATUS OR TYPE CLASS.:	Std-B			
Manufacturer:	Teletype Corp			

No Illustration Available

FUNCTIONAL DESCRIPTION:

Teletypewriters TT-128A/UG and TT-129A/UG are sending and receiving page-printing teletypewriter sets used for the transmission and reception of weather aerological information by teletypewriter over wire or radio communication circuits. Signaling between stations is accomplished by the five-unit, start-stop permutation code and utilizes the 7.42-unit transmission pattern. The normal operating speed of 60 words per minute may be increased to 75 or 100 words per minute by changing to other gears which are available as optional equipment.

The TT-128A/UG and TT-129A/UG are electrically and mechanically interchangeable with the exception of their motors. The TT-128A/UG is equipped with synchronous ac Motor PD-17A/U; the TT-129A/UG is equipped with series-governed ac Motor PD-18/U. The cabinet supplied with either unit is suitable for deck mounting.

Teletypewriters TT-128A/UG and TT-129A/UG are identical to the TT-47A/UG and TT-48A/UG respectively, with the exception of their keyboards. The keyboards of the TT-128A/UG and TT-129/UG have weather symbols instead of standard communications keyboards.

RELATIONSHIP TO SIMILAR EQUIPMENT:**TECHNICAL DESCRIPTION:***Type Keyboards:* improved weather*Characters Per Line:* 85*Operating Speed:*

368 opm, 60 wpm

460 opm, 75 wpm

600 opm, 100 wpm

Code: 5-unit, start-stop*Transmission Pattern:* 7.42-unit*Signaling Frequency:*

60 wpm: 22.8 dot-cy

75 wpm: 28.5 dot-cy

100 wpm: 37.1 dot-cy

Output Signal: on-off dc, 0.06 amp nominal from external 115-v source, either positive or negative polarity*Input Signal:* on-off dc, 0.06 amp nominal from external source, either positive or negative polarity

AN/UGC-type
TELETYPEWRITER

TT-128A/UG
TT-129A/UG

Type Motor:

TT-128A/UG: synchronous (PD-17A/U)
TT-129A/UG: series-governed (PD-18/U)

Current Rating:

TT-128A/UG (PD-17A/U):

Starting: 9 amp
Operating: 1.85 amp

TT-129A/UG (PD-18/U):

Starting: 1.75 amp
Operating: 1 amp

Heat Dissipation:

TT-128A/UG (PD-17A/U): 50 w

TT-129A/UG (PD-18/U): 75 w

Power Requirements:

TT-128A/UG (PD-17A/U): 65 w, 0.3 pf, 115-v $\pm 10\%$ 60 cy $\pm .5$ cy 1-phase ac

TT-129A/UG (PD-18/U): 95 w, 0.83 pf, 115-v $\pm 10\%$ 50- to 60-cy 1-phase ac

Major Units:

1	MX-1422A/UG	9 $\frac{3}{4}$ " x 10 $\frac{1}{2}$ " x 15 $\frac{1}{2}$ "	19 lbs
1	MX-1421A/UG	4 $\frac{3}{4}$ " x 15 $\frac{1}{2}$ " x 17 $\frac{1}{2}$ "	11 lbs
1	SB-154A/UG	4 $\frac{5}{8}$ " x 8 $\frac{1}{8}$ " x 18"	5 lbs

TUBES, CRYSTALS, TRANSISTORS:

REFERENCE DATA AND LITERATURE:

NAVSHIPS 91713
NAVSHIPS 98350

AN/UGC-type
TELETYPEWRITERTT-130A/UG
TT-131A/UG

1 March 1964

Cog. Serv: USN FSN:

USA Line Item No.: 680460

USA

USN

USAF

STATUS OR TYPE CLASS.: Std-B

Manufacturer: Teletype Corp

No Illustration Available

FUNCTIONAL DESCRIPTION:

Teletypewriters TT-130A/UG and TT-131A/UG are sending and receiving page-printing teletypewriter sets used for the transmission and reception of weather aerological information by teletypewriter over wire or radio communication circuits. Signaling between stations is accomplished by the five-unit, start-stop permutation code and utilizes the 7.42-unit transmission pattern. The normal operating speed of 60 words per minute may be increased to 75 or 100 words per minute by changing to other gears that are available as optional equipment.

The TT-130A/UG and TT-131A/UG are electrically and mechanically interchangeable with the exception of their motors. The TT-130A/UG is equipped with synchronous ac Motor PD-17A/U; the TT-131A/UG is equipped with series-governed ac Motor PD-18/U. The cabinet supplied with either unit is suitable for bulkhead shelf mounting.

Teletypewriters TT-130A/UG and TT-131A/UG are identical to the TT-69A/UG and TT-70A/UG, respectively, with the exception of their keyboards. The keyboards of the TT-130A/UG and TT-131A/UG have weather symbols instead of standard communications keyboards.

RELATIONSHIP TO SIMILAR EQUIPMENT:**TECHNICAL DESCRIPTION:***Type Keyboard:* improved weather*Characters Per Line:* 85*Operating Speed:*

368 opm, 60 wpm

460 opm, 75 wpm

60 opm, 100 wpm

Code: 5-unit, start-stop*Transmission Pattern:* 7.42-unit*Signaling Frequency:*

60 wpm: 22.8 dot-cy

75 wpm: 28.5 dot-cy

100 wpm: 37.1 dot-cy

Output Signal: on-off dc, 0.06 amp nominal from external 115-v source, either positive or negative polarity

AN/UGC-type
TELETYPEWRITER

TT-130A/UG
TT-131A/UG

Input Signal: on-off dc, 0.06 amp nominal from external source, either positive or negative polarity

Type Motor:

TT-130A/UG: synchronous (PD-17A/U)

TT-131A/UG: series-governed (PD-18/U)

Current Rating:

TT-130A/UG (PD-17A/U):

Starting: 9 amp

Operating: 1.85 amp

TT-131A/UG (PD-18/U):

Starting: 1.75 amp

Operating: 1 amp

Heat Dissipation:

TT-130A-UG (PD-17A/U): 50 w

TT-131A/UG (PD-18/U): 75 w

Power Requirements:

TT-130A/UG (PD-17A/U): 65 w, 0.3 pf, 115-v $\pm 10\%$ 60-cy $\pm .5$ cy 1-phase ac

TT-131A/UG (PD-18/U): 95 w, 0.83 pf 115-v $\pm 10\%$ 50- to 60-cy 1-phase ac

Major Units:

1	MX-1422A/UG	9 $\frac{3}{4}$ " x 10 $\frac{1}{2}$ " x 15 $\frac{1}{2}$ "	19 lbs
1	MX-1421A/UG	4 $\frac{3}{4}$ " x 15 $\frac{1}{2}$ " x 17 $\frac{1}{2}$ "	11 lbs
1	SB-154A/UG	4 $\frac{5}{8}$ " x 8 $\frac{1}{8}$ " x 18"	5 lbs

TUBES, CRYSTALS, TRANSISTORS:

REFERENCE DATA AND LITERATURE:

NAVSHIPS 91713

NAVSHIPS 98350

AN/UGR-type
TELETYPEWRITER
TT-171/UG

28 October 1958

Cog. Serv: USN FSN:

USA Line Item No.: 680464

	USA	USN	USAF	USMC
--	-----	-----	------	------

STATUS OR TYPE CLASS.:	Std-B			
------------------------	-------	--	--	--

Manufacturer: Teletype Corp

No Illustration Available

FUNCTIONAL DESCRIPTION:

Teletypewriter TT-171/UG is a receiving only page-printing teletypewriter set used to receive typewritten messages over wire or radio telegraph circuits from equipment located at a ship or shore station. The normal operating speed of 60 words per minute may be increased to 75 or 100 words per minute by changing to other gears that are available as optional equipment.

The TT-171/UG is similar to the TT-47A/UG and TT-69A/UG with the exception of the sending keyboard. The TT-171/UG is equipped with synchronous ac Motor PD-17A/U, and the cabinet supplied with the unit is suitable for deck mounting.

RELATIONSHIP TO SIMILAR EQUIPMENT:**TECHNICAL DESCRIPTION:***Characters Per Line:* 85*Operating Speed:*

368 opm, 60 wpm

460 opm, 75 wpm

600 opm, 100 wpm

Code: 5-unit, start-stop*Transmission Pattern:* 7.42-unit*Signaling Frequency:*

60 wpm: 22.8 dot-cy

75 wpm: 28.5 dot-cy

100 wpm: 37.1 dot-cy

Input Signal: on-off dc, 0.06 amp nominal from external source, either positive or negative polarity*Type Motor:* synchronous (PD-17A/U)*Current Rating:*

Starting: 9 amp

Operating: 1.85 amp

Heat Dissipation: 50 w*Power Requirements:* 65 w, 0.3 pf, 115-v $\pm 10\%$ 60-cy $\pm .5$ cy 1-phase ac*Major Units:*

MX-1115A/UG

9 $\frac{3}{4}$ " x 10 $\frac{1}{2}$ " x 15 $\frac{1}{2}$ "

19 lbs

SB-154/UG

4 $\frac{5}{8}$ " x 8 $\frac{1}{8}$ " x 15"

5 lbs

AN/UGR-type
TELETYPEWRITER

TT-171/UG

TUBES, CRYSTALS, TRANSISTORS:

REFERENCE DATA AND LITERATURE:

NAVSHIPS 91713

AN/UGT-type
TELETYPEWRITER DISTRIBUTOR-TRANSMITTER

TT-187/UG

30 October 1958

Cog. Serv: USN FSN:

USA Line Item No.: 613694

USA

USN

USAF

USMC

STATUS OR TYPE CLASS.:

Std-A

Manufacturer: Western Electric Co

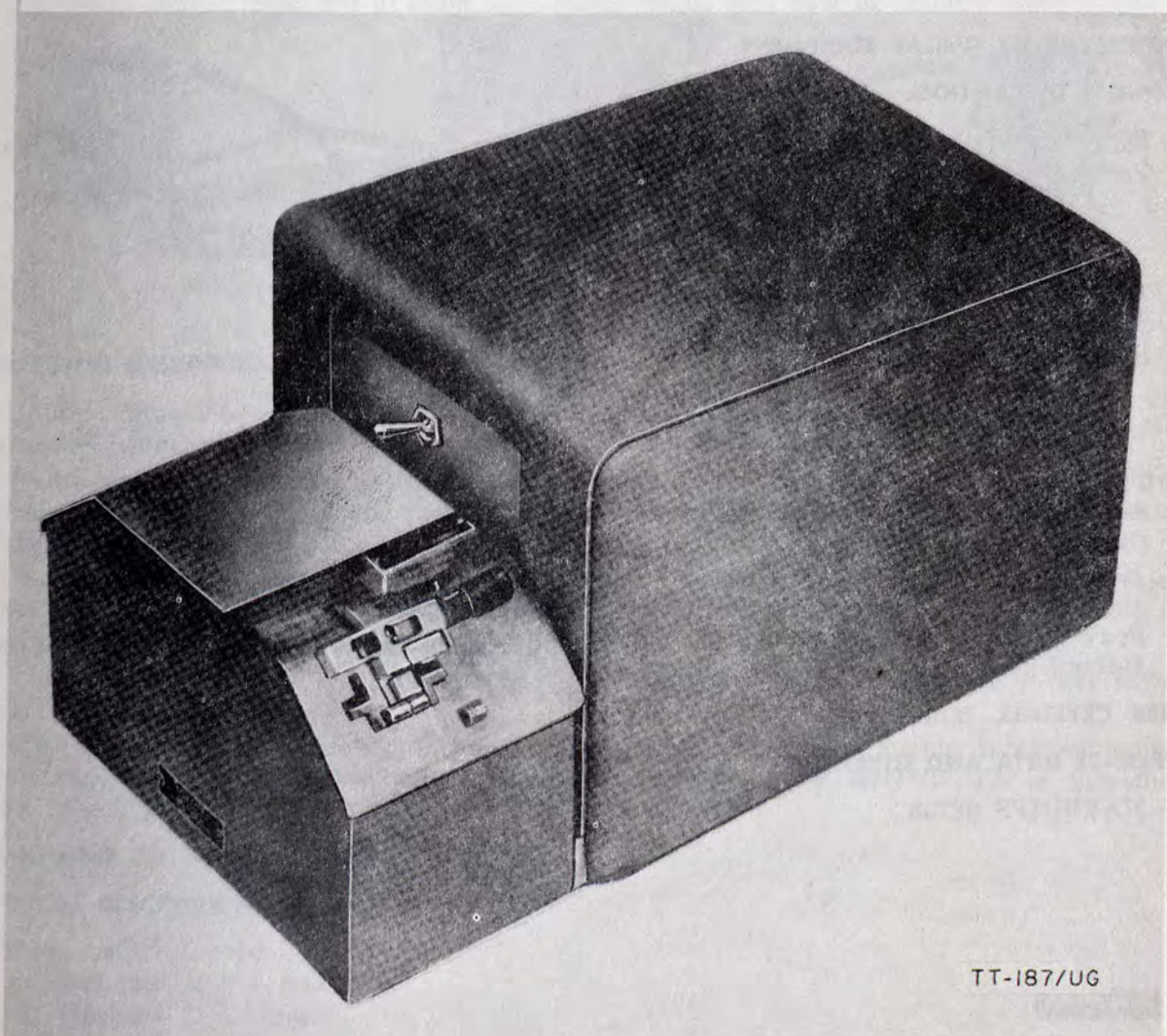

TT-187/UG

AN/UGT-type
TELETYPEWRITER DISTRIBUTOR-TRANSMITTER

TT-187/UG

FUNCTIONAL DESCRIPTION:

Teletypewriter Distributor-Transmitter TT-187/UG is an automatic transmitter distributor designed for use in transmitting or relaying stations where large amounts of traffic must be handled with minimum delay. The unit translates code impulses from fully perforated or chadless tape into electrical impulses and transmits these impulses, in the form of a five-unit, start-stop permutation code to one or more receiving stations.

The TT-187/UG consists principally of tape sensing and tape feeding mechanisms, a distributor commutator, and a motor, all of which are housed in a metal cabinet. It has an all steel external expansion clutch, sensing pins with longer travel located in line with axis of the feed wheel, and an increased number of feed pins engaging the feed holes in the tape.

RELATIONSHIP TO SIMILAR EQUIPMENT:

TECHNICAL DESCRIPTION:

Type Tape: chad (perforated) or chadless

Operating Speed:

368 opm, 60 wpm

460 opm, 75 wpm

600 opm, 100 wpm

Type Signaling Code: 5-unit, start-stop

Transmission Pattern: 7.42-unit

Signaling Frequency:

60 wpm: 22.8 dot-cy

75 wpm: 28.5 dot-cy

100 wpm: 37.1 dot-cy

Type Motor: synchronous

Motor Speed: 3,600 rpm

Current Rating:

Starting: 9 amp

Operating: 1.85 amp

Power Requirements: 65 w, 0.3 pf, 115-v $\pm 10\%$ 60-cy $+75\%$, 1-phase ac

Major Units:

TUBES, CRYSTALS, TRANSISTORS:

REFERENCE DATA AND LITERATURE:

NAVSHIPS 92733

INTERCOMMUNICATION SET

AN/UIC-1, -1X

1 March 1964

Cog. Serv: USA FSN: 5830-224-5341

USA Line Item No.: 621266

USA

USN

USAF

USMC

STATUS OR TYPE CLASS.:

Std-A

Manufacturer:

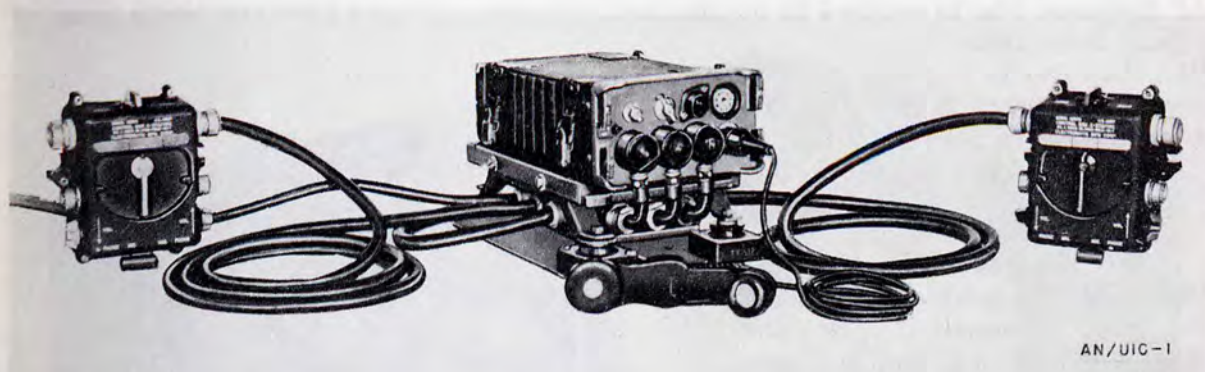

AN/UIC-1

FUNCTIONAL DESCRIPTION:

Intercommunication Sets AN/UIC-1 and AN/UIC-1X are vehicular interphone units used to provide two-way communication in inclosed or armored vehicles.

These equipments consist essentially of an audio power amplifier, two interphone control stations, and power components plus accessories, depending upon the type of vehicle in which the system is installed. An additional control box can be added to the system.

The sets provide control of one or two radio sets installed and operated within the vehicle equipped with the system. These radio sets are designed to be employed in conjunction with an integrated series of radio equipment.

Power is obtained from vehicular 12- or 24-volt storage batteries through appropriate power supply components.

Both models of this set are similar, with the exception of the power supply. Intercommunication Set AN/UIC-1 is furnished with a 12-volt power supply; the AN/UIC-1X is furnished with a 24-volt power supply.

RELATIONSHIP TO SIMILAR EQUIPMENT:**TECHNICAL DESCRIPTION:***Signal Input Levels:*

Channel 1: 5 v max

Channel 2: 5 v max

Channel 3: 0.25 v max

Signal Output Levels:

Channel 1: 350 mw min

INTERCOMMUNICATION SET

AN/UIC-1, -1X

Channel 2: 350 mw min

Channel 3: 800 mw min; 1,800 mw min (5 v and .25 v signal into channel)

Input Impedance:

Channel 1: 1,500 ohms

Channel 2: 1,500 ohms

Channel 3: 150 ohms

Output Impedance:

Channel 1: 600 ohms

Channel 2: 600 ohms

Channel 3: 600 ohms

AF Response: Flat to within 4 db for frequencies between 400 and 2,500 cps; sharp cutoff beyond these limits

Distortion Due to Overload: 10% max each channel

Crosstalk Between Channels 1 and 2: 50 db down, min

Amplifier Power Requirements:

Plates: 135 v at 35 ma

Filaments: 12- or 24-v operation: 12.6 va at 0.6 amp

Relay: 6.3 v at 166 ma

Microphone: 6.3 at 30 ma

Operating Temperature Range: -40°F to +149°F

Power Requirements:

AN/UIC-1: 3.85 amp at 12 v dc

AN/UIC-1X: 2.4 amp at 24 v dc

Major Units:

1	AM-65/GRC	4 $\frac{1}{4}$ " x 12 $\frac{7}{8}$ " x 7 $\frac{7}{8}$ "	10 lbs
2	C-375/VRC	6 $\frac{3}{16}$ " x 7" x 3 $\frac{1}{4}$ "	3.25 lbs
1	MT-300/GR	3 $\frac{1}{16}$ " x 13" x 8 $\frac{5}{16}$ "	
1	PP-281/GRC		10 lbs
	(For AN/UIC-1)	4 $\frac{1}{4}$ " x 5 $\frac{3}{4}$ " x 2 $\frac{15}{16}$ "	5.5 lbs
1	PP-282/GRC		
	(For AN/UIC-1X)	4 $\frac{1}{4}$ " x 5 $\frac{3}{4}$ " x 2 $\frac{15}{16}$ "	5.5 lbs

TUBES, CRYSTALS, TRANSISTORS:**REFERENCE DATA AND LITERATURE:**

TM 11-2643

SOUND RECORDER REPRODUCER SET

AN/UNH-3A

1 March 1964

Cog. Serv: USMC FSN:

USA Line Item No.:

USA

USN

USAF

USMC

STATUS OR TYPE CLASS.:

Std

Manufacturer: U. S. Recording Co



SOUND RECORDER REPRODUCER SET

AN/UNH-3A

FUNCTIONAL DESCRIPTION:

Sound Recorder Reproducer Set AN/UNH-3A is a self-contained tape recorder-reproducer which uses standard one-quarter-inch plastic tape as the recording medium.

RELATIONSHIP TO SIMILAR EQUIPMENT:

None

TECHNICAL DESCRIPTION:

Recording Tape Speed: $3\frac{3}{4}$ and $7\frac{1}{2}$ IPS

Frequency Response:

$3\frac{3}{4}$ IPS: 60 to 5,000 cps

$7\frac{1}{2}$ IPS: 60 to 10,000 cps

Power Output: 5 w

Operating Power Requirements: 115 v, 60 cps, single phase

Case: watertight transit case

Shipping Data:

Size: 12" x 14" x 10"

Weight: 40 lbs

Major Items:

No data available

TUBES, CRYSTALS, TRANSISTORS:

REFERENCE DATA AND LITERATURE:

None

SOUND RECORDER SET

AN/UNH-6

1 March 1964

Cog. Serv: USA FSN: 5835-892-3510

USA Line Item No.: 659111

USA

USN

USAF

STATUS OR TYPE CLASS.: Std-A

Manufacturer: Amplex Corp

No Illustration Available

FUNCTIONAL DESCRIPTION:

Sound Recorder Set AN/UNH-6 is a general purpose unit designed for airborne requirements. It is lightweight and has a high fidelity dual track. The set functions as a recorder only.

This equipment has single speed only. It has two tracks for simultaneous recording of either voice or data with erasure head for clearing tape ahead of recording.

RELATIONSHIP TO SIMILAR EQUIPMENT:

None

TECHNICAL DESCRIPTION:*Type:* electromagnetic*Number of Tracks:* 2*Tape:*

Type: Mylar base

Width: 1/4"

Feed: 7.5" per sec

Frequency Response: ± 2 db from 50 cps to 10,000 cps*Input Impedance (Each Channel):*

Microphone: 200 ohms

Data: 500 ohms

Recording Time: 45 min max; continuous*Power Requirements:* 108 to 121-v, 380 to 420 cps, 1-phase ac, 0.32 amp; 25- to 29-v dc, 6.0 amp*Major Units:***TUBES, CRYSTALS, TRANSISTORS:****REFERENCE DATA AND LITERATURE:**

FREQUENCY SHIFT CONVERTER-COMPARATOR GROUP

AN/URA-8, -8A

1 March 1964

Cog. Serv: USN FSN: AN/URA-8: 5840-644-4842
 AN/URA-8A: 5840-642-8360

USA

USN

USAF

STATUS OR TYPE CLASS.:

L/Std

Manufacturer: Hoffman Radio Corp

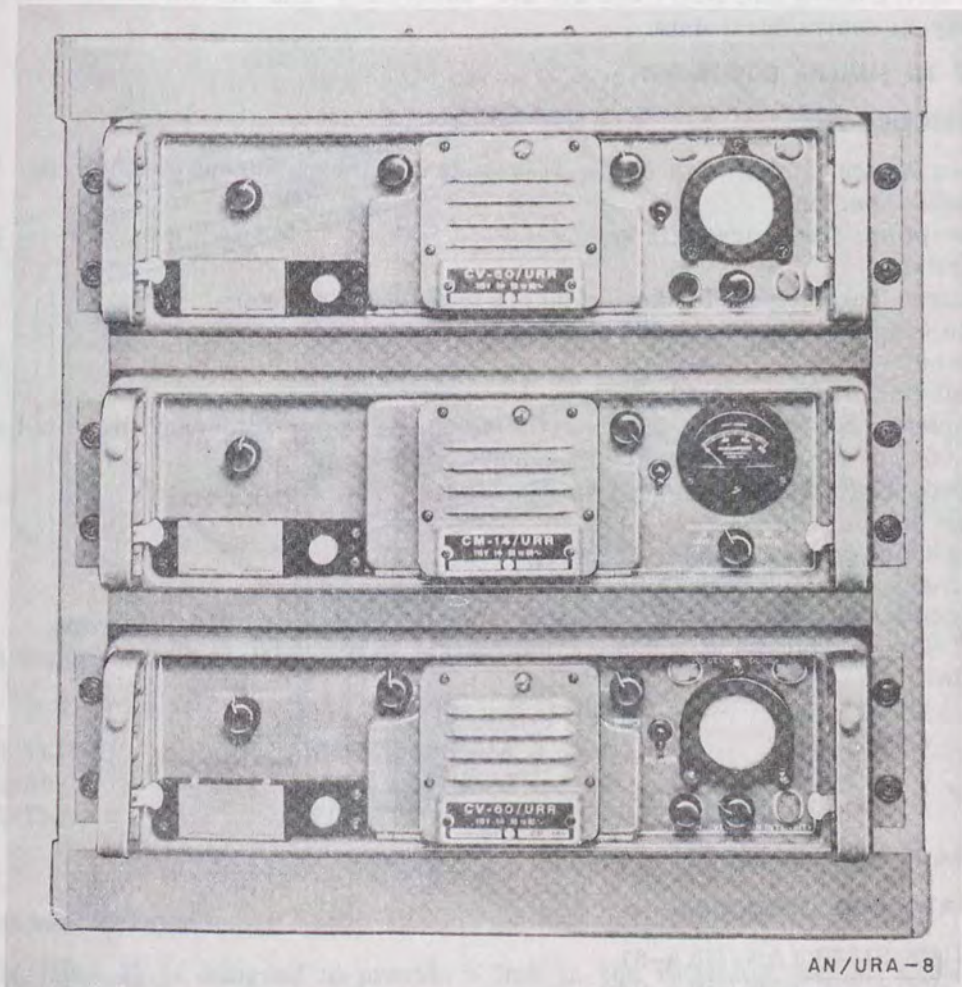

AN/URA-8

FUNCTIONAL DESCRIPTION:

Frequency Shift Converter-Comparator Groups AN/URA-8 and AN/URA-8A are designed to operate on frequency-shift keyed radiotelegraph signals. These signals are derived from the audio frequency outputs of radio receivers and provide keying facilities for the operation of teletypewriter printers or other automatic recording devices.

FREQUENCY SHIFT CONVERTER-COMPARATOR GROUP

AN/URA-8, -8A

Two receiving channels are used in a diversity arrangement but the frequency-shift converters may be used separately for single receiver reception. A comparator selects the stronger signal to control the teletypewriter loop and the keyed tone.

It is possible to obtain keying speeds of up to 60 words per minute for a single telegraph channel, or of 100 words per minute if external apparatus is used. These keying speeds are useable in the reception of four-channel, multiplex, telegraph signal, diversity, or single-unit operation.

The two equipments are used with two radio receivers and a standard or high-speed teletypewriter with loop power supply. Radio Receiving Equipments RBA, RBB, RBC, or equivalent may be used. The AN/URA-8 and AN/URA-8A are electrically and mechanically interchangeable and differ only in contractual data.

RELATIONSHIP TO SIMILAR EQUIPMENT:

TECHNICAL DESCRIPTION:

Frequency Range: audio; with center frequency of either 1,000 cps or 2,550 cps

Type Modulation: fm

Type Reception: frequency-shift keying

Power Output:

Electron Tube Keyer: for keying 60-ma teletypewriter loop

Tone Signal: 12 mw into 600-ohm load

Audio Input:

Input Power: 60 uw to 60 mw

Frequency Shifts: 10 to 200 cps for 1,000-cps center frequency, narrow band; 200 to 1,000 cps for 2,500-cps center frequency, wide band

Impedance: 600 ohm, balanced or unbalanced

Maximum Keying Speed:

Single Telegraph Channel: 23 dot cps

Four-channel Multiplex Telegraph Signals: 100 dot cps

Tone Signals Frequencies: 595; 765; 935; 1,105; 1,275; 1,445; 1,615; 1,785 cps

Power Requirements: 160 w or 220 w; 105-v, 115-v, or 125-v 50- to 60-cy, 1-phase ac

Major Units:

1	CM-14/URR	5 $\frac{1}{8}$ " x 19" x 15 $\frac{1}{4}$ "	
2	CV-60/URR	5 $\frac{1}{8}$ " x 19" x 15 $\frac{1}{4}$ "	47 lbs
1	CM-22/URA-8A	5" x 17" x 17"	36 lbs
2	CV-89/URA-8A	5 $\frac{1}{4}$ " x 17" x 17"	47 lbs

TUBES, CRYSTALS, TRANSISTORS:

REFERENCE DATA AND LITERATURE:

NAVSHIPS 91339 (AN/URA-8)

NAVSHIPS 91278 (AN/URA-8A)

COMPARATOR-CONVERTER GROUP

AN/URA-17

1 March 1964

Cog. Serv: USN FSN: 5820-474-3975

USA Line Item No.:

USA

USN

USAF

USMC

STATUS OR TYPE CLASS.:

Std

Manufacturer: CKB (28959)

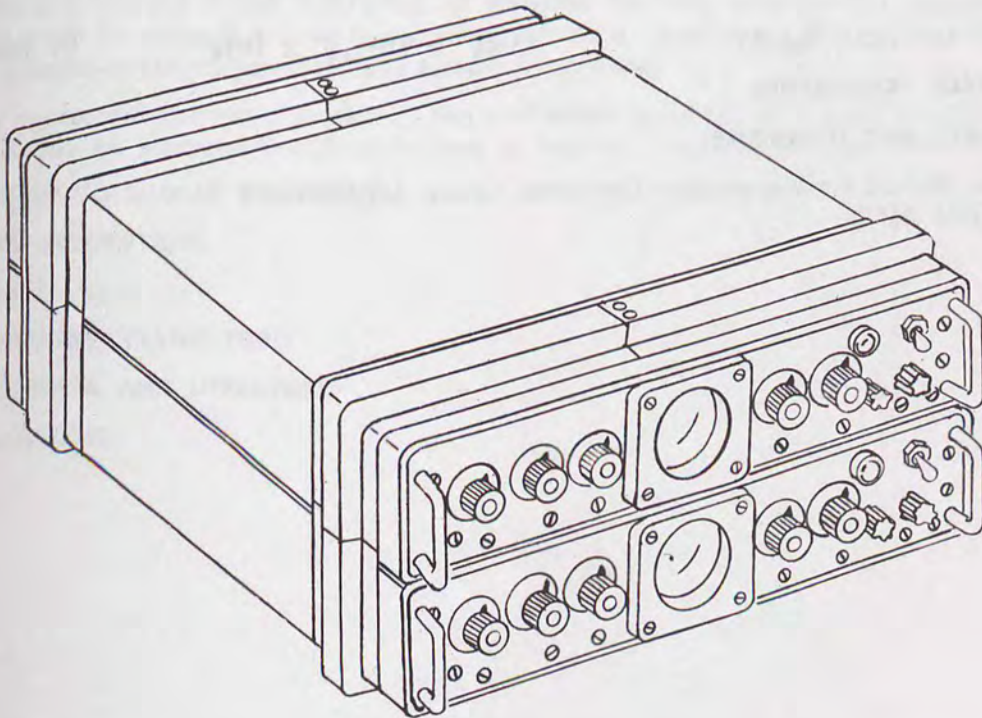
**FUNCTIONAL DESCRIPTION:**

The AN/URA-17 is designed to provide a link in the receiving end of a frequency shift communication system, in which telegraph or teletype mark-space characters are transmitted as rapid shifts above and below the center frequency of a radio frequency carrier. These fsk (frequency shift keyed) signals are translated by a standard communications receiver into an audio signal. The Comparator-Converter Group changes these signals into dc mark-space pulses for operation of a loop keying circuit of an automatic recording device. This method of communication provides the noise reduction advantages of frequency modulation for coded teletype-writer messages at speeds up to 400 wpm.

COMPARATOR-CONVERTER GROUP

AN/URA-17

RELATIONSHIP TO SIMILAR EQUIPMENT:

The AN/URA-17 performs the same functions as the AN/URA-8B. It is not electrically or mechanically interchangeable with the AN/URA-8B. The AN/URA-17 uses only a fraction of the power required for the AN/URA-8B because of its semiconductor type construction.

TECHNICAL DESCRIPTION:

Frequency Data:

Narrow Shift: 1000 cps mean frequency 10 to 200 cps shift

Wide Shift: 2550 cps mean frequency, 200 to 1000 cps shift

Input Impedance: 600 ohms

Output: Keys 60 ma circuit in teletypewriter receiver loop circuit

Operating Power Requirements: 105 to 125 vac, 50 to 400 cps, single phase, 60 w

Major Units:

2 CV-483/URA-17

3¹⁵/₃₂" x 16¹/₁₆" x 18⁷/₈"

27 lbs

TUBES, CRYSTALS, TRANSISTORS:

REFERENCE DATA AND LITERATURE:

Technical Manual for Comparator Converter Group AN/URA-17
NAVSHIPS 94028

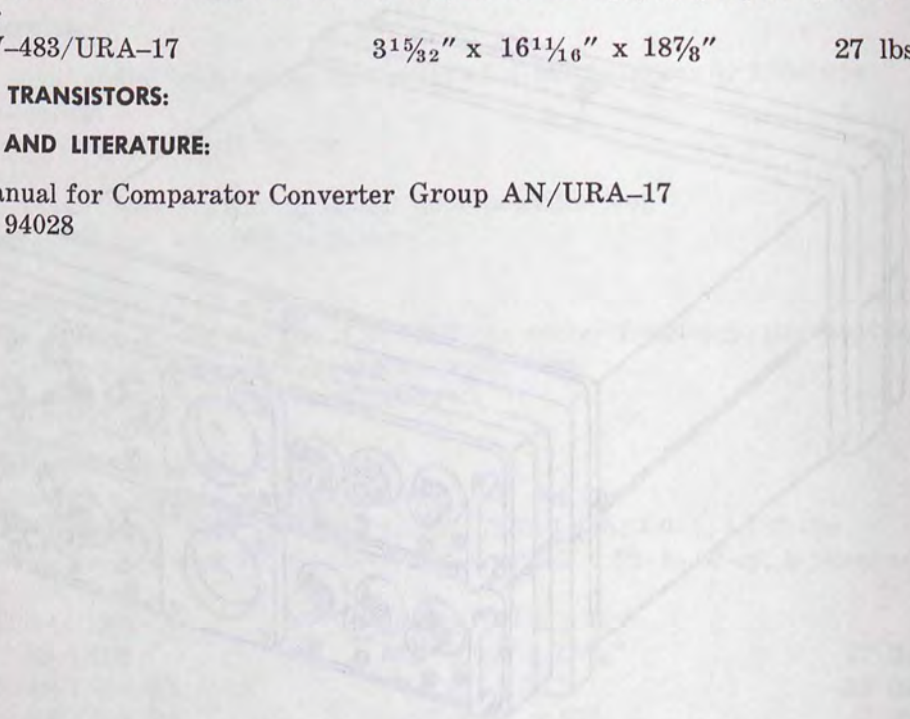

RADIO SET CONTROL GROUP

AN/URA-19

3 December 1958

Cog. Serv: USN FSN:

USA Line Item No.:

	USA	USN	USAF	USMC
STATUS OR TYPE CLASS.:			T/Std	

Manufacturer:

No Illustration Available

FUNCTIONAL DESCRIPTION:

Radio Set Control Group AN/URA-19 provides facilities that permit the calling of individual aircraft by normal ground-to-air communication apparatus. The group utilizes existing types of ground-to-air transmitters and airborne receivers.

This equipment relieves the pilot of the continuous monitoring of voice circuits. Ultimately, it will provide an emergency calling feature as well as a limited message capability.

RELATIONSHIP TO SIMILAR EQUIPMENT:**TECHNICAL DESCRIPTION:***Major Units:***TUBES, CRYSTALS, TRANSISTORS:****REFERENCE DATA AND LITERATURE:**

MIL-R-9542

REVISIONS

DESCRIPTION

NO.	DATE	DESCRIPTION
1	1965	...
2	1965	...
3	1965	...

1.1 SCOPE

1.2 REFERENCES

1.3 TERMINOLOGY

1.4 FUNCTIONAL DESCRIPTION

1.5 TECHNICAL DESCRIPTION

1.6 REFERENCES DATA AND LITERATURE

1.7 APPENDIX

MODULATOR-POWER SUPPLY GROUP

AN/URA-23, -23A

1 March 1964

Cog. Serv: USN FSN: AN/URA-23 5820-543-1215
AN/URA-23A 5820-543-1491

USA Line Item No.:

USA

USN

USAF

USMC

STATUS OR TYPE CLASS.:

Manufacturer: CCLX (82679)

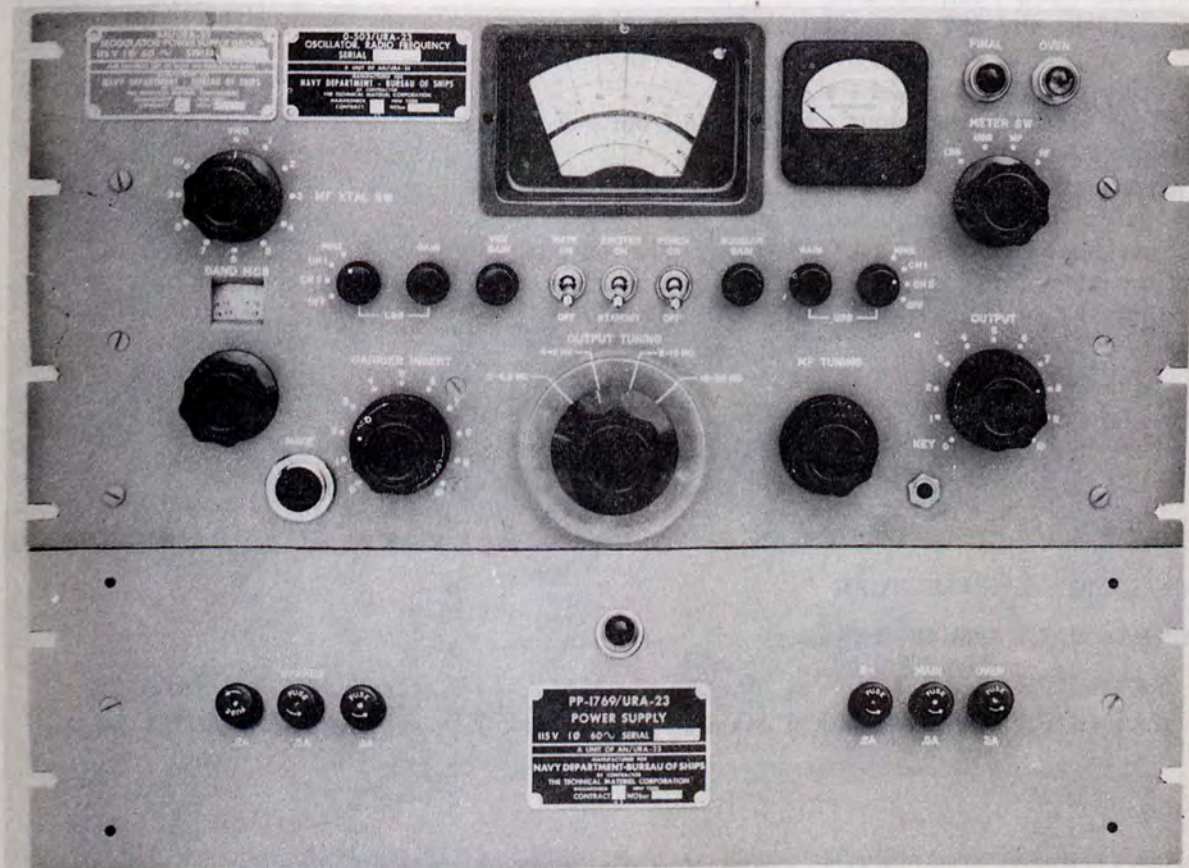

FUNCTIONAL DESCRIPTION:

These equipments are exciters permitting the transmission of any intelligence on single sideband or double sideband with or without carrier. Simultaneous or independent transmission of intelligence may be had on either upper or lower sideband.

AN/URA-23 was supplied as the single sideband exciter on early delivered models of AN/URT-17. Later deliveries contained the AN/URA-23A. The difference between the two equipments is in the rf oscillator.

MODULATOR-POWER SUPPLY GROUP

AN/URA-23, -23A

RELATIONSHIP TO SIMILAR EQUIPMENT:

AN/URA-23 is manufacturer's Model SBE-1. AN/URA-23A is manufacturer's Model SBE-2.

TECHNICAL DESCRIPTION:

Power Requirements: 115/220 v, 50-60 cps, single phase, 140 w

Frequency Range: 2-32 mc

Type of Emission: A1, A2, A3, A3a, A3b

Frequency Control: Crystal or external variable frequency oscillator

Crystal Oven Temperatures:

17 kc and 287 kc oscillator: 75 degrees C

mf and hf oscillator: 70 degrees C

Stability: 1 ppm for 24-hour period

Power Output: continuously adjustable from 0-3 w max

Output Impedance: 72 ohms

Carrier Suppression: at least 55 db from PEP level

Carrier Insertion: adjustable

Spurious Signals: at least 60 db below PEP output

Unwanted Sideband Rejection: 500 cps single tone at 60 db down

Audio Response: within 3 db, 350-3300 cps

Major Units:

For AN/URA-23A:

1	0-503/URA-23	8 $\frac{3}{4}$ " x 19" x 15"	35 lbs
---	--------------	-------------------------------	--------

1	PP-1769/URA-23	5 $\frac{1}{4}$ " x 19" x 11"	36 lbs
---	----------------	-------------------------------	--------

For AN/URA-23:

1	0-503A/URA-23	8 $\frac{3}{4}$ " x 19" x 15"	35 lbs
---	---------------	-------------------------------	--------

1	PP-1769/URA-23	5 $\frac{1}{4}$ " x 19" x 11"	36 lbs
---	----------------	-------------------------------	--------

TUBES, CRYSTALS, TRANSISTORS:

REFERENCE DATA AND LITERATURE:

NAVSHIPS 93162, Technical Manual for Modulator-Power Supply AN/URA-23

NAVSHIPS 93163, Technical Manual for Modulator-Power Supply AN/URA-23A

AN/URA-type
ANTENNA COUPLERCU-656/U, CU-873/U,
and CU-874/U

1 March 1964

Cog. Serv: USN FSN:

USA Line Item No.:

USA

USN

USAF

USMC

STATUS OR TYPE CLASS.:

Std

Manufacturer:

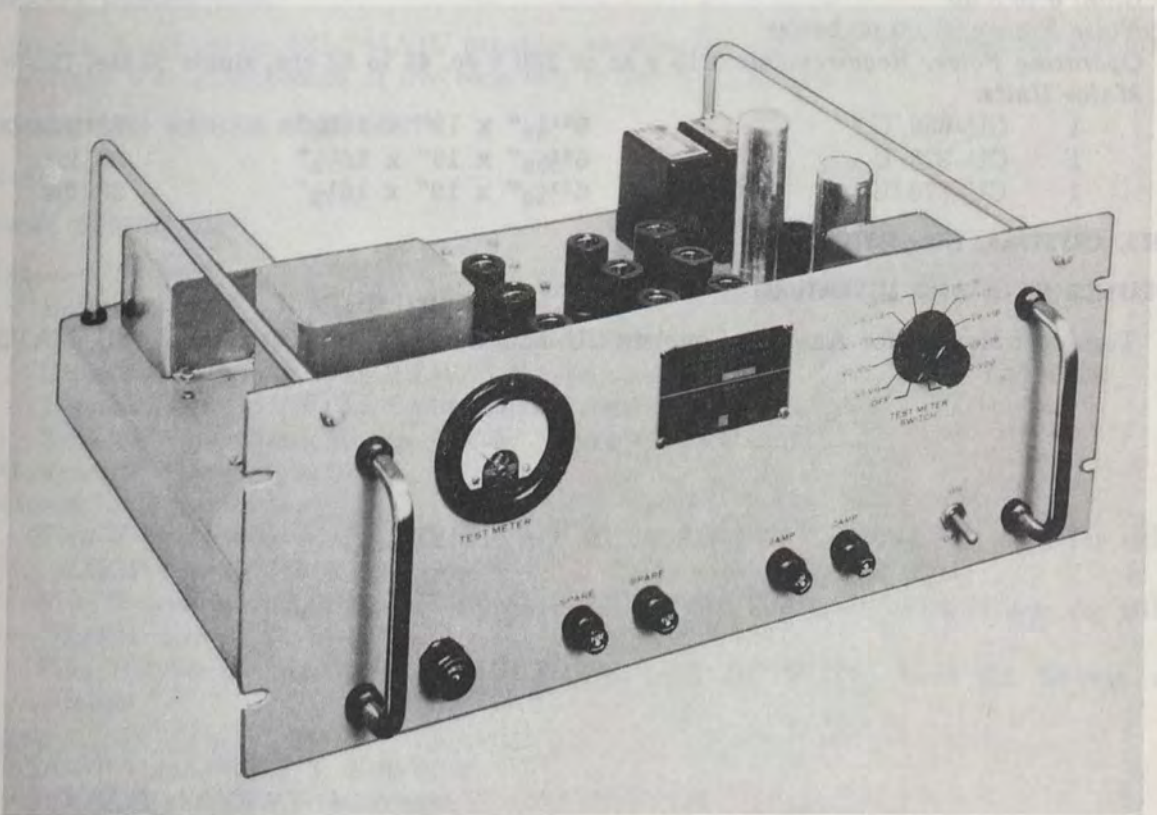
**FUNCTIONAL DESCRIPTION:**

The CU-656/U, CU-783/U, CU-874/U are physically and electrically similar. They provide optimum coupling between a single antenna and as many as eight receivers. Design considerations include selection of circuits and choice of components providing a low voltage standing wave ratio, a wide frequency range, a high attenuation of out of band frequencies, a minimum noise figure, minimum intermodulation, a high degree of isolation between individual outputs, an overall power gain and high reliability.

AN/URA-type
ANTENNA COUPLER

CU-656/U, CU-873/U,
and CU-874/U

RELATIONSHIP TO SIMILAR EQUIPMENT:

Antenna Couplers CU-656/U, CU-873/U, and CU-874/U are electrically similar. Antenna Couplers CU-656/U and CU-873/U each have a 70 ohm input, CU-874/U has a 150 ohm balanced input. The units are physically similar except the CU-656/U utilizes type C input and output connectors while CU-873/U and CU-874/U utilize type N input and output connectors.

TECHNICAL DESCRIPTION:

Frequency Range: 2.0 to 32 mc

Number of Outputs: 8

Gain: 0 to 3 db

Noise Figure: 6 db or better

Operating Power Requirements: 115 v ac or 230 v ac, 48 to 62 cps, single phase, 125 w.

Major Units:

1	CU-656/U	6 ³ / ₃₂ " x 19" x 16 ¹ / ₂ "	33 lbs
1	CU-873/U	6 ³ / ₃₂ " x 19" x 16 ¹ / ₂ "	33 lbs
1	CU-874/U	6 ³ / ₃₂ " x 19" x 16 ¹ / ₂ "	33 lbs

TUBES, CRYSTALS, TRANSISTORS:

REFERENCE DATA AND LITERATURE:

Technical Manual for Antenna Couplers CU-656/U, CU-873/U, and CU-874/U, NAVSHIPS 93804(A)

AN/URA-type
ANTENNA MULTICOUPLER

CU-784A/U

1 March 1964

Cog. Serv: USN FSN:

USA Line Item No.:

USA

USN

USAF

USMC

STATUS OR TYPE CLASS.:

Manufacturer: Westrex Co Div of Litton Systems Inc

No Illustration Available

FUNCTIONAL DESCRIPTION:

Antenna Multicoupler CU-784A/U provides coupling between five VLF antennas and fifteen VLF receivers with a maximum of five receivers to any one antenna.

RELATIONSHIP TO SIMILAR EQUIPMENT:

None.

TECHNICAL DESCRIPTION:*Antenna Inputs:*

- Broadband whip (WHIP I), N-type receptacle
- Tunable loop (LOOP I), 5-pin female receptacle
- Broadband trailing wire (T.W.), N-type receptacle
- Tunable loop (LOOP II), 5-pin female receptacle
- Broadband 50-ohm antenna (50 Ω), N-type receptacle

Frequency Range: 14.6 to 38.0 kc*Outputs to Receivers:*

- Five N-type receptacles (ANTENNA I MULTICOUPLER OUTPUTS) used for either LOOP I or WHIP I operation.
- Five N-type receptacles (ANTENNA II MULTICOUPLER OUTPUTS) used for either LOOP II or T.W. operation.
- Five N-type receptacles (50 Ω MULTICOUPLER OUTPUTS) used for 50-ohm antenna.

Gain:

- LOOP I and WHIP I: 4 db min
- LOOP II and T.W.: 18 db min
- 50 Ω Antenna: 4 db min

Operating Power Requirements: 117 v, 60 cps, 1 phase; 0.25 amps*Major Units:*

1	CU-784A/U	10" x 14 $\frac{1}{8}$ " x 11 $\frac{11}{16}$ "	31 $\frac{3}{4}$ lbs
---	-----------	---	----------------------

TUBES, CRYSTALS, TRANSISTORS:**REFERENCE DATA AND LITERATURE:**

NAVSHIPS 94184, Technical Manual for Antenna Multicoupler CU-784A/U

UNIVERSITY OF CALIFORNIA
LIBRARY
DUE DATE
1953-10-15

THE UNIVERSITY OF CALIFORNIA
LIBRARY
DUE DATE
1953-10-15

THE UNIVERSITY OF CALIFORNIA
LIBRARY
DUE DATE
1953-10-15

THE UNIVERSITY OF CALIFORNIA
LIBRARY
DUE DATE
1953-10-15

THE UNIVERSITY OF CALIFORNIA
LIBRARY
DUE DATE
1953-10-15

THE UNIVERSITY OF CALIFORNIA
LIBRARY
DUE DATE
1953-10-15

THE UNIVERSITY OF CALIFORNIA
LIBRARY
DUE DATE
1953-10-15

AN/URA-type
FREQUENCY SHIFT CONVERTER

CV-62/U

1 March 1964
 Cog. Serv: USA FSN: 5815-337-7277
 USA Line Item No.: 611482

USA USN USAF

STATUS OR TYPE CLASS.: Std-A

Manufacturer: Radio Frequency Labs, Inc

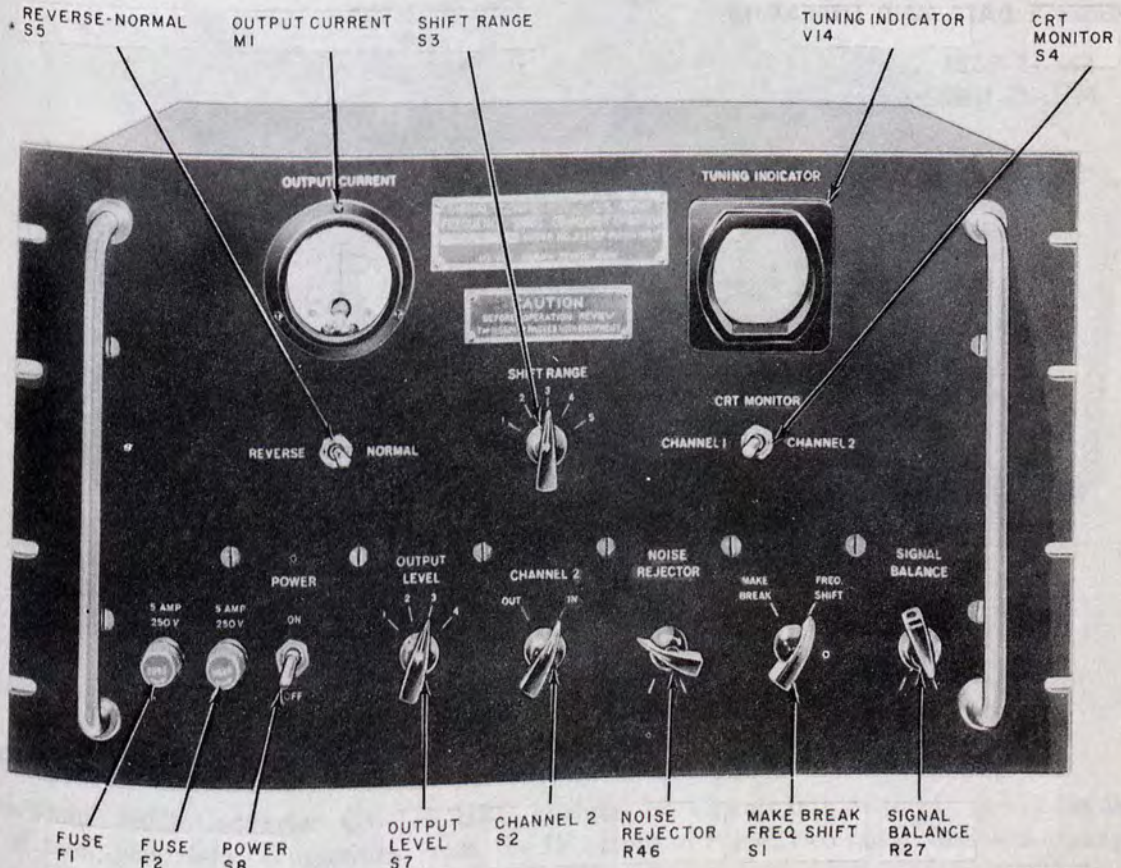

CV-62/U

FUNCTIONAL DESCRIPTION:

Frequency Shift Converter CV-62/U is used to convert af, fsk signals or make-and-break teletypewriter signals into dc output pulses for the operation of a teletypewriter.

It is intended for use at the receiving terminal of a radioteletype system and is arranged for rack-and-panel mounting.

AGO 10476A

AN/URA-type
FREQUENCY SHIFT CONVERTER

CV-62/U

RELATIONSHIP TO SIMILAR EQUIPMENT:

TECHNICAL DESCRIPTION:

Type of Communication Circuits: Dual-diversity (or single received signal) fsk, center frequency of 2,500 cy with shifts of 100 to 1,100 cps or dual-diversity (or single received signal) for make-and-break signal in range of 500 to 5,000 cps or conversion of single received signal (using external discriminator) with center frequency between 850 and 5,000 cps

Power Requirements: 130 va, 115-v (+10%), 50/60 cy, 1-phase ac

Major Units:

1 6V-62/U

10 $\frac{1}{2}$ " x 13 $\frac{1}{2}$ " x 19"

60 lbs

TUBES, CRYSTALS, TRANSISTORS:

REFERENCE DATA AND LITERATURE:

TM 11-5524

MIL-C-10232

AN/URA-type
FREQUENCY SHIFT CONVERTER

CV-116/URR

1 March 1964

Cog. Serv: USA FSN: 5815-503-2600

USA Line Item No.: 611484

	USA	USN	USAF
STATUS OR TYPE CLASS.:	Std-A		Std
Manufacturer:	Hoffman Laboratories, Inc		



CV-116/URR

FUNCTIONAL DESCRIPTION:

Frequency Shift Converter CV-116/URR changes fsk signals into dc pulses to key the loop circuit of teletypewriters. It operates from the IF output of one or two radio receivers arranged in either space of frequency diversity.

This equipment consists of the converter unit, cables, and accessories.

The converter unit is designed for continuous duty and is used in a radio-teletype communication system. In addition to the CV-116/URR, a typical system consists of a teletypewriter, a control unit, a frequency-shift keyer, a radio transmitter, two radio receivers, two or three antennas (one or two receiving and one transmitting) and another teletypewriter.

This equipment is used with such sets as Radio Receiving Set AN/FRR-38.

RELATIONSHIP TO SIMILAR EQUIPMENT:**TECHNICAL DESCRIPTION:**

Operating Speed: 100 dot-cps

**AN/URA-type
FREQUENCY SHIFT CONVERTER**

CV-116/URR

Power Requirements: 200 w 115-v 50/60-cy 1-phase ac

Major Units:

1 CV-116/URR

8 $\frac{3}{4}$ " x 17" x 19"

65 lbs

TUBES, CRYSTALS, TRANSISTORS:

REFERENCE DATA AND LITERATURE:

TM 11-2241

MIL-F-10532

AN/URA-type
SINGLE SIDEBAND CONVERTER

CV-157/URR

1 March 1964

Cog. Serv: USA FSN: 5820-503-2594

USA Line Item No.: 611494

USA

USN

USAF

USMC

STATUS OR TYPE CLASS.:

Std-A

Manufacturer: Dubrow Development Co
Hoffman Laboratories, Inc
Munston Manufacturing & Service, Inc

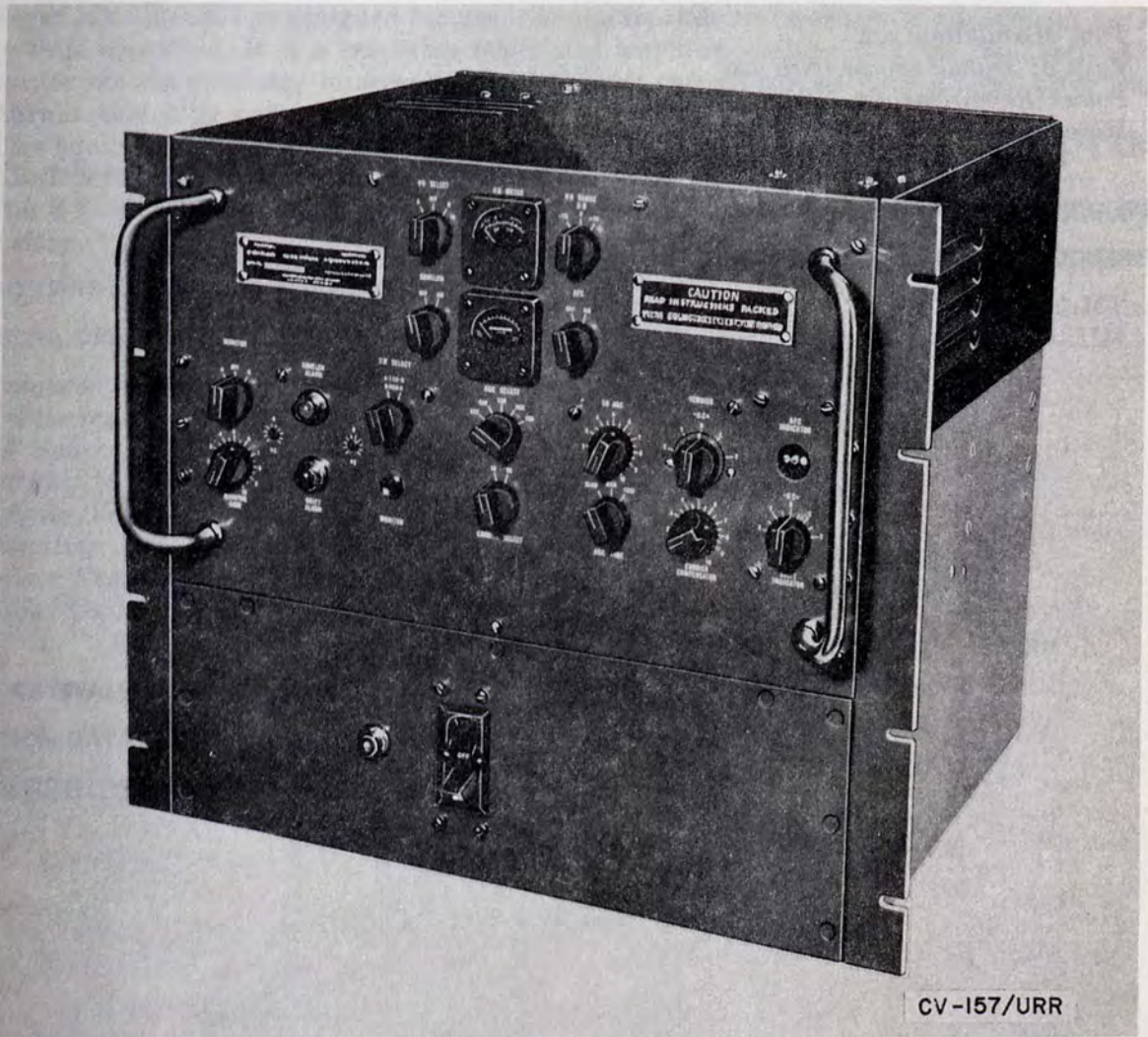

CV-157/URR

AN/URA-type

SINGLE SIDEBAND CONVERTER

CV-157/URR

FUNCTIONAL DESCRIPTION:

Single Sideband Converter CV-157/URR is used at the receiving end of a radio communication system that operates in a single-sideband reduced carrier transmission.

It may also be used as an aid in the reception of am double-sideband signals under severe atmospheric conditions.

This equipment consists of a single operating component arranged for rack-mounting and is intended for the handling of heavy traffic at fixed installations. In such applications, operating with a receiver, it is used to feed carrier terminal equipment that handles several channels of telephone, teletypewriter, and facsimile.

RELATIONSHIP TO SIMILAR EQUIPMENT:

TECHNICAL DESCRIPTION:

Type Modulation: am

Type of Signal: ssb or twin ssb

Power Requirements: 250 w, 105-125/210-250-v 50/60-cy ac

Major Units:

1 CV-157/URR

104 lbs

TUBES, CRYSTALS, TRANSISTORS:

REFERENCE DATA AND LITERATURE:

TM 11-266

MIL-C-11957A

AN/URA-type
KEYER**KY-43/URT**

1 March 1964

Cog. Serv: USN FSN:

USA Line Item No.:

USA

USN

USAF

USMC

STATUS OR TYPE CLASS.:

L/Std

Manufacturer: Munston Manufacturing and Service Inc

No Illustration Available

FUNCTIONAL DESCRIPTION:

Keyer KY-43/URT is designed for use with appropriate transmitters to adapt them for frequency-shift operation. It is a reactance modulated amplifier used to shift the frequency of the transmitter master oscillator in accordance with direct current signals from a polar keyer which is, in turn, actuated by a standard teletypewriter.

This equipment is designed primarily for use with, Transmitting Equipment TAB-5, TAB-6, or TAB-7. Provision is made for mounting of the keyer on the TAB-series transmitter.

The KY-43/URT is basically identical with Keyer KY-43A/URT except for minor changes in circuitry.

RELATIONSHIP TO SIMILAR EQUIPMENT:**TECHNICAL DESCRIPTION:***Frequency Range:* 100 to 555 kc*Frequency Shift Range:* 170 cps*RF Source:* TAB-5, -6, -7 master oscillator*Output:* to TAB-5, -6, -7 master oscillator through coaxial cable*Keying Voltage:* Polar Keyer output of 40 to 120 v*Mounting Data:* left-hand side of TAB-5, -6, -7 exciter*Power Requirements:* 110 w, 220-v, 60-cy 1-phase ac*Major Units:*

1 KY-43/URT

22½" x 8" x 15½"

34 lbs

TUBES, CRYSTALS, TRANSISTORS:**REFERENCE DATA AND LITERATURE:**

NAVSHIPS 91138

AN/URA-type
KEYER

KY-43A/URT

1 March 1964

Cog. Serv: USN FSN: 5805-665-1514

USA Line Item No.:

USA

USN

USAF

STATUS OR TYPE CLASS.:

Std

Manufacturer: Fidelity Amplifier Co

FUNCTIONAL DESCRIPTION:

Keyer KY-43A/URT is designed for use with appropriate transmitters to adapt them for frequency-shift operation. It permits the impression of intelligence on a radio frequency carrier by the frequency-shift method in order to minimize the effects of fading, noise interference, and static disturbances on the receiving equipment.

The KY-43A/URT is a reactance-modulated amplifier used to shift the frequency of the transmitter master oscillator in accordance with the direct current polar mark and space impulses from a teletypewriter keyer. It employs a reactance tube circuit to convert the polar dc signals into a rf carrier shift that is symmetrical with respect to the assigned frequency.

This equipment is designed primarily for use with Transmitting Equipment TAB-5, TAB-6, or TAB-7. The keyer consists of a rectangular chassis and front panel mounted on a plate for mounting of the unit on the side of the master oscillator section of the TAB-series transmitters. All controls for the keyer are located on the front panel.

The KY-43A/URT is basically identical with Keyer KY-43/URT except for minor changes in circuitry.

RELATIONSHIP TO SIMILAR EQUIPMENT:**TECHNICAL DESCRIPTION:***Frequency Range:* 100 to 555 kc*Frequency Shift Range:* 170 cps (nominal)*Type Modulation:* fm (F1)*Type Signal:* fsk*RF Source:* TAB-5, -6, -7 master oscillator*Output:* to TAB-5, -6, -7, master oscillator through coaxial cable*Keying Speed Maximum:* at least 60 wpm*Keying Voltage:* dc polar ± 40 to ± 120 v*Keying Input Impedance:* 3,800 ohms*Mounting Data:* left-hand side of TAB-5, -6, -7 exciter*Power Requirements:* 110 w, 220-v $\pm 10\%$ 60-cy 1-phase ac*Major Units:*

1 KY-43A/URT

22½" x 8" x 15½"

34 lbs

TUBES, CRYSTALS, TRANSISTORS:**REFERENCE DATA AND LITERATURE:**

NAVSHIPS 91645

MIL-K-15651

AN/URA-type
KEYER

KY-43A/URT

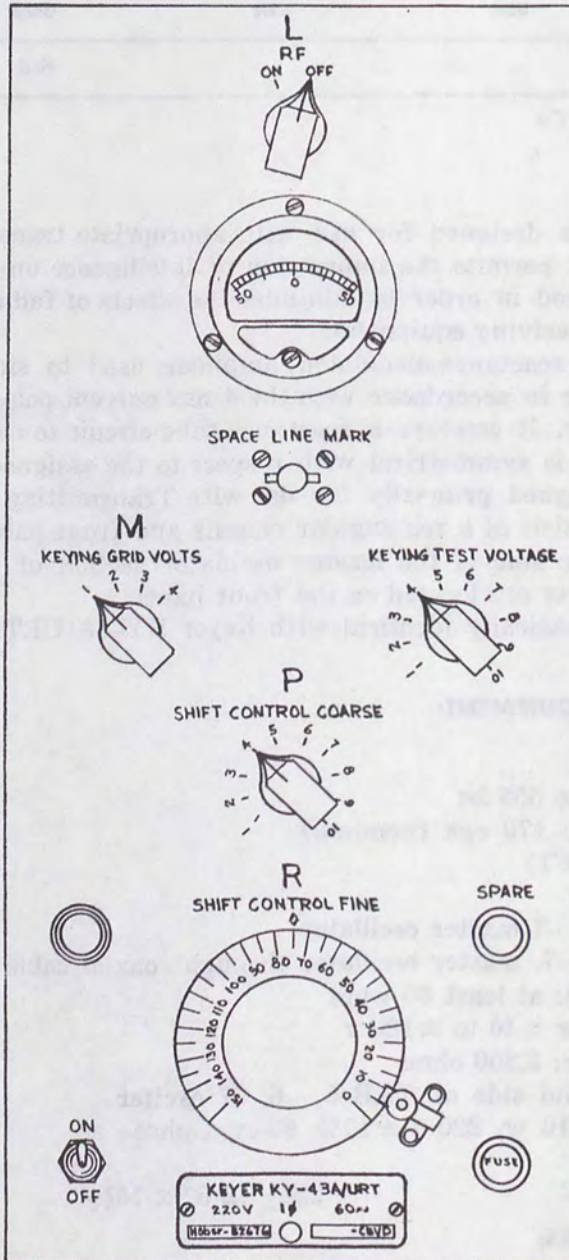

KY-43A/URT

AN/URA-type
RADIO SIGNAL DISTRIBUTION PANEL

SB-1510/FRR

1 March 1964
 Cog. Serv: USN FSN:
 USA Line Item No.:

USA

USN

USAF

USMC

STATUS OR TYPE CLASS.:

Manufacturer:

FUNCTIONAL DESCRIPTION:

Radio Signal Distribution Panel SB-1510/FRR is used to interconnect three receivers to either of two radio test sets, enabling the operator to test any receiver with any test set.

Three-position coaxial switches connect each receivers input to one of three signal sources:

- (1) The receivers associated antenna
- (2) The receiver selector switch of test set number one
- (3) The receiver selector switch of test set number two

Three-position coaxial switches connect the output of each test set to one of the three receiver inputs; while two-position coaxial switches choose the output of the test set, either rf or noise. In addition, three-position coaxial switches connect each of three oscilloscopes to receive synchronizing triggers from either test set, as necessary.

RELATIONSHIP TO SIMILAR EQUIPMENT:**TECHNICAL DESCRIPTION:**

Frequency Range: 2 to 32 mc

Input and Output Impedance: 70 ohms

Voltage Standing Wave Ratio: 1:1.1 or less

Switch Crosstalk: -100 db

Attenuation: less than 0.5 db

Ambient Temperature Range: 0°C. to 50°C.

Major Units:

TUBES, CRYSTALS, TRANSISTORS:**REFERENCE DATA AND LITERATURE:**

NAVSHIPS 94281, Technical Manual for Radio Signal Distribution Panel SB-1510/FRR

MIL-HDBK-161A/TM11-487A-3/NAVEXOS P-2058/TO 31-3-73

AN/URA-type
RADIO SIGNAL DISTRIBUTION PANEL

SB-1510/FRR

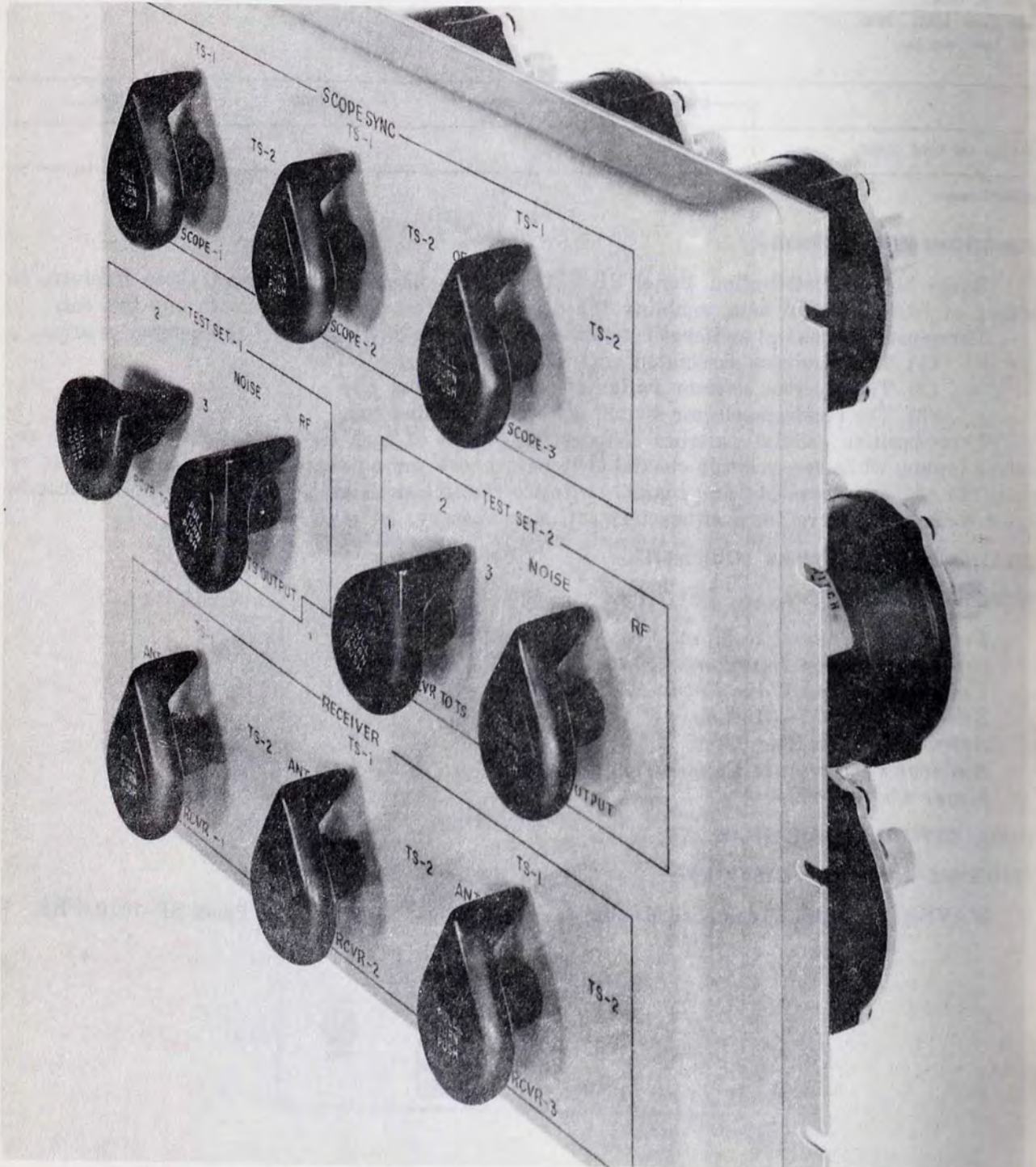

RADIO SET
AN/URC-4

1 March 1964

Cog. Serv: USAF FSN: 5820-352-0015

USA Line Item No.: 647800

USA

USN

USAF

STATUS OR TYPE CLASS.:

L/Std

Manufacturer: Philharmonic Radio and Television Corp

FUNCTIONAL DESCRIPTION:

Radio Set AN/URC-4 is a portable, hand-operated, ultra-high frequency and very-high frequency unit designed to furnish two-way air-to-ground and point-to-point communication in emergency rescue situations. It is dropped from aircraft in a watertight container which floats on the surface of the water.

The transmitter is crystal-controlled and, depending upon the crystal in use, operates on any preset frequency within the given bands. The receiver is of the superregenerative type and can be tuned independently of the transmitter to any frequency within the given range.

The antenna is located in the top of the radioset from where it can be quickly extended.

This equipment may be operated while in motion and will function continuously for 24 hours in cycles of 5 minutes for transmitting and 5 minutes for receiving.

The unit can also be used for emergency airdrome traffic control.

Radio Carrier Vest AN/URC-4 and Droppable Kit AN/URC-4 are part of the radio set and are supplied in addition to the basic components if required.

RELATIONSHIP TO SIMILAR EQUIPMENT:**TECHNICAL DESCRIPTION:***Frequency Range:*

Preset Frequency in mc: 120 to 130

Harmonic Operation: 240 mc to 260 mc

Number of Crystal-controlled Preset Frequencies: 1*Type Modulation:* am*Type Emission and Reception:* voice, tone, or mcw*Power Output:*

Receiver: 75 mw

Transmitter: 35 mw

Power Requirements:

45 ma Plate Supply: 125-v dc

520 ma Filament Supply: 125-v dc

Battery Life: 24 hr when operated in cy of 5 minutes transmitting and 5 minutes receiving

Major Units:

1

22" x 13"

20 lbs

TUBES, CRYSTALS, TRANSISTORS:**REFERENCE DATA AND LITERATURE:**

TO 16-30URC4-2

TO 12R2-2URC4-1

RADIO SET

AN/URC-4

TO 12R2-2URC4-2
TO 12R2-2URC4-4
MIL-R-6373; R-7240

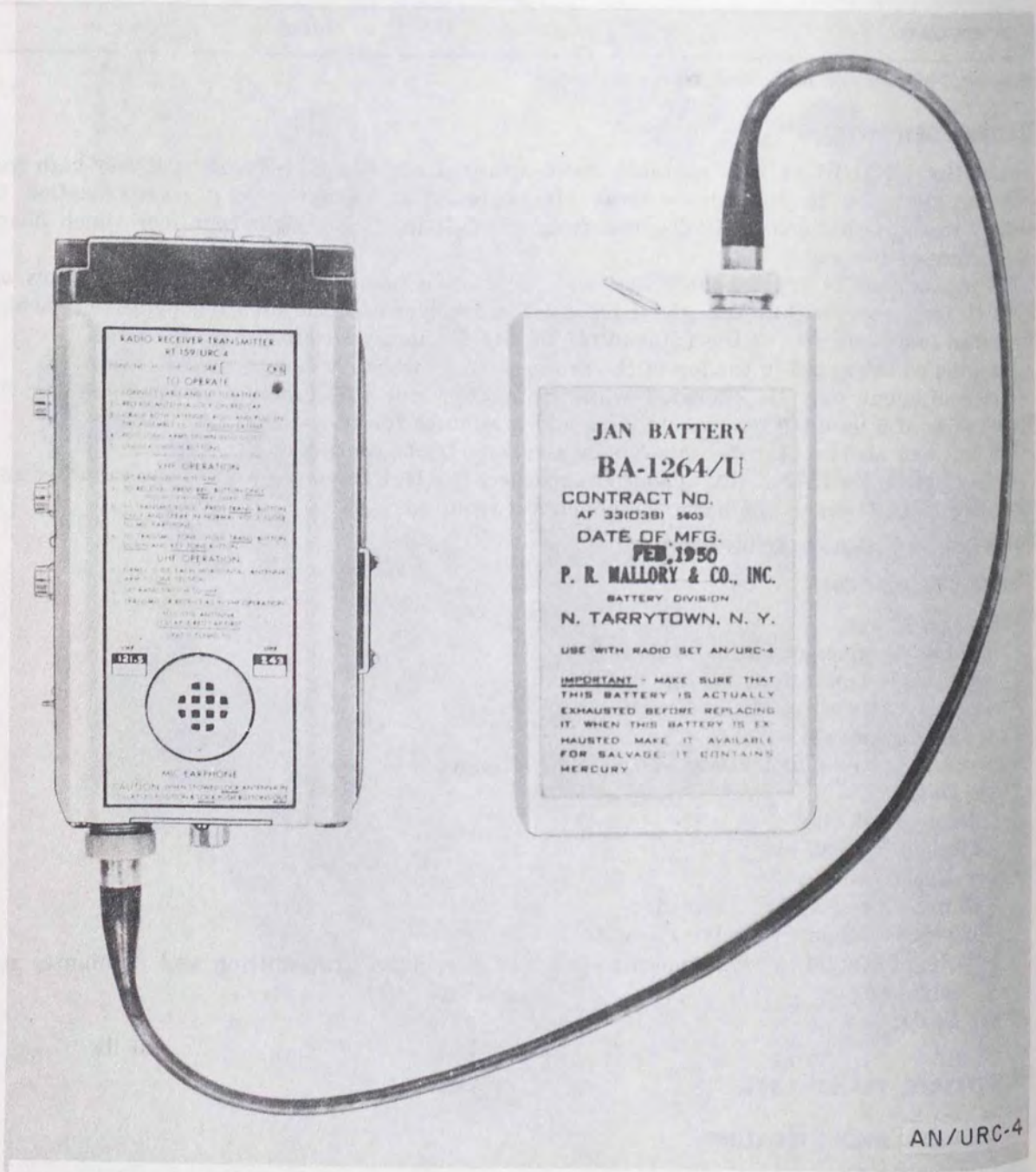

RADIO RECEIVER TRANSMITTER
RT 159 URC 4

TO OPERATE

1. CHECK BATTERY AND SET OPERATING
2. CHECK FREQUENCY AND BAND
3. CHECK MODE (RECEIVE, TRANSMIT, OR
4. CHECK TONE AND PULSE RATE

VHF OPERATION

1. SET RADIO TO VHF USE
2. TO RECEIVE PRESS REC. BUTTON ON
3. TO TRANSMIT PRESS RADIO TALK/BUTTON
4. TO TRANSMIT TONE PRESS TALK/BUTTON
5. TO TRANSMIT PULSE PRESS TALK/BUTTON

UHF OPERATION

1. RADIO IS SET TO RECEIVE UHF SIGNALS
2. TO RECEIVE PRESS REC. BUTTON
3. TO TRANSMIT PRESS TALK/BUTTON

MIC. EARPHONE

AUTOMATICALLY LOCKS AND UNLOCKS
ANTENNA COILS TO SAVE POWER AND TO

JAN BATTERY
BA-1264/U

CONTRACT NO.
AF 3310381 5603

DATE OF MFG.
FEB, 1950

P. R. MALLORY & CO., INC.
BATTERY DIVISION
N. TARRYTOWN, N. Y.

USE WITH RADIO SET AN/URC-4

IMPORTANT - MAKE SURE THAT
THIS BATTERY IS ACTUALLY
EXHAUSTED BEFORE REPLACING
IT. WHEN THIS BATTERY IS EX-
HAUSTED MAKE IT AVAILABLE
FOR SALVAGE. IT CONTAINS
MERCURY.

AN/URC-4

RADIO SET
AN/URC-11

1 March 1964

Cog. Serv: USAF FSN:

USA Line Item No.:

USA

USN

USAF

STATUS OR TYPE CLASS.:

A/Std

Manufacturer: Philharmonic Radio and Television Corp

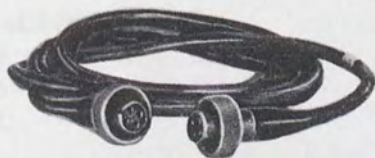

AN/URC-11

FUNCTIONAL DESCRIPTION:

Radio Set AN/URC-11 is a portable, subminiature, hand-operated, ultra-high frequency receiver-transmitter used for two-way communication between distressed personnel and searching aircraft.

RADIO SET

AN/URC-11

This equipment can operate on any preset frequency within the band, and its receiver portion can be tuned, independently of the transmitter, to any frequency within the specified range.

The radio set uses a one-half length telescopic antenna that is collapsible and storable within the receiver-transmitter case.

RELATIONSHIP TO SIMILAR EQUIPMENT:

TECHNICAL DESCRIPTION:

Frequency Range in mc: 240 to .260

Type Modulation: am

Type Reception and Emission: A3 (voice, tone)

Power Output:

Transmitter: 75 mw

Receiver: 25 mw

Operational Range: line of sight

Power Requirements:

Power Source: Battery BA-1315/U

Battery Life: 24 hr of continuous operation in cy of 5 minutes transmitting and 5 minutes receiving

Data: 1.25 v, 550 ma dc; 120 v, 35 ma dc (continuous operation) 550 ma at 1.25-v dc; 35 ma at 120-v dc for continuous operation.

Major Units:

TUBES, CRYSTALS, TRANSISTORS:

REFERENCE DATA AND LITERATURE:

TO 12R2-2URC11-1

TO 12R2-2URC11-2

TO 12R2-2URC11-4

MIL-R-8178 (USAF)

RADIO SET
AN/URC-32

15 March 1962

Cog. Serv: USN FSN:

USA Line Item No.:

USA

USN

USAF

USMC

STATUS OR TYPE CLASS.:

Manufacturer: COL (13499)

No Illustration Available

FUNCTIONAL DESCRIPTION:

Radio Set AN/URC-32 is a manually operated single sideband transmitter-receiver used primarily for transmission and reception on upper side band, lower sideband, or two independent sidebands, with separate audio and IF channels for each side band. Provisions are also included for compatible am (carrier reinserted), cw, or fsk operation. The 2-30 mc frequency range is covered in four bands, the desired operating frequency being set by 1 kc increments on a direct reading frequency counter. Frequency accuracy and stability are controlled by a self-contained frequency standard. Provisions are included for using an external frequency standard such as an AN/URQ-9.

RELATIONSHIP TO SIMILAR EQUIPMENT:

TECHNICAL DESCRIPTION:

Frequency Range: 2-30 mc*Mode:* cw telegraphy (A1)

Double sideband, full carrier (A3) on receive

Single sideband, reduced carrier (A3a)

Two independent sidebands, reduced carrier (A3b)

Composite transmission (A9)

Single sideband, full carrier (A9a) on transmit

Frequency shift telegraphy (F1)

Frequency Stability: 1 part in 10^6 per month and 1 part in 10^8 per day under all ambient conditions, using the internal frequency standard.*Receiver Sensitivity:* 1 μ v for 10 db signal-plus-noise to noise ratio.*Receiver Selectivity:*

3 kc bandwidth on either sideband

6 kc bandwidth on am

Receiver audio distortion: Less than 5 percent*Transmit Power Output:*

(A1) 500 w

(A9a) 125 w carrier power

(A3a) 500 w PEP

(A3b) 500 w PEP total

(F1) 500 w

Distortion on transmit: 35 db below PEP output (3d order distortion)

RADIO SET

AN/URC-32

Carrier suppression: 45 db below PEP output

Undesired sideband suppression: 35 db below PEP output

Audio inputs:

USB Line —38 to +8 dbm into 600 ohms balanced

LSB Line —38 to +8 dbm into 600 ohms balanced

Microphone Standard high impedance dynamic microphone

Audio Outputs:

USB Line +14 to —34 dbm (adjustable) into 600-ohms balanced

LSB Line +14 to —34 dbm (adjustable) into 600-ohms balanced

Phones: Standard 600-ohm headphones

Speaker 3 w max into 3-4 ohm or 600-ohm speaker

Receiver RF Input Impedance: 50 ohms unbalanced

Transmit RF Output Impedance: 50 ohms unbalanced

Power Source Requirements: 115/230 v, 60 cy, single phase, 1500 w

Major Units:

1 AN/URC-32

73" x 21⁷/₈" x 20⁷/₈"

390 lbs

TUBES, CRYSTALS, TRANSISTORS:

REFERENCE DATA AND LITERATURE:

NAVSHIPS 93285(A), Technical Manual for Radio Set AN/URC-32

RADIO SET

AN/URC-34, -34X

15 March 1962
 Cog. Serv: USN FSN:
 USA Line Item No.:

USA

USN

USAF

USMC

STATUS OR TYPE CLASS.:

Manufacturer: CBHT (74096)

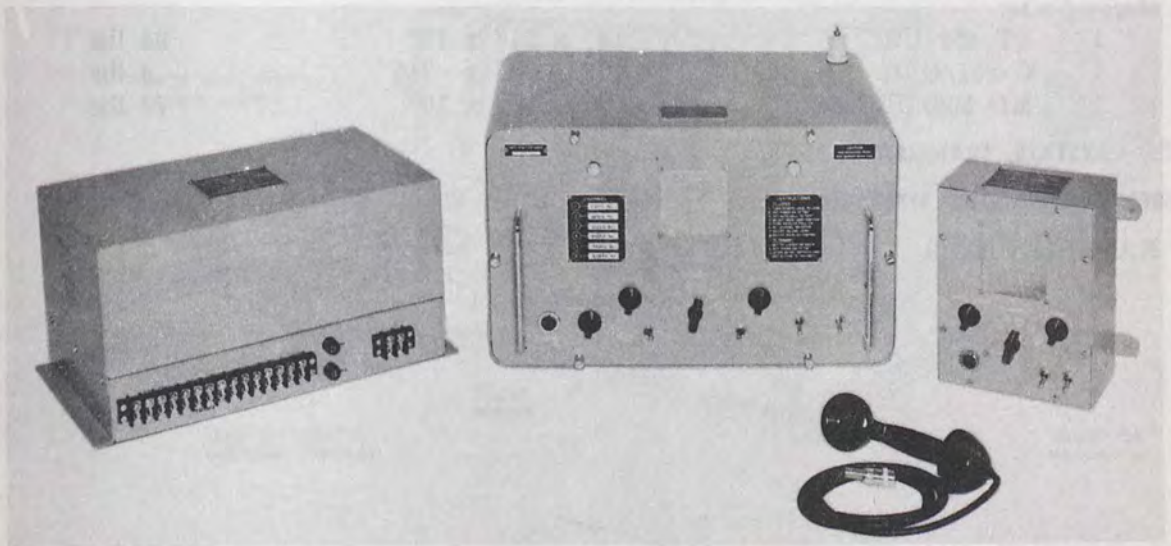
**FUNCTIONAL DESCRIPTION:**

These equipments are complete operating radio telephone systems, for two-way voice communication shipboard or shore-station use. Automatic channel selection of six pretuned frequency channels is provided. The radio set includes a remote control unit that contains all accessory controls for operating all functions of the radio set. The remote control unit includes the transmitting and receiving handset, and a loudspeaker for the reception of incoming calls.

RELATIONSHIP TO SIMILAR EQUIPMENT:

Radio Sets AN/URC-34 and AN/UPC-34X are functionally similar, differing only in power supply voltages.

TECHNICAL DESCRIPTION:

Type of Transmission and Reception: A3 (telephone), 6 kc bandwidth Frequency Range (transmit and receive)

All Six Channels: 2.0-9.0 mc

Alternate Arrangements:

Two Channels: 2-4 mc band

Four Channels: 4-7 mc band

RADIO SET

AN/URC-34, -34X

Four Channels: 2-4 mc band

Two Channels: 7-9 mc band

Transmitter Power: 75 w*Modulation:* The transmitter is capable of providing at least 95 percent modulation*Receiver Power Output:* 2 w or more with less than 10 percent distortion*Receiver Sensitivity:* 3 μ v—30 percent modulation (6 db signal-to-noise ratio) for 100 mw audio output*Operating Power Requirements:* 250 w receiver; 500 w receiver*Power Supply (MD-337/URC-34X):* Input 115 v dc*Power Supply (MD-336/URC-34):* Input 115 v 60 cps, single phase*Major Units:*

1	RT-452/URC	14" x 21" x 15"	34 lbs
1	C-251/URC	10" x 8" x 7½"	5 lbs
1	MD-336/URC-34	9" x 18" x 10"	70 lbs

TUBES, CRYSTALS, TRANSISTORS:**REFERENCE DATA AND LITERATURE:**

NAVSHIPS 93349

RADIO SET
AN/URC-35

15 March 1962
Cog. Serv: USN FSN:
USA Line Item No.:

	USA	USN	USAF	USMC
STATUS OR TYPE CLASS.:		P/Std		
Manufacturer:				

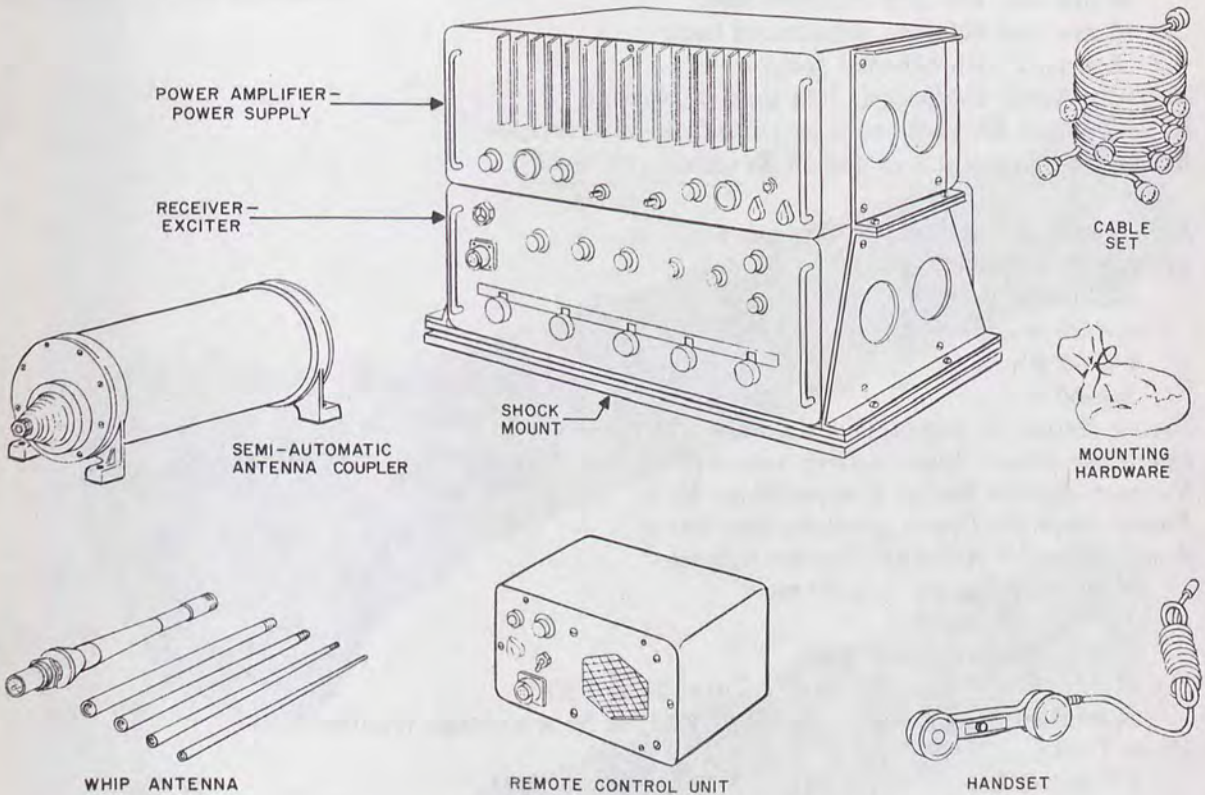

FUNCTIONAL DESCRIPTION:

Radio Set AN/URC-35 is a single sideband (ssb) and amplitude modulation (am) transceiver operable over the frequency range of 2 to 30 megacycles. Three operating modes: upper sideband (usb), lower sideband (lsb), and am are provided. A remote control unit and local operating controls permit both remote and local operation in all of the operating modes. Any one of three antennas can be used with the radio set: a 15-foot probe or whip, a 25-foot centered whip, or a 35-foot whip. Although designed primarily for mobile operation, the AN/URC-35 is supplied with shock-mounts to enable permanent installation in a shipboard or ground communications system. An internal battery provides dc power when the radio set is used in a mobile application.

RADIO SET

AN/URC-35

RELATIONSHIP TO SIMILAR EQUIPMENT:

TECHNICAL DESCRIPTION:

Frequency Range: 2 to 30 mc in 1-kc increments

Frequency Stability: 1 part in 10^7 per week

Modes of Operation: usb, lsb, am

Receiver IF Rejection: -80 db

Receiver Image Rejection: -80 db

Receiver Audio Output:

60 mw into 600-ohm balanced load;

15 mw into 600-ohm unbalanced load;

3 w max with external speaker

Receiver Audio Distortion: less than 1 percent

Receive Noise Blanker: reduces pulse type interference

Receiver Sensitivity: 1 μ v for 10 db signal and noise
noise

Receiver Bandwidth: ssb-3.2 kc; am-6 kc

Transmitter Power Output:

ssb-100 w PEP

am-25 w carrier

cw-50 w

fsk-50 w

Power Amplifier Output Termination: 52 ohms

Operating Power Requirement: external 24 v dc; internal 24 v dc zinc battery

Receiver-Exciter Power Consumption: 43 w

Power Amplifier Power Consumption: 180 w

Semi-Automatic Antenna Coupler System

Frequency Range: 2 to 30 mc

VSWR: 1.5:1 max

Input Impedance: 52 ohms

Minimum RF Input Power To Tune: 25 w PEP

Maximum RF Input Power: 100 w PEP or 50 w average (continuous)

Major Units:

RT-618/URC	7" x 17 $\frac{3}{8}$ " x 17 $\frac{1}{4}$ "	47 lbs
------------	--	--------

AM-3008/URT	7" x 17 $\frac{3}{8}$ " x 12 $\frac{3}{4}$ "	45 lbs
-------------	--	--------

TUBES, CRYSTALS, TRANSISTORS:

REFERENCE DATA AND LITERATURE:

NAVSHIPS 94254, Technical Manual for Radio Set AN/URC-35.

AN/URC-type
ANTENNA ASSEMBLY
AS-1018/URC

15 March 1962

Cog. Serv: USN FSN: 5985-613-5647

USA Line Item No.:

USA

USN

USAF

USMC

STATUS OR TYPE CLASS.:

Manufacturer: CHU Associates



AN/URC-type
ANTENNA ASSEMBLY**AS-1018/URC****FUNCTIONAL DESCRIPTION:**

Antenna Assembly AS-1018/URC is a broadband uhf communications antenna. It provides essentially hemispherical radiation coverage with an omnidirectional horizontal radiation pattern. The antenna is vertically polarized. The vertical upward propagation, needed to fill the cone of silence, is horizontally polarized. A line on the mast cap of the antenna indicates the direction of this polarization. The antenna consists of the internal transmission line, the antenna (a two-element colinear dipole array), and the polyester fiberglass mast which completely encloses them.

RELATIONSHIP TO SIMILAR EQUIPMENT:**TECHNICAL DESCRIPTION:**

Frequency Range: 225 to 400 mc

Power Rating: 2 kw average

Gain: 5 db above an isotropic source

Input Impedance: 50 ohms

Standing Wave Ratio: 2:1 max

Circularity: omnidirectional horizontally to within ± 1.0 db

Tilt: antenna beam is tilted upward to place lower half-power point on or below horizon

Wind Load: 120 knots

Maximum Pressurization: 15 psig

Ambient Temperature Range: -32°C to $+52^{\circ}\text{C}$

Major Units:

1 AS-1018/URC

72 $\frac{3}{8}$ " x 13 $\frac{1}{2}$ " dia

50 lbs

TUBES, CRYSTALS, TRANSISTORS:**REFERENCE DATA AND LITERATURE:**

NAVSHIPS 94041A. Technical Manual for Antenna Assembly AS-1018/URC

AN/URC-type
RADIO FREQUENCY MONITOR

IP-591(XN-1)/U

15 March 1962

Cog. Serv: USN FSN:

USA Line Item No.:

USA

USN

USAF

USMC

STATUS OR TYPE CLASS.:

P/Std

Manufacturer: CCVM (05714)

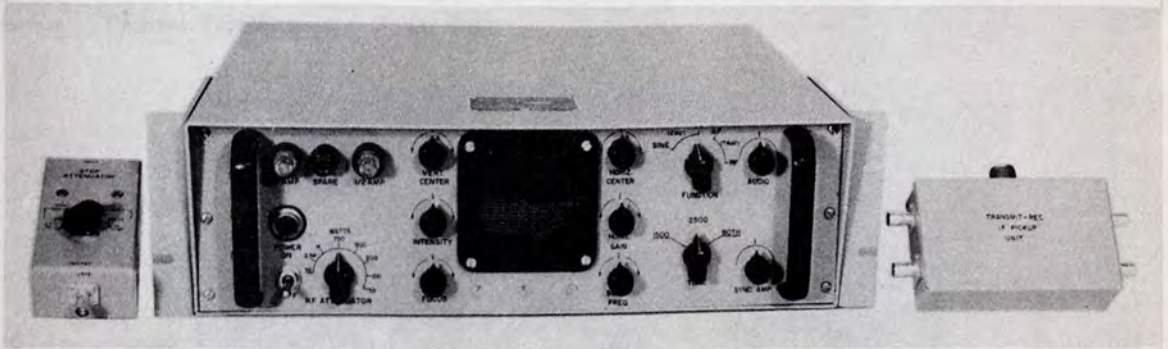
**FUNCTIONAL DESCRIPTION:**

The IP-591(XN-1)/U provides a continuous visual indication of transmitter performance during normal operation of the transmitter. In case of transmitter malfunction or misadjustment, it aids in locating the point of difficulty. It also displays receiver IF signals allowing diagnosis of troubles at distant station. The unit is designed for mounting in standard 19-inch electronic cabinets.

RELATIONSHIP TO SIMILAR EQUIPMENT:**TECHNICAL DESCRIPTION:**

Input Signal Data: one band, 2 to 30 mc frequency range.

Modes of Operation: sine envelope, cw envelope, af trapezoid, rf trapezoid.

Type of Indication: cathode ray tube

Operating Power Requirements: 110 to 120 v ac, 60 cps, single phase.

Major Units:

IP-591(XN-1)/U

5 $\frac{7}{32}$ " x 19" x 17"

30 lbs

Low-level detector and IF pickup

1 $\frac{9}{16}$ " x 6 $\frac{5}{8}$ " x 3 $\frac{11}{16}$ "

1 lb

TUBES, CRYSTALS, TRANSISTORS:**REFERENCE DATA AND LITERATURE:**

NAVSHIPS 94046

RADIO RECEPTION REPORT

IP-3-10-1-11

Station Name: _____
City: _____ State: _____

Date: _____ Time: _____
Frequency: _____

Signal Strength: _____
Quality: _____

Comments: _____

Remarks: _____

Signature: _____

Print Name: _____

Address: _____

City: _____ State: _____

Phone: _____

Other: _____

Station: _____

Page: _____

RADIO RECEIVING SET

AN/URR-13, -13A, -13B, -13C

15 March 1962

Cog. Serv: USN FSN: AN/URR-13: 5820-644-477
 AN/URR-13A: 5820-642-8244
 AN/URR-13B: 5820-665-2374
 AN/URR-13C: 5820-644-3395

USA Line Item No.:

USA

USN

USAF

USMC

STATUS OR TYPE CLASS.:

Std

Manufacturer: Federal Telephone and Radio Corp

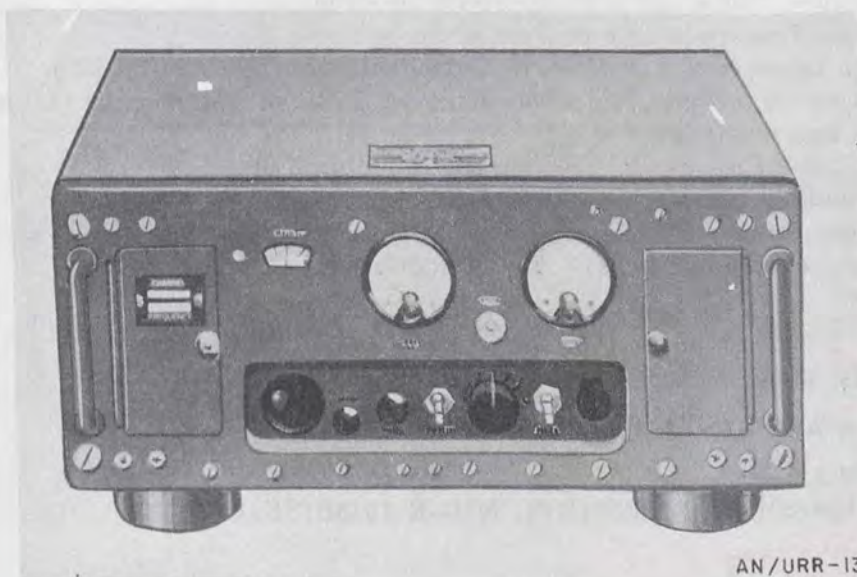

AN/URR-13

FUNCTIONAL DESCRIPTION:

Radio Receiving Sets AN/URR-13, AN/URR-13A, AN/URR-13B, and AN/URR-13C are general purpose, compact communication units designed to provide ultra-high frequency reception on naval vessels, at naval air and shore stations, or at other military establishments.

These equipments are used on conjunction with Radio Transmission Equipment TED. They replace Radio Receiving Equipment RED.

Each set consists of a panel, frame, and chassis assembly housed in a cabinet equipped with shockmounts for shipboard installation. For shore installation the set may be mounted in a standard 19-inch relay rack.

The circuit components are grouped on a functional basis into five major sections within the cabinet and consist of the preselector, intermediate frequency/audio frequency, power supply, cable filtering, and front panel sections.

The sets may be operated on a single crystal-controlled channel, or, through the self-excited conversion oscillator, on continuously variable manual tuning. Provision is made for connecting a panoramic type radio receiver to provide a visual image of the received signal.

RADIO RECEIVING SET

AN/URR-13, -13A, -13B, -13C

All of the equipments are mechanically and electrically interchangeable but have minor differences in components. The AN/URR-13C has two additional test cables not supplied with the previous models. These sets are also similar to Radio Receiving Equipment RDZ and RCN.

RELATIONSHIP TO SIMILAR EQUIPMENT:

TECHNICAL DESCRIPTION:

Frequency Range in Mc: 225 to 400

Type Modulation: am

Type Reception: A2, A3 (voice, mcw)

Number of Channels: single

Type Control: crystal or continuously variable

Type Receiver: double conversion superheterodyne

Intermediate Frequency: 18.6 mc (center frequency ± 2 kc)

Sensitivity: better than 8 μ v for a 10 db single-to-signal plus noise ratio

Audio Output: 60 mw max into a 600-ohm load, 7% max distortion or 600 mc into a 60-ohm load 7% max distortion

Scanning Channel Bandwidth: 600 kc, flat to within 6 db

Heat Dissipation: 120 w

Antenna: quarter-wave, broad-band with 50-ohm terminal impedance

Power Requirements: 125 w; 110- to -20- v, 50-to 60-c, 1-phase ac

Major Units:

AN/URR-13()

8 $\frac{7}{16}$ " x 17 $\frac{1}{2}$ " x 19 $\frac{1}{8}$ "

57 lbs

TUBES, CRYSTALS, TRANSISTORS:

REFERENCE DATA AND LITERATURE:

NAVSHIPS 91270

MIL-R-1513A(SHIPS), 16R53(RE), MIL-R-1513B(SHIPS)

RADIO RECEIVING SET

AN/URR-27

15 March 1962

Cog. Serv: USN FSN: 5820-644-4991

USA Line Item No.:

USA

USN

USAF

USMC

STATUS OR TYPE CLASS.:

L/Std

Manufacturer: National Co Inc

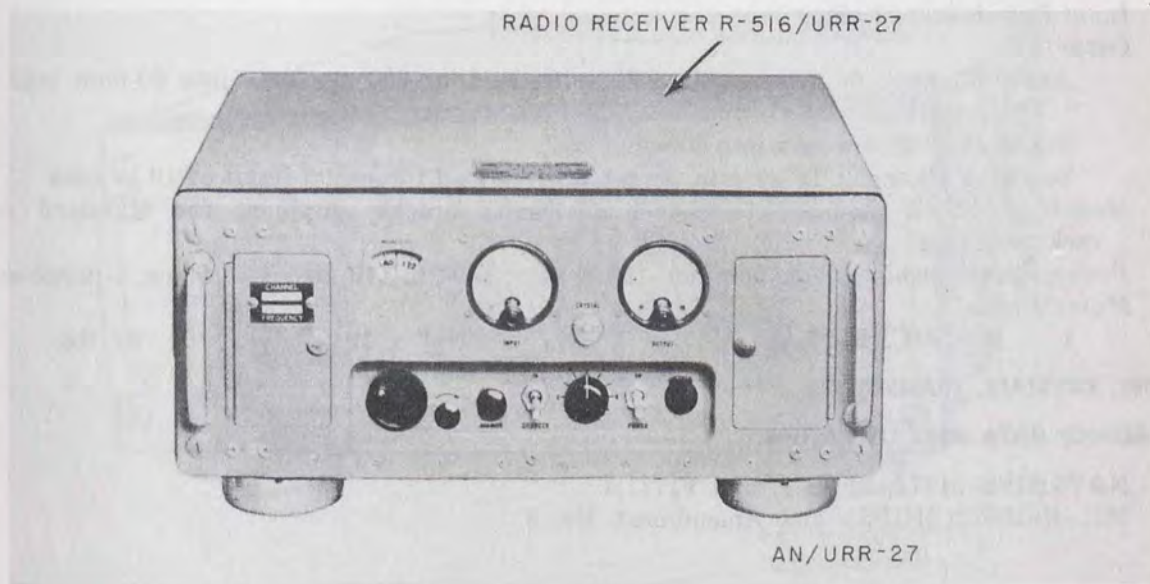
**FUNCTIONAL DESCRIPTION:**

Radio Receiving Set AN/URR-27 is an amplitude modulated communication unit used aboard ship, at shore stations, or by other military establishments in general application. It is designed primarily for operation as a pretuned, single-channel receiver with provisions for continuous variable tuning as well as crystal control.

This equipment includes provisions for connecting a panoramic adapter to obtain a visual indication of the received signal frequency. The scanning channel has a bandwidth of 600 kc, flat to within 6 db.

The AN/URR-27 is similar to Radio Receiving Set AN/URR-13 in electrical design and mechanical construction. However, the AN/URR-13 covers a frequency range of 225 to 400 mc.

RELATIONSHIP TO SIMILAR EQUIPMENT:**TECHNICAL DESCRIPTION:***Frequency Range in Mc:*

Rated: 105 to 190

Maximum: 103.9 to 191.9

RADIO RECEIVING SET

AN/URR-27

Tuning Bands: complete coverage of range with 19 consecutive turns of the tuning control crank

Preset Frequencies:

Manual Tuning: none

Crystal Tuning: one; determined by crystal unit installed

Frequency Control: crystal-controlled oscillator (crystal tuning only)

Type Receiver: superheterodyne

Intermediate Frequency: 18.6 mc \pm 2 kc

Type Reception: A2 (mcw, tone)

Type Modulation: am

Input Impedance: 51 ohms

Output:

Audio Channel: 60 mw max into 600-ohm load, or 600 mw max into 60-ohm load with 7% distortion

Phone Jack: 60 mw max into 600-ohm load

Scanning Channel: 10 μ v min across 50-ohm load for signal input of 10 μ v max

Mounting: Shock mounted for bench or shelf; bracket supplied for standard relay-rack mounting

Power Requirements: 112 w nominal, 120 w max; 110-, to 115- to 120-v, 60 cy, 1-phase ac

Major Units:

1 R-516/URR-27

8 $\frac{7}{16}$ " x 17 $\frac{1}{2}$ " x 19 $\frac{1}{8}$ "

57 lbs

TUBES, CRYSTALS, TRANSISTORS:

REFERENCE DATA AND LITERATURE:

NAVSHIPS 91771, 91771.2, and 91771.4

MIL-R-15872(SHIPS) and Amendment No. 2

RADIO RECEIVING SET
AN/URR-28(XN-1)

15 March 1962

Cog. Serv: USN FSN:

USA Line Item No.:

USA

USN

USAF

USMC

STATUS OR TYPE CLASS.:

P/Std

Manufacturer: CNA (42498)

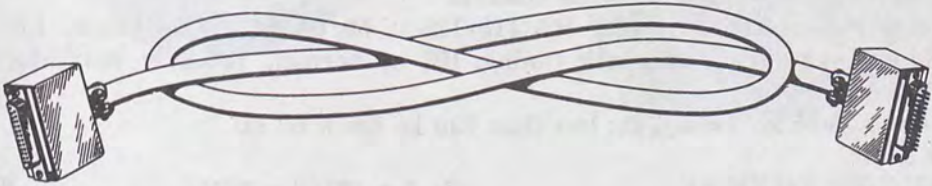
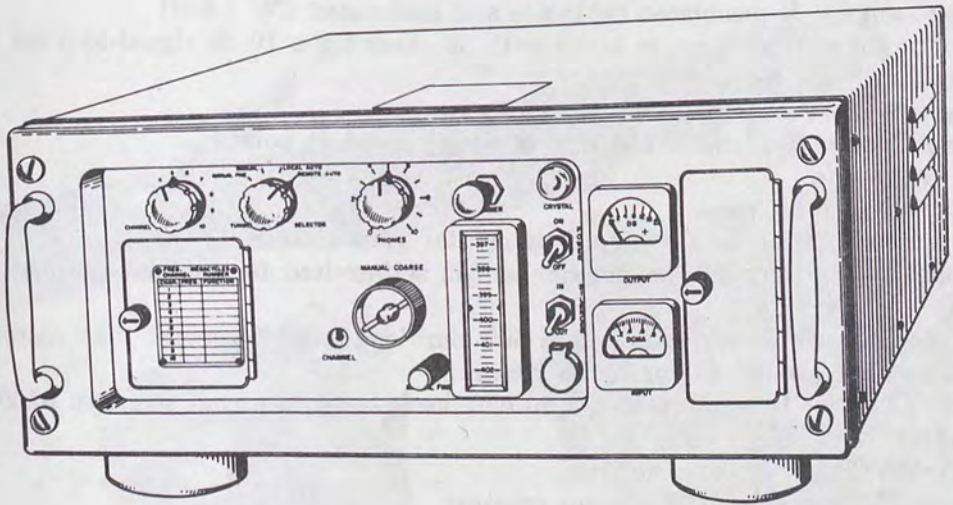
**FUNCTIONAL DESCRIPTION:**

Radio Receiving Set AN/URR-28(XN-1) is a vhf/uhf, double superheteodyne type receiver for general purpose use. The receiver may be mounted on a bench or any other firm horizontal surface, or by attaching brackets in a standard 19-inch relay rack. Provisions are made for connecting a panoramic adapter to the receiver.

RADIO RECEIVING SET

AN/URR-28(XN-1)**RELATIONSHIP TO SIMILAR EQUIPMENT:**

Radio Receiving Set AN/URR-28(XN-1) is a redesign of Radio Receiving Set AN/URR-35A. It is similar to the AN/URR-35A except that: (1) 10 crystal controlled channels are provided in the AN/URR-28(XN-1) as compared with 1 in the AN/URR-35A; and (2) remote selection of any of the 10 crystal controlled channels is possible with the AN/URR-28(XN-1). No remote control is possible with the AN/URR-35A.

TECHNICAL DESCRIPTION:

Frequency Range: 225-400 mc

Reception: amplitude modulated (a3) voice and modulated CW (A-2)

Sensitivity: better than 8 mv in series with 50 ohms for a 10 db signal-to-noise ratio

Tuning Bands: one, continuous

Intermediate Frequencies: 18.6 and 1.775 mc

Scanning Channel Bandwidth: 300-1000 kc between —6 db points

Preset Frequencies:

Manually Tuned: none

Crystal Tuned: 10 as determined by crystal units installed

Frequency Control: crystal for preset channel, self-excited for manual tuning

Receiver Outputs:

Audio Channel: 60 mw max into a 600 ohm load with 7 percent max distortion

Phone Jacks: same as for audio channel

Scan Channel: 10 μ min across a 50 ohm load, for max signal strength of 20 μ

Impedances:

Antenna: Input: 50 ohms nominal

Audio Channel Output: 600 ohms nominal

Phone Jack Output: 600 ohms nominal

Scan Channel Output: 50 ohms nominal

Operating Power Requirements: 105/115/125 v, 50/60 cy; single phase, 1.07 amp normal, 1.88 amp max during automatic tuning, 107 w normal, 196.5 w max during automatic tuning

Selectivity: 70-85 kc down 6 db; less than 190 kc down 60 db

Major Units

AN/URR-28(XN-1)

8 $\frac{7}{16}$ " x 17 $\frac{1}{2}$ " x 22 $\frac{3}{4}$ "

62 lbs

TUBES, CRYSTALS, TRANSISTORS:**REFERENCE DATA AND LITERATURE:**

NAVSHIPS 92333

RADIO RECEIVING SET
AN/URR-29

15 March 1962

Cog. Serv: USA FSN: 5820-567-2358

USA Line Item No.: 658590

USA

USN

USAF

USMC

STATUS OR TYPE CLASS.:

Std

Manufacturer: Motorola, Inc

**FUNCTIONAL DESCRIPTION:**

Radio Receiving Set AN/URR-29 is a transportable general purpose hf and qvhf equipment used for the monitoring and reception of cw, am, and fm signals. It can be used in fixed, semifixed, and transportable applications.

This equipment consists essentially of Radio Receiver R-220/URR, an internal power supply, and accessory components.

It can be used for diversity reception, direction-finding, frequency-shift radioteletype, facsimile, signal analysis, and single-sideband reception, when operated with suitable associated equipment.

RADIO RECEIVING SET

AN/URR-29

RELATIONSHIP TO SIMILAR EQUIPMENT:

TECHNICAL DESCRIPTION:

Frequency Range in Mc: 20 to 230

Type Modulation: am, fm

Type of Signal: cw, mcw, fsk, voice

Power Requirements: 35 w, 115/230-v 48-62 cy ac

Major Units:

1	PP-660/URR	6 $\frac{1}{4}$ " x 5 $\frac{3}{4}$ " x 11 $\frac{1}{2}$ "	30 lbs
1	R-220/URR	10 $\frac{1}{2}$ " x 14 $\frac{3}{4}$ " x 19"	96 lbs

TUBES, CRYSTALS, TRANSISTORS:

REFERENCE DATA AND LITERATURE:

TM 11-882

MIL-R-1058A

RADIO RECEIVING SET
AN/URR-29X

15 March 1962

Cog. Serv: USA FSN: 5820-511-8151

USA Line Item No.:

	USA	USN	USAF	USMC
STATUS OR TYPE CLASS.:	Std	Used by		

Manufacturer:

No Illustration Available

FUNCTIONAL DESCRIPTION:

Radio Receiving Set AN/URR-29X is a portable communication unit suitable for fixed, semifixed, or portable installations. It is designed for the reception and monitoring of amplitude-modulated and frequency-modulated signals.

The receiver has provisions for output connections to standard equipments as required for diversity reception, direction finding, carrier-shift radio teletypewriter, facsimile, signal analysis and sideband reception.

This equipment consists essentially of Radio Receiver R644/URR, and related accessory components.

RELATIONSHIP TO SIMILAR EQUIPMENT:

The set is generally similar to Radio Receiving Set AN/URR-29; however, it differs in respect to the radio receiver and other components.

TECHNICAL DESCRIPTION:*Frequency Range in Mc:* 20 to 230*Number of Bands:* 7*Type Modulation:* am, fm*Type Reception:* A9, F9 (mcw, cw)*Type Presentation:* electric meter*Power Requirements:* 22-v to 32-v dc*Major Units:*

1 R-644/URR

19" x 14 $\frac{7}{8}$ " x 10 $\frac{1}{2}$ "**TUBES, CRYSTALS, TRANSISTORS:****REFERENCE DATA AND LITERATURE:**

TM 11-5016

1000 ...
1000 ...

1000 ...

1000	1000	1000	1000
1000	1000	1000	1000

1000 ...

1000 ...

1000 ...

1000 ...

1000 ...

1000 ...

1000 ...

1000 ...

1000 ...

1000 ...

1000 ...

RADIO RECEIVING SETS

AN/URR-35, -35A, -35B, -35C

15 March 1962

Cog. Serv: USN FSN: AN/URR-35: 5820-665-2375
 AN/URR-35A: 5820-665-1245
 AN/URR-35B: 5820-642-8747
 AN/URR-35C: 5820-644-4773

USA Line Item No.: 658368

	USA	USN	USAF	USMC
STATUS OR TYPE CLASS.:	Std-A	Used by	Std	
Manufacturer:	AN/URR-35, -35B AN/URR-35A AN/URR-35C	Federal Telephone and Radio Corp National Co, Inc Rauland-Borg Corp		

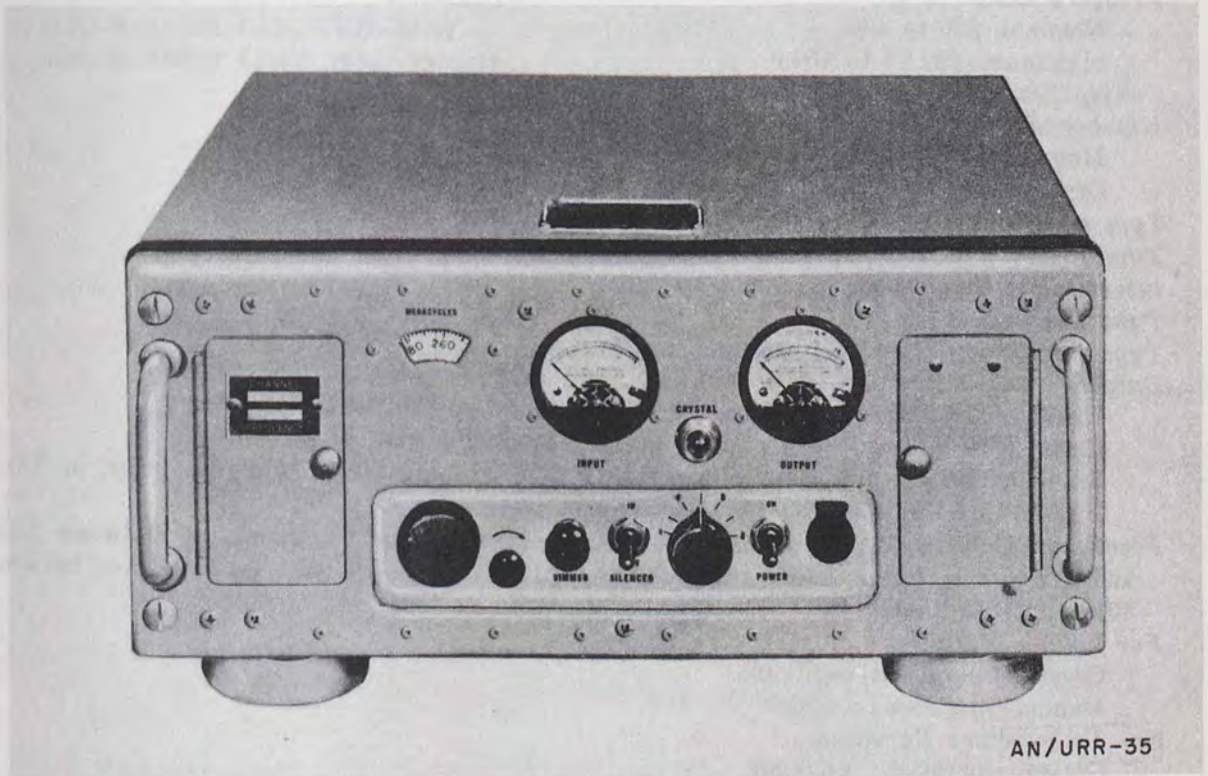
**FUNCTIONAL DESCRIPTION:**

Radio Receiving Sets AN/URR-35, AN/URR-35A, AN/URR-35B, and AN/URR-35C are general purpose very-high-frequency and ultra-high frequency units used on naval vessels, at naval air and shore stations, or at other military establishments. They provide amplitude-modulated point-to-point communications.

All of these equipments are similar functionally and in appearance. The frequency range, operating modes, sensitivity, and response characteristics are the same for the entire series.

RADIO RECEIVING SET

AN/URR-35, -35A, -35B, -35C

The AN/URR-35 and AN/URR-35A are identical except for minor changes in the values of two resistors.

The AN/URR-35B contains a new blower and a plug-and-jack type connection for the blower circuit.

The AN/URR-35C eliminates the entire scanning circuit and the test cables included with previous models. There are, in addition, a few minor modifications of resistance values.

Auxiliary apparatus necessary to operate these equipments are the antenna, antenna transmission line, crystal units, power cable, audio output cable, headphones, and loudspeaker or other responsive devices.

RELATIONSHIP TO SIMILAR EQUIPMENT:**TECHNICAL DESCRIPTION:***Frequency Range in Mc:*

Nominal: 225 to 400

Maximum: 222.75 to 404.0

*Tuning Bands: 1 (continuous)**Number of Preset Frequencies:*

Manual Tuning: None

Crystal Tuning: 1; as determined by crystal unit installed

*Type of Frequency Control: crystal-controlled oscillator**Type Receiver: double superheterodyne**Intermediate Frequencies: 18.6 mc; 1.775 mc**Type Modulation: am**Type Reception: A1, A3 (voice, mc, mcw)**Outputs:*

Audio Channel Output: 60 mw into 600-ohm load; 7% max distortion

Phone Jack Output: 60 mw into 600-ohm load; 7% max distortion

Scan Channel Output: 10 μ v min across a 50-ohm load, for max signal input of 75 μ v (AN/URR-35 and AN/URR-35A only)

Frequency Stability: overall stability for any selected frequency, operating between 103.5 and 126.5 v ac (using 115-v transformer tap), between -4° and $+122^{\circ}$ F. and between 30% and 90% humidity:

For Voltage Variation:

Crystal Operation: negligible

Manual Operation: $\pm 0.02\%$

For Temperature Variation:

Crystal Operation: $\pm 0.008\%$

Manual Operation: $\pm 0.1\%$

Silencer Circuit:

Effective; Silencing Range: 300- μ v inpt (max)

Audio Output Reduction: 40 db under standard output conditions (max)

Time-Constant: Less than 0.2 sec

Impedance

Antenna Input: 50 ohms, coaxial

Audio Channel Output: 600 ohms, nominal

Phone Jack Output: 600 ohms, nominal

AN/URC-type

AN/URR-35, -35A, -35B, -35C

Scan Channel Output: 50 ohms, coaxial (AN/URR-35, AN/URR-35A only)

Sensitivity: 8 μ v, in series with 50 ohms, for 10-db signal-to-noise ratio (signal modulated 30% at 1,000 cps)*Selectivity:* 70 to 85 kc down 6 db; less than 190 kc down 60 db*Power Requirements:* 98 w, (with blower off), 108 w (with blower on); 0.97 amps, 105 to 125 v, 50- to 60-cy, 1-phase ac*Major Units:*

1 R-482/URR-35

8 $\frac{7}{16}$ " x 17 $\frac{1}{2}$ " x 19 $\frac{1}{8}$ "

57 lbs

TUBES, CRYSTALS, TRANSISTORS:**REFERENCE DATA AND LITERATURE:**

NAVSHIPS 91906 (AN/URR-35 and AN/URR-35B)

NAVSHIPS 92022 (AN/URR-35A)

NAVSHIPS 92676 (AN/URR-35C)

MIL-R-10584 (AN/URR-35A)

MIL-R-16620 (Each other model)

RADIO RECEIVING SET
AN/URR-35D

15 March 1962

Cog. Serv: USN FSN:

USA Line Item No.:

	USA	USN	USAF	USMC
STATUS OR TYPE CLASS.:	Std-A	Used by	Std	

Manufacturer: Rauland-Borg Corp
Western Electric Co

No Illustration Available

FUNCTIONAL DESCRIPTION:

Radio Receiving Set AN/URR-35D is a very-high-frequency and a ultra-high-frequency unit used on naval vessels, at naval air and shore stations, or at any other military establishments.

This equipment is designed primarily for operation as a pretuned, single-channel, crystal-controlled receiver. By selecting a suitable crystal, any channel within the frequency range of the set may be used.

An adjustable carrier relay circuit is provided to allow operation over an input signal range of 2 to 20 microvolts.

A panel-mounted pilot light indicates the operation of the carrier relay.

RELATIONSHIP TO SIMILAR EQUIPMENT:**TECHNICAL DESCRIPTION:**

Frequency Range in Mc: 225 to 400

Type Modulation: am

Type Reception: voice, mcw

Frequency Control: crystal or manual

Type Receiver: double superheterodyne

Presentation: Audio type

Input Signal Voltage:

Power Requirements: 105-, 115-, or 125-v, 50- to 60-cy 1-phase ac

Major Units:

1 F-318()/URR-35

1 R-482()/URR-35

TUBES, CRYSTALS, TRANSISTORS:**REFERENCE DATA AND LITERATURE:**

MIL-R-16620A(SHIPS)

100-1000 MHz
100-1000 MHz
100-1000 MHz

100-1000 MHz	100-1000 MHz	100-1000 MHz	100-1000 MHz
100-1000 MHz	100-1000 MHz	100-1000 MHz	100-1000 MHz

100-1000 MHz
100-1000 MHz

100-1000 MHz

TECHNICAL DESCRIPTION

The ANURR-35D is a very high frequency radio receiver designed for use in aircraft and other military installations.

This receiver is designed for use as a radio receiver in aircraft and other military installations.

The receiver is designed for use as a radio receiver in aircraft and other military installations.

The receiver is designed for use as a radio receiver in aircraft and other military installations.

REQUIREMENTS FOR INSTALLATION

GENERAL DESCRIPTION

The receiver is designed for use as a radio receiver in aircraft and other military installations.

The receiver is designed for use as a radio receiver in aircraft and other military installations.

The receiver is designed for use as a radio receiver in aircraft and other military installations.

The receiver is designed for use as a radio receiver in aircraft and other military installations.

The receiver is designed for use as a radio receiver in aircraft and other military installations.

The receiver is designed for use as a radio receiver in aircraft and other military installations.

The receiver is designed for use as a radio receiver in aircraft and other military installations.

The receiver is designed for use as a radio receiver in aircraft and other military installations.

100-1000 MHz

100-1000 MHz

TECHNICAL DESCRIPTION

REQUIREMENTS FOR INSTALLATION

GENERAL DESCRIPTION

RADIO RECEIVING EQUIPMENT

AN/URR-36

15 March 1962

Cog. Serv: USN FSN:

USA Line Item No.:

USA

USN

USAF

USMC

STATUS OR TYPE CLASS.:

Manufacturer: CNA (42498)

No Illustration Available

FUNCTIONAL DESCRIPTION:

Radio Receiving Equipment AN/URR-36 is a general purpose communications receiver. It uses plug-in coils for band coverage. The accessories also are plug-in type. One of the accessories, the vibrator power supply, operates from a 6 v dc supply to furnish complete operating voltages for the receiver. Receiver selectivity characteristics are made adjustable by means of a crystal filter. The equipment is temperature compensated, and contains noise limiter and tone control circuits. Plug-in mountings are included for a narrow band fm adaptor and a crystal calibrator.

RELATIONSHIP TO SIMILAR EQUIPMENT:**TECHNICAL DESCRIPTION:**

Operating Modes: cw, phone, narrow band fm, phono

Frequency Range: 50-430 kc and 480 kc- 35 mc

Frequency Coverage: 12 bands

Receiver Output Impedance: 8 or 500 ohms

Mounting: table or rack

Operating Power Requirements: 110/220 or 220/240 v, 50/60 cy, approximately 115 w; 6 v dc with storage battery vibrator, power supply accessory; directly from batteries

Major Units: AN/URR-36 consists of 1 Receiver Loudspeaker

TUBES, CRYSTALS, TRANSISTORS:**REFERENCE DATA AND LITERATURE:**

NAVSHIPS 91648

...

...

...

...

...

...

...

...

...

...

...

...

...

...

...

...

...

...

AN/URR-type
 AMPLIFIER, AUDIO FREQUENCY
AM-413D/G

15 March 1962
 Cog. Serv: USN FSN: 5820-856-1266
 USA Line Item No.:

USA

USN

USAF

USMC

STATUS OR TYPE CLASS.:

Manufacturer: General Sintering Corp

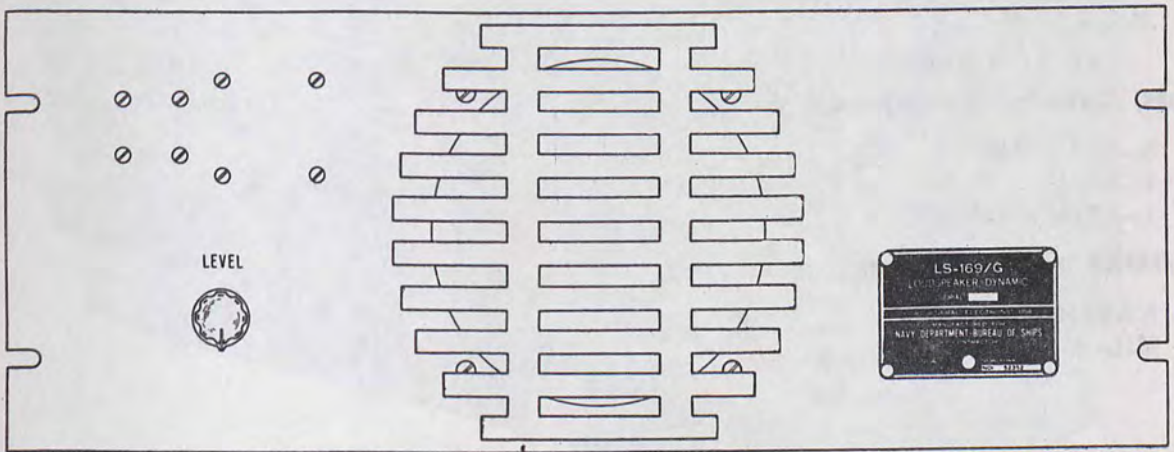
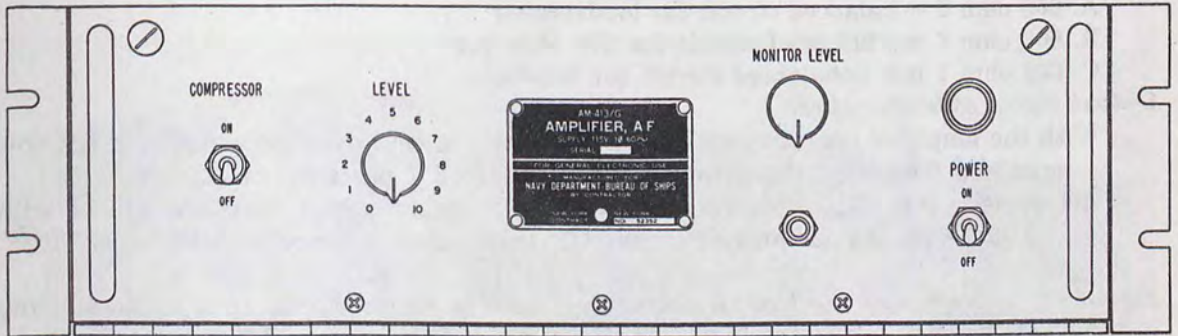

AM-413/G

FUNCTIONAL DESCRIPTION:

This is an audio frequency amplifier suitable for general communication purposes when operating in conjunction with Naval radio receiving sets and associated equipment. It is an automatic variable gain amplifier capable of producing rated audio power output of 2 watts with any audio power input between 0.001 milliwatts and 6 milliwatts. The amplifier is designed for mounting in a standard 19-inch relay rack and complies with specification MIL-E-16400 for class 4 temperature requirements.

AN/URR-type
AMPLIFIER, AUDIO FREQUENCY

AM-413D/G

RELATIONSHIP TO SIMILAR EQUIPMENT:

EQUIPMENT REQUIRED BUT NOT SUPPLIED:

None of the cables required for use with the equipment is supplied, nor are any of the auxiliary devices used in conjunction with the equipment, such as radio receiving sets or speakers.

TECHNICAL DESCRIPTION:

Frequency Range: 200 cps to 5000 cps

Power Output:

- A. 600 ohm 2 w balanced circuit for loudspeaker
- B. 600 ohm 6 mu balanced circuit for 600 ohm line
- C. 600 ohm 1 mw unbalanced circuit for headset

Output signal characteristics:

With the amplifier operating at a the rated power output over the range of rated power input and frequency, the distortion will not exceed 7 percent (r.m.s. value).

Accuracies: With the compressor circuit OFF the frequency response will be within ± 2 db. With the compressor circuit ON the frequency response will be within ± 5 db.

Pertinent electrical and mechanical characteristics: The input impedance of each audio input circuit of the amplifier (total of two) is 600 ohms ± 10 percent at 1000 cps

Where and how installed: Designed for mounting in a standard 19-inch Navy type relay rack.

Mounting dimensions: Designed for mounting in a standard 19-inch Navy Type relay rack.

Number of operators required: One

Major Units:

1 AM-413D/G

19" x 5½" x 9"

16½ lbs

TUBES, CRYSTALS, TRANSISTORS:

5-12AT7WA

1-6005

1-5Y3WGTA

REFERENCE DATA AND LITERATURE:

NAVSHIPS 91905

MIL-A-15695C, Amendment 3

AN/URR-type
RADIO RECEIVER

BC-312()

15 March 1962

Cog. Serv: USA FSN: BC-312, -A, -C thru N: 5820-164-7230
BC-312-HX, -NX: 5820-164-6371

USA Line Item No.: 635020

USA

USN

USAF

USMC

STATUS OR TYPE CLASS.: L/Std

Manufacturer: Farnsworth Television & Radio



BC-312

FUNCTIONAL DESCRIPTION:

Radio Receiver BC-312-() is an mf and hf, am (voice, tone, and cw) general utility radio receiving equipment widely used as part of such radio sets as the AN/GRC-26 and SCR-399. It can be used in mobile, vehicular, fixed-plant, or airborne radio communication applications.

**AN/URR-type
RADIO RECEIVER**

BC-312()

This equipment consists of a single primary operating component. It can be used with a loudspeaker or headphones.

RELATIONSHIP TO SIMILAR EQUIPMENT:

TECHNICAL DESCRIPTION:

Frequency Range in Mc: 1.5 to 18.0 in 6 bands

Type Modulation: am

Type of Signal: cw, tone, voice

Power Requirements: BC-312 (most models): 12-14-v dc (storage battery); BC-312-HX, -NX: 24-28-v dc (storage battery)

Major Units:

1 BC-312

10" x 9 $\frac{1}{16}$ " x 18 $\frac{1}{16}$ "

58 lbs

TUBES, CRYSTALS, TRANSISTORS:

REFERENCE DATA AND LITERATURE:

TM 11-850

(USA) 71-914

AN/URR-type
RADIO RECEIVER

R-388()/URR

15 March 1962

Cog. Serv: USA, USN FSN: 5820-537-3895

USA Line Item No.: 635910

USA

USN

USAF

USMC

STATUS OR TYPE CLASS.:

Manufacturer: Collins Radio Co (R-388/URR)
Collins Radio Co (R-388A/URR)

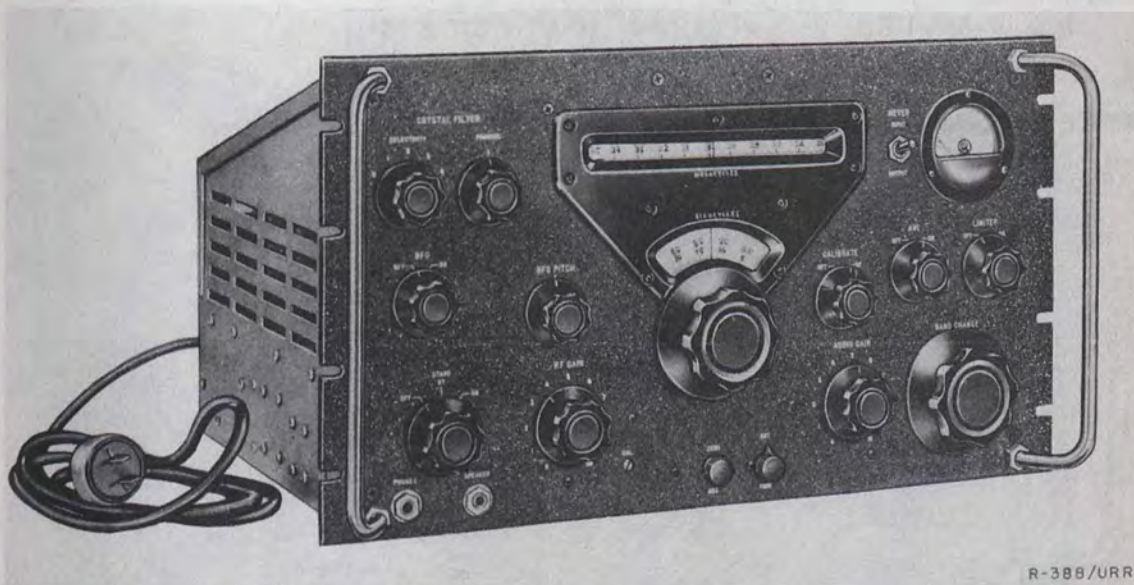

FUNCTIONAL DESCRIPTION:

Radio Receiver R-388()/URR is a general purpose, am (voice, cw, and fsk) radio receiving equipment operating in the mf and hf bands for fixed-station or mobile applications.

This equipment, consisting of a single self-contained rack-mounted radio receiver, having unusual stability and calibration accuracy, is especially useful for operating on known frequencies without searching or readjustment, and for reception of frequency-shift-keyed signals. It includes a 100-kc crystal-calibrated oscillator, a coaxial antenna input connector, a coaxial connector for tapping the IF output, and has provision for connecting an external circuit to control the built-in remote-disabling relay. It can be operated with straight wire or doublet-type antenna systems.

AN/URR-type
RADIO RECEIVER

R-388()/URR

RELATIONSHIP TO SIMILAR EQUIPMENT:

Radio Receiver R-388A/URR, procured by the USN, is identical to the R-388/URR, except that it uses mechanical filters and nonmagnetic side panels.

TECHNICAL DESCRIPTION:

Frequency Range in Mc: 0.5 to 30.5

Type Modulation: am

Type of Signal: cw, voice, fsk

Power Requirements: 85 w, 115/230-v 45-70-cy ac

Major Units:

1 R-388/URR

10½" x 19" x 13¼"

35 lbs

TUBES, CRYSTALS, TRANSISTORS:

REFERENCE DATA AND LITERATURE:

TM 11-854

AN/URR-type
RADIO RECEIVER

R-389()/URR

15 March 1962

Cog. Serv: USA FSN: 5820-503-1417

USA Line Item No.: 658381

USA

USN

USAF

USMC

STATUS OR TYPE CLASS.:

Std

Manufacturer:



R-389/URR

FUNCTIONAL DESCRIPTION:

Radio Receiver R-389()/URR is a general purpose, low- and medium-frequency, fixed station equipment used in communication, intercept, and direction-finding applications.

For radioteletype applications, this equipment has a 455-kc output that can be connected to a suitable frequency-shift converter to operate teletypewriter equipment.

It is intended for standard rack-and-panel installation in fixed-plant applications but may also be used in mobile applications where suitable power is available.

AN/URR-type
RADIO RECEIVER

R-389()/URR

RELATIONSHIP TO SIMILAR EQUIPMENT:

TECHNICAL DESCRIPTION:

Frequency Range in Mc: 0.015 to 1.5

Type Modulation: am

Type of Signal: cw, mcw, voice, fsk

Power Requirements: 250 w, 115/230-v, 48-62 cy, ac

Major Units:

1 R-389()/URR

10 $\frac{1}{2}$ " x 17 $\frac{1}{4}$ " x 19"

82 lbs

TUBES, CRYSTALS, TRANSISTORS:

REFERENCE DATA AND LITERATURE:

TM 11-855

MIL-R-10474

AN/URR-type
RADIO RECEIVER
R-390/URR

15 March 1962

Cog. Serv: USA FSN: 5820-503-1242

USA Line Item No.: 658382

	USA	USN	USAF	USMC
STATUS OR TYPE CLASS.:	Std-A		A/Std	

Manufacturer: Motorola, Inc

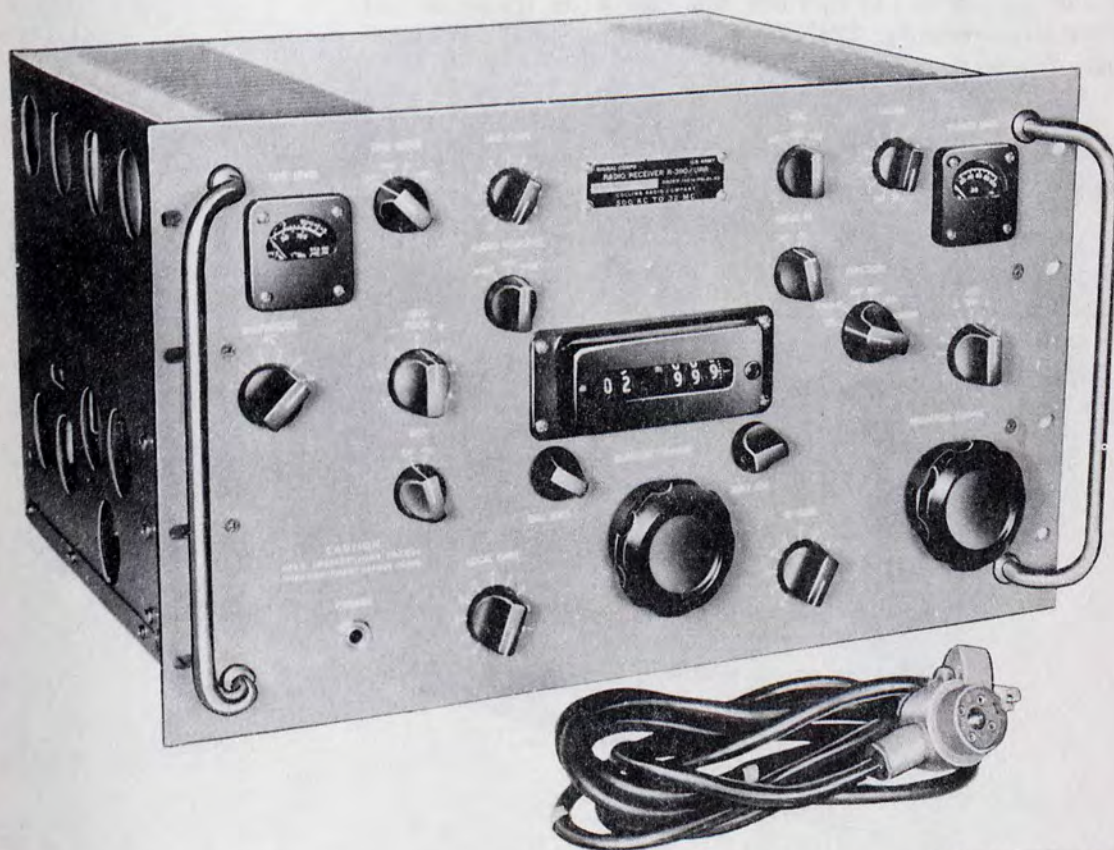

R-390/URR

FUNCTIONAL DESCRIPTION:

Radio Receiver R-390/URR is a general purpose am (cw, mcw, and voice) medium- and high-frequency equipment of exceptional stability characteristics, used in fixed and mobile applications.

**AN/URR-type
RADIO RECEIVER**

R-390/URR

This equipment can be operated in space-diversity and single sideband arrangements for radioteletype communication, in conjunction with such equipment as Radioteletype Terminal Equipment AN/FGC-1, Frequency Shift Converter CV-116/URR, or Single Sideband Converter CV-157/URR.

This receiver is composed of seven subchassis assemblies that can be removed for troubleshooting and repair.

RELATIONSHIP TO SIMILAR EQUIPMENT:

TECHNICAL DESCRIPTION:

Frequency Range in Mc: 0.5 to 32

Type Modulation: am

Type of Signal: cw, mcw, voice, fsk, composite transmissions

Power Requirements: 225/270 w, 115/230-v, 48-62-cy, ac

Major Units:

1 R-390/URR

10 $\frac{1}{2}$ " x 17 $\frac{1}{4}$ " x 19"

84.7 lbs

TUBES, CRYSTALS, TRANSISTORS:

REFERENCE DATA AND LITERATURE:

TM 11-264B

TM 11-856

MIL-R-10474; MIL-R-13947

AN/URR-type
RADIO RECEIVER
R-390A/URR

1 March 1964

Cog. Serv: USA FSN: 5820-510-1605

USA Line Item No.:

USA

USN

USAF

USMC

STATUS OR TYPE CLASS.:

Std-A

Std

Manufacturer: Collins Radio Co



R-390A/URR

FUNCTIONAL DESCRIPTION:

Radio Receiver R-390A/URR is a high performance, exceptionally stable, general purpose superheterodyne receiver for use in fixed and mobile applications. It provides reception of continuous wave, modulated continuous wave, voice, and frequency-shifted keyed signals within a frequency range of 0.5 to 32 megacycles.

AN/URR-type
RADIO RECEIVER

R-390A/URR

The receiver can be operated in a space-diversity receiving system, either of two types of space-diversity radioteletype receiving systems, and in a single-side band radioteletype receiving system.

RELATIONSHIP TO SIMILAR EQUIPMENT:

TECHNICAL DESCRIPTION:

Frequency Range in Mc: 0.5 to 32

Type of Signal: A1, A2, A3, A9, F1

Audio Power Output:

600-ohm unbalanced line: 500 mw (min)

600-ohm balanced line: 10 mw (min)

Headphones: 1 mw

If Selectivity: 100 cps to 16 kc

Antenna:

Unbalanced: straight wire or random length or vehicular mounted whip

Balanced: 125-ohm terminating impedance

Power Requirements: 225 w, 115/230 v ($\pm 10\%$), 48- to 62-cy, ac

Major Units:

1 Amplifier, radio frequency

11 $\frac{3}{4}$ " x 4 $\frac{11}{16}$ " x 5"

1 Audio assembly

11 $\frac{1}{8}$ " x 5 $\frac{1}{4}$ " x 3 $\frac{5}{16}$ "

TUBES, CRYSTALS, TRANSISTORS:

REFERENCE DATA AND LITERATURE:

TM 11-856A

MIL-4-1D474

AN/URR-type
RADIO RECEIVER
R-391/URR

1 March 1964

Cog. Serv: USA FSN: 5815-503-1256

USA Line Item No.: 658372

	USA	USN	USAF	USMC
STATUS OR TYPE CLASS.:	Std-A		Std	
Manufacturer:	Collins Radio Co			

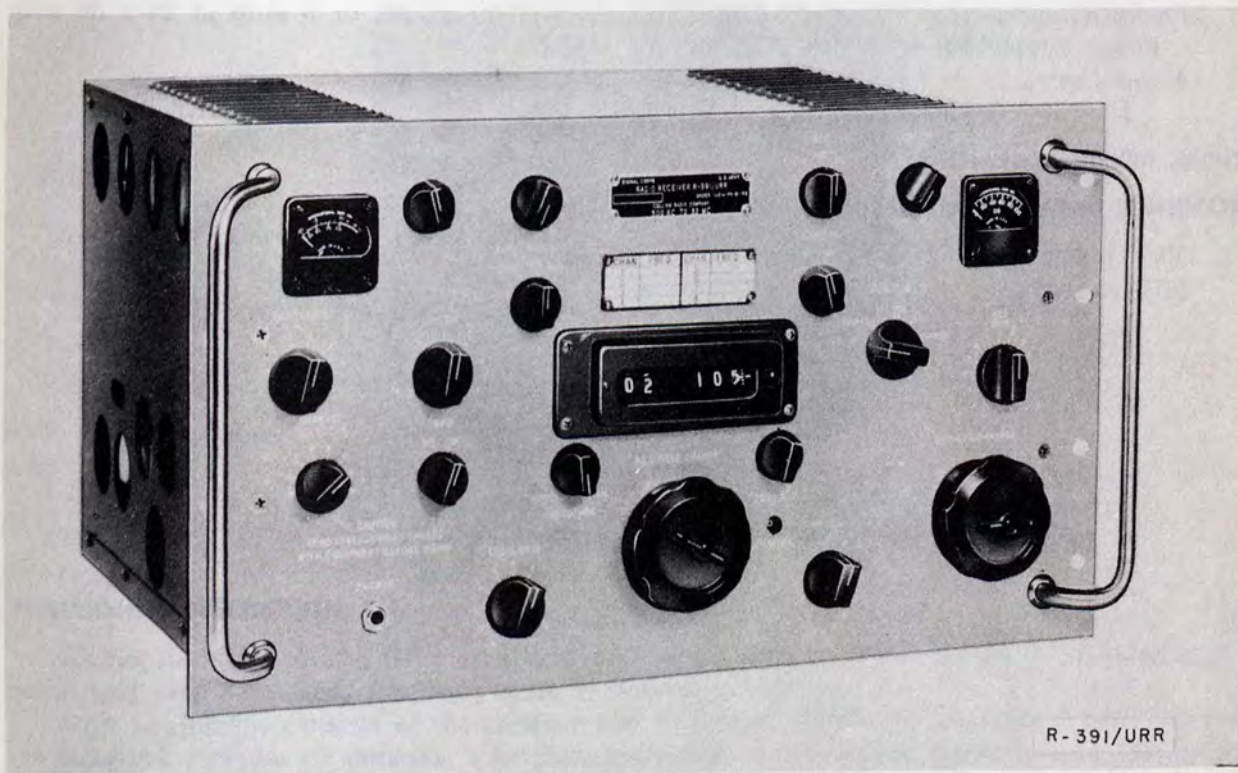

R-391/URR

FUNCTIONAL DESCRIPTION:

Radio Receiver R-391/URR is a general purpose mf and hf equipment for both fixed and mobile service and provides reception of am (cw, mew, voice) and fsk signals.

This equipment consists of the receiver, which contains its own power supply, and necessary cable assemblies. The antenna, headset, speaker, transmission line, adapter connectors, and a separate power supply for use with an autotune system are required but not supplied.

Two or three receivers may be connected as a space-diversity receiving system for reception of voice signals.

AN/URR-type
RADIO RECEIVER

R-391/URR

This receiver is one of a series that also includes the R-389/URR and R-390/URR. Each one, differing in the method of tuning and frequency range, has a number of features in common, such as utilized construction and interchangeable subchassis.

This receiver, in mobile applications, requires an external Power Supply PP-629/URR.

RELATIONSHIP TO SIMILAR EQUIPMENT:

TECHNICAL DESCRIPTION:

Frequency Range in Mc: 0.5 to 32 in 32 steps

Type Modulation: am

Type of Signal: cw, mew, voice, fsk

Power Requirements: 270 w, 115/230-v ($\pm 10\%$), 48-62-cy, ac; or 3 amp at 24-v dc with Power Supply PP-629/URR for autotune systems only

Major Units:

1 R-391/URR

10 $\frac{1}{2}$ " x 17 $\frac{1}{4}$ " x 19"

87.2 lbs

TUBES, CRYSTALS, TRANSISTORS:

REFERENCE DATA AND LITERATURE:

TM 11-863

MIL-R-10474

AN/URR-type
RADIO RECEIVER**R-392/URR**

1 July 1958

Cog. Serv: USA FSN: 5820-503-1250

USA Line Item No.: 658384

	USA	USN	USAF	USMC
STATUS OR TYPE CLASS.:	Std-A			

Manufacturer:

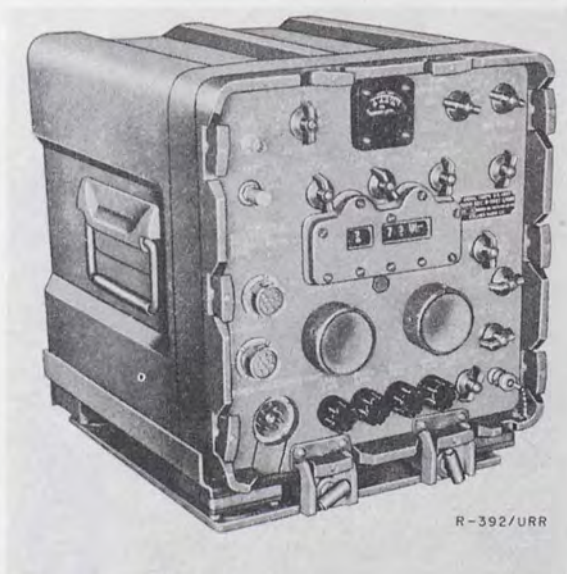

R-392/URR

FUNCTIONAL DESCRIPTION:

Radio Receiver R-392/URR is a vehicular equipment used for receiving radiotelegraph, voice, and single-channel, frequency-shift radioteletype signals.

This equipment consists of the receiver and tube case. Additional equipment required, but not supplied, includes an antenna, a headset, a speaker, the mounting, power source, and accessories.

It can be used as a conventional communication receiver, as part of a vehicular two-way communication system, or as part of a single-channel, frequency-shift radioteletype system.

This receiver is immersionproof and is sufficiently rugged to withstand parachute delivery when mounted in a truck or in standard U.S. Army parachute delivery container.

It has provision for connection of its 455-kc IF signal output to a frequency-shift radioteletype converter.

RELATIONSHIP TO SIMILAR EQUIPMENT:**TECHNICAL DESCRIPTION:**

Frequency Range in Mc: 0.5 to 32 in 32 bands

Type Modulation: am

AN/URR-type
RADIO RECEIVER

R-392/URR

Type of Signal: cw, mw, voice, fsk

Power Requirements: 3 amp, 22-28-v, dc

Major Units:

1 R-392/URR

11½" x 14⅛" x 11"

52 lbs

TUBES, CRYSTALS, TRANSISTORS:

REFERENCE DATA AND LITERATURE:

TM 11-858

MIL-R-10474

AN/URR-type
RADIO RECEIVER

R-520()/URR

15 March 1962

Cog. Serv: USA FSN: 5820-503-1403

USA Line Item No.: 658388

USA

USN

USAF

USMC

STATUS OR TYPE CLASS.:

Manufacturer: Zenith Radio Corp

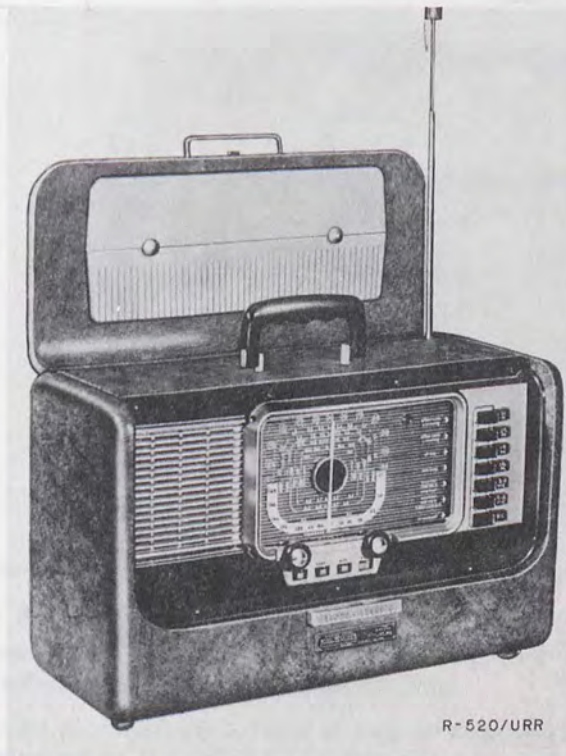

R-520/URR

FUNCTIONAL DESCRIPTION:

Radio Receiver R-520()/URR is a portable superheterodyne receiving equipment, used for troop information. It is capable of receiving am signals over the broadcast and shortwave bands (total of seven), and of operating with an internal loudspeaker or an externally connected, low-impedance headset.

Accessory equipment, such as a headset and a long-wire antenna, is not supplied with this equipment.

RELATIONSHIP TO SIMILAR EQUIPMENT:**TECHNICAL DESCRIPTION:**

Frequency Range in Mc: 0.54 to 1.6; 2 to 4; 4 to 8; 9.4 to 9.8; 11.6 to 12; 14.9 to 15.5; 17.5 to 18.1

AN/URR-type
RADIO RECEIVER

R-520()/URR

Type Modulation: am

Type of Signal: voice

Power Requirements: 10/20 w, 115/230-v, ac; 7.5/15 w, 115/230-v, dc; or 67 ma at 9-v, dc (A battery) and 17 ma at 90-v, dc (B battery)

Major Units:

1 R-520()/URR

11 $\frac{1}{16}$ " x 7 $\frac{3}{32}$ " x 17 $\frac{5}{16}$ "

20 lbs

TUBES, CRYSTALS, TRANSISTORS:

REFERENCE DATA AND LITERATURE:

TM 11-877

RADIO TRANSMITTING SETS
AN/URT-7, -7A, -7B, -7C

15 March 1962

Cog. Serv: USN FSN: 5820-665-2473 (AN/URT-7B)

USA Line Item No.:

USA

USN

USAF

USMC

STATUS OR TYPE CLASS.:

Used by

Manufacturer: Federal Telephone and Radio Corp; Rauland-Borg Corp

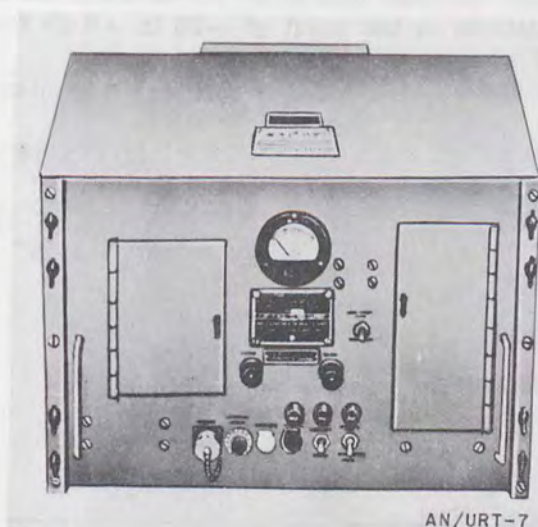
**FUNCTIONAL DESCRIPTION:**

Radio Transmitting Sets AN/URT-7, AN/URT-7A, AN/URT-7B, and AN/URT-7C are low power, general purpose units designed for radiotelephone and modulated continuous wave communication on ship, submarine, or at shore installations.

This equipment may be mounted on a table or may be removed from its cabinet and mounted in a standard 19-inch relay rack. Remote control operation may be from a standard Remote Radiophone Unit NT-23500 or equivalent. Limited control from a remote location may be obtained with Transmitter Control NT-23555.

Radio Transmitting Sets AN/URT-7, AN/URT-7A, AN/URT-7B, and AN/URT-7C are interchangeable but differ in minor electrical and mechanical design.

RELATIONSHIP TO SIMILAR EQUIPMENT:**TECHNICAL DESCRIPTION:**

Frequency Range in Mc: 115 to 156

Frequency Control: crystal

Frequency Stability: $\pm 0.007\%$

Type Modulation: am

Type Emission: A2, A3 (cw, mcw, voice)

RADIO TRANSMITTING SETS

AN/URT-7, -7A, -7B, -7C

Power Output: 30 w, nominal

Impedance:

Microphone: 600 ohms input

Antenna: 50 ohms output

Audio Input Voltage: 25 to + 5 db from a 0.006-w reference level (0.1 to 3.4 v)

Audio Frequency Response: flat within ± 3 db from a 1,000-cps reference level, from 300 to 3,500 cps

Audio Frequency Filter: flat with ± 2 db from a 1,000 cps reference level, and -50 db at 5,000 and over.

Input to Clipping Stage: normally held at 20 ± 5 db above the clipping level by action of the avc circuit for variations in the input of -25 to +5 db from 0.006-w reference level

Heat Dissipation: 700 w

Power Requirements: 750 w; 115- or 230-v $\pm 10\%$, 50- to 60-cy $\pm 5\%$, 1-phase ac, 0.85 pf

Major Units:

1	T-336/URT-7	13 ² / ₃₂ " x 16 ¹ / ₂ " x 19"	146 lbs
1	AM-638/URT	5" x 9 ³ / ₃₂ " x 14 ¹ / ₂ "	
1	CY-1126/URT	13 ² / ₃₂ " x 14 ¹ / ₁₆ " x 19"	
1	PP-773/URT	12 ⁷ / ₃₂ " x 16 ¹ / ₄ " x 19"	
1	MD-163/URT	4" x 9 ³ / ₃₂ " x 14 ³ / ₈ "	

TUBES, CRYSTALS, TRANSISTORS:

REFERENCE DATA AND LITERATURE:

NAVSHIPS 91684

RADIO TRANSMITTING SET

AN/URT-7D

15 March 1962

Cog. Serv: USN FSN: 5820-713-3939

USA Line Item No.:

	USA	USN	USAF	USMC
STATUS OR TYPE CLASS.:		Std		
Manufacturer:	CCWJ (89114)			

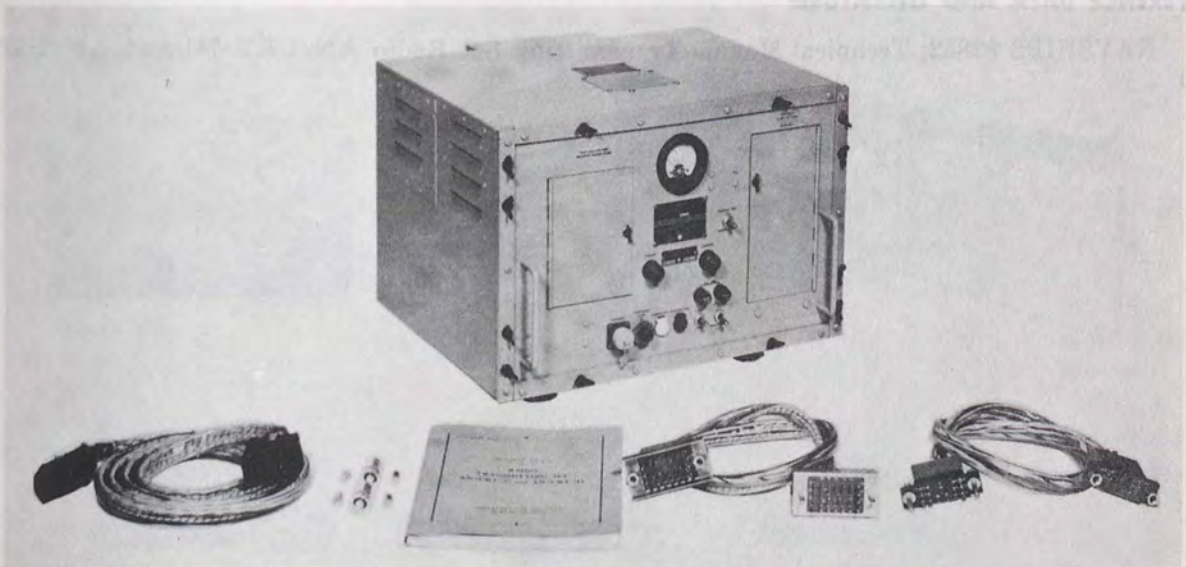
**FUNCTIONAL DESCRIPTION:**

The AN/URT-7D is predominantly used for ship-to-ship and ship-to-shore communications. It is employed for radio telephone am modulated-continuous wave communications. The range is approximately line of sight. It may be operated from remote units.

RELATIONSHIP TO SIMILAR EQUIPMENT:

Functionally similar to previous models in the AN/URT-7 series.

TECHNICAL DESCRIPTION:

Frequency Range: 115 to 156 mc

Emission: voice or mcw

Carrier Power: 30 w min

Sideband Power: 15 w min

Frequency stability: 0.007 pct

Operating Power Requirements: 115 or 230 v ac, 50 to 60 cps, single phase.

RADIO TRANSMITTING SET

AN/URT-7D

Major Units:

1	T-336D/URT	16 $\frac{1}{2}$ " x 19" x 13 $\frac{23}{32}$ "	34 lbs
1	AM-638D/URT	13 $\frac{3}{4}$ " x 5" x 10"	13 lbs
1	PP-773D/URT	14 $\frac{1}{2}$ " x 19" x 12 $\frac{7}{32}$ "	55 lbs
1	MD-163D/URT	13 $\frac{3}{8}$ " x 4" x 10"	26 lbs
1	CX-1826/U	96" lg	1 $\frac{3}{4}$ lbs
1	CX-1827/U	36" lg	1 $\frac{1}{2}$ lbs
1	CX-3154/U	36" lg	1 lb
1	Maintenance Parts Kit	11 $\frac{1}{4}$ " x 21 $\frac{1}{4}$ " x 7 $\frac{1}{2}$ "	40 lbs

TUBES, CRYSTALS, TRANSISTORS:

REFERENCE DATA AND LITERATURE:

NAVSHIPS 92832; Technical Manual Transmitting Set Radio AN/URT-7C and AN/URT-7D

RADIO TRANSMITTING SET
AN/URT-10(XN-1)

15 March 1962

Cog. Serv: USN FSN:

USA Line Item No.:

USA

USN

USAF

USMC

STATUS OR TYPE CLASS.:

P/Std

Manufacturer: Federal Telephone and Radio Corp

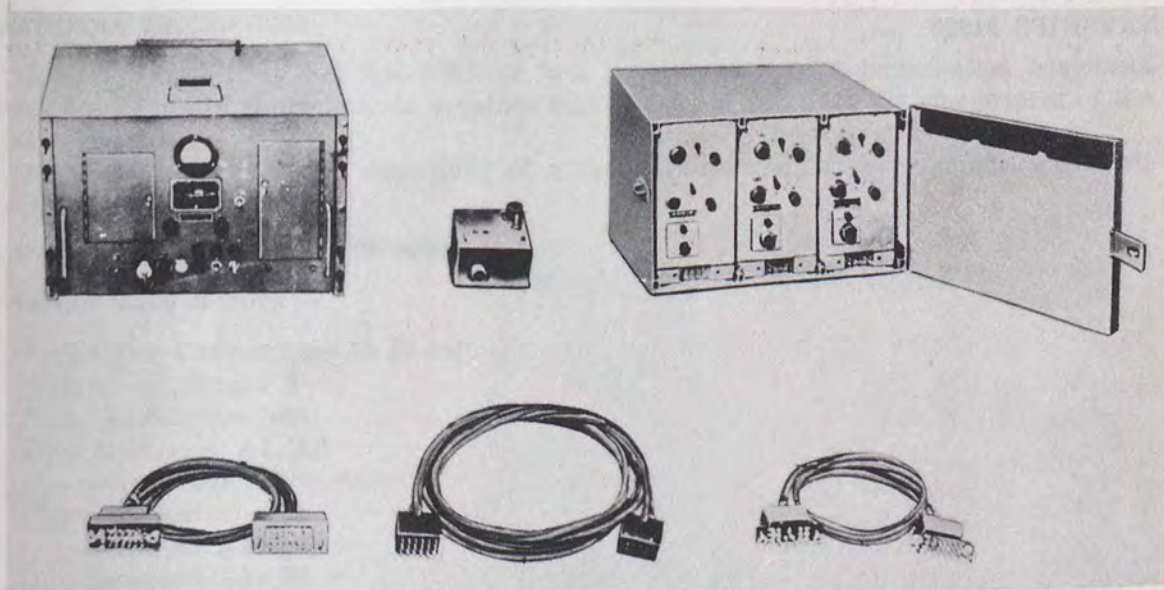
**FUNCTIONAL DESCRIPTION:**

Radio Transmitting Set AN/URT-10(XN-1) is used for vhf/uhf radio-telephone and modulated continuous wave (mcw) transmission, and is intended for installation aboard ships, submarines, and at shore stations. The transmitter control unit permits limited control of the equipment from a remote point, and is primarily for use at shore installations and on small ships. Remote operation from standard shipboard remote units is also possible.

RELATIONSHIP TO SIMILAR EQUIPMENT:**TECHNICAL DESCRIPTION:**

Frequency Range: 30-400 mc

Frequency Control: crystal

Emission and Modulation Capability: A2(mcw) 100 percent; A3 (Phone) 100 percent

Nominal Carrier Output: 30 w between 30 and 115 mc; 15 w between 115 and 400 mc

Frequency Stability: ± 0.007 percent under any conditions

RADIO TRANSMITTING SET

AN/URT-10(XN-1)

Impedance:

Microphone Input: 600 ohms

Antenna Output: 50 ohms

Audio Input Voltage: -25 db to +5 db from a 0.006 w reference level (0.1 to 3.4 v)

Operating Power Requirements: 115/230 v ± 10 percent, 50-60 cy ± 5 percent, single phase, 0.85 power factor, 750 w

Major Units:

1 AN/URT-10(XN-1)

13 $2\frac{3}{32}$ " x 19" x 16 $1\frac{1}{2}$ "

146 lbs

TUBES, CRYSTALS, TRANSISTORS:

REFERENCE DATA AND LITERATURE:

NAVSHIPS 91625

RADIO TRANSMITTING SET

AN/URT-12

3 December 1958

Cog. Serv: USN FSN:

USA Line Item No.:

	USA	USN	USAF	USMC
STATUS OR TYPE CLASS.:		Used by	Std	

Manufacturer: Radiomarine Corporation of America

No Illustration Available

FUNCTIONAL DESCRIPTION:

Radio Transmitting Set AN/URT-12 is a general purpose communication equipment designed for ship and shore use. It provides eight bands to facilitate the employment of the frequency range.

This equipment consists essentially of a radio transmitter, a power supply, a cabinet, and associated accessories.

RELATIONSHIP TO SIMILAR EQUIPMENT:**TECHNICAL DESCRIPTION:***Frequency Range:* 2 mc to 30 mc*Number of Bands:* 8*Type Modulation:* am*Type Emission:* A1, A3*Frequency Control:* crystal*Power Output:*

Emission A1: 100 w

Emission A3: 75 w

Power Requirements: 1,050 w; 115-v or 230-v, 50- to 60-cy, 1-phase ac*Major Units:*

1 AN/URT-12

20" x 20" x 36"

TUBES, CRYSTALS, TRANSISTORS:**REFERENCE DATA AND LITERATURE:**

ALL INFORMATION CONTAINED HEREIN IS UNCLASSIFIED

RADIO TRANSMITTER

AN/UR-13

Part Number	Description	Quantity	Remarks
1	Transmitter Assembly	1	
2	Power Supply	1	
3	Control Panel	1	
4	Antenna	1	
5	Mounting Bracket	1	

1. This transmitter is designed to transmit voice and data signals over a distance of up to 100 miles. It is suitable for use in both land and sea environments.

2. The transmitter consists of a general purpose communication equipment designed for use in both land and sea environments. It provides a means of communication between the transmitter and the receiver.

3. The transmitter is designed to transmit voice and data signals over a distance of up to 100 miles. It is suitable for use in both land and sea environments.

4. The transmitter is designed to transmit voice and data signals over a distance of up to 100 miles. It is suitable for use in both land and sea environments.

5. The transmitter is designed to transmit voice and data signals over a distance of up to 100 miles. It is suitable for use in both land and sea environments.

RADIO TRANSMITTER

AN/URT-17

15 March 1962

Cog. Serv: USN FSN:

USA Line Item No.:

USA

USN

USAF

USMC

STATUS OR TYPE CLASS.:

Manufacturer: CCLX (82679)

FUNCTIONAL DESCRIPTION:

Radio Transmitter AN/URT-17 is for radio telephone, telegraph, frequency shift, and facsimile operation on all frequencies within its range. The AN/URT-17 may be used, because of its pi network output circuit, to load any properly constructed unbalanced antenna system with a reasonable degree of matching. The equipment is adaptable for multi-channel, frequency shift, and single sideband operation. For sideband operation, the transmitter is used in conjunction with a single sideband exciter that provides single sideband with suppressed carrier, double sideband with full carrier, or cw operation.

RELATIONSHIP TO SIMILAR EQUIPMENT:

This equipment is the military version of manufacturer's radio transmitter Model GPT-750.

TECHNICAL DESCRIPTION:

Frequency Range: 2-32 mc, band switched

Power Rating:

1000 w output, cw or fs

750 w output, radio telephone

750 w output, PEP, single sideband for continuous service.

Frequency Control: built-in high stability master oscillator, plus three crystal positions selectable by front panel switch

Keying Speed:

up to 240 wpm on cw

up to 1000 wpm on fs

Master Oscillator Characteristics:

Frequency Range: 2-4 mc continuously variable

Oscillator Calibration: direct reading in cps

Readability: 20 cps per mc to a previously calibrated frequency

Frequency Calibration: An oven-controlled 100 kc oscillator may provide a crystal check point. The 100 kc oscillator may be calibrated against a primary standard.

Zero Beat Indication: 50 kc check points on neon light null indicator. Additional aural check points are available

Stability: better than 20 cps per mc for a 30° change in ambient temperatures

Line Voltage Effect: not more than 10 cps for a ± 10 percent variation

Crystal Oscillator Characteristics:

Frequency Range: 2-4 MC

Number of Positions: 3, selectable from front panel

MIL-HDBK-161A/TM11-487A-3/NAVEXOS P-2058/TO 31-3-73

RADIO TRANSMITTER

AN/URT-17



RADIO TRANSMITTER

AN/URT-17

Modulation Characteristics: capable of 100 percent sine wave plate modulation with less than 10 percent distortion.

Noise Level: better than 40 db down

Frequency Response: Uniform within ± 1.5 db from 100-5000 cps

Output Impedance:

30 to 10000 ohms at angle 0° (equivalent SWR-1)

50 to 700 ohms at angle $\pm 45^\circ$ (equivalent SWR-4) all unbalanced to ground

Audio Input: 600 ohm balanced or carbon microphone

Tuning: all tuning and band switching from front panel, no plug-in frequency components

Cooling: forced filtered air; two separate blowers

Overload and Bias Protection: automatic

Temperature/Humidity: ambient limits, 0° to $\pm 50^\circ$ C; relative humidity up to 75 percent

Operating Power Requirements: 115/230 v, 50/60 cy, single phase, approximately 2600 w at a .87 power factor for full continuous output.

Major Units:

1 AN/URT-17

47" x 34" x 27"

695 lbs

TUBES, CRYSTALS, TRANSISTORS:

REFERENCE DATA AND LITERATURE:

NAVSHIPS 93161

RADIO TRANSMITTING SET

AN/URT-18

15 March 1962

Cg. Serv: USN FSN: 5820-725-4824

USA Line Item No.:

USA

USN

USAF

USMC

STATUS OR TYPE CLASS.:

Manufacturer: COL 13499

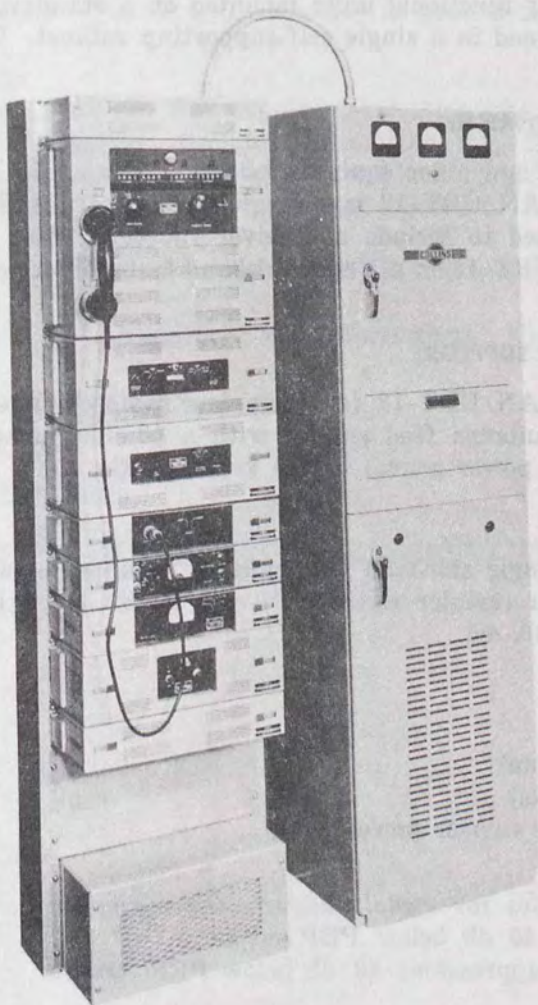

FUNCTIONAL DESCRIPTION:

Radio Transmitter Set AN/URT-18 is a manually tuned single-sideband transmitter for operation in the 2 to 30 megacycle high frequency range. The AN/URT-18 delivers 2.5 kilo-

RADIO TRANSMITTING SET

AN/URT-18

watts peak envelope power or 2.5 kilowatts average power continuously. Although the AN/URT-18 is primarily designed for single sideband transmission on upper sideband, lower sideband or twin sideband (with separate audio and IF channels for each sideband) provisions are included for compatible am (carrier reinserted), cw, or fsk operation. The frequency range of 2 to 30 megacycles is covered in four bands, the desired operating frequency being set to one kilocycle increments on a direct reading frequency counter. Frequency accuracy and stability are controlled by a self-contained frequency standard.

Radio Transmitting Set AN/URT-18 includes an exciter rack, a power amplifier, and an antenna coupler.

The exciter rack consists of functional units mounted on a standard 19-inch open type rack. The power amplifier is contained in a single self-supporting cabinet. The antenna is contained in a single dustproof chassis.

RELATIONSHIP TO SIMILAR EQUIPMENT:

Similarities between this and other equipments:

Radio Transmitting Set AN/URT-18 is a single sideband transmitter with a 2.5 kw power amplifier, and may be modified to include a receiver function. The Radio Set AN/URC-32, which is similar to the AN/URT-18 is a single sideband transceiver with a 500 w power amplifier.

EQUIPMENT REQUIRED BUT NOT SUPPLIED:

Radio Transmitting Set AN/URT-18 is a complete radio communications transmitter requiring only an antenna, an antenna feed system with a 50-ohm unbalanced termination, and a 230 v, 60 cps, single phase power source of 6.5 kva capacity.

TECHNICAL DESCRIPTION:

Type of Transmission: Single sideband transmission on upper sideband, lower sideband, or twin sideband. Compatible am (carrier reinserted), cw, or fsk operation.

Frequency Range: 2.0 to 30. mc

Power Output:

- (A1) 2.5 kw
- (A3_a) 2.5 kw PEP
- (A3_b) 2.5 kw PEP total
- (A9) 2.5 kw PEP total
- (A9a) 2.5 kw average carrier power
- (FL) 2.5 kw

Output signal characteristics for visual and/or audio outputs:

Carrier Suppression: 45 db below PEP output

Undesired sideband suppression: 40 db below PEP output

Audio inputs:

USB Line: -38 to +8 dbm into 600 ohms balanced

LSB: -38 to +8 dbm into 600 ohms balanced

Microphone: Standard high impedance dynamic with push-to-talk switch

Handset: High impedance dynamic, noise cancelling type with push-to-talk switch

R-F output impedance: 50 ohms unbalanced

RADIO TRANSMITTING SET

AN/URT-18

Ranges as rated:

Not applicable

Accuracies: Frequency accuracy and stability are controlled by a self-contained frequency standard which has a stability of 1 part in 10^6 per month or 1 part in 10^8 per day.

Power Source Required: 115/230 v ac, single phase, 60 cps, 6.5 kva capacity.

Heat Dissipation: Heat dissipation in the exciter rack is 400.0 w, and in the linear amplifier 2.8 kw.

Type of Modulation:

- (1) single sideband of an am signal with suppressed carrier.
- (2) am (single-side (USB) and carrier).

How and where installed: This set is used mainly as ground support equipment, but can also be used shipboard.

Mounting Dimensions

Antenna Coupler, 180Y-1: May require fabrication of a lattice-type rack by the installing activity. May be mounted using the top, the bottom, or either side as the mounting surface. For top and bottom; mounting holes No. 10 Rivnut, 4 places, $5\frac{1}{2}$ " by $13\frac{3}{8}$ ". For both sides; mounting holes No. 10 Rivnut, 4 places, $13\frac{3}{8}$ " by $9\frac{5}{8}$ ".

Power Amplifier 204F-1: Base mounting hole dimensions. Front $12\frac{1}{4}$ " by $14\frac{1}{4}$ " deep. Holes are $1\frac{1}{16} \pm \frac{1}{64}$ ".

Exciter Rack: Base mounting hole dimensions. Front $19\frac{1}{16}$," rear $15\frac{1}{4}$ " and sides $12\frac{3}{4}$ ".

No. of operators required: 1

TUBES, CRYSTALS, TRANSISTORS:**REFERENCE DATA AND LITERATURE:**

Manuscript Technical Manual for Non-Registered Radio Transmitting Set AN/URT-18

AN/URT-type
RADIO FREQUENCY AMPLIFIER

AM-2374/URT

15 March 1962

Cog. Serv: USN FSN:

USA Line Item No.:

USA

USN

USAF

USMC

STATUS OR TYPE CLASS.:

Manufacturer: COL (13499)

FUNCTIONAL DESCRIPTION:

Radio Frequency Amplifier AM-2374/URT is a three-stage, linear power amplifier designed to amplify low power radio frequency signals from an associated exciter unit to a level suitable for transmission from an antenna. The AM-2374/URT is primarily intended for single-sideband operation, but can be used with any type of input signal that does not exceed its bandwidth and power capabilities. The amplifier may be switched to either of two channels, and either channel may be tuned to any frequency between 2 and 30 megacycles. The AM-2374/URT is capable of delivering either 2.5 kilowatts peak envelope power or 2.5 kilowatts average power continuously. It can be operated locally or remotely.

RELATIONSHIP TO SIMILAR EQUIPMENT:

The AM-2374/URT is the military version of the Collins 204F-1 type Amplifier.

EQUIPMENT REQUIRED BUT NOT SUPPLIED

Radio Frequency Amplifier MA-2374/URT is intended for use as one portion of a complete system. It requires the use of 0.1 watt external exciter; an antenna coupler with a 50 ohms impedance; a three-pole, 250 vac fused disconnect switch, 3 power conductors, and an 8 in. by 4 in. external air duct.

TECHNICAL DESCRIPTION:

Types of transmission: superior for ssb operation. Can be used with any type not exceeding bandwidth or power capabilities of the amplifier.

Frequency range: 2 to 30 mc

Power Output: 2.5 kw peak envelope power or 2.5 kw average power continuously.

Output signal characteristics for visual and/or audio outputs: N/A

Ranges as rated: N/A

Accuracies: ssb distortion has at least 35 db signal-to-distortion ratio.

Power source required: 200 to 250 v ac, 50 or 60 cy, single phase; 28 v dc, 50 ma.

Heat dissipation: 2.5 kw

Excitation required: 0.1 w nominal, 0.2 w from external exciter

Bandwidth: at least 16 kc at 1-db points.

Input impedance: 50 ohms

Output impedance: 50 ohms

AN/URT-type
RADIO FREQUENCY AMPLIFIER

AM-2374/URT

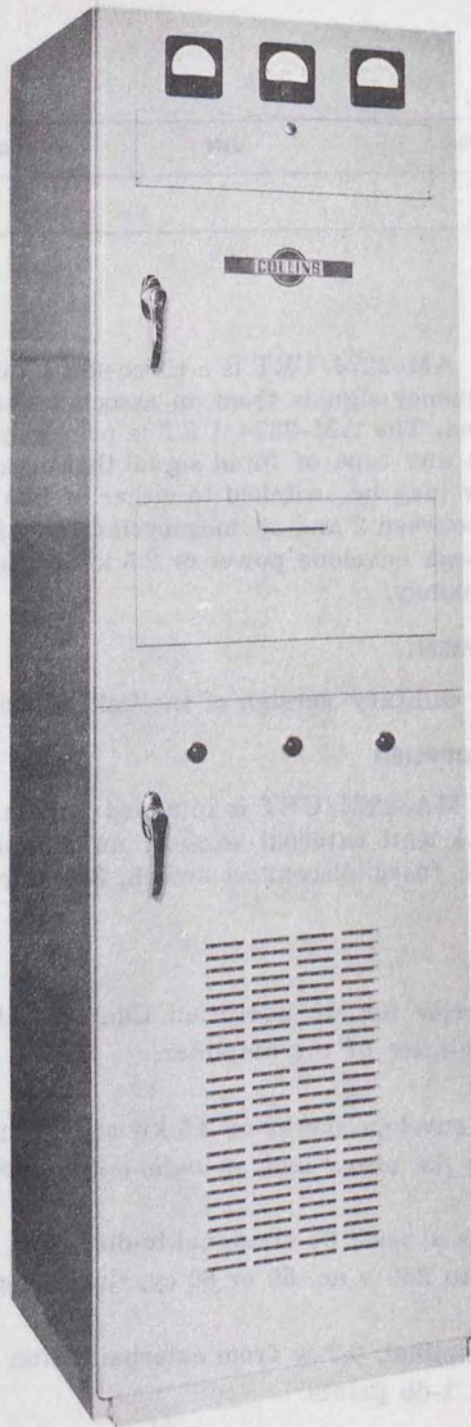

AN/URT-type
RADIO FREQUENCY AMPLIFIER

AM-2374/URT

How installed: Amplifier AM-2374/URT is contained in a self-supporting aluminum cabinet.

Dimensions: 20" x 20" x 70"

Number of operators required: One

Major Units:

1	AM-2374/URT	70" x 20" x 20"	600 lbs
---	-------------	-----------------	---------

TUBES, CRYSTALS, TRANSISTORS:

REFERENCE DATA AND LITERATURE:

Technical Manual for Radio-Frequency Amplifier, AM-2374/URT, Contract NObsr 81039

AN/URT-type
RADIO TRANSMITTER

T-368()/URT

Cog. Serv: USA FSN: 5820-503-2640
USA Line Item No.: 691947

USA

USN

USAF

USMC

STATUS OR TYPE CLASS.:

Std

Manufacturer: Barker & Williamson, Inc

FUNCTIONAL DESCRIPTION:

Radio Transmitter T-368()/URT is a medium-power, am (cw, voice), hf transmitter that can be used as mobile or fixed-station equipment.

It may also be used as an rf amplifier for low-powered exciter units or as driver or high-power transmitters. In such applications, it will transmit frequency-shift keying, narrowband fm, and a combination of frequency-shift keying with voice am.

This equipment consists of the transmitter and accessory items, and requires a tuning unit when a long-wire or whip-type antenna is used. It also requires auxiliary equipment for frequency-shift keying or other special modes of transmission.

RELATIONSHIP TO SIMILAR EQUIPMENT:**TECHNICAL DESCRIPTION:***Frequency Range in Mc:* 1.5 to 20*Type Modulation:* am, fm*Type of signal:* cw, icw, voice, fsk*Power Output:*

am: 4000 w

cw: 450 w

Power Requirements: 2.2 kw, 115-v 50/60-cy, ac*Major Units:*

1 T-368/URT

57" x 31" x 32"

TUBES, CRYSTALS, TRANSISTORS:**REFERENCE DATA AND LITERATURE:**

TM 11-908

MIL-T-11770; MIL-T-11437

AN/URT-type
RADIO TRANSMITTING SET
T-368()/URT

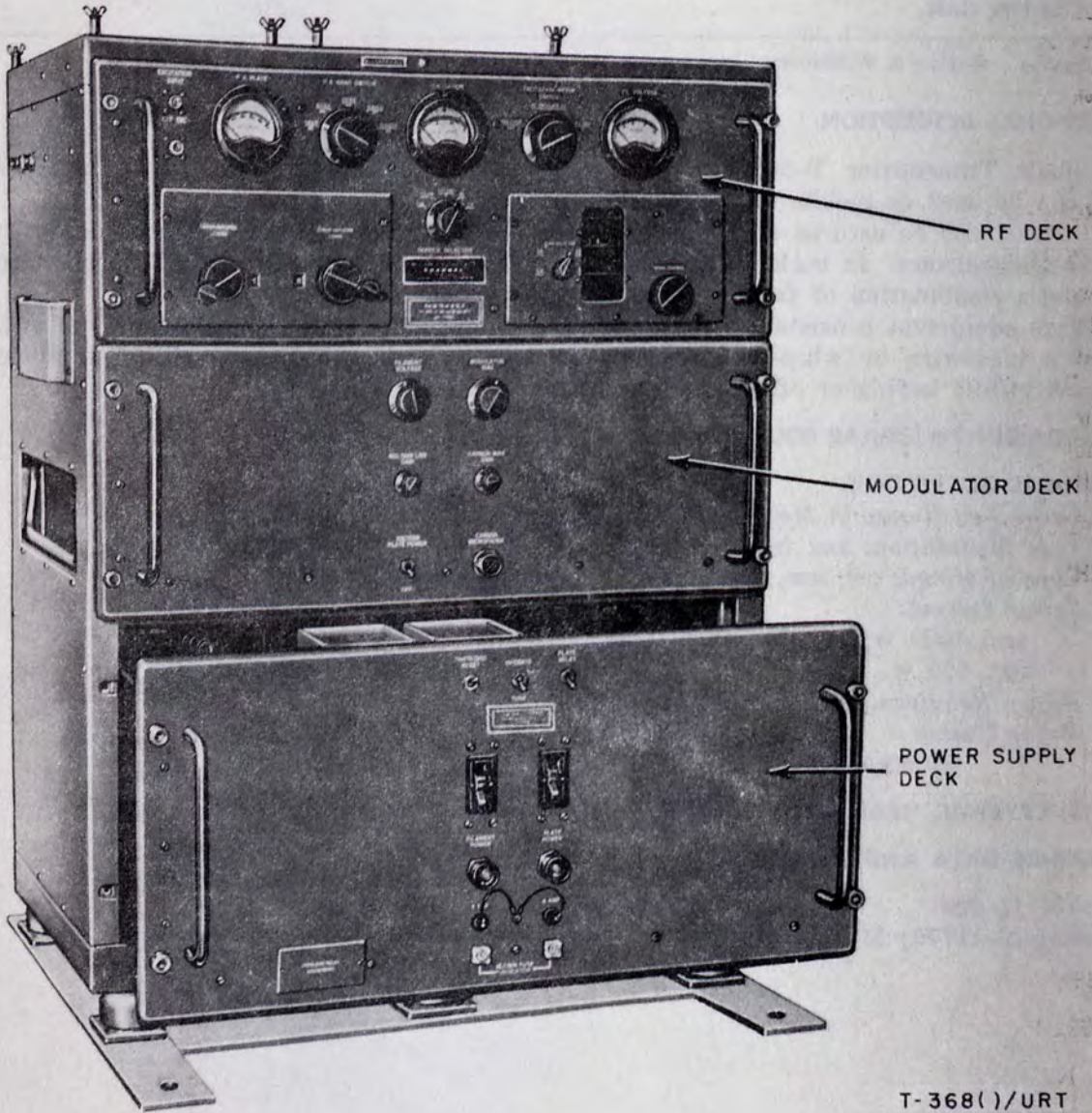

AN/USA-type
TELEPHONE TERMINAL

TA-269/U

1 December 1958

Cog. Serv: USN FSN: 5805-681-9821

USA Line Item No.: 681734

	USA	USN	USAF	USMC
STATUS OR TYPE CLASS.:	Std-B			

Manufacturer: Radio Frequency Laboratories, Inc

No Illustration Available

FUNCTIONAL DESCRIPTION:

Telephone Terminal TA-269/U provides two-way conversation over a radio circuit from a two-wire or four-wire telephone system. Connections are provided to extend the two-wire circuit to a point remote from the terminal; or a local four-wire handset can be used to communicate over either the radio circuit or over the two-wire voice line to a remote point.

By setting a remote three-position switch, the internal circuits of this equipment can be switched by relays for communication with the local handset over the radio circuit, to the remote station (or PBX board), or for the usual communication from the remote station on the two-wire line over the four-wire radio circuit.

RELATIONSHIP TO SIMILAR EQUIPMENT:**TECHNICAL DESCRIPTION:***Frequency Range:*

Amplifier Response: within 2 db from 200 to 3,500 cps

Filter Band-Pass: within 3 db from 200 to 3,000 cps

Power Output: +8 dbm (max) output level of both receiver and transmitter amplifier*Sensitivity:* input signal to the limiter circuit at level of -15 dbm to +6 dbm appears at limiter circuit output at level of -28 dbm to -18 dbm*Amplification:* signal from limiter output (-28 to -18 dbm) amplified by transmitting amplifier with adjustable amplification gain of 8 to 35 db*Power Requirements:* 35 w, 115/230-v ($\pm 10\%$), 50-60 cy, 1-phase, ac*Major Units:*

TA-269/U

5 $\frac{1}{4}$ " x 16" x 19"

53 lbs

TUBES, CRYSTALS, TRANSISTORS:**REFERENCE DATA AND LITERATURE:**

NAVSHIPS 92181

10-10-10
10-10-10
10-10-10

10-10-10
10-10-10
10-10-10

10-10-10
10-10-10
10-10-10

10-10-10
10-10-10
10-10-10

10-10-10
10-10-10
10-10-10

10-10-10
10-10-10
10-10-10

AN/USM-type
MODULATOR

MD-83A/ARN

4 December 1958

Cog. Serv: USN FSN: 5820-543-1641

USA Line Item No.: 627552

	USA	USN	USAF	USMC
STATUS OR TYPE CLASS.:	Std-A			
Manufacturer:	Collins Radio Co			

No Illustration Available

FUNCTIONAL DESCRIPTION:

Modulator MD-83A/ARN is designed to facilitate the testing and calibrating of omni-range navigation receivers for aircraft use.

In conjunction with Signal Generator SG-1/ARN, this equipment provides a synthesis of signals encountered in reception and interpretation of omni-range, tone localizer, voice, and glide slope facilities. In addition, the various components of these signals are available singly and in combination for test purposes.

All voltages obtained from the modulator are generated mechanically.

RELATIONSHIP TO SIMILAR EQUIPMENT:**TECHNICAL DESCRIPTION:***Output Voltage:* 3 v*Voltage Stability:* $\pm 5\%$ *Frequency Stability:* dependent upon power source*Phase Angle Stability:* ± 0.2 *Power Requirements:* 115/v, 60-cy, 1-phase, ac*Major Units:*

1 MD-83A/ARN

12" x 12" x 15"

60 lbs

TUBES, CRYSTALS, TRANSISTORS:**REFERENCE DATA AND LITERATURE:**

TO 33A1-8-37-1

FACSIMILE RECORDER SET
AN/UXH-2(XN-3)

3 December 1958

Cog. Serv: USN FSN:

USA Line Item No.:

USA

USN

USAF

USMC

Used by

Std
(AN/UXH-2)

STATUS OR TYPE CLASS.:

Manufacturer: Times Facsimile Corp

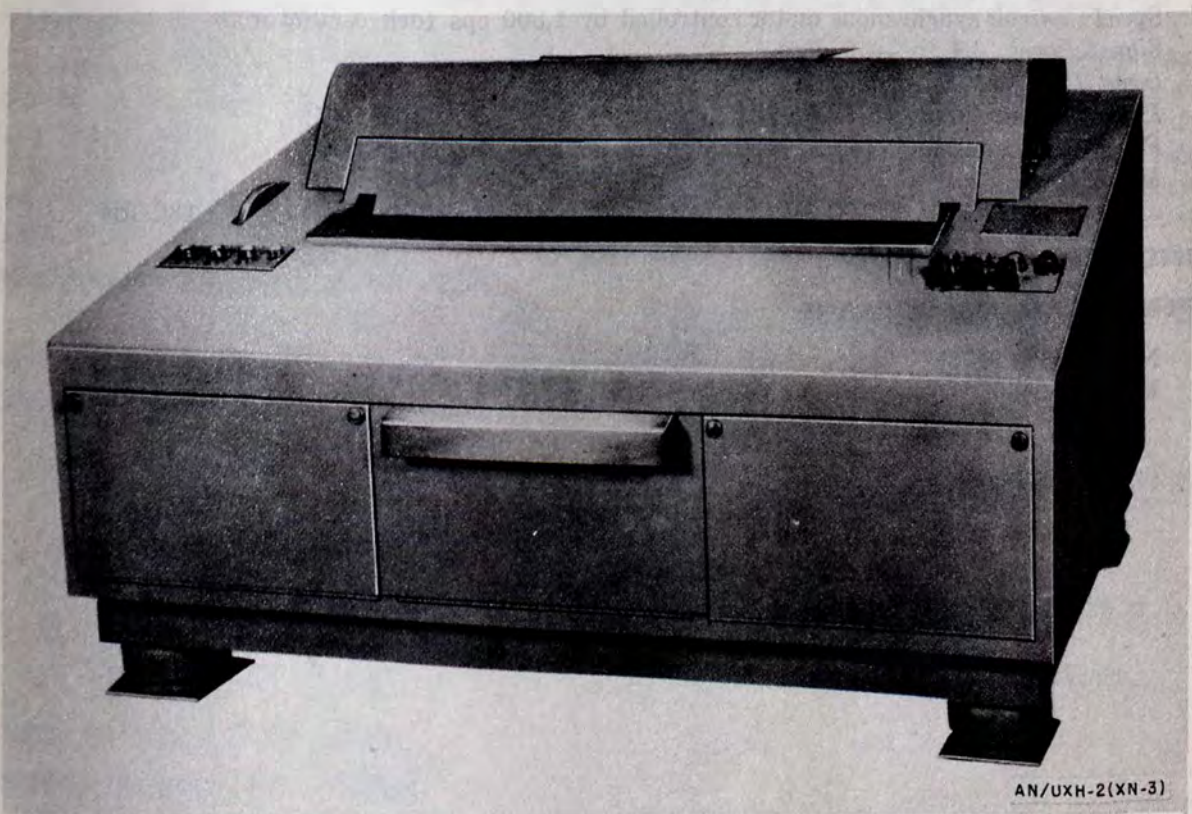
**FUNCTIONAL DESCRIPTION:**

Facsimile Recorder Set AN/UXH-2(XN-3) is a continuous web-type unit designed to automatically produce a record of information transmitted by facsimile. It permits long periods of unattended operation while recording data received from a transmitter capable of sending the proper control signals.

This equipment automatically compensates for changes in signal level between transmissions; it will automatically phase, and start the recording as well as stop the apparatus when the transmission is completed.

FACSIMILE RECORDER SET

AN/UXH-2(XN-3)

The control signal adapter of the AN/UHX-2(XN-1) is an accessory used between any one of the Facsimile Transmitters AN/TXC-1, AN/TXC-1A, AN/TXC-1B, AN/TXC-1C or AN/TXC-1D and the Facsimile Recorder Set AN/UXH-2(XN-3).

RELATIONSHIP TO SIMILAR EQUIPMENT:

TECHNICAL DESCRIPTION:

Recording Width: 18.85 in.

Type Recording: direct stylus

Scans Per Minute: 30, 60, 120

Type Modulation: am

Input Frequency: 450 cps to 2,700 cps

Speed Control: synchronous motor controlled by 1,800 cps fork oscillator

Signal Level: +4 to -36 dbm

Input Contrast: 8 to 16 db

Power Consumption: 270 w at 11-v or 230-v

Power Requirements: 115-v or 230-v, 45- to 65-cycle, 1-phase, ac

Major Units:

1 AN/UXH-2(XN-3)

16" x 21 $\frac{3}{4}$ " x 30"

180 lbs

TUBES, CRYSTALS, TRANSISTORS:

REFERENCE DATA AND LITERATURE:

NAVSHIPS 92735

MIL-F-19480

FACSIMILE RECORDER SET
AN/UXH-5(XN-1)

15 March 1962
 Cog. Serv: USN FSN:
 USA Line Item No.:

	USA	USN	USAF	USMC
STATUS OR TYPE CLASS.:		P/Std		
Manufacturer:	Westrex Corporation			

No Illustration Available

FUNCTIONAL DESCRIPTION:

The AN/UXH-5(XN-1) is a continuous page facsimile recorder designed to make a succession of direct recordings of maps, sketches, typewritten or printed information sent from a distant transmitter. The facsimile signals may be recorded directly from wire circuits, or from radio circuits if the paper auxiliary equipment is used. The recorder is designed for recording black and white copy. The recorder will automatically phase, adjust for optimum printing level, start, and stop is proper control signals are transmitted from the distant transmitter.

RELATIONSHIP TO SIMILAR EQUIPMENT:

The AN/UXH-5(XN-1) is a modified and improved version of the AN/UXH-2. It is interchangeable mechanically and electrically with the AN/UXH-2.

TECHNICAL DESCRIPTION:

Input Frequency: 600 to 4200 cps

Control Signal: 1800 to 3600 cps carrier modulated by 300 cps to start, 60 cps to start recorder, 450 cps to stop recorder.

Signal Level: +4 to -36 dbm

Input Impedance: 600 ohms

Operating Power Requirements: 115 or 230 v ac, 45 to 60 cps, single phase, 275 w

Major Units:

AN/UXH-5(XN-1)

16" x 30" x 21³/₄"

214 lbs

TUBES, CRYSTALS, TRANSISTORS:

REFERENCE DATA AND LITERATURE:

NAVSHIPS 94358

NAVSHIPS 93158(A)

Published by the American Statistical Association, 1110 North 17th Street, Washington, D.C. 20036

Subscription prices: Single copy \$3.00; Annual subscription \$28.00; Life membership \$1000.00

Copyright © 1964 by the American Statistical Association. All rights reserved.

The American Statistical Association is a non-profit organization devoted to the advancement of the science and practice of statistics. It publishes the *Journal of the American Statistical Association*, *Biometrics*, and *Journal of Business and Economic Statistics*.

For more information, contact the American Statistical Association, 1110 North 17th Street, Washington, D.C. 20036.

Subscription orders should be sent to the American Statistical Association, 1110 North 17th Street, Washington, D.C. 20036.

Single copies of the *Journal of the American Statistical Association* are available for purchase.

For a complete list of subscription rates and terms, please refer to the back cover of this volume.

Printed in the United States of America.

AMERICAN STATISTICAL ASSOCIATION

1110 North 17th Street, Washington, D.C. 20036

AUXILIARY INTERPHONE EQUIPMENT

AN/VIA-1

15 March 1962

Cog. Serv: USA FSN: 5830-539-7728

USA Line Item No.: 621274

USA

USN

USAF

USMC

STATUS OR TYPE CLASS.:

Std-B

Manufacturer:

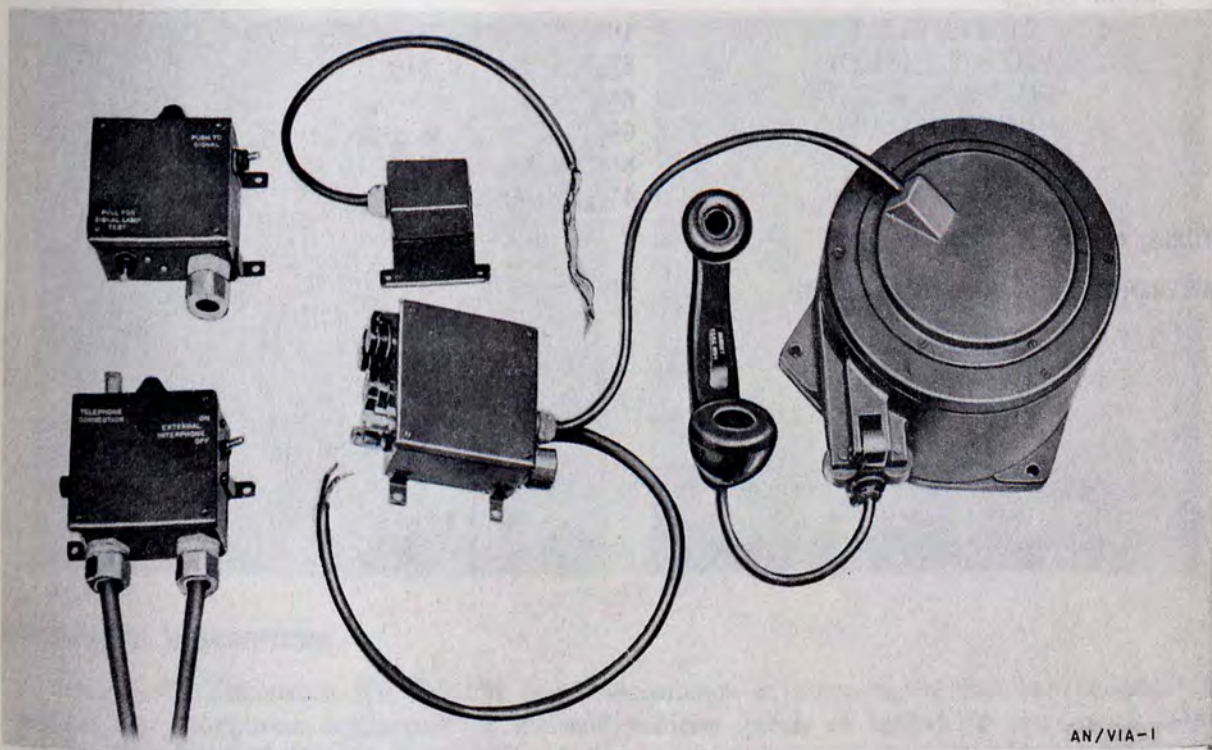

AN/VIA-1

FUNCTIONAL DESCRIPTION:

Auxiliary Interphone Equipment AN/VIA-1 is an assemblage of components used to extend a vehicular interphone system to the exterior of the vehicle. It is used in inclosed or armored vehicles.

This equipment consists essentially of interphone station control units that are installed within the vehicle, and a cable reel which includes a handset and a control unit designed to be mounted on the exterior of the vehicle to provide an outside interphone station.

The stations of this system have call signal lamps to indicate that control with the exterior station is desired.

The only adjustment provided is for control of volume.

The equipment is powered by the electrical system of the vehicle in which it is installed.

AUXILIARY INTERPHONE EQUIPMENT

AN/VIA-1

RELATIONSHIP TO SIMILAR EQUIPMENT:

Facilities: Can be used with Radio Sets SCR-508, -528, -608, -628, or AN-VRC-3 or with Interphone Equipment RC-99 or similar types of units.

Type Controls:

- C-663: external interphone ON-OFF switch
- C-664: external interphone PUSH TO SIGNAL switch
- C-665: VOLUME

Power Output: dependent on interphone system

Power Requirements: draws required power from system to which it is connected.

Major Units:

1	RL-149/VIA-1	$10\frac{3}{16}$ " x $9\frac{13}{16}$ " x $5\frac{13}{16}$ "
1	MTS-1 (USMC)	$8\frac{7}{8}$ " x $2\frac{3}{4}$ " x $3\frac{1}{2}$ "
1	C-663/VIA-1	$6\frac{3}{8}$ " x $4\frac{7}{16}$ " x $5\frac{15}{16}$ "
1	C-664/VIA-1	$6\frac{3}{16}$ " x $6\frac{9}{16}$ " x $2\frac{17}{32}$ "
1	C-665/VIA-1	$8\frac{1}{2}$ " x $5\frac{5}{8}$ " x $3\frac{13}{16}$ "
1	C-666/VIA-1	$4\frac{7}{16}$ " x $4\frac{3}{32}$ " x $1\frac{11}{16}$ "

TUBES, CRYSTALS, TRANSISTORS:

REFERENCE DATA AND LITERATURE:

TM 11-704

AN/VIC-type
INTERPHONE EXTENSION KIT

RC-298

15 March 1962

Cog. Serv: USA FSN: 5830-222-1662

USA Line Item No.: 621890

USA

USN

USAF

USMC

STATUS, OR TYPE CLASS.: Std-B

Manufacturer:

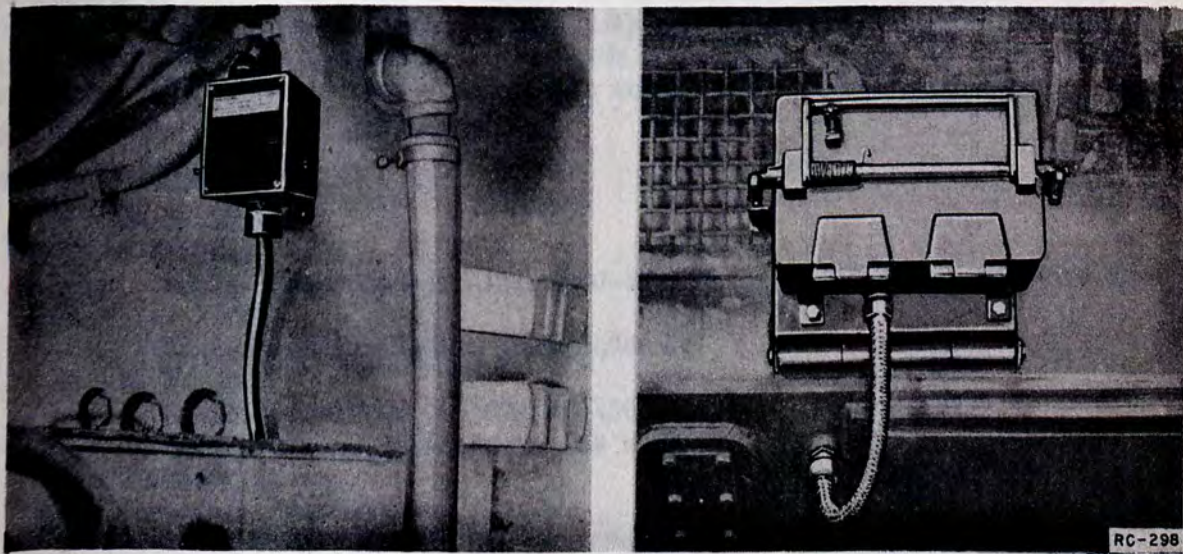
**FUNCTIONAL DESCRIPTION:**

Interphone Extension Kit RC-298 is an assemblage of components that can be added to the existing interphone equipment of inclosed vehicles (such as tanks) to provide an interphone station located outside the vehicle. It is used in conjunction with interphone systems designed for use in armored vehicles.

This equipment consists of an external interphone box, an internal interphone switchbox, and related components. The only adjustment provided is for control of volume. Internal and external interphone stations have call signal lamps to indicate that contact with the station outside the vehicle is desired.

RELATIONSHIP TO SIMILAR EQUIPMENT:**TECHNICAL DESCRIPTION:***Type of Signal:* voice*Type of Communication Circuits:* two-way; press-to-talk*Controls:* volume only (on external interphone station)*Power Requirements:* vehicular storage battery

**AN/VIC-type
INTERPHONE EXTENSION KIT**

RC-298

Major Units:

- 1 Cordage CO-213
- 1 Box BC-1362
- 1 BC-1361
- 1 ST52R

TUBES, CRYSTALS, TRANSISTORS:

REFERENCE DATA AND LITERATURE:

TM 11-703

15 March 1962

Cog. Serv: USN FSN: 5820-196-1736

USA Line Item No.: 648200

USA

USN

USAF

USMC

STATUS OR TYPE CLASS.:**Manufacturer:****FUNCTIONAL DESCRIPTION:**

Radio Set AN/VRC-1 is a vehicular mounted equipment used by ground organizations in the control of tactical aircraft. Normally, the hf section is used for communication within a ground point-to-point net. The hf section may also be used as a beacon for radio compass equipped aircraft, and for communication with hf equipped aircraft. The vhf section is normally used for ground-air communication with aircraft fitted with vhf equipment.

RELATIONSHIP TO SIMILAR EQUIPMENT:**TECHNICAL DESCRIPTION:***Frequency Range:*

hf Section:

Radio Transmitter BC-191: 3000-4500 kc using TV-6 and 4500-6000 kc using TV-7

Radio Receiver BC-312: 1500-18,000 kc

vhf Section:

Radio Transmitter BC-625: 10-156 mc

Radio Receiver BC-624: 100-156 mc

Type Modulation: am*Type Signals Transmitted and Received:*

hf section, Radio Set SCR-193: cw, tone, voice

vhf section, Radio Set SCR-542: voice

Power Supply: 12 volt vehicular storage battery and dynamotors

hf Section

Dynamotor BD-77

Input: 12 v, 40 amp

Output: 1000 v, 350 ma

Dynamotor DM-21

Input: 12 v, 2.7 amp

Output: 300 v, 260 ma; 150 v, 10 ma; 13 v, 3.9 amp

Power Output:

HF Section: 40-75 w

VHF Section: 8-9 w

Major Units:

1 BC-191
1 BC-312
1 BC-625
1 BC-624
1 BC-602
1 BC-606

RADIO SET

AN/VRC-1

TUBES, CRYSTALS, TRANSISTORS:

REFERENCE DATA AND LITERATURE:

TM 11-277

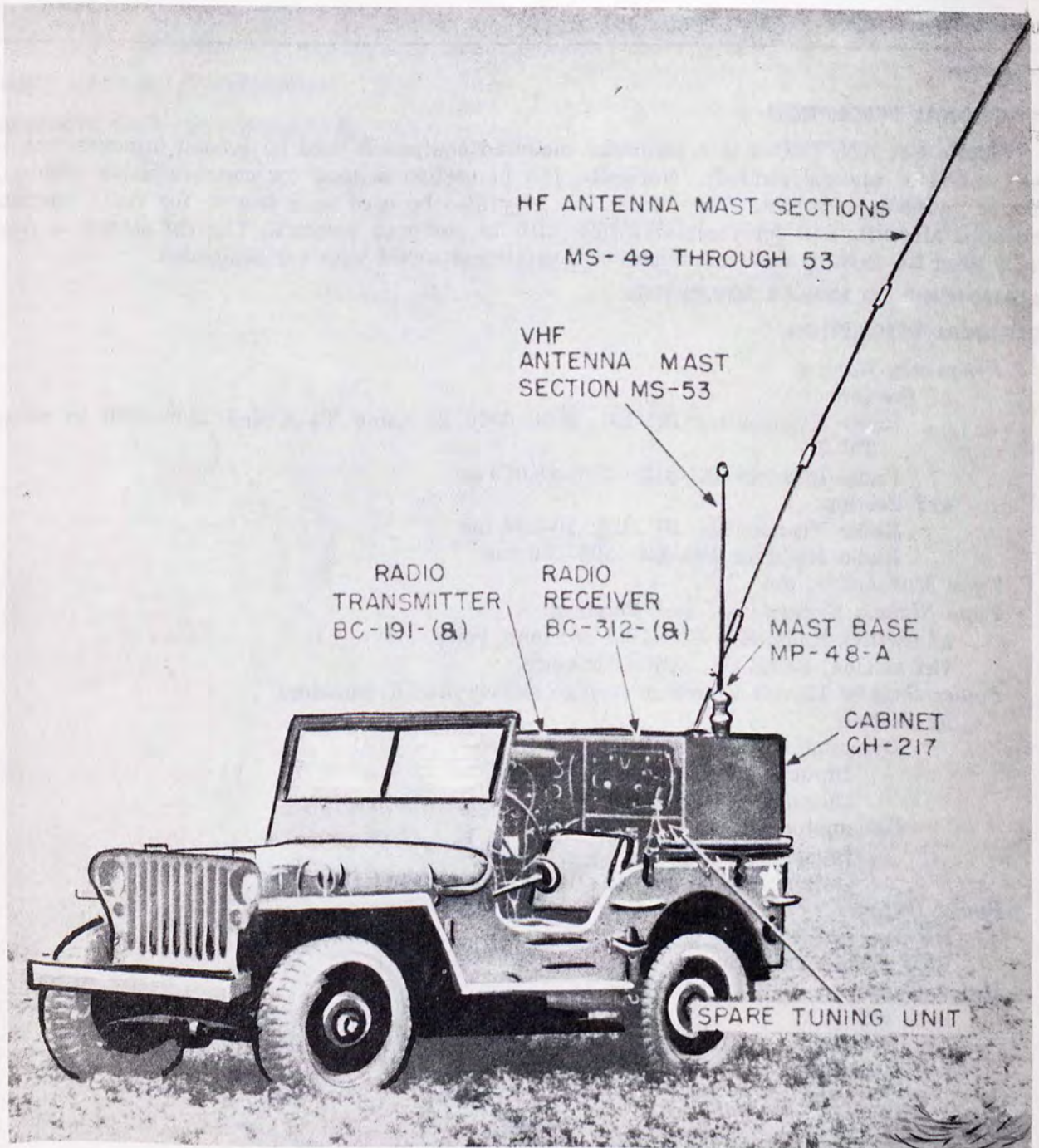

RADIO SET
AN/VRC-2, -2X, -26, -26X

15 March 1962

Cog. Serv: USN FSN: AN/VFC-2 5820-644-4997
 AN/VRC-2X 5820-230-3958
 AN/VRC-26
 AN/VRC-26X 5820-644-4900

USA Line Item No.: 648300

USA

USN

USAF

USMC

STATUS OR TYPE CLASS.: AN/VRC-2()
 Std-C

Manufacturer: AN/VRC-2, 26 CGG (24009)
 AN/VRC-2X, 26X CBZM (82892)

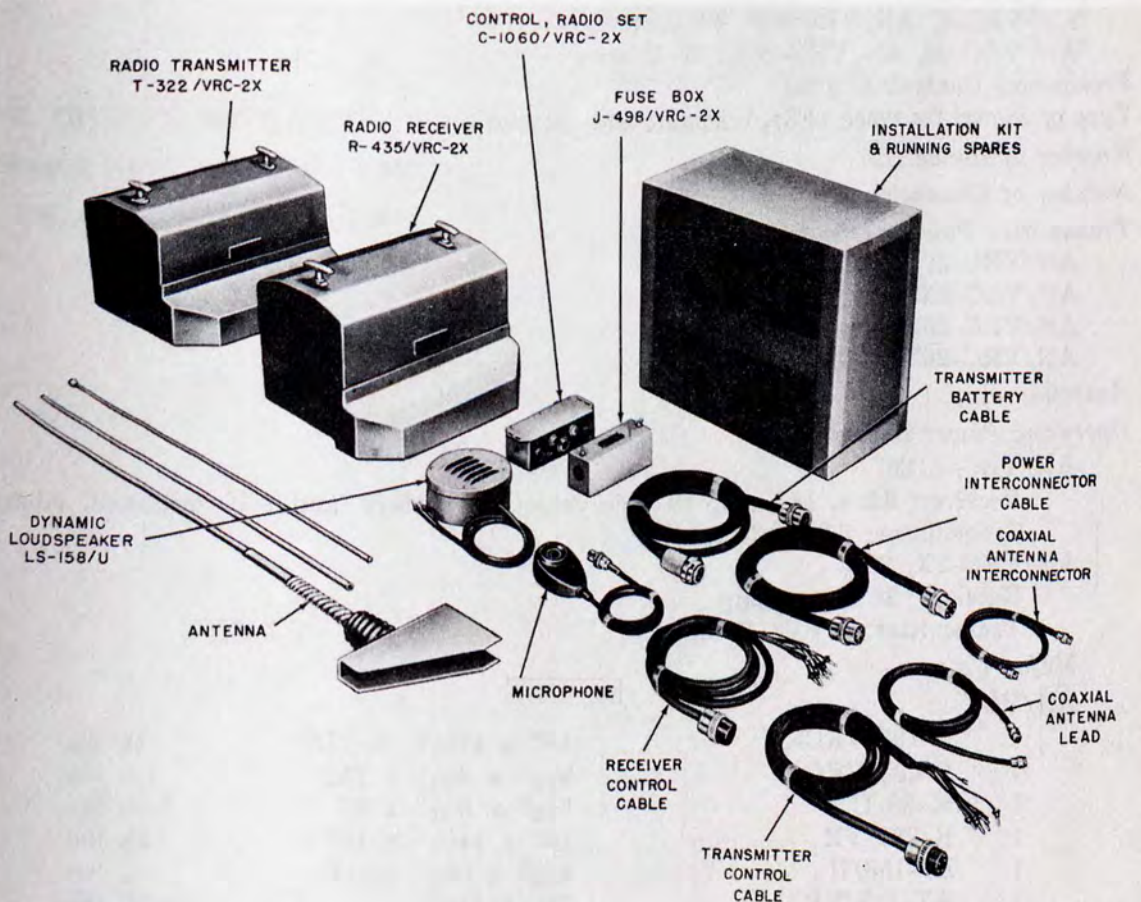

AN/VRC-2X

RADIO SET

AN/VRC-2, -2X, -26, -26X

FUNCTIONAL DESCRIPTION:

These fm equipments are complete radio sets, less primary power source. They are for vehicular operation, and provide two-way voice communication with similar fixed or mobile equipments operating at the same frequency. The radio set is preset for a single frequency. The frequency may be changed by changing the crystal frequency control. In open terrain, the reliable communications range is up to 15 miles.

RELATIONSHIP TO SIMILAR EQUIPMENT:

AN/VRC-2 is similar to AN/VRC-2X, except for the required power source. Completion of Field Change 1 changes the frequency range from 30-40 mc to 32-42 mc and the type designation from AN/VRC-2, AN/VRC-2X to AN/VRC-26 and AN/VRC-26X, respectively.

TECHNICAL DESCRIPTION:

Frequency Range:

AN/VRC-2, AN/VRC-2X: 30-40 mc

AN/VRC-26, AN/VRC-26X: 32-42 mc

Frequency Control: Crystal*Type of Signal* fm voice (F3), transmit and receive*Number of Bands:* 1*Number of Channels:* 1*Transmitter Power Output:*

AN/VRC-2: 25 w

AN/VRC-2X: 30 w

AN/VRC-26: 25 w

AN/VRC-26X: 30 w

Antenna: whip*Operating Power Requirements:*

AN/VRC-2, 26:

Receiver: 6.3 v, 14.5 amp (6 v dc vehicular battery and self-contained vibrator)

Transmitter: 6.3 v, 25 amp

AN/VRC-2X, 26X

Receiver: 24 v dc, 3 amp

Transmitter: 24 v dc, 10 amp

Major Units:

AN/VRC-2:

1	T-193/VRC-2	10" x 11½" x 15"	41 lbs
1	C-493/VRC-2	2½" x 3¼" x 7¼"	1.5 lbs
1	M-38/U	3½" x 3¾" x 5"	1.25 lbs
1	R-237/VR	10" x 11½" x 15"	35 lbs
1	LS-158/U	4¼" x 9½" (dia)	5 lbs
1	AT-129/VR	78" x 1½"	3.25 lbs

AN/VRC-2X:

1	T-322/VRC-2X	10" x 11½" x 15"	41 lbs
1	C-1060/VRC-2	2½" x 3¼" x 7¼"	1.5 lbs
1	R-435/VRC-2X	10" x 11½" x 15"	35 lbs

AN/VRC-2, -2X, -26, -26X

1	M-38/U	3½" x 3¾" x 5"	1.25 lbs
1	LS-158/U	4¼" x 9½" (dia)	5 lbs
1	AT-129/VR	78" x 1½" x 1½"	3.25 lbs
AN/VRC-26:			
1	T-193()/VRC-2	10" x 11½" x 15"	41 lbs
1	R-237()/VR	10" x 11½" x 15"	35 lbs
1	C-493()/VRC-2	2½" x 3¼" x 7¼"	1.5 lbs
1	AT-129()/VRC-2	78" x 1½" x 1½"	3.25 lbs
1	M-38/U	3½" x 3¾" x 5"	1.25 lbs
1	LS-158/U	4¼" x 9½" (dia)	5 lbs
AN/VRC-26X:			
1	T-540/VRC-26X	10" x 11½" x 15"	41 lbs
1	R-435/VRC-2X	10" x 11½" x 15"	35 lbs
1	C-1060/VRC-2X	2¼" x 3¼" x 7¾"	1.5 lbs
1	M-38/U	3½" x 3¾" x 5"	1.25 lbs
1	LS-158/U	4¼" x 9½" (dia)	5 lbs
1	AT-129/UR	78" x 1½" x 1½"	3.25 lbs

TUBES, CRYSTALS, TRANSISTORS:**REFERENCE DATA AND LITERATURE:**

TM 11-607, TO 16-30VRC2-5

SECRET

ANNEX I - IX - 100

Item No.	Description	Quantity	Unit	Remarks
1	M-200	1	EA	
2	
3	
4	
5	
6	
7	
8	
9	
10	
11	
12	
13	
14	
15	
16	
17	
18	
19	
20	
21	
22	
23	
24	
25	
26	
27	
28	
29	
30	
31	
32	
33	
34	
35	
36	
37	
38	
39	
40	
41	
42	
43	
44	
45	
46	
47	
48	
49	
50	

THE LIST IS SUBJECT TO CHANGE WITHOUT NOTICE.
 REFERENCE DATA AND DESCRIPTIONS
 THESE CRYSTAL TRANSDUCERS

RADIO SET
AN/VRC-3

15 March 1962

Cogn. Serv: USN FSN: 5820-196-1735

USA Line Item No.: 648400

USA

USN

USAF

USMC

STATUS OR TYPE CLASS.:

Std-C

Manufacturer:

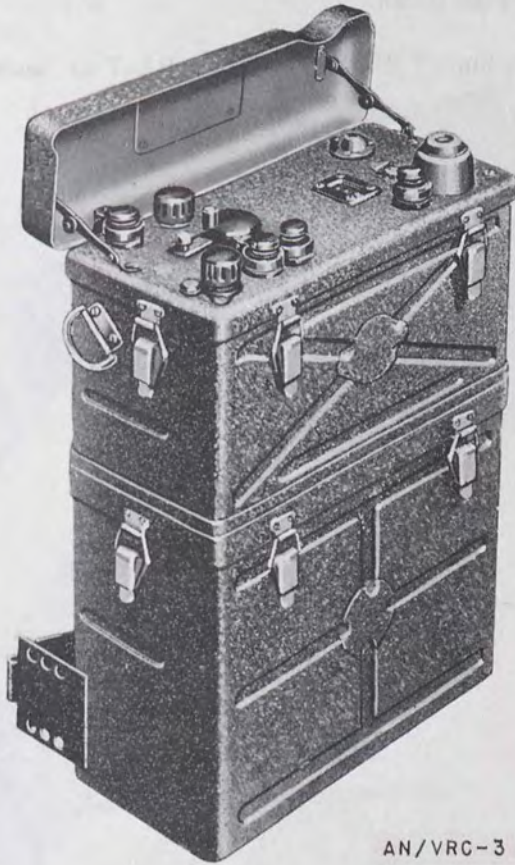

AN/VRC-3

FUNCTIONAL DESCRIPTION:

Radio Set AN-VRC-3 is a vehicular mounted fm equipment used for two-way communication over short distances. It is primarily intended for installation in light and medium tanks to provide communications between tanks and supporting infantry.

RADIO SET

AN/VRC-3

RELATIONSHIP TO SIMILAR EQUIPMENT:

Similar to Radio Set SCR-300, with the addition of special mounting brackets.

TECHNICAL DESCRIPTION:

Transmitter:

Frequency Range: 40-48 mc

Power Output: 0.3 w

Receiver:

Frequency Range: 40-48 mc

Power Output: 2 mw

Modulation: frequency

Frequency Control: master oscillator

Range: 3 miles

Operating Power: Power Supply PP-114/VRC-3, BA-7 or loaded Battery Case CS-139

Major units:

1 BC-1000-A

11 $\frac{5}{16}$ " x 7 $\frac{1}{8}$ " x 5 $\frac{5}{8}$ "

13 lbs

TUBES, CRYSTALS, TRANSISTORS:

REFERENCE DATA AND LITERATURE:

TM 11-487A

TM 11-637

RADIO SET

AN/VRC-6()

15 March 1962

Cog. Serv: USA FSN: 5820-096-7009

USA Line Item No.: 648700

USA

USN

USAF

USMC

STATUS OR TYPE CLASS.:

Std-A

Manufacturer: Motorola, Inc

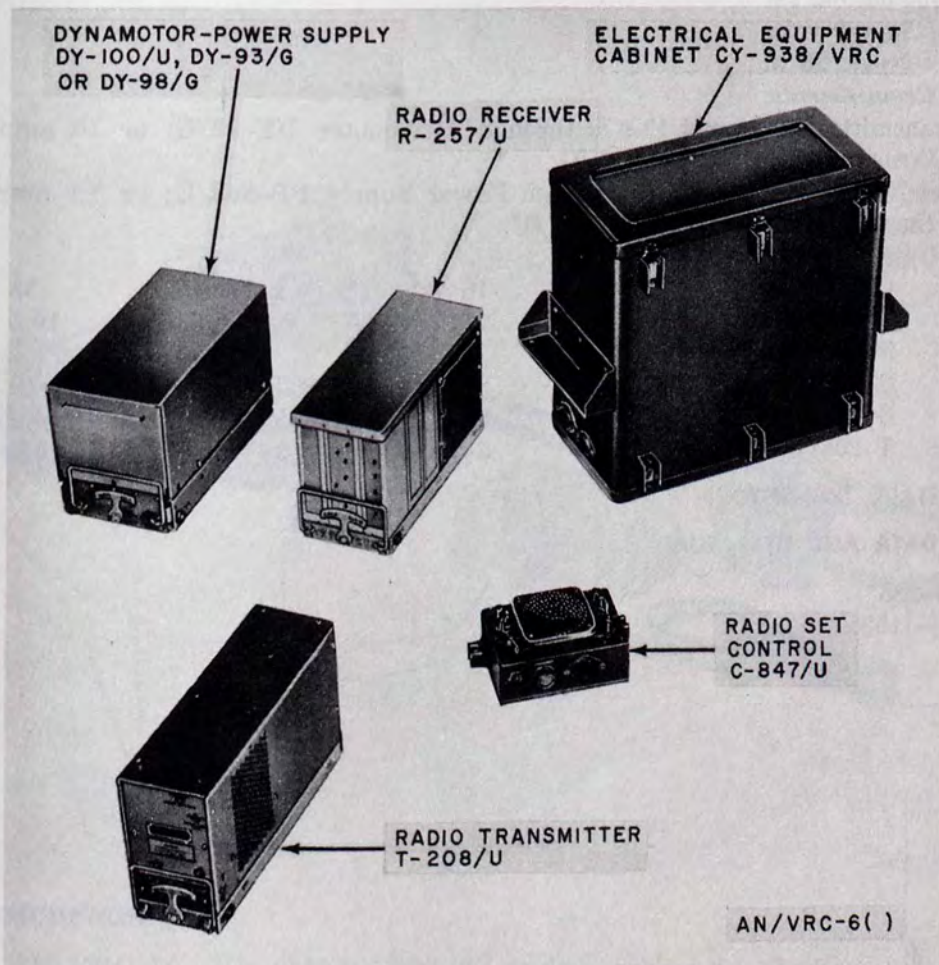
**FUNCTIONAL DESCRIPTION:**

Radio Set AN/VRC-6() is vehicular, hf, fm (voice) receiving and transmitting equipment used for nontactical radio communication with other vehicular and/or fixed stations, including civilian police authorities.

RADIO SET

AN/VRC-6()

This equipment consists essentially of receiving and transmitting components, each with its own power supplies and associated components. It can be push-to-talk operated from a remote point by means of suitable remote control equipment.

The AN/VRC-6 and AN/VRC-6X enable operation from storage battery sources of 24 or 12 volts, respectively.

RELATIONSHIP TO SIMILAR EQUIPMENT:**TECHNICAL DESCRIPTION:**

Frequency Range in Mc: 25 to 50

Type Modulation: fm

Type of Signal: voice

Power Output: 25 w

Power Requirements:

Transmitter: 20 amp at 12-v dc through Dynamotor DY-93/G; or 10 amp at 24-v dc through Dynamotor DY-98/G

Receiver: 2 amp at 12-v dc through Power Supply PP-868/U; or 1.1 amp at 24-v dc through Power Supply PP-867/U

Major Units:

1	CY-938/VRC	16 $\frac{1}{2}$ " x 10 $\frac{1}{2}$ " x 19 $\frac{1}{4}$ "	33 lbs
1	MT-1236/VRC	7 $\frac{3}{4}$ " x 10 $\frac{3}{4}$ " x 23 $\frac{1}{2}$ "	10.5 lbs
1	PP-868/U or PP-867/U		
1	R-257/U	8 $\frac{1}{2}$ " x 5 $\frac{3}{4}$ " x 14 $\frac{1}{2}$ "	16 lbs
1	C-847/U	5" x 2 $\frac{1}{4}$ " x 7 $\frac{1}{2}$ "	4.5 lbs
1	T-208/U	8 $\frac{1}{2}$ " x 4 $\frac{1}{2}$ " x 14 $\frac{1}{2}$ "	8.5 lbs

TUBES, CRYSTALS, TRANSISTORS:**REFERENCE DATA AND LITERATURE:**

TM 11-283

MIL-N-11539

RADIO SET
AN/VRC-7()

15 March 1962

Cog. Serv: USA FSN: 5820-196-8996

USA Line Item No.: 648800

USA

USN

USAF

USMC

STATUS OR TYPE CLASS.:

Std-B

Manufacturer:

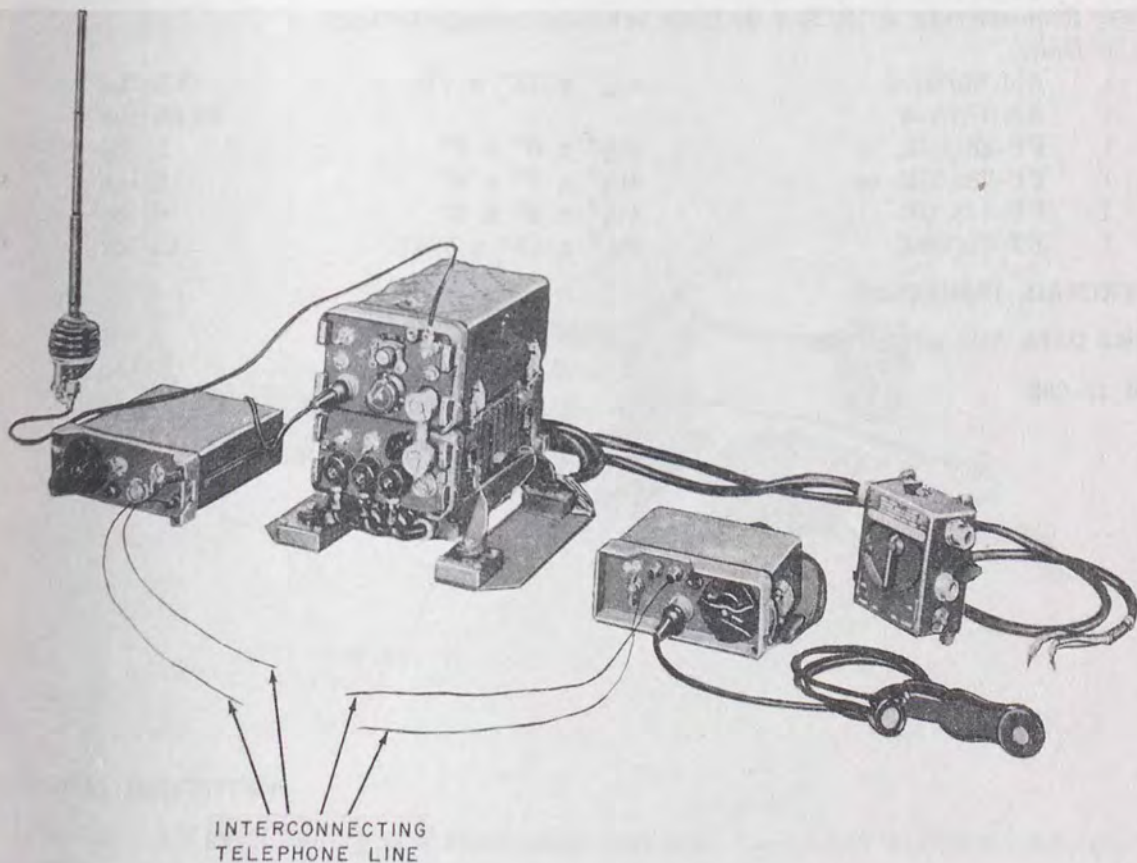

AN/VRC-7

FUNCTIONAL DESCRIPTION:

Radio Set AN/VRC-7() is a short-range, fm (voice), vehicular radiotelephone equipment used within and among artillery, infantry, and armored force units.

This set consists of a separate, short-range, low-power receiver-transmitter component, designated as Set 2 when used as part of the integrated series of radio sets, such as the AN/GRC-3 through AN/GRC-8.

It includes a vehicular installation unit power supply equipment, and an interphone amplifier, plus various control and accessory equipment such as microphone, headset, and loudspeaker.

RADIO SET

AN/VRC-7()

It can be operated by means of Control Group AN/GRA-6 from a remote point up to a distance of about 2 miles over a telephone pair.

RELATIONSHIP TO SIMILAR EQUIPMENT:

TECHNICAL DESCRIPTION:

Frequency Range in Mc: 47.0 to 58.4

Type Modulation: fm

Type of Signal: voice

Power Output: 500 mw

Power Requirements: 6/12/24-v dc from vehicular storage battery

Major Units:

1	AM-65/GRC	4 $\frac{1}{4}$ " x 13" x 7 $\frac{7}{8}$ "	15.5 lbs
1	AN/GRA-6		20.85 lbs
1	PP-281/GR, or	4 $\frac{1}{2}$ " x 6" x 3"	6 lbs
1	PP-282/GR, or	4 $\frac{1}{2}$ " x 6" x 3"	6 lbs
1	PP-448/GR	4 $\frac{1}{2}$ " x 6" x 3"	6 lbs
1	RT-70/GRC	4 $\frac{3}{4}$ " x 13" x 7 $\frac{1}{8}$ "	45 lbs

TUBES, CRYSTALS, TRANSISTORS:

REFERENCE DATA AND LITERATURE:

TM 11-285

RADIO SET

AN/VRC-8()

15 March 1962

Cof. Serv: USA FSN: 5820-196-1718

USA Line Item No.: 648900

USA

USN

USAF

USMC

STATUS OR TYPE CLASS.:

Std-B

Manufacturer:

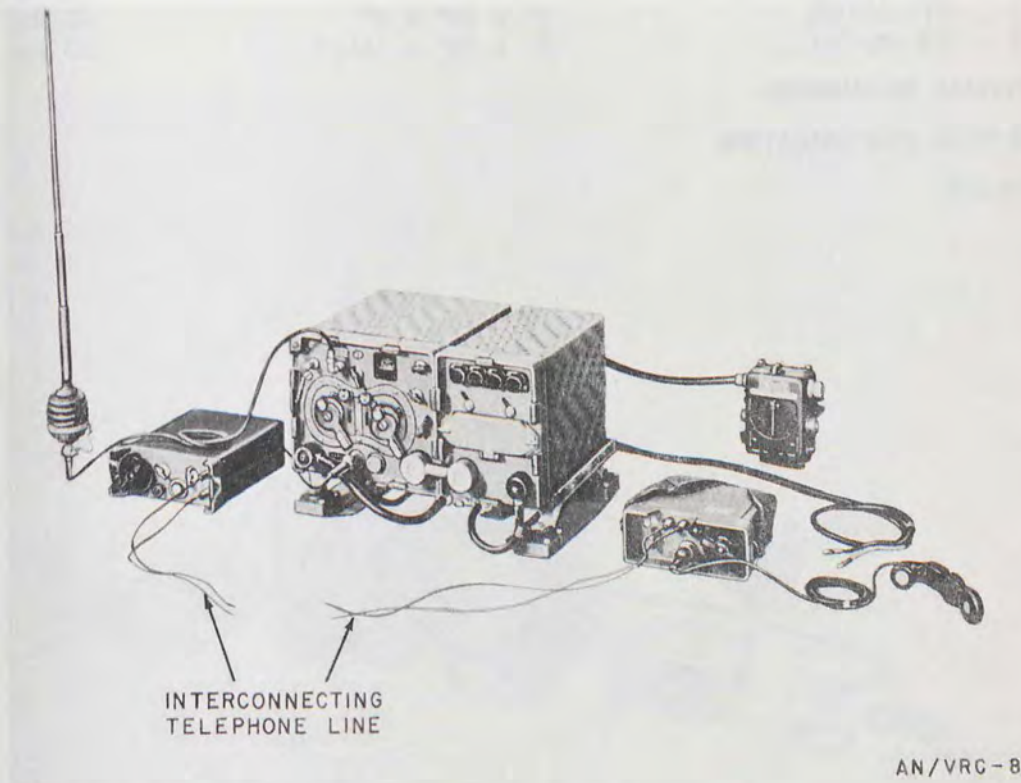

AN/VRC-8

FUNCTIONAL DESCRIPTION:

Radio Set AN/VRC-8() is a short-range vehicular fm (voice) equipment for communication within and between armored units.

This set consists of a receiver-transmitter component designated as Set 1 when used as part of the integrated series of radio sets, such as the AN/GRC-3 and AN/GRC-4. A vehicular installation unit, power supply equipment, plus control and accessory components are included.

This equipment can be operated from a remote point up to a distance of about 2 miles over a telephone pair, by means of Control Group AN/GRA-6.

RELATIONSHIP TO SIMILAR EQUIPMENT:**TECHNICAL DESCRIPTION:**

Frequency Range in Mc: 20.0 to 27.9

Type Modulation: fm

RADIO SET

AN/VRC-8()

Type of Signal: voice

Power Output:

High Power: 9 to 16 w

Low Power: 2 w

Power Requirements: 12/24-v dc from vehicular storage battery

Major Units:

1	AN/GRA-6		20.85 lbs
1	PP-109/GR, or	8" x 13" x 9"	33 lbs
1	PP-112/GR	8" x 13" x 9"	33 lbs
1	RT-66/GRC	9" x 13" x 11 ¹ / ₄ "	35 lbs

TUBES, CRYSTALS, TRANSISTORS:

REFERENCE DATA AND LITERATURE:

TM 11-286

RADIO RECEIVING SET

AN/VRC-9()

15 March 1962

Cog. Serv: USA FSN: 5820-193-8809

USA Line Item No.: 649000

USA

USN

USAF

USMC

STATUS OR TYPE CLASS.:

Std-B

Manufacturer:

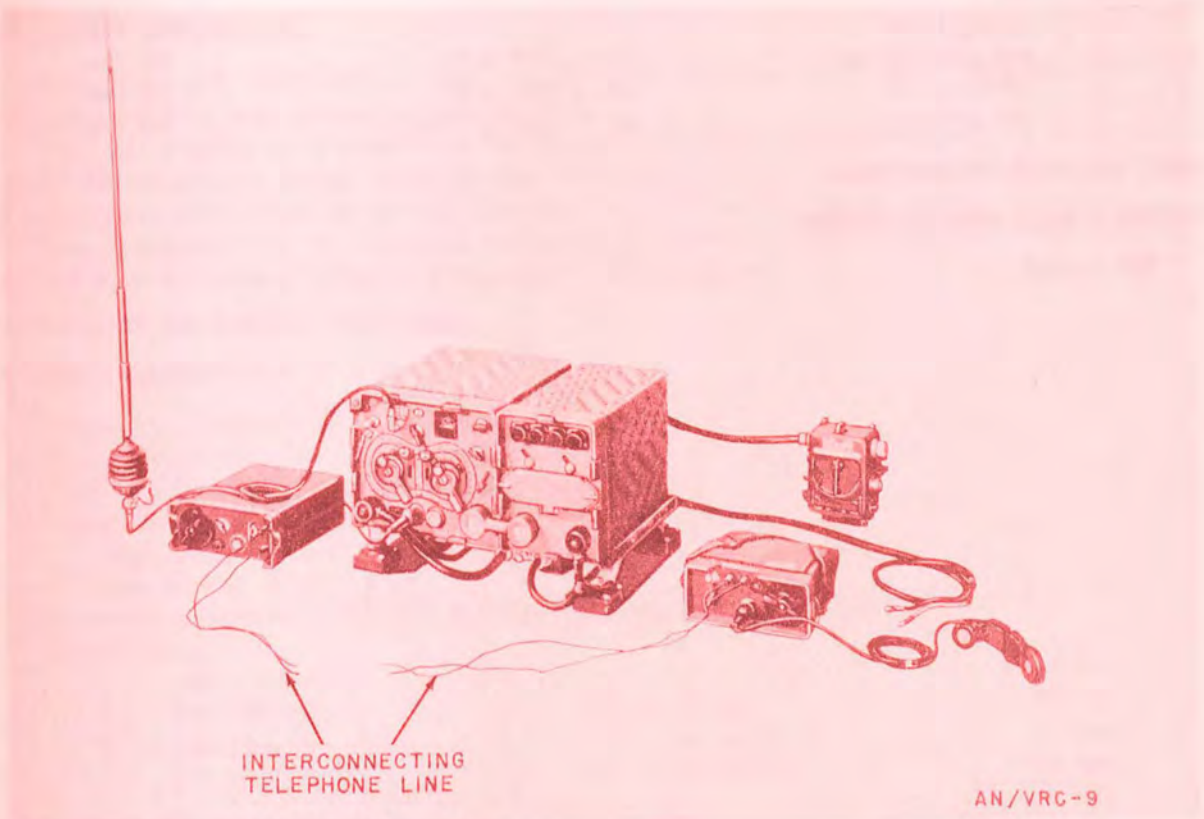

AN/VRC-9

FUNCTIONAL DESCRIPTION:

Radio Set AN/VRC-9() is a short range, vehicular, fm (voice) equipment for communication within and between artillery units.

This set consists of the receiver-transmitter component designated as Set 1 when used as part of the integrated series of radio sets, such as the AN/GRC-6. A vehicular installation unit, power supply equipment, plus control and accessory items are included.

This equipment can be operated by means of Control Group AN/GRA-6 from a remote point up to a distance of about 2 miles over a telephone pair.

RADIO SET

AN/VRC-9()

RELATIONSHIP TO SIMILAR EQUIPMENT:

TECHNICAL DESCRIPTION:

Frequency Range in Mc: 27.0 to 38.9

Type Modulation: fm

Type of Signal: voice

Power Output:

High Power: 9 to 16 w

Low Power: 2 w

Power Requirements: 12/24-v dc from vehicular storage battery

Major Units:

1	AN/GRA-6		20.8 lbs
1	PP-109/GR, or	8" x 13" x 9"	33 lbs
1	PP-112/GR	8" x 13" x 9"	33 lbs
1	RT-67/GRC	9" x 13" x 11½"	35 lbs

TUBES, CRYSTALS, TRANSISTORS:

REFERENCE DATA AND LITERATURE:

TM 11-286

RADIO SET
AN/VRC-10()

15 March 1962

Cog. Serv: USA FSN: 5820-196-1721

USA Line Item No.: 649100

	USA	USN	USAF	USMC
STATUS OR TYPE CLASS.:	Std-B			

Manufacturer:

For illustration see AN/VRC-15, page 917.

FUNCTIONAL DESCRIPTION:

Radio Set AN/VRC-10() is a short-range, vehicular, fm (voice) equipment for communication within and between infantry units.

This set consists of the receiver-transmitter components, designated as Set 1 when used as part of the integrated series of radio sets, such as the AN/GRC-7 and AN/GRC-8. A vehicular installation unit, power supply equipment, plus control and accessory items are include.

This equipment can be operated by means of Control Group AN/GRA-6 from a remote point up to a distance of about 2 miles over a telephone pair.

RELATIONSHIP TO SIMILAR EQUIPMENT:**TECHNICAL DESCRIPTION:***Frequency Range in Mc:* 38.0 to 54.9*Type Modulation:* fm*Type of Signal:* voice*Power Output:*

High Power: 9 to 16 w

Low Power: 2 w

Power Requirements: 12/24 v dc from vehicular storage battery*Major Units:*

1	AN/GRA-6		20.85 lbs
1	PP-109/GR	8" x 13" x 9"	33 lbs
1	PP-112/GR	8" x 13" x 9"	33 lbs
1	RT-68/GRC	8" x 13" x 11 $\frac{1}{4}$ "	35 lbs

TUBES, CRYSTALS, TRANSISTORS:**REFERENCE DATA AND LITERATURE:**

TM 11-286

ANNUAL REPORT

Department of Defense

Report No. DA-100-100

100-100-100-100
100-100-100-100
100-100-100-100

STATUS OF THIS CASE	DATE	BY	REMARKS

100-100-100-100

TECHNICAL DESCRIPTION

Model AN-VTU-100 is a single-stage vehicle. The overall dimensions for the vehicle are 100" x 100" x 100". The vehicle is a single-stage vehicle. The overall dimensions for the vehicle are 100" x 100" x 100". The vehicle is a single-stage vehicle. The overall dimensions for the vehicle are 100" x 100" x 100".

RELATIONSHIP TO SIMILAR EQUIPMENT

TECHNICAL DESCRIPTION

1. Primary Power to Model is 100 W
 2. Secondary Power to Model is 100 W
 3. Power to Model is 100 W
 4. Power to Model is 100 W
 5. Power to Model is 100 W
 6. Power to Model is 100 W
 7. Power to Model is 100 W
 8. Power to Model is 100 W
 9. Power to Model is 100 W
 10. Power to Model is 100 W

Model	Power	Dimensions
AN-012-0	100 W	100" x 100" x 100"
1-9-100-01	100 W	100" x 100" x 100"
1-11-100-01	100 W	100" x 100" x 100"
1-11-100-01	100 W	100" x 100" x 100"

TECHNICAL TRANSMISSION

REFERENCE DATA AND LITERATURE

100-100-100-100

100-100-100-100

100-100-100-100

100-100-100-100

100-100-100-100

100-100-100-100

RADIO SET
AN/VRC-13()

15 March 1962

Cog. Serv: USA FSN: 5820-192-7133

USA Line Item No. 649300

	USA	USN	USAF	USMC
STATUS OR TYPE CLASS.:	Std-B			

Manufacturer:

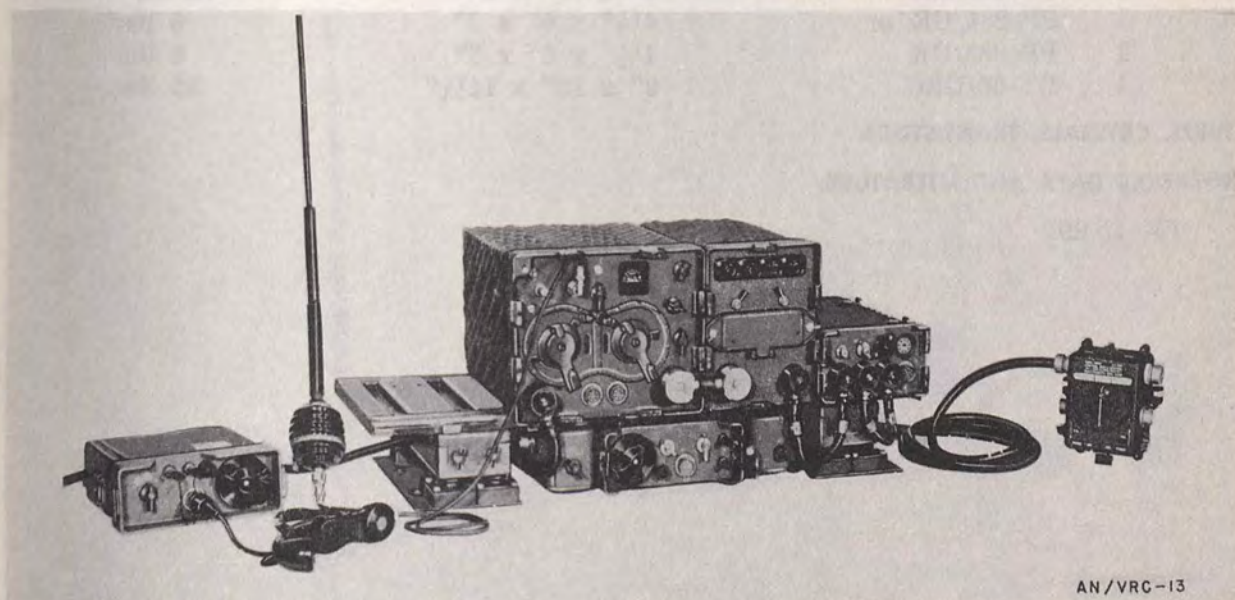

AN/VRC-13

FUNCTIONAL DESCRIPTION:

Radio Set AN/VRC-13() is a short-range, vehicular, fm (voice) equipment for communication within and between armored units.

This set consists of the receiver-transmitter component, designated as Set 1 when used as part of the integrated series of radio sets, such as the AN/GRC-3 and AN/GRC-4. A vehicular installation unit, power-supply equipment, interphone amplifier, antenna, and accessory components are included.

This equipment can be operated by means of Control Group AN/GR A-6 from a remote point up to a distance of about 2 miles over a telephone pair.

RELATIONSHIP TO SIMILAR EQUIPMENT:**TECHNICAL DESCRIPTION:**

Frequency Range in Mc: 20.0 to 27.9

Type Modulation: fm

Type of Signal: voice

RADIO SET

AN/VRC-13()

Power Output:

High Power: 9 to 16 w

Low Power: 2 w

Power Requirements: 12/24-vdc from vehicular storage battery.*Major Units:*

1	AM-65/GRC	4 $\frac{1}{4}$ " x 13" x 7 $\frac{7}{8}$ "	15.5 lbs
1	AN/GR A-6		20.85 lbs
1	PP-109/GR, or	8" x 13" x 9"	33 lbs
1	PP-112/GR	8" x 13" x 9"	33 lbs
1	PP-281/GR, or	4 $\frac{1}{2}$ " x 6" x 3"	6 lbs
1	PP-282/GR	4 $\frac{1}{2}$ " x 6" x 3"	6 lbs
1	RT-66/GRC	9" x 13" x 11 $\frac{1}{4}$ "	35 lbs

TUBES, CRYSTALS, TRANSISTORS:

REFERENCE DATA AND LITERATURE:

TM 11-291

RADIO SET
AN/VRC-14()

15 March 1962

Cog. Serv: USA FSN: 5820-197-6532

USA Line Item No.: 649400

	USA	USN	USAF	USMC
STATUS OR TYPE CLASS.:	Std-B			

Manufacturer:

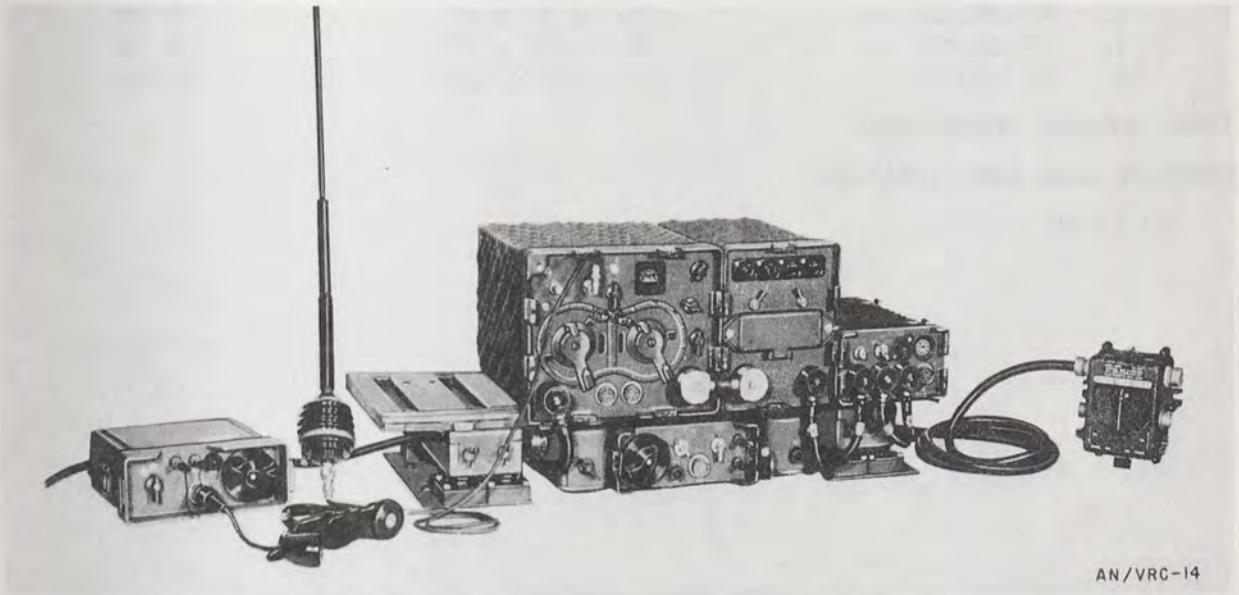

AN/VRC-14

FUNCTIONAL DESCRIPTION:

Radio Set AN/VRC-14 is a short-range, vehicular, fm (voice) equipment for communication within and between artillery units.

This set consists of a receiver-transmitter component, designated as Set 1 when used as part of the integrated series of radio sets, such as the AN/GRC-5 and AN/GRC-6. A vehicular installation unit, interphone amplifier equipment, power supply equipment, plus control and accessory items are included.

This equipment can be operated by means of Control Group AN/GRA-6 from a remote point up to a distance of about 2 miles over a telephone pair.

RELATIONSHIP TO SIMILAR EQUIPMENT:**TECHNICAL DESCRIPTION:**

Frequency Range in Mc: 27.0 to 38.9

Type Modulation: fm

Type of Signal: voice

RADIO SET

AN/VRC-14()*Power Output:*

High Power: 9 to 16 w

Low Power: 2 w

Power Requirements: 12/24 v dc from vehicular storage battery*Major Units:*

1	AM-65/GRC	4 $\frac{1}{4}$ " x 13" x 7 $\frac{7}{8}$ "	15.5 lbs
1	C-375/VRC	7" x 4" x 7"	3.5 lbs
1	AN/GRA-6		20.85 lbs
1	PP-109/GR, or	8" x 13" x 9"	33 lbs
1	PP-112/GR	8" x 13" x 9"	33 lbs
1	PP-281/GR, or	4 $\frac{1}{2}$ " x 6" x 3"	6 lbs
1	PP-282/GR	4 $\frac{1}{2}$ " x 6" x 3"	6 lbs
1	RT-67/GRC	9" x 13" x 11 $\frac{1}{2}$ "	35 lbs

TUBES, CRYSTALS, TRANSISTORS:**REFERENCE DATA AND LITERATURE:**

TM 11-291

RADIO SET
AN/VRC-15()

15 March 1962

Cog. Serv: USA FSN: 5820-192-7111

USA Line Item No.: 649500

	USA	USN	USAF	USMC
STATUS OR TYPE CLASS.:	Std-B			

Manufacturer:

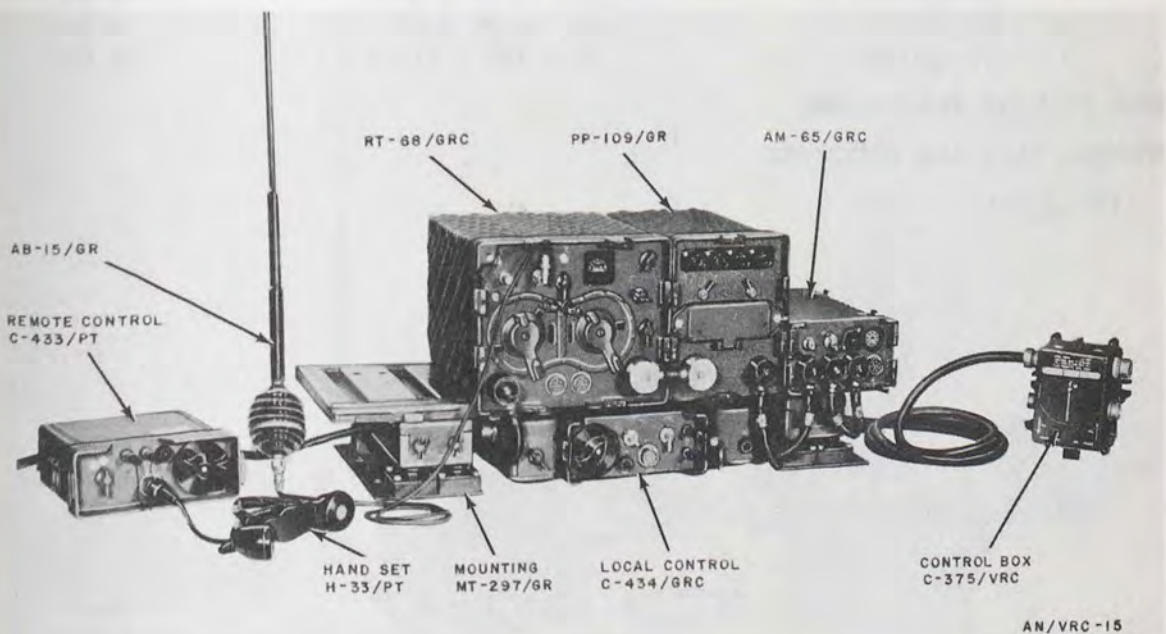
**FUNCTIONAL DESCRIPTION:**

Radio Set AN/VRC-15() is a short-range, vehicular, fm (voice) equipment for communication within and between infantry units.

This set consists of the receiver-transmitter component designated as Set 1 when used as part of the integrated series of radio sets, such as the AN/GRC-7 and AN/GRC-8. A vehicular installation unit, interphone amplifier, power supply equipment, plus control and accessory item are included.

This equipment can be operated by means of Control Group AN/GRA-6 from a remote point at a distance of about 2 miles over a telephone pair.

RELATIONSHIP TO SIMILAR EQUIPMENT:**TECHNICAL DESCRIPTION:**

Frequency Range in Mc: 38.0 to 54.9

Type Modulation: fm

RADIO SET

AN/VRC-15()

Type of Signal: voice

Power Output:

High Power: 9 to 16 w

Low Power: 2 w

Power Requirements: 12/24 v dc from vehicular storage battery.

Major Units:

1	AM-65/GRC	4 $\frac{1}{4}$ " x 13" x 7 $\frac{7}{8}$ "	15.5 lbs
1	AN/GRA-6		20.85 lbs
1	PP-109/GR, or	8" x 13" x 9"	33 lbs
1	PP-112/GR	8" x 13" x 9"	33 lbs
1	PP-281/GR, or	4 $\frac{1}{2}$ " x 6" x 3"	6 lbs
1	PP-282/GR	4 $\frac{1}{2}$ " x 6" x 3"	6 lbs
1	RT-68/GRC	9" x 13" x 11 $\frac{1}{4}$ "	35 lbs

TUBES, CRYSTALS, TRANSISTORS:

REFERENCE DATA AND LITERATURE:

TM 11-291

RADIO SET
AN/VRC-16()

15 March 1962

Cog. Serv: USA FSN: 5820-253-6131

USA Line Item No.: 649600

USA

USN

USAF

USMC

STATUS OR TYPE CLASS.:

Std-B

Manufacturer:

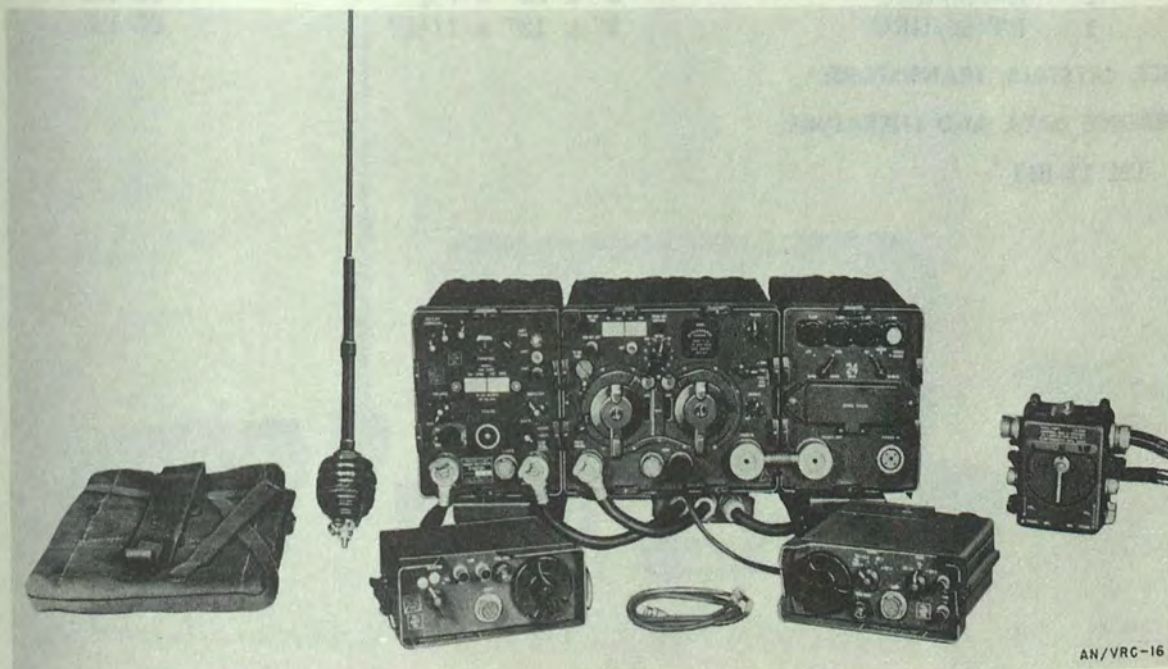
**FUNCTIONAL DESCRIPTION:**

Radio Set AN/VRC-16() is a short-range, vehicular, fm (voice) equipment for communication within and between armored units.

This set consists of the receiver-transmitter component designated as Set 1 when used as part of the integrated series of radio sets, such as the AN/GRC-3 and AN/GRC-4. The auxiliary receiver component of these sets is also provided with this equipment. A vehicular installation unit, power supply equipment, antenna, plus control components are included.

This equipment can be operated by means of Control Group AN/GRA-6 from a remote point up to a distance of about 2 miles over a telephone pair.

RELATIONSHIP TO SIMILAR EQUIPMENT:

Frequency Range in Mc: 20.0 to 27.9

Type Modulation: fm

Type of Signal: voice

RADIO SET

AN/VRC-16()*Power Output:*

High Power: 9 to 16 w

Low Power: 2 w

Power Requirements: 12/24 v dc from vehicular storage battery*Major Units:*

1	AN/GRA-6		20.85 lbs
1	PP-109/GR, or	8" x 13" x 9"	33 lbs
1	PP-112/GR	8" x 13" x 9"	33 lbs
1	PP-281/GR, or	4½" x 6" x 3"	6 lbs
1	PP-282/GR	4½" x 6" x 3"	6 lbs
1	R-108/GRC	9" x 13" x 7¼"	35 lbs
1	RT-66/GRC	9" x 13" x 11¼"	35 lbs

TUBES, CRYSTALS, TRANSISTORS:**REFERENCE DATA AND LITERATURE:**

TM 11-611

RADIO SET
AN/VRC-17

15 March 1962

Cog. Serv: USA FSN: 5820-351-3384

USA Line Item No.: 649700

	USA	USN	USAF	USMC
STATUS OR TYPE CLASS.:	Std-B			

Manufacturer:

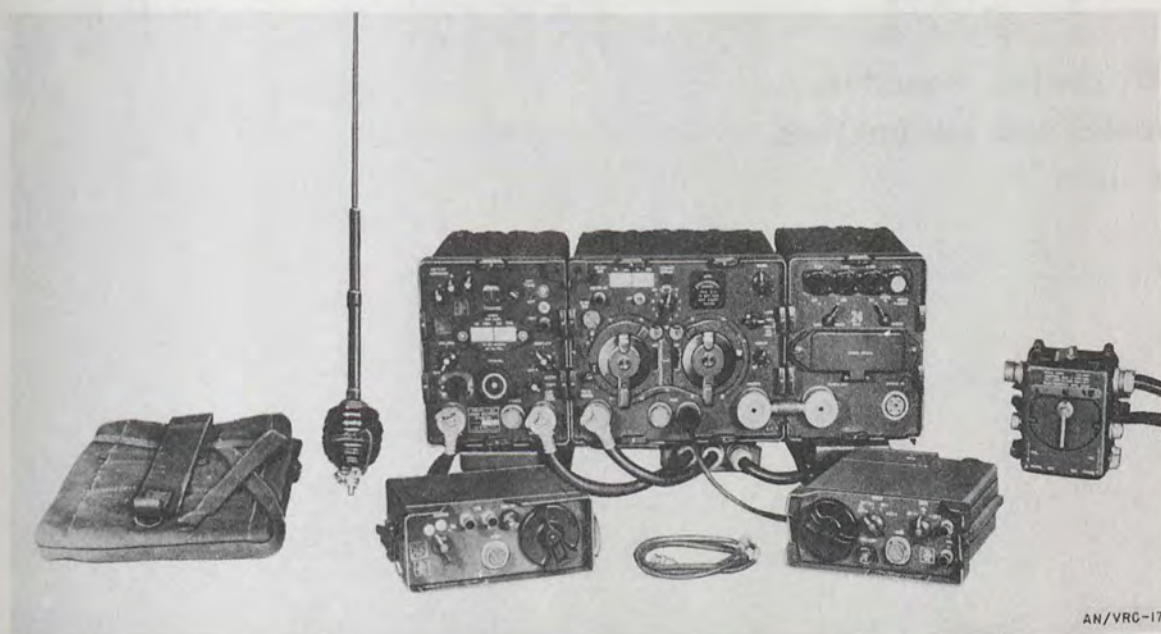

AN/VRC-17

FUNCTIONAL DESCRIPTION:

Radio Set AN/VRC-17 is a short-range, vehicular, fm (voice) equipment for communication within and between artillery units.

This set consists of the receiver-transmitter component, designated as Set 1 when used as part of the integrated series of radio sets, such as the AN/GRC-5 and AN/GRC-6. The auxiliary receiver component of these sets is also provided with the equipment. A vehicular installation unit, power supply equipment, antenna, plus control components are included.

This equipment can be operated by means of Control Group AN/GRA-6 from a remote point up to a distance of about 2 miles over a telephone pair.

RELATIONSHIP TO SIMILAR EQUIPMENT:**TECHNICAL DESCRIPTION:**

Frequency Range in Mc: 27.0 to 38.9

Type Modulation: fm

Type of Signal: voice

RADIO SET

AN/VRC-17

Power Output:

High Power: 9 to 16 w

Low Power: 2 w

Power Requirements: 12/24 v dc from vehicular storage battery

Major Units:

1	AN/GRA-6		20.85 lbs
1	PP-109/GR, or	8" x 13" x 9"	33 lbs
1	PP-112/GR	8" x 13" x 9"	33 lbs
1	PP-281/GR, or	4½" x 6" x 3"	6 lbs
1	PP-282/GR	4½" x 6" x 3"	6 lbs
1	R-109/GR	9" x 13" x 11½"	35 lbs
1	RT-67/GRC	9" x 13" x 11½"	35 lbs

TUBES, CRYSTALS, TRANSISTORS:

REFERENCE DATA AND LITERATURE:

TM 11-611

RADIO SET
AN/VRC-18()

15 March 1962

Cogn. Serv: USA FSN: 5820-234-6399

USA Line Item No.: 649800

	USA	USN	USAF	USMC
STATUS OR TYPE CLASS.:	Std-B			

Manufacturer:

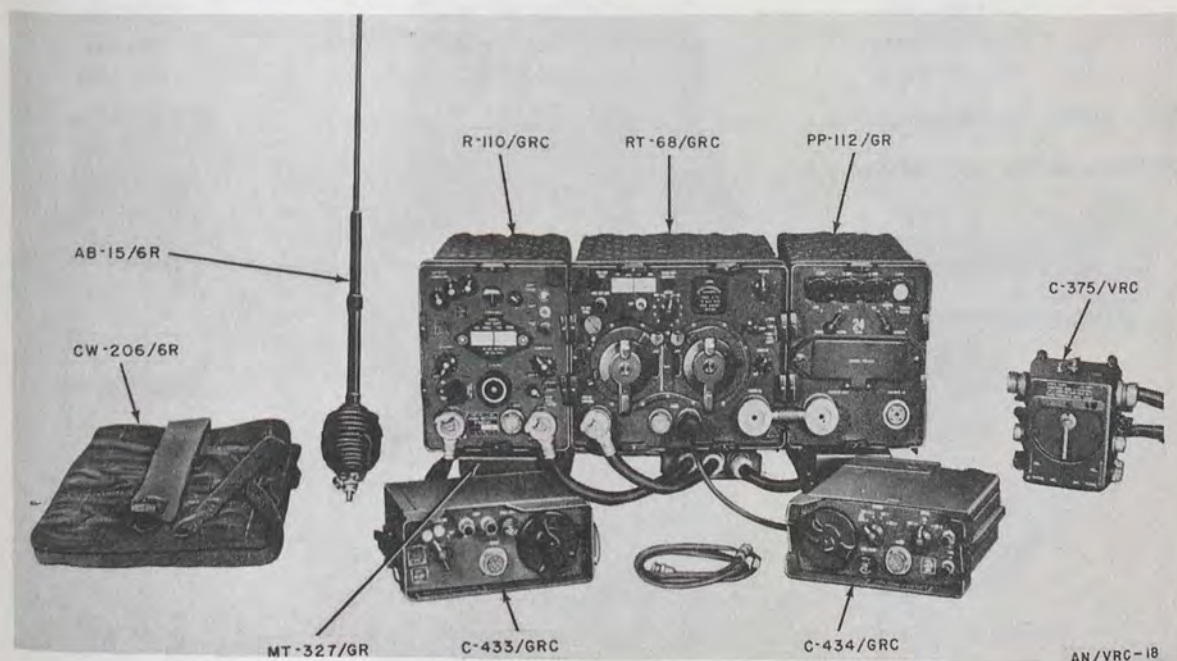
**FUNCTIONAL DESCRIPTION:**

Radio Set AN/VRC-18() is a short-range, vehicular fm (voice transmitting and receiving) equipment used for communication within and between infantry units.

This equipment consists of the receiver-transmitter component, designated as Set 1 when used as part of the integrated series of radio sets, such as the AN/GRC-7 and AN/GRC-8. The auxiliary receiver component of these sets is also provided with this equipment. A vehicular installation unit, power supply equipment, antenna, plus control components are included.

This equipment can be operated by means of Control Group AN/GRA-6 from a remote point up to a distance of about 2 miles over a telephone pair.

RELATIONSHIP TO SIMILAR EQUIPMENT:**TECHNICAL DESCRIPTION:**

Frequency Range in Mc: 38.0 to 54.9

Type Modulation: fm

RADIO SET

AN/VRC-18()

Type of Signal: voice

Power Output:

High Power: 9 to 16 w

Low Power: 2 w

Power Requirements: 12/24 v dc from vehicular storage battery

Major Units:

1	AN/GRA-6		20.85 lbs
1	PP-109/GR, or	8" x 13" x 9"	33 lbs
1	PP-112/GR	8" x 13" x 9"	33 lbs
1	PP-281/GR, or	4½" x 6" x 3"	6 lbs
1	PP-282/GR	4½" x 6" x 3"	6 lbs
1	R-110/GRC	9" x 13" x 7¼"	35 lbs
1	RT-68/GRC	9" x 13" x 11¼"	35 lbs

TUBES, CRYSTALS, TRANSISTORS:

REFERENCE DATA AND LITERATURE:

TM 11-611

RADIO SET
AN/VRC-19()

15 March 1962

Cog. Serv: USA FSN: 5820-503-1124

USA Line Item No.: 650300

USA

USN

USAF

USMC

STATUS OR TYPE CLASS.:

Std-A

Manufacturer: Motorola, Inc

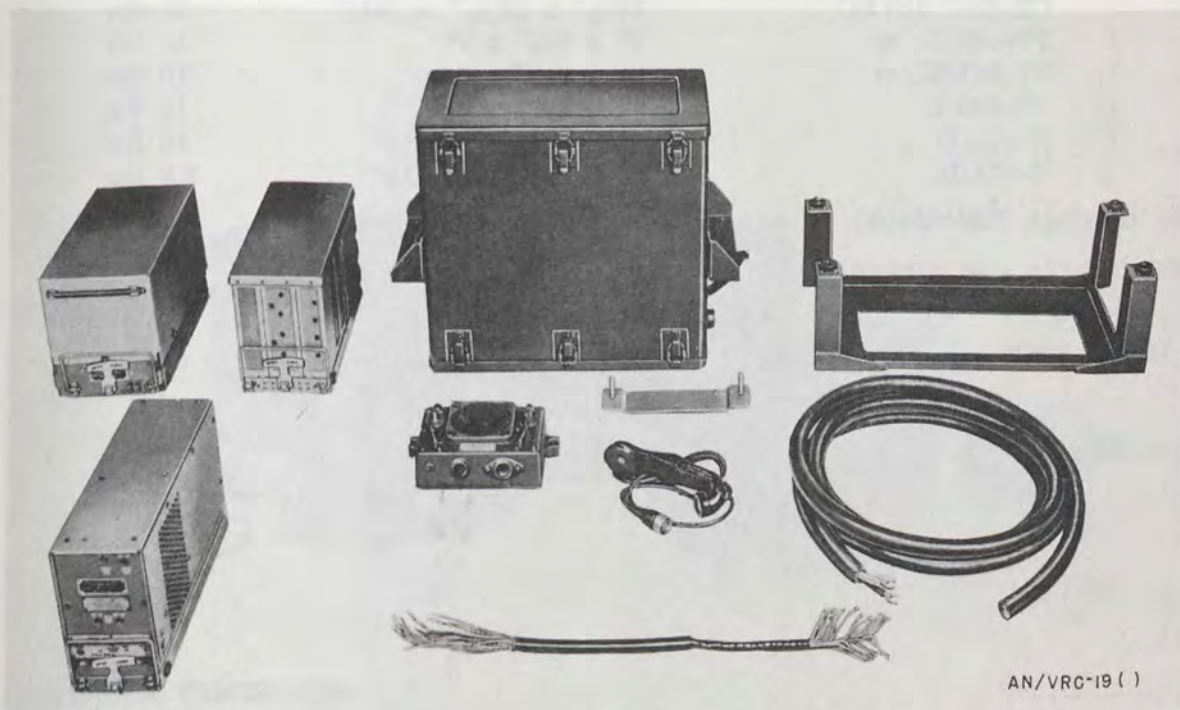
**FUNCTIONAL DESCRIPTION:**

Radio Set AN/VRC-19() is a small, battery-powered, vehicular, low-powered, fm radio communication equipment used by military police, guard, and security troops. It can be installed in railroad trains and motor vehicles.

This equipment consists essentially of a radio receiver and power supply, a transmitter and power supply, a control unit, and an electrical cabinet.

The AN/VRC-19 and AN/VRC-19X operate on a 24-volt and 12-volt, vehicular battery, respectively.

RELATIONSHIP TO SIMILAR EQUIPMENT:**TECHNICAL DESCRIPTION:**

Frequency Range in Mc: 152 to 174

Type Modulation: fm

RADIO SET

AN/VRC-19()

Type of Signal: voice

Power Output: 20 to 25 w

Power Requirements:

AN/VRC-19: 26.4 w (rcvr), 240 w (xmtr); 24-v dc

AN/VRC-19X: 24 w (rcvr), 240 w (xmtr); 12-v dc

Major Units:

1	DY-93/G, or	8 $\frac{5}{8}$ " x 6 $\frac{7}{8}$ " x 14 $\frac{1}{2}$ "	24 lbs
1	DY-98/G, or	8 $\frac{5}{8}$ " x 6 $\frac{7}{8}$ " x 14 $\frac{1}{2}$ "	24 lbs
1	DY-100/U	8 $\frac{5}{8}$ " x 6 $\frac{7}{8}$ " x 14 $\frac{1}{2}$ "	24 lbs
1	CY-938()/VRC	10 $\frac{1}{2}$ " x 19 $\frac{5}{16}$ " x 16 $\frac{1}{2}$ "	33 lbs
1	PP-867/U, or	5" x 6 $\frac{1}{4}$ " x 7"	10 lbs
1	PP-868/U, or	5" x 6 $\frac{1}{4}$ " x 7"	10 lbs
1	PP-869/U	5" x 6 $\frac{1}{4}$ " x 7"	10 lbs
1	R-394/U	8 $\frac{1}{2}$ " x 5 $\frac{3}{4}$ " x 14 $\frac{1}{2}$ "	16 lbs
1	T-278/U	8 $\frac{1}{2}$ " x 4 $\frac{1}{2}$ " x 14 $\frac{1}{2}$ "	8.5 lbs

TUBES, CRYSTALS, TRANSISTORS:

REFERENCE DATA AND LITERATURE:

TM 11-297

MIL-N-11539

RADIO SET
AN/VRC-20

15 March 1962

Cog. Serv: USA FSN: 5820-519-4104

USA Line Item No.: 650400

USA

USN

USAF

USMC

STATUS OR TYPE CLASS.:

Std-B

Manufacturer:

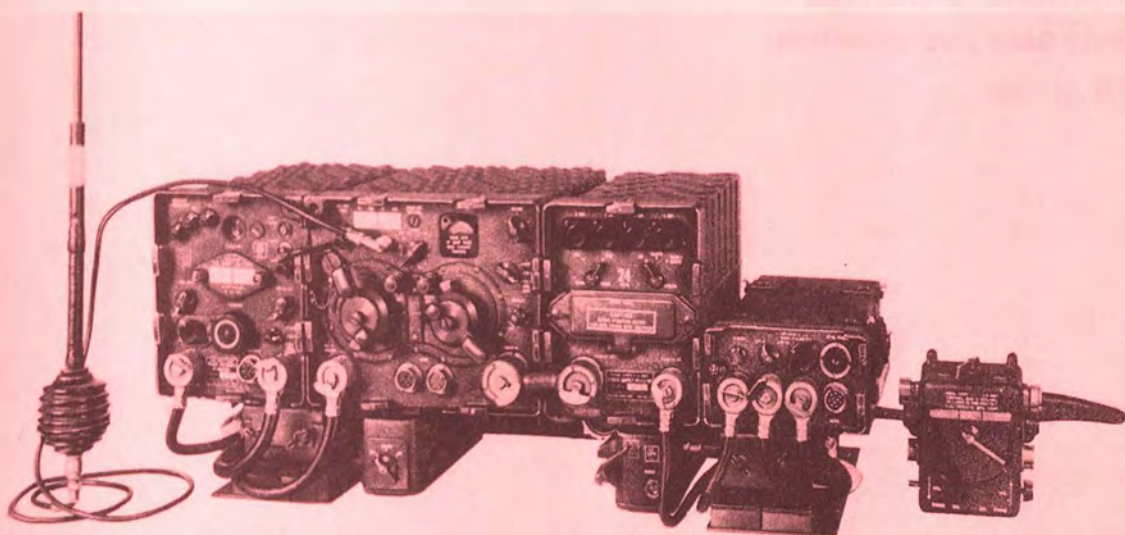

AN/VRC-20

FUNCTIONAL DESCRIPTION:

Radio Set AN/VRC-20 is a vehicular, short-range, fm (voice), radiotelephone equipment for communication within and between armored units.

This equipment consists of the receiver-transmitter component designated as Set 1 when used as part of the integrated series of radio sets, such as the AN/GRC-3 and AN/GRC-4. The auxiliary receiver component of these sets is also provided with this equipment. A vehicular installation unit, power supply equipment, antenna, plus control components are included.

RELATIONSHIP TO SIMILAR EQUIPMENT:**TECHNICAL DESCRIPTION:**

Frequency Range in Mc: 20.0 to 27.9

Type Modulation: fm

Type of Signal: voice

Power Output:

High Power: 9 to 16 w

Low Power: 2 w

RADIO SET

AN/VRC-20

Power Requirements: 12/24-volts dc from vehicular storage battery

Major Units:

1	AM-65/GRC	4 $\frac{1}{4}$ " x 13" x 7 $\frac{7}{8}$ "	15.5 lbs
1	C-375/VRC	7" x 4" x 7"	3.5 lbs
1	PP-109/GR, or	8" x 13" x 9"	33 lbs
1	PP-112/GR	8" x 13" x 9"	33 lbs
1	PP-281/GR, or	4 $\frac{1}{2}$ " x 6" x 3"	6 lbs
1	PP-282/GR	4 $\frac{1}{2}$ " x 6" x 3"	6 lbs
1	R-108/GRC	9" x 13" x 7 $\frac{1}{4}$ "	35 lbs
1	RT-66/GRC	9" x 13" x 11 $\frac{1}{4}$ "	35 lbs

TUBES, CRYSTALS, TRANSISTORS:**REFERENCE DATA AND LITERATURE:**

TM 11-642

RADIO SET
AN/VRC-21

15 March 1962

Cog. Serv: USA FSN: 5820-519-4102

USA Line Item No.: 650700

USA

USN

USAF

USMC

STATUS OR TYPE CLASS.:

Std-B

Manufacturer:

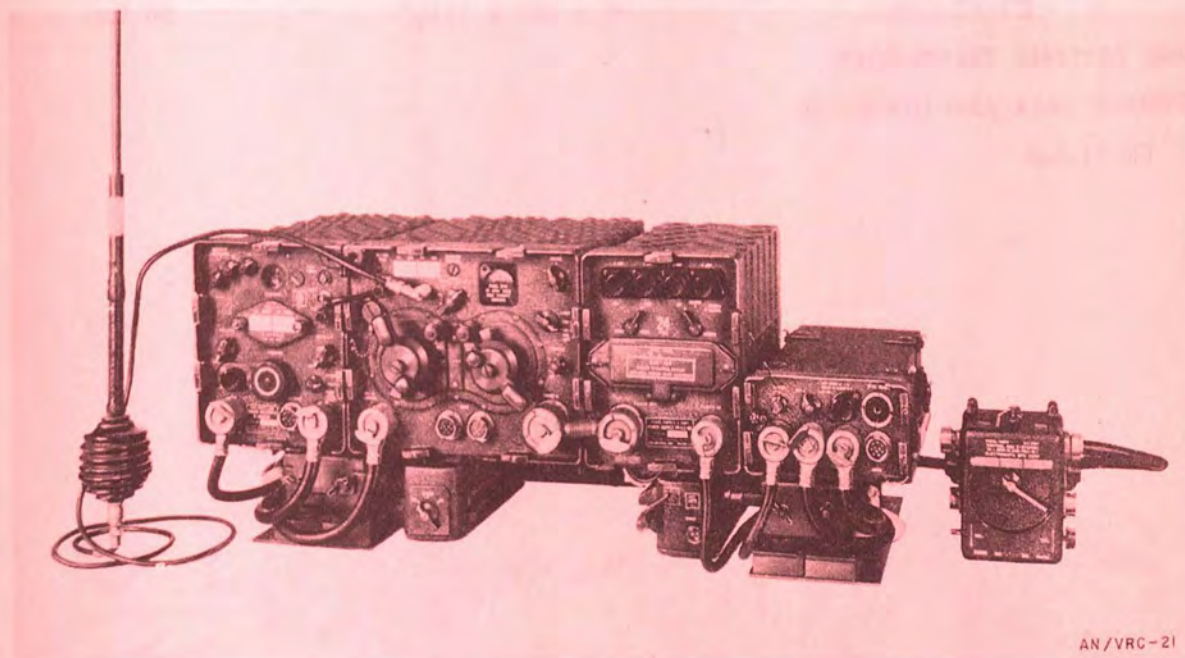

AN/VRC-21

FUNCTIONAL DESCRIPTION:

Radio Set AN/VRC-21 is a vehicular, short-range, fm (voice), radiotelephone equipment for communication within and between artillery units.

This equipment consists of the receiver-transmitter component designated as Set 1 when used as part of the integrated series of radio sets, such as the AN/GRC-5 and AN/GRC-6. The auxiliary receiver component of these sets is also provided with this equipment. A vehicular installation unit, power supply equipment, antenna, plus control components are included.

RELATIONSHIP TO SIMILAR EQUIPMENT:**TECHNICAL DESCRIPTION:**

Frequency Range in Mc: 27.0 to 38.9

Type Modulation: fm

Type of Signal: voice

Power Output:

High Power: 9 to 16 w

Low Power: 2 w



RADIO SET

AN/VRC-22*Type of Signal:* voice*Power Output:*

High Power: 9 to 16 w

Low Power: 2 w

Power Requirements: 12/24-v dc from vehicular storage battery*Major Units:*

1	AM-65/GRC	4 $\frac{1}{4}$ " x 13" x 7 $\frac{7}{8}$ "	15.5 lbs
1	C-375/VRC	7" x 4" x 7"	3.5 lbs
1	PP-109/GR, or	8" x 13" x 9"	33 lbs
1	PP-112/GR	8" x 13" x 9"	33 lbs
2	PP-281/GR, or	4 $\frac{1}{2}$ " x 6" x 3"	6 lbs
2	PP-282/GR	4 $\frac{1}{2}$ " x 6" x 3"	6 lbs
1	R-110/GRC	9" x 13" x 7 $\frac{1}{4}$ "	35 lbs
1	RT-68/GRC	9" x 13" x 11 $\frac{1}{4}$ "	35 lbs

TUBES, CRYSTALS, TRANSISTORS:**REFERENCE DATA AND LITERATURE:**

TM 11-642

RADIO SET
AN/VRC-27

15 March 1962

Cog. Serv: USN FSN: 5840-695-4447

USA Line Item No.:

USA

USN

USAF

USMC

STATUS OR TYPE CLASS.:

Manufacturer: CGG (80211)

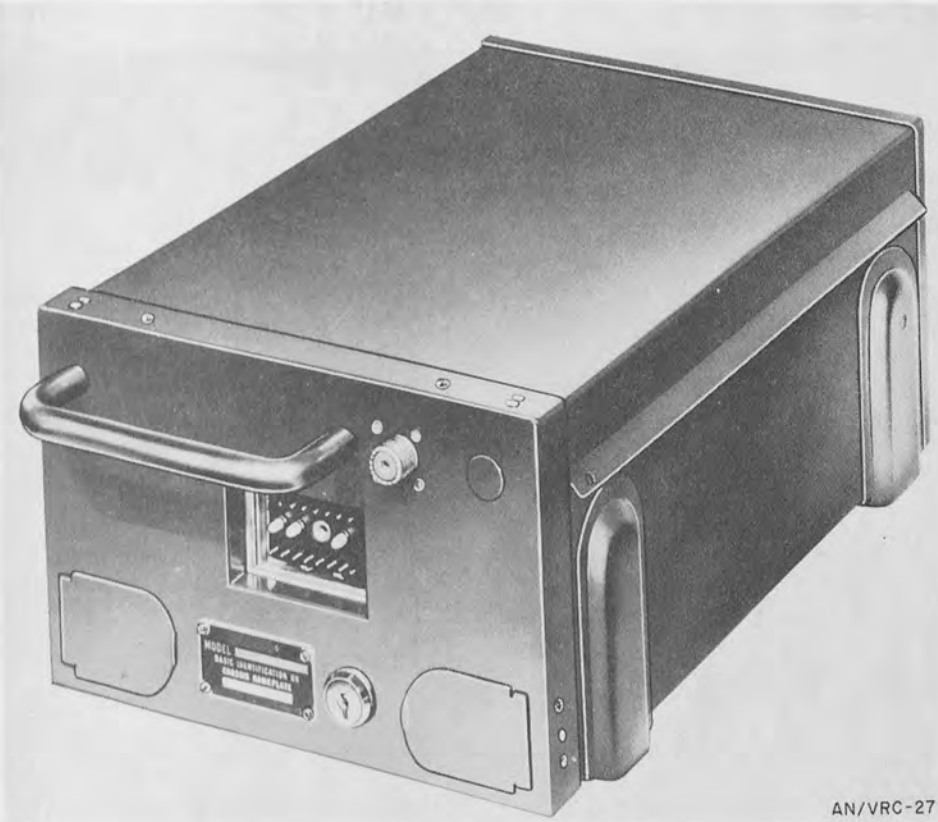
**FUNCTIONAL DESCRIPTION:**

Radio Set AN/VRC-27 is an fm, two-way radio equipment, consisting essentially of a transmitter, a receiver, and a power supply assembled in a drawer-type mobile housing. The transmitter and receiver operate in fixed, crystal controlled frequencies. The power supply furnishes all the voltages required for operation of both the transmitter and receiver. When installed with the appropriate cable kit, the radio set will operate from either 6 or 12 v dc. The set is for installation in the trunk of a passenger vehicle.

RELATIONSHIP TO SIMILAR EQUIPMENT:**TECHNICAL DESCRIPTION:**

Frequency Range: 30-42 mc

Transmitter Output: 25-30 w

RADIO SET

AN/VRC-27

Transmitter Modulation: ± 15 kc for 100 percent at 1000 cps

Receiver Sensitivity: Less than $0.35 \mu\text{v}$ for 30 db quieting

Receiver Selectivity: -100 db at ± 30 kc

Receiver Modulation Acceptance: ± 15 kc or more at -6 db

Power Input:

Standby: 10 amp at 6.3 v dc

Transmit: 25 amp at 6.3 v dc

Major Units:

1 TA-179

$2\frac{3}{8}'' \times 5\frac{1}{4}'' \times 15''$

3.75 lbs

1 TA-180

$3\frac{1}{4}'' \times 5\frac{1}{4}'' \times 15''$

5.4 lbs

1 TV-117

$3'' \times 5\frac{1}{4}'' \times 15''$

9.5 lbs

REFERENCE DATA AND LITERATURE:**TUBES, CRYSTALS, TRANSISTORS:**

NAVSHIPS 92757

RADIO SET
AN/VRC-30

15 March 1962

Cog. Serv: USA FSN: 5895-578-5453

USA Line Item No.: 652900

USA

USN

USAF

USMC

STATUS OR TYPE CLASS.:

Std-B

Manufacturer:

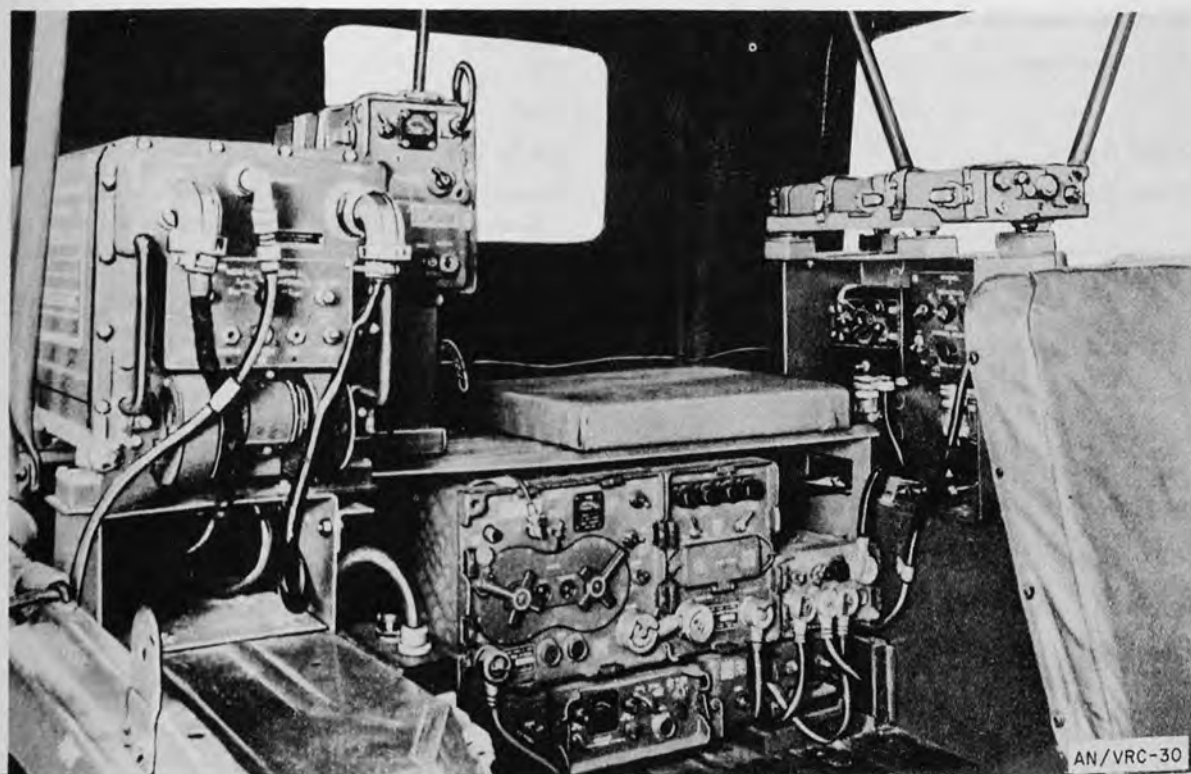
**FUNCTIONAL DESCRIPTION:**

Radio Set AN/VRC-30 is an assemblage of transmitting and receiving equipment arranged for vehicular installation and operation. Its components operate in different rf ranges, separately or simultaneously, to increase flexibility of ground and ground-to-air communication.

This equipment consists of the following radio sets: AN/ARC-27, AN/PRC-9, AN/TRC-7 (optional), and AN/VRC-14. The AN/TRC-7 is supplied only when a frequency range of 100 to 156 mc is required.

This equipment provides ground-to-air communication between forward observation posts on the ground and aircraft assigned to close support missions, as well as communication between the forward observation post and a similar radio set at a higher tactical ground-force headquarters.

RADIO SET

AN/VRC-30

It is usually installed in a 1/4-ton, 4 x 4 truck (M38 or M38A1) but may be mounted in a 3/4-ton truck, an armored personnel carrier, or a tank.

For installation in the 1/4-ton truck, 3/4-ton truck, or other vehicle, a heavy-duty generator must be installed to provide the necessary power to operate all equipment.

RELATIONSHIP TO SIMILAR EQUIPMENT:**TECHNICAL DESCRIPTION:**

SET	AN/ARC-27	AN/PRC-9	AN/TRC-7	AN/VRC-14
Frequency Range in mc	225.0 to 399.9	27.0 to 38.9	100 to 156	27 to 38.9
Type Modulation	am voice	fm voice	am voice	fm voice
Power Output	10 w	1 w	0.5 to 1.5w	2 or 20
Power Requirements	24- to 28-v dc	Battery BA-279/U	Battery BA-70 or Hand Generator G-3/TRC-7	12- or 24-v vehicular storage battery

Major Units:

1	AN/ARC-27	19 ³ / ₄ " x 12 ³ / ₈ " x 27 ⁵ / ₈ "	81.8 lbs
1	AN/TRC-9		26 lbs
1	AN/TRC-7		143 lbs
1	AN/VRC-14		185 lbs

TUBES, CRYSTALS, TRANSISTORS:**REFERENCE DATA AND LITERATURE:**

TB SIG 283

RADIO SET
AN/VRC-32

15 March 1962

Cog. Serv: USN FSN: 5820-665-1709

USA Line Item No.:

USA

USN

USAF

USMC

STATUS OR TYPE CLASS.:

Manufacturer: CG (24446)

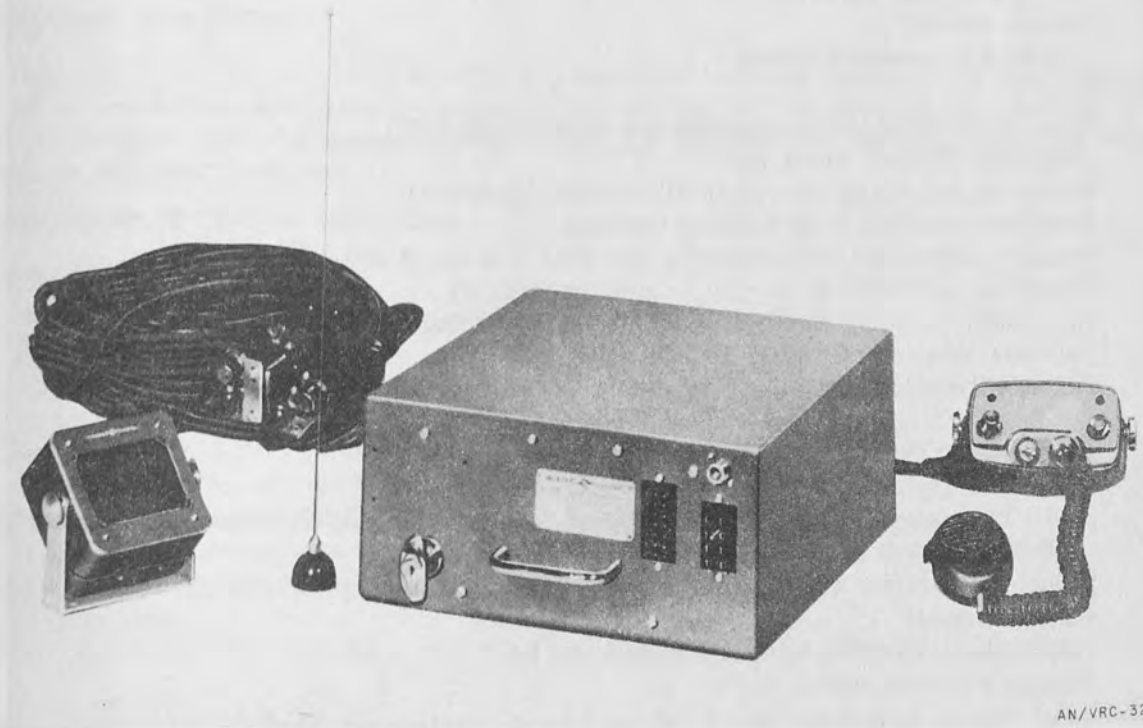

AN/VRC-32

FUNCTIONAL DESCRIPTION:

Radio Set AN/VRC-32 is a compact, ruggedly constructed equipment that provides two-way communication with land-mobile equipments.

RELATIONSHIP TO SIMILAR EQUIPMENT:**TECHNICAL DESCRIPTION:***Transmitter*

Frequency Range: 30-42 mc

Power Output: 30 w (nominal)

Modulation: ± 5 kc (narrow band) or ± 15 kc (wide band) swing with instantaneous modulation limiting

RADIO SET

AN/VRC-32

Crystal Multiplication: 12 times

Ambient Temperature Range: -30°C to $+60^{\circ}\text{C}$

Frequency Stability:

Unheated Crystal: ± 0.002 percent

Heated Crystal: ± 0.0005 percent

Audio Frequency: between ± 1 to -3 db of a 6 db/octave pre-emphasis from 300-3000 cps (1000 cps reference)

Spurious and Harmonic Radiation: at least 80 db below rated power output at any frequency

Hum and Noise Level: -40 db (below ± 10 kc swing)

Channel Separation (max): 0.4 percent of operating frequency (160 kc approx) for 2, 3, or 4 channel operation

Control: crystal

Output: F3 phase modulation

Receiver:

Type: wide band, double conversion superheterodyne

Frequency Range: 30-54 mc

Audio Output: 1.5 w (less than 10 percent distortion)

Sensitivity: 0.4 uv (20 db quieting method)

Squelch: adjustable, will open at less than 0.15 uv at critical setting

Selectivity: 100 db ± 30 kc (20 db quieting method)

Bandwidth: ± 15 kc at the 6 db points (swing method of measurement)

Spurious Response: at least 100 db down

Ambient Temperature: -30°C to $+60^{\circ}\text{C}$ (outside of cabinet that houses chassis)

Frequency Stability:

Unheated Crystal: ± 0.002 percent

Heated Crystal: ± 0.0005 percent

Audio Frequency: within $+2$ to -8 db of a 6 db/octave de-emphasis curve from 300-3000 cps (1000 cps reference)

Channel Separation (max): 0.4 percent operating frequency (160 kc approx)

Control: crystal

Intermediate Frequencies: 3.2 mc and 290 kc

Output: F3 phase modulation

Operating Power Requirements: 6, 12, or 24 v dc; battery operated

Antenna Type: vertical whip

Major Units:

1 CY-1908/VRC-32

1 RT-367/VRC-32

1 C-184/VRC-32

1 LS-255/U

TUBES, CRYSTALS, TRANSISTORS:

REFERENCE DATA AND LITERATURE:

NAVSHIPS 92652

RADIO SET

AN/VRC-33, -33A

15 March 1962

Cog. Serv: USN FSN: (AN/VRC-33) 5820-565-0963
 (AN/VRC-33A) 5820-542-7035

USA Line Item No.:

USA

USN

USAF

USMC

STATUS OR TYPE CLASS.:

Manufacturer: CCI

(13848)

No Illustration Available

FUNCTIONAL DESCRIPTION:

The AN/VRC-33 and AN/VRC-33A are universal vehicular radios. They are designed for use by police, maintenance crews, transportation vehicles, and fire department operations to provide dependable two-way communication. The AN/VRC-33 and AN/VRC-33A are identical except in equipment supplied.

RELATIONSHIP TO SIMILAR EQUIPMENT:

TECHNICAL DESCRIPTION:

Frequency Range: 30 to 42 mc, 1 channel, crystal controlled.

Emission: F3

Frequency Stability: 0.002%

Ambient Temperature Range: -30°C to +60°C

Sensitivity: 0.4 uv for 20 db noise quieting

Spurious Response: -100 db

Antenna Input Impedance: 52 ohms

Audio Output Impedance: 4 and 500 ohms

Operating Power Requirements: 6, 12 or 24 v dc, 25 to 35 w

Major Units:

1	RT-408/VRC-33	5½" x 11" x 13"	38 lbs
1	CY-2108/VRC-33	5½" x 11" x 13"	
1	C-2110/VRC-33	2½" x 3¾" x 4½"	
1	LS-425/U	3¼" x 6" x 6"	
1	RT-408/VRC-33A	5½" x 11" x 13"	38 lbs
1	CV-2018A/VRC-33A	5½" x 11" x 13"	
1	C-2110/VRC-33	2½" x 3¾" x 4½"	
1	LS-425/U	3¼" x 6" x 6"	

TUBES, CRYSTALS, TRANSISTORS:

REFERENCE DATA AND LITERATURE:

NAVSHIPS 92922(A)

Page 12

ANNEXURE-2

1. The following are the details of the assets and liabilities of the company as at the end of the financial year 1963-64.

Particulars	Rs.	Paise.
Fixed Assets	1,00,00,000	00
Current Assets	50,00,000	00
Liabilities	1,50,00,000	00

2. The following are the details of the assets and liabilities of the company as at the end of the financial year 1964-65.

Particulars	Rs.	Paise.
Fixed Assets	1,20,00,000	00
Current Assets	60,00,000	00
Liabilities	1,80,00,000	00

3. The following are the details of the assets and liabilities of the company as at the end of the financial year 1965-66.

Particulars	Rs.	Paise.
Fixed Assets	1,50,00,000	00
Current Assets	80,00,000	00
Liabilities	2,30,00,000	00

4. The following are the details of the assets and liabilities of the company as at the end of the financial year 1966-67.

Particulars	Rs.	Paise.
Fixed Assets	1,80,00,000	00
Current Assets	1,00,00,000	00
Liabilities	2,80,00,000	00

RADIO SET

AN/VRC-51

15 March 1962

Cog. Serv: USN FSN: 5820-893-0050

USA Line Item No.:

USA

USN

USAF

USMC

STATUS OR TYPE CLASS.:

Manufacturer: CCI (13848)

**FUNCTIONAL DESCRIPTION:**

The AN/VRC-51 is a fixed tuned, crystal controlled unit of the single channel type, designed for fm emission. It is designed for vehicular operation. Power output of the set is variable, depending on the frequency and input voltage.

RELATIONSHIP TO SIMILAR EQUIPMENT:

This equipment is functionally similar to the AN/VRC-42, except for frequency range.

TECHNICAL DESCRIPTION:

Frequency Range: 132 to 152 mc

Control: crystal controlled

Power Output: 25 w min; 30 to 32 w normal

Modulation: -fm, Type F3 emission

RADIO SET

AN/VRC-51*Operating Power Requirements:* 12 or 24 v dc*Major Units:*

1	RT-616/VRC-51	12 $\frac{1}{2}$ " x 9 $\frac{1}{4}$ " x 5 $\frac{1}{2}$ "	14 $\frac{3}{4}$ lbs
1	C-3691/VRC-51	3" x 6" x 5"	9 $\frac{1}{2}$ lbs
1	Antenna	22 $\frac{1}{2}$ " x 1 $\frac{1}{2}$ " x 1"	$\frac{1}{2}$ lb
1	Microphone	10 $\frac{1}{4}$ " x 4 $\frac{7}{8}$ " x 2 $\frac{3}{8}$ "	1 $\frac{1}{4}$ lbs

TUBES, CRYSTALS, TRANSISTORS:**REFERENCE DATA AND LITERATURE:**

NAVSHIPS 94121

AN/VRC-type
RADIO SET

SCR-506-()

15 March 1962

Cog. Serv: USN FSN: 5820-196-1743

USA Line Item No.: 653000

USA

USN

USAF

USMC

STATUS OR TYPE CLASS.:

L/Std

Manufacturer:

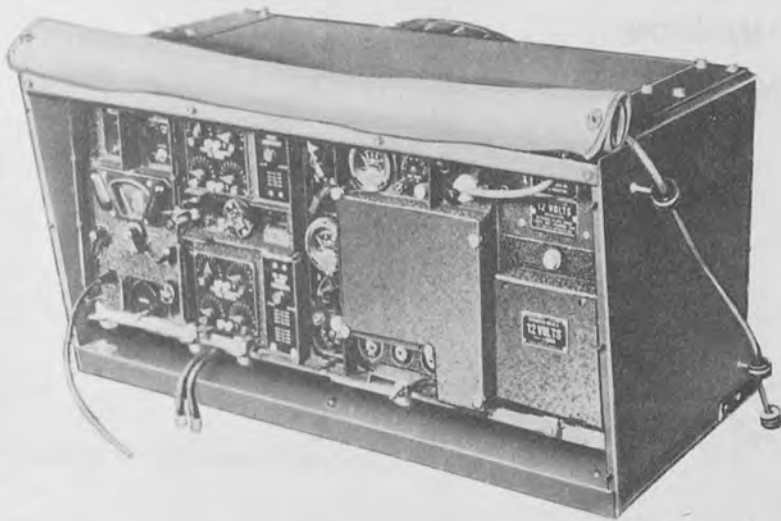

SCR-506

FUNCTIONAL DESCRIPTION:

Radio Set SCR-506-() is a medium power, am (voice) and cw, vehicular radio transmitting and receiving equipment used by motorized tactical units for ground-to-ground and ground-to-air communication in the medium-frequency range.

This equipment consists of a radio transmitter and a radio receiver mounted on a vehicular shock mounting common to both, and includes antenna, cording, and accessory items. It is usually installed in tanks, armored and amphibious vehicles, personnel carriers and similar vehicles. The set has provision for rapidly adjusting, and operating over any of five preselected channels.

It operates from the storage battery of the vehicle in which it is installed.

This equipment has been replaced by Radio Set AN/GRC-19

RELATIONSHIP TO SIMILAR EQUIPMENT:**TECHNICAL DESCRIPTION:**

Frequency Range in Mc:

Transmitter: 2.0 to 4.5 (126 channels)

Receiver: 2.0 to 6.0 (210 channels, 2 bands)

**AN/VRC-type
RADIO SET**

SCR-506-()

Type Modulation: am

Type of Signal: voice and cw

Power Output:

Voice: 10 to 25 w

Cw: 50 to 90 w

Power Requirements: 12/24-v dc from vehicular storage battery

Major Units:

1	DM-42	7" x 4" (dia)	
1	BC-652	12 $\frac{1}{2}$ " x 14 $\frac{5}{8}$ " x 7 $\frac{5}{8}$ "	46.5 lbs
1	BC-653	12 $\frac{1}{2}$ " x 14 $\frac{5}{8}$ " x 25 $\frac{3}{32}$ "	143.0 lbs

TUBES, CRYSTALS, TRANSISTORS:

REFERENCE DATA AND LITERATURE:

TM 11-630

AN/VRC-type
RADIO SET

SCR-508-()

15 March 1962

Cog. Serv: USA FSN: 5820-192-7137 (12 v)

5820-192-7138 (24 v)

USA Line Item No.: 653100

USA

USN

USAF

USMC

STATUS OR TYPE CLASS.:

L/Std

Manufacturer:

**FUNCTIONAL DESCRIPTION:**

Radio Set SCR-508-() is a vehicular, medium-range, crystal-controlled, fm (voice) radio-telephone equipment used by armored units.

This equipment consists of two receivers and one transmitter mounted on a common shock mount and provides a total of 20 receiving and 10 transmitting channels. It also provides for operation of the vehicular interphone system. Each receiver and the transmitter provide 80 frequency channels, 10 of which are preset, and are selected by means of a pushbutton mounted on the front panel, of each. A whip-type vehicular antenna, a set of crystals, and related accessories are included.

RELATIONSHIP TO SIMILAR EQUIPMENT:**TECHNICAL DESCRIPTION:**

Frequency Range in Mc: 20.0 to 27.9

Type of Modulation: fm

Type of Signal: voice

Power Output: 25 w

AN/VRC-type
RADIO SET

SCR-508-()

Power Requirements:

Transmitter: 20 amp at 12-v dc from vehicular storage battery, through Dynamotor DM-35; 12 amp at 24-v dc from vehicular storage battery, through Dynamotor DM-37

Receiver: 4 amp at 12-v dc from vehicular storage battery, through Dynamotor DM-34; 2 amp at 24-v dc from vehicular storage battery, through Dynamotor DM-36

Major Units:

1	BC-606-H	1/2" x 2 1/4" x 4 1/4"	1.8 lbs
1	FT-237	5 1/2" x 13" x 3 3/8"	26 lbs
2	BC-603	11 1/2" x 10 1/4" x 18"	35 lbs
1	BC-604	11 1/2" x 10 1/4" x 18"	67 lbs

TUBES, CRYSTALS, TRANSISTORS:**REFERENCE DATA AND LITERATURE:**

TM 11-600

RADIO SET
AN/VRQ-1

15 March 1962

Cog. Serv: USA FSN: 5820-222-6404

USA Line Item No.: 649900

	USA	USN	USAF	USMC
STATUS OR TYPE CLASS.:	Std-B			
Manufacturer:				

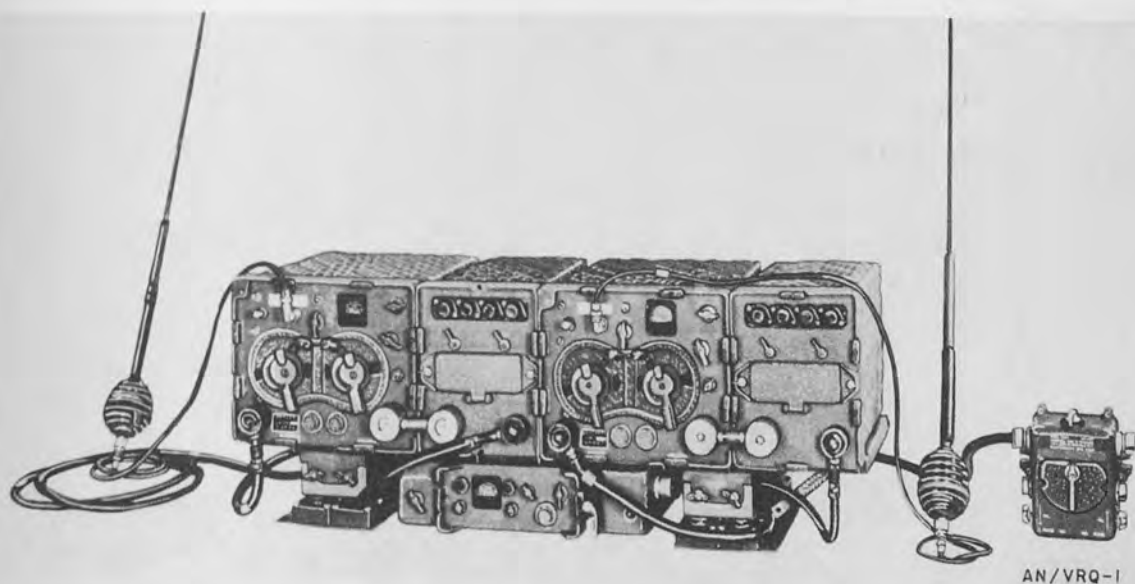

AN/VRQ-1

FUNCTIONAL DESCRIPTION:

Radio Set AN/VRQ-1 is a short-range, vehicular, fm (voice) equipment for point-to-point, retransmission, or radio-relay communication within and between armored units.

This set consists of two receiver-transmitters, designated as Set 1 when used as part of the integrated series of radio sets, such as the AN/GRC-3 and AN/GRC-4. A vehicular installation unit, power-supply equipment, and control and accessory units are included.

This equipment can be operated by means of Control Group AN/GRA-6 from a remote point up to a distance of about 2 miles over a telephone pair.

RELATIONSHIP TO SIMILAR EQUIPMENT:**TECHNICAL DESCRIPTION:**

Frequency Range in Mc: 20.0 to 27.9

Type Modulation: fm

Type of Signal: voice

Power Output (Each Transmitter):

High Power: 9 to 16 w

Low Power: 2 w

RADIO SET

AN/VRQ-1

Power Requirements: 12/24-v dc from vehicular storage battery

Major Units:

1	AN/GRA-6		20.85 lbs
2	PP-109/GR, or	9" x 13" x 8"	33 lbs
2	PP-112/GR	9" x 13" x 8"	33 lbs
2	RT-66/GRC	9" x 13" x 11 $\frac{1}{4}$ "	35 lbs

TUBES, CRYSTALS, TRANSISTORS:

REFERENCE DATA AND LITERATURE:

TM 11-287

RADIO SET
AN/VRQ-2()

15 March 1962

Cog. Serv: USA FSN: 5820-193-8838

USA Line Item No.: 650000

USA

USN

USAF

USMC

STATUS OR TYPE CLASS.: Std-B

Manufacturer:

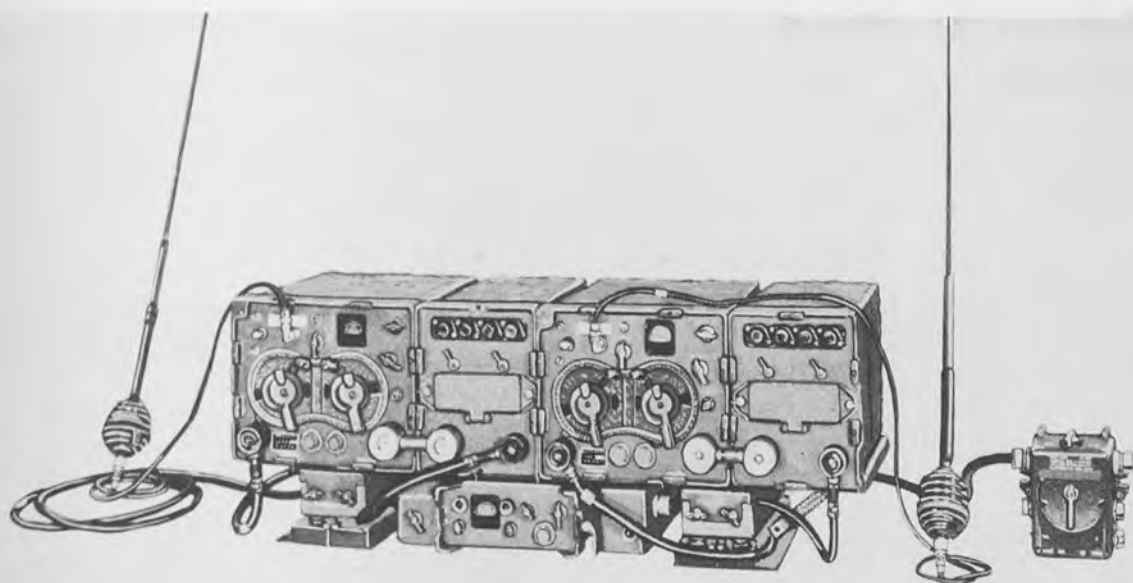

AN/VRQ-2

FUNCTIONAL DESCRIPTION:

Radio Set AN/VRQ-2() is a short-range, vehicular, fm (voice) equipment for point-to-point, retransmission, or radio-relay communication within and between artillery units.

This set consists of two receiver-transmitters, designated as Set 1 when used as part of the integrated series of radio sets, such as the AN/GRC-5 and AN/GRC-6. A vehicular installation unit, power-supply equipment, and control and accessory units are included.

This equipment can be operated by means of Control Group AN/GRA-6 from a remote point up to a distance of about 2 miles over a telephone pair.

RELATIONSHIP TO SIMILAR EQUIPMENT:**TECHNICAL DESCRIPTION:**

Frequency Range in Mc: 27.0 to 38.9

Type Modulation: fm

Type of Signal: voice

RADIO SET

AN/VRQ-2()

Power Output (Each Transmitter):

High Power: 9 to 16 w

Low Power: 2 w

Power Requirements: 12/24-v dc from vehicular storage battery

Major Units:

1	AN/GRA-6		20.85 lbs
2	PP-109/GR, or	9" x 13" x 8"	33 lbs
2	PP-112/GR	9" x 13" x 8"	33 lbs
2	RT-67/GRC	9" x 13" x 11 $\frac{1}{4}$ "	35 lbs

TUBES, CRYSTALS, TRANSISTORS:

REFERENCE DATA AND LITERATURE:

TM 11-287

RADIO SET
AN/VRQ-3()

15 March 1962

Cog. Serv: USA FSN: 5820-193-8811

USA Line Item No.: 650100

	USA	USN	USAF	USMC
STATUS OR TYPE CLASS.:	Std-B			

Manufacturers:

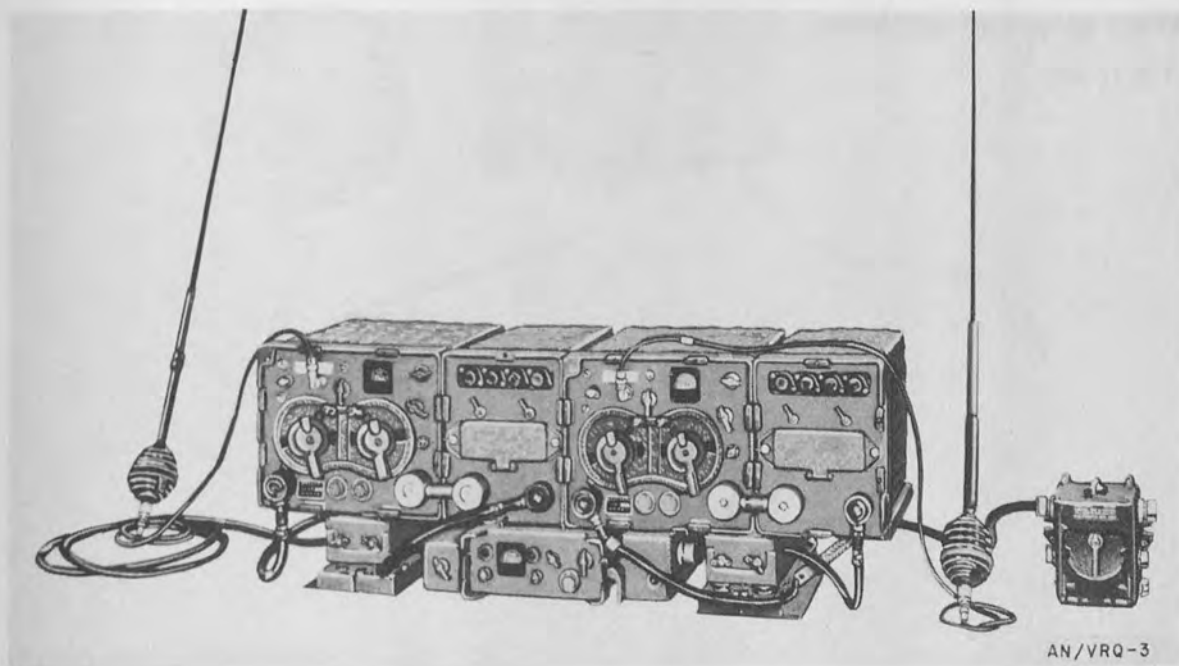
**FUNCTIONAL DESCRIPTION:**

Radio Set AN/VRQ-3() is a short range, vehicular, fm (voice) equipment for point-to-point, retransmission, or radio-relay communication within and between infantry units.

This set consists of two receiver-transmitters designated as Set 1 when used as part of the integrated series of radio sets such as the AN/GRC-7 and AN/GRC-8. A vehicular installation unit, power supply equipment, and control and accessory units are included.

RADIO SET

AN/VRQ-3()

This equipment can be operated by means of Control Group AN/GRA-6 from a remote point up to a distance of about 2 miles over a telephone pair.

RELATIONSHIP TO SIMILAR EQUIPMENT:

TECHNICAL DESCRIPTION:

Frequency Range in Mc: 38.0 to 54.9

Type Modulation: fm

Type of Signal: voice

Power Output (Each Transmitter):

High Power: 9 to 16 w

Low Power: 2 w

Power Requirements: 12/24-v dc from vehicular storage battery

Major Units:

1	AN/GRA-6		20.85 lbs
2	PP-109/GR, or	9" x 13" x 8"	33 lbs
2	PP-112/GR	9" x 13" x 8"	33 lbs
2	RT-68/GRC	9" x 13" x 11 ¹ / ₄ "	35 lbs

TUBES, CRYSTALS, TRANSISTORS:

REFERENCE DATA AND LITERATURE:

TM 11-287

RADIO RECEIVING SET

AN/VRR-4

15 March 1962

Cog. Serv: USA FSN: 5820-164-7175

USA Line Item No.: 636280

	USA	USN	USAF	USMC
STATUS OR TYPE CLASS.:	Std-C			

Manufacturer:

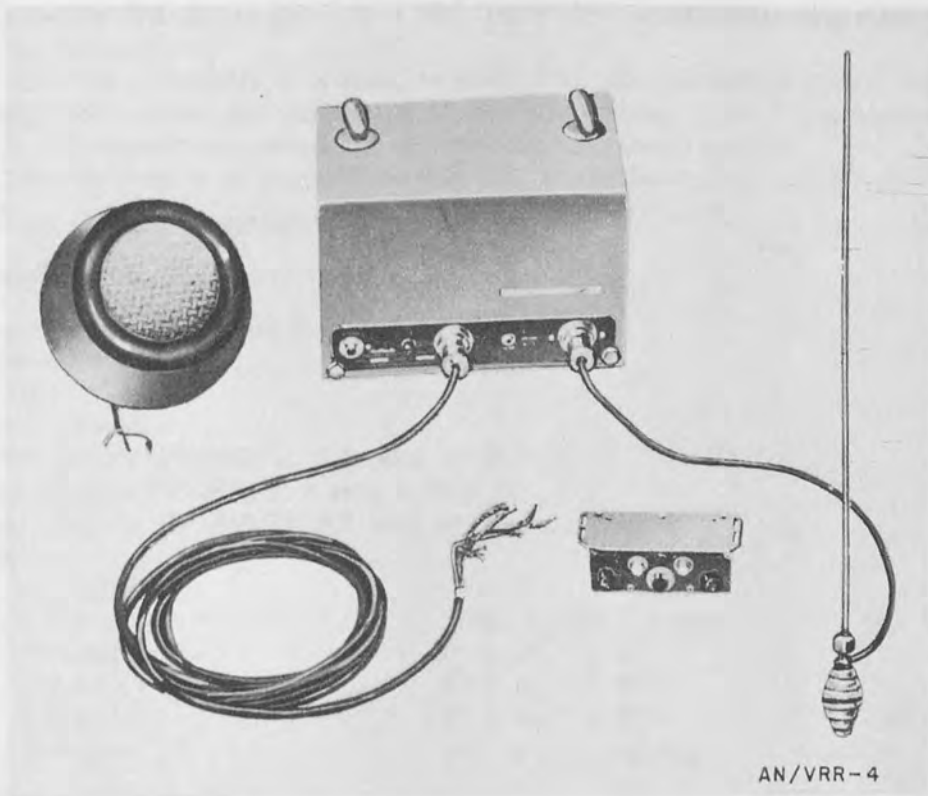
**FUNCTIONAL DESCRIPTION:**

Radio Receiving Set AN/VRR-4 is a vehicular, short-range, fm, fixed-frequency, crystal-controlled radio receiver used by military police, guard, and security troops for traffic control and similar communication in the vhf band.

This equipment consists essentially of a commercial (Galvin FMR-13 v), police car radio receiver and loudspeaker, plus accessories.

This set is composed of the receiver components of Radio Set AN/VRC-2 and uses a whip-type vehicular antenna. It is powered by the storage battery of the vehicle in which it is installed.

RADIO RECEIVING SET

AN/VRR-4

RELATIONSHIP TO SIMILAR EQUIPMENT:

TECHNICAL DESCRIPTION:

Frequency Range in Mc: 30 to 40

Type Modulation: fm

Type of Signal: voice

Power Requirements: 8 amp at 6-v from vehicular storage battery.

Major Units:

1 P-8022 (Galvin)

1 FMR-13V (P8028) (Galvin).

9⁵/₁₆" x 14³/₄" x 9¹/₂"

TUBES, CRYSTALS, TRANSISTORS:

REFERENCE DATA AND LITERATURE:

RADIO RECEIVING SET

AN/VRR-7

15 March 1962

Cog. Serv: USA FSN: 5820-682-2590

USA Line Item No.: 658596

	USA	USN	USAF	USMC
STATUS OR TYPE CLASS.:	Std-A			

Manufacturer: Motorola, Inc

No Illustration Available

FUNCTIONAL DESCRIPTION:

Radio Receiving Set AN/VRR-7 is a vhf, fm (voice) equipment used in monitoring and communications applications.

This set consists essentially of a radio receiver with an appropriate power supply, housed in a metal equipment cabinet, and includes either a roof mounted whisker type antenna for hard-top vehicles or a bumper-mounted coaxial antenna for canvas-top vehicles.

It is a vehicular version of Radio Receiving Set AN/FRR-36.

RELATIONSHIP TO SIMILAR EQUIPMENT:**TECHNICAL DESCRIPTION:**

Frequency Range in Mc: 152 to 174

Type Modulation: fm

Type of Signal: voice

Power Requirements:

Power Supply PP-867/U: 1.1 amp at 24-v dc

Power Supply PP-868/U: 2 amp at 12-v dc

Power Supply PP-869/U: 3.7 amp at 6-v dc

Major Units:

1	AT-496/G		
1	CY-1150/U	10 ⁵ / ₈ " x 21 ¹ / ₄ " x 7 ¹ / ₂ "	14.5 lbs
1	PP-867/U, or	5" x 6 ¹ / ₄ " x 7"	10 lbs
1	PP-868/U, or	5" x 6 ¹ / ₄ " x 7"	10 lbs
1	PP-869/U	5" x 6 ¹ / ₄ " x 7"	10 lbs
1	R-394/U	8 ¹ / ₂ " x 14 ¹ / ₂ " x 5 ³ / ₄ "	17 lbs

TUBES, CRYSTALS, TRANSISTORS:**REFERENCE DATA AND LITERATURE:**

TM 11-229

MIL-N-11539

AN/VRR-type
RADIO RECEIVER**R-108/GRC, -109/GRC, -110/GRC**

15 March 1962

Cog. Serv: USA FSN: R-108/GRC: 5820-503-1258
R-109/GRC: 5820-503-1413
R-110/GRC: 5820-503-1254USA Line Item No.: 635660 (R-108/GRC)
635661 (R-109/GRC)
635662 (R-110/GRC)

	USA	USN	USAF	USMC
STATUS OR TYPE CLASS.:	Std-B			
Manufacturer:	Federal Telephone and Radio Corp			

FUNCTIONAL DESCRIPTION:

Radio Receivers R-108/GRC, R-109/GRC, and R-110/GRC are small lightweight, frequency-modulated, superhetrodyne-type receivers designed for use in vehicular or ground installations. They provide for the reception of voice modulated fm signals between the range of 20 to 55 megacycles, and are similar except for their operating frequency range, the components that determine the frequency range, and the bias source for the squelch oscillator.

The equipments contain continuously variable tuning; detent selection of three preset frequencies is also included. They may be operated from a storage battery, in conjunction with a plug-in vibrator-type voltage supply, or from an external power source.

RELATIONSHIP TO SIMILAR EQUIPMENT:**TECHNICAL DESCRIPTION:***Frequency Range in Mc:*

R-108/GRC: 20 to 28

R-109/GRC: 27 to 39

R-110/GRC: 38 to 55

Channel Data:

R-108/GRC: 80

R-109/GRC: 120

R-110/GRC: 170

Channel Spacing: 110 kc*Type of Signal:* voice or tone*Audio Output:*

Loudspeaker: 500 mw

Earphones: 40 mw

Output Impedance: 600 ohms (unbalanced)*Antenna Type:* portable whip*Power Requirements:* Power Supply PP-448/GR with 6-v storage battery, Power Supply PP-281/GRC with 12-v storage battery, or Power Supply PP-282/GRC with 24-v storage battery*Major Units:*

1 (of the 3 major equipments)

7 $\frac{1}{4}$ " x 9" x 12 $\frac{13}{16}$ "

20.25 lbs

AN/VRC-type
RADIO RECEIVER

R-108/GRC, -109/GRC, -110/GRC

TUBES, CRYSTALS, TRANSISTORS:

REFERENCE DATA AND LITERATURE:

TM 11-898

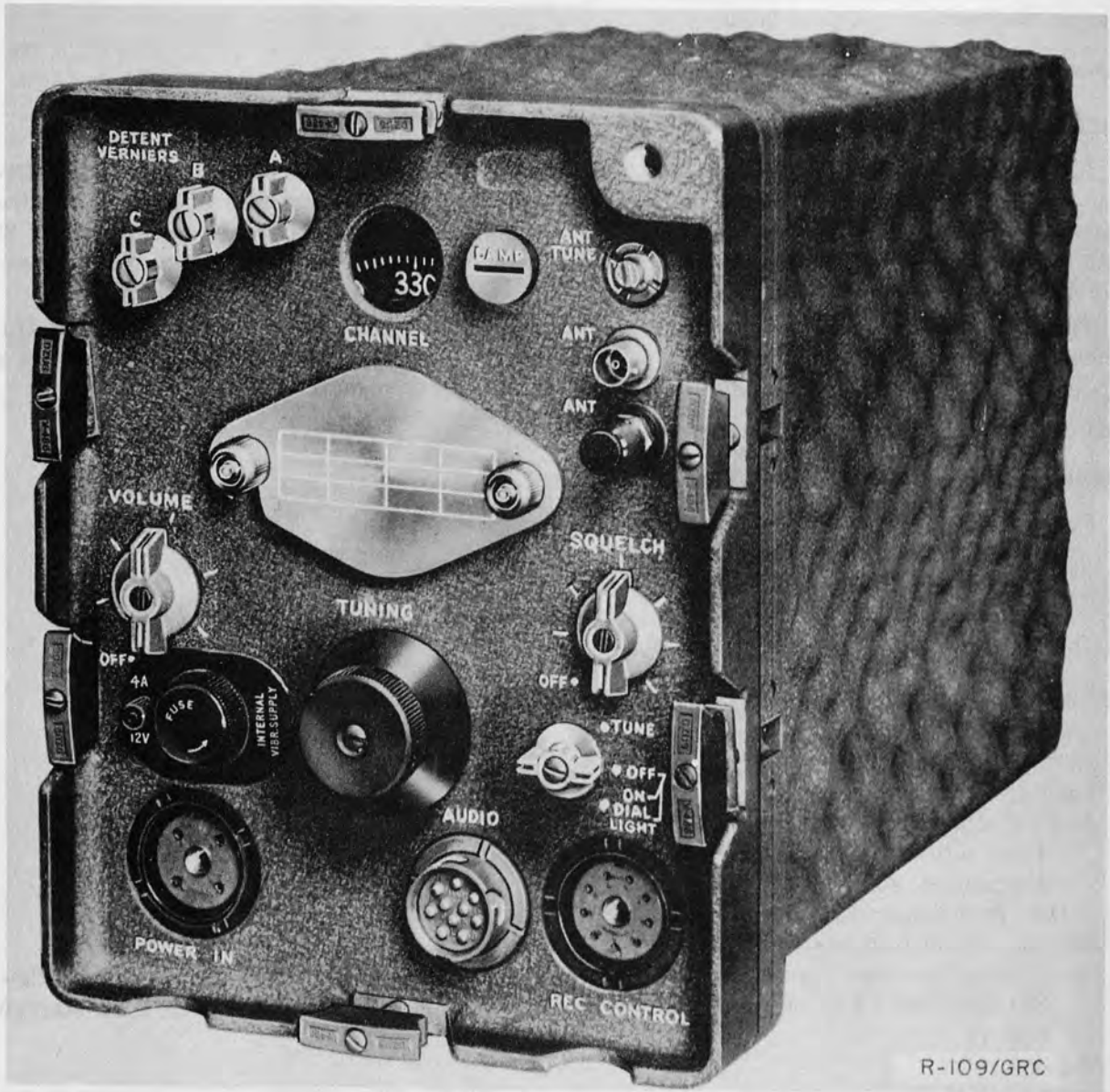

R-109/GRC

ANTENNA GROUP

AN/WRA-2(XN-2)

15 March 1962

Cog. Serv: USN FSN:

USA Line Item No.:

	USA	USN	USAF	USMC
STATUS OR TYPE CLASS.:		Pln Std		
Manufacturer:	CKB (28959)			

FUNCTIONAL DESCRIPTION:

Antenna Group AN/WRA-2(XN-2) is a telescoping, base-fed, grounded-quarterwave, vertical antenna of the hybrid helix-whip type with remote-control tuning and position-indicating mechanisms. Antenna Group AN/WRA-2(XN-2) is intended for use with Radio Transmitter Set AN/WRT-4(XN-1), (XN-2), or (XN-3) aboard an undersurface vessel. However, with a suitable ground plane and hydraulic system, it can be used in other installations with any transmitter and transmission line having the required electrical characteristics.

The antenna group is capable of radiating the output of any transmitter operating on any frequency between 2 and 32 megacycles and having a power output of not more than 1000 watts continuous or 5000 watts peak (25% duty cycle). The input impedance of the antenna group is variable and permits the matching of a 50 ohm transmission line with a voltage standing wave ratio (vswr) of not more than 1.5 to 1 over most of the frequency range. In no case will the vswr exceed 2.5 to 1. It is possible to match the antenna group to any transmission line having an impedance of from 35 to 150 ohms.

RELATIONSHIP TO SIMILAR EQUIPMENT:

The AN/WRA-2(XN-2) is similar to the AN/WRA-2(XN-1) with the following differences: The AN/WRA-2(XN-1) includes a hydraulic system as part of the equipment supplied; mounts unpressurized in the sail of the undersurface vessel; and its electrical and hydraulic circuits are different. Units are not interchangeable between the two equipments although some assemblies and components are.

EQUIPMENT REQUIRED BUT NOT SUPPLIED:

- 1 Radio Transmitting Set AN/WRT-4(XN-1), (XN-2), or (XN-3)
- 9 Interconnecting cables:
 - 1—FSGA-3 (W1)
 - 1—THOF-9 (W3)
 - 1—MHFF-19 (W4)
 - 1—MHFF-14 (W5)
 - 1—TTRSA-6 (W6)
 - 1—WSCA-30 (W8)
 - 1—TSGA-14 (W9)
 - 1—MSCA-10 (W10)
 - 1—RG-17A/U (W11)
- 1 Antenna Hydraulic system
- 1 rf connector (1A1P3)

ANTENNA GROUP

AN/WRA-2(XN-2)

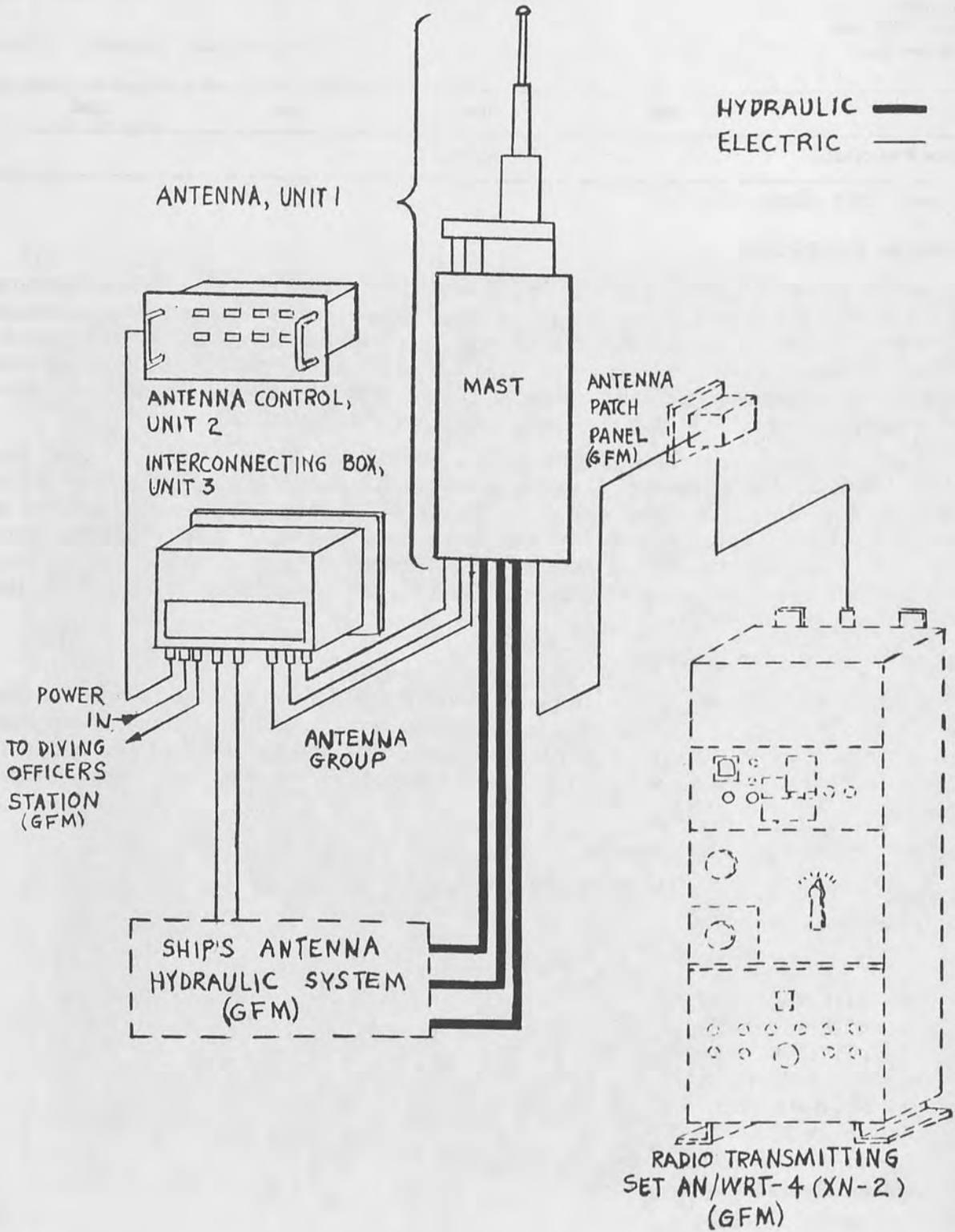

AN/WRA-2(XN-2)

TECHNICAL DESCRIPTION:

Frequency range: 2 to 32 mc

Rf input power: 5 kw peak (25% duty cycle), 1 kw continuous

Input impedance: 50 ohms (nominal)

Electrical requirements: 120 v, 12 amp, 400 cy, 3 phase, ac (delta system, ungrounded)

Hydraulic requirements: approx 400 psi; MIL-H-5606A hydraulic fluid for helix hydraulic cylinder. The whip is powered by a transducer using ship's system pressure reduced to 350 psi with MIL-H-5606A fluid.

Ambient temperature limitations:

Operating 0° to 50°C (+32° to +122°F)

Nonoperating: -62° to +75°C (-78.8° to +167°F)

How installed: Bolted to ship's mast

Number of operators required: 1

Major Units:

TUBES, CRYSTALS, TRANSISTORS:

REFERENCE DATA AND LITERATURE:

NAVSHIPS XXXXX, Technical Manual for Antenna Group AN/WRA-2(XN-2)

TRANSMITTER GROUP

AN/WRA-3(XN-1)

15 March 1962

Cog. Serv: USN FSN:

USA Line Item No.:

	USA	USN	USAF	USMC
STATUS OR TYPE CLASS.:		Pln/Std		

Manufacturer: CKB (82260)

FUNCTIONAL DESCRIPTION:

The AN/WRA-3(XN-1) is a continuous wave (cw) transmitter, designed for 15-watt operation. It is primarily intended for use as an exciter for larger transmitting equipment; however it may also be used independently when coupled to an antenna system with a 50-ohm impedance. It consists of five units housed in a cabinet.

RELATIONSHIP TO SIMILAR EQUIPMENT:**TECHNICAL DESCRIPTION:***Frequency Range:* 2 to 32 mc, 5 bands*Emission:* cw, A1*Power output:* 15 w*Operating Power Requirements:* 115 or 230 v ac, 47.5 to 63.0 cps, single phase.*Major Units:*

1 CY-3022(XN-1)/WRA-3

37" x 22.25" x 23.25"

TUBES, CRYSTALS, TRANSISTORS:**REFERENCE DATA AND LITERATURE:**

NAVSHIPS 94252

TRANSMITTER GROUP

AN/WRA-3(XN-1)

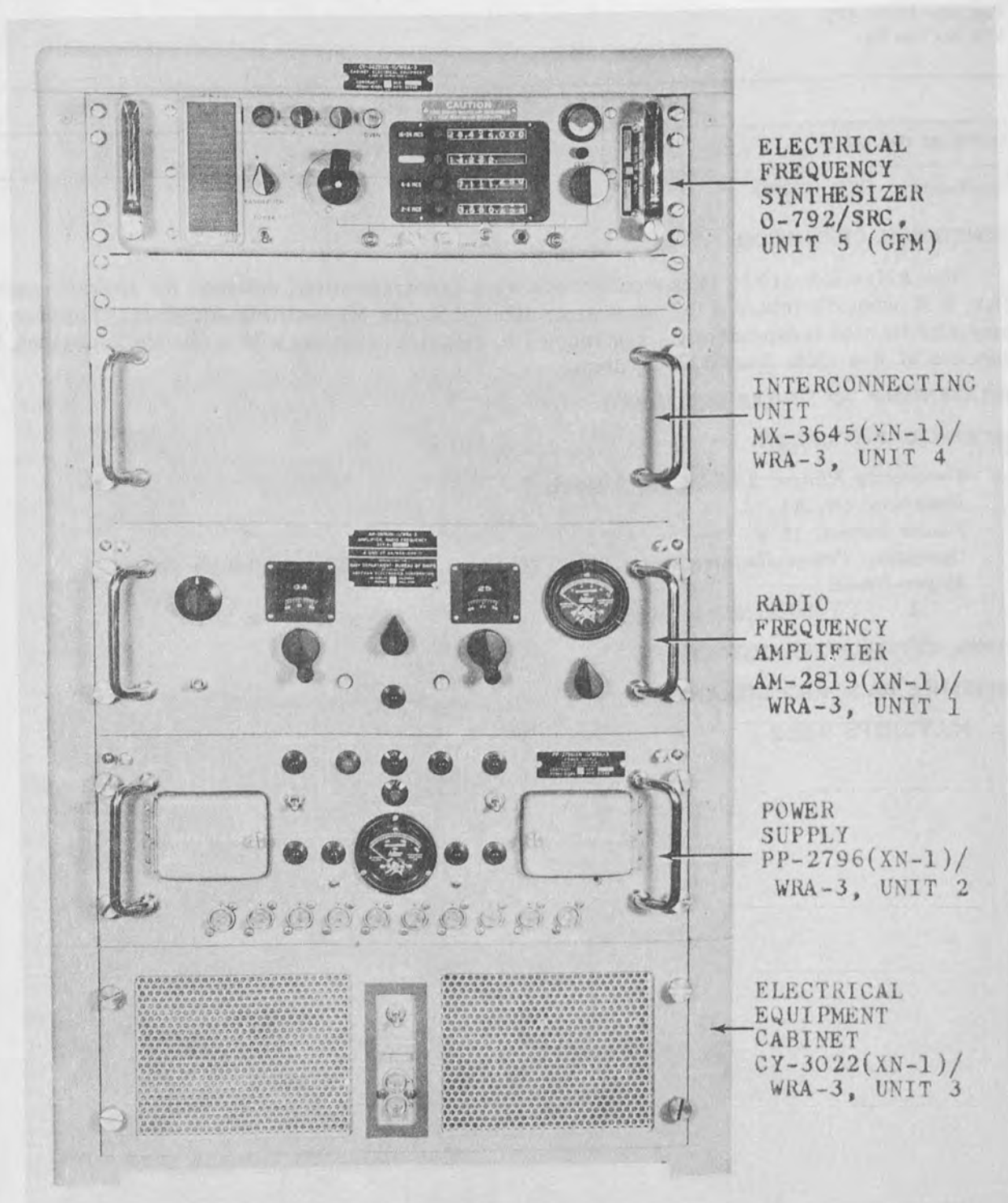

ELECTRICAL
FREQUENCY
SYNTHESIZER
0-792/SRC,
UNIT 5 (CFM)

INTERCONNECTING
UNIT
MX-3645(XN-1)/
WRA-3, UNIT 4

RADIO
FREQUENCY
AMPLIFIER
AM-2819(XN-1)/
WRA-3, UNIT 1

POWER
SUPPLY
PP-2796(XN-1)/
WRA-3, UNIT 2

ELECTRICAL
EQUIPMENT
CABINET
CY-3022(XN-1)/
WRA-3, UNIT 3

AN/WRC-1

15 March 1962

Cog. Serv: USN FSN:

USA Line Item No.:

	USA	USN	USAF	USMC
STATUS OR TYPE CLASS.:		Std		
Manufacturer:	CCPF (95403)			

No Illustration Available

FUNCTIONAL DESCRIPTION:

Radio Set AN/WRC-1 is a communication transmitting and receiving system requiring an automatic antenna tuning system for proper operation. The system consists of a receiver, a single sideband exciter, a junction box, and a power amplifier. The inclusion of independent sideband capability makes it possible to transmit and receive different information simultaneously. The exciter may be used to drive any compatible high power linear amplifier; the receiver may be used as a general purpose am or sideband receiver.

RELATIONSHIP TO SIMILAR EQUIPMENT:

The antenna tuning system generally used with the AN/WRC-1 is the AN/URA-38.

TECHNICAL DESCRIPTION:

Frequency Range: 2 to 30 mc in 1 kc increments

Frequency Stability: 1 part in 10^7 per week

Modes of Operation: am, cw, fsk, usb, lsb, isb

Receiver IF Rejection: -80 db

Receiver Image Rejection: -80 db

Receiver Audio Output:

60 mw into 600-ohm balance load

15 mw into 600-ohm unbalanced load

Receiver Audio Distortion: less than 1 percent

Receiver Noise Blanker: reduces pulse interference

Receiver Sensitivity: 1 uv for 10 db signal plus noise/noise

Receiver Bandwidth:

ssb-3.2 kc

am, cw-6 kc

Transmitter Power Output:

ssb-100 w PEP

am-25 w carrier

cw-50 w

fsk-50 w

Power Amplifier Output Impedance: 52 ohms

Receiver Power Consumption: 43 w

Exciter Power Consumption: 40 w

RADIO SET

AN/WRC-1

Power Amplifier Power Consumption:

ssb—130 w

am, fsk—150 w

Operating Power Requirements: 115 v ac, 48 to 1000 cps, single phase

Major Units:

1	R-1051/URR	7" x 17 ³ / ₈ " x 18 ¹ / ₈ "	25 lbs
1	T-827/URT	7" x 17 ³ / ₈ " x 18 ¹ / ₈ "	25 lbs
1	AM-3007/URT	7" x 17 ³ / ₈ " x 15 ³ / ₄ "	35 lbs

TUBES, CRYSTALS, TRANSISTORS:

REFERENCE DATA AND LITERATURE:

RADIO RECEIVING SET
AN/WRR-3(XN-1)

15 March 1962
Cog. Serv: USN FSN:
USA Line Item No.:

	USA	USN	USAF	USMC
STATUS OR TYPE CLASS.:		P/Std		
Manufacturer:	CMX (37695)			

No Illustration Available

FUNCTIONAL DESCRIPTION:

The AN/WRR-3(XN-1) is a dual conversion superheterodyne receiver for ashore, surface craft, and submarine installations. The chassis is mounted on slides for ease in servicing. It may be removed from its case and tilted for access to the underside of the receiver or completely removed for servicing. Most parts of the receiver are mounted on printed circuit boards. Each printed circuit board may be removed and replaced with a spare, and the faulty part repaired at a later time, thus keeping the receiver in operation for a maximum period.

RELATIONSHIP TO SIMILAR EQUIPMENT:

TECHNICAL DESCRIPTION:

Frequency Range: 14 to 600 mc, 5 band

Reception: A1, A2, F1

Receiver Output: two 600-ohm balanced lines and two front panel headphone jacks

Receiver Input: 50 ohms on low selection; 200 uuf on high selection

Operating Power Requirements: 105, 115, or 125 v ac, 50 to 60 or 400 cps, single phase

Major Units:

1 R-/WRR-3(XN-1)

8.75" x 17.25" x 16.75"

69.5 lbs

TUBES, CRYSTALS, TRANSISTORS:

REFERENCE DATA AND LITERATURE:

NAVSHIPS 94112

RADIO TRANSMITTING SET
AN/WRT-4(XN-2)

15 March 1962
 Cog. Serv: USN FSN:
 USA Line Item No.:

	USA	USN	USAF	USMC
STATUS OR TYPE CLASS.:		P/Std		
Manufacturer:	CKB (82260)			

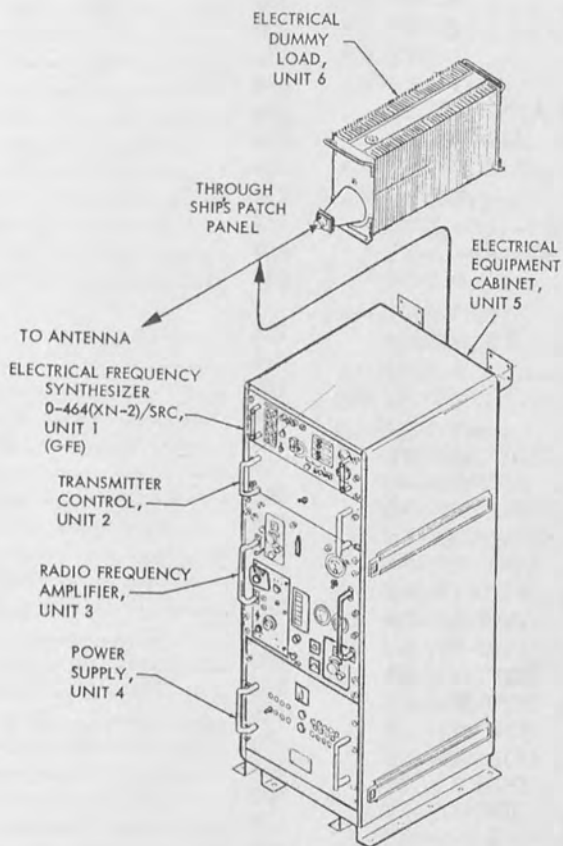

FUNCTIONAL DESCRIPTION:

The AN/WRT-4(XN-2) is a high frequency radio transmitter capable of 1 kw of continuous power on A1 emission. It is a lightweight, water-cooled continuous wave (cw) transmitter, primarily designed for submarine installation.

RELATIONSHIP TO SIMILAR EQUIPMENT:

Similar to the AN/WRT-4(XN-1)

RADIO TRANSMITTING SET

AN/WRT-4(XN-2)

TECHNICAL DESCRIPTION:

Frequency Range: 2 to 32 mc, 6 bands

Emission: A1 cw

Impedance: 50 ohms

Operating Power Requirements: 120 v ac, 400 cps, three-phase, 7000 w

Major Units:

1 Cabinet Unit 5

55 $\frac{3}{8}$ " x 22 $\frac{5}{8}$ " x 28"

TUBES, CRYSTALS, TRANSISTORS:

REFERENCE DATA AND LITERATURE:

NAVSHIPS 93752

APPENDIX B

INDEX OF ITEMS BY TYPE NUMBERS (THIRD INCREMENT)

<i>Item</i>	<i>Page</i>	<i>Item</i>	<i>Page</i>
AN/TGC-1()	595	AN/TRT-3	695
AN/TGC-3	597	AN/TRT-Type:	
AN/TGC-14(V)	599	T-303A/G	697
AN/TGC-Type:		T-389A/TRC-29	699
EE-98-()	601	AN/TSA-16	701
TC-18	603	AN/TTC-7	703
TG-7-B	605	AN/TTQ-2	705
TH-5/TG	607	AN/TTQ-3	707
TT-4()/TG	609	AN/TXA-Type:	
AN/TIP-2	611	CV-172, -172A/U	709
AN/TIQ-2()	613	KY-44, -44A, -44B, -44C/FX	711
AN/TIQ-3()	617	AN/TXC-1()	713
AN/TRA-1()	619	AN/TXC-Type:	
AN/TRA-2	621	CV-2, -2A, -2B/TX	715
AN/TRA-10	623	FX-1, -1A, -1B	719
AN/TRA-19	625	RC-120-()	721
AN/TRA-Type:		AN/TXR-Type:	
C-292()/TRA	627	RD-92A/UX	723
CV-31()/TRA	629	AN/UGA-1	725
O-39()/TRA	631	AN/UGC-3	727
AN/TRC-1()	633	AN/UGC-Type:	
AN/TRC-3()	635	AM-2731/UGC	729
AN/TRC-4()	637	CM-185/UGC	731
AN/TRC-7, -7A, -7B	639	CV-972P/UGC	733
AN/TRC-8	643	KY-346P/UGC	735
AN/TRC-11()	645	PP-2713/UGC	737
AN/TRC-12()	647	RL-177A/UG	739
AN/TRC-20	649	RO-135/FRR	741
AN/TRC-22	651	SA-733/UGC	743
AN/TRC-24()	653	SB-1177/UGC	745
AN/TRC-27	655	SB-1178/UGC	747
AN/TRC-28	659	SB-1179/UGC	749
AN/TRC-29	661	SB-1180/UGC	751
AN/TRC-32	663	TD-410/UGC	753
AN/TRC-34()	665	TD-411/UGC	755
AN/TRC-35()	667	TH-42/UG	757
AN/TRC-36()	669	TT-47, -48/UG	759
AN/TRC-38	671	TT-47A, -48A/UG	763
AN/TRC-39	673	TT-69, -70/UG	767
AN/TRC-40	675	TT-69A, -70A/UG	771
AN/TRC-41	677	TT-128A, -129A/UG	773
AN/TRC-42()	679	TT-130A, -131A/UG	775
AN/TRC-69	681	AN/UGR-Type:	
AN/TRC-Type:		TT-171/UG	777
SCR/499-()	683	AN/UGT-Type:	
AN/TRQ-1	685	TT-187/UG	779
AN/TRR-2	689	AN/UIC-1, -1X	781
AN/TRR-7	691	AN/UNH-3A	783
AN/TRT-1	693		

<i>Item</i>	<i>Page</i>	<i>Item</i>	<i>Page</i>
AN/UNH-6	785	AN/USA-Type:	
AN/URA-8, -8A	787	TA-269/U	883
AN/URA-17	789	AN/USM-Type:	
AN/URA-19	791	MD-83A/ARN	885
AN/URA-23, -23A	793	AN/UXH-2(XN-3)	887
AN/URA-Type:		AN/UXH-5(XN-1)	889
CU-656/U, CU-873/U, CU-874/U	795	AN/VIA-1	891
CU-784A/U	797	AN/VIC-Type:	
CV-62/U	799	RC-298	893
CV-116/URR	801	AN/VRC-1	895
CV-157/URR	803	AN/VRC-2, -2X, -26, -26X	897
KY-43/URT	805	AN/VRC-3	901
KY-43A/URT	807	AN/VRC-6()	903
SB-1510/FRR	809	AN/VRC-7()	905
AN/URC-4	811	AN/VRC-8()	907
AN/URC-11	813	AN/VRC-9()	909
AN/URC-32	815	AN/VRC-10()	911
AN/URC-34, -34X	817	AN/VRC-13()	913
AN/URC-35	819	AN/VRC-14	915
AN/URC-Type:		AN/VRC-15()	917
AS-1018/URC	821	AN/VRC-16()	919
IP-591(XN-1)/U	823	AN/VRC-17	921
AN/URR-13, -13A, -13B, -13C	825	AN/VRC-18()	923
AN/URR-27	827	AN/VRC-19()	925
AN/URR-28(XN-1)	829	AN/VRC-20	927
AN/URR-29	831	AN/VRC-21	929
AN/URR-29X	833	AN/VRC-22	931
AN/URR-35, -35A, -35B, -35C	835	AN/VRC-27	933
AN/URR-35D	839	AN/VRC-30	935
AN/URR-36	841	AN/VRC-32	937
AN/URR-Type:		AN/VRC-33, -33A	939
AM-413D/G	843	AN/VRC-51	941
BC-312()	845	AN/VRC-Type:	
R-388()/URR	847	SCR-506-()	943
R-389()/URR	849	SCR-508-()	945
R-390/URR	851	AN/VRQ-1	947
R-390A/URR	853	AN/VRQ-2()	949
R-391/URR	855	AN/VRQ-3()	951
R-392/URR	857	AN/VRR-4	953
R-520()/URR	859	AN/VRR-7	955
AN/URT-7, -7A, -7B, -7C	861	AN/VRR-Type:	
AN/URT-7D	863	R-108, -109, -110/GRC	957
AN/URT-10(XN-1)	865	WRA-2(XN-2)	959
AN/URT-12	867	WRA-3(XN-1)	963
AN/URT-17	869	WRC-1	965
AN/URT-18	873	WRR-3(XN-1)	967
AN/URT-Type:		WRT-4(XN-2)	969
AM-2374/URT	877		
T-368()/URT	881		

Custodians:

Army—EL
Navy—BuShips
Air Force—AF-85

Preparing Activity:

Army—EL
MISC-0138

User activities:

Army—MO, MU