

D 101.11:
9-1580

DEPARTMENT OF THE ARMY
TECHNICAL MANUAL

TM 9-1580

DEPARTMENT OF THE AIR
FORCE TECHNICAL ORDER

TO 38-1-1

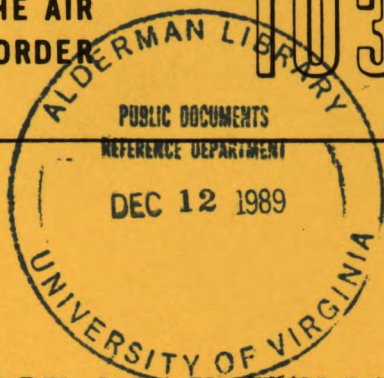

ORDNANCE MAINTENANCE

BINOCULARS M3, M7

M8, M9, M13, M13A1

M15, M15A1, M16

M17 AND M17A1 AND

BC TELESCOPE M65

This copy is a reprint which includes current
pages from Change 1.

DEPARTMENTS OF THE ARMY AND THE AIR FORCE

FEBRUARY 1953

Digitized by Google

TECHNICAL MANUAL

ORDNANCE MAINTENANCE:
BINOCULARS M3, M7, M8, M9, M13, M13A1, M15, M15A1, M16,
M17, AND M17A1 AND BC TELESCOPE M65

TM 9-1590 }
CHANGES No. 1 }

DEPARTMENT OF THE ARMY
WASHINGTON 25, D. C., 16 November 1955

TM 9-1580, 11 February 1953, is changed as follows:

The dimension of the center post in figure 30, RA PD 87039A, Special Fixture for Collimating BC Telescope M65, page 47, is changed as follows:

Change	To
9	7
16	16

[AG 418.74 (20 Oct 55)]

BY ORDER OF THE SECRETARY OF THE ARMY:

MAXWELL D. TAYLOR,
General, United States Army,
Chief of Staff.

OFFICIAL:

JOHN A. KLEIN,
Major General, United States Army,
The Adjutant General.

DISTRIBUTION:

Active Army:

CINCB (1)
Tec Svc, DA (2) except
COFORD (25)
Ord Bd (2)
Hq, CONARC (3)
Army AA Comd (2)
OS Maj Comd (2)
OS Base Comd (2)
Log Comd (3)
MDW (1)
Armies (3)
Corps (2)
Div (2)
Ord Gp (2)
Ord En (2) except TOE: 9-
46R (1)
Ord Co (2) except TOE's 9-
12R, 9-17R, 9-46R, 9-47R,
9-49R, 9-57R, 9-229R, 9-
347R, 9-367R, 9-337R, (1).

Ft & Cp (2)
Gen & Br Svc Sch (3) except
Ord Sch (50)
FMST Ord ROTC Units (1)
Gen Depots (2) except Atlanta
Gen Depot (None)
Ord Sec, Gen Depots (5)
Ord Depot (10) except Ross-
ford Ord Depot (12) Annis-
ton Ord Depot (18)
Trans Terminal Comd (2)
OS Sup Agencies (1)
Ord PG (10)
Ord Arsenal (5) except Bari-
tan Arsenal (100) Benicia
Arsenal (20)
Mil Dist (1)
Ord Proc Dist (10)
MAAG (1)
Mil Mm. (1)

NG: State AG (6); units—same as Active Army except allowance is one copy to each unit.

USAR: None.

For explanation of abbreviations used, see SR 320-50-1.

TM 9-1580/TO 38-1-1

This manual supersedes TM 9-1580, 15 March 1945, TB 9-1580-1, 13 March 1952; and those portions of TB ORD 331, 23 November 1945, and TB ORD 394, 10 October 1950, pertaining to the materiel covered herein.

ORDNANCE MAINTENANCE

BINOCULARS M3, M7
M8, M9, M13, M13A1
M15, M15A1, M16,
M17 AND M17A1 AND
BC TELESCOPE M65



United States Government Printing Office

Washington : 1953

This manual is correct to 13 October 1968

**DEPARTMENTS OF THE ARMY AND
THE AIR FORCE**

Washington 25, D. C., 11 February 1953

TM 9-1580/TO 38-1-1 is published for the information and guidance of all concerned.

[AG 413. 74 (10 Nov. 52)]

BY ORDER OF THE SECRETARIES OF THE ARMY AND THE AIR FORCE:

OFFICIAL:

WM. E. BERGIN
Major General, USA
The Adjutant General

J. LAWTON COLLINS
Chief of Staff,
United States Army

OFFICIAL:

K. E. THIEBAUD
Colonel, USAF
Air Adjutant General

HOYT S. VANDENBERG
Chief of Staff,
United States Air Force

DISTRIBUTION:

Active Army:

Tech Svc (1) ; Tech Svc Bd (2) ; AFF (2) ; AA Comd (2) ; OS Maj Comd (10) ; Base Comd (2) ; MDW (3) ; Log Comd (5) ; A (10) ; CHQ (2) ; Div (2) ; Regt 9 (2) ; Bn 9 (2) ; CO 9 (2) ; FT (2) ; Sch (5) except 9 (50) ; PMS & T 9 (1) ; Gen Dep (2) ; Dep 9 (10) ; POE (5), OSD (2) ; PRGR 9 (10) ; Ars 9 (10) ; Proc Dist 9 (10) ; Mil Dist (3).

NG: Same as Active Army except one copy to each unit.

Army Reserve: Same as Active Army except one copy to each unit.

For explanation of distribution formula, see SR 310-90-1.

CONTENTS

	<i>Paragraphs</i>	<i>Pages</i>
CHAPTER 1. INTRODUCTION		
<i>Section I.</i> General.....	1-3	1
<i>II.</i> Description and data.....	4-7	3
CHAPTER 2. PARTS, SPECIAL TOOLS, AND EQUIPMENT FOR FIELD AND DEPOT MAINTENANCE	8-19	20
3. INSPECTION		
<i>Section I.</i> Introduction.....	20-23	52
<i>II.</i> Inspection of binoculars and BC telescope in the hands of troops.....	24-28	54
<i>III.</i> Ordnance shop inspection.....	29-32	63
<i>IV.</i> Pre-embarkation inspection.....	33, 34	72
CHAPTER 4. TROUBLE SHOOTING	35, 36	74
5. REPAIR AND REBUILD OF BINOCULAR M3		
<i>Section I.</i> General maintenance.....	37-53	80
<i>II.</i> Rebuild of binocular M3.....	54-58	96
<i>III.</i> Tests and adjustments.....	59-65	107
CHAPTER 6. REPAIR AND REBUILD OF BINOCULARS M7 AND M16		
<i>Section I.</i> Rebuild of binoculars M7 and M16.....	66-69	124
<i>II.</i> Tests and adjustments.....	70-76	134
CHAPTER 7. REPAIR AND REBUILD OF BINOCULAR M8		
<i>Section I.</i> Rebuild of binocular M8.....	77-80	135
<i>II.</i> Tests and adjustments.....	81-87	141
CHAPTER 8. REPAIR AND REBUILD OF BINOCULAR M9		
<i>Section I.</i> Rebuild of binocular M9.....	88-91	143
<i>II.</i> Tests and adjustments.....	92-98	146
CHAPTER 9. REPAIR AND REBUILD OF BINOCULARS M13 AND M13A1		
<i>Section I.</i> Rebuild of binoculars M13 and M13A1.....	99-102	150
<i>II.</i> Tests and adjustments.....	103-109	156
CHAPTER 10. REPAIR AND REBUILD OF BINOCULARS M15, M15A1, M17, AND M17A1		
<i>Section I.</i> Rebuild of binoculars M15, M15A1, M17, and M17A1.....	110-113	161
<i>II.</i> Tests and adjustments.....	114-120	176
CHAPTER 11. REPAIR AND REBUILD OF BC TELESCOPE M65 AND TELESCOPE MOUNT M48		
<i>Section I.</i> General maintenance.....	121-124	178
<i>II.</i> Rebuild of BC telescope M65 and telescope mount M48.....	125-137	192
<i>III.</i> Tests and adjustments.....	138-149	251
CHAPTER 12. FINAL INSPECTION		
<i>Section I.</i> Inspection of binoculars.....	150, 151	267
<i>II.</i> Inspection of BC telescope M65 and telescope mount M48.....	152, 153	267
APPENDIX REFERENCES		269
INDEX		273



This manual supersedes TM 9-1580, 15 March 1945; TB 9-1580-1, 13 March 1962; and those portions of TB ORD 331, 23 November 1945 and TB ORD 394, 10 October 1950 pertaining to the matériel covered herein

CHAPTER I

INTRODUCTION

Section I. GENERAL

1. Scope

a. This manual is published for the information and guidance of personnel responsible for field and depot maintenance of binoculars M3, M7, M8, M9, M13, M13A1, M15, M15A1, M16, M17, and M17A1, and BC telescope M65. It contains information on maintenance beyond the scope of the tools, equipment, or supplies normally available to using organizations. This manual does not contain information which is intended primarily for the using organization, since such information is available to ordnance maintenance personnel in the pertinent operator's technical manual.

b. This manual contains a description of and procedures for inspection, disassembly, repair, rebuild, and assembly of binoculars, BC telescope, and equipment.

c. The appendix contains a list of current references, including supply catalogs, technical manuals, and other available publications applicable to the binoculars, BC telescope, and equipment.

d. Operation, lubrication, and all maintenance operations allocated to using organizations in performing maintenance work within their scope for the binoculars and BC telescope are contained in TM 9-575.

e. This manual differs from TM 9-1580, 15 March 1945, as follows:

- (1) Adds information on: Binoculars M13A1 and M17A1.
- (2) Revises information on: Binoculars M3, M7, M8, M9, M13, M15, M15A1, M16, and M17, and BC telescope M65.
- (3) Deletes information on: Binoculars M2 and M6, field glasses type EE, and BC telescopes M1915 and M1917 series.

2. Field and Depot Maintenance Allocation

The publication of instructions for complete disassembly and rebuild is not to be construed as authority for the performance

by field maintenance units of those functions which are restricted to depots and arsenals. In general, the prescribed maintenance responsibilities will apply as reflected in the allocation of maintenance parts listed in the appropriate columns of Department of the Army Supply Catalogs ORD 8 SNL F-210 (for binoculars M3, M8, M9, M13, and M13A1), ORD 8 SNL F-238 (for binoculars M7, M15, M15A1, M16, M17, and M17A1), ORD 8 SNL F-259 (BC telescope M65), and tool sets for maintenance of sighting and fire control equipment listed in ORD 6 SNL F-272, and ORD 6 SNL J-10, Section 13, 14. Instructions for depot maintenance are to be used by maintenance companies in the field only when the tactical situation makes the repair functions imperative. Provisions of parts listed in the depot stock guide column of the applicable ORD 8 SNL's will be made to field maintenance only when the emergency nature of the maintenance to be performed has been certified by a responsible officer of the requisitioning organization.

3. Forms, Records, and Reports

a. General. Responsibility for the proper execution of forms, records, and reports rests upon the officers of all units maintaining this equipment. However, the value of accurate records must be fully appreciated by all persons responsible for their compilation, maintenance, and use. Records, reports, and authorized forms are normally utilized to indicate the type, quantity, and condition of matériel to be inspected, to be repaired, or to be used in repair. Properly executed forms convey authorization and serve as records for repair or replacement of matériel in the hands of troops and for delivery of matériel requiring further repair to ordnance shops in arsenals, depots, etc. The forms, records, and reports establish the work required, the progress of the work within the shops, and the status of the matériel upon completion of its repair.

b. Authorized Forms. The forms, records, and reports generally applicable to units maintaining the binoculars and BC telescope are listed in the appendix. No forms other than approved Department of the Army forms will be used. For a current and complete listing of all forms, see current SR 310-20-6. For instructions on the use of these forms, see FM 9-10 and TM 9-1100.

c. Field Reports of Accidents. The reports necessary to comply with the requirements of the Army safety program are prescribed in detail in the SR 385-10-40 series of special regulations. These reports are required whenever accidents involving injury to personnel or damage to matériel occur.

d. Report of Unsatisfactory Equipment or Materials. Any suggestions for improvement in design and maintenance of equipment, safety and efficiency of operation, or pertaining to the application of prescribed lubricants, and/or preserving materials, will be reported through technical channels, as prescribed in SR 700-45-5, to the Chief of Ordnance, Washington 25, D. C., ATTN: ORDFM, using DA Form 468, Unsatisfactory Equipment Report. Such suggestions are encouraged so that other organizations may benefit.

Note. Do not report all failures that occur. Report only REPEATED or RECURRENT failures which indicate unsatisfactory design or material. See also SR 700-45-5 and the printed instructions on DA Form 468.

e. Report of Negligence. Report to the responsible officer any persistent carelessness, or negligence in the observance of preventive maintenance procedures and safety precautions. This report should be accompanied by recommendations for correcting the unsatisfactory conditions.

f. Inspection of Record Forms. At each inspection the inspector will examine the organization's record forms to make sure that these records have been kept up-to-date and that all entries have been properly made. (Previous repairs, work performed in connection with technical bulletins, and modification work orders are some records which are usually required.) Refer to chapter 3 for details.

Section II. DESCRIPTION AND DATA

4. Description

a. General. Figures 1 through 8 illustrate the binoculars, BC telescope M65, and equipment.

b. Binoculars (fig. 9).

- (1) The binoculars consist of two prismatic telescopes pivoted about a common hinge so as to permit adjustment of the distance between the eyepieces (interpupillary distance). The hinge holds the axes of the two telescopes in parallel alinement. The prism system in each telescope erects the image (which would otherwise appear inverted) and provides an offset line of sight which increases stereoscopic vision. The prism system also increases the effective optical length of the two telescopes without increasing their actual size, thus providing a more compact instrument. The left telescope of many models (par. 6b) contains a reticle with a scale pattern calibrated in mils (1/6400 part of a circle) for the measurement of small horizontal and vertical angles.

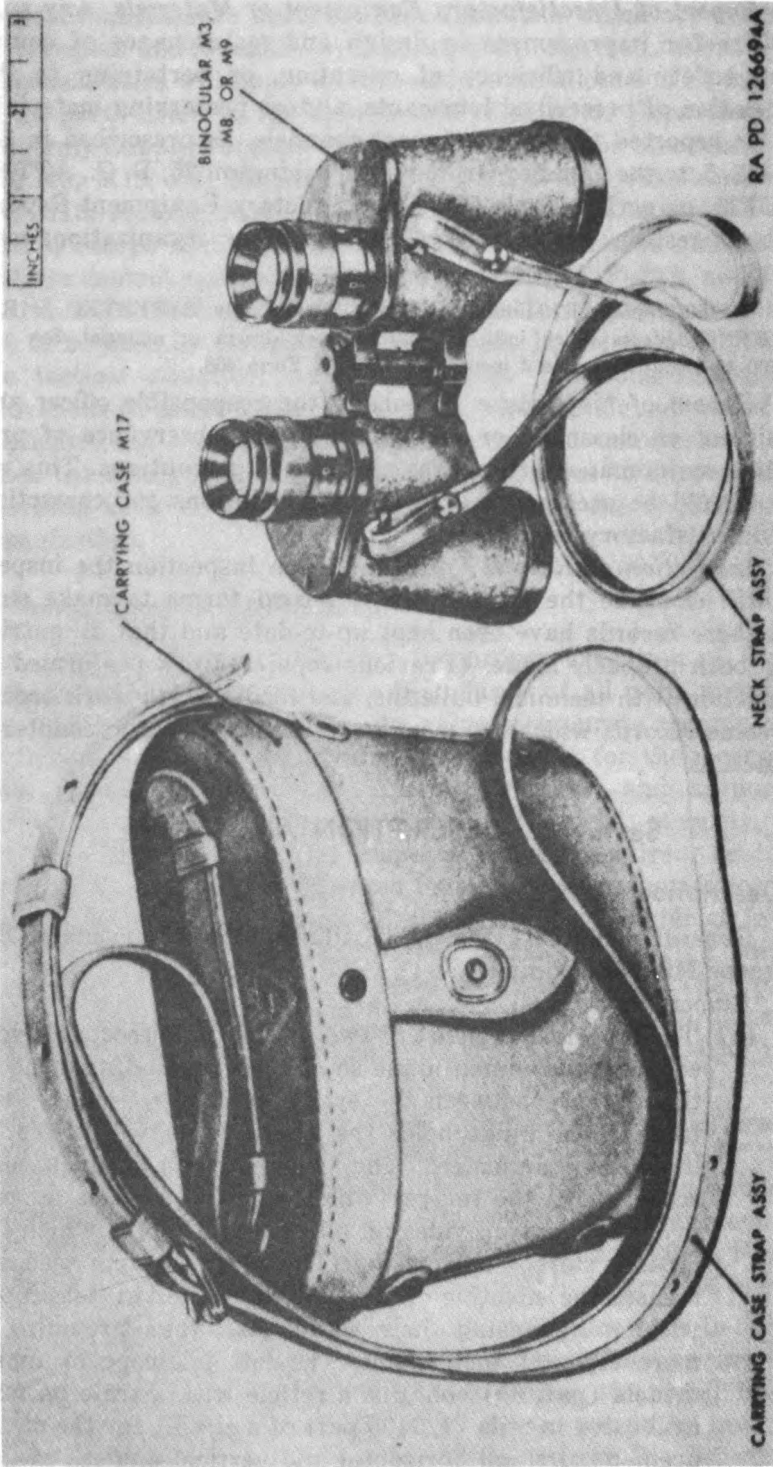

Figure 1. Binocular M8, M8, or M9 with carrying case M17.



Figure 2. Binocular M7 or M16 with carrying case M24.

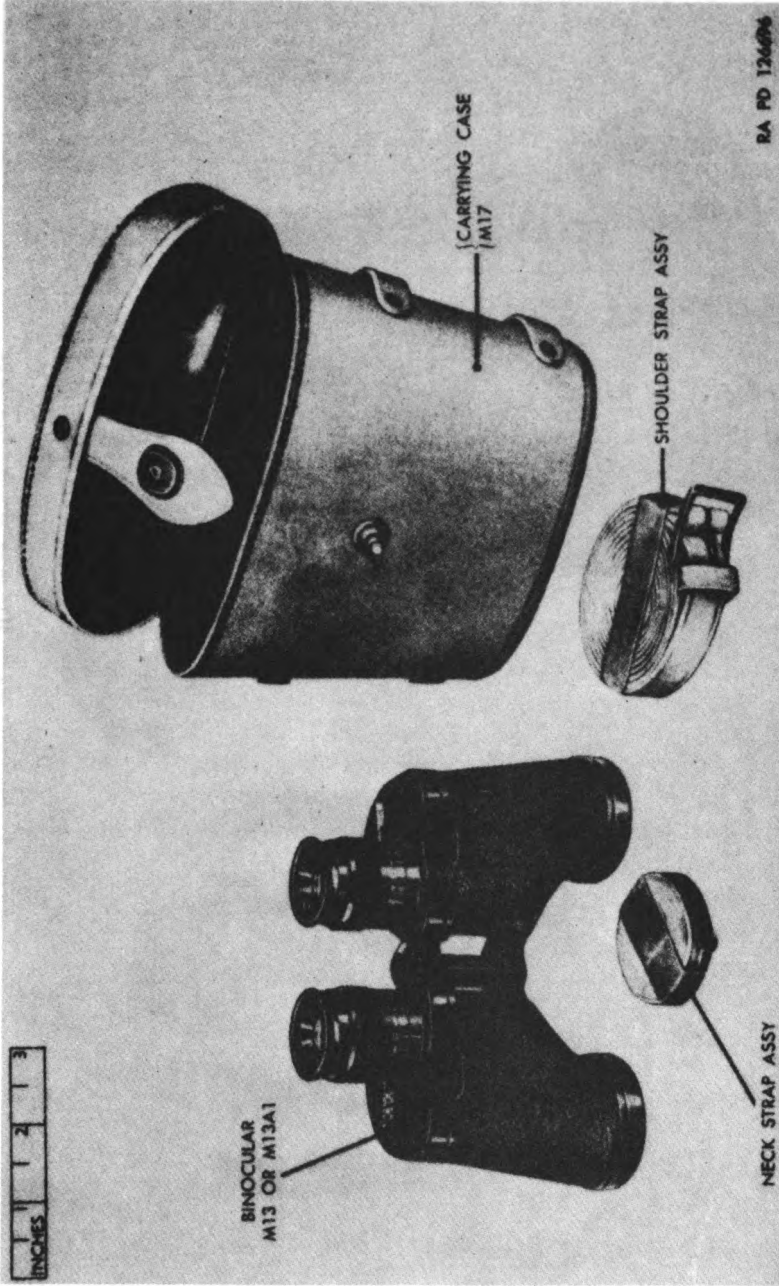

Figure 3. Binocular M13 or M13A1 with carrying case M17.

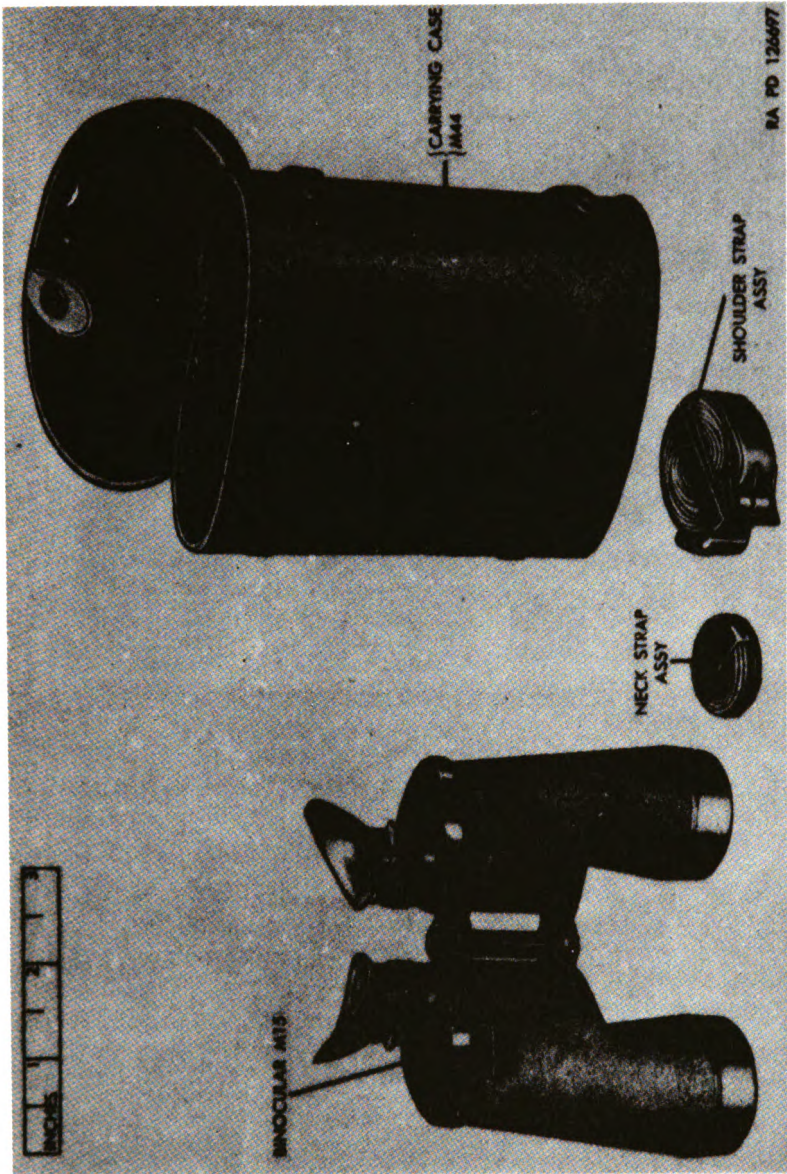

Figure 4. Binocular M16 with carrying case M44.

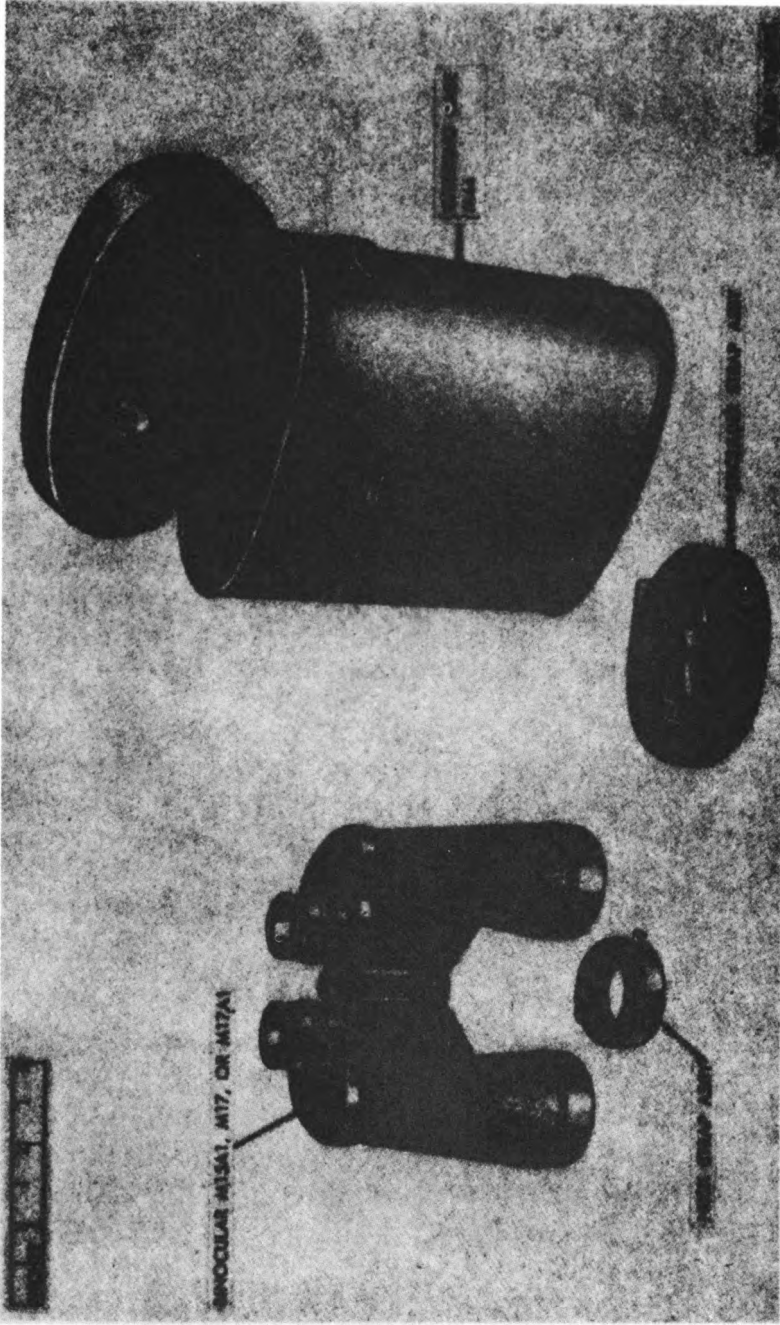

Figure 5. Binocular M15A1, M17, or M17A1 with carrying case M 44.

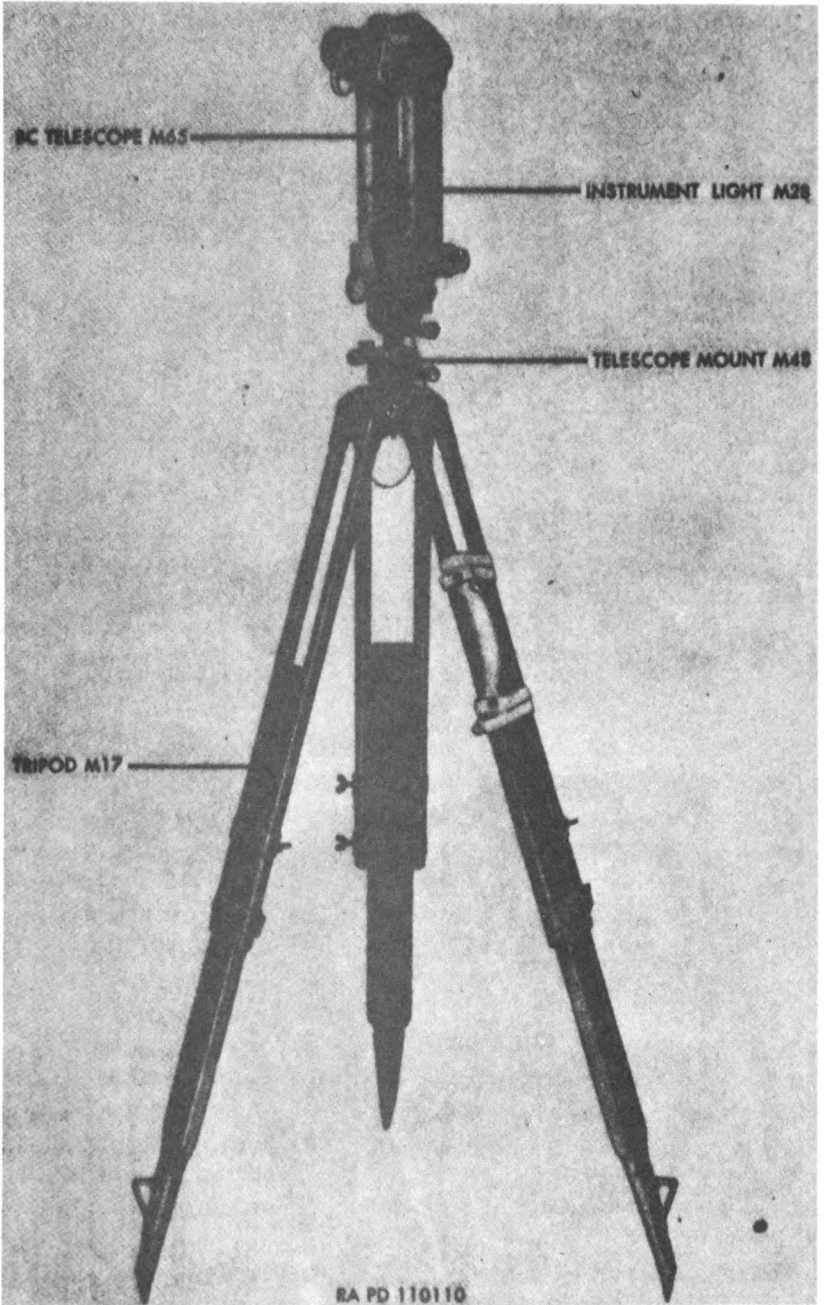

Figure 6. BC telescope M65 with equipment.

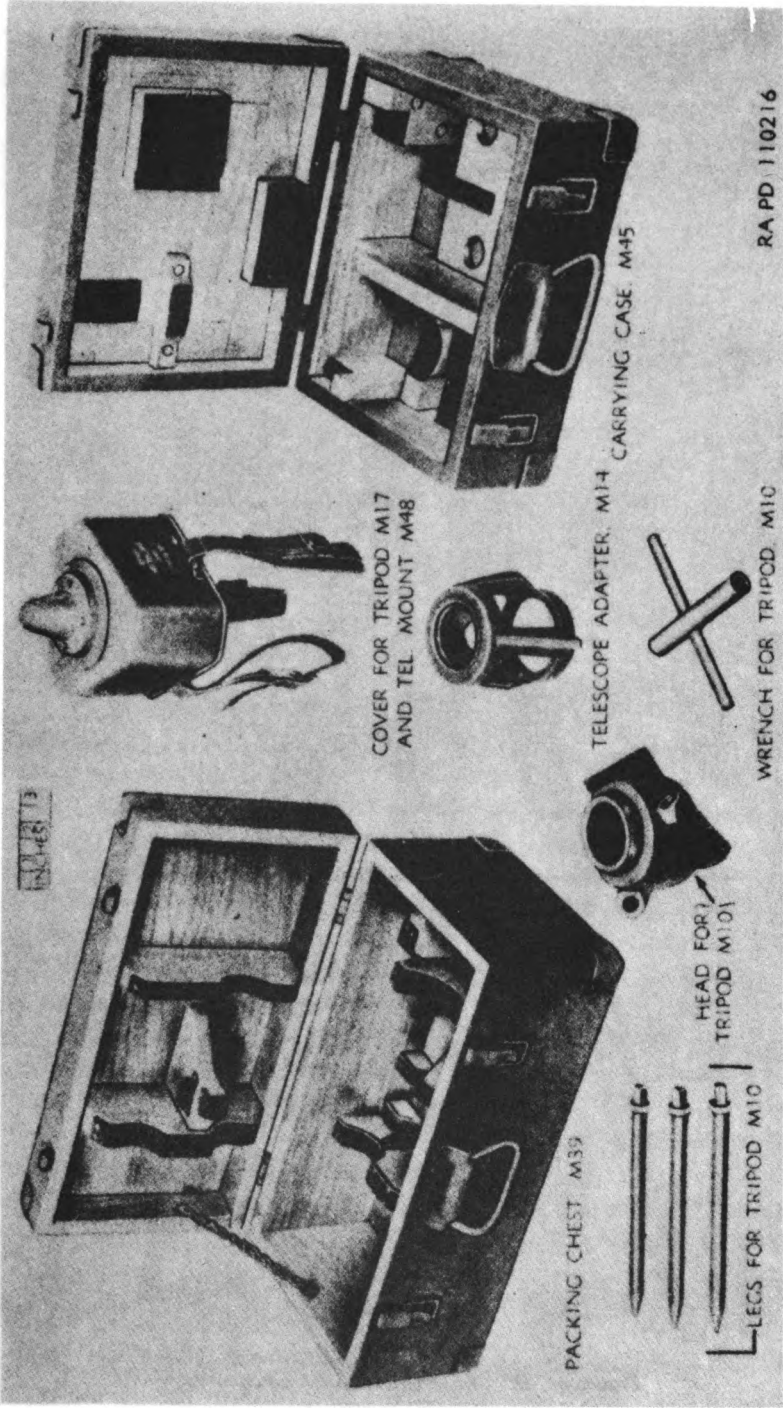

Figure 7. Equipment for BC telescope M66.



Figure 8. Carrying case M62 for binocular M3, M8, M9, M13 or M13A1.

- (2) All of the binoculars covered in this manual are constructed for separate focusing; that is, each eyepiece can be focused independently of the other by turning the diopter scale in a plus or minus direction. The scale, which is calibrated in diopters, indicates the correction required for the corresponding eye. Once the proper setting for diopter adjustment has been determined for each eye, the setting may be applied immediately on future use.
- (3) The binocular hinge is equipped with a scale which indicates in millimeters the interpupillary distance (distance between the pupils of the eyes). When the proper setting for the observer has been determined, any binocular may be adjusted at once for the correct interpupillary distance. (Refer to the operator's manual, TM 9-575.)
- (4) Binoculars are usually designated by the power of magnification and the diameter of the objectives. Thus, a 6 x 30 binocular magnifies 6 diameters and has objectives which are 30 millimeters in diameter. This designation is usually stamped on the body cover.

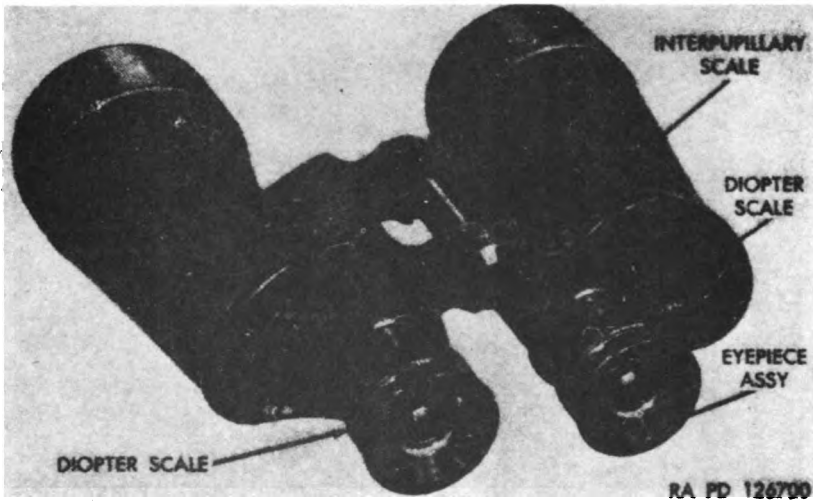

Figure 9. Location of principal components of typical binocular.

- (5) The optical elements of all binoculars are provided with a reflection reducing coating of magnesium fluoride. This coating may be recognized by the bluish tint of light reflected from the surfaces of the objective or eyepiece lens. The coating increases the efficiency of the binocular by cutting down loss of light by reflection at the many air-glass or glass-air surfaces in the instrument. Refer to TM 9-2601.
- (6) For further information on the binoculars, refer to TM 9-575 and to chapters 5 through 11 of this manual. Refer also to TM 9-575 for a description of filter M1 which is used for binoculars covered in this manual.

c. BC Telescope M65 (figs. 6 and 7)

- (1) The BC (battery commander's) telescope is similar in optical principle to the preceding binoculars. It is a binocular instrument which consists of two periscope-type telescopes joined at the top by a hinge mechanism (fig. 10) and at the bottom by an interpupillary mechanism and knob (figs. 10 and 11). The BC telescope M65 is not hinged at the bottom (as were earlier model battery commander's telescopes) and can be used only for periscopic observation. The BC telescope M65 in conjunction with its equipment (telescope mount M48, tripod M17, and instrument light M28, or telescope mount M48, adapter M14, tripod M10 and instrument light M28) is used for observation and the measurement of

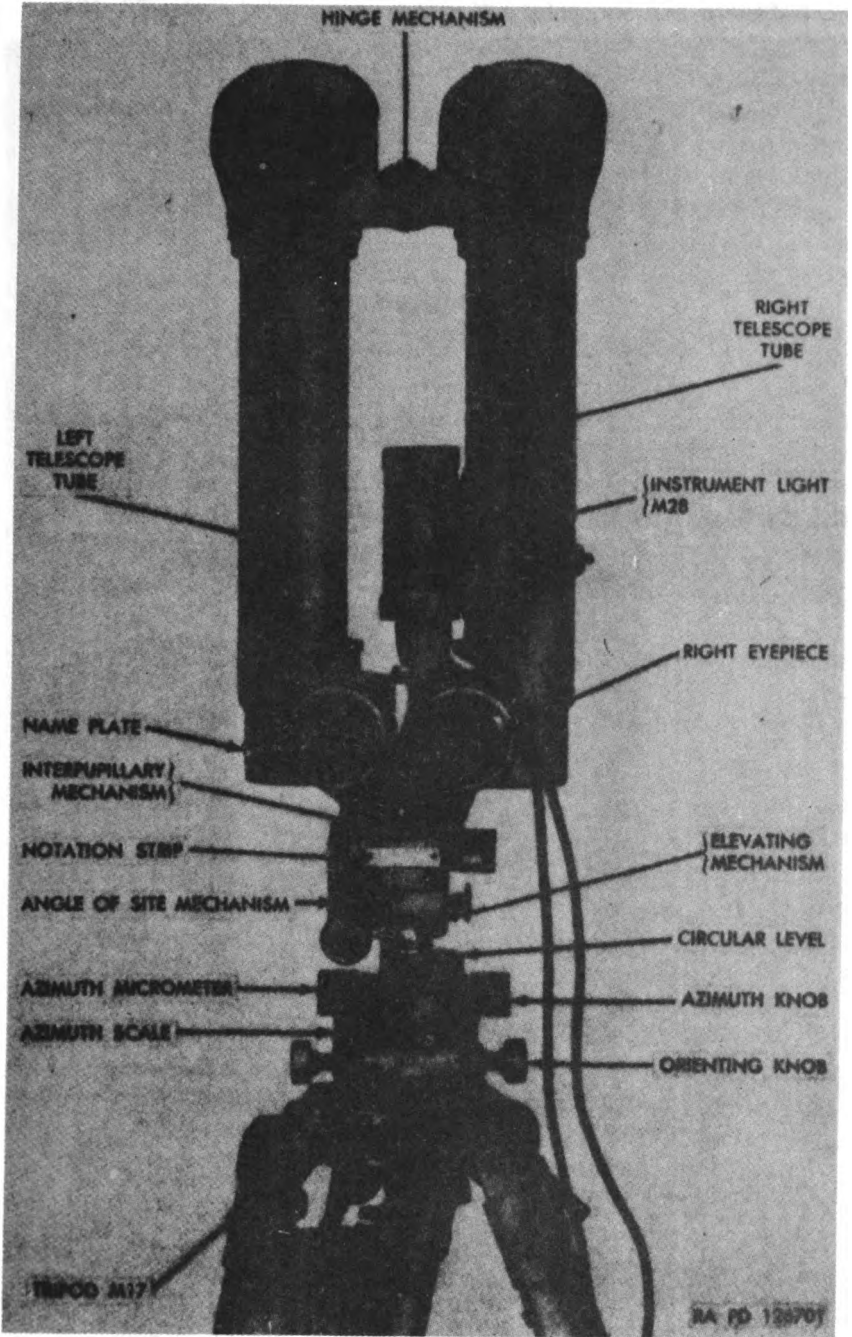

Figure 10. BC telescope M65 — rear view.

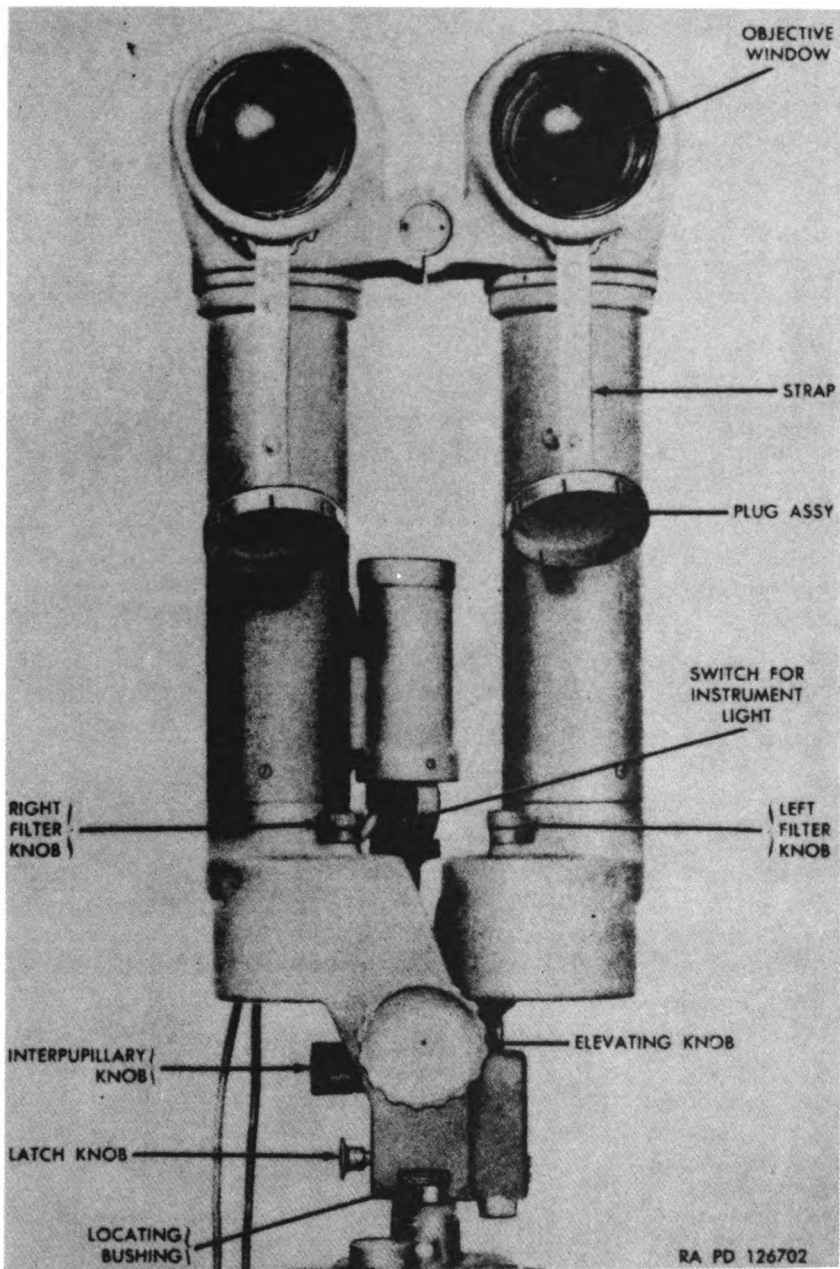

Figure 11. BC telescope M65 — front view.

angles of site and azimuth for artillery fire.

- (2) The two telescopes of the BC telescope are mounted on a worm-and-gear type elevating mechanism (fig. 10) which is actuated by an elevating knob (fig. 11) at the front (objective end) of the instrument. Elevation angles are measured by means of the angle of site mechanism (fig. 10) which consists basically of a worm actuated level vial. The angle of site micrometer is calibrated in mils and the level scale is calibrated in hundreds of mils with zero elevation at "3." Refer to TM 9-575.
- (3) The right telescope contains a reticle, calibrated in mils, for measuring angles in elevation and azimuth. One of the two lamps of instrument light M28 shines through a red filter in an opening in the right housing of the telescope and provides edge illumination for the reticle. The other lamp, on a flexible cable, is used as a hand light to read the instrument scales and micrometers.
- (4) Each telescope is provided with filters; an amber, red, or neutral filter or a clear window may be moved into position between the objective lens and eyepiece of either telescope by means of filter knobs (fig. 11) located on the front of the telescope.
- (5) Also, the BC telescope is used in conjunction with mount M48 for measurement of angles in azimuth. Mount M48 is equipped with a locating pin which is received by the locating bushing of the telescope (fig. 11). An azimuth worm, with micrometer (fig. 10), is used to rotate the telescope through horizontal angles. The angle is indicated in hundreds of mils on the body of the mount and in mils on the azimuth micrometer (fig. 10). An uncalibrated worm is used for orienting the telescope. By pushing horizontally on the azimuth knob (fig. 10), the azimuth micrometer worm may be temporarily disengaged from its gear for zeroing the scale or for rapid slewing of the telescope. Refer to TM 9-575.
- (6) If the BC telescope M65 and mount M48 are employed with tripod M10, adapter M14 must be used between the mount and the tripod. No adapter is necessary for use with tripod M17. A wrench is supplied for seating the legs of tripod M10 in the ground.
- (7) For further descriptive information on the BC telescope, refer to TM 9-575.

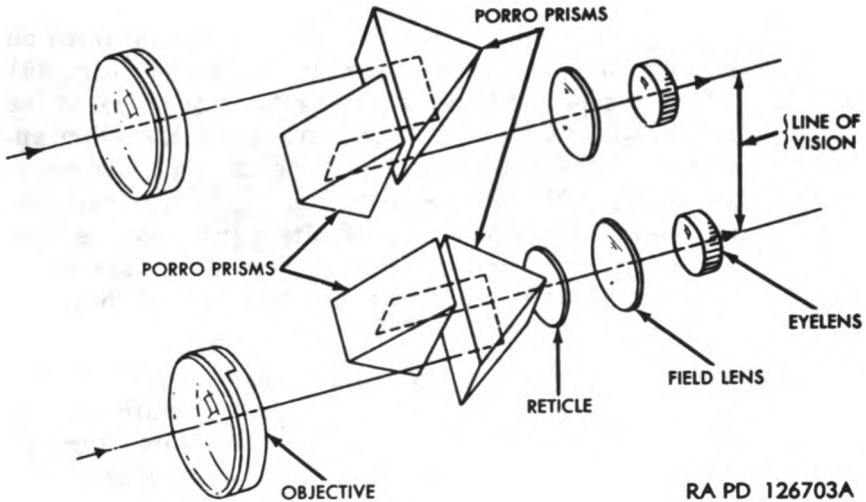

Figure 12. Optical system of typical binocular.

5. Functional Description

a. Binoculars. A simplified diagram of a typical binocular optical system is shown in figure 12. The objective lens forms a real and inverted image which is erected by the porro prisms and magnified by the eyepiece. The porro prisms are arranged to reduce the length of the telescope and to separate the objective lenses for greater stereoscopic effect. In the left eyepiece of some binoculars, the reticle in the focal plane superimposes scales on the field of view to permit approximation of ranges and small angles. The eyepiece lenses magnify the image to several times the size beheld by the unaided eye. For a full description refer to TM 9-575 and TM 9-2601.

b. BC Telescope M65. The optical system of BC telescope M65 (fig. 13) is similar to that of the binoculars, except for the modification of the prism system to achieve periscopic vision. The prism system of the telescope can be derived from that of the binocular described in *a* above by taking half of each of the vertical porro prisms and moving the 90° prisms thus formed upward to the telescope elbow. The telescope objective is located between the two parts of the prism thus obtained. The upper or 90° prisms are protected in use by plane-parallel glass windows.

6. Differences Among Binoculars

a. For differences in the appearance of the binoculars, refer to figures 1 through 5.

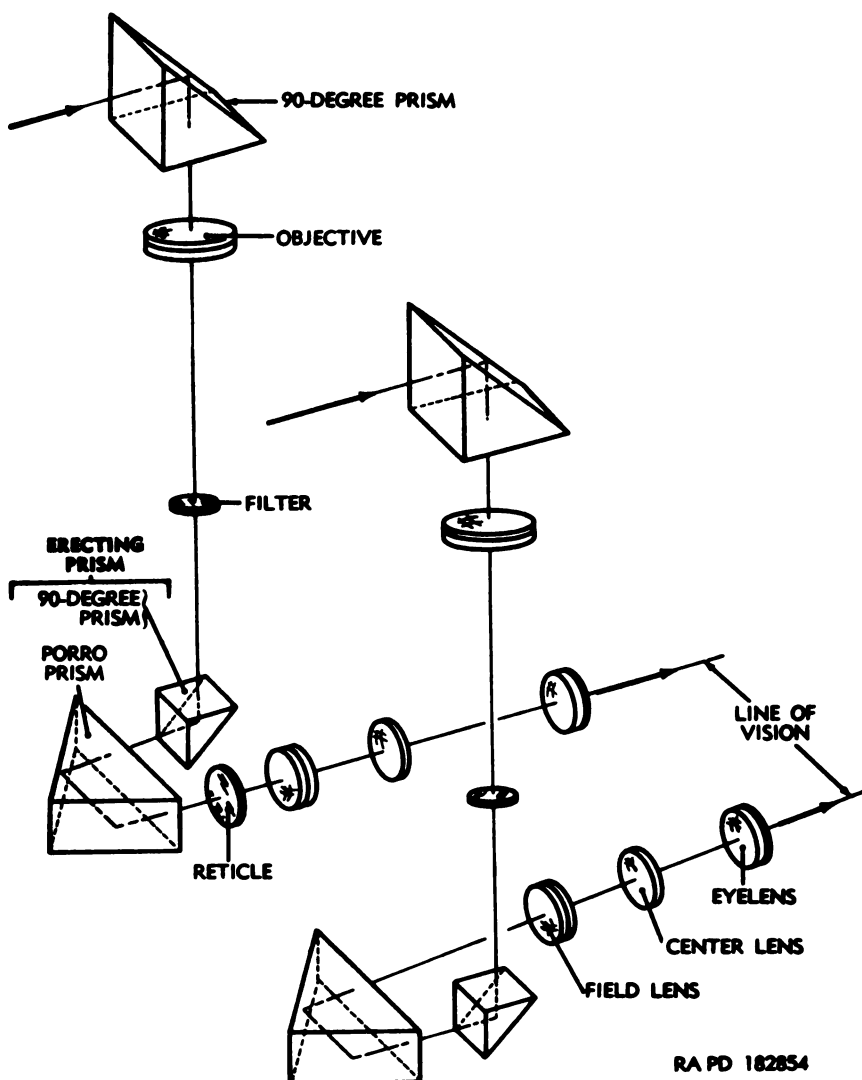

RA PD 182854

Figure 13. Optical system of BC telescope M65.

b. Binoculars M7, M15, and M15A1 have no reticles; binoculars M3, M8, M9, M13, M13A1, M16, M17, and M17A1 each have a reticle in the left telescope.

c. Modification of the binoculars to accommodate filter M1 is authorized in MWO ORD F210-W1 (binoculars M3, M8, M9, M13, and M13A1) and MWO ORD F238-W1 (binoculars M7, M15, M16, and M17). The modification consists basically in the installation of new eye guards, each with an annular groove for retention of the filter. For the 6 x 30 binoculars (M3, M8, M9, M13, and

M13A1), the old eye guards are simply unscrewed and the new ones installed. For binoculars M7 and M16, the eye guards are replaced as for the 6 x 30 binoculars. For binocular M17 (without built-in filters), the diopter scale clamping ring must be replaced, as well as the eye guard. For binoculars M15 and M17 with built-in filters, the eyeshields, built-in filters, and diopter scale clamping rings are removed and new clamping rings and the eye guards are installed. After modification, the designations of binoculars M15 and M17 are changed to M15A1 and M17A1, respectively. The designations of other binoculars are not affected. For the procedures required to effect the modification, refer to the applicable modification work order and to the rebuild chapters (5 through 11) of this manual. Modification of binoculars M17 and M17A1 is authorized by MWO ORD F238-W2. It involves removal of a portion of left prism shelf C7670777. This permits removal and installation of left prism assembly 7670776 and reticle assembly 7636815 as a unit. Modification of binoculars M3 and M8 is authorized by MWO ORD F210-W2. The modification consists of providing washer — A204753 in the objective assembly so as to prevent accidental rotation of parts during collimation adjustment.

d. Binoculars M13 and M13A1 are identical with the exception that the waterproofing of the M13A1 model has been improved over that of the M13 model. Instruments of early design are not waterproof, whereas those instruments of later manufacture are.

e. Binoculars M3 and M8 employ a setscrew to prevent the objective cell from turning in the eccentric ring and thus destroying the collimation of the instrument. Later binoculars employ an objective adapter with 1/8-inch slots and a washer with wing lugs which engage the slots to prevent turning of the objective cell.

f. At present, binoculars M3, M8, and M9 employ different reticle assemblies. Parts are available for standardization of the reticle assemblies. Refer to ORD 8 SNL F-210. However, the parts will be issued as individual components and not as an assembly.

g. Further differences may be seen from inspection of table I.

7. Tabulated Data

The optical characteristics of the binoculars and BC telescope are given in table I.

TABLE I. Optical Characteristics

Binocular	Power of magnification	Field of view	Diam. of exit pupil (in)	Effective focal length		Filter
				Objective (in)	Eyepiece (in)	
M3.....	6	8° 30'	0.197	5.191	0.865	When modified, all binoculars listed use filter M1.
M7.....	7	7° 16'	.280	7.583	1.083	
M8.....	6	8° 30'	.197	5.191	.866	
M9.....	6	8° 16'	.197	5.191	.865	
M13 or M13A1.	6	8° 30'	.197	5.191	.865	
M15 or M15A1.	7	7° 16'	.280	7.583	1.083	
M16.....	7	7° 16'	.280	7.583	1.083	
M17 or M17A1.	7	7° 16'	.280	7.583	1.083	Integral Red, amber, neutral, and clear.
BC Telescope M65.	10	6°	.177	10.756	1.076	

CHAPTER 2

PARTS, SPECIAL TOOLS, AND EQUIPMENT FOR FIELD AND DEPOT MAINTENANCE

8. General

Tools and equipment and maintenance parts over and above those available to the using organization are supplied to ordnance field maintenance units and depot shops for maintaining, repairing, and for rebuilding the matériel.

9. Parts

Maintenance parts are listed in Department of the Army Supply Catalog ORD 8 SNL's F-210, F-238, and F-259, which are the authority for requisitioning replacements. Parts not listed in an ORD 8 catalog, but required by depot shops in rebuild operations, may be requisitioned from the listing in the corresponding ORD 9 catalog and will be supplied, if available, when the need is substantiated. Requisitions for ORD 9 parts will contain a complete justification of requirements. Binocular bodies will not be supplied for rebuild purposes.

10. Common Tools and Equipment

Standard and commonly used tools and equipment having general application are authorized for issue by T/A and T/O&E. They are not specifically identified in this manual.

11. Special Tools and Equipment

The special tools and equipment tabulated in table II are listed in Department of the Army Supply Catalog ORD 6 SNL F-272. This tabulation contains only those special tools and equipment necessary to perform the operations described in this manual, is included for information only, and is not to be used as a basis for requisitions.

Note. Special tool sets in ORD 6 SNL F-272, in addition to special tools, also contain standard and commonly used tools and equipment specifically applicable to this matériel.

TABLE II. Special Tools and Equipment for Field and Depot Maintenance

Item	Identifying Number	Reference		Use
		Fig.	Par.	
BLOCK, "V," angle groove, CI, set of 3, size $1\frac{1}{4}$ x $3\frac{3}{4}$ x $1\frac{3}{8}$.	41-B-1472-100.....	14, 134, 195	135, 143.....	For holding collimating telescope during inspection tests.
FIXTURE, binocular testing.....	41-F-2987-457.....	20, 23, 64, 65	14, 64b and d, 65a and c, 76.	For accurate adjustment and inspection of binoculars.
FIXTURE, field glasses.....	41-F-2992-150.....	14, 56, 59, 61	60, 64b and c, 65..	For holding binoculars in rigid position during test and adjustment (will be superseded by fixture 41-F-2987-457).
FIXTURE, leveling.....	41-F-2994.....	24	17, 31o, 145, 147d.	Used for checking accuracy of elevating mechanism, angle of site mechanism, setting of level vials (BC telescope and mount M48).
FIXTURE, testing, azimuth.....	7691596.....	26, 27	17c, 18, 32e, 146c, 147d.	Used for testing azimuth movements of mount M48.
FIXTURE, testing, azimuth.....	41-F-2995.....	25	18, 32e, 146e.....	Used for testing azimuth movements of mount M48 (will be superseded by fixture 7691596).
GAGE, surface, univ, 9 in spindle, 3 x $2\frac{1}{2}$ in base.	41-G-372.....	14, 56, 190	60a, 64c, 65b, 143j, n.	Provides adjustments in height for mounted collimating telescope.
HOLDER, telescope, collimator.....	41-M-2374-125.....	14, 56, 190	60, 64c, 65b.....	Holds collimating telescope in position on surface gage during tests.

TABLE II. Special Tools and Equipment for Field and Depot Maintenance—Continued

Item	Identifying Number	References		Use
		Fig.	Par.	
HOT PLATE, elec, sgle unit, hv duty, 3 way control switch 120 v, 1,000 w, diam of top 7-in with 6-ft cord and plug.	17-H-7875.....	16	42, 43, 51, 56d.....	For melting sealing compound.
KIT, instrument repair complete w/tools. The following are some of the special tools which are included in the instrument repair kit and are required for the binoculars and BC telescope: TELESCOPE, collimating OD 1 in, length over-all 3 $\frac{3}{4}$ in.	41-K-96.....		38, 102e, 117f, 127l, 132e, 146f.....	General.
WRENCH, spanner, face, adj, Ordnance design, diam of pin 0.06 by 0.06 in, No. 2.	18-T-540-250.....	14, 56, 59, 61, 62, 63, 190	15, 31, 59, 60, 61, 64c, 65, 111c, 115, 143.	Optical inspection tests
WRENCH, spanner, face, adj, Ordnance design, diam of pin 0.07 in, No. 2.	41-W-3248-115.....	15	127k, p, w, 132b, o.	Removal of ball cap 7579463 and screw A181696 (BC telescope M65).
WRENCH, spanner, face, adj, Ordnance design, diam of pin 0.039 in, No. 2.	41-W-3248-125.....	15	127l, 132m.....	Removal of retaining ring B180804 (BC telescope M65).
WRENCH, spanner, face, adj, Ordnance design, diam of pin 0.039 in, No. 2.	41-W-3248-110.....	15	127d.....	Removal of objective cell adjusting screws A316673 (BC telescope M65).
WRENCH, spanner, face, adj, Ordnance design, diam of pin 0.1 in, No. 2.	41-W-3248-130.....	15, 187	127j, 132n.....	Removal of ball cap 7579736 (BC telescope M65).

WRENCH, strap, metal handle, lgh 7 $\frac{1}{4}$ in.	41-W-3382	15	56d, 101d	Removal of objective adanter from binocular body.
WRENCH, strap, wood handle, 8 $\frac{1}{4}$ in.	41-W-3385-25	15	56d, 101d	Used in lieu of wrench 41-W-3382.
LEVEL, mach, bench, adj, iron, ground and grad vial, w/cross level size 8 in.	41-L-1176-75	14, 190, 195	64b	Cross level surface plate 41-P-1565, for use as a horizontal base.
PLATE, adjustable leveling	18-P-22465	14, 56, 59, 61, 62, 63, 189, 190, 195	16, 60a, 64b, 65b	Level reference base for performing various optical tests and adjustments.
PLATE, surface, CI, w/handle and cover, size 12 by 18 in, (no holes on top).	41-P-1565	16, 134	16, 123b, 147c, 148a	Level reference base for performing various optical tests and adjustments.
TESTER, vibration, binocular	17-T-5549-925	19, 37	13, 30a	For simulating shock and handling conditions the binocular would undergo during normal use. Positive check for loose optical elements. Accommodates six binoculars.
TESTER, vibration, universal	17-T-5549-975	18, 38	12, 31a	Same as for fixture 17-T-5549-925 but used with suitable adapters, on BC telescope M65, or a single binocular.
WRENCH, binocular	41-W-3746-50	15	76	Used on binoculars M7 and M16 only for rotating eccentric ring and objective cell.
WRENCH, binocular, eccentric cell and bushing (sgle-end, tubular, pronged).	41-W-3740-150	14, 63, 65	65b	Used on binoculars M3, M8, M9, M13, and M13A1 for rotating eccentric ring and objective cell.
WRENCH, binocular M3	41-W-3746-500	15, 47	56b, 58e	Used on binocular M3 for removing reticle adapter A185479.

TABLE II. *Special Tools and Equipment for Field and Depot Maintenance—Continued*

Item	Identifying Number	References		Use
		Fig.	Par.	
WRENCH, binocular M3	41-W-3746	14	56g	For removing reticle retaining ring, binocular M3.
WRENCH, telescope lens retainer ring.	41-W-3740-200	14	120	Used on binoculars M15A1 and M17A1 only. For rotating eccentric ring and objective cell.
WRENCH SET, tubular dble-end, concave inserted blade, set of 76 wrenches.	41-W-3725-850	17	General.
The following wrenches which are part of wrench set 41-W-3725-850 are used on the binoculars and BC telescope:				
WRENCH, tubular, dble-end, concave inserted blade, size 1.094 and 1.109 in ($1\frac{1}{4}$ and $1\frac{1}{8}$ in).	41-W-3726-93	17, 75	68f, 112i	For removing left eyepiece assembly retaining ring, binocular M16.
WRENCH, tubular, dble-end concave inserted blade, size 1.187 and 1.203 in ($1\frac{1}{4}$ and $1\frac{1}{8}$ in).	41-W-3726-105	17, 68	68b	For removing reticle retaining ring, binocular M16.
WRENCH, tubular, dble-end, concave inserted blade, size 1.250 and 1.266 in ($1\frac{1}{4}$ and $1\frac{1}{8}$ in).	41-W-3726-113	17, 162	127i	For removing reticle retaining ring of BC telescope.

WRENCH, tubular, dble-end, concave inserted blade, size 1.406 and 1.422 in ($1\frac{1}{4}$ and $1\frac{1}{4}$ in).	41-W-3726-140.....	17, 164	127u.....	For removing retaining ring of BC telescope eyepiece assembly.
WRENCH, tubular, dble-end, concave inserted blade, size 1.594 and 1.609 in ($1\frac{1}{8}$ and $1\frac{3}{8}$ in).	41-W-3726-170.....	17, 50	56d.....	For removing objective assembly retaining ring binoculars M3, M8, M9, M13, and M13A1.
WRENCH, tubular, dble-end, concave inserted blade, size 1.875 and 1.891 in ($1\frac{1}{2}$ and $1\frac{3}{4}$ in).	41-W-3726-220.....	17, 159	127r.....	For removing retaining ring A316672 of BC telescope objective assembly.
WRENCH, tubular, dble-end, concave inserted blade, size 2.062 and 2.078 in ($2\frac{1}{8}$ and $2\frac{1}{4}$ in).	41-W-3726-250.....	17, 139	127d, 132a.....	For removing BC telescope objective assemblies.
WRENCH, tubular, dble-end, concave inserted blade, size 2.094 and 2.109 in ($2\frac{3}{8}$ and $2\frac{1}{4}$ in).	41-W-3726-255.....	17	68d, 112f.....	For removing retaining ring of objective assembly binoculars M7, and M16.
WRENCH, tubular, dble-end, concave inserted blade, size 2.344 and 2.359 in ($2\frac{1}{8}$ and $2\frac{3}{8}$ in).	41-W-3726-295.....	70, 152	68d, 112e, 127n.....	For removing window assemblies of BC telescope; for removing objective assembly retaining ring (M16 binocular only).
WRENCH, telescope, BC, M65 (dble-end tubular pin type, c to c of pins $\frac{1}{2}$ and $\frac{3}{4}$ in length 4 in).	41-W-3727-221.....	15	127p, 128c.....	For removing bushing A181697 (BC telescope M65) and nut A317309 (mount M48).

TABLE II. *Special Tools and Equipment for Field and Depot Maintenance—Continued*

Item	Identifying Number	References		Use
		Fig.	Par.	
WRENCH, telescope, BC, M65 (dble-end tubular pin type, c to c of pins $1\frac{1}{4}$ and $2\frac{1}{8}$ in length 4 in).	41-W-3727-225	15, 143, 154	127g, o	For removing ring A316642, and ring A316688 (BC telescope M65).
WRENCH, telescope, BC, M65 (hook spanner, diam of circle $1\frac{1}{8}$ in (1.078), length over-all $4\frac{1}{4}$ in).	41-W-3250-223	15, 147	127l, 132m	For removing spindle B181037, and bushing A46497 (BC telescope M65).
WRENCH, telescope, BC, M65 (hook spanner, diam of circle $2\frac{1}{4}$ in, length over-all $8\frac{1}{8}$ in).	41-W-3249-740	15, 138, 186	127c, 132a	For removing nut B180579 and releasing head assembly C82516.

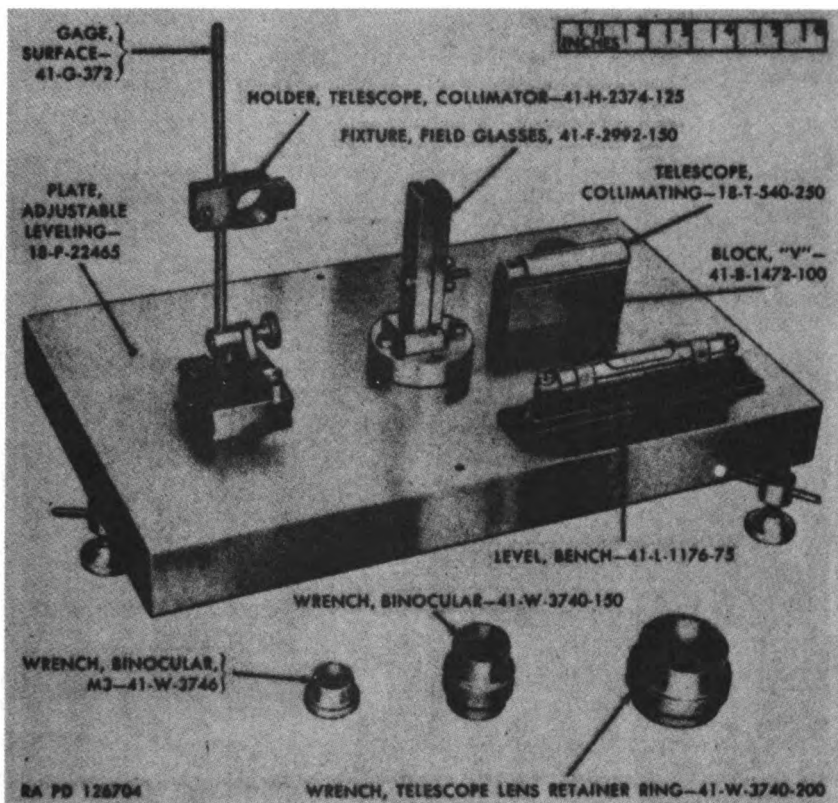

Figure 14. Special tools.

12. Universal Vibration Tester 17-T-5549-975 (fig. 18)

This is a motor driven vibrator with appropriate adapters for the BC telescope M65. It is used to determine that all parts are properly secured and that all dirt has been removed. Any defects due to maladjustment or serious dirt deposits are cause for rejection and reprocessing.

13. Binocular Vibration Tester 17-T-5549-925 (fig. 19)

This is a vibrator similar to the universal vibration tester described above but equipped with a clamping device for binoculars only. The tester will vibrate six binoculars at one time.

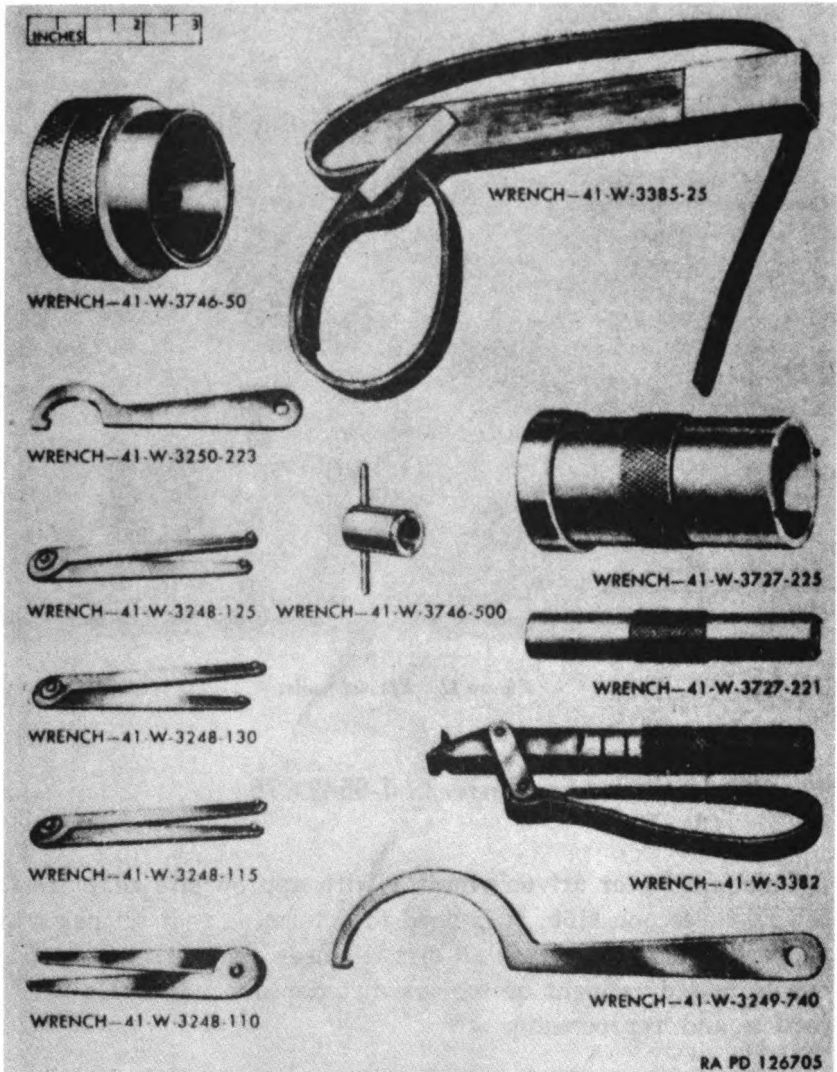

Figure 16. Special tools.

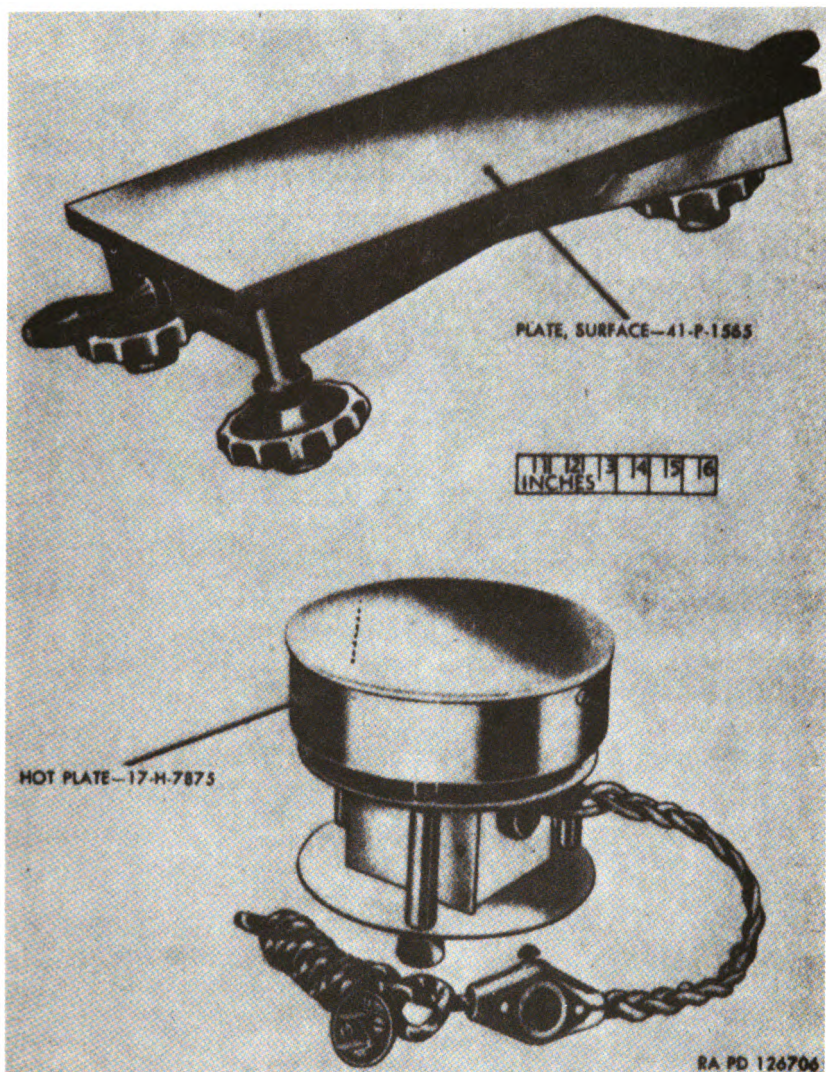

Figure 16. Special tools.

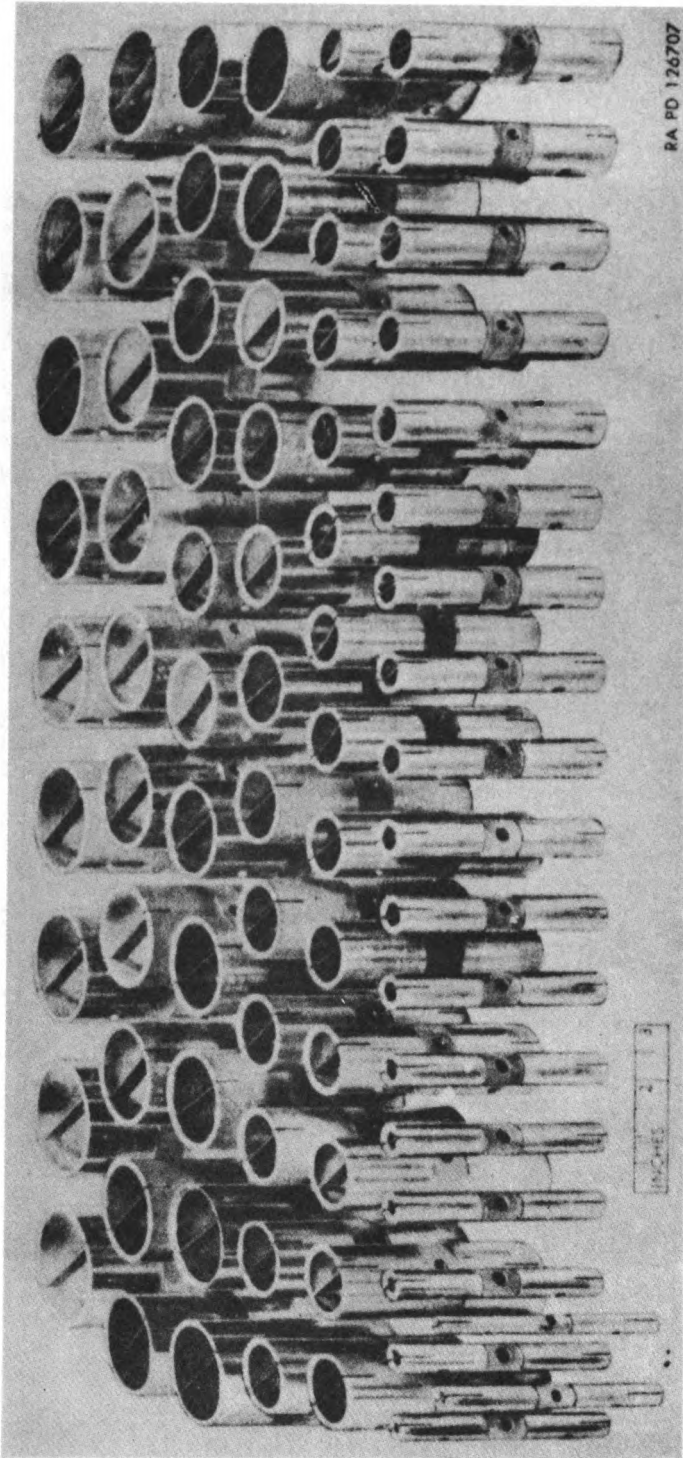

Figure 17. Wrench set 41-W-5725-860.

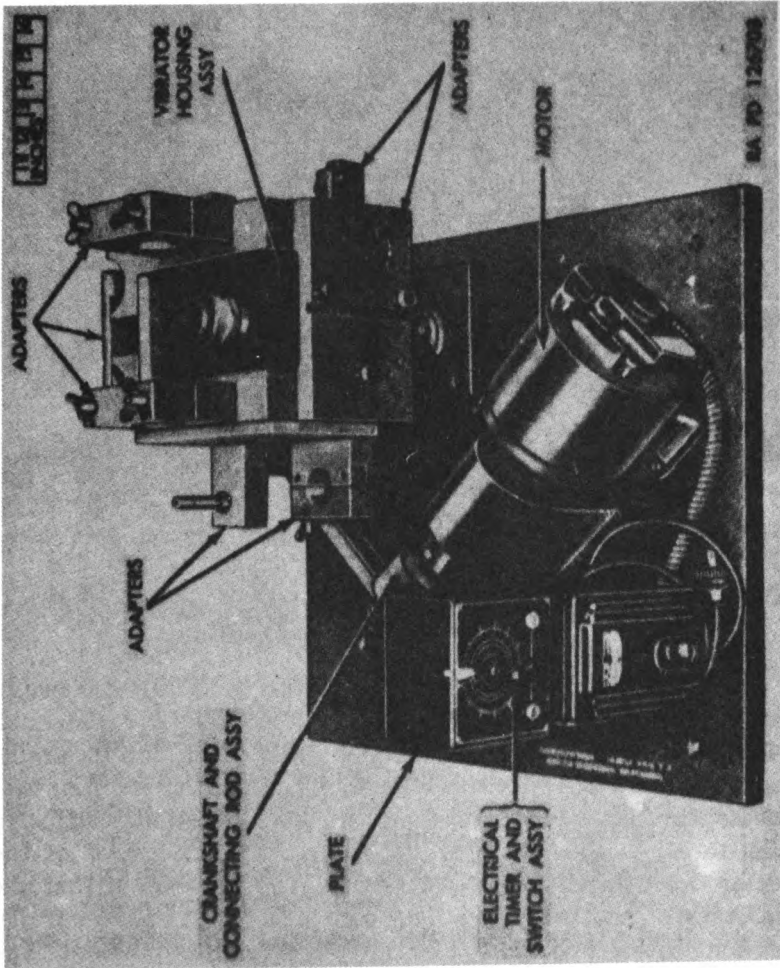

Figure 18. Universal vibration tester 17-T-6649-976.

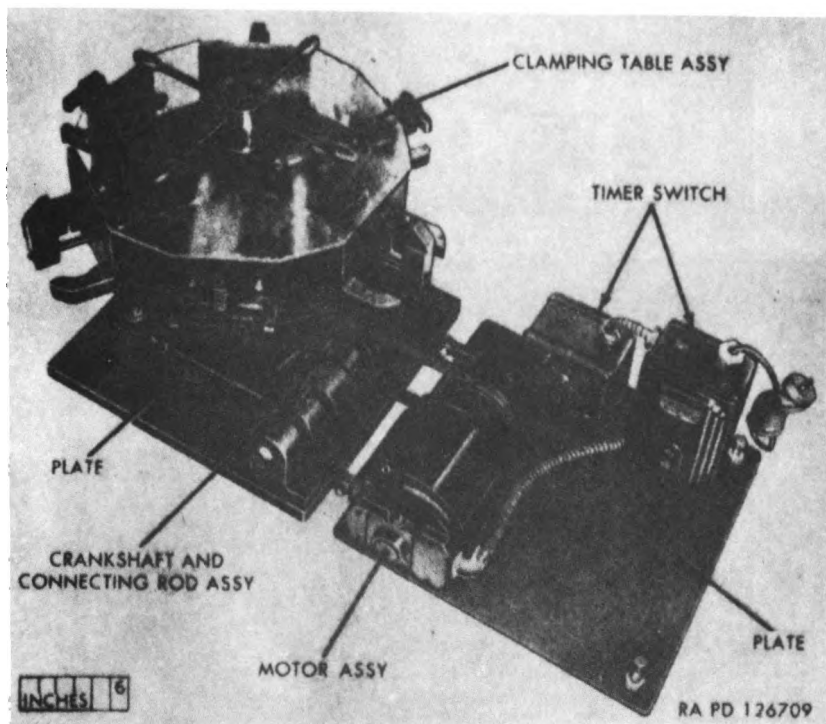

Figure 19. Binocular vibration tester 17-T-5549-925.

14. Binocular Testing Fixture 41-F-2937-457 (fig. 20)

a. The binocular fixture has been designed primarily for use in collimating the 6 x 30 and 7 x 50 binoculars covered in this manual. The fixture is constructed in such a manner, with three parallel collimating telescopes and three parallel viewing telescopes, that the two optical axes of a binocular may be conveniently adjusted parallel to each other and parallel to the hinge pin axis of the binocular. Such condition of adjustment is desirable so that the optical axes of the two binocular telescopes will remain parallel throughout their entire range of interpupillary adjustment. The binocular to be adjusted is held in the fixture so that its right telescope may be rotated freely about the hinge pin axis. The eccentric adjusting rings of the right telescope objective lens are then adjusted until the optical axis of the right telescope is parallel to the hinge pin axis. The eccentric adjusting rings of the left telescope objective lens are then adjusted until the optical axis of the left telescope is parallel to the optical axis of the right telescope. It follows that the optical axes of both the right and

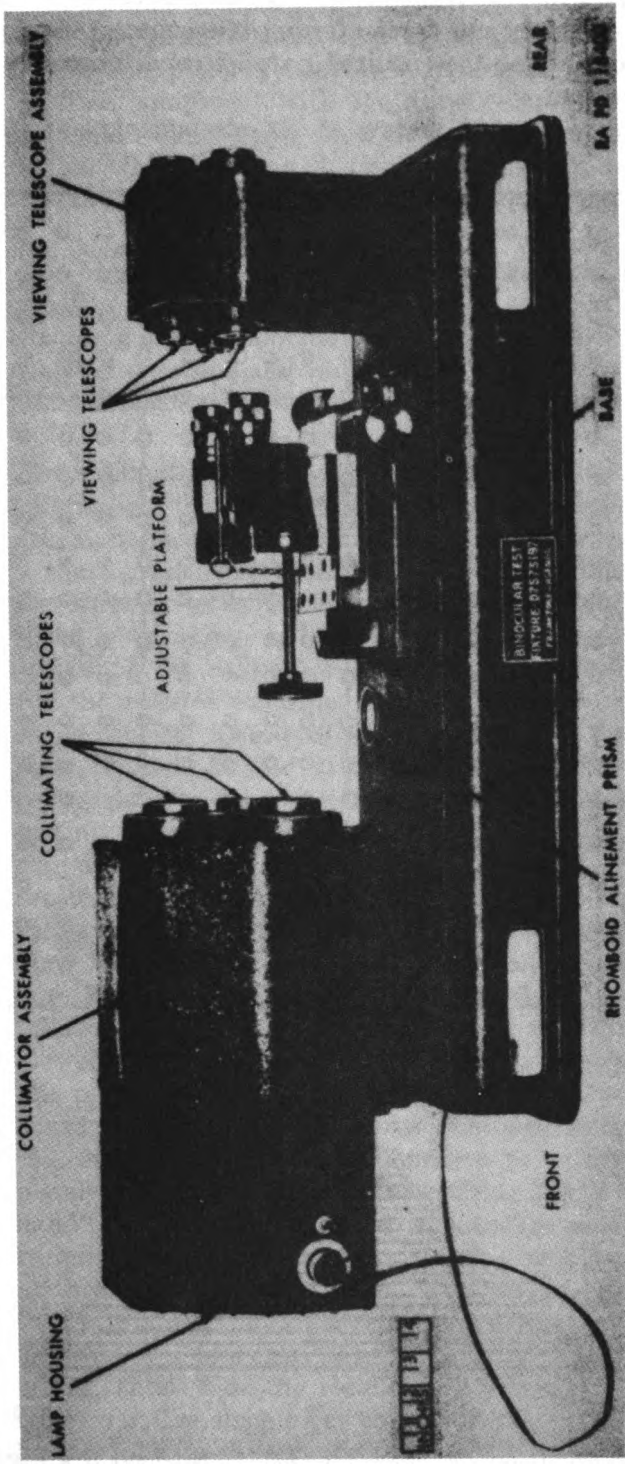
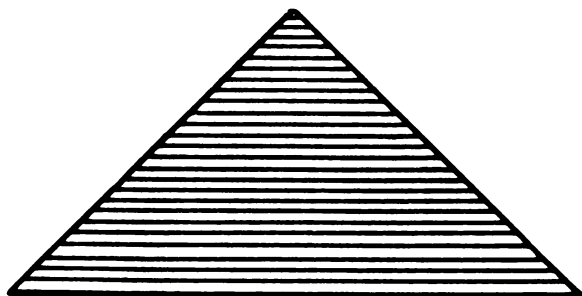
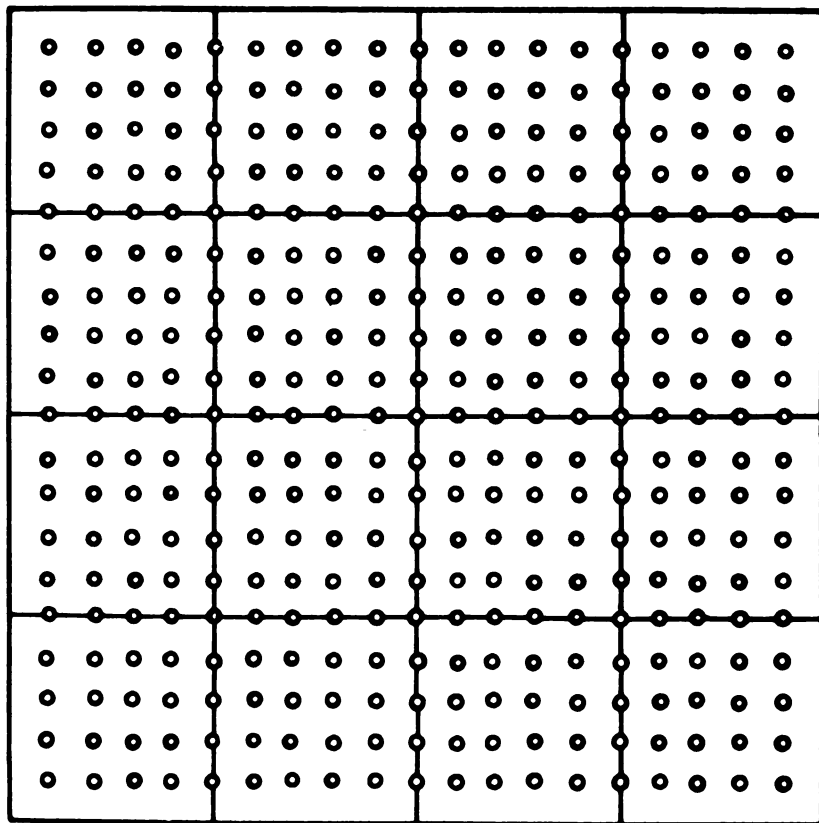

Figure 20. Binocular testing fixture 41-F-9887-487.

left telescopes will be parallel to the hinge pin axis. The three collimating telescopes and three viewing telescopes of the fixture are used to determine the required parallel conditions of a binocular as described above.

b. The fixture consists mainly of six components as follows:



RA PD 118402

Figure 21. Plotting board and ruled triangle for use with fixture 41-P-2267-457.

the base, the collimator assembly, the viewing telescope assembly, the adjustable platform, the lamp housing, and the rhomboid alignment prism. A plotting board and ruled triangle (fig. 21) are furnished as equipment with the fixture, but are not to be considered as main components since they are only used as an aid to the operator while learning to use the fixture. A detailed description of the fixture's components and equipment is given as follows:

- (1) The base is an aluminum-alloy casting machined flat on the top and bottom surfaces with suitable holes for clamping and supporting the collimator assembly, the viewing telescope assembly, and the adjustable platform. The dimensions of the base are approximately 4 x 12 x 30.
- (2) The collimator assembly consists of a housing and three collimating telescopes. The housing is fabricated from two aluminum plates with supporting cross members and a sheet brass cover. Each of the two aluminum plates has three large holes bored in it around which are fastened supporting collars. The three collimating telescopes of the collimator assembly are identical except for the reticles contained in each telescope. Each telescope consists mainly of a brass tube, and an objective lens, a reticle located at the principal focus of the objective lens and an eyepiece assembly. The three collimating telescopes are held in the housing by means of clamping shoes and socket-head setscrews. Three setscrews are used at both ends of each telescope and arranged so that the optical axes of the three telescopes may be adjusted parallel to each other. The reticles (fig. 22) for the three collimating telescopes have the following patterns: the lower left-hand telescope (as viewed from the rear of the fixture) has a simple cross line pattern. The upper telescope has a grid or checkerboard pattern of small squares over the central area of the reticle while two perpendicular center lines run completely across the field of the reticle. The lower right-hand telescope reticle has two perpendicular center lines running across the field and also has a rectangular block at the intersection of the two cross lines. The lines of the rectangular block serve as tolerance marks for collimation of a binocular. The rectangular tolerance block is not centered on the reticle with respect to the vertical center line since more collimation error is permitted horizontally in divergence than in convergence for the

rays emerging from the two binocular eyepieces (par. 30d).

- (3) The viewing telescope assembly is similar in construction to the collimating telescope assembly described above. It has the same general type of housing, clamping shoes, setscrews and telescopes. The three viewing telescopes are identical to each other and have simple cross line reticle patterns. The viewing telescopes can be adjusted so that their optical axes are parallel to each other and also parallel to the optical axes of the three collimating telescopes. The reticle in each of the three viewing telescopes is located at the principal focus of its objective lens.
- (4) The adjustable platform is a device for clamping a binocular on the fixture between the viewing telescopes and the collimating telescopes (fig. 23). It is constructed so that by means of two knurled knobs the binocular may be moved in azimuth or elevation to aline it with the optical system of the fixture. The azimuth and elevation

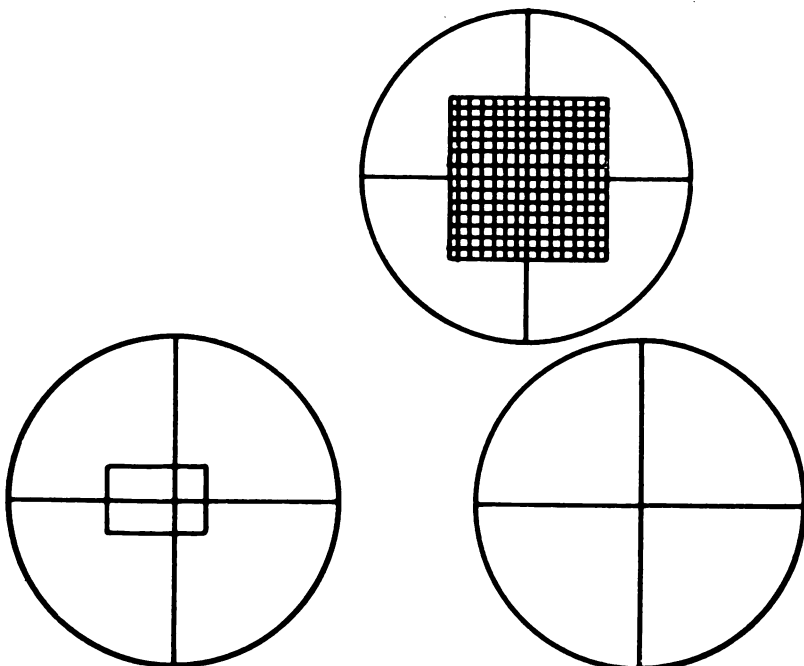

RA PD 118401

Figure 22. Reticles of fixture 41-F-2957-457 as viewed through collimating telescopes.

movements are spring loaded so as to reduce backlash to a minimum. The platform is designed so that either 6 x 30 or 7 x 50 binoculars may be clamped to it. When clamped to the adjustable platform, the binocular is held in an inverted position with the hinge axis horizontal. The clamping action takes place on the hinge lugs of the left telescope of the binocular. The clamping device is worked by means of a tapered slide which pulls down on a "hook" shaped member through which a $\frac{1}{4}$ -diameter ($\frac{9}{32}$ inch for binoculars M7 and M16) clamping rod is inserted. The rod clamps down on one side of the hinge pin lugs while the lower side of the hinge pin lugs rests on the mounting adapter of the adjustable platform. The clamping action is brought about by rotating a knurled clamping knob (fig. 23) in a clockwise direction until the binocular is firmly held on the hinge pin lugs by the vise-like action between the $\frac{1}{4}$ -inch diameter clamping rod and the mounting adapter of the adjustable platform.

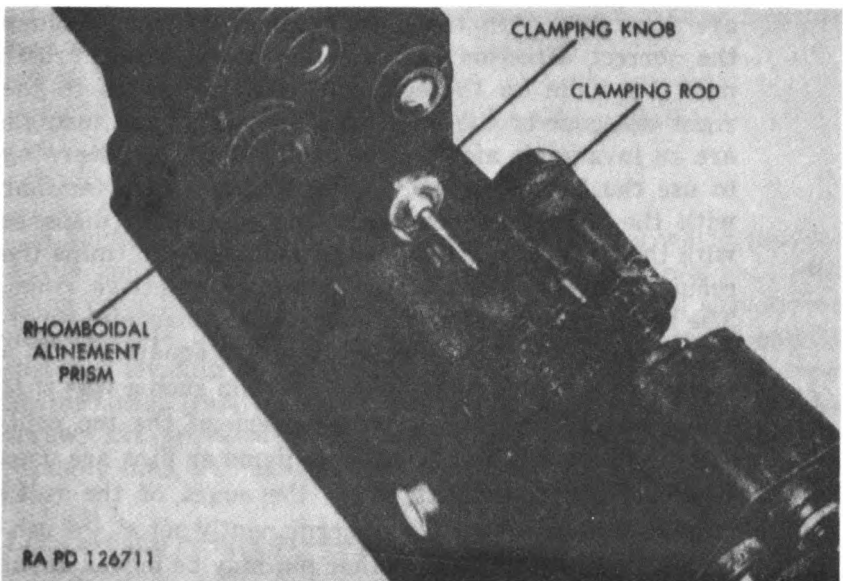

Figure 23. Binocular testing fixture 41-F-2987-457 showing method of clamping binocular.

- (5) The lamp housing is fastened to the eyepiece end of the collimator assembly. It is a fabricated housing containing a standard 60-watt lamp and a frosted glass diffusing screen. The purpose of the lamp housing is to pro-

vide illumination for the reticles in the telescopes of the collimator assembly. The lamp housing is fastened to the collimator assembly by means of two knurled clamping screws at the front end of the fixture. It has a lamp switch and extension cord for use with a 110-volt source of power.

- (6) The rhomboidal alinement prism (fig. 23) is furnished with the fixture for setting and checking the parallelism of the optical axes of the three viewing telescopes with the optical axes of the three collimating telescopes. The prism is held in a metal housing which is designed so that it may be fitted over the objective end of the collimating telescope tubes. The prism, when fitted on the objective end of a collimating telescope, provides an optical offset to complete a continuous path through the viewing and collimating telescopes. The prism is only used to set or check the fixture and is not used while a binocular is mounted on the fixture for collimation adjustment.
- (7) The plotting board and ruled triangle (fig. 21) which are furnished with the fixture, are used to determine the correct direction and amount of adjustment that must be made on the eccentric objective rings in the right telescope of the binocular. The board and triangle are an invaluable aid to an operator upon first learning to use the fixture. After becoming thoroughly familiar with the fixture, an operator may decide to dispense with the board and triangle, and mentally determine the required adjustment for the eccentric objective rings. The board is made from a piece of sheet masonite three-sixteenths of an inch thick by 10 inches square. It has a series of 1/8-inch drilled holes located in such a way that they correspond to the reticle pattern of the top collimating telescope. Two 3/16-inch diameter pins are used with the board, against which the edges of the ruled triangle are held. One pin is permanently set at the center of the board while the other pin may be moved about by inserting it in the various holes that are drilled in the board. The ruled triangle is made from a piece of sheet aluminum one-sixteenth of an inch thick and measures 5 inches along the two sides adjacent to the 90° angles. A series of reference lines are ruled off diagonally to the 90° angle and are spaced approximately three-sixteenths of an inch apart.

15. Collimating Telescope 18-T-540-250 (fig. 14)

The collimating telescope is a small, straight-tube telescope containing only an objective lens, a reticle, and an eyepiece. Since there is no erecting system, an inverted image is seen. The telescope is carefully adjusted so that its optical axis is coincident with the mechanical axis of the telescope tube. The fact that the optical axis of a collimating telescope is aligned with its mechanical axis makes it possible to establish a line of sight to a distant target which is parallel to a line determined by mechanical means. For example, if the collimating telescope is placed in an accurately machined "V" block, the "V" block is placed upon a cross-leveled surface plate, the line of sight of the collimating telescope is a level line which may be extended to a target or object at any distance. Other uses for the collimating telescope are: to establish a horizontal or vertical line by means of its own reticle in order to test instruments for tilt of field of view or tilt of reticle; to serve as a magnifier, thereby aiding the human eye in detecting small differences in distances and in degree of convergence, divergence, or parallelism of light rays; and to reduce the effect of near or farsightedness in the eye when taking measurements of focus.

16. Surface Plate 41-P-1565 and Adjustable Leveling Plate 1/8-P-22465 (figs. 14 and 16)

A surface or adjustable leveling plate is a tool which provides a true, smooth, flat surface. The plate is used as a level base, after being cross-leveled, from which many of the optical adjustments prescribed in this manual are performed. Surface plate and adjustable leveling plate prescribed for use, are made of close-grained cast iron, and are rectangular in shape. Three leveling screws are provided in the base of the plate so that it may be brought into true level.

17. Leveling Fixture 41-F-2994

a. General. Leveling fixture 41-F-2994 (fig. 24) has been designed for checking the accuracy of elevation mechanisms, angle of site mechanisms, and setting of level vials.

b. Description.

- (1) The fixture is fabricated from heavy components, mainly cast iron, to reduce vibration and maintain accurate angular settings. Two large circular scales, graduated in

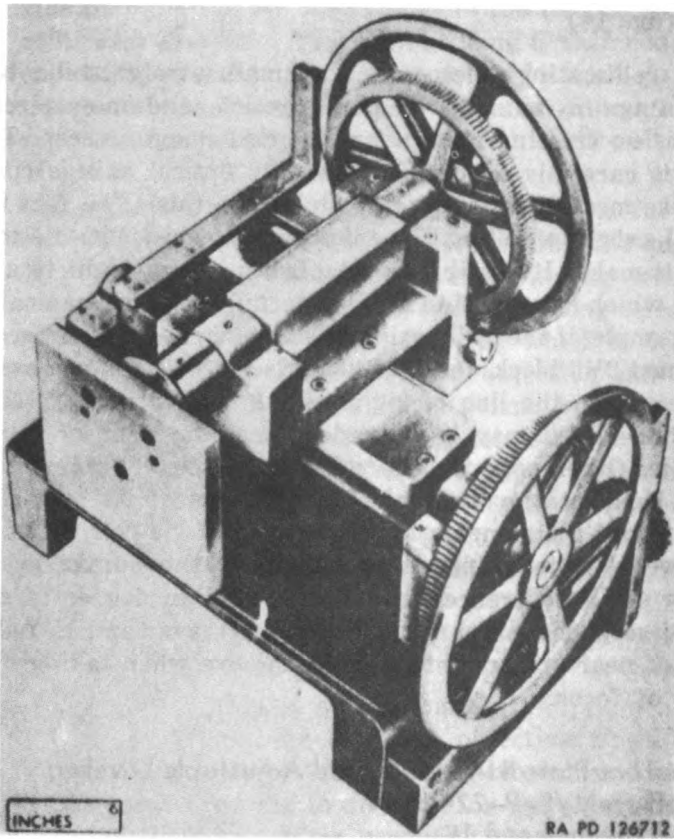

Figure 24. Leveling fixture 41-F-2994.

degrees, form part of the elevation and cross-leveling mechanisms of the fixture. The axes of these mechanisms lie in a horizontal plane and are fixed at right angles to each other. Each mechanism may be displaced independently upward or downward by means of worm and wormwheel movements actuated by the handwheel. Angular settings of either mechanism may be refined to minutes of arc by means of the vernier scales which form the indexes for the circular scales.

- (2) The fixture is modified by TB ORD 373 to provide an accurate locating point for various mounting plates and adapters, thereby facilitating the interchanging of mounting plates and adapters required for inspection of various items of fire control matériel.

c. *Adapters.* The leveling fixture 7691596, with suitable adapters (fig. 27), can be made to accommodate BC telescope M65 and

mount M48. The adapters can be machined from parts or metal stock commonly found in repair shops. With the aid of face plates or angle plates, matériel can be accurately positioned and fastened to the fixture to provide suitable mounting surfaces.

18. Azimuth Testing Fixtures 41-F-2995 and 7691596

a. General. There are two types of azimuth testing fixtures. Fixture 41-F-2995 (fig. 25) is being currently used in repair shops but will eventually be replaced with fixture 7691596 (fig. 26).

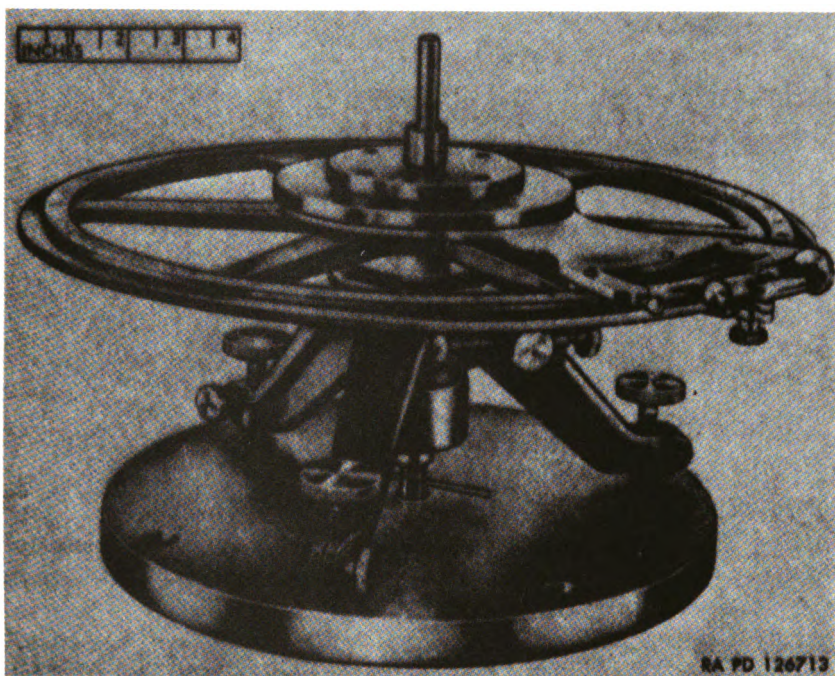

Figure 25. Azimuth testing fixture 41-F-2995.

b. Purpose. These fixtures are designed so that they can test the accuracy of the azimuth movements of the telescope mount M48. They are also used for zero setting of scales and micrometers. By using adapters similar to those shown in figure 27, telescope mount M48 may be checked.

c. Fixture 41-F-2995 (fig. 25). This fixture has a flat, heavy cast metal base and can be readily clamped to a surface plate or similar mounting surface. A three-legged support is attached to the top surface of the base by a central universal joint. The three legs also have leveling screws which bear on the top of the base.

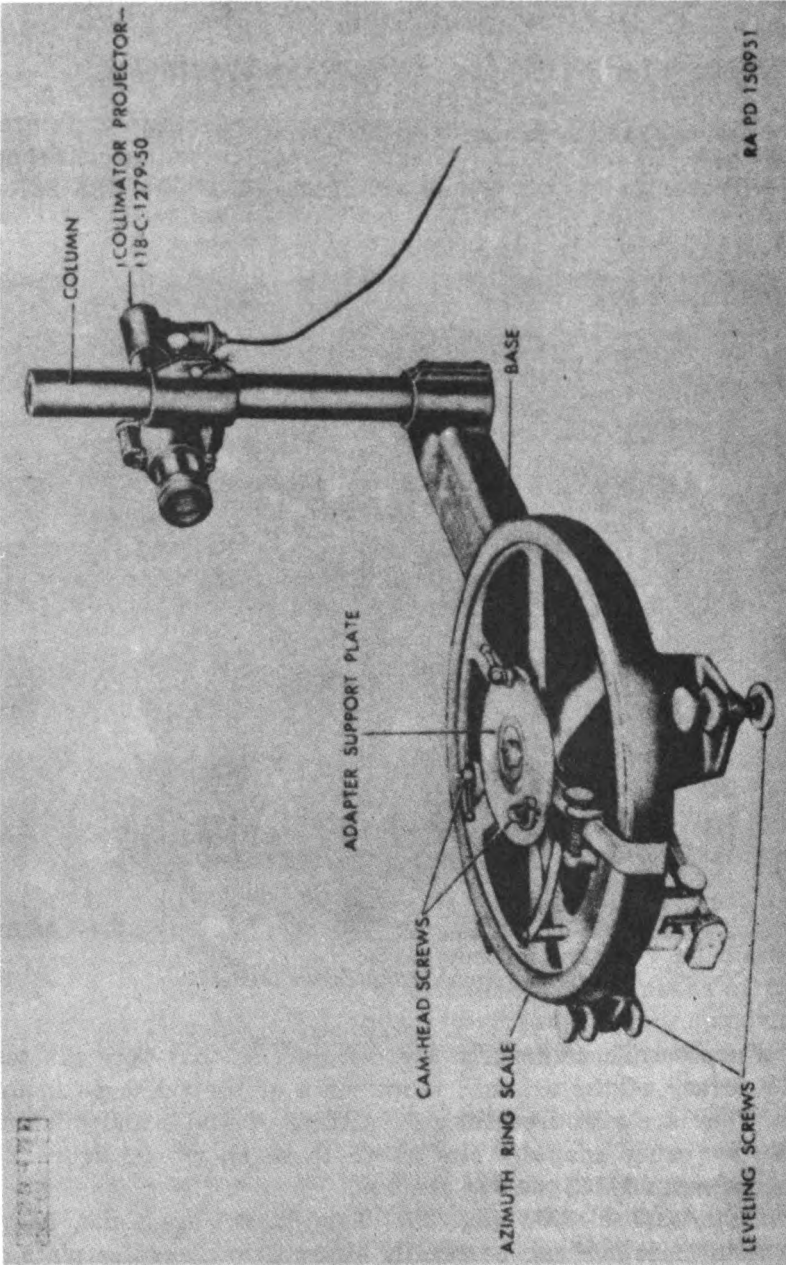

Figure 88. Azimuth testing fixture 7681686.

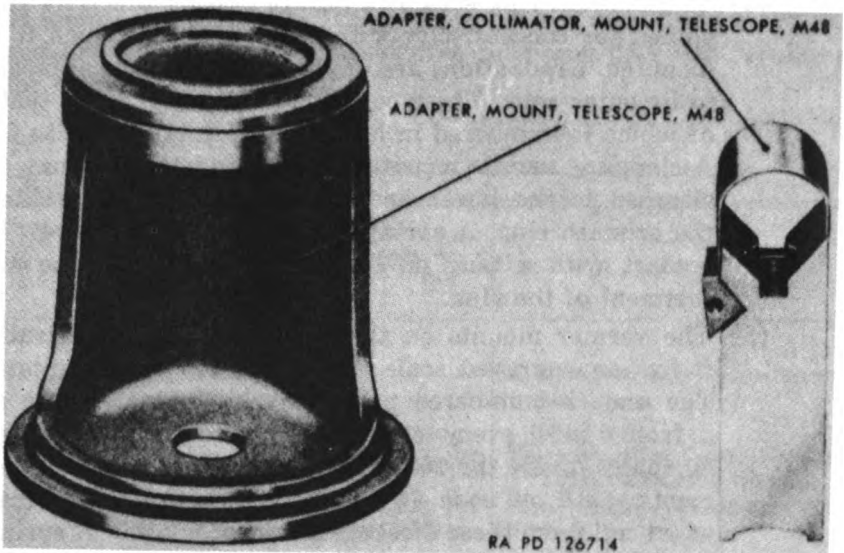

Figure 27. Adapters for azimuth testing fixture 7691596.

A circular, or wheel-like scale, graduated in degrees, is fastened horizontally over the center of the support. A central vertical spindle, which projects above the circular scale, is supported by bearing surfaces in the support. The top of the spindle is machined to accommodate the various adapters mentioned in paragraph 17c (fig. 27). A radial arm, with a vernier scale and clamping arrangement at the outer end, projects from the top section of the spindle. The arm is supported at the outer end by a bearing surface machined around the top of the circular scale. The arm can be fixed at any angular position on the scale and can be adjusted to obtain accurate angular settings by means of a screw adjustment and the vernier scale.

d. *Fixture 7691596* (fig. 26). This fixture consists mainly of seven basic components; the base, the azimuth ring, the vernier, the adapter support plate, the column, the collimator projector, and various adapters (fig. 27). The column and collimator projector are not used for inspection of the telescope mount. Thus, this fixture becomes very similar to fixture 41-F-2995 (fig. 25).

- (1) The base is an aluminum casting having three leveling screws. It contains a steel bushing which accommodates a tapered steel spindle to which the azimuth ring scale and adapter support plate are fastened. It has a cast projection for mounting the vernier scale. A split bore provides for mounting and clamping the column.

- (2) The azimuth ring scale is a bronze casting precisely machined for concentricity with the spindle on which it is mounted. Graduations are engraved on the face adjacent to its outer edge. These consist of 640 lines, every tenth of which is numbered in hundreds of mils from 0 to 63. A clamping arm is mounted under the base and may be clamped to the lower end of the spindle thus locking the azimuth ring. A spring loaded plunger and screw in contact with a tang on this arm provide for fine adjustment of the ring.
- (3) The vernier mounts on the base in a machined track. It has an engraved scale consisting of 51 graduations. The scale is numbered progressively, in increments of 2, from 0 to 10, every tenth line being so identified. These 50 spaces divide the 10-mil spaces of the ring into increments of 0.2 mil each. It is possible to estimate readings of 0.1 mil from these direct readings of 0.2 mil. A spring loaded screw provides for fine adjustment of the vernier.
- (4) The adapter support plate is fastened to the spindle of the azimuth ring. A ground locating stud allows the adapter to be mounted concentrically with the spindle and the azimuth ring. A ground surface, perpendicular to the axis of the spindle, provides the mounting surface for the adapter. Three camhead screws in the adapter plate permit easy clamping of the adapter on this surface.
- (5) The column is keyed and clamped to the base. The column, when used, mounts the collimator projector for testing other fire control instruments.
- (6) The telescope mount M48 has locating bores and surfaces which fit the adapter support plate and are held in place by three cam lock screws. The collimator adapter (fig. 27) is mounted on the spindle of the telescope mount with an attached collimating telescope to establish true verticality of the mount when it is attached to the fixture.

19. Improvised Tools

The improvised tools listed in table III and the dimensioned detail drawings furnished herein apply only to field and depot shops in order to enable these maintenance organizations to fabricate these tools locally, if desired. These tools are of chief value to maintenance organizations engaged in rebuilding a large number

of identical components. These tools are not essential for rebuild and are not available for issue; the following data are furnished for information only.

TABLE III. Improvised Tools for Field and Depot Maintenance

Item	References		Use
	Fig.	Par.	
APPLICATOR, sealing compound.	28	51	Applying sealing compound around objectives.
FIXTURE, special.	29, 59, 62, 63	65	For collimating binoculars and holding collimating telescope.
FIXTURE, special.	30, 189, 190	138, 143	For collimating BC telescope M65.
GUN, sealing compound.	31	51	Applying sealing compound around lenses.
HOLDER, lens.	32	43	Holding lenses during inspection and repair.
HOLDER, reticle or lens.	33	43	For holding reticle or lenses during inspection and repair.
HOLDER, priam.	34	46	Holding prism during inspection.
PICKUPS (vacuum).	35, 42	46	Vacuum system used in removing dust and loose dirt from optical elements and interior of instrument. (Figure 42 illustrates a similar system in use.)

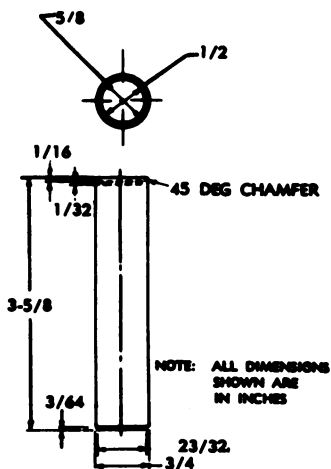

MAPLE WOOD RA PD 126715

Figure 28. Sealing compound applicator.

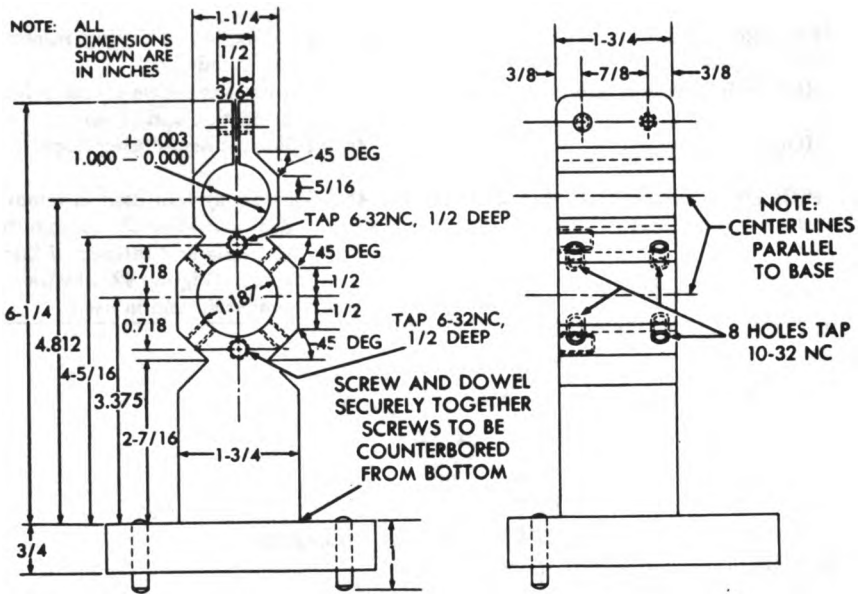
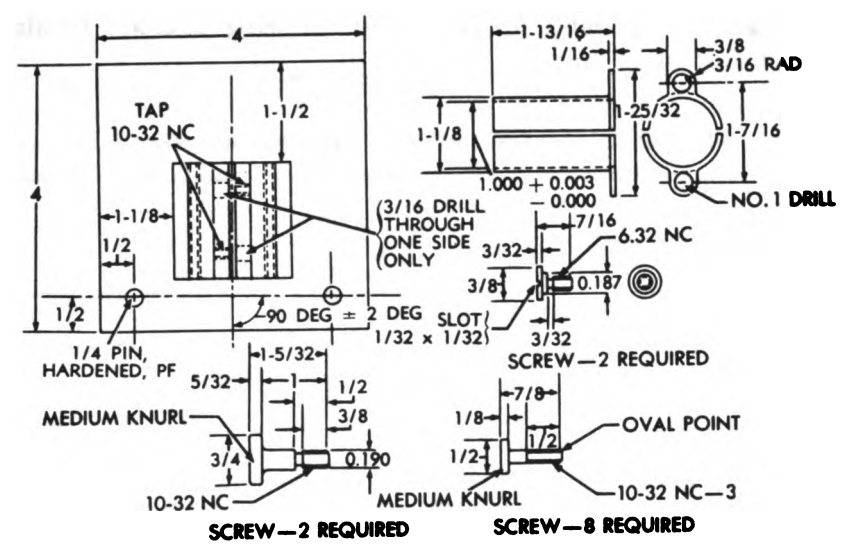

MATERIAL
 BODY: MACHINE STEEL
 PINS: HIGH CARBON STEEL HARDENED AND TEMPERED
 SCREWS: DRILL ROD
TOLERANCE ON DIMENSIONS NOT OTHERWISE SPECIFIED:
 FRACTIONAL ± 1/64
 DECIMAL ± 0.005
 RA PD - 87040

Figure 29. Special feature for collimating binoculars.

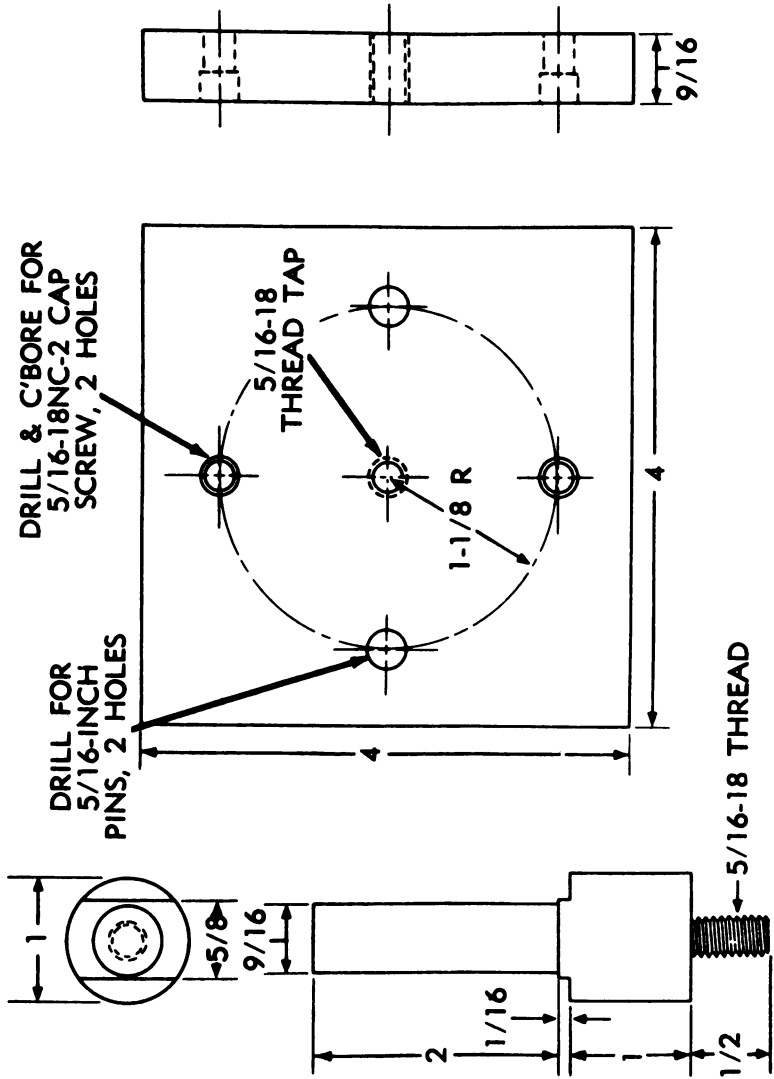

RA PD 87039A

Figure 30. Special feature for collimating BC telescope M65.

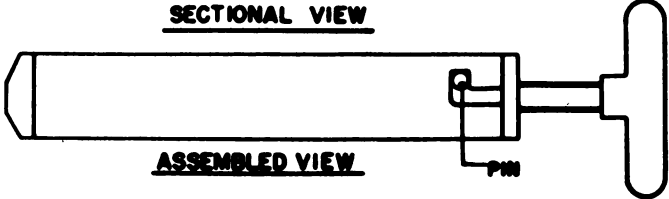
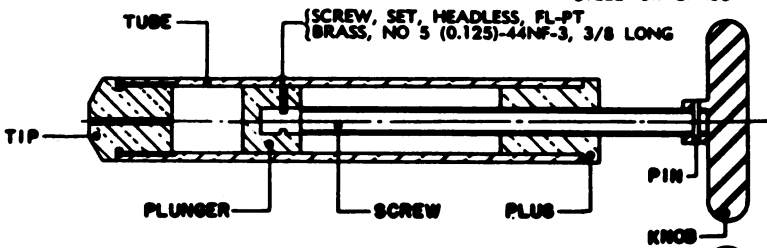
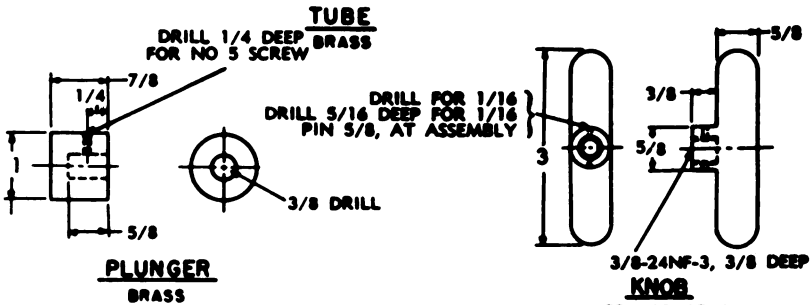
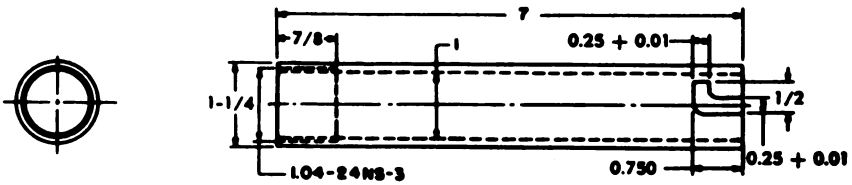
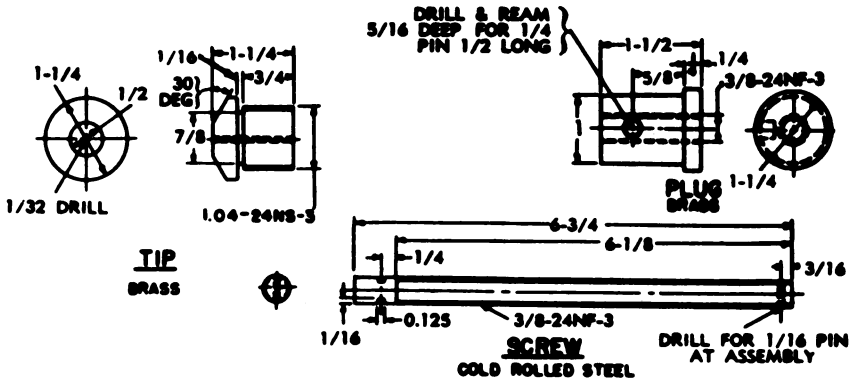

NOTE: ALL DIMENSIONS SHOWN ARE IN INCHES RA PD 126716

Figure 31. Seating compound gun.

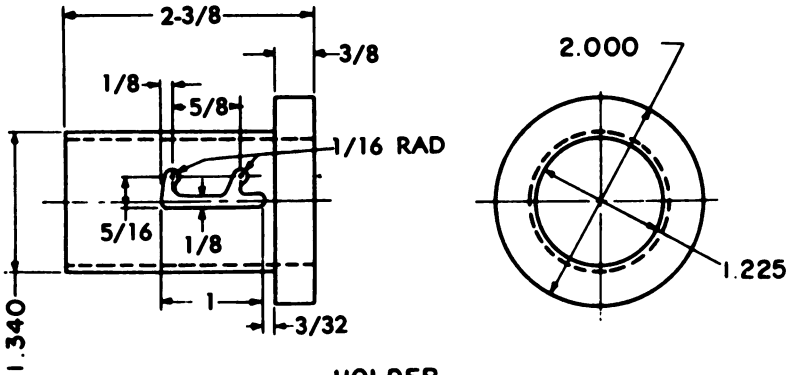

**HOLDER
BRASS**

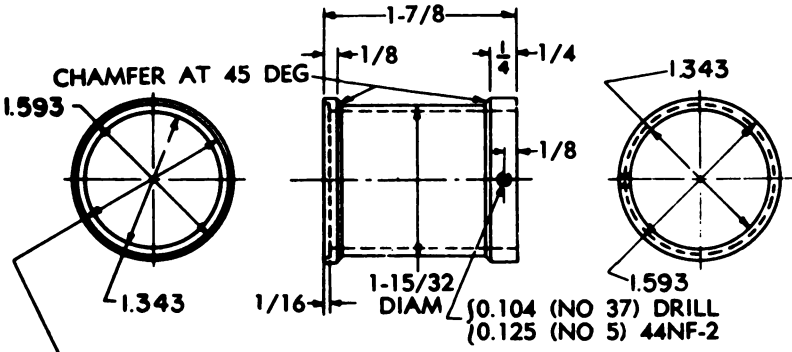

**SLEEVE
BRASS**

**NOTE: ALL DIMENSIONS
SHOWN ARE
IN INCHES**

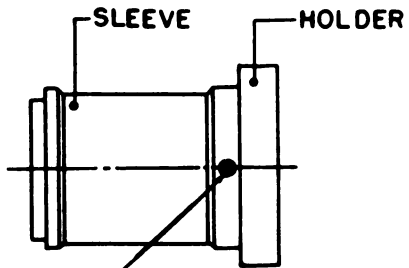

**SCREW, SET, HEADLESS
FLAT POINT 0.125 (NO 5)
44NF-2, 3/16 LONG**

RA PD 126717

Figure 32. Lens holder.

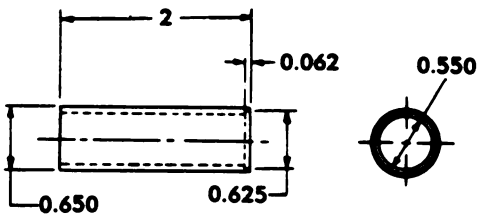

BRASS HALF HARD

**NOTE: ALL DIMENSIONS
SHOWN ARE
IN INCHES**

RA PD 126718

Figure 33. Reticle or lens holder.

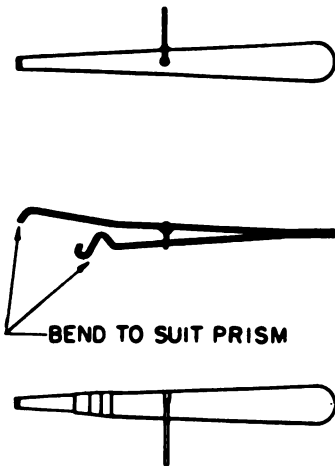

SPRING STEEL

RA PD 126719

Figure 34. Prism holder.

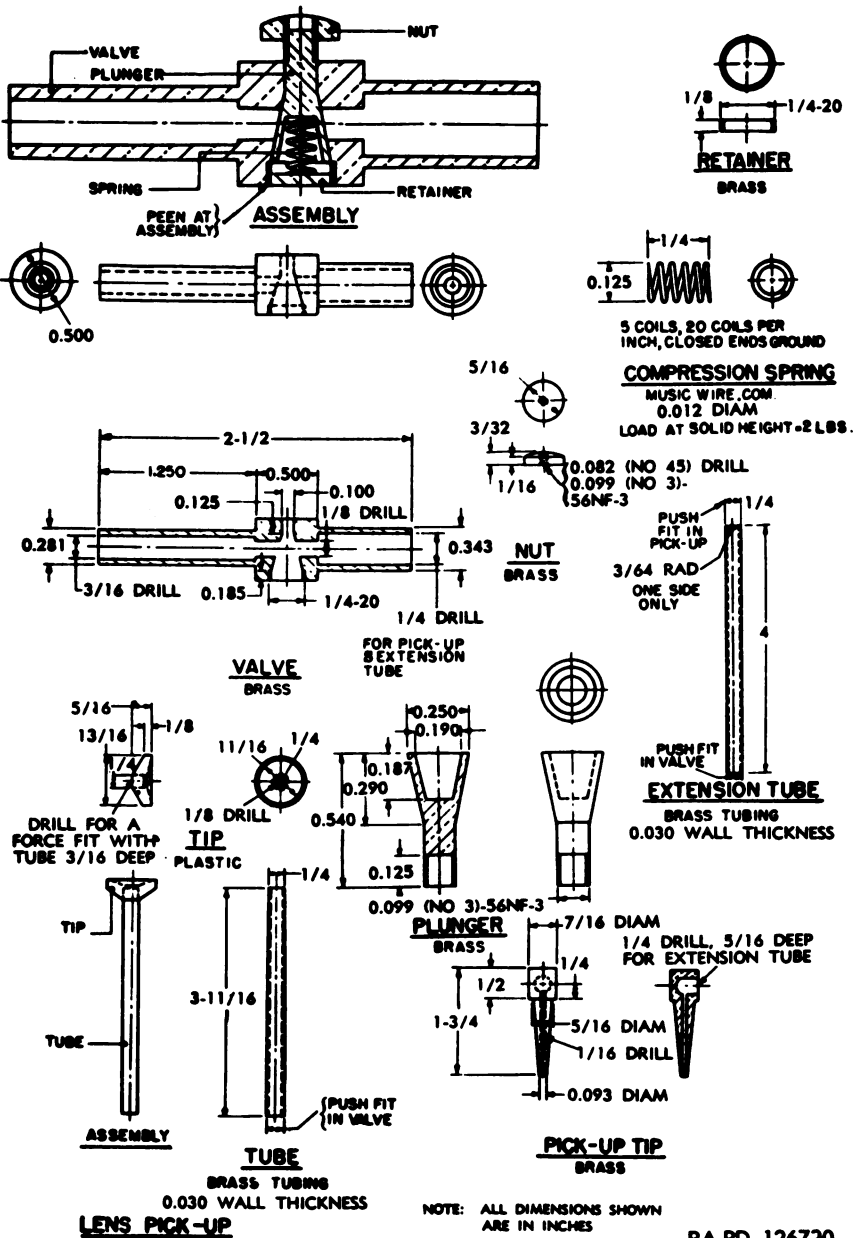

Figure 35. Pickups (vacuum system).

CHAPTER 3

INSPECTION

SECTION I. INTRODUCTION

20. General

This chapter provides specific instructions for the technical inspection by ordnance maintenance personnel of the binoculars and BC telescope either in the hands of troops or when received for repair in ordnance shops. It also defines the in-process inspection of matériel during repair or rebuild and the final inspection after repair or rebuild has been completed. Trouble shooting information is incorporated wherever applicable as a normal phase of the inspection. General inspection forms and instructions are contained in TM 9-1100.

21. Purposes of Inspections

Inspection is primarily for the purpose of —

- a. Determining the condition of an item, i.e., serviceable or un-serviceable,
- b. Recognizing conditions which would cause failure,
- c. Assuring proper application of maintenance policies at prescribed levels, and
- d. Determining the ability of a unit to accomplish its maintenance and supply missions.

22. Categories of Technical Inspections

In general, there are five categories of inspection performed by ordnance maintenance personnel:

- a. *Over-all Inspection.* This is a periodic over-all inspection performed on *all* matériel in the hands of troops or on matériel received for repair in field or depot maintenance shops. Upon completion of an inspection for serviceability, matériel will be declared either serviceable or unserviceable. This inspection may be limited in scope, such as an inspection in the hands of troops, or

detailed in scope, such as an ordnance shop inspection. Detailed procedures are presented in paragraphs 24 through 28.

b. Pre-embarkation Inspection. This inspection is conducted on materiel in the hands of troops alerted for oversea duty to insure that such matériel will not become unserviceable or worn out in a relatively short time. It prescribes a higher percentage of remaining usable life in serviceable matériel to meet a specific need beyond minimum serviceability.

c. In-process Inspection. These are inspections performed by the repair technician and/or floor inspector in the process of repairing or rebuilding the matériel and its components. This is to insure that all parts conform to prescribed standards, that the workmanship is in accordance with approved methods and procedures, and that deficiencies not disclosed by the technical inspection are found and corrected. Detailed instructions are contained in the rebuilt chapters, 5 through 11.

d. Final Inspection. This is an acceptance inspection performed by a final inspector, after repair or rebuild has been completed, to insure that the matériel is acceptable according to established standards.

e. Spot Check Inspection. This is a periodic overall inspection performed on only a percentage of the matériel in each unit to determine the adequacy and effectiveness of organizational and field maintenance.

23. Classification of Matériel

All ordnance matériel after inspection is classified as follows:

a. Serviceable. Serviceable property consists of all new or used supplies which are in condition for issue for the purpose intended and all supplies which can be placed in such condition through pre-issue tests or inspections, in-storage deprocessing, installation of accessories, correction of minor deficiencies which have developed since the item was last classified as serviceable, application of modification work orders for which parts are available, or assembly of available components.

b. Unserviceable. Unserviceable property consists of all supplies which are not serviceable. The definition of unserviceable property is further broken down into the following subclassification: property which is unserviceable but economically repairable, property which is unserviceable and not economically repairable.

Section II. INSPECTION OF BINOCULARS AND BC TELESCOPE IN THE HANDS OF TROOPS

24. General

This section provides specific instructions for the technical inspection by ordnance maintenance personnel of the binoculars and BC telescope in the hands of troops. Also, this section amplifies the general instructions contained in TM 9-1100 so far as the instructions pertain to inspection of the matériel. Personnel making these inspections will acquaint themselves with the malfunctions indicated in paragraph 36 which are the most common deficiencies of the binoculars and BC telescope. In general, if the instrument is complete and performs its intended function properly, if all modification work orders classified as urgent have been completed, and if all defects as disclosed by the inspection have been corrected, the matériel may be considered serviceable.

25. Inspection of Mechanical Components of Binoculars

a. Applicability. Unless otherwise noted, the inspection procedures and serviceability standards of this paragraph apply to all the binoculars covered in this manual.

b. Preliminary.

- (1) Record the serial number of the instrument and other pertinent information as prescribed by inspection forms. Refer to paragraph 3 and TM 9-1100.
- (2) Check to see that the materiel has been cleaned of all corrosion preventive compound, grease, excessive oil, dirt or foreign matter which might interfere with its proper functioning or obscure the true condition of parts.

c. Completeness. Check to see that all component parts of the binocular and equipment are present. See that all screws are in place and properly sealed. Check the spare parts and equipment for completeness. Note all missing parts or equipment. Refer to ORD 7 SNL F-210 or ORD 7 SNL F-238 to determine required equipment.

d. Appearance. The appearance of the binocular will indicate its general condition and will reflect the type of treatment it has received. Examine the external surfaces of the instrument for dents, cracks, scratches, corrosion, loose paint, or any other evidence of damage or misuse which might indicate the need for repair. See that the vinylite body covering is not damaged.

e. Functioning of Mechanical Components. Mechanical components must operate smoothly without binding or rough motion.

Parts must be free from grit and must be properly lubricated. Check each eyepiece focusing movement to make sure that it turns smoothly under a moderate pressure and will maintain its setting with normal handling. Check the movement of the hinge. The hinge should maintain any interpupillary setting for all handling; but should not be tight enough to cause binding.

f. Sealing. See that the sealing of the binocular is in good condition and is not deteriorated so as to cause apparent leaks or openings.

g. Modification Work Orders. Modification of the binoculars to accommodate filter M1 is authorized by MWO ORD F210-W1 (binoculars M3, M8, M9, M13, and M13A1) and MWO ORD F238-W1 (binoculars M7, M15, M16, and M17). Modification of binoculars M3 and M8, to prevent accidental rotation of objective assembly during collimation adjustment, is authorized by MWO ORD F210-W2. (These modifications will not be performed unless the binoculars are in a repair shop. Refer to par. 6c.)

h. Name Plate Data, Scales, and Indexes. Inspect scale numbers, divisions and indexes, and the name plate data engraved on the body cover to see that they are clearly defined and easily read.

i. Paint and Finish. Inspect for bare spots or damaged finish which may expose base metal surfaces and lead to corrosion. Determine whether a touch-up paint job or a complete refinishing is necessary to restore the finish to good condition. The condition of the paint may indicate how long the instrument has been in service without maintenance (TM 9-2851).

j. Lubrication. Proper lubrication of the binocular is indicated by smoothness of hinge and eyepiece movement. Lubricate the eyepieces and hinge movements with aircraft and instruments grease at the time of rebuild.

k. Cracks. Plates and castings should be inspected for cracks and breaks.

l. Spare Parts and Equipment. Check all spare parts and equipment against the applicable ORD 7 SNL F-210 or ORD 7 SNL F-238 for completeness of matériel and equipment. Check the carrying case for general appearance. Make sure that straps and snaps are in a serviceable condition. Check the seams to see that the stitching is not broken. Check the condition of the leather or plastic. Leather or plastic should be clean and without cracks or checks. Check to see that the filters of filter M1 are in good condition and not broken or otherwise damaged. See that the filter adjusting lever works properly and that the metal parts of the filter are not broken or otherwise damaged. Filter M1 should

be found in the bottom of carrying case M17 (fig. 36). Inspect to see that the binocular eyepieces have been turned to their extreme clockwise position in the case. This will prevent the eyeguards of the binocular from striking the filter. This inspection does not apply to carrying case M62 or M62A1 since there is ample room for the storing of the binocular with the filter attached.

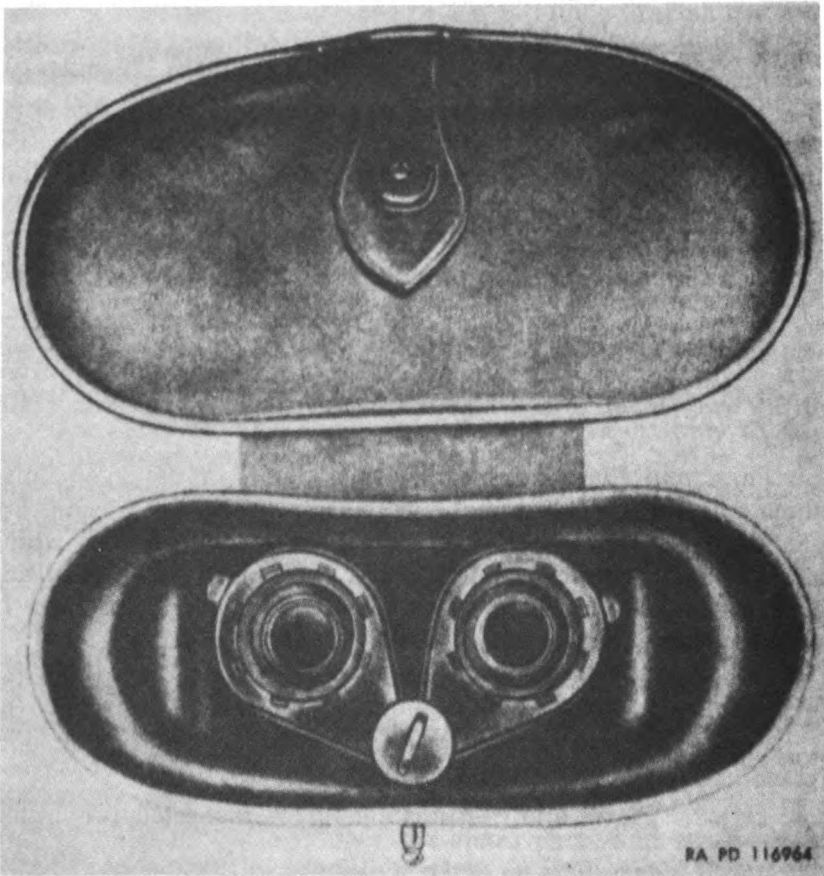

Figure 36. Position of filter M1 in carrying case M17.

26. Inspection of Optical Components of Binoculars

a. Condition of Optical Elements.

- (1) Lenses, prisms, and reticles must be free from such smears, scratches, pits, dirt, condensate, fungus growth, fractures, chips, and cement separations as will interfere with cleaning of their surfaces or which affect optical performance of the instrument.

- (2) *Note.* Binoculars will not be rejected for defects which can only be detected by the shading or shadowing technique. When inspecting through the eyepiece end of the binocular, rejection is to be based only on those defects which are apparent when the instrument is used in a manner simulating field conditions.

“Shadowing” is the technique of looking into the eyepiece or objective end of the instrument obliquely so as to obtain reflections from a particular surface in the optical system. With this method, the surfaces of lenses and reticles are dark grey in appearance, and all defects (condensate, scratches, etc) show up as white particles.

- (3) The sealing should not be so deteriorated as to cause apparent leaks or opening.

b. Adjustment of Optical Elements. Performance of the binocular must be such that image and reticle are properly defined and there is no evidence of parallax, double vision, or aberration. Refer to TM 9-2601. Perform the checks described in *c* through *i* below and see that the binocular is within the tolerances specified.

c. Definition of Field of View. Distant objects (beyond 200 yards) should appear sharp and clear.

d. Parallax. Place the instrument on a solid surface, and observe a distant target (beyond 200 yards) through the binocular. Move the head, and watch for movement of a point nearest the center of the reticle with respect to the distant target in the field of view. Any apparent movement is parallax. There must be no movement.

e. Tilt in Field of View. Pronounced cases of tilt can be detected by looking through the *objective* end of each telescope separately, observing a straight line. Hold the instrument about a foot from the eyes and look through and around the telescope simultaneously. The part of the line visible in the field of view of the telescope should not be tilted in relation to the actual line.

f. Tilt of Reticle. Set the interpupillary scale at 63-mm, and place the binoculars on a level surface. Sight on a line known to be vertical. The vertical line of the reticle should be approximately parallel to the vertical line.

g. Double Vision.

- (1) To check for double vision, place instrument on a solid surface. Adjust both eyepieces for use by one eye. Sight through one telescope to locate a sharply defined object at the edge of the field of view. Use the same eye and repeat this operation on the other telescope. If the object is not in the same relative position in both fields of view, double vision exists and the instrument requires collimation.

- (2) As an alternate check, hold the instrument in the hands, and focus both telescopes on a distant object. Close either eye for a minute or so. Then open the eye quickly. If any double vision exists, it can be detected at once. The target will appear to blur apart and then together again quickly, as the eye corrects for the defect. To use this method, observation should be confined to a sharply outlined target such as a telephone pole or a smoke-stack.

h. Interpupillary Scale Setting. Set the interpupillary scale at 64 mm. The distance between corresponding points of the eyepiece should be 2.52 inches to within plus or minus 0.039 inch (1 mm). The interpupillary distance and scale setting of a binocular may be roughly checked by setting the scale to the inspector's own interpupillary distance and observing through the instrument. Errors in interpupillary distance will cause a feeling of eyestrain, and the edges of the field of view may appear as two overlapping circles instead of a single circle. The accurate inspection is made by actual measurement. An ordinary millimeter scale will suffice to perform this measurement.

i. Stagger. With the same diopter setting on both eyepieces, as determined by the use of an auxiliary telescope, check that one eyepiece does not extend beyond the other by more than one-sixteenth of an inch.

27. Inspection of Mechanical Components of BC Telescope M65

a. Preliminary.

- (1) Record the serial number of the instrument and other pertinent information as prescribed by inspection forms. Refer to paragraph 3 and TM 9-1100.
- (2) Check to see that the matériel has been cleaned of all corrosion preventive compound, grease, excessive oil, dirt, or foreign matter which might interfere with its proper functioning or obscure the true coordination of parts.

b. Completeness. Check to see that all component parts of the telescope and equipment are present. See that all screws are in place and properly sealed. Note all missing parts or equipment. Refer to ORD 7 SNL F-259 to determine required accessories.

c. Appearance. The appearance of the telescope and equipment will indicate their general condition and will reflect the type of treatment received. Examine external surfaces of the telescope for dents, cracks, scratches, corrosion, loose paint, or any other

evidence of damage or misuse which might indicate the need for repair. Extend the same inspection to the equipment (fig. 7) (tripods M10 and M17 (fig. 170), adapter M14, telescope mount M48 (fig. 170), instrument light M28 (fig. 183), and the cases (fig. 185)). In particular, see that the legs of tripod M17 (figs. 178 and 179) are free from warpage and damage.

d. Functioning of Mechanical Components. Mechanical components must operate smoothly without binding or rough motion. Parts must be free from grit and must be properly lubricated. The checks described in *a* through *c* above and *e* through *i* below are to be performed on the equipment and BC telescope.

e. Telescope Mount M48 (figs. 6 and 171).

- (1) See that the upper vertical spindle of the mount is free from burrs or other defects that will prevent the telescope from seating properly.
- (2) See that the circular level vial is free from cracks and is tight in its holder. The bubble must be smaller than the index. With the telescope mounting spindle in a true vertical position and the bubble in the center of the index, release the orienting screw and rotate the instrument through a complete circle. The bubble must stay within the index at all points of the circle.
- (3) Operate the azimuth and orienting movements throughout their ranges. The movements must function without undue irregularities, friction, or looseness. The azimuth throwout mechanism must operate so as to return the worm into mesh immediately upon releasing.
- (4) The lower vertical spindle, mount leveling and clamping mechanism should be free from burrs or other defects that will prevent the mount from being clamped in any position desired when the telescope is attached to its mount.
- (5) With the BC telescope mounted, set the azimuth scale and micrometer on mount M48 at zero. Superimpose the center of the reticle on a target by rotating the orienting knob (fig. 10). Rotate the azimuth knob 800 mils in one direction and return the reticle to the reference point. Be careful not to overpass. Note the reading on the micrometer. Rotate the azimuth knob 800 mils in the opposite direction and return to the target, again noting the reading on the micrometer scale. The sum of the differences between the two readings and the initial reading is the total amount of backlash in the first quadrant. Check the other three quadrants in the same manner. The backlash in the azimuth mechanism

must not exceed 1.0 mil in any quadrant. While rotating the azimuth knob, check for smooth movement or drag.

- (6) Superimpose the center of the reticle on a vertical reference line more than 300 yards distant. Looking through the telescope, move the elevating knob (fig. 11) slightly and notice if the center of the reticle appears to move away from the reference line. If it does not move immediately, backlash is present. The backlash in the orienting mechanism must not exceed 1.0 mil.

f. Tripod M17 (fig. 6).

- (1) See that the tripod head is not damaged in any way that would prevent the telescope mount from being securely fastened to the tripod.
- (2) Operate the tripod leg hinge assemblies; they must hold the tripod legs in any position desired when clamped.
- (3) See that the tripod leg assemblies have a smooth movement and will hold their positions when clamped in any extended position.
- (4) The tripod shoe assemblies must be firmly fastened to the lower legs.
- (5) Inspect the strap assembly for mold, breaks, tears, loose stitching, or defective buckles.

g. Tripod M10 and Adapter M14. The metal components of the tripod and the adapter must not be damaged in any way that would prevent the proper mounting of the telescope mount.

h. BC Telescope M65.

- (1) *Locating bushing* (fig. 11). The bushing should be free from any defects that would interfere with the proper seating of the telescope. Place the telescope on the mount. The bushing must mate securely with the upper vertical spindle and must be securely fastened to the elevating worm gear.
- (2) *Backlash in angle of site mechanism* (fig. 10). The mechanism should function without undue irregularities, friction or looseness. Move the angle of site micrometer to determine if the movement is free from bind and chatter. Set the angle of site scale at "3" and the micrometer at "0." Center the bubble by rotating the elevating knob. Rotate the angle of site micrometer until the scale reads zero, and bring it back until the bubble is again centered. Do not overpass the point of level. Note the micrometer reading. Rotate the micrometer until the scale reads "6" and return to level point. Again note micrometer reading. The sum of the differ-

ences between the two readings is the total amount of backlash. The backlash must not exceed 1 mil.

- (3) *Backlash in elevation.* Superimpose the center of the reticle on a horizontal reference line over 300 yards distant. Looking through the telescope, move the elevation knob slightly and notice if the center of the reticle appears to move away from the reference line. If it does not move immediately, backlash is present.
- (4) *Extent of elevating movement.* See that the elevating mechanism has approximately a 700-mil movement (18° above to 18° below the horizontal line of sight) (fig. 11). Level the mount. Place the angle of site scale at zero and the micrometer at zero. See if the bubble can be centered by rotating the elevating knob. Repeat this procedure with the angle of site scale at "6" and the micrometer at "0."
- (5) *Smoothness of focusing movement.* Rotate each eyepiece to the limit of movement in both directions and notice whether there is any drag or binding.
- (6) *Interpupillary scale setting* (figs. 10 and 11). Rotate the interpupillary scale knob and see that the mechanism has full 12-mm movement. Set the scale at 64 mm. The distance between corresponding parts of the eyepieces should be 2.52 inches.

i. Instrument Light M28. Check to see that light is held securely on the right telescope and positioned so that the reticle window is illuminated. Carefully check the insulation on the wiring for bare spots and deterioration. Place a battery in the battery case and both bulbs in the sockets. See that bulbs light. Check spare batteries and bulbs for serviceability.

j. Sealing. Inspect the reticle light window and the sealed and painted portions of the instrument to determine whether sealing is complete.

k. Modification Work Orders. All pertinent modification work orders must have been applied.

l. Name Plates, Scales, and Indexes. Inspect scale numbers, divisions and indexes, and lettering on name plates, to see that they are clearly defined and easily read.

m. Paint and Finish. Inspect for bare spots or damaged finish which may expose base metal surfaces and lead to corrosion. Determine whether a touch-up paint job or a complete refinishing is necessary to restore the finish to good condition. Refer to TM 9-2851.

n. Lubrication. Bearings, sliding surfaces, hinge joints, and

other movable parts will be clean, properly lubricated, and free from rust and other foreign matter.

o. Cracks. Plates and castings should be inspected for cracks and breaks.

p. Spare Parts and Equipment. Check all spare parts and equipment against ORD 7 SNL F-259 for completeness of matériel and equipment.

28. Inspection of Optical Components of BC Telescope M65

a. Condition of Optical Elements. Refer to paragraph 26a which is also applicable to the BC telescope.

b. Adjustment of Optical Elements. Performance of the instrument must be such that image and reticle are properly defined and there is no evidence of parallax, double vision, or aberration. Perform the checks described in *c* through *i* below and see that the performance of the telescope is within the tolerances specified.

c. General Inspection. Check all optical elements for dirt, moisture, chips, scratches, and cement separations. Looking through the objective end of the instrument, it is possible to inspect all the elements up to the reticle. Looking through the eyepiece end, inspect all elements up to and including the reticle. Optical elements which are chipped or damaged so as to interfere with the normal use of the instrument will render it unserviceable.

d. Parallax. With the naked eye, observe the reticle through the right telescope. Rotate the diopter scale until clearest definition of the reticle is obtained. Orient the instrument on a sharply defined object 700 to 800 yards distant. Move the eye about one-quarter inch from side to side and up and down. If there is any apparent movement between the center of the reticle and the target, parallax exists.

e. Double Vision. Double vision occurs when the optical axes of the two telescopes are not parallel. Refer to paragraph 26g.

f. Tilt of Reticle. Orient the instrument on a plumb reference line at least 300 yards distant. Set the interpupillary distance at 60 mm. Look through the right telescope and note whether or not the vertical reticle line aligns with the plumb reference line within 16 minutes of arc.

g. Tilt of Field of View. For field inspection purposes, a check may be made by looking through the objective end of the instrument and sighting on a long straight vertical line. An image of the line is seen in the entrance pupil and the line itself is seen extending above the instrument. That part of the line visible in

the field of view of the telescope should not be tilted in relation to its extension above the instrument.

h. Horizontal Travel.

- (1) *Wave type.* Superimpose the center of the reticle on a reference point. Release the free orienting screw and the azimuth throw-out lever. Holding the telescope on the target, rotate the orienting housing below the azimuth housing. The center of the reticle should remain on the reference point. If the reticle rises or falls by more than 1.5 mils, it indicates incorrect horizontal travel of the wave type (table V).
- (2) *Jump type.* Superimpose the center of the reticle on a horizontal reference line. Rotate the azimuth knob (fig. 10) and observe whether the center of the reticle jumps away from the reference line. Reorient the instrument and continue the test until the entire 6,400-mil rotation is checked. If the reticle leaves the reference line by more than 0.5 mil at any point in the circle, it indicates incorrect horizontal travel of the jump type (table V).

i. Vertical Travel. Aline the reticle on a plumb target. Rotate the elevating knob (fig. 11), noting whether the center of the reticle travels along the true plumb line. The deviation should not be more than 1 mil when the instrument is rotated through an angle approximately 18° below to 18° above the horizontal line of sight (table V).

Section III. ORDNANCE SHOP INSPECTION

29. General

Technical inspection performed by the ordnance repair shop upon receipt of materiel turned in for repair, determines the extent of repairs required, and provides the basis for requisitioning the parts, assemblies, or supplies necessary to accomplish the repairs. Often this inspection in the shop may be the same as that performed by inspectors in the field or will disclose additional necessary repairs not indicated by the using organization. Perform the applicable inspections given in paragraphs 25 and 26 in addition to the procedures in this section.

30. Inspection of Binoculars

a. Vibration Test. Clamp the binocular in the binocular vibration tester 17-T-5549-925 (fig. 37) and vibrate for 15 seconds before performing the following inspection operations.

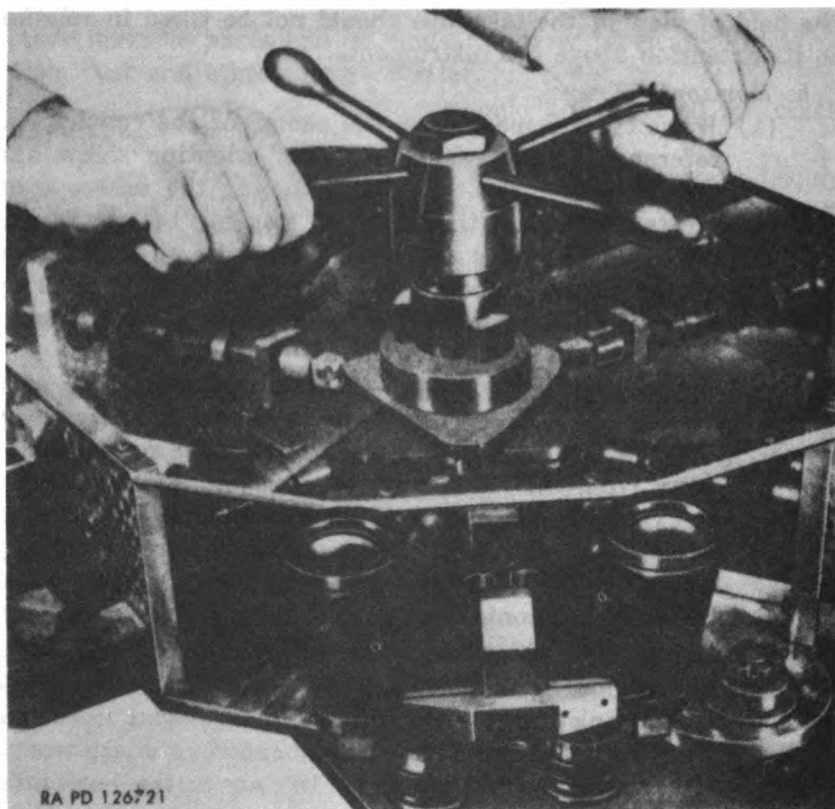

Figure 37. Binocular mounted on binocular vibration tester 17-T-5649-926.

b. Condition of Optical Elements. When looking through the eyepiece and objective ends of the binoculars, there should not be seen any objectionable dirt, smears, scratches, digs, condensate, fungus growth, chips, fractures, or cement separations. Use the shading or shadowing technique (par. 26a) to detect those optical elements requiring replacement.

c. Definition of Field of View and Proper Diopter Setting. Using a collimating telescope (par. 15), focus the eyepiece until distant objects (beyond 200 yards) in the field of view appear sharp and clear. Check the diopter reading. The diopter reading must be within plus or minus one-quarter diopter of zero. Make sure the eyepiece has sufficient movement from this sharp focus to cover the plus and minus range of the diopter scale. See that the images formed by the two optical systems are sharp and clear at the center of the field (table IV).

d. Collimation. Check collimation as described in paragraph 65. With the eyepieces focused at infinity, and with any interpupil-

lary setting between 58 and 72 mm, see that two parallel rays entering the objective lenses are parallel on emerging from the two eyepieces within the following limits:

- (1) Three and one-half minutes of true field in a vertical direction (1.03 mils).
- (2) Three and one-half minutes of true field in a horizontal direction if the rays are converging (1.03 mils).
- (3) Seven minutes of true field in a horizontal direction if the rays are diverging (2.07 mils).

e. Parallax. Adjust the diopter scale to zero as indicated in *d* above and check to see that the reticle graduation nearest the center of the field is in sharp focus when the left eyepiece is set between 0 and minus 0.6 of a diopter. This requirement is not applicable to binoculars M7, M15, and M15A1 which have no reticle (par. 61).

f. Image Tilt. The images of a vertical target formed by the two optical systems will be vertical within 1° and parallel to each other within one-half degree. (One degree of arc is equivalent to approximately 2.4-mil blocks measured across the field of view.)

Note. A "mil block" refers to one block or square of a checkerboard target placed at a distance or range of 1,000 times the dimensions of each square. That is, a mil block target placed 5,000 inches (139 yards) from the instrument would be marked off in blocks 5 inches square. A deviation of 1-mil block on this target at 5,000 inches (139 yards) would represent an error or tolerance of 1 mil.

g. Reticle. The long horizontal line of the reticle should be parallel to the line of centers of the two objectives when the interpupillary scale reads "63 mm" plus or minus 1 mm. This requirement is not applicable to binoculars M7, M15, and M15A1 which have no reticles (par. 64).

h. Eyepiece Movement. Turn the eyepieces throughout the entire range of the diopter scale; the eyepieces must function without undue irregularities, friction, or looseness throughout the range of the diopter scale.

i. Stagger. Sighting through each eyepiece with a collimating telescope, obtain a sharp image of a distant target by rotating the eyepiece. Hold the binocular with the objective end on a surface plate. Place a straight-edge across the eye guards. One eyepiece will not extend beyond the other by more than one-sixteenth inch.

j. Interpupillary Scale. See that the interpupillary distances between corresponding parts of the eyepieces as actually measured check with the scale reading to within 1 mm. (par. 26*h* and 63).

k. Hinge Movement. The hinge movement should be firm and

smooth throughout the range of the interpupillary scale. It should be firm enough to prevent accidental movement during normal handling or use of the binocular.

l. Coated Optical Elements. Binoculars which are processed through an Ordnance depot maintenance shop on a rebuild basis must have coated optics in accordance with TM 9-1501. A coating of a magnesium fluoride film on the refracting surfaces of lenses and prisms reduces the amount of light reflected from the surfaces and results in a corresponding increase in the amount of light transmitted through the lenses. Reticles are not coated. To identify coated optical elements, hold the instrument at an angle to a source of light. Observe the reflections from the objective. If the reflection of light has a purplish or bluish tint, the optical elements are coated. Under certain conditions this tint may have the appearance of a dull film on the face of the lens. Instruments of late manufacture have a label attached which warns of coated elements. Partial or complete removal of the coating does not make the element useless but reduces the efficiency of the instrument. If scratches or partial removal develop, do not attempt to remove the scratch or the remainder of the coating. A partially coated optical element is still more efficient than an element with no coating. Refer to TM 9-1501.

m. Cementing of Optical Elements. Optical elements which have been cemented with a *thermoplastic* type cement, such as Canada Balsam, will not be used at the time of rebuild. Optical elements which have been cemented with various types of *thermosetting* cement at the time of manufacture, may be used if the elements have no apparent defects. When recementing operations on optical elements are required at the time of rebuild, the latest approved type of *thermosetting* optical cement will be used (ORD 3 SNL K-1). Refer to TM 9-1501 for information on cementing lenses.

n. Sealing. Check to see that the binoculars are sealed, where required in the rebuild procedure, with sealing compound for optical lenses and that exterior screw holes are filled with sealing and plugging cement. Refer to the applicable rebuild chapter (chs. 5 through 11).

o. Condition of Finish. See that the paint is in good condition and neither chipped nor cracked. The diopter scales and their indexes must be clearly legible. The paint must afford protection against corrosion and the binocular must present an appearance similar to that of a new instrument. The vinylite body covering must not be damaged or blistered. Base metal should not be visible on any portion of the binoculars requiring paint. The inspector

must determine whether there are chips, scratches, blisters, or cracks which will require a complete repainting or whether the condition can be corrected by spot painting.

p. Carrying Cases (figs. 1, 2, 4, 7, and 8). Check the carrying cases for mold, breaks, tears, loose stitching, rust, and defective snaps or buckles.

q. Filter M1.

- (1) Inspect filter M1 according to procedures presented in paragraph 25l.
- (2) The filter when used on the binocular must be removed and placed on the bottom of the carrying case M17 (fig. 36) before placing the binocular in the case after the above inspection.
- (3) The filter will be stored in the bottom of carrying case M17 when not in use.
- (4) All carrying cases M17 which have been classified unsatisfactory as a result of inspection and tagging in accordance with the now obsolete SB 9-91, but which pass inspection in all other respects will be considered as serviceable.
- (5) These instructions do not apply when using carrying case M62 or M62A1, since there is ample room for the storing of the binocular with the filter attached. The following inspection procedure should be used:
 - (a) Remove the filter M1 from the binocular.
 - (b) Place the filter M1 in the bottom of the carrying case M17 (fig. 36).

31. Ordnance Shop Inspection of BC Telescope M65

a. Vibration Test. Vibrate the BC telescope for 15 seconds on the universal vibration tester 17-T-5549-975 (figs. 18 and 38) prior to other inspection operations.

b. Condition of Optical Elements. Refer to paragraph 30b which is also applicable to the BC telescope.

c. Definition of Field of View, and Proper Diopter Setting. Check to see that the diopter scale indexes indicate 0 within plus or minus 0.5 diopter when the images, at the center of the field, of a target 750 yards plus or minus 50 yards distant, are brought into sharp focus with the aid of a collimating telescope 18-T-540-250 (fig. 14) focused at infinity. See that the images are sharp and clear at the center of the field. From this sharp focus the eyepiece must have 3 diopters movement in the plus and minus direction.

d. Tilt of Image. Mount the telescope (fig. 190) so that its

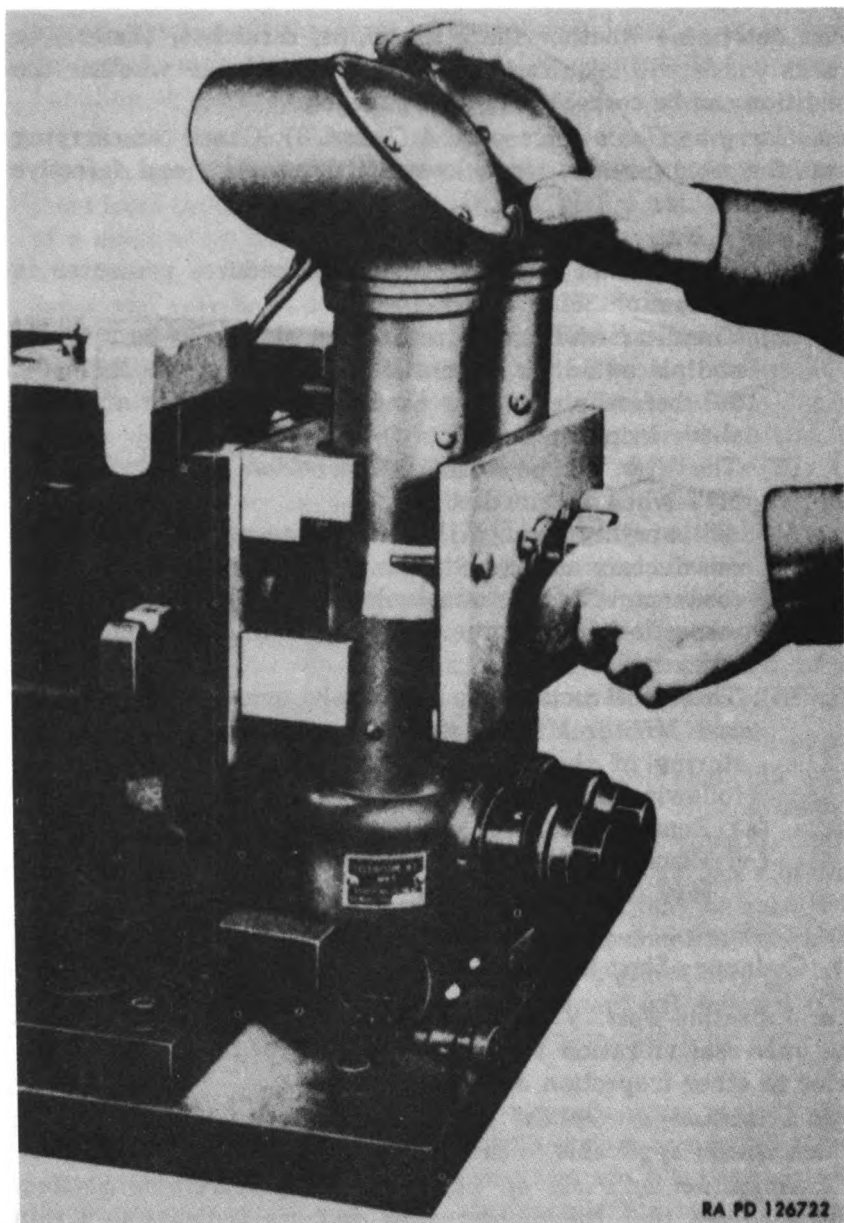

Figure 38. BC telescope mounted on universal vibration tester 17-T-5549-975.

spindle socket is in a true vertical position. Place collimating telescope 18-T-540-250 in holder 41-H-2374-125 and mount on surface gage 41-G-372. Sight through collimating telescope at a plumb line and erect the reticle. Slide the collimating telescope behind either eyepiece of the BC telescope and sight on the plumb

line. The image of the plumb line formed by either optical system must be parallel to the reticle of the collimating telescope within 2 mils as measured across the entire field of view and parallel to the other within 1 mil.

e. Tilt of Reticle. With the telescope mounted as in *d* above, check that the center vertical reticle line is parallel to the image of a plumb line within 0.5 mil as measured across the entire field of view.

f. Parallax. Place the instrument in a fixture and direct it at an object or target at a distance of 700 to 800 yards. Observe the target through the instrument with the eye, alining a point or line on the target with a mark on the reticle. Observing through the instrument, shift the eye from side to side and up and down. Note whether the target reference point appears to shift with relation to the mark on the reticle. Then direct the instrument at an extremely distant target and repeat the eyeshift test for parallax.

g. Collimation. Collimation adjustments are prescribed in paragraph 143. At the zero setting of the eyepieces and at any interpupillary setting between 58 and 72 mm, two parallel rays entering the head prisms should be parallel on emerging from the eyepieces within the following limits:

- (1) 2.0 minutes of true field in a vertical direction (0.6 mil).
- (2) 3.3 minutes of true field in a horizontal direction (1.0 mil).

h. Eyepiece Movements. Refer to paragraph 30*h*.

i. Eyepiece Stagger. Set the eyepieces to the same diopter setting, and, by laying a straightedge across the eyepieces, see that neither of the eyepieces extends beyond the other by more than 1 diopter (approximately 1/32-inch). Follow the inspection indicated in paragraph 30*i*.

j. Filters. Check to see that the filters are clean and free from cracks or breaks. Operate the filter knobs and make sure that the knob indication coincides with the filter actually in place in the telescope tubes.

k. Interpupillary Movement and Scale. Operate the interpupillary movement throughout its range; the movement must function without undue irregularities, friction, or looseness. The interpupillary distance as measured by a scale laid between corresponding parts of the eyepieces must be correct within 0.5 mm.

l. Angle of Site Mechanism. Operate the angle of site mechanism throughout its range; the mechanism must function without undue irregularities, friction, or looseness.

m. Angle of Site Error. Using procedure presented in para-

graph 147d, check to see that the error of any angle of site reading including backlash, does not exceed 2 mils.

n. Backlash. Using procedure presented in paragraph 27h(2), check to see that backlash does not exceed 1 mil.

o. Angle of Site Level. Mount the telescope (par. 144) so that the spindle socket is in a true vertical position, and adjust so that the optical line of sight is horizontal. In this position, the angle of site level bubble must be central with respect to the vial graduations when the angle of site index is opposite "3" of the angle of site scale and the angle of site micrometer set to read "0". The elevation and angle of site mechanisms can be checked for angular accuracy with the leveling fixture 41-F-2994 (par. 17). In using the leveling fixture, the elevation movement is displaced *vertically* in known angular steps, and the associated angle of site level vial bubble is centered to obtain the elevation error. Refer to adjustments, paragraph 147.

p. Elevating Mechanism. With the telescope mounted on the spindle of the special fixture (par. 138), check to see that the elevating mechanism functions throughout its range without undue irregularities, friction, looseness, or chatter. If chatter exists in the movement, it must not cause the telescope to move vertically more than 4 mils.

q. Plumb Travel. With the telescope mounted as in the inspection for the angle of site level (par. 147), the optical line of sight must not deviate from a plumb line by more than 1 mil when the telescope is rotated through an angle of approximately 18° below to 18° above the horizontal line of sight (table V).

r. Reticle Illumination. Illuminate the reticle by means of instrument light M28 or equivalent, and see that the reticle markings are clearly defined when observed in a dark room.

s. Plug Assemblies. See that the plug assemblies fit properly over the telescope windows.

t. Optical Coating. Telescopes which have been processed through an ordnance base maintenance shop on a "rebuild" basis must have coated optics in accordance with TM 9-1501. This coating is not mandatory for telescopes being issued from depot stock (par. 30l).

u. Cementing of Optical Elements. Refer to paragraph 30m.

v. Lubrication. Refer to paragraphs 47 and 132 through 137.

w. Sealing. Check to see that telescope is sealed, where required, with sealing compound, for optical lenses and that exterior screw holes are filled with sealing and plugging cement (par. 51). The compound and cement are listed in ORD 3 SNL K-1.

x. Condition of Finish. See that the paint is in good condition and neither chipped nor cracked. All scales and indexes must be

clearly legible. The paint must afford protection against corrosion and the telescope must present an appearance similar to that of a new instrument. Base metal should not be visible on any portion of the BC telescope requiring paint. The inspector must determine whether there are chips, scratches, blisters, or cracks which will require a complete repainting or whether the condition can be corrected by spot painting. Instruments should be completely and repainted at the time of rebuild by depot shops (TM 9-2851 and TM 9-1861).

32. Ordnance Shop Inspection of Telescope Mount M48, Tripod M17 and Equipment

a. Circular Level. Adjust the mount so that the telescope mounting spindle is in a true vertical position and check to see that the level bubble is centered within the limits of the etched circle.

b. Movements. Refer to paragraph 27d.

c. Horizontal Travel. Set the spindle of the mount in a true vertical position and install a BC telescope on it. Superimpose the center of the reticle on a reference point or target. Rotate the mount by means of the azimuth worm to any position in 360° and bring the optical line of sight back to the target by means of an azimuth testing fixture 41-F-2995 or 7691596 (fig. 23 and par. 11). The line of sight of the telescope must not deviate up or down from a point on a vertical line of the target by more than 1.5 mils. Repeat this test using the orienting worm.

d. Lift. Center a horizontal line of the BC telescope reticle on a horizontal line of the target with the mount spindle approximately vertical. Move the telescope horizontally by means of the azimuth knob, then reverse the movement. The reticle line must not be displaced from the horizontal line of the target by more than 0.5 mil. Repeat this test using the orienting worm.

e. Circular Error. The circular error in the azimuth mechanism must not exceed 2 mils including backlash, when checked against a calibrated azimuth testing fixture 41-F-2995 (fig. 25) or 7691596 (fig. 27) at any point on the azimuth circle.

f. Backlash. Backlash in the azimuth or orienting mechanism must not exceed 1 mil (par. 27h(2)).

g. Azimuth Scale and Micrometer Dial. See that the zero graduation of the azimuth micrometer is opposite its index, when the azimuth scale index is opposite any graduation of the azimuth scale.

h. Painting. Check the paint of the mount as indicated for the BC telescope in paragraph 31x.

i. Mount Cover (fig. 7). See that the metal cover of the telescope mount is not damaged in any way that will prevent the cover from fitting properly on the tripod M17 when the mount is attached. The straps will be free from mold, breaks, tears, loose stitching, or defective buckles.

j. Tripods M10 and M17 and Telescope Adapter M44 (fig. 7). Inspect these items as indicated in paragraph 27d.

k. Instrument Light M28. Inspect the instrument light M28 as described in paragraph 27i.

l. Packing Chest M39 and Carrying Case M45 (fig. 7). See that all leather, wood, felt, and metal components are free from mold, breaks, tears, rust, defective lid clamps, or broken handles. Make sure that the packing chest is not damaged in any way that will prevent the telescope from being securely supported in the proper position. Similarly inspect the carrying case M45 for tripod M10 and adapter M14.

Section IV. PRE-EMBARKATION INSPECTION

33. General

a. Inspection for outward appearance of the binoculars, BC telescope, mount, and equipment is of importance as well as mechanical condition.

b. Where any doubt exists as to the utility of an assembly or of the binoculars, BC telescope, and equipment, that assembly or the matériel must be replaced by a truly serviceable item. Equipment, when inspected, must approach new equipment standards of operation and appearance, and the workmanship and quality of the end product must reflect the highest standards obtainable. To assure that all items, insofar as practicable, possess original appearance, it is desired that items normally painted be repainted if the painted surfaces show signs of damage.

34. Inspection

a. The specifications, standards, and operations intended as a guide to insure satisfactory performance and acceptability of the matériel covered in this manual are as follows:

- (1) Refer to the technical inspections prescribed in paragraphs 22 through 32. In addition, particular attention should be given to the sealing and moisture proofing of the matériel.
- (2) The inspector should be familiar with the section on operations under unusual conditions in the operator's manual TM 9-575.

(3) Fungus proofing of the BC telescope M65, if required, should be checked. Refer to paragraph 137.

b. Make sure that MWO ORD F210-W1, MWO ORD F210-W2, and MWO ORD F238-W1 have been accomplished. See paragraph 25g.

CHAPTER 4

TROUBLE SHOOTING

35. Purpose

Trouble shooting is a systematic isolation of defective components by means of symptoms, tests for determining the defective components, and includes remedies. The tests and remedies provided herein are governed by the scope of the level of ordnance maintenance.

36. Procedure

Specific troubles likely to be encountered in inspecting and testing the binoculars and BC telescope are listed in the first column of table IV or table V. The probable cause of the difficulty is given in the second column, and the corrective action to be taken, with references to the pertinent paragraphs of the rebuilt chapters is given in the third column.

Table IV. Trouble Shooting — Binoculars

Malfunction	Probable causes	Corrective action
Binding in the eyepiece movement.	Dirty or burred threads..	Disassemble, clean, and lubricate (para. 47 and 48) threads of eyepiece assembly.
	Wrong lubricant.....	Clean. Lubricate threads with approved grease (par. 47).
Rough movement of hinge.	Burrs on hinge pin or washers.	Disassemble and remove burrs from washers with a fine oilstone; remove burrs from the hinge pin by lapping together (para. 48 and 49).

TABLE IV. Trouble Shooting — Binoculars — Continued

Malfunction	Probable causes	Corrective action
Loose hinge.....	Improper lubrication and adjustment of tension.	Disassemble hinge assembly, lubricate (par. 47), reassemble, and adjust the hinge pin screws for the correct tension (par. 58a), readjust interpupillary scale (par. 63).
Diopter scale more than 0.25 diopter off zero when tested as described in par. 30c.	Improper shimming or assembly.	Disassemble hinge, clean all parts, reassemble, and lubricate (par. 47), if necessary, installing additional washers to take up all end play. Adjust hinge for correct tension (par. 58a).
Parallax and improper diopter movement.	Diopter scale improperly located.	Adjust diopter scale (par. 59 or 81 for binocular M8).
Eyepiece stagger.....	Image formed by objective too close or too far from focal plane of eyepiece.	Adjust objective assembly (par. 61, 72, or 105 as applicable) and correct assembly of optical elements.
Tilt in field of view.....	Image formed by objective too close or too far from focal plane of eyepiece.	Adjust position of objective (par. 62). Recheck for parallax and proper diopter movement (pars. 30i and 62).
Tilt of reticle.....	Improper matching of optical elements.	Refer to paragraph 62.
Tilt of reticle.....	Porro prisms not set at 90° angle in relation to one another.	Adjust porro prisms (pars. 40 and 58b).
Poor definition of the reticle.	Improper reticle positioning.	Adjust reticle (par. 64).
Poor definition of the image.	Defective optical elements; incorrect assembly and positioning of elements located between the reticle and the eye of the observer.	Perform a thorough inspection of elements and correct assembly.
Collimation error excessive or double vision evident.	Causes for poor definition of the reticle apply. However, only those optical elements forming the image are responsible for the poor definition.	Perform a thorough inspection of elements and correct assembly.
Collimation error excessive or double vision evident.	Optical axes not parallel to true hinge axis at some interpupillary setting.	Collimate binocular (par. 65).

Table V. Trouble Shooting — BC Telescopes M65 and Equipment

Malfunction	Probable causes	Corrective action
Tripod legs warped.....	Replace legs (pars. 129 and 134).
Loose tripod shoes.....	Shrinkage of wood.....	Apply heat and reswheat shoe to leg; drill a new hole and install a straight pin (par. 134b).
Tripod leg hinge fails to support leg in horizontal position.	Improper adjustment of clamping screw.	Back off the safety nut (clamping lever locking nut) and, using the adjusting lever as a wrench, rotate the clamping screw until the hinge assembly will support the leg. Tighten the safety nut (fig. 198).
Circular level vial bubble larger than index circle.	Defective vial.....	Replace circular level vial (pars. 128 and 133).
Circular level vial bubble does not stay within index when mount is rotated.	Improper adjustment of circular level vial.	Adjust the level vial by means of the adjusting screws (par. 148).
Wave type horizontal travel. Refer to paragraph 28A.	Burr on bearing surfaces where the azimuth housing and the orienting housing bear on the worm gear and the internal surfaces where they bear on each other.	Disassemble the mount completely (par. 128) and remove the burrs with a fine india stone. Reassemble (par. 133) mount and test (pars. 146 and 148). Refer to par. 122 for maintenance of worm and gear.
Jump type horizontal travel. Refer to paragraph 28A.	Play between azimuth housing and orienting housing.	Remove the mount from the tripod and remove the saucer-shaped clamp; remove two headless staking screws and adjust play between the housings by tightening the round steel nut. Countersink the housing for staking screws and assemble the mount (par. 133).
Diagonal type vertical travel.	Bent or cross threaded locating bushing of BC telescope M65. Bent upper vertical spindle of mount M48.	Replace or refit the locating bushing (pars. 127l and 132m). Replace or straighten the upper vertical spindle (pars. 128 and 133) and secure with a taper pin.

TABLE V. Trouble Shooting — BC Telescope M65 and Equipment — Continued

Malfunction	Probable causes	Corrective action
Backlash in mount orienting mechanism.	<p>Improper spring tension.</p> <p>End play between orienting worm and ball cap.</p>	<p>Increase the tension on the flat spring A46528 or shim the plunger located under spring retaining cover (integral name plate) (pars. 128 and 133).</p> <p>Tighten the orienting worm ball cap (pars. 133 and 146c). Refer to paragraph 122.</p>
Backlash in azimuth more than 1.0 mil.	<p>Improper mesh between worm and worm gear.</p> <p>End play between azimuth worm and ball cap.</p>	<p>Increase tension on the compression spring by tightening the slotted plug located near the azimuth micrometer (pars. 128, 133, and 146c).</p> <p>Tighten the ball cap located beneath the azimuth knob (pars. 128, 133, and 146c).</p>
Drag in azimuth or orienting mechanism in inter-pupillary movement in angle of site mechanism or in elevating mechanism.	<p>Improper lubrication or dirty bearing surfaces.</p> <p>Ball cap too tight; staking screws too tight on ball cap and socket.</p> <p>Too much spring pressure or damaged parts.</p> <p>Burrs on bearing surfaces.</p>	<p>Disassemble, clean, and properly lubricate (pars. 46, 47, 128, and 133).</p> <p>Loosen ball cap and screws (pars. 122 and 146c).</p> <p>Adjust the spring pressure (par. 146c (2)); disassemble and replace damaged parts (pars. 128 and 133).</p> <p>Disassemble mount (par. 128) and remove burrs with a fine file or india stone (pars. 48 and 122). Assemble (par. 133).</p>
Locating bushing does not mate securely with mount.	<p>Improper fit or assembly of latch A316659, plug A316660, and spring A316661.</p> <p>Locating bushing is not securely fastened to elevating worm gear.</p>	<p>Stone the mating surfaces with a fine india stone until proper fit is obtained. Refer to paragraph 132m.</p> <p>Remove the two taper pins (par. 127) which secure the locating bushing to the worm gear; ream the holes and refit the taper pins (par. 132m).</p>

TABLE V. Trouble Shooting — BC Telescope M65 and Equipment — Continued

Malfunction	Probable causes	Corrective action
Backlash in elevation. . . .	<p>Improper mesh of elevating worm and worm gear.</p>	<p>Tighten the adjusting plug located at the top of the right housing, thus increasing the pressure on the compression spring which in turn increases pressure on the plunger. Refer to paragraph 122i.</p>
	<p>End play between elevating worm and ball cap.</p>	<p>Tighten ball cap located beneath the elevation knob. Refer to paragraph 122i.</p>
<p>Elevating movement less than an angle of approximately 18° below to 18° above the horizontal line of sight (par. 53).</p>	<p>Defective worm gear. . . .</p>	<p>Replace worm gear (para. 128 and 133).</p>
	<p>Stop rings not positioned properly.</p>	<p>Check the position of the elevating worm stop rings (para. 127 and 132n).</p>
	<p>High spots at extremities of worm gear.</p>	<p>Lap the elevating worm and gear together (par. 122), until extremities are worn down to match the wear at the center.</p>
<p>Binding in angle of site movement.</p>	<p>Ball cap too tight.</p>	<p>Loosen ball cap under angle of site micrometer (para. 122l and 147).</p>
<p>Chatter.</p>	<p>Improper mesh of worm and worm gear.</p>	<p>Lap worm and worm gear together (para. 48 and 49, 122g).</p>
<p>Backlash in angle of site mechanism exceeds one mil; irregularities, friction, or looseness in movement (par. 27A).</p>	<p>Improper mesh of angle of site worm and worm gear.</p>	<p>Tighten plug beneath the angle of site worm increasing the pressure on the spring and plunger (para. 122 and 147b).</p>
	<p>End play between angle of site worm and ball cap.</p>	<p>Tighten the angle of site ball cap which is located beneath the angle of site micrometer (par. 147b).</p>
<p>Interpupillary scale movement less than 12 millimeters (par. 27A).</p>	<p>Improper positioning of stop rings.</p>	<p>Disassemble the interpupillary screw assembly and reassemble properly (para. 127 and 132b).</p>
<p>Interpupillary scale reading incorrect (par. 27A).</p>	<p>Improper adjustment. . . .</p>	<p>Set the interpupillary distance at 2.52 inches and loosen the two screws securing the interpupillary scale to the housing and align the 64-mm mark with the index (par. 142). Tighten the two screws.</p>

TABLE V. Trouble Shooting—BC Telescope M65 and Equipment—Continued

Malfunction	Probable causes	Corrective action
Binding in the eyepiece movement.	<p>Dirty or burred thread...</p> <p>Wrong lubricant.....</p>	<p>Disassemble, clean, and lubricate (pars. 46 and 47) threads of eyepiece assembly. Remove burrs (pars. 48 and 49).</p> <p>Lubricate threads with approved grease (par. 47).</p>
Poor reticle definition.....	<p>Defective optical elements; incorrect assembly and positioning of elements located between the reticle and the eye of the observer; improper adjustment of diopter scale.</p>	<p>Perform a thorough inspection of elements and correct assembly (par. 139).</p>
Poor image definition.....	<p>Causes for poor reticle definition apply. However, only those optical elements forming the image are responsible for the poor definition.</p>	<p>Perform a thorough inspection of elements and correct assembly; adjust the position of the objective cell (par. 139).</p>
Parallax and improper diopter movement.	<p>Image formed by objective too close or too far from focal plane of eyepiece.</p>	<p>Refer to paragraph 31f. Adjust objective assembly (par. 139).</p>
Eyepiece stagger.....	<p>Image formed by objective too close or too far from focal plane of eyepiece.</p> <p>Improper matching and positioning of optical elements.</p>	<p>Adjust position of objective (par. 139). Recheck for parallax and proper diopter movement.</p> <p>Refer to paragraphs 30i, 31i, and 141.</p>
Diopter scale more than 0.5 diopters off zero when tested as described in paragraph 31c.	<p>Diopter scale improperly located.</p>	<p>Adjust diopter scale (par. 139).</p>
Tilt of reticle.....	<p>Improper reticle positioning.</p>	<p>Slightly loosen the four reticle positioning screws, remove the plug in the housing, and with a scribe, rotate the reticle all the desired amount (par. 144). Install the plug and tighten the positioning screws. Also refer to paragraph 31c and d.</p>
Collimation error excessive or double vision present.	<p>Optical axes not parallel to geometric axes at some interpupillary setting.</p>	<p>Collimate BC telescope (par. 143).</p>
Tilt of field of view.....	<p>Improper adjustment of 90° prisms.</p> <p>Porro prisms not set at 90° angle in relation to each other.</p>	<p>Replace erecting prism assembly.</p> <p>Replace erecting prism assembly.</p>

CHAPTER 5

REPAIR AND REBUILD OF BINOCULAR M3

Section I. GENERAL MAINTENANCE

37. General

a. Information and instructions herein are supplementary to instructions for the using organization contained in TM 9-575.

b. This chapter contains general and specific maintenance instructions for the repair and rebuild of each major component of the binocular M3. In the following sections, specific adjustments, repair, and rebuild procedures are described. Each major component is restored to a serviceable condition by disassembling its assemblies and subassemblies, by inspecting, by replacing parts, and using necessary machining operations followed by reassembly, test and adjustment, and final inspection.

c. Constant care should be exercised to see that the in-process inspection during repair and rebuild is properly performed since final acceptance of the assembled item depends largely upon the care exercised in process.

38. Handling of Disassembled Parts

a. A parts tray or suitable receptacle should be provided so that parts, as removed, can be placed in their respective positions in relation to the assembled instrument. Always keep the relative position of parts until the instrument is completely assembled. This is especially important where there is a possibility of a different man assembling the unit.

b. The instrument repair kit 41-K-96 contains several plastic parts boxes which are used for segregating small parts during disassembly. Small plywood trays can also be constructed for this purpose. As a makeshift, a number of small cardboard boxes will serve. Whatever the equipment used, small parts must be kept separated and in order, so that reassembly can be performed with the least possible confusion.

c. As parts are removed, they should be placed in logical order in the trays provided. Large assemblies should be kept on the work bench and carefully placed so as to prevent loss or breakage. After cleaning and inspection, optical elements should be wrapped in lens tissue and marked for identification. Mechanical parts and housings should be cleaned, inspected, and lubricated if further maintenance is unnecessary. All optical elements should be cleaned again prior to reassembly. If parts are to remain disassembled for any length of time, protect them with a bench cover.

d. Always be sure to wrap optical elements thoroughly after they are marked. Store them in a safe position in a cool, dry place to protect them from damage. Mechanical parts must be marked for clear identification and carefully stored to prevent damage. If they are to be stored for a few days before reassembly, the old grease should not be removed, as a perfectly clean metal part will soon become corroded. Be sure to identify each part or group of parts with the instrument of which it is a component.

39. Marking of Metal Components

The metal components of the binoculars should be marked as the instrument is disassembled in order to simplify accurate re-assembly. The alinement of such marks permits the instrument

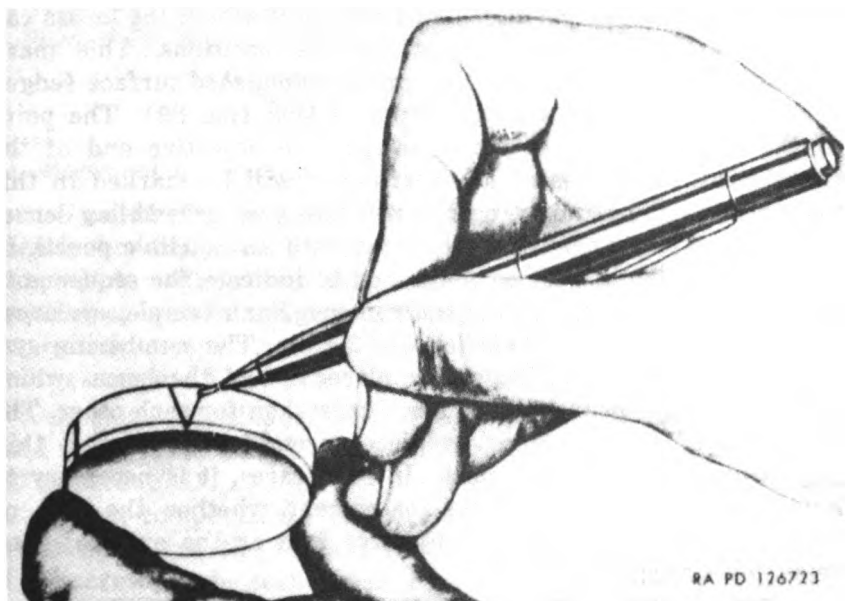

Figure 39. Lens marking system.

repairman to replace mating parts in their original relationship to each other, thus greatly facilitating reassembly and adjustment. In some instances, original assembly by the manufacturer is done with special jigs and fixtures not available to the repairman. In these cases, proper marking of mating parts may be the only way that proper and satisfactory reassembly can ever be accomplished. Use a scribe and, if possible, a steel rule or straight edge to mark the mating parts. Make the marks small but legible, and as simple as possible. Never scribe marks on threads or bearing surfaces.

40. Marking of Optical Elements

a. General. The marking of optical elements in an instrument has a threefold purpose. It aids in the reassembly of an instrument by indicating the original position of each element in relation to other elements. If it is necessary to remove the cement from compound lenses, a mark of some nature on the edge of the lens aids in recementing the lens in its proper relationship to the mating parts (TM 9-1501). It enables the repairman to indicate the properties or characteristics of an element. The marking of these elements, whatever the purpose, should be uniform throughout all shops to insure recognition by any instrument repairman.

b. Lenses. The prime purpose for marking lenses upon disassembly is to establish a guide by means of which the lenses can be reassembled in their proper relative positions. This mark should consist of a "V", inscribed on the *unpolished* surface (edge) across all the elements of a compound lens (fig. 39). The point of the "V" should be directed toward the objective end of the instrument. All lenses of an instrument will be marked in this manner, thereby eliminating the possibility of assembling lenses incorrectly. The marking can be done with an indelible pencil. In addition, the lenses will be numbered to indicate the sequence in which they are placed in the instrument. For example, eyelenses should be marked "1," field lenses "2," etc. The numbering system aids in preventing improper placement of the lenses which are similar in appearance and easily mistaken for each other. The field lens of the binocular eyepiece assembly has a very thin edge which is difficult to mark. In such cases, it is necessary to note when disassembling the instrument whether the side of greater curvature faces the objective lens or the eyelens; then reassemble accordingly.

c. Prisms. All markings on prisms are placed on the unpolished surfaces. Each prism should be marked to indicate whether it was

located in the right or left telescope. Identify such location by placing an "R" or "L" on each prism (fig. 40). Immediately after the "R" or "L," mark the "E" or "O." The "E" indicates that the prism is first in the light path of the eyepiece, whereas the "O" specifies that the prism is first in the light path of the objective lens. A prism marked "LE" thus belongs in the left telescope and is first in the light path of the eyepiece. As it is necessary to prevent the prisms from being reassembled in a reversed position, an arrow should be marked, pointing toward the closed end of the prism assembly (fig. 40).

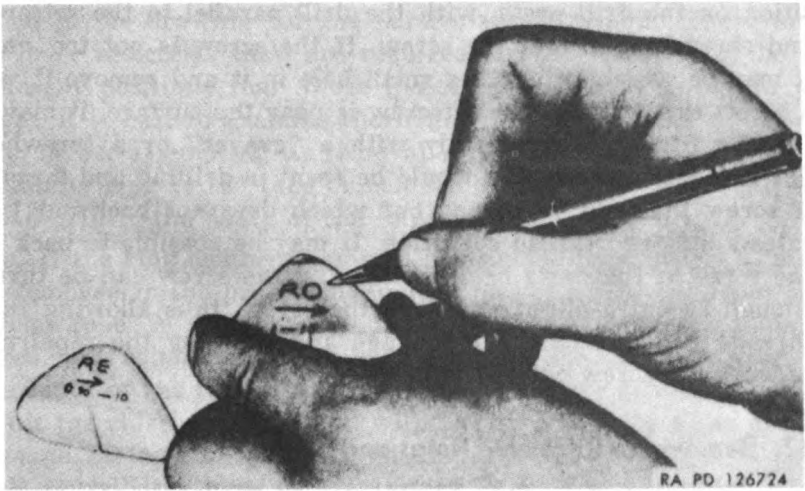

Figure 40. Marking prism pairs.

41. Removal of Setscrews

a. General. The positioning of mechanical components is frequently accomplished by the use of setscrews. Disassembly of components without removing these setscrews is probably the greatest cause of damage to fire control instruments during the inspection or repair process. Many setscrews are concealed with sealing compound and paint.

b. Removal of Undamaged Setscrews. A sharpened piece of hard wood, brass wire, etc. are good tools for locating and digging out setscrews. Do not use the jewelers' screw driver for digging out sealing compound as this action may damage both the screw driver blade and the threads in the screw hole. When the head of the screw can be seen, insert a screw driver of the proper size and remove the screw. After unscrewing, pick out the screw with tweezers.

Caution: If the screw will not back out when normal pressure is applied with the screw driver, do not force it. It may have been sealed in place with shellac or another fixing agent. If so, apply a few drops of alcohol to the screw head and allow it to soak for a few minutes. Again insert the screw driver and exert a slight back and forth pressure. Repeat this process until the screw can be removed by normal pressure.

c. Removal of Damaged Setscrew. If the slot of a setscrew below the surface is damaged, the best method, usually is to drill out the screw with its own tap drill and retap the threads. If this is to be done, set up the part to be drilled in a firm position on the drill press, with the drill parallel to the setscrew, and carefully drill out the screw. If the screw is not too small, it may be possible to drill a small hole in it and remove it with a screw extractor. If the setscrew is near the surface, it may be possible to slot it sufficiently with a "graver" or a screwhead file, thus saving time that would be spent in drilling and tapping. A screw that can be turned but which does not back out indicates a stripped thread condition. It may be possible to back out the screw if the parts held together by the screw can be turned enough to put a slight stress on the screw, thus allowing those threads still undamaged to engage and enabling the repairman to work the screw out of the hole.

42. Removal of Retaining Rings and Cells

a. Retaining rings may be sealed with shellac or sealing compound, or may be held with a setscrew. The application of alcohol to the shellac holding a retaining ring may be sufficient to soften the shellac and permit the removal of the ring. In obstinate cases, however, when the alcohol will not penetrate sufficiently, the flame of a small gasoline or alcohol blow torch applied to the outer diameter of the cell, in the area of the retaining ring, will burn or singe the shellac enough to allow removal of the ring.

b. In the case of objectives where the sealing compound is usually heavily applied, the excess compound should be removed by picking or scraping without damaging the thread. Threads protruding beyond the retaining ring should be cleaned with the correct thread chaser. Dry cleaning solvent or volatile mineral spirits should then be applied to the thread to permit softening of the compound which has penetrated under the retaining ring. The ring may then be removed. If not, the application of heat by hot plate 17-H-7875 (fig. 16) or flame will soften the compound and permit removal of the ring. This should only be used after previous methods have been tried, as it may damage the paint.

c. Setscrew holes are usually spotted into the retaining ring. After removing the screw (par. 41), clean the hole with a tap and syringe. The ring can then be moved easily. If the hole has not been spotted into the ring, however, and the setscrew has been pressed on the threads, the threads may have become damaged thus preventing the removal of the retaining ring. In this case, select the proper tap drill for the size tap used to thread the hole, and spot the hole to the depth of the thread in the retaining ring. It should then be possible to remove the ring easily without further damage to the threads. Refer to paragraph 41.

d. In some cases the ring may not be held by the method specified in the drawing for the particular instrument. There may be more setscrews than are required, or the screws may be in different positions than those indicated on the drawing. In all cases, it is best to examine thoroughly the area of the retaining ring before attempting its removal. A punch mark may stake the retaining ring to the tube or cell. This should be spotted with a small drill to the depth of the impression.

e. If the ring has been jammed beyond the point where it may be removed in the proper manner, it must then be cut from the cell or tube. A thin, small-angle chisel should be used to make three cuts, equidistant from each other, in the retaining ring to the depth of the thread in the cell or tube. Care should be taken to hit the chisel properly and with the right weight so as not to damage the optical elements, the tube, or the cell. If it is possible to drill the ring, it may assist in making the cuts. After cutting, the pieces of the ring can be removed by prying them loose from the threads of the cell or tube. Before reassembly is attempted, the thread of the cell or tube must be repaired with the proper thread chaser and a new retaining ring fitted.

f. The cells or tubes contained in the binoculars are usually held by a retaining ring, and, after the ring is removed, they should slide out. If they do not, invert the instrument and tap it lightly in the area of the tube or cell with a rapping stick. The tube or cell should then drop. If additional pressure is required, it should then be applied with a wooden dowel stick behind the cell or tube. Care should be taken not to dent the instrument.

g. Some tubes or cells are threaded and fixed to the instrument the same as retaining rings. These should be removed in the same manner as described previously for removal of retaining rings. However, the cells or tubes, being heavier and containing optical elements, cannot be cut from the instrument as were the retaining rings unless the optical elements are sacrificed to save the body of the instrument, which is usually not replaceable.

h. Dents, bent or broken parts, and damage to tubes, separators, and diaphragms should be repaired whenever possible. Parts should be replaced only when their use would impair the functioning of the instrument. Dented tubes may be repaired by using a mandrel of solid stock with an outside diameter slightly less than the inside diameter of the tube. The mandrel is inserted in the tube to the damaged section. The mandrel is then clamped in a vise and the tube is tapped with a soft mallet until the dent is pressed out and the tube returns to its proper shape.

43. Removal of Lenses from Cells

To remove lenses from cells with threaded retainers, remove the retaining ring setscrews, fit the proper size tubular wrench to the retaining ring and proceed to loosen the ring. When the ring has made one revolution, turn the cell over and tap gently to allow the lens to drop onto the retaining ring. Maintain this inverted position while removing the ring; the lens will drop down evenly as the ring is removed. This will prevent cocking of the lens in the cell and subsequent fracturing or chipping of the lens. If the lens is sealed with sealing compound, heat the cell with hot plate 17-H-7875 (fig. 16) and proceed as described above. If gravity is insufficient to release the sealed lens, back off the retaining ring several turns. Place the cell upon clean paper and, utilizing several folds of lens tissue to prevent smudging, apply finger pressure to the top lens until the seal is broken. Finish the removal as described previously.

Caution: Heat the cell only enough to soften the sealing compound. If heated too much, the cement between the optical elements may be damaged or the lens may crack. If the lens should bind in the cell while the ring is being removed, screw the ring back until the lens is straightened; then proceed as previously described.

An improvised lens or reticle holder (par. 19) (figs. 32 and 33) with suitable collet slots may be conveniently used for removing elements.

44. Cementing Compound Optical Elements

Refer to TM 9-1501 for procedures.

45. Coated Optical Elements

Uncoated elements of instruments of early manufacture should be coated at the time of rebuild in accordance with TM 9-1501. Refer to paragraph 30l.

46. Cleaning

a. Metal Parts. Remove all optical elements, if any, from the part to be cleaned, then immerse it in dry-cleaning solvent or volatile mineral spirits, and clean with a stiff-bristled brush of suitable size. Remove the part from the dry-cleaning solvent or volatile mineral spirits, dry thoroughly, and replace as soon as practicable. Parts that have been cleaned should not be left unprotected and exposed to oxidation or accumulation of dust and dirt. Lubricate the part with the proper protective compound before installing it in the assembly (par. 47). It must be remembered that dry-cleaning solvent and volatile mineral spirits are inflammable and applicable precautions should be observed while using them.

b. Optical Elements. To clean an optical element, remove all loose dust with a camel's-hair brush or by blowing it off with a syringe (fig. 41).

Note. Do not blow dust off the surfaces of prisms when assembled to the prism shelf assembly. To do so may result in the dust becoming lodged on an inaccessible optical surface. The dust should preferably be removed by means of a vacuum pickup (fig. 42) or a suction hose with suitable nozzle.

Then, soak the element for a short time in a pan of liquid lens cleaning detergent. Wash it gently, while submerged, with a piece of clean celanese cloth. Rinse in warm distilled water. Remove the element from the water and spray it with acetone. The acetone will remove the water and then evaporate without leaving a film. *If the element is cemented, the immersion process described above cannot be used.* The liquids must be applied to the surface of the element with a brush, taking care not to allow them to come into contact with the cemented edges of the lens. Inspect the surface carefully to determine whether it is sufficiently clean. Repetition of the process may be necessary before a perfectly clean surface is attained. Lenses may also be cleaned with ethyl alcohol. Apply with lens tissue on a suitable applicator (fig. 43). Dry with fresh lens tissue. Hold prisms with a suitable prism holder (fig. 34). Do not soak cemented elements; avoid getting alcohol on the edges of such elements. More care must be taken in cleaning coated optical elements than in cleaning ordinary clear optics. Lens cleaning liquid soap should be used to clean coated elements. Care should be exercised in cleaning since excessive rubbing will remove the coating. Soft coatings of early manufacture will endure only one or two cleanings. Refer to paragraph 30l.

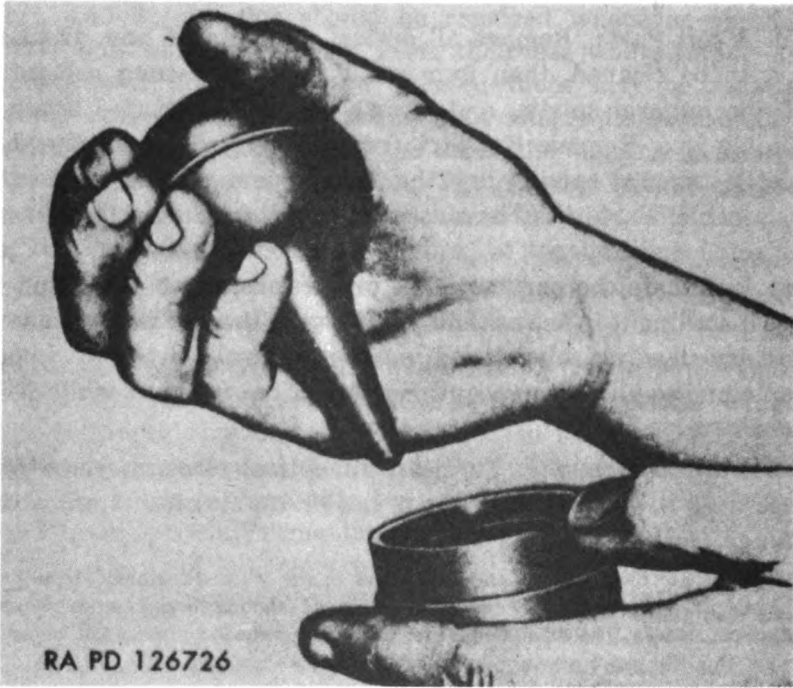

Figure 41. Using syringe to clean optical element.

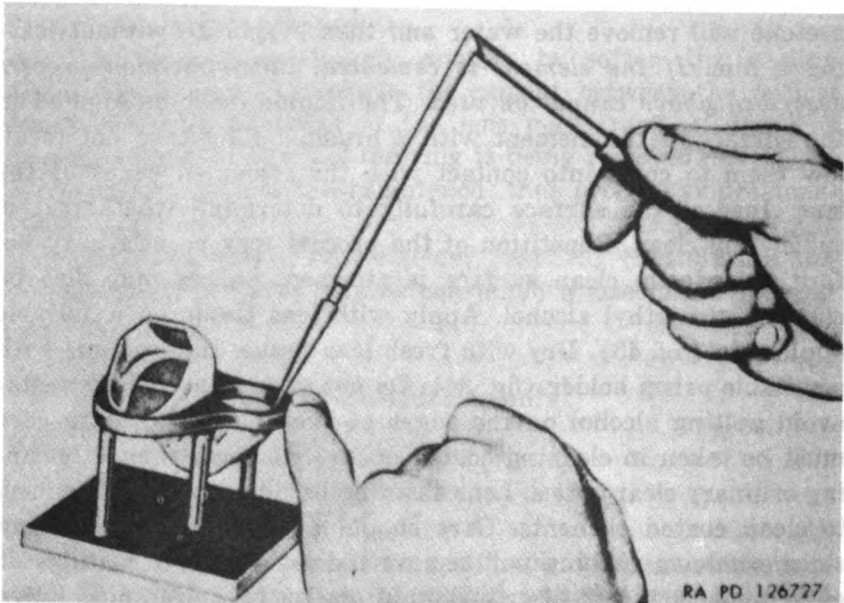

Figure 42. Cleaning prisms on prism shelf assembly with vacuum pickup.

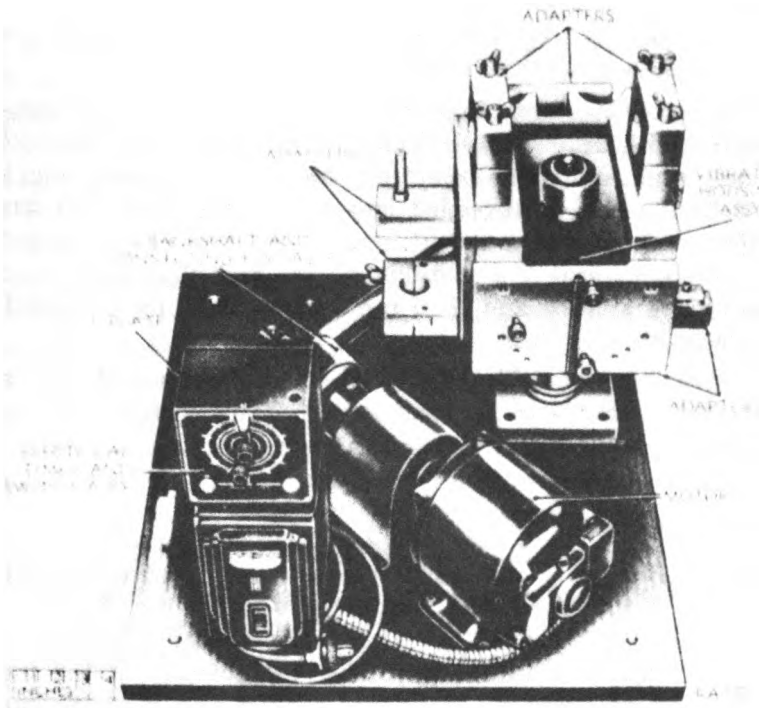

Figure 43. Cleaning lens mounted in improvised holder.

47. Lubrication

a. Lubricate the eyepieces and hinge movement with instruments aircraft grease 14-G-611-10 (1-lb can), 14-G-611-5 (8-oz tube). Use of incorrect grease for lubrication of the focusing movements of the eyepiece will result in failure of the eyepiece movements to remain stationary during usage after focusing or in the bleeding of the lubricant into the interior of the instrument.

b. Where difficulty arises during assembly of parts without the use of any lubricant, some form of assembly lubrication is considered necessary. Prime factors to be considered under assembly of optical parts are as follows:

- (1) Presence of dirt resulting from the improper cleaning of metallic parts, improper shop storage and handling practices, and dirty surroundings during assembly.
- (2) Generation of dirt, foreign material, and metallic chips resulting from threading components into each other or from assembly of pilot diameters and close fitting parts.

- (3) Detrimental effects resulting from improper use or misapplication of grease, such as formation of liquid condensate on optical elements.

c. It is permissible under assembly to grease the internal metal components with an *extremely* light film of instrument lubricating grease where required except on lens seats. Greasing should apply to such parts as threaded lens cells, pilot diameters, etc. The objective is to attain an extremely light film of grease sufficient merely to seal the metallic pores, and that the grease is to be lightly applied and then removed by rubbing vigorously with a clean lint-free cloth.

Caution: In no case will the grease be applied to any optical element seat or to those surfaces of a retaining ring that will contact an optical element.

48. Removal of Burrs

Movable components of the instrument must operate smoothly and precisely. Small burrs can be removed with the aid of a knife-edge oilstone. Care must be observed when honing a burr from the crest or side of a thread to follow the contour of the machined surface, bringing the stone into contact only with the surface of the burr. Short, light strokes should be used. If the burr is large enough to warrant its use, a jeweler's file can be used to reduce its proportions until it is practicable to finish the operations by honing. After the process has been satisfactorily completed, clean the part thoroughly, taking care to remove all particles of metal and abrasive, lubricate, and install the component in the assembly.

49. Lapping Mating Parts Together

If the eyepiece threads or other mating parts bind, run them in with a lapping compound made of powdered pumice and oil. Wash the parts with dry-cleaning solvent or volatile mineral spirits thoroughly after this operation to remove *all* of the pumice, and lubricate with approved lubricant (par. 47).

Note. Do not use an abrasive that is too coarse as a very loose fit will be the result.

50. Installing Optical Elements

a. Hold the retaining ring in a horizontal position and place all the components of the optical assembly in their respective positions on the retaining ring. Slide cell down over components and screw in retaining ring. Secure ring with headless screw. In some

instruments, it may be necessary to install components individually. In this case, cover the end of the finger with lens tissue paper, place the optical element on the paper, and slide cell over optical element and finger. Be sure that the optical element is firmly seated against the shoulder of the cell, then carefully tip the cell over and install the retaining ring, securing with headless screw.

b. In general, repairmen are inclined to tighten retaining rings for optical parts too tightly, thus distorting the optical elements within the assembly. Do not attempt to hold an assembly in position by tightening any retaining ring beyond the point where it should finally rest. If the definition of an instrument has deteriorated since its repair, it is probable that a retaining ring is too tight or an optical element is not in its proper position (par. 36).

51. Sealing and Cementing

a. General. The purpose of sealing optical instruments is to prevent the entrance of foreign matter into the optical or mechanical system of the instrument, such as water, moisture, dust, fungus, or mold. These corrode parts, obscure the optical path and interfere with operation of mechanical parts. External optical elements, cells, joints, and screw heads must be sealed airtight and water-tight in order to provide protection for all internal optical elements and, at the same time, must be fairly easy to disassemble. It is, therefore, necessary that the sealing compound be removable under conditions that are not injurious to the components of the instrument. In addition to the compounds listed below, paint also acts as a sealing material.

b. Sealing and Cementing Materials.

- (1) Optical lens sealing compound is for sealing all eyelenses and objective lenses within their cells, and for sealing between metal parts such as binocular body covers and body, binocular objective shields, and eyepieces of binoculars. Refer to ORD 3 SNL K-1 for requisitioning information on sealing and cementing materials.
- (2) Plugging or sealing cement is for sealing all set screw holes over countersunk fillister-head screws, and for sealing closed holes where hiding or filling is necessary.
- (3) Instrument lubricating grease is a lubrication agent (par. 47).
- (4) Orange shellac varnish is for cementing screws, cells, and other metal parts in place.
- (5) Synthetic rubber is for cementing prisms to prism shelves.

c. Sealing Procedures.

- (1) **Lenses.** All external lenses, such as eyelenses and objective lenses of binoculars, must be sealed with sealing compound for optical lenses. The actual sealing process may be accomplished effectively in several ways:
 - (a) One method is to heat the compound to a liquid state and apply it with a brush to the seat of a heated cell. Both the cell and the compound can be brought to the proper temperature by placing on a hot plate 17-H-7875 (fig. 16) at about 300° F. The compound thus remains fluid due to the heat of the cell, while the lens is being installed in the cell. The lens may then be brought to bear on the cell seat by installing the lens retaining ring or by using a special fixture (fig. 28). After the lens has been seated, the excess sealing compound must be wiped off with a clean cloth. When the assembly cools, the lens is solidly sealed in the cell.
 - (b) Another method is to form the compound into long strings or "spaghetti." The string can be made by using a sealing compound applicator (fig. 28) and gun (par. 49) (fig. 31) with about a 1/16 or 1/32-inch tip opening. The size of the string will vary according to where it is to be used. The sealing compound must be heated and softened in the gun so that it will flow from the tip. If it is desired to make up a quantity of strings, prepare a lightly greased sheet of heavy paper or thin sheet metal on which to place the strings. The grease helps to prevent sticking (but must not be allowed to get between optical elements). To apply the string, merely take a piece long enough to go completely around the inside of the cell and lay it on the cell seat. Heat the cell on a hot plate to allow the compound to flow into all corners. Insert the lens and push out the excess compound by applying pressure with the retaining ring. The compound that is forced out can then be wiped off with a clean cloth. Through experience and care in applying the correct amount of sealing compound, it is possible to seal a lens without forcing any excess compound onto the lens surface.
- (2) **Screw threads and screws.** The sealing of screws may be divided into sealing of the head and sealing of the threads. The sealing of the head applies to recessed setscrews, flat-head screws, and fillister-head screws. Sealing is necessary to keep out moisture and also to

hide the screw, thus protecting it from any tampering by unauthorized personnel and for revealing tampering that may occur. The material used for this purpose is sealing and plugging cement. It is usually applied with a 1/16-inch flat spatula. For very small setscrew holes, a needle probe is used in order to prevent the formation of air bubbles. Screw threads must also be sealed to prevent the entrance of moisture into the instrument itself. Instrument lubricating grease can be used for this purpose and is applied with a small, round camel's-hair brush to form a thin film on the male threads only. Avoid excess grease, as it will ball up and push into the instrument. Under no circumstances should a permanent sealing compound, such as orange shellac, be applied directly to the threads, as it will prevent removal of the screw. Screw heads are cemented when a drop of shellac is placed on the bottom surface of the head before installation. This accomplishes the double action of cementing and sealing. All screws previously cemented should, therefore, be cemented again at assembly.

- (3) *Other assemblies.* The best method of sealing metal-to-metal parts, other than screws, is achieved through the use of sealing compound for optical lenses in "spaghetti" form. One of the mating parts usually has a ledge or shelf on which the compound may be applied. This part should be just warm enough to keep the compound sticky but not fluid while it is being assembled. In some cases, such as the sealing of a binocular objective cell, first apply the "spaghetti" around the cell. Then, using a flat, heated tool, melt and smooth out the compound until it flows into the cracks and is spread evenly. Care must be taken at any point where the seal opens directly into the optical system of an instrument, as too much compound will squeeze out to a featheredge within the instrument and, upon becoming cold, break off, and fall on the optical elements.

52. Touch-Up Painting

Where paint has been chipped or worn off, dirt or moisture may enter the instrument, or corrosion or rust may develop. Before touching up these spots, make sure that all dust and rust have been removed. The spot should be thoroughly sandpapered all the way out into the good paint. Be sure that no rough edge is left around the spot. Select paint of the same color and apply with a soft brush (TM 9-1861 and TM 9-2851).

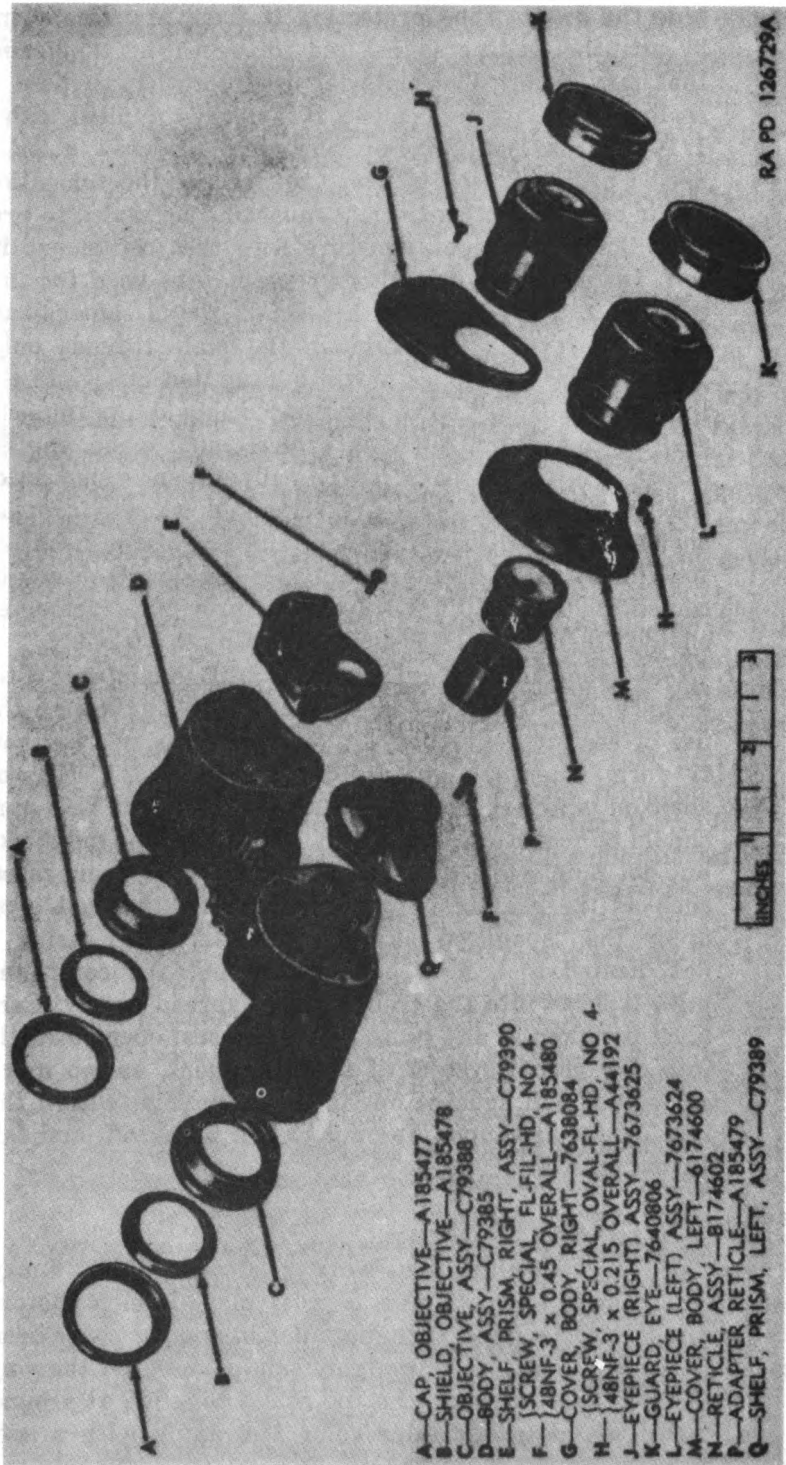

Figure 44. Binocular M3 — exploded view.

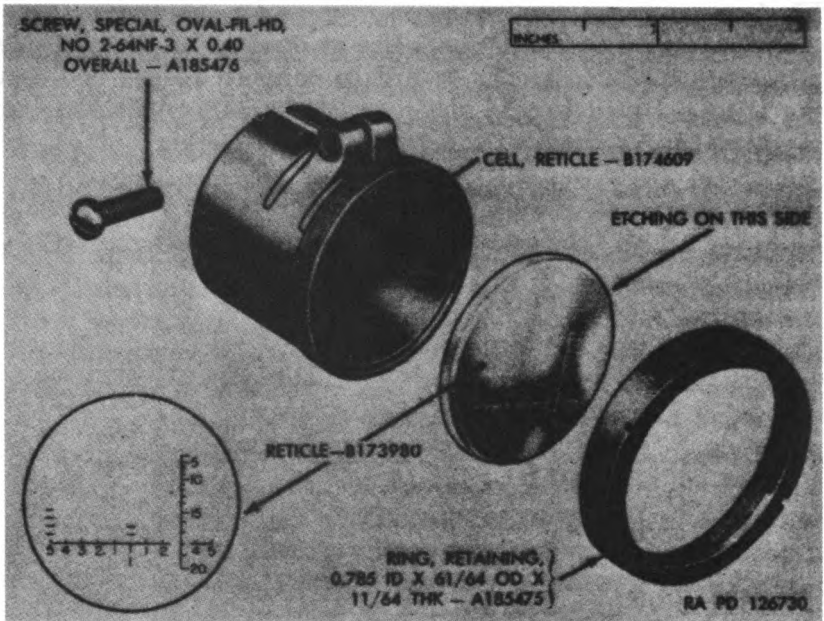

Figure 45. Reticle assembly — B174002 — exploded view.



Figure 46. Prism shelf assembly — C79389 (left) or C79390 (right) — exploded view.

53. Carrying Cases

Clean cases with saddle soap. Use as directed on the container. If seams become loose due to broken threads, resew, and carry the stitching well beyond the point of breakage. Moisture and moldproofing compound is used for treating leather.



Figure 47. Removing or installing reticle adapter A185479 with wrench 41-W-3746-500.

Section II. REBUILD OF BINOCULAR M3

54. General

Organizational maintenance of the binocular M3 is described in TM 9-575. Preventive maintenance services, care in handling, lubrication and cleaning of mechanical parts, cleaning optical parts, organizational spare parts, tools, and equipment, and serviceability tests are included in TM 9-575. This section contains maintenance procedures which are beyond the scope of organizational maintenance.

55. Preliminary Inspection

The serviceability of binocular M3 should be determined as described in paragraphs 29 and 30.

56. Disassembly

a. Remove Eyepiece Assemblies, Body Covers, and Desiccators (fig. 44). Unscrew the eye guard from the eyepiece assembly. Unscrew the eyepiece assembly from the body. Remove the two

screws securing each body cover and pry off the covers. Remove and discard the desiccators.

b. Remove Reticle Assembly.

- (1) If inspection (par. 30g) indicated that the reticle is vertical before disassembly, scribe marks on the reticle retaining ring will indicate proper relation of parts for correct assembly and adjustment. Proper alinement of marks made prior to disassembly will make the reticle approximately vertical and require very little final adjustment (par. 64).
- (2) Loosen the screw which clamps the reticle cell (fig. 45) and remove one screw (adjacent to the reticle adapter) which secures the adjusting key (fig. 46) to the left prism shelf assembly. Pivot the key to one side about its other attaching screw; turn the reticle assembly slightly counterclockwise to clear the projections of the body and slide the assembly off of the reticle adapter (fig. 44). Unscrew the adapter from the prism shelf assembly, using wrench 41-W-3746-500 (fig. 47).

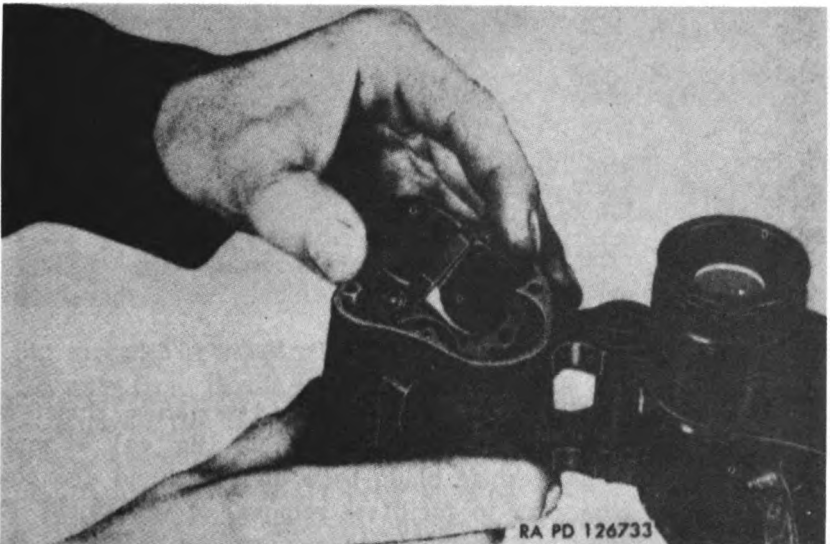

Figure 48. Removing or installing prism shelf assembly.

c. Remove Prism Shelf Assemblies. Remove the three large flat-fillister-head screws which secure the prism shelf assembly to the body assembly (fig. 44). Grasp the upper prism with the

thumb and forefinger across the upper prism clip. Raise the prism shelf assembly until the locating pins are freed. Lift the assembly by raising the outside edge of the shelf (fig. 48) until the shelf clears the outside body lug. Lift the prism shelf assembly the rest of the way out. Do not force the assembly during this operation as there is danger of chipping the prism. Install the prism shelf assembly on a suitable holder. Inspect the prisms for breakage or obvious optical defects. If the prism shelf assembly is to be disassembled, cleaning may be deferred; if not, clean off dust from the optical surfaces of the prisms with a suction hose (par. 46 and fig. 42).

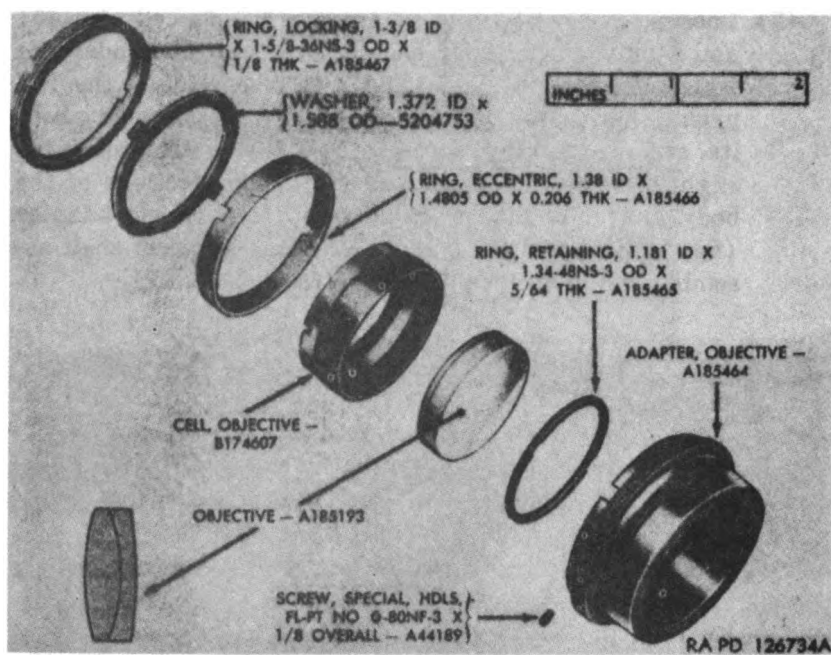

Figure 49. Objective assembly C79388 — exploded view.

d. *Remove and Disassemble Objective Assemblies.* Unscrew the objective cap. Remove the objective shield (fig. 44). It may be necessary to slide a knife blade between the shield and the objective cell locking ring to facilitate removal of the shield. It is neither necessary nor desirable to remove the objective assembly as a unit because of the difficulty of removing the objective adapter from the body. Consequently, remove the parts of the objective assembly (fig. 49), leaving the adapter in the body. Remove the two screws which lock the objective retaining ring and eccentric ring. Using wrench 41-W-3726-170 (figs. 17 and 50), remove the retaining ring. Remove the objective cell

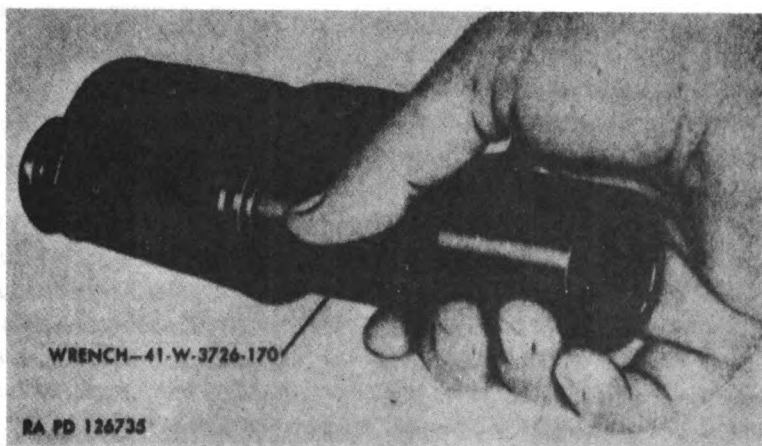
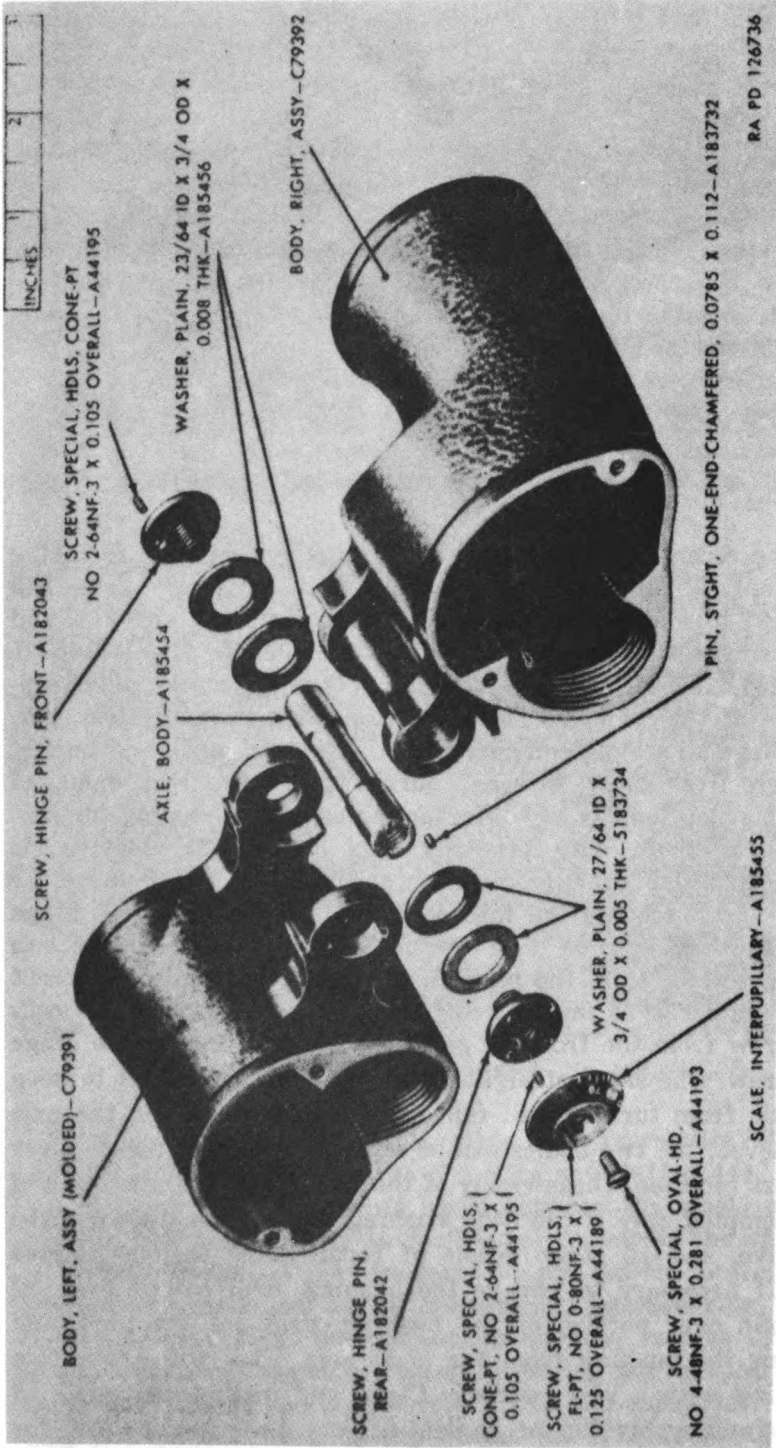

Figure 50. Using wrench 41-W-3726-170 to remove objective retaining ring.

and the eccentric ring. Remove the objective adapter from the body, only if damaged, applying heat from hot plate 17-H-7875 (fig. 16) to soften the sealing compound (pars. 43, and 51), and then using a suitable strap wrench 41-W-3382 or 41-W-3385-25 (fig. 15). Inspect the objective for scratches, cracks, dirt, separation of the cemented elements, etc. Clean the objective (par. 46). Clean all sealing compound from the metal parts and inspect for defective screw threads, burrs (par. 48), and damaged wrench slots. Remedy any defect found before proceeding further.

e. Disassemble Body Assembly (figs. 51 and 52). Remove the headless special screw from the interpupillary scale. Remove the screw which secures the interpupillary scale to the rear hinge pin screw and remove the interpupillary scale. Remove the two locking screws from the rear hinge pin screw. Scribe the front hinge pin screw to the flange of the left body. Remove the locking screw from the front hinge pin screw and remove the hinge pin screw. The small straight locking pin which is used to keep the axle from turning will fall out at this time. When the axle is removed, the two bodies can be separated and the nickel-silver washers removed. Disassembly of the right body assembly should be attempted only if the body bushing (fig. 52) is known to be defective, and all other means of repair have been attempted first. If necessary to remove the bushing, drill out or turn off the spun over portion of the bushing, drill out the pins, and unscrew the bushing from the body lugs. This will necessitate replacing with a new bushing. Clean and inspect the parts of the body assembly for mechanical defects. Look particularly for burrs on the body axle and on the washers. Remove burrs from



RA PD 126736

Figure 51. Body assembly C79886 — exploded view.

the washers with a fine oilstone (par. 48); remove burrs from the axles by lapping (par. 49).

f. Disassemble Eyepiece Assemblies (fig. 53). Remove the screw which locks the diopter scale clamping ring to the eyepiece cell and remove the ring. Lift off the diopter scale. Unscrew the stop ring from the eyepiece adapter. Slowly unscrew the eyepiece cell from the adapter until the point of disengagement of the threads is reached. At this point, place a mark on the cell to line up approximately with the index on the adapter. This mark will assist in locating the proper engagement for the multiple threads of cell and adapter at reassembly. Lift out the cell. Remove the ring, field lens, separator, and eyelens from the cell. Mark the lenses in accordance with the instructions of paragraph 40. Clean and inspect the field and eyelens. Remove all old grease from the threads of the adapter and cell and inspect for burrs or other defects. Lubricate the threads of the cell (par. 47) and temporarily install the cell in the adapter. If the cell has rough movement or binds in the adapter, lap the threads of cell and adapter together (par. 49). Clean and relubricate the parts. If the cell is too loose for proper operation, replace both cell and adapter.

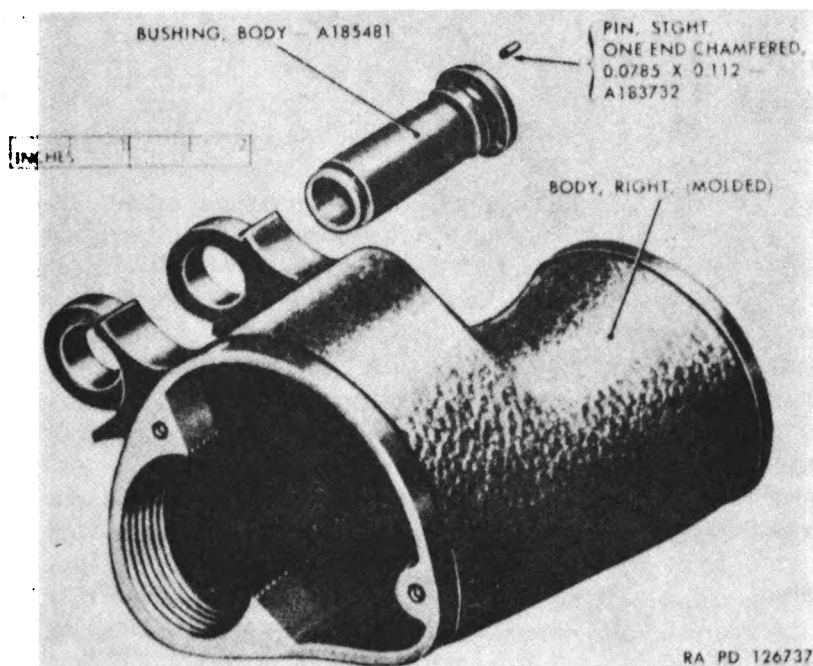

Figure 62. Right body assembly C79398 — exploded view.

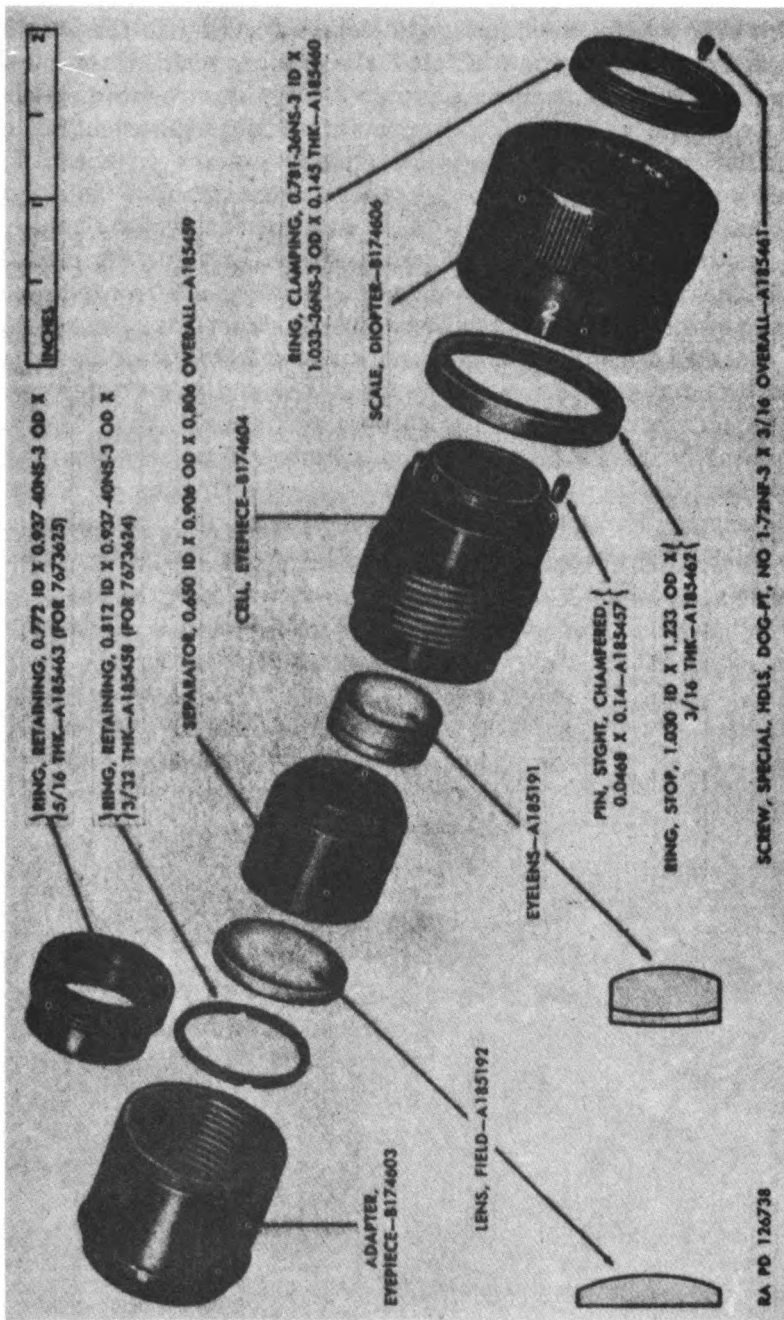

Figure 68. Eyepiece assembly 7673624 (left) or 7673625 (right) — exploded view.

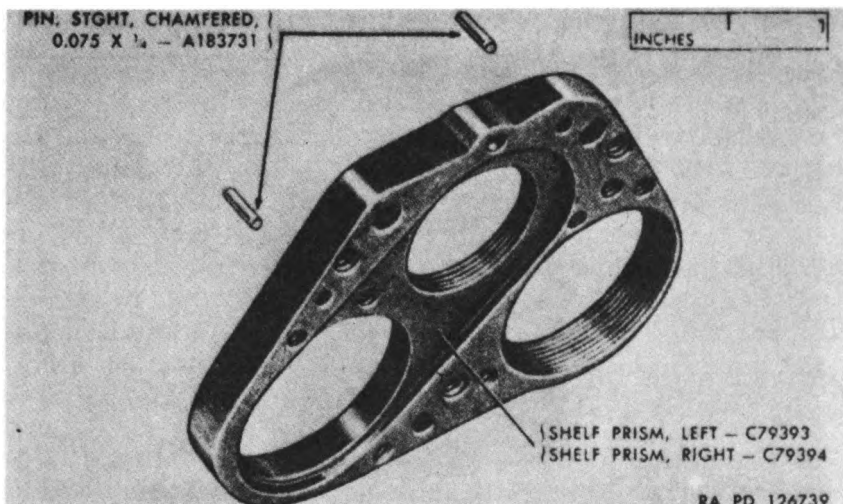

Figure 54. Stripped prism shelf assembly (left or right) — exploded view.

g. Disassemble Reticle Assembly (fig. 45). Scribe a mark on top of the reticle retaining ring to line up with the left end of the horizontal mil scale of the reticle; continue this line down onto the cell. Using wrench 41-W-3746 (fig. 14), unscrew the retaining ring and remove the reticle from its cell. Remove the screw from the cell. Clean and inspect the parts.

h. Disassemble Prism Shelf Assemblies (figs. 46 and 54). Mark the prisms as described in paragraph 40. In addition, mark the outside edge of each prism with indelible pencil and scribe a corresponding mark on the prism shelf. If prism wire is used, remove the four screws which secure the prism wire to the prism. Remove the two screws which secure the prism clip to the shelf. Remove the prism clip, prism clip pad, shield, prism, and prism wire. Discard the prism wire and attaching screws; the prism will be cemented to the shelf on reassembly. If the prism is cemented to the shelf with synthetic rubber cement, scrape and remove as much of the cement as possible. Apply technical benzol to the remaining cement and allow to stand for 30 minutes. Then apply reciprocating pressure to both sides of the prism to loosen it. If the prism still cannot be removed, strike the prism sharply on the side with a small rawhide mallet. Because of the damage that may occur, this method should be used only when other methods have failed. Use the same procedure to remove the remaining prism. From the left prism shelf assembly only, remove the reticle adjusting key. Only if necessary, press the pins from the prism shelf. Clean and inspect the prisms and the shelf. Take care to remove all old cement from the prisms.

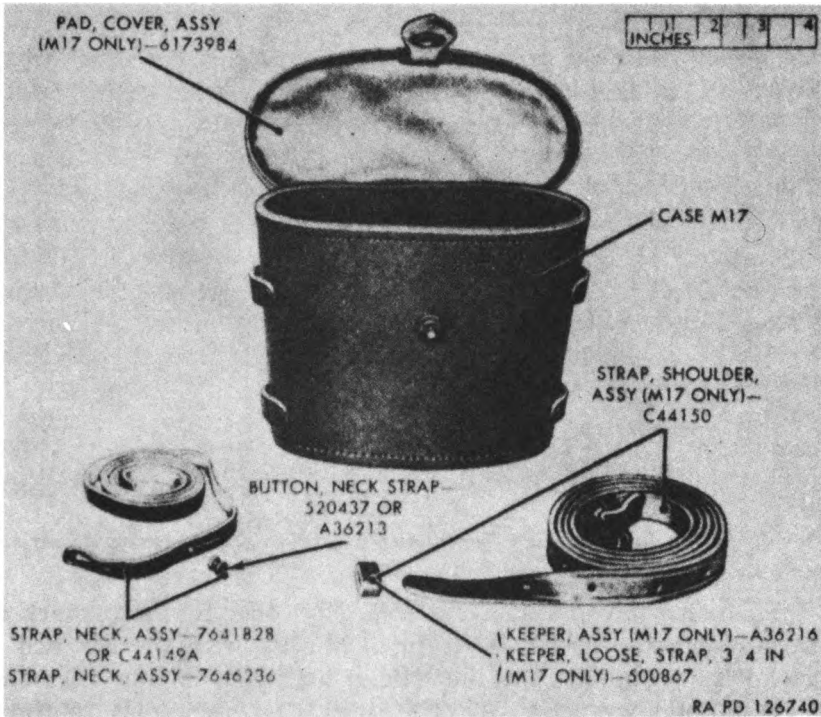

Figure 55. Maintenance parts for carrying cases M17 and M62.

57. Rebuild of Equipment

a. Neck Straps Assemblies. Inspect the neck strap assembly (fig. 55). If the leather of the strap is torn or otherwise defective, replace the entire assembly. If the neck strap button is missing, or defective, install a new button in the slit of the strap assembly (fig. 55). Refer to paragraph 30p.

b. Shoulder Strap Assembly. If the leather of the shoulder strap assembly of carrying case M17 is torn, broken, or otherwise defective, replace the entire shoulder strap assembly. If the strap loose keeper (fig. 55) is missing or defective, replace with a new one. Refer to ORD 8 SNL F-210.

c. Carrying Case M17. Inspect the cover pad assembly (fig. 55). If the cover pad is torn or otherwise defective, or not firmly attached, cement a serviceable pad assembly in place inside the case cover.

d. Carrying Case M62 (fig. 7). No maintenance is authorized, except for the neck strap ((a) above).

58. Assembly

a. Assemble Body Assembly (fig. 51). Lubricate the axle and brass washers with instrument lubricating grease. Install as many brass washers as necessary to take up all play between the flanges of the bodies.

Note. The washers having holes with the larger diameter must be placed between the flanges next to the interpupillary scale.

Insert the axle through the flanges of the bodies from the eyepiece end of the binocular and in alignment with drill hole for small steel pin. Place the flanges of the objective end of the instrument on a level surface and, using thumb pressure press the axle into position.

Caution: Be sure the washers are properly centered before positioning the axle.

To secure the axle in place, place the straight pin in position and tap in place with a small punch and a light hammer. Insert the front and rear hinge pin screws. Final adjustment of the hinge movement is made by tightening the front hinge pin screw.

Note. If the original holes in the hinge pin screws cannot be lined up, drill new holes in the flanges using a No. 50 drill.

Secure the front and rear hinge pin screws with their setscrews. At this point, the hinge should be tight enough to maintain any interpupillary setting through normal handling (par. 30*k*). If the hinge has rough movement, it may be caused by burrs on the washers or axle. Disassemble the body assembly once more and remove all burrs from the washers with a fine oilstone (par. 48). Assemble the body assembly and adjust hinge pin screws for correct tension. If this does not correct for loose movement, the tapered bearing surfaces of the body assembly may be worn. Use swage blocks, if available, to close the body bushing to provide a smaller opening for the axle. If this still fails to correct the condition, remove the bushing (par. 56*e*) and pin of the right body assembly (fig. 52). Install a new bushing, with the flanged end of the bushing at the objective end of the body. Spin over the end of the bushing at the eyepiece end of the body, drill a new hole for the pin, and pin to the flange at the objective end, pressing the pin in flush. Ream the bushing to fit the axle. Reassemble the body assembly as described above and set the interpupillary scale on the rear hinge pin screw. Install the large screw which secures the scale to the rear hinge pin screw. Final adjustment of the interpupillary scale will be made when the instrument has been completely assembled (par. 63).

b. Assemble Prism Shelf Assemblies (figs. 46 and 54). Set the porro prism on the shelf, being careful to match the scribe marks made during disassembly. Place the shield, pad, and clip on the

prism and secure all parts with the two screws. Install the other prism in the same manner. Refer to paragraph 60 for adjustment of the prism shelf assembly for tilt.

c. Install Prism Shelf Assemblies (figs. 44 and 48). Install the prism shelf assembly in the body of the instrument and secure in place with the three fillister-head screws. Inserting the prism shelf assemblies, turn the prism shelf assembly so that the pins in the shelf will line up with their holes in the body when inserted. Then insert the edge of the shelf assembly nearest the hinge, so that it passes under the threaded portion of the body and toward the hinge. Slide the shelf assembly toward the hinge and seat the pins in their holes. Secure shelf with special fillister-head screws.

d. Assemble and Install Objective Assemblies (fig. 44). Place the objective in the objective cell (fig. 49) and secure with the retaining ring. If a new objective or cell is to be installed, the objective lens seat may be bored in depth in steps of 0.012 inch from a minimum dimension of 0.348 to 0.456 inch to suit variations in focal length and thickness of objectives. The depth of bore for seating the objective is to be a minimum of 0.348 inch for spare parts. Interchangeability of right and left objective cells is not essential. Place the eccentric ring on the cell. Install the objective cell, objective, and eccentric ring in the objective adapter. Check that MWO ORD F210-W2 has been applied. It provides for a 1.372 ID x 1.588 OD washer (fig. 49) so as to prevent rotation of parts when the locking ring is tightened after collimation adjustment. Secure with the locking ring. If the objective adapter (fig. 49) was removed from the body, install the assembly in the body, sealing the adapter to the body.

Note. The cell, eccentric ring, and locking ring must not be sealed until the binocular has been collimated (par. 65).

e. Assemble and Install Reticle Assembly. Place the reticle on the reticle cell (fig. 45). Secure the reticle with the retaining ring. Aline the scribe marks on the cell and retaining ring with the left end of the horizontal mil scale of the reticle (par. 56g). Install the reticle adapter (fig. 44) in the left prism shelf using wrench 41-W-3746-500 (fig. 47), making sure that the scribe marks on the adapter and the prism shelf are in alinement. Slide the reticle assembly into place on the adapter. Set the key in place on the prism shelf assembly and secure with the two special screws (fig. 46). Tighten the reticle cell clamping screw (fig. 45). Eliminate tilt of reticle as described in paragraph 64.

f. Install Body Covers. Place a light coating of sealing compound (par. 51) around the inside of the body cover. Place the cover in position on the body and press down firmly. Secure cover

with the two screws (H, fig. 44).

g. Assemble and Install Eyepiece Assemblies (fig. 53). Clean and install the eyelens, separator, and field lens in the cell in the order named, following the markings made at disassembly (par. 56f). Secure with the retaining ring. Lubricate the external threads of the cell with instrument lubricating grease. Install the cell in the adapter. Screw the stop ring onto the adapter. Install the diopter scale and secure with the diopter scale clamping ring. Install the screw which locks the diopter scale clamping ring in place. Apply sealing compound around the shoulder of the eyepiece assembly (par. 30n) and screw the eyepiece assembly into the body. At this time, examine the eye guard (fig. 44). If the eye guard does not have a groove around its periphery for accomodation of filter M1, MWO ORD F210-W1 has not been applied. Apply the modification work order by discarding the old eye guard B174605 and installing a new eye guard 7640806 (fig. 44) in its place. This step completes assembly of the binocular.

Section III. TESTS AND ADJUSTMENTS

59. Definition of Field of View and Proper Diopter Setting

If inspection shows that the diopter scale does not indicate zero within one-quarter diopter, with the field of view sharp and clear, as viewed through a collimating telescope, adjust as follows: using a collimating telescope 18-T-540-250 to sight into the instrument, focus the eyepiece until objects beyond 200 yards appear sharp and clear. Remove the eye guard. Remove the locking screw from the diopter scale clamping ring and loosen the clamping ring. Shift the diopter scale until it reads zero. Reassemble and repeat test. Refer to table IV for additional causes of poor definition if this adjustment fails.

60. Tilt of Field of View

a. Remove the objective assembly, eyepiece and cover and use body as a fixture. To adjust the prism shelf assembly in the instrument, proceed as follows: fasten the field glasses fixture 41-F-2992-150 on adjustable leveling plate (fig. 56) and install the binoculars in the fixture. Place the collimating telescope holder 41-H-2374-125 on the vertical spindle of a surface gage 41-G-372 (fig. 56). Install a collimating telescope 18-T-540-250 (fig. 56) in the holder. Push down on the two pins at the rear of the surface gage and set the gage on the surface plate with the two pins against the back edge of the plate. Adjust the collimating telescope holder so that the collimating telescope is in line with,

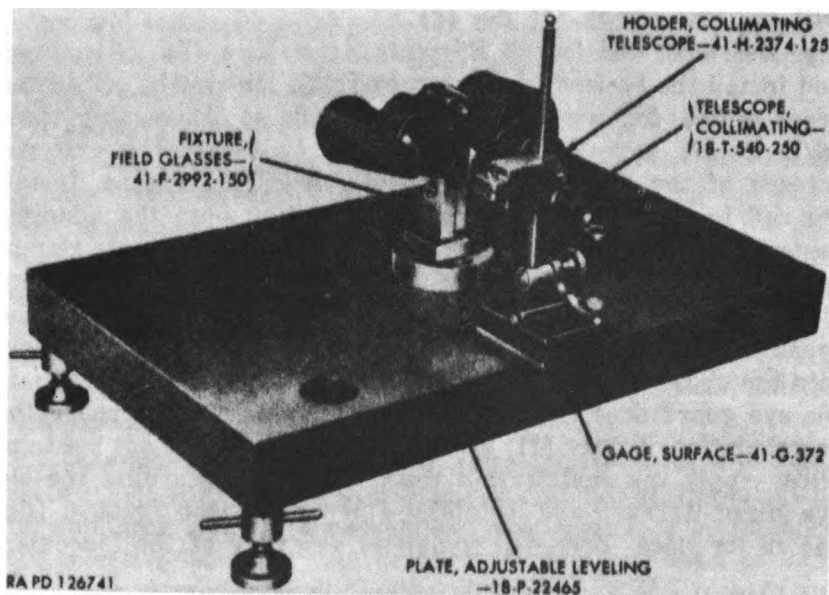

Figure 56. Adjusting for tilt of field of view.

and at the same height as, the aperture in the prism shelf. Slide the surface gage off to one side and rotate the collimating telescope until one of the cross-hairs is superimposed on the plumb line. Slide the surface gage behind the instrument. Sight into the collimating telescope and into the prism assembly. The cross hairs of the collimating telescope should be parallel with the image of the plumb line as seen through the prisms. If the image is tilted in either direction, rotate the prisms slightly to right or left. When the prism has been rotated sufficiently, tighten the adjusting screws equally to lock the prism in place. Recheck that the prism does not move.

b. After adjustment, place the prism shelf assembly on a prism shelf holder, if available, or on some other fixture which will hold the prism shelf level and not touch either prism. Using a metal hypodermic syringe, apply an even but minute quantity of oil resistant synthetic rubber cement, around the prism and on the prism and shelf at the sides. Allow the cement to set for 30 minutes. Take care not to apply any pressure to the prisms until the cement has set.

c. On the left prism shelf assembly only, loosely attach the reticle adjusting key (fig. 46) to the prism shelf assembly with the No. 4 x 0.168 overall special screw. The remaining screw A185471 will be installed when the reticle assembly is installed (fig. 46).

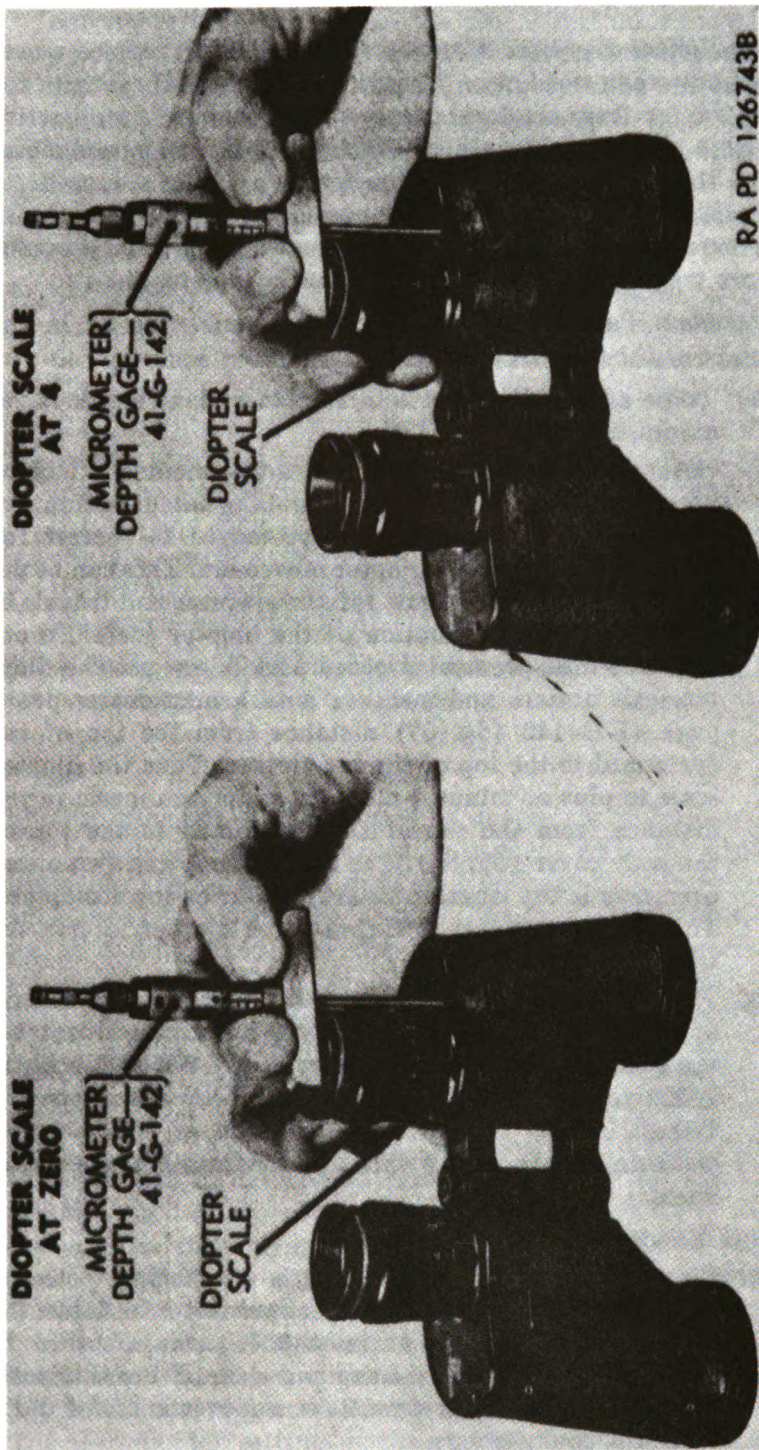

Figure 57. Measuring travel of diopter scale.

61. Parallax and Eyepiece Movement

a. Insufficient Eyepiece Movement. Insufficient eyepiece movement occurs when the image formed by the objective lens is too close or too far from the focal plane of the eyepiece. An objective lens with a short focal length will cause insufficient minus movement of the diopter scale. An objective lens with a long focal length will cause insufficient plus movement of the diopter scale. As a general rule, insufficient eyepiece movement will be encountered only when the optical elements have been replaced.

b. Parallax. Parallax occurs when the reticle does lie in the focal plane of the objective lens.

- (1) These adjustments are interrelated and, if either is required, both should be made.
- (2) Before attempting to make the adjustments, it will be necessary to know how far and in what direction the various optical elements need be moved to correct for parallax and improper diopter movement. This can be determined by knowing how far the eyepiece cell travels in or out for each graduation of the diopter scale. To obtain this measurement proceed as follows: set the diopter scale at zero and measure with a micrometer depth gage 41-G-142 (fig. 57) distance from the top of the eye guard to the top of the body cover. Turn the diopter scale to plus or minus 4 diopters and again measure the distance from the top of the eye guard to the top of the body cover (fig. 57). The difference in the two measurements is the length of travel in inches for 4 diopters. To obtain the travel in inches for 1 diopter, divide the total difference by four.
- (3) For the removal of parallax, the target distance should approach the theoretical infinity for the instrument being adjusted. Theoretical infinity of the 6-x-30 binocular is 351 yards one of the 7-x-50 binocular is 681 yards. Although infinity is preferable, as little as one-half this distance may be used without introducing too much parallax.

c. Left Telescope.

- (1) *Check diopter movement.* Using a collimating telescope 18-T-540-250, sight into the instrument and focus the eyepiece until objects at least 200 yards distance in the field of view appear sharp and clear. From this position, the diopter scale must have a movement of 4 diopters in both directions.

(2) *Adjust to obtain correct diopter movement.* If diopter movement is insufficient in the plus direction, it can be corrected by replacing the objective lens with a lens having a shorter focal length, or by replacing the present objective cell with one having less depth. If diopter movement is insufficient in the minus direction, it can be corrected by replacing the objective lens with a lens having a longer focal length, or by replacing the present objective cell with one having greater depth.

(3) *Eliminate parallax.* Eliminate parallax as follows: Sight into the instrument with a collimating telescope. Focus the eyepiece until the reticle appears sharp and clear. Note the diopter scale reading. If the diopter scale reads plus, it will be necessary to move the reticle away from the eye and field lens. If the diopter scale reads minus, it will be necessary to move the reticle assembly towards the eye and field lens. To move the reticle in either direction, unscrew the left eyepiece assembly and loosen the clamping screw (fig. 45) of the reticle assembly. Slide the reticle assembly in or out as necessary and recheck.

d. Right Telescope. Perform checks and adjustments on right telescope as performed for left telescope (c(1) and (2) above).

62. Stagger

a. General. Stagger is a term used to denote the difference in depth of the eyepieces of a binocular instrument when the focusing movements are set at zero diopter. Excess stagger in an instrument does not reduce the optical efficiency. Mechanically, however, it is difficult to align the instrument with the eyes if one eyepiece is ahead of or behind the other. Stagger must be reduced to less than one-sixteenth inch. Eyepiece stagger may be caused by improper matching of mechanical parts between the two telescopes in relation to the optical elements. Considering that the mechanical and optical values of the elements in the left telescope (fig. 58) are identical to those of the right telescope, stagger will be introduced into the eyepieces by the cell in which the right telescope objective is mounted. This is evident because the right eyepiece "B", figure 58 would have to be advanced toward the objective lens to bring its focal plane into coincidence with the focal plane of the objective lens and thus obtain sharp focus of the image.

b. Procedure. Stagger can be brought within specified tolerances by moving the right objective lens in or out as required to bring the zero diopter setting of the right eyepiece to the same

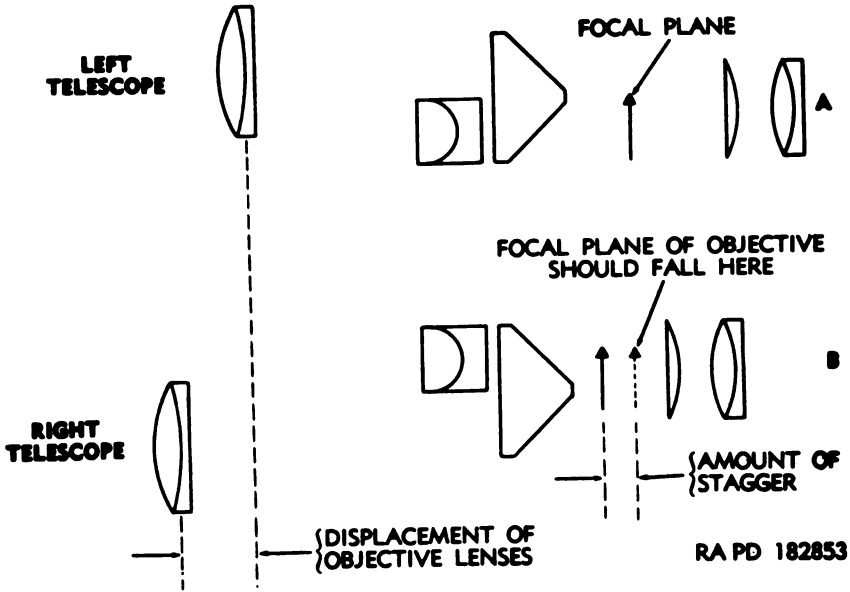

Figure 68. Stagger due to improperly matched objective cells.

plane as the left. After this adjustment is made, it will again be necessary to check for proper diopter movement.

63. Interpupillary Setting

Adjust the binocular bodies so that the distance between the outside of one part of the eyepiece to the inside of the corresponding part of the other eyepiece is 64 mm (2.52 inches). Set the interpupillary scale so that the 64-mm mark is directly opposite the index. Install the interpupillary scale locking screw. If the holes in the interpupillary scale and the rear hinge pin screw do not line up, it will be necessary to drill and tap a new hole in the rear hinge pin screw, using a No. 56 (0.046) drill and No. 0-80NF-3 tap.

64. Tilt of Reticle

a. The reticle of the binocular must be correctly oriented with respect to the field of view when the binocular has been set up in a level position. It is usually most convenient to orient a vertical marking on the reticle to a known vertical line (for example, a plumb line), but the principle and procedure are identical if the adjustment is made with a horizontal marking on the reticle against a known horizontal line.

b. Set the interpupillary scale at 63 mm plus or minus 1 mm. Place the binocular in fixture 41-F-2992-150 (figs. 14 and 59) or

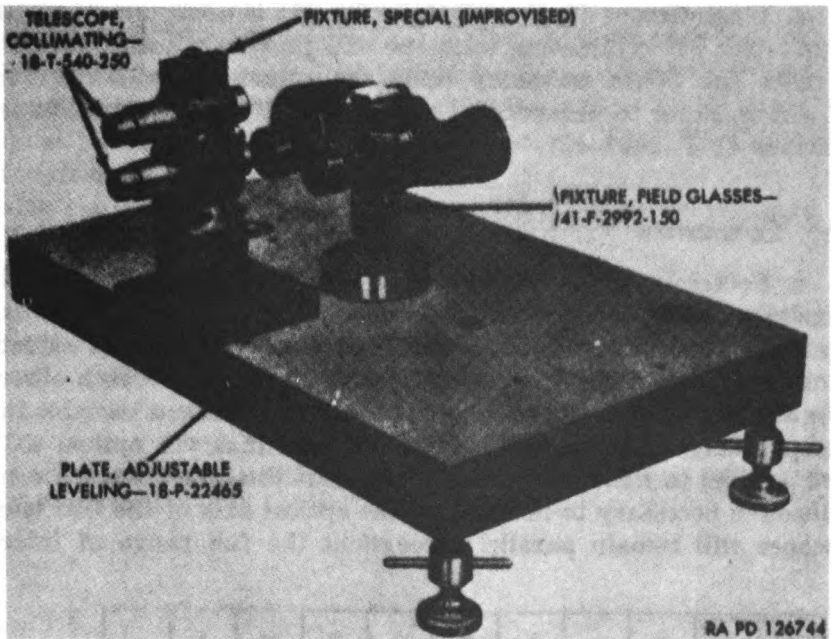

Figure 59. Binocular and improvised fixture in position for collimating at 67-MM setting of interpupillary scale or for checking tilt of reticle.

fixture 41-F-2987-457 (fig. 20). When fixture 41-F-2992-150 is used, level the binocular by placing level 41-L-1176-75 (fig. 14) across the binocular so that it will touch corresponding parts of the two bodies. The adjustable leveling plate should be cross-leveled. Sight through the instrument at a true horizontal line such as a lower edge of a plumb target. Tilt of field (par. 58b) if present, must be eliminated prior to performing this inspection. If the horizontal line of the reticle is not parallel to the line of centers of the two objectives, remove the eyepiece assembly and body cover, loosen the reticle cell retaining ring, and rotate the reticle in the cell, until the horizontal scale of the reticle coincides with the horizontal line. Install body cover and eyepiece, and check again.

c. Another method of inspection using fixture 41-F-2992-150 (fig. 59) is by use of the collimating telescope 18-T-540-250. Tilt of field of view need not be eliminated prior to this inspection when using this method. The collimating telescope in the improvised fixture (par. 19 and fig. 59) or surface gage 41-G-372 and holder 41-H-2374-125 (fig. 56) (depending upon availability of tools) is directed at a plumb-line and rotated until its reticle line is coincident. The collimating telescope is then placed behind the binocular and the same procedure as indicated in *b* above is used.

pupillary adjustment. The actual procedure used to collimate the binocular will depend upon the available tools and test equipment. Two procedures are described in *b* and *c* below. The first is based upon the use of fixture 41-F-2992-150 (figs. 14 and 59), the leveling plate, collimating telescopes, and surface gage. The second procedure, using fixture 41-F-2987-457 (fig. 20), is the more reliable one and should be used whenever this fixture is available.

b. Collimation with Fixture 41-F-2992-150.

- (1) Construct a target similar to that shown in figure 60. A suitable size for the blocks is one-half mil; that is, use the formula: width of a block in inches-target range in yards x 0.018. Draw on paper an exact 5 x 5 duplicate of the target for recording the positions of the optical axis at different interpupillary settings. Cut from stiff card-

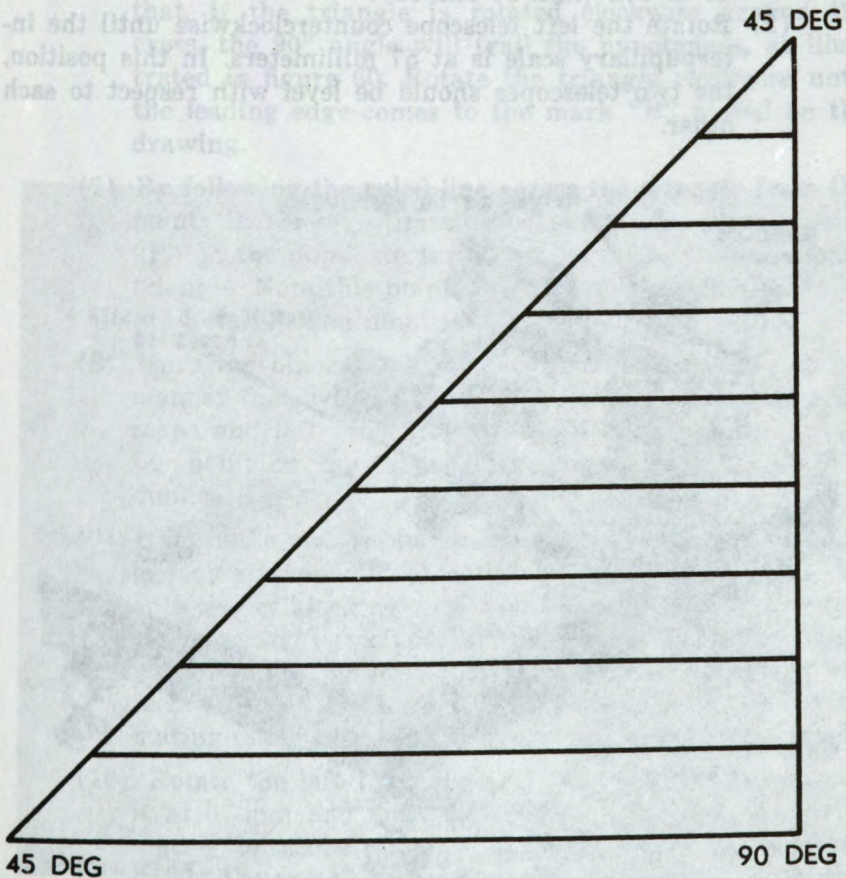

RA PD 182847

Figure 61. Ruled triangle for locating aiming point.

board or a thin transparent material a right isosceles triangle of such size that, when one of the 45° corners is placed at the cross on the duplicate target, the hypotenuse will extend to the farthest corner. For the 5 x 5 duplicate target, the length of the hypotenuse of the triangle should be about $2\frac{1}{2}$ inches. Rule lines across the triangle in the manner indicated in figure 61. Mount fixture 41-F-2992-150 on adjustable leveling plate 18-P-22465. Install two collimating telescopes 18-7-540-250 (fig. 59) in the collimating telescope holders 41-H-2374-125 (fig. 56) and slide both holders over the vertical spindle of surface gage 51-G-372 (fig. 56). Adjust both telescopes so that they are parallel to each other. If the improvised collimating fixture (table III and fig. 59) is available, use this to hold the collimating telescopes instead of the holders 41-H-2374-125 and surface gage 41-G-372 (figs. 56 and 62).

- (2) Rotate the left telescope counterclockwise until the interpupillary scale is at 57 millimeters. In this position, the two telescopes should be level with respect to each other.

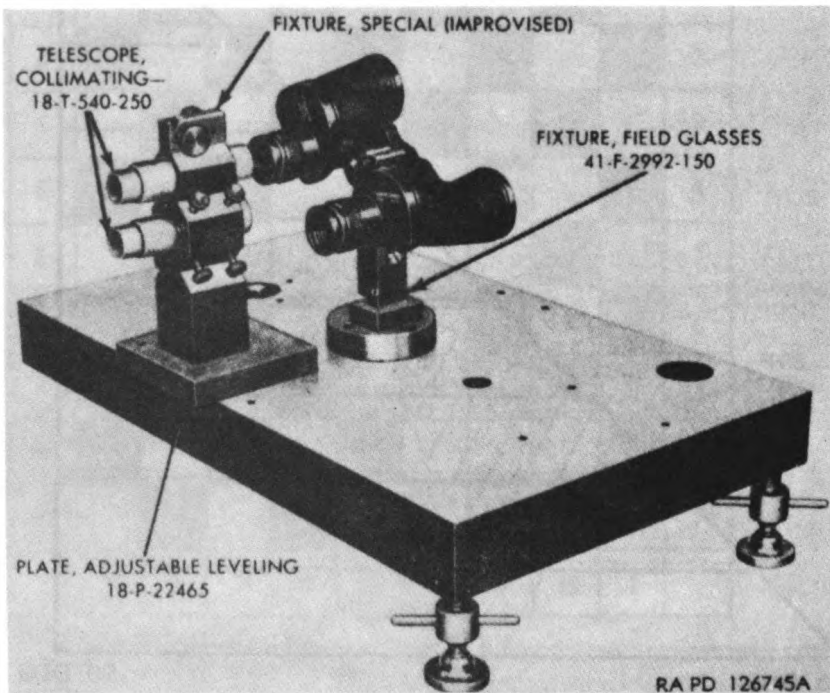

Figure 62. Binocular and improvised fixture in position for collimating at 74-MM setting of interpupillary scale.

- (3) While looking through the lower collimating telescope and left binocular telescope (fig. 59), move the support and binocular until the cross-hairs of the collimating telescope fall on the cross of the target.
- (4) Rotate the left telescope until the interpupillary scale is at 74 mm. While looking through the upper collimating telescope and left binocular telescope (fig. 62), note the point on the target where the cross-hair falls. The letter and number indexes on the target will aid in locating this point.
- (5) Mark a "B" on the duplicate target in the same relative place and in the block indicated by number and letter as the point determined in (4) above.
- (6) Place the prepared triangle on the duplicate target with a 45° corner at the target cross and in such a manner that, if the triangle is rotated clockwise around the cross, the 90° angle will trail the hypotenuse, as illustrated in figure 60. Rotate the triangle clockwise until the leading edge comes to the mark "B" placed on the drawing.
- (7) By following the ruled line across the triangle from the point "B," or by estimating between lines, place a point "P" on the duplicate target at the opposite edge of the triangle. Note this point "P" on the target by means of the lettering and numbering system.
- (8) Move the binocular by means of its support in such a manner that, when looking through the collimating telescope and left binocular telescope, the cross-hair is on the point on the target corresponding to "P" on the duplicate.
- (9) Loosen the two screws which secure the objective cell locking ring and the objective cell in place. Unscrew the objective cell locking ring. Sight through the collimating telescope and left binocular telescope. Using wrench 41-W-3740-150 (fig. 65), rotate the eccentric ring and objective cell (fig. 63) until the cross-hairs of the collimating telescope fall on the center of the black diamond.
- (10) Rotate the left telescope until the interpupillary scale is at 57-mm and note, by observing through the collimating telescope and left binocular telescope, whether or not the cross-hair falls on the black circle. If so, the left telescope is collimated, and the objective assembly may now be secured in its proper position. If not, repeat



Figure 83. Rotating eccentric ring and objective cell.

the adjustment procedure until tests in both positions prove that the instrument is collimated. Care must be exercised to prevent the objective from shifting while it is being secured. If there is a shift, collimation will be destroyed. Allowance must be made for such a shift in the collimation adjustment before the objective is finally secured.

- (11) When the left telescope is collimated and the binoculars set at the 57-mm setting, move the collimating telescope and look through the collimating telescope and right binocular telescope. Rotate the objective cell and eccentric ring until the cross-hair falls within the tolerance rectangle containing the black square. Secure the objective assembly, again being careful that it does not shift. The binocular is now in perfect collimation.
- (12) It will be found in some cases that the line of sight cannot be moved by means of the eccentric ring and ob-

jective cell. Should this happen, it will be necessary to move or change the prisms in the shelf assembly. Refer to paragraph 58*b*. After completion of collimation, install the locking ring and setscrew and seal the objective assembly (par. 51). Install the shield and cap.

- (13) While the binoculars are adjusted by the eccentric rings, consideration must also be given to the porro prism assemblies which are assembled in the binoculars. These prism assemblies must be held with a close degree of accuracy for light deviation, otherwise the eccentric rings will not have sufficient adjustment to properly collimate the binocular. The light deviation of the binocular should be held to within the tolerances indicated in paragraph 30*d*. This will insure that the objective eccentrics will have sufficient adjustment to collimate the binocular.

c. Collimation with Fixture 41-F-2987-457 (figs. 64 and 65).

- (1) *General.* The procedure given in (2) and (3) below requires the use of binocular test fixture 41-F-2987-457. It is the preferred procedure whenever the fixture is available. For a general description of the fixture, refer to paragraph 14.

- (2) *Adjustment of fixture.*

- (a) Since the fixture, when shipped from the manufacturer, will have the collimating and viewing telescopes removed from their housings, these instructions cover the initial setting-up and adjusting operations as well as subsequent adjustment after the fixture has been in operation.
- (b) Remove the lamp housing and viewing telescope housing from the fixture. The lamp housing may be detached from the collimator assembly by removing the two knurled clamping screws shown at the front end of the fixture in figure 20. The viewing telescope housing may be removed by taking out eight socket-head screws under the rear end of the fixture base.
- (c) Place the three collimating telescopes 18-T-540-250 in their housing with the objective ends toward the adjustable platform (fig. 20). The telescopes must be located in the housing so that their reticles will appear as shown on figure 22 when viewed through the eyepiece end of the telescopes. Allow the telescopes to project out of their supporting collars about three-

eights of an inch at the objective end. Insert the clamping shoes under the three setscrews at the ends of each telescope. Move the fixture to a location where a distant target, at 3,000 yards or more, can be observed when looking into the eyepiece end of the collimating telescopes. Adjust the six setscrews holding any one of the three telescopes until it is approximately central with the mounting collars at the ends of the telescope. Adjust the other two collimating telescopes by the setscrews until their optical axes are parallel to the optical axis of the first telescope adjusted. This parallel condition for the three telescopes can be noted when the intersection of the central cross lines on each reticle fall on a common point of a distant target.

Note. Use the large size clamping shoes when assembling the collimating telescopes. The small size clamping shoes are for use with the viewing telescopes.

- (d) Place the fixture on a firm platform or bench where it is to be used for adjustment of binoculars. Assemble the lamp housing and viewing telescope housing to the fixture. Insert the three viewing telescopes in their housing with the objective ends toward the adjustable platform, and projecting out from the supporting collars about one-quarter of an inch. Since the three viewing telescopes are identical, they need not be placed in any special order when assembled in their housing. Insert the clamping shoes at both ends of the telescope and secure them with the setscrews. Plug in the lamp housing extension cord and illuminate the collimating telescope reticles (fig. 22). Place the rhomboid alinement prism over the objective end of one of the collimating telescopes and rotate the prism around the axis of the collimating telescope 18-T-540-250 until the aperture of the prism is lined up approximately with the axis of the mating viewing telescope. While looking into the eyepiece of the viewing telescope, rotate and adjust its alinement with the setscrews until the center cross lines of the viewing telescope coincide with the central cross lines of the collimating telescope. The other two viewing telescopes must be adjusted in the same manner so that the optical axes of all six telescopes on the fixture are parallel to each other. The rhomboid alinement prism should be used frequently, after the fixture has been put into operation to check the alinement

of the viewing telescopes with the collimating telescopes. When any doubt exists about the parallelism of the three collimating telescopes, they should be checked on a distant target as described in (c) above.

(3) Operation of fixture.

- (a) Place a binocular in the inverted position on the adjustable platform so that the hinge pin lugs of the left telescope rest on the mounting adapter of the adjustable platform (figs. 20 and 64). The objective end of the binocular must be toward the collimating telescopes of the fixture while the eyepiece end of the binocular will be toward the viewing telescopes of the fixture. Insert the $\frac{1}{4}$ inch diameter clamping rod and tighten the knurled clamping knob until the binocular is securely fastened (fig. 64). The right telescope of the binocular (left telescope facing the fixture) can now be rotated around the hinge pin axis throughout the entire distance of the interpupillary movement. Swing the right telescope of the binocular down to its greatest interpupillary distance. Rotate the azimuth and elevation adjusting knobs of the adjustable platform until the reticle center of the lower left-hand viewing telescope coincides with the reticle center of



Figure 64. *Installing binocular in binocular testing fixture 41-F-2987-457.*

the lower left-hand collimating telescope. The binocular eyepieces must be rotated to their 0-diopter setting while collimation adjustment is being performed.

- (b) Swing the right telescope of the binocular up to its smallest interpupillary distance and note the relative positions of the reticle centers for the top viewing and collimating telescopes. If the centers of the two reticles coincide, no adjustment will be required on the right objective lens of the binocular since the optical axis of the right telescope will be parallel to the hinge pin axis. If the reticle center of the top viewing telescope does not coincide with the reticle center of the top collimating telescope, the following adjusting procedure should be carried out: using the plotting board and ruled triangle (fig. 21), insert the movable 3/16-inch diameter pin in the nearest hole on the plotting board which corresponds to the location at which the viewing telescope reticle center falls on the checkerboard reticle pattern of the top collimating telescope. Place the ruled triangle flat on the plotting board with its 90° angle inserted between the two pins. The 90° angle must point around the center of the plotting board in a counterclockwise direction. Slide the triangle about until the two pins are contacting the ends of a common ruled line on the triangle. Note the location on the board where the 90° point of the triangle falls. Adjust the azimuth and elevation knobs of the



Figure 65. Using binocular testing fixture 41-F-2987-457 to collimate binocular 58-MM setting of interpupillary scale.

adjustable platform until the reticle center of the top viewing telescope falls on a point of the checkerboard reticle pattern which corresponds to the location of the 90° triangle point on the plotting board. Adjust the objective eccentric rings in the right telescope of the binocular until the reticle center of the top viewing telescope coincides with the reticle center of the top collimating telescope (fig. 65). The optical axis of the right telescope of the binocular will now be parallel to its hinge pin axis.

- (c) Without changing the angle of the adjustable platform, adjust the eccentric rings in the left telescope of the binocular until the reticle center of the lower right-hand viewing telescope coincides with the reticle center of the lower right-hand collimating telescope. The binocular will now be collimated so that when two parallel rays enter its objective lenses, the rays will remain parallel upon emerging from the binocular eyepieces for any setting of the interpupillary adjustment.
- (d) Since a collimation tolerance is permitted (par. 30d), the lower right-hand collimating telescope reticle has a tolerance block at the intersection of the cross lines. This tolerance may be used where necessary, if difficulty is experienced in an endeavor to maintain perfect collimation adjustment.

Note. Excessive light deviation errors in binocular prisms assemblies usually account for difficulties with collimation adjustment. The porro prisms usually have to be changed or shifted to other positions when a binocular cannot be properly collimated (par. 58b).

- (e) After completion of collimation, install the locking ring and setscrew and seal the objective assembly (par. 51). Install the shield and objective cap.

CHAPTER 6

REPAIR AND REBUILD OF BINOCULARS M7 AND M16

Section I. REBUILD OF BINOCULARS M7 AND M16

66. General

Refer to paragraphs 37 through 53.

67. Preliminary Inspection

The serviceability of binoculars M7 and M16 should be determined as described in paragraphs 29 and 30.

68. Disassembly

a. Remove Eyepiece Assemblies and Body Covers (fig. 66). Proceed as in paragraph 56a except take out three screws which secure each body cover.

b. Remove and Disassemble Reticle Assembly (M16 only) (fig. 67). Unscrew the reticle retaining ring using tubular wrench 41-W-3726-105 (fig. 68), and take out the reticle and the spacer. Unscrew and remove the cell.

c. Remove Prism Shelf Assemblies (fig. 66). Remove the prism shelf assemblies as described for binocular M3 (par. 56c).

d. Remove and Disassemble Objective Assemblies (figs. 66 and 69). Unscrew and remove the objective cap. Remove two set-screws from the objective adapter. Using tubular wrench 41-W-3726-295 (2 23/64 inch end) (fig. 70), unscrew the objective assembly retaining ring. Remove the objective cell and the eccentric ring from the adapter. To remove the cell, hold the instrument with the objective end about 1 inch above the bench and tap sharply with the palm of the hand or a rapping stick. In obstinate cases, apply pressure from inside the instrument, protecting the objective lens with padding. Remove the retaining ring from the objective cell with wrench 41-W-3726-255 (fig. 17) and take out the objective. Do not attempt to remove the objective adapter from the body unless damaged. If damaged, apply heat to soften

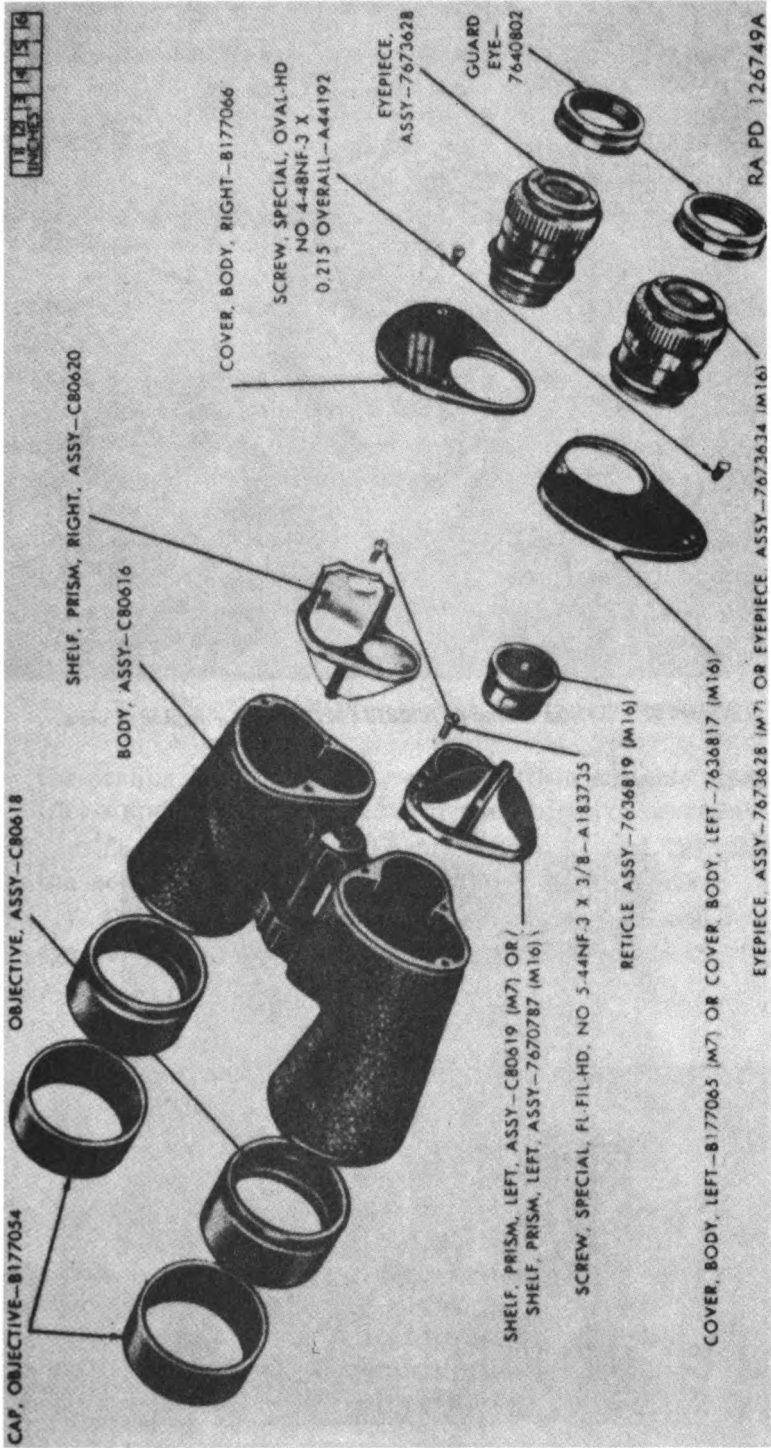

Figure 66. Binocular M7 or M16 — exploded view.

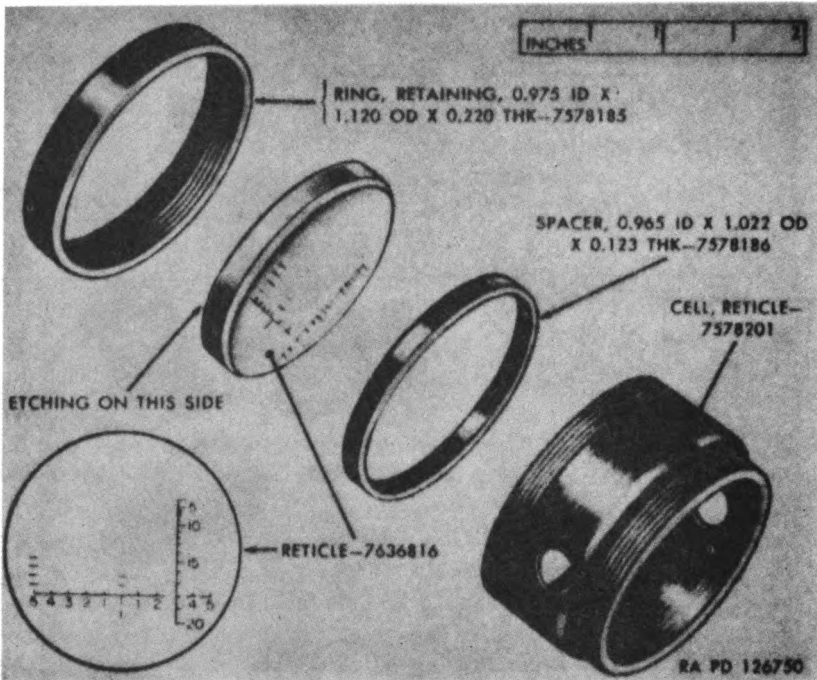

Figure 67. Reticle assembly 7636819 (M16 only) — exploded view.

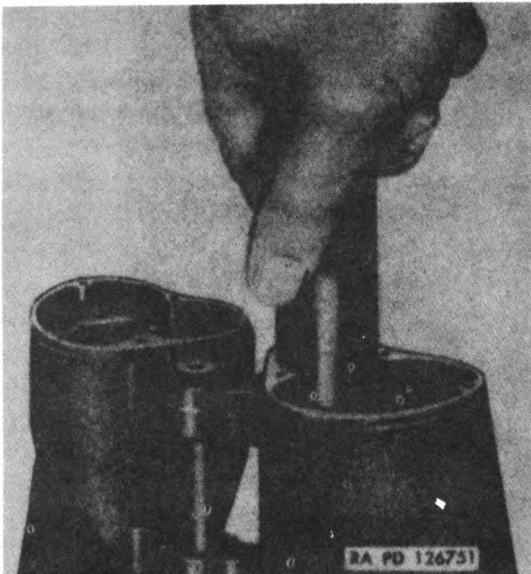

Figure 68. Using wrench 41-W-5726-106 to remove retaining ring (M16 only).

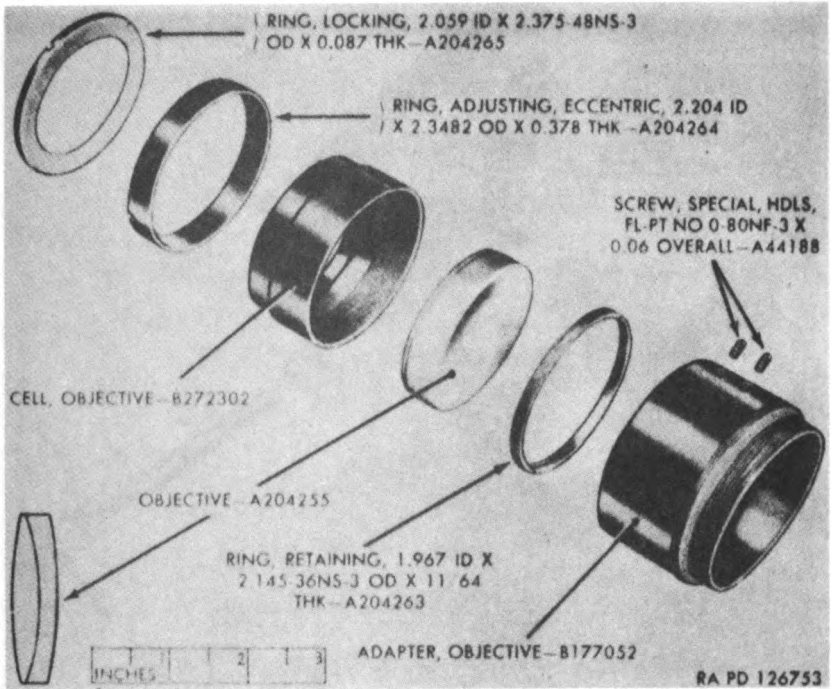

Figure 69. Objective assembly C80618 — exploded view.

the sealing compound and remove with a suitable strap wrench. Clean and inspect the parts of the objective assembly.

e. Disassemble Body Assembly (figs. 71 and 72). Disassemble the body assembly as described in paragraph 56e.

f. Disassemble Eyepiece Assemblies (figs. 73 and 74). Remove eye guards. Remove the headless screw which secures the clamp-

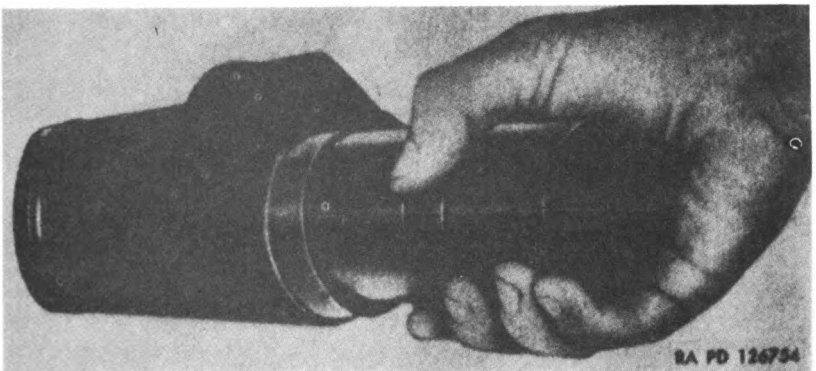

Figure 70. Using wrench 41-W-5726-296 to remove objective retaining ring.

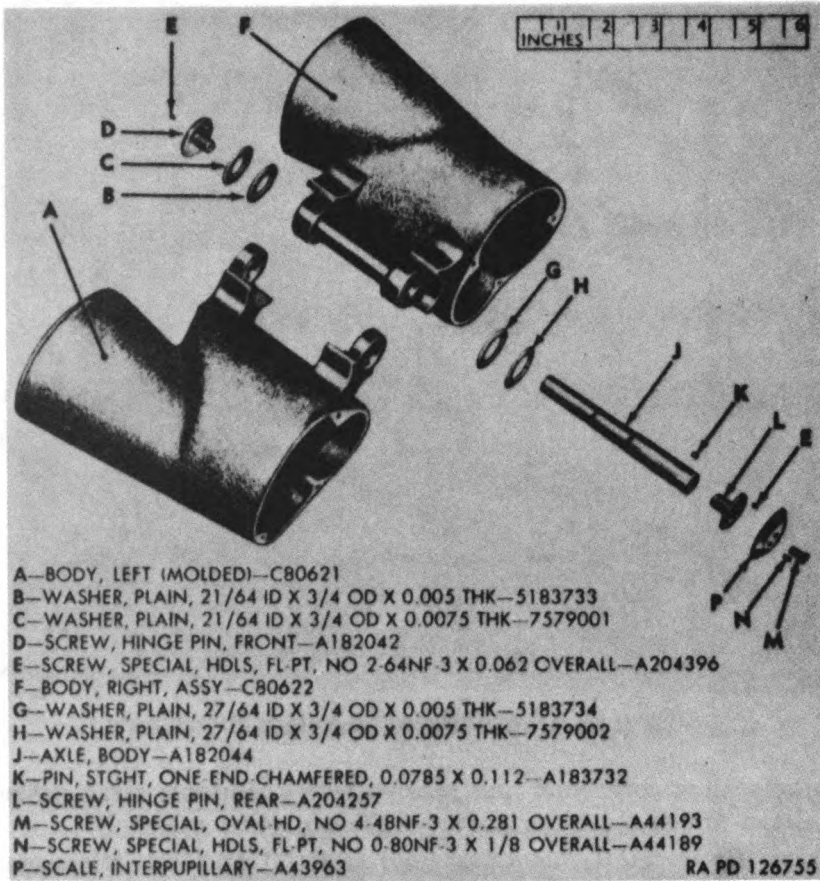

Figure 71. Body assembly C80616 — exploded view.



Figure 72. Right body assembly C80622 — exploded view.

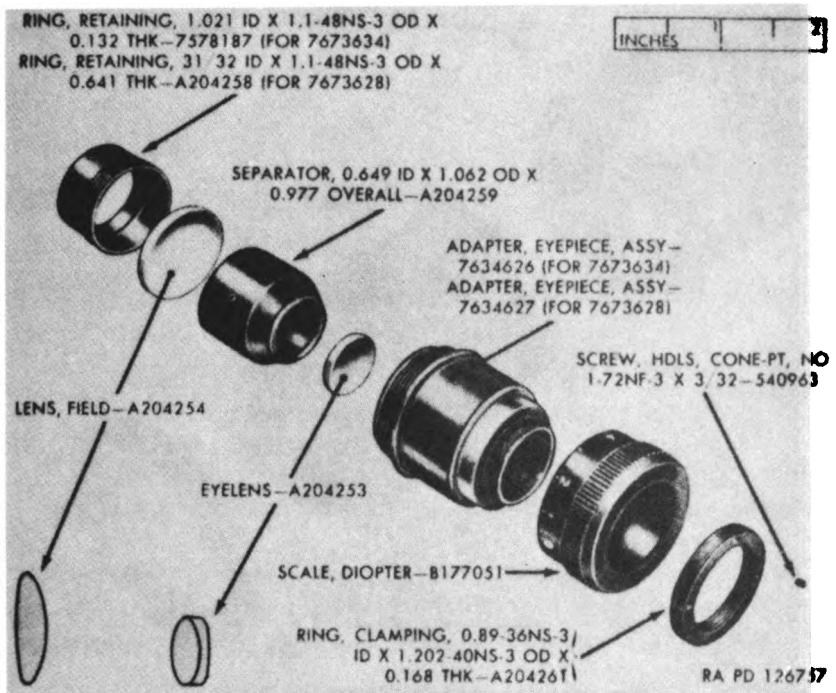

Figure 75. Eyepiece assemblies 7679634 (left, M16 only) and 7679628 — exploded view.

ing ring to the diopter scale. Unscrew and remove the clamping ring using an adjustable pin wrench and remove the diopter scale. Using wrench 41-W-3726-93 (fig. 75), unscrew and remove the retaining ring of the left eyepiece assembly of binocular M16, and remove the field lens, separator, and eye lens from the adapter assembly. The retaining rings of the remaining eyepiece assemblies may be removed by hand. Disassemble the adapter assembly (fig. 74) by removing the ring from the adapter and slowly unscrewing the cell from the adapter until the multiple threads just reach the point of disengagement. At this point, mark the cell to coincide with the index on the adapter and lift off the cell. Clean and inspect the parts as described for the eyepiece assembly of binocular M3 (par. 56f).

g. Disassemble Prism Shelf Assemblies (figs. 76 and 77). Proceed as described for binocular M3 (par. 56h) except remove the two prism clip posts which secure each prism clip to the prism shelf.

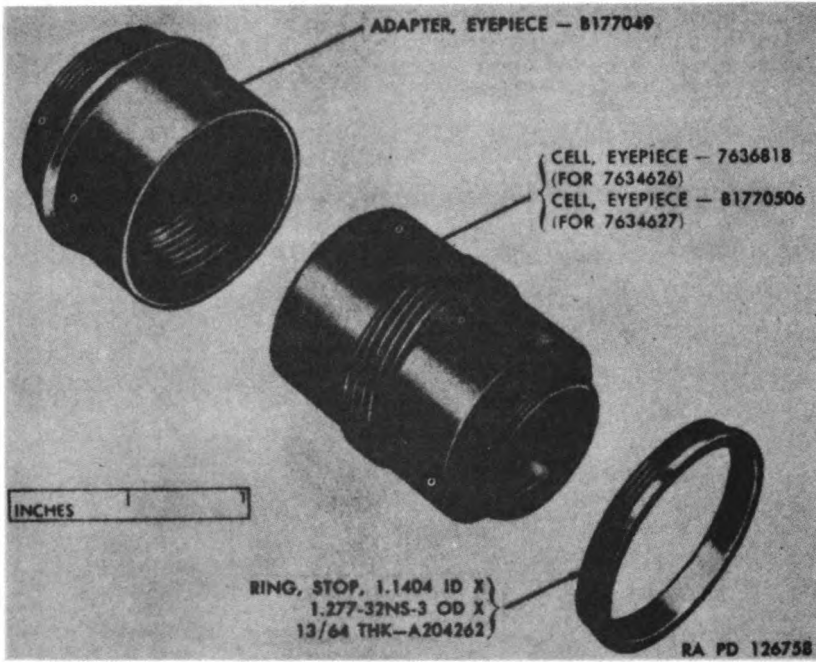

Figure 74. Eyepiece adapter assemblies 7634626 and 7634627 — exploded view.

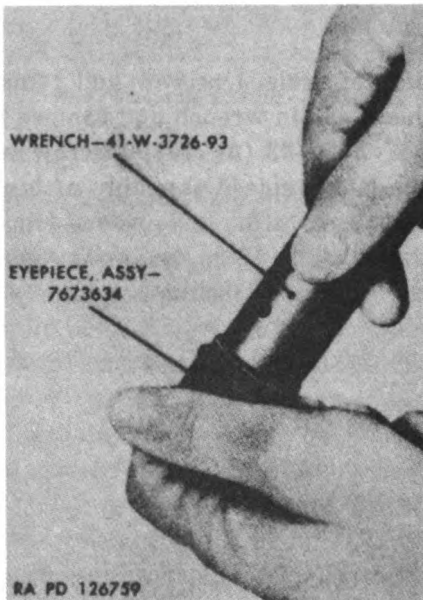

Figure 75. Using wrench 41-W-3726-93 to remove retaining ring of left eyepiece assembly.

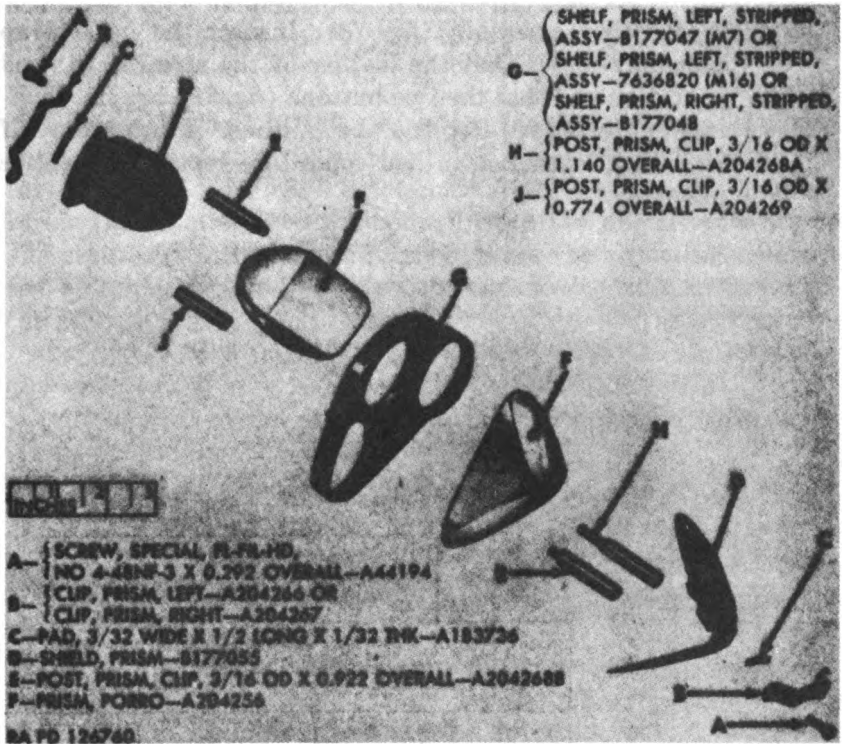

Figure 76. Prism shelf assemblies C80619 (left, M7 only), 7670787 (left, M16 only), C80620 (right) — exploded view.



Figure 77. Stripped left prism shelf assemblies B177047 (M7 only), 7636820 (M16 only), or stripped right prism shelf assembly B177048 — exploded view.

h. Rebuild of Equipment.

- (1) *Neck strap assembly* (fig. 78). Inspect the neck strap assembly to see that the leather of the strap is in good condition and that the two buttons (fig. 79) are not missing or defective. Replace the buttons, if necessary. If the strap leather is in bad condition, replace the entire assembly.

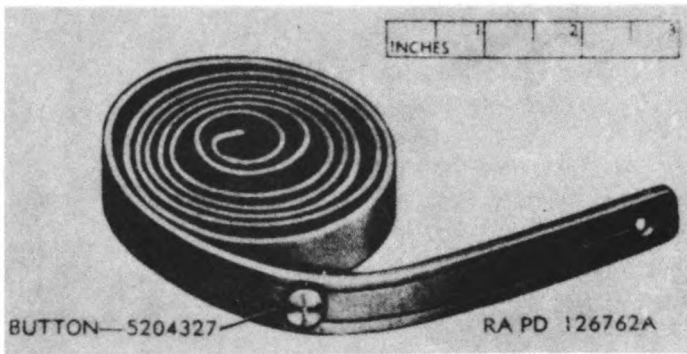

Figure 78. Neck strap assembly B177126.

- (2) *Shoulder strap assembly*. Check the shoulder strap assembly to see that the leather and buckle are in good condition. If not, replace the entire assembly with a serviceable one. If the loose keeper is missing or defective, slip a serviceable keeper on the strap.
- (3) *Carrying case M24*. If the cover assembly is damaged, pry out the four oval-head split rivets which secure the cover assembly in place and take off the assembly. Rivet a new cover assembly in place.
- (4) *Case carrying M44* (figs. 4 and 5). No maintenance is authorized except to the neck and shoulder strap assemblies ((1) and (2) above).

69. Assembly

a. Assemble Body Assembly (figs. 71 and 72). Refer to paragraph 58a.

b. Assemble Prism Shelf Assemblies (figs. 76 and 77). Set the porro prism on the shelf being careful to match the scribe marks made at disassembly. Install the prism clip posts in the shelf. Place the shield, pad, and clip on the prism and secure the clip to the posts with the two screws. Proceed similarly with the remain-

ing prism and its attaching parts. Adjust and cement the prism shelf assembly as described in paragraph 60.

c. Install Prism Shelf Assembly (fig. 66). Refer to paragraph 58c.

d. Assemble and Install Objective Assembly (figs. 66 and 69). If the objective adapter was removed from the body, apply sealing compound (par. 51) between the adapter and the body and screw the adapter into the body. Install the objective in its cell and secure with the retaining ring. Place the adjusting ring over the objective cell and slide the cell with objective installed and the adjusting ring into the adapter. Secure with the locking ring.

Note. Do not seal the locking ring, adjusting ring, and objective cell until the binocular has been collimated (par. 65).

After collimation, install the two No. 0-80 screws and seal the assembly (par. 51).

e. Assemble and Install Reticle Assembly (M16 only) (figs. 66 and 67). Place the reticle spacer in the reticle cell. Install the reticle so that the etched side is toward the eyepiece end of the instrument. Install the reticle retaining ring, making sure that the reticle is alined to the scribe marks made during disassembly. Screw the reticle assembly into the prism shelf assembly making sure that the scribe marks are alined. If a new retaining ring, or other part, has been used so that the old scribe marks are not available for reference, adjust the reticle so that it is vertical when the interpupillary scale is set at 63 mm.

f. Install Body Covers (fig. 66). Proceed as described for binocular M3 (par. 58f) except secure covers with three screws each instead of two.

g. Assemble and Install Eyepiece Assemblies (figs. 66, 73, and 74). Lubricate the threads of the eyepiece cell (fig. 74) with instrument lubricating grease and screw the cell into the adapter. Secure with the stop ring. Place the eyelens, separator, and field lens in the eyepiece adapter assembly (fig. 73) following the markings made at disassembly (par. 40). Install the diopter scale and secure with the diopter scale clamping ring. Install the screw which locks the diopter scale clamping ring in place. Screw the eyepiece assembly into the body (fig. 66). At this time examine the binocular for the application of MWO ORD F238-W1. If necessary apply the modification work order. If the eye guard does not have a groove around its periphery for the accommodation of filter M1, MWO ORD F238-W1 has not been applied. Apply the modification work order by discarding the old eye guard A204260 and installing a new eye guard 7640802 in its place. This step completes assembly of binoculars M7 and M16.

Section II. TESTS AND ADJUSTMENTS

70. Definition of Field of View and Proper Diopter Setting

Refer to paragraph 59. In assembling the clamping ring, spot the diopter scale with a 90° drill point for the cone-point set-screw.

71. Tilt of Field of View

Adjustment for tilted field is made during assembly of prism shelf (par. 60).

72. Parallax and Eyepiece Movement

Proceed as described for binocular M3 (par. 61) except to move the reticle away from the eyepiece assembly; use a thinner reticle spacer between the reticle and the shoulder of the reticle cell. To move the reticle toward the eyepiece assembly, use a wider reticle spacer. Target distance for binocular M16 is 6.81 yards. Therefore, 681.1 = the distance in yards from the telescope at which the target should be placed for the removal of parallax.

73. Stagger

Refer to paragraph 62.

74. Interpupillary Setting

Refer to paragraph 63.

75. Tilt of Reticle (Binocular M16 Only)

Refer to paragraph 64.

76. Collimation

Proceed as described in paragraph 65, except, in using binocular test fixture 41-F-2987-457 (fig. 20), a 9/32-inch diameter clamping rod must be used instead of the 1/4-inch clamping rod when installing the binocular in the fixture (par. 65c(3)). Use wrench 41-W-3746-50 (fig. 15) to rotate the eccentric adjusting ring and objective cell in adjusting the binoculars.

CHAPTER 7

REPAIR AND REBUILD OF BINOCULAR M8

Section I. REBUILD OF BINOCULAR M8

77. General

Refer to paragraphs 37 through 53.

78. Preliminary Inspection

Refer to paragraphs 29 and 30.

79. Disassembly

a. Remove Eyepiece Assemblies and Body Covers (fig. 79). Refer to paragraph 56a.

b. Remove and Disassemble Reticle Assembly (figs. 79 and 80). Mark the position of the reticle in the retaining ring and scribe the retaining ring to the cell and the cell to the prism shelf (par. 39). Unscrew the reticle retaining ring, and remove reticle and spacer.

Note. The parts of the reticle assembly for binocular M3 (fig. 45) are available for binocular M8, together with the necessary attaching parts. Refer to ORD 8 SNL F-210. If these parts have been installed in binocular M8, remove as described in paragraph 56b.

c. Remove Prism Shelf Assemblies (fig. 79). Refer to paragraph 56c.

d. Remove and Disassemble Objective Assemblies (fig. 81). Refer to paragraph 56d.

e. Disassemble Body Assembly (figs. 82 and 83). Refer to paragraph 56e.

f. Disassemble Eyepiece Assemblies (fig. 84). Proceed as described for binocular M3 (par. 56f) except remove the screw which attaches the diopter scale to the eyepiece cell before taking off the diopter scale.

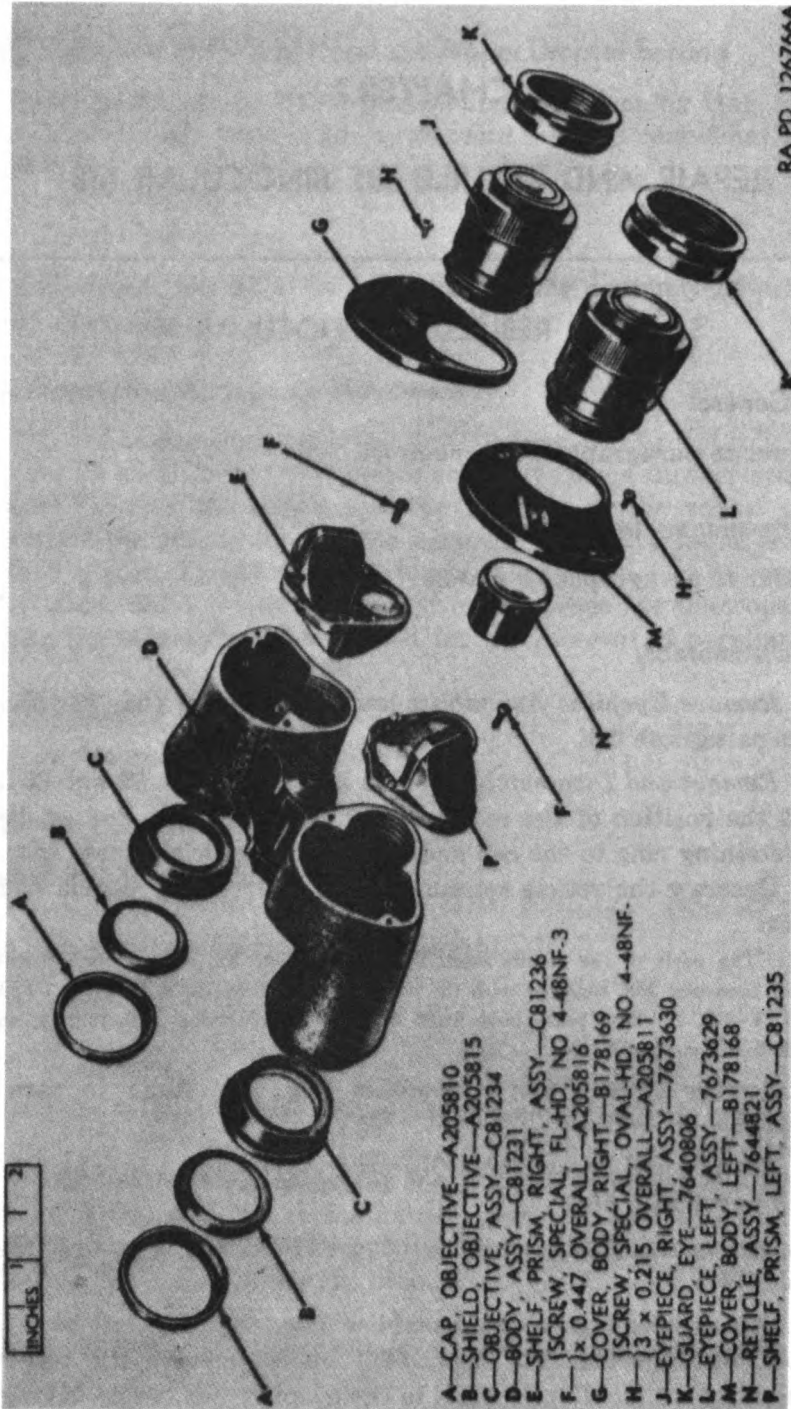

Figure 79. Binoocular M8 — exploded view.

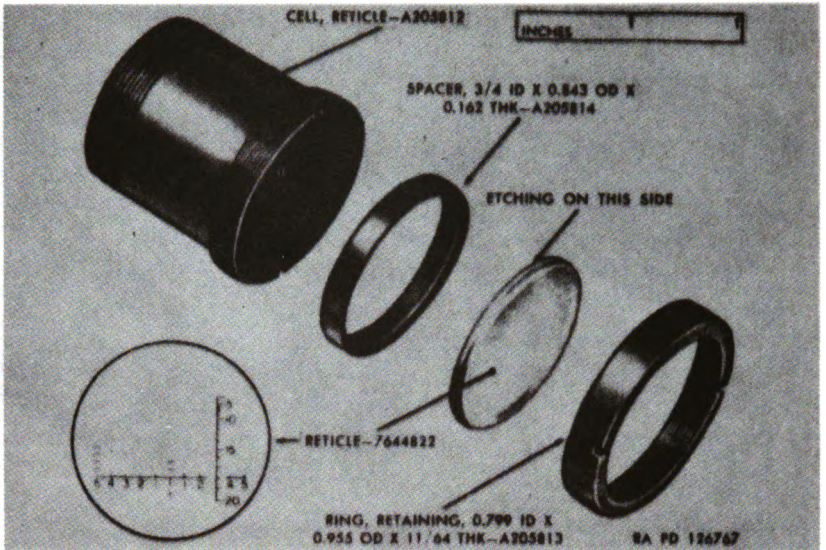

Figure 80. Reticle assembly 7644821 — exploded view.

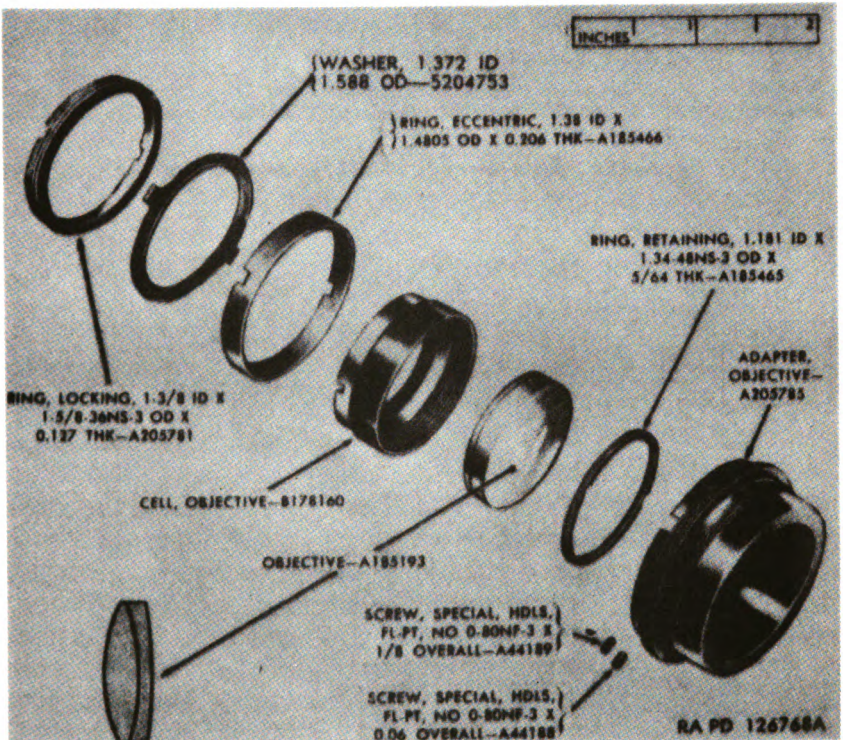

Figure 81. Objective assembly C81234 — exploded view.



Figure 82. Body assembly C81231 — exploded view.

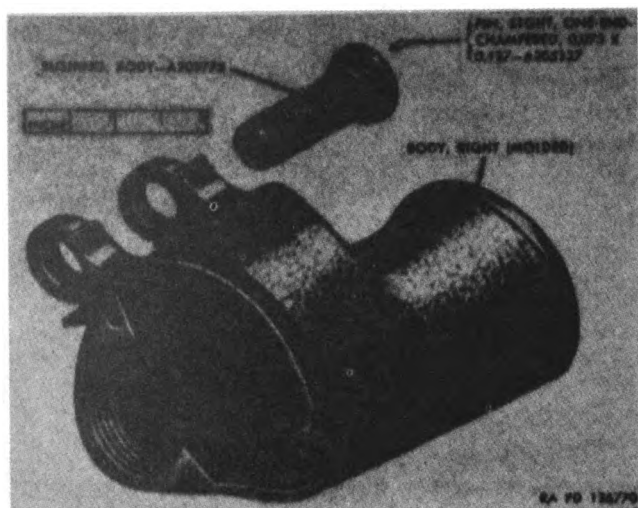

Figure 83. Right body assembly C81238 — exploded view.

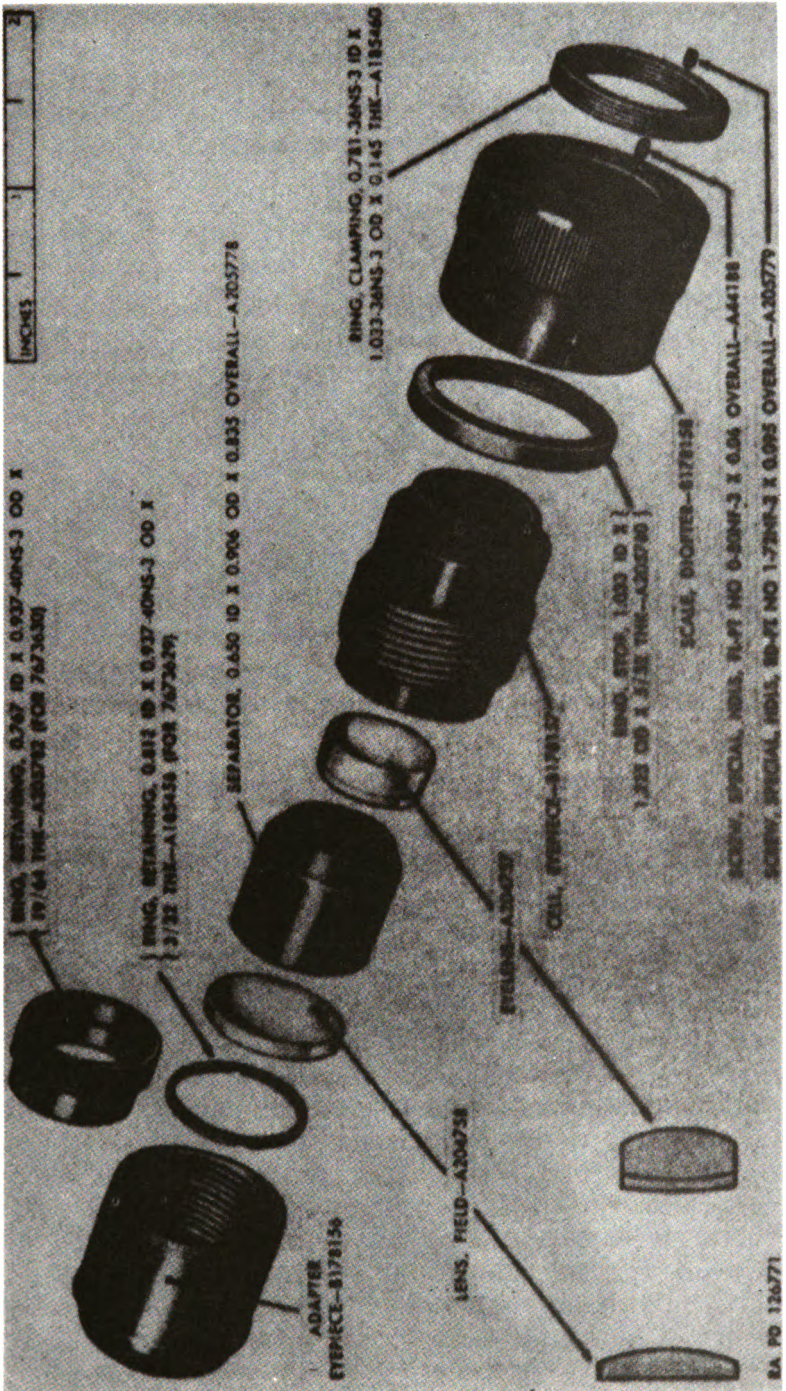

Figure 84. Eyepiece assemblies 7673629 (left), or 7673630 (right) — exploded view.

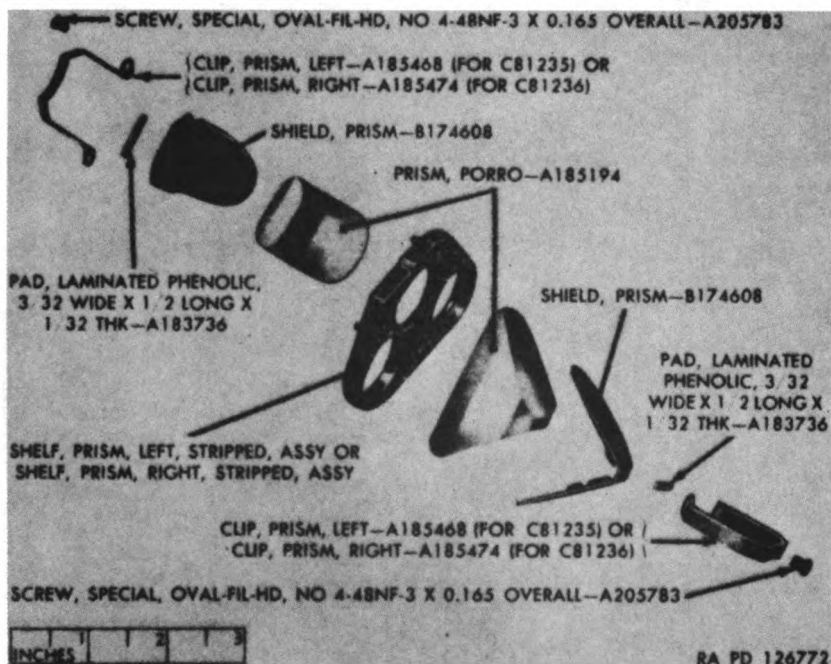

Figure 85. Prism shelf assembly C81235 (left) or C81236 (right) — exploded view.

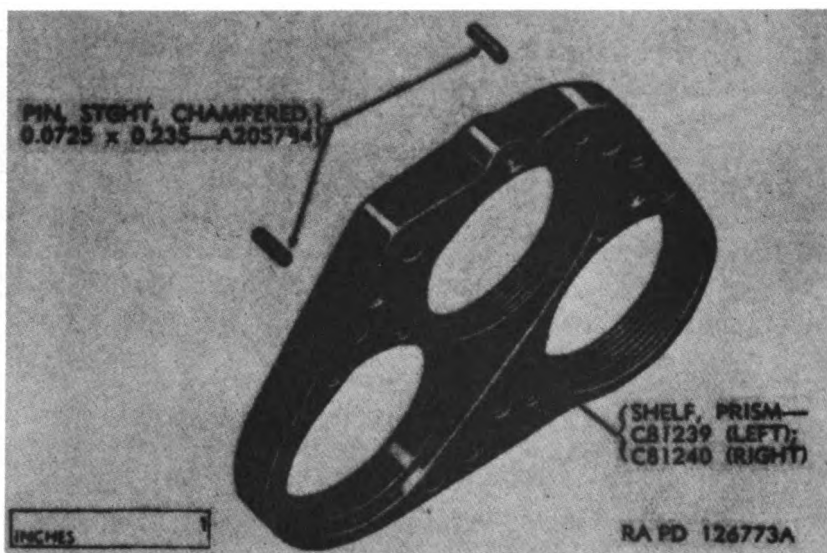

Figure 86. Left or right prism shelf stripped assembly — exploded view.

g. Disassemble Prism Shelf Assemblies (figs. 85 and 86). Refer to paragraph 56h.

80. Assembly

a. Assemble Body Assembly (fig. 82). Refer to paragraph 58a.

b. Assemble Prism Shelf Assemblies (figs. 85 and 86). Proceed as described in paragraph 58.

c. Install Prism Shelf Assemblies (fig. 79). Refer to paragraph 58c.

d. Assemble and Install Objective Assemblies (figs. 79 and 81). Refer to paragraph 58d.

e. Assemble and Install Reticle Assembly (figs. 79 and 80). If a reticle and cell of the type used with binocular M3 are used, assemble and install as described in paragraph 58e. If the reticle assembly shown in figure 80 is used, place the reticle spacer in the reticle cell. Install M3-type reticle with etching facing eyepiece assembly, others will face objective assembly. Screw in the reticle retaining ring, making sure that the reticle is alined to the scribe marks made during disassembly. Screw the reticle assembly into the prism shelf assembly, making sure that the scribe marks are alined. Adjust for tilt of reticle as described in paragraph 64.

f. Install Body Covers (fig. 79). Refer to paragraph 58f.

g. Assemble and Install Eyepiece Assemblies (figs. 79 and 84). Proceed as described in paragraph 58g, except install the No. 0-80 headless screw (fig. 84) which secures the diopter scale to the eyepiece cell, before screwing on the diopter scale clamping ring. Adjust for proper diopter movement as described in paragraph 59 and, if necessary, spot the diopter scale with a drill point for the No. 1-72 round-point screw (fig. 84) which secures the clamping ring, and spot the cell for the No. 0-80 flat-point headless screw which secures the diopter scale.

h. Rebuild of Equipment. Refer to paragraph 57.

Section II. TESTS AND ADJUSTMENTS

81. Definition of Field of View and Proper Diopter Setting

Proceed as described for binocular M3 (par. 59). After adjustment, spot new holes, if necessary, for the two headless screws (par. 80g).

82. Tilt of Field of View

Adjustment for tilt of field of view was made during reassembly. Refer to paragraph 60.

83. Parallax and Eyepiece Movement

Proceed as described for binocular M3 (par. 61) except to move the reticle away from the eyepiece assembly; use a thinner reticle spacer between the reticle and the shoulder of the reticle cell. To move the reticle toward the eyepiece, use a wider reticle spacer.

Note. If the binocular has been equipped with a M3-type reticle assembly, adjust by loosening the headless screw (fig. 45) and sliding the reticle cell toward or away from the eyepiece.

84. Stagger

Refer to paragraph 62.

85. Interpupillary Setting

Refer to paragraph 63.

86. Tilt of Reticle

Refer to paragraph 64.

87. Collimation

Refer to paragraph 65.

CHAPTER 8

REPAIR AND REBUILD OF BINOCULAR M9

Section I. REBUILD OF BINOCULAR M9

88. General

Refer to paragraphs 37 through 53.

89. Preliminary Inspection

Refer to paragraphs 29 and 30.

90. Disassembly

a. Remove Eyepiece Assemblies and Body Covers (fig. 87). Refer to paragraph 56a.

b. Remove Reticle (fig. 87). Reticle B173980 and attaching parts are mounted and removed in the same manner as the reticle assembly for the binocular M8 (par. 79b). However, the parts of the reticle assembly for binocular M3 (fig. 45), together with attaching parts, are available for binocular M9 for standardization. Refer to ORD 8 SNL F-210. If these parts have been installed in binocular M9, remove as described in paragraph 56b.

c. Remove Prism Shelf Assemblies (fig. 87). Refer to paragraph 56c.

d. Remove and Disassemble Objective Assemblies (figs. 87 and 88). Proceed as described in paragraph 56d, but ignore references to two screws and after removal of the locking ring, remove the washer with wing lugs (fig. 88).

e. Disassemble Body Assembly (figs. 89 and 90). Refer to paragraph 56e.

f. Disassemble Eyepiece Assemblies (fig. 91). Proceed as described for binocular M3 (par. 56f) except remove the screw which attaches the diopter scale to the eyepiece cell before taking off the diopter scale.

g. Disassemble Prism Shelf Assemblies (figs. 92 and 93). Refer to paragraph 56h.

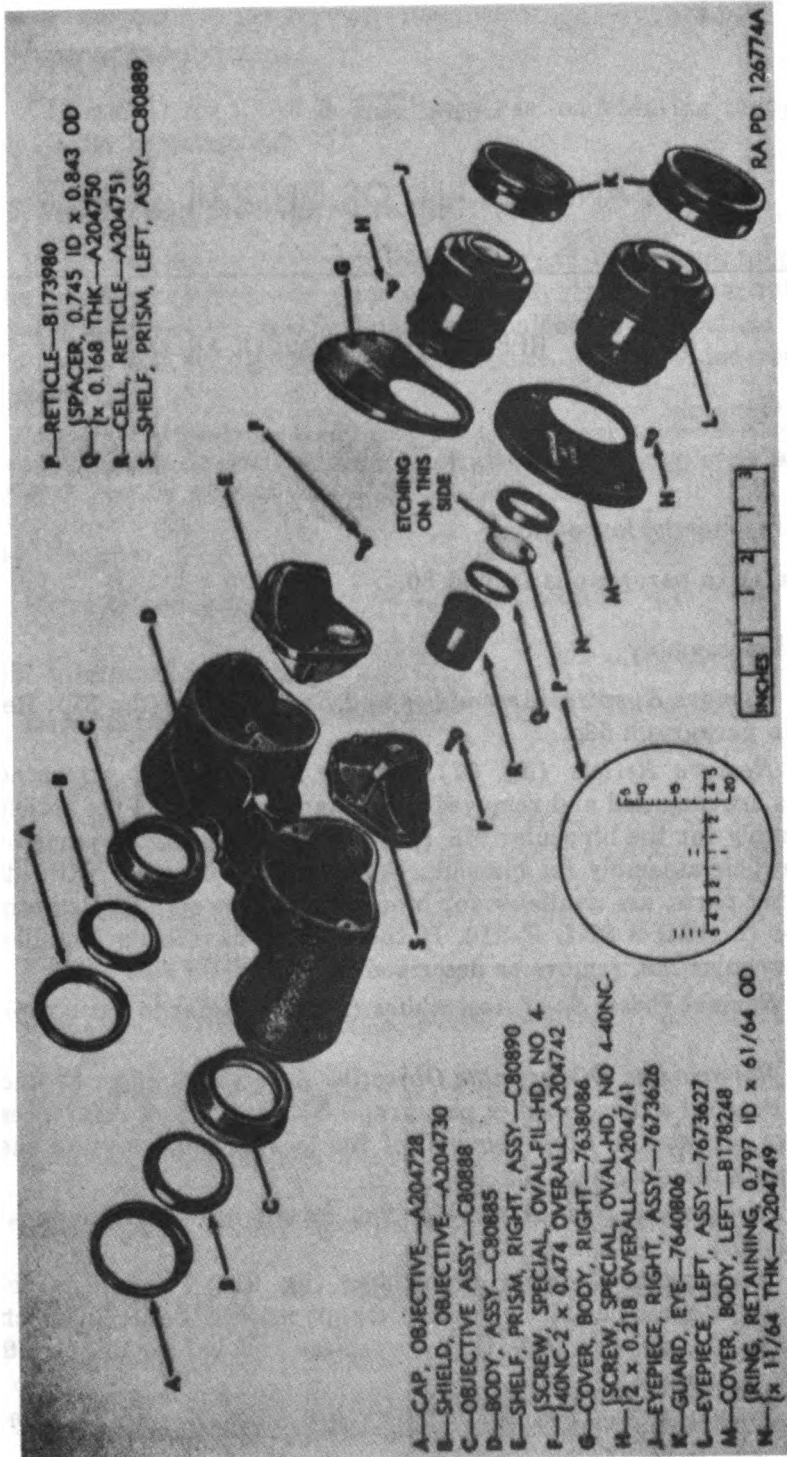

P—RETICLE—8173980
 Q—SPACER, 0.745 ID x 0.843 OD
 R—CELL, RETICLE—A204751
 S—SHELF, PRISM, LEFT, ASSY—C80889

A—CAP, OBJECTIVE—A204728
 B—SHIELD, OBJECTIVE—A204730
 C—OBJECTIVE ASSY—C80888
 D—BODY, ASSY—C80885
 E—SHELF, PRISM, RIGHT, ASSY—C80890
 F—SCREW SPECIAL, OVAL-FIL-HD, NO 4
 G—COVER, BODY, RIGHT—7638086
 H—SCREW SPECIAL, OVAL-HD, NO 4-40NC-
 I—EYEPiece, RIGHT, ASSY—7673626
 J—GUARD, EYE—7640806
 K—EYEPiece, LEFT, ASSY—7673627
 L—COVER, BODY, LEFT—8178248
 M—RING, RETAINING, 0.797 ID x 61/64 OD
 N—

INCHES 1 2 3

RA PD 126774A

Figure 87. Binocular MV — exploded view.

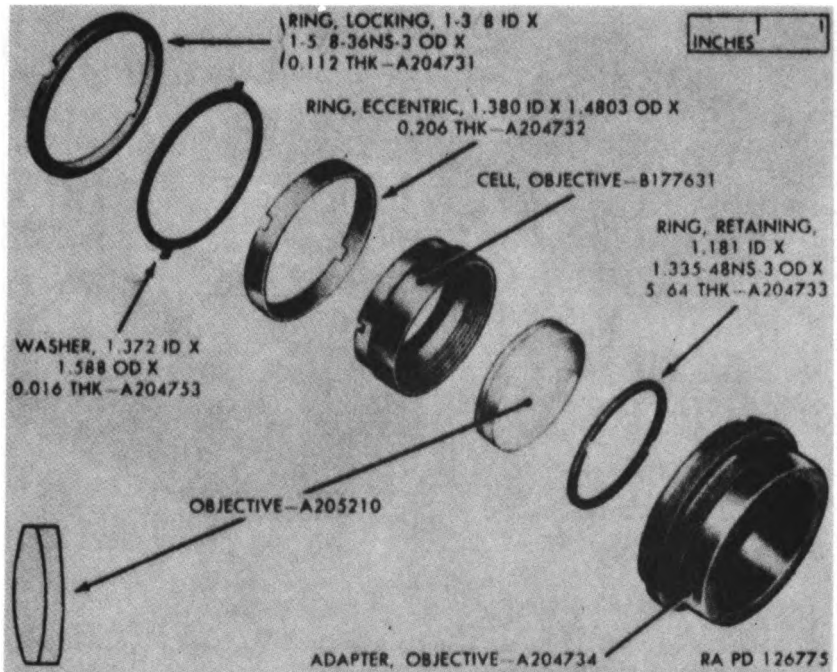

Figure 88. Objective assembly C80888 — exploded view.

91. Assembly

a. Assemble Body Assembly (figs. 89 and 90). Refer to paragraph 58a.

b. Assemble Prism Shelf Assemblies (figs. 92 and 93). Proceed as described in paragraph 58.

c. Install Prism Shelf Assemblies (fig. 87). Refer to paragraph 58c.

d. Assemble and Install Objective Assemblies (figs. 87 and 88). Place the objective in the cell and secure with the retaining ring. Place the eccentric ring on the cell and install cell, eccentric ring, and objective in the adapter. Put the washer in the adapter so that the external lugs of the washer engage the slots of the adapter. Secure with the locking ring. If the adapter was removed from the body, install the assembly in the body, sealing the adapter to the body (par. 51) with sealing compound for optical lenses.

Note. The cell, eccentric ring, washer, and locking ring must not be sealed until the instrument is collimated (par. 65).

Install the objective shield and cap.

e. Install Reticle (fig. 87). Proceed as described in paragraph 80e.

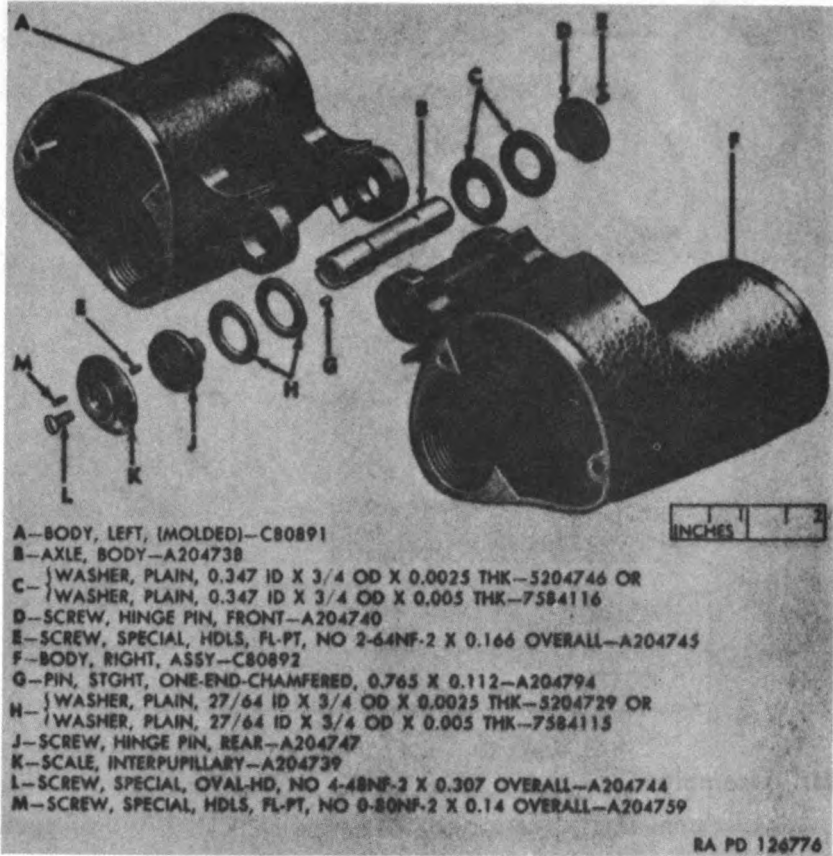

Figure 89. Body assembly — C8086 — exploded view.

f. Install Body Covers (fig. 87). Refer to paragraph 58f.

g. Assemble and Install Eyepiece Assemblies (figs. 87 and 91). Proceed as described in paragraph 58g, except install the No. 0-80 screw which secures the diopter scale to the eyepiece cell before screwing on the diopter scale clamping ring. Adjust for proper diopter movement as described in paragraph 59 and, if necessary, spot the cell with a 90° drill point for the flat-point No. 0-80 screw which secures the diopter scale and spot the diopter scale for the No. 1-72 round-point screw.

Section II. TESTS AND ADJUSTMENTS

92. Definition of Field of View and Proper Diopter Setting

Refer to paragraph 59.

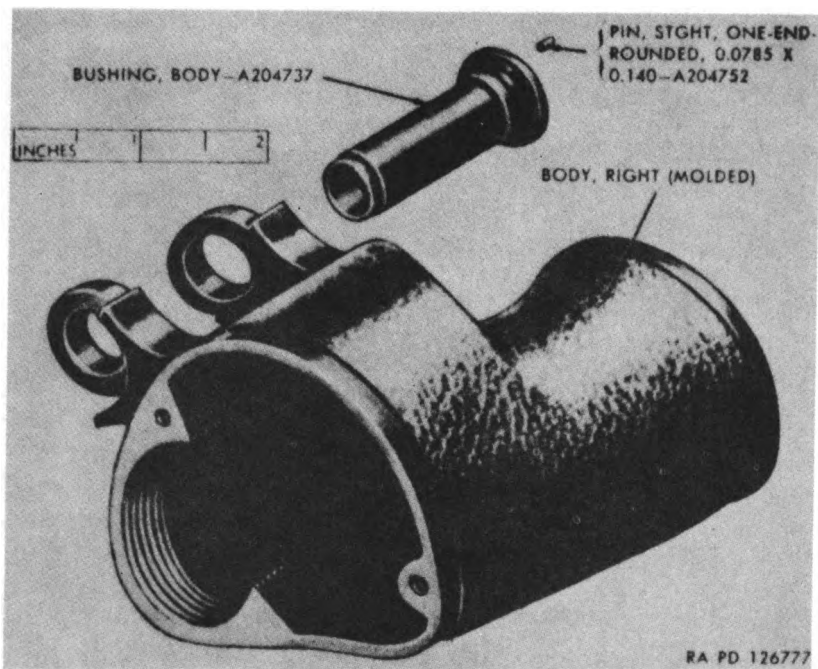

Figure 90. Right body assembly C80892 — exploded view.

93. Tilt of Field of View

Adjustment for tilt of field was made during reassembly (par. 60).

94. Parallax and Eyepiece Movement

Proceed as described in paragraph 61, except, in order to move the reticle away from the eyepiece assembly, use a thinner reticle spacer between the reticle and the shoulder of the reticle cell. To move the reticle toward the eyepiece assembly, use a wider reticle spacer.

Note. If the binocular has been equipped with a M3-type reticle assembly (fig. 45), adjust by loosening the screw and sliding the reticle cell toward or away from the eyepiece end of the instrument.

95. Stagger

Refer to paragraph 62.

96. Interpupillary Setting

Refer to paragraph 63.

97. Tilt of Reticle

Refer to paragraph 64.

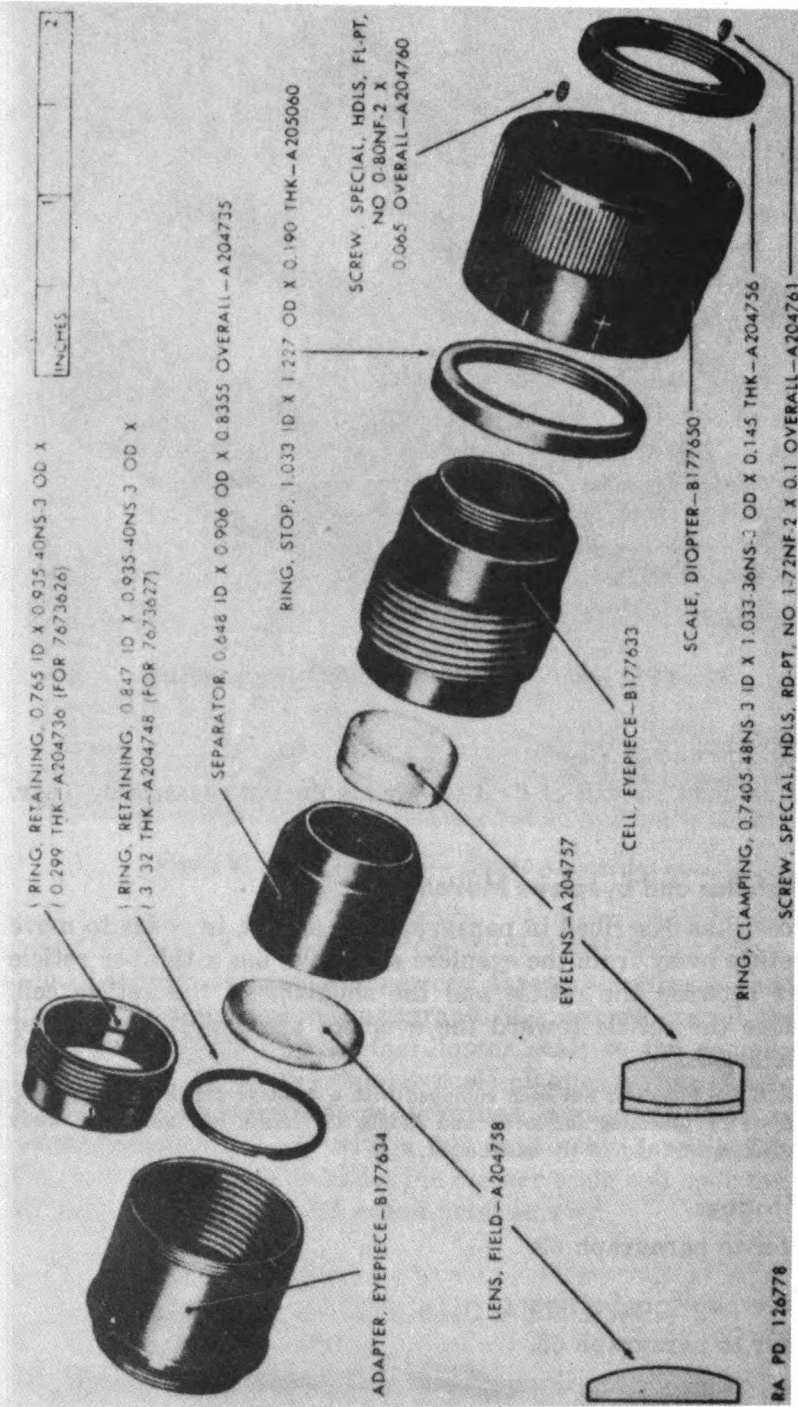

Figure 91. Eyepiece assembly 7673627 (left) or 7673626 (right) — exploded view.

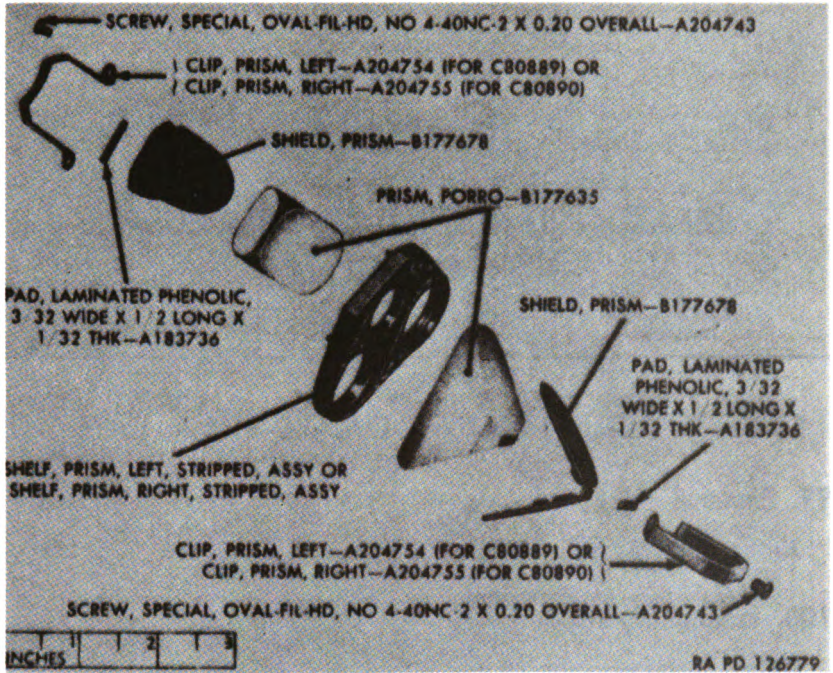

Figure 92. Prism shelf assembly C80889 (left) or C80890 (right) — exploded view.

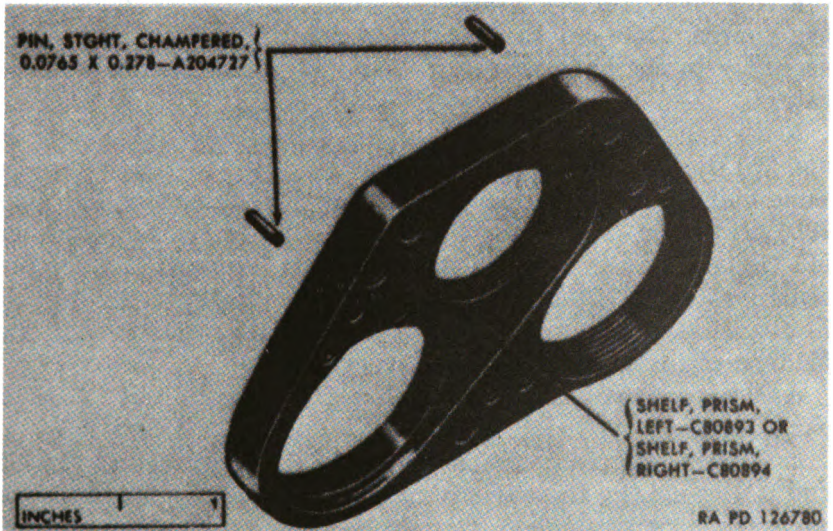

Figure 93. Left or right prism shelf stripped assemblies — exploded view.

98. Collimation

Refer to paragraph 65.

CHAPTER 9

REPAIR AND REBUILD OF BINOCULARS M13 AND M13A1

Section I. REBUILD OF BINOCULARS M13 AND M13A1

99. General

Refer to paragraphs 37 through 53.

100. Preliminary Inspection

Refer to paragraphs 29 and 30.

101. Disassembly

a. Remove Eyepiece Assemblies (figs. 94 and 95). Remove the eye guards. Take out the five screws which secure each eyepiece assembly to the body assembly. Take out and discard the desiccators.

b. Remove and Disassemble Reticle Assembly (figs. 94, 95, and 96). Reticle assembly 7199590 is mounted and removed in the same manner as the reticle assembly for the binocular M8 (par. 79b). However, the parts of the reticle assembly for binocular M3 (fig. 45) together with attaching parts, are available for binoculars M13 and M13A1 for standardization. Refer to ORD 8 SNL F-210. If these parts have been installed in binoculars M13 and M13A1, remove as described in paragraph 56b.

c. Remove Prism Shelf Assemblies (figs. 94 and 95). Refer to paragraph 56c.

d. Remove and Disassemble Objective Assemblies (figs. 94, 95, and 97). Unscrew the objective caps. On binocular M13 only remove the objective shield. It may be necessary to slide a knife blade between the shield and the locking ring of the objective assembly to facilitate removal of the shield. Unscrew the locking ring and remove the washer with external lugs. On binocular M13A1 only, remove the gasket from the objective cell. Remove the eccentric ring and the objective cell. Unscrew the retaining



RA PD 126781A

- A—CAP, OBJECTIVE—A185477
- B—SHIELD, OBJECTIVE—A185478
- C—OBJECTIVE, ASSY—C131334
- D—BODY, ASSY—C131255
- E—SHELF, PRISM, RIGHT, ASSY—C79390
- F—} SCREW, SPECIAL, FL-FIL-HD, NO. 4,
- } 48NF-3 x 0.45 OVERALL—A185480
- G—GASKET, EYEPiece—8269516
- H—EYEPiece, RIGHT, ASSY—7673632
- I—} SCREW, SPECIAL, OVAL-FIL-HD, NO. 4,
- } 48NF-3 x 0.375—7578741
- K—GUARD, EYE—7640806
- L—EYEPiece, LEFT, ASSY—7673631
- M—RETICLE, ASSY—7199590
- N—SHELF, PRISM, LEFT, ASSY—C131337

Figure 94. Binocular M13 — exploded view.

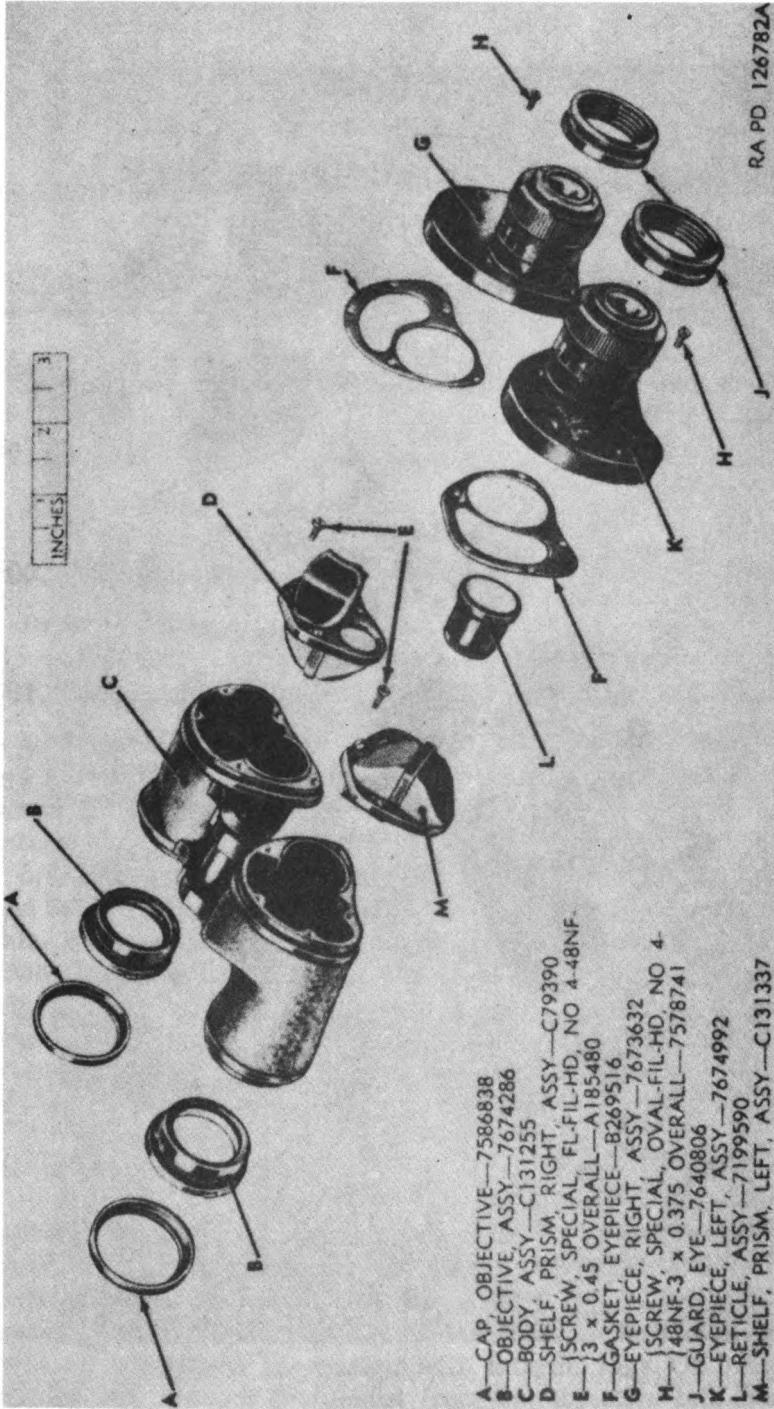

Figure 96. Binocular M19A1 — exploded view.

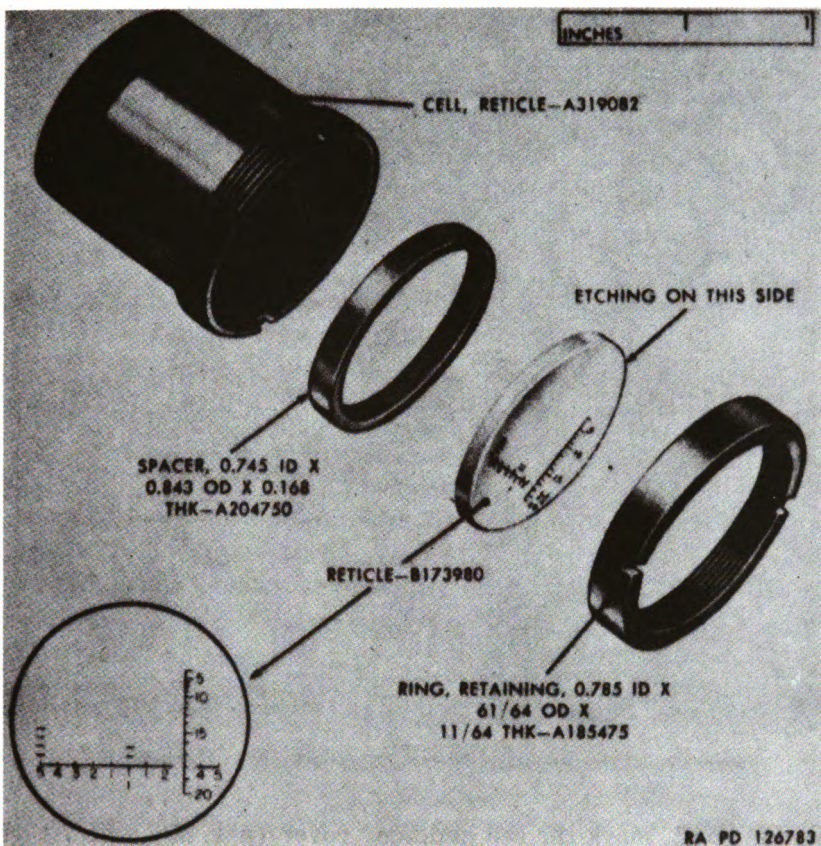

Figure 96. Reticle assembly 7199590 — exploded view.

ring from the objective cell and take out the objective and, on M13A1 only, the gasket. Do not remove the objective adapter from the body assembly unless damaged. If removal is necessary, apply heat to soften the sealing compound (par. 42) and unscrew the adapter, using a suitable strap wrench 41-W-3382 or 41-W-3385-25 (fig. 15).

e. Disassemble Body Assembly (figs. 98 and 99). Refer to paragraph 56.

f. Disassemble Eyepiece Assemblies (figs. 100 through 104). Remove the dog-point screw from the diopter scale clamping ring. Unscrew the ring and remove the diopter scale. Unscrew the retaining ring and remove the field lens, separator, and eyelens (par. 43). Mark the lenses (par. 40). Remove the stop ring from the body cover assembly. Disassemble the body cover assembly until the multiple threads are at the point of disengagement.

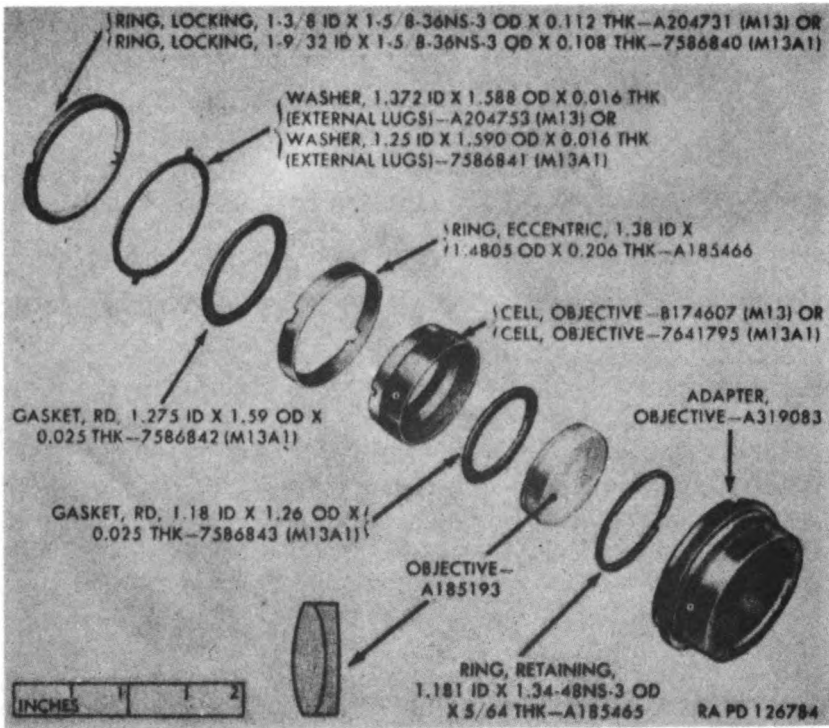

Figure 97. Objective assembly C131334 or 7674286 — exploded view.

At this point, mark the cell and body cover (par. 39) and lift out the cell assembly. Do not disassemble the eyepiece cell assembly unless the pins are damaged. Clean and inspect the parts of the eyepiece assembly as described for binocular M3 (par. 56f).

g. Disassemble Prism Shelf Assemblies (figs. 105 and 106). Refer to paragraph 56h.

h. Rebuild of Equipment. Refer to paragraph 57.

102. Assembly

a. Assemble Body Assembly (figs. 98 and 99). Refer to paragraph 58a.

b. Assemble Prism Shelf Assemblies (figs. 105 and 106). Proceed as described in paragraph 58b.

c. Install Prism Shelf Assemblies (fig. 94). Refer to paragraph 58c.

d. Assemble and Install Objective Assemblies (figs. 94 and 97). On M13A1 only, install the gasket with 1.26-inch outer diameter in the objective cell. On both M13 and M13A1, install the objec-



Figure 98. Body assembly C151255 — exploded view.

tive in the cell and secure with the retaining ring. Place the eccentric ring on the objective cell and insert the cell in the adapter. On binocular M13A1, place the gasket with 1.59-inch outer diameter over the objective cell and eccentric ring. Install the washer with external lugs engaging the lugs in the slots of the adapter and secure with the locking ring. If the adapter was removed from the body, install the objective assembly in the body sealing the adapter to the body (par. 51) with sealing compound for optical lenses.

e. Assemble and Install Reticle Assembly (figs. 94 and 96). Proceed as described in paragraph 80e.

f. Assemble Eyepiece Assemblies (figs. 100 through 104). If necessary, press new pins into the holes in the eyepiece cell. Lubricate the threads of the eyepiece cell assembly with instrument lubricating grease and screw the cell assembly into the body cover making sure to line up the scribe marks made at disassembly be-

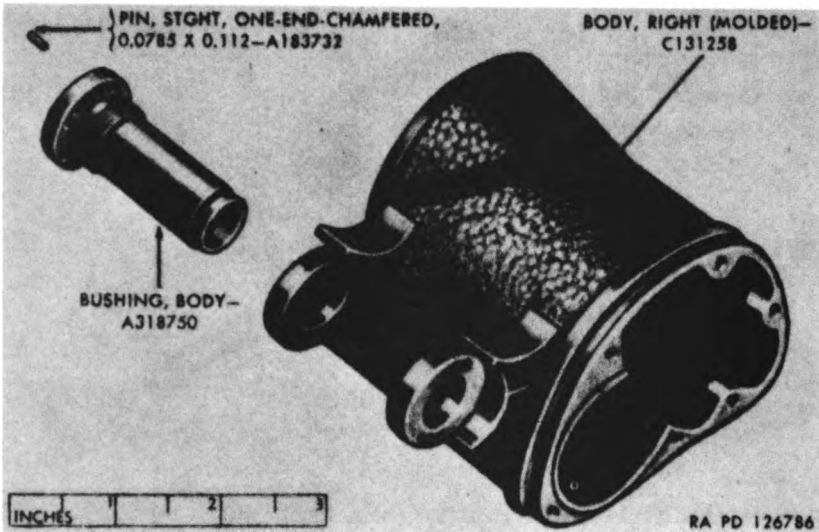

Figure 99. Right body assembly C131256 — exploded view.

fore engaging the multiple threads. Install the stop ring on the body cover. Place the eyelens, separator, and field lens in the body cover assembly and secure with the retaining ring. Install the diopter scale on the eyepiece cell and secure with the clamping ring and the set screw. The diopter scale will be adjusted to the proper setting (par. 59) after assembly of the instrument.

g. Install Eyepiece Assembly (fig. 94). Place a thin coating of optical lens sealing compound around the lower shoulder of the binocular body. Place the gasket in the body cover of the eyepiece assembly and install the eyepiece assembly on the binocular body. Secure with the five screws. Examine the eye guards. If the eye guards do not have an annular groove for the accommodation of filter M1, apply MWO ORD F210-W1 as described for binocular M3 (par. 58g).

Section II. TESTS AND ADJUSTMENTS

103. Definition of Field of View and Proper Diopter Setting

Refer to paragraph 59.

104. Tilt of Field of View

Adjustment for tilt of field of view was made during reassembly. Refer to paragraph 60.

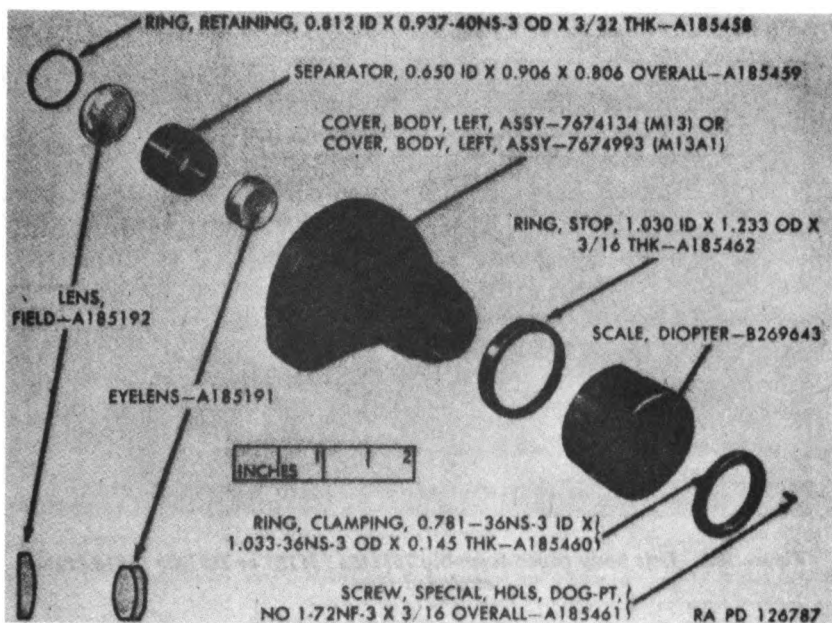

Figure 100. Left eyepiece assembly 7673631 (M13) or 7674992 (M13A1) — exploded view.

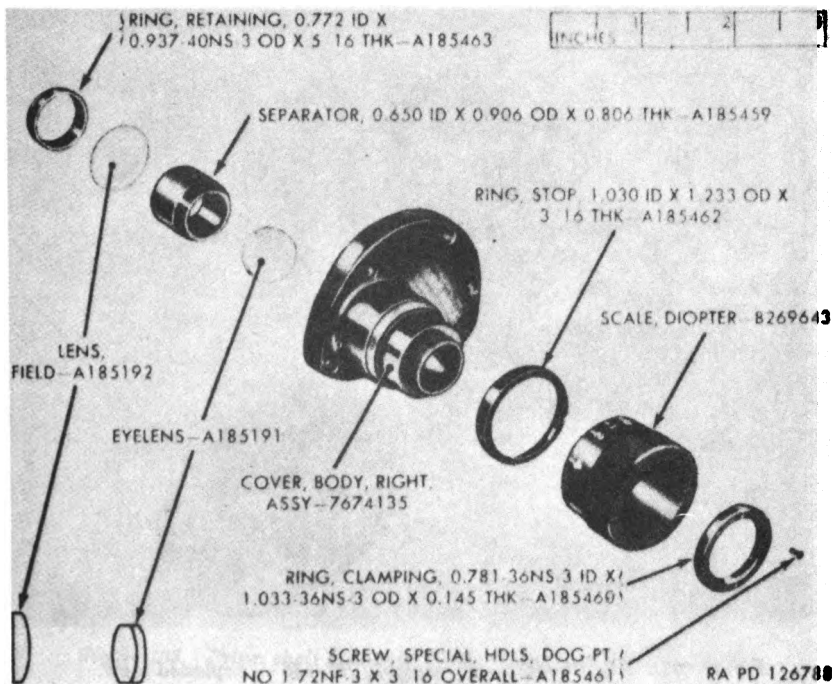

Figure 101. Right eyepiece assembly 7673632 — exploded view.

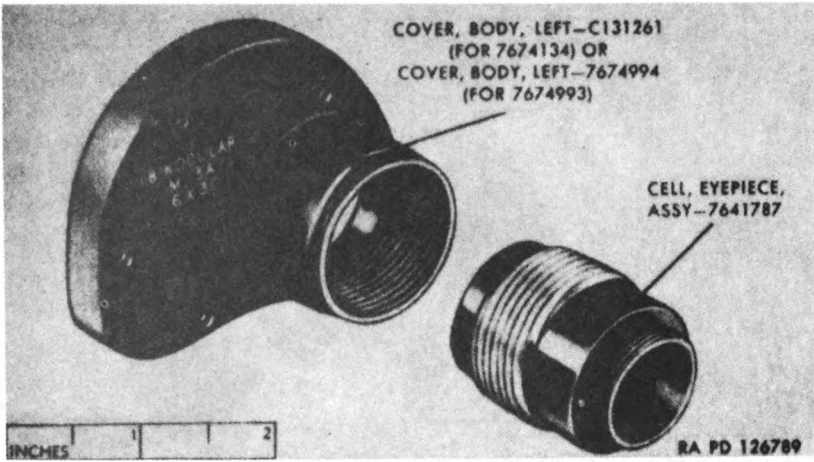

Figure 102. Left body cover assembly 7674134 (M1S) or 7674993 (M1SA1) — exploded view.

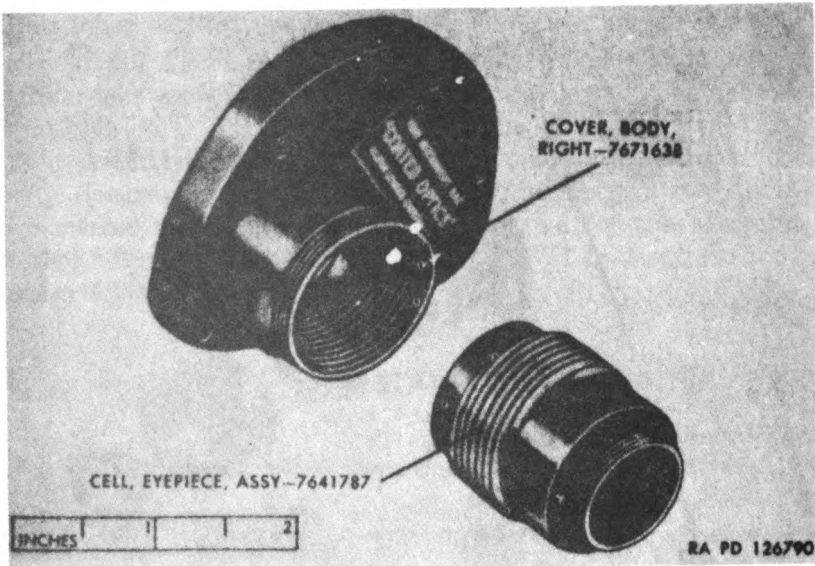

Figure 103. Right body cover assembly 7674135 — exploded view.

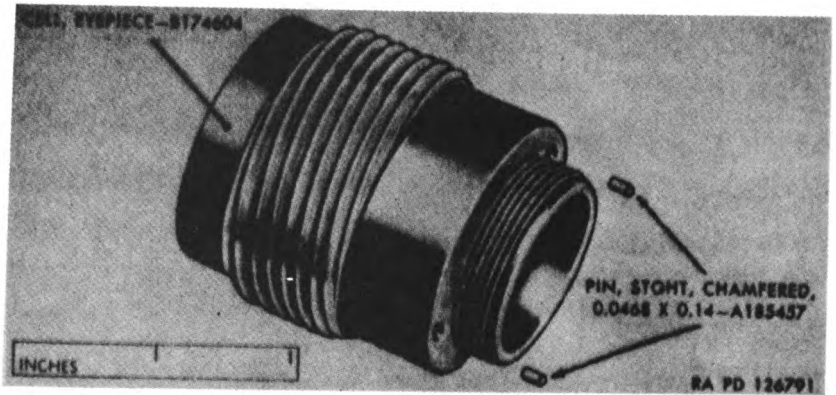

Figure 104. Eyepiece cell assembly 7641787 — exploded view.

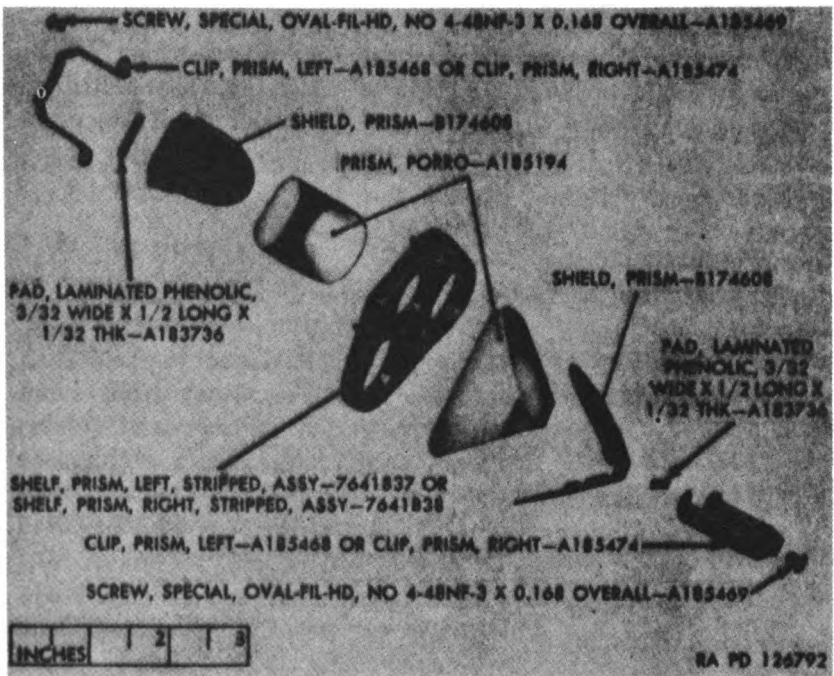

Figure 106. Prism shelf assembly C78990 (right) or C131937 (left) exploded view.

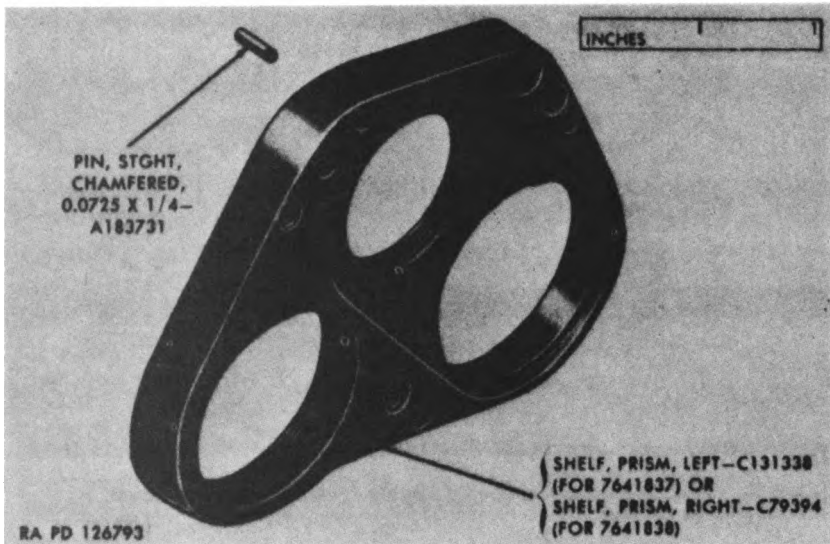

Figure 108. Stripped prism shelf assembly 7641837 (left) or 7641838 (right) — exploded view.

105. Parallax and Eyepiece Movement

Proceed as described in paragraph 61, except in order to move the reticle away from the eyepiece assembly, use a thinner reticle spacer between the reticle and the shoulder of the reticle cell. To move the reticle toward the eyepiece assembly, use a wider reticle spacer.

106. Stagger

Refer to paragraph 62.

107. Interpupillary Setting

Refer to paragraph 63.

108. Tilt of Reticle

Refer to paragraph 64.

109. Collimation

Refer to paragraph 65.

CHAPTER 10

REPAIR AND REBUILD OF BINOCULARS M15, M15A1, M17, AND M17A1

Section I. REBUILD OF BINOCULARS M15, M15A1, M17, AND M17A1

110. General

MWO ORD F238-W1 modifies binoculars M15 and M17 to accommodate filter M1 and changes the designation of binocular M15 to M15A1 and binocular M17 to M17A1. Refer to paragraph 6c. For general maintenance information, refer to paragraphs 37 through 53.

111. Preliminary Inspection

Refer to paragraphs 29 and 30.

112. Disassembly

a. Remove Filter Holder Adapter Assemblies or Eye Guards (figs. 107 through 110). If filter holder adapter assemblies are used, as on binocular M15 or on early models of binocular M17, remove the three screws 7579569 which secure each adapter assembly to the cover with eyepiece assembly. Lift off the adapter assemblies. The adapter assemblies will be discarded in accordance with MWO ORD F238-W1 at assembly. If eye guards are used, remove the eye guards.

b. Remove Cover with Eyepiece Assemblies (figs. 107 through 110). Remove the five screws which secure each cover with eyepiece assembly; take off the assemblies and their gaskets. Removal of the alternate assemblies is no different from that of the preferred cover with eyepiece assembly. Remove and discard desiccators.

c. Remove and Disassemble Reticle Assembly (M17 and M17A1) (figs. 109, 110, and 111). Refer to paragraph 68b.

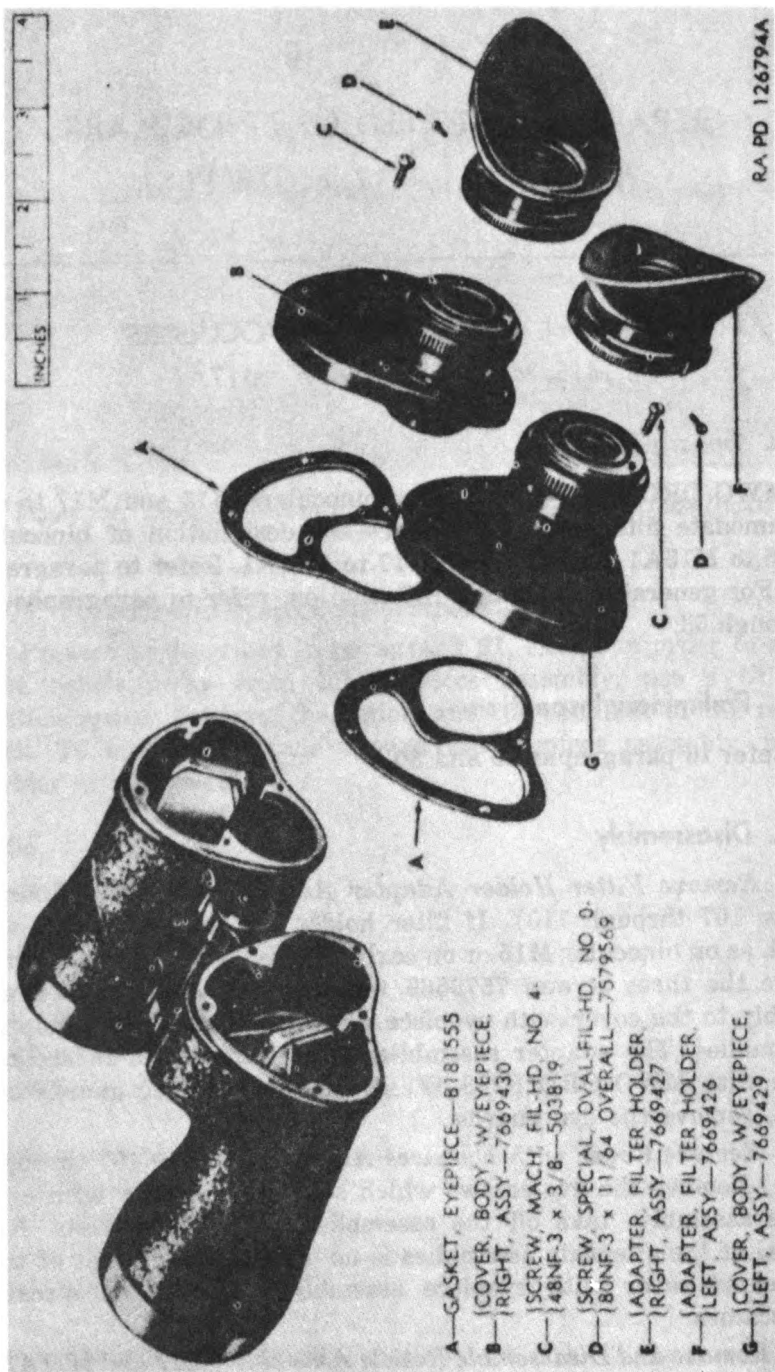

Figure 107. Binocular M16 — partial exploded view.

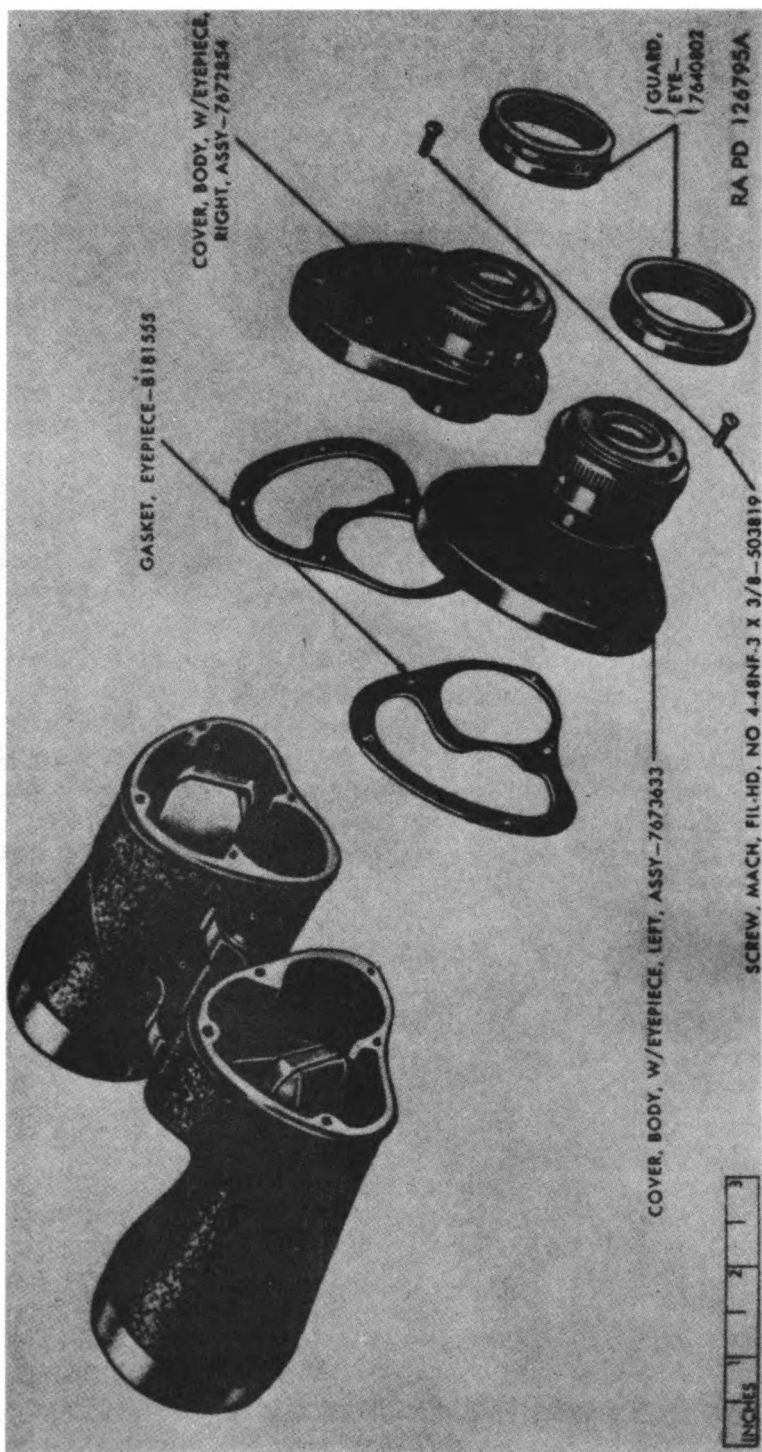

Figure 108. Binocular M15A1 — partial exploded view.

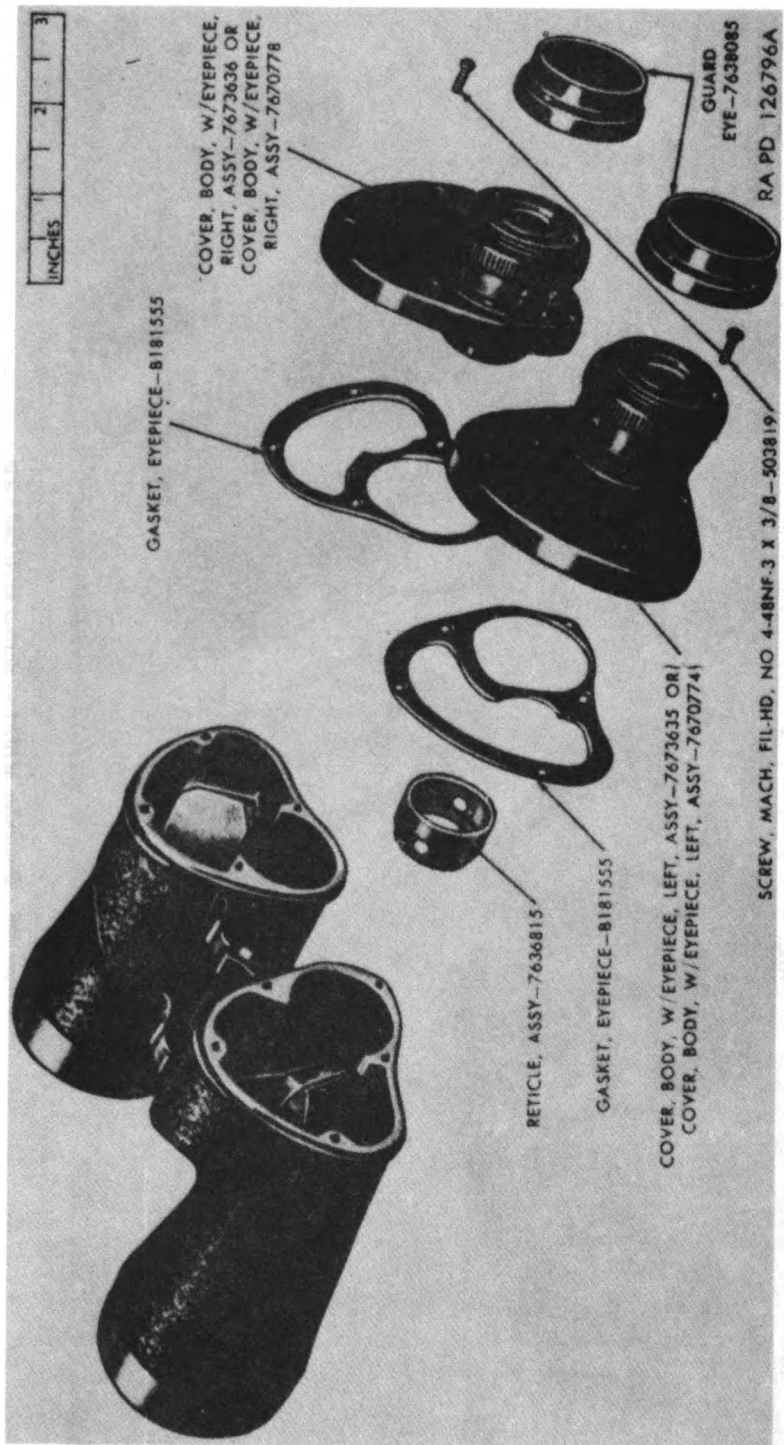

Figure 109. Binocular M17 — partial exploded view.

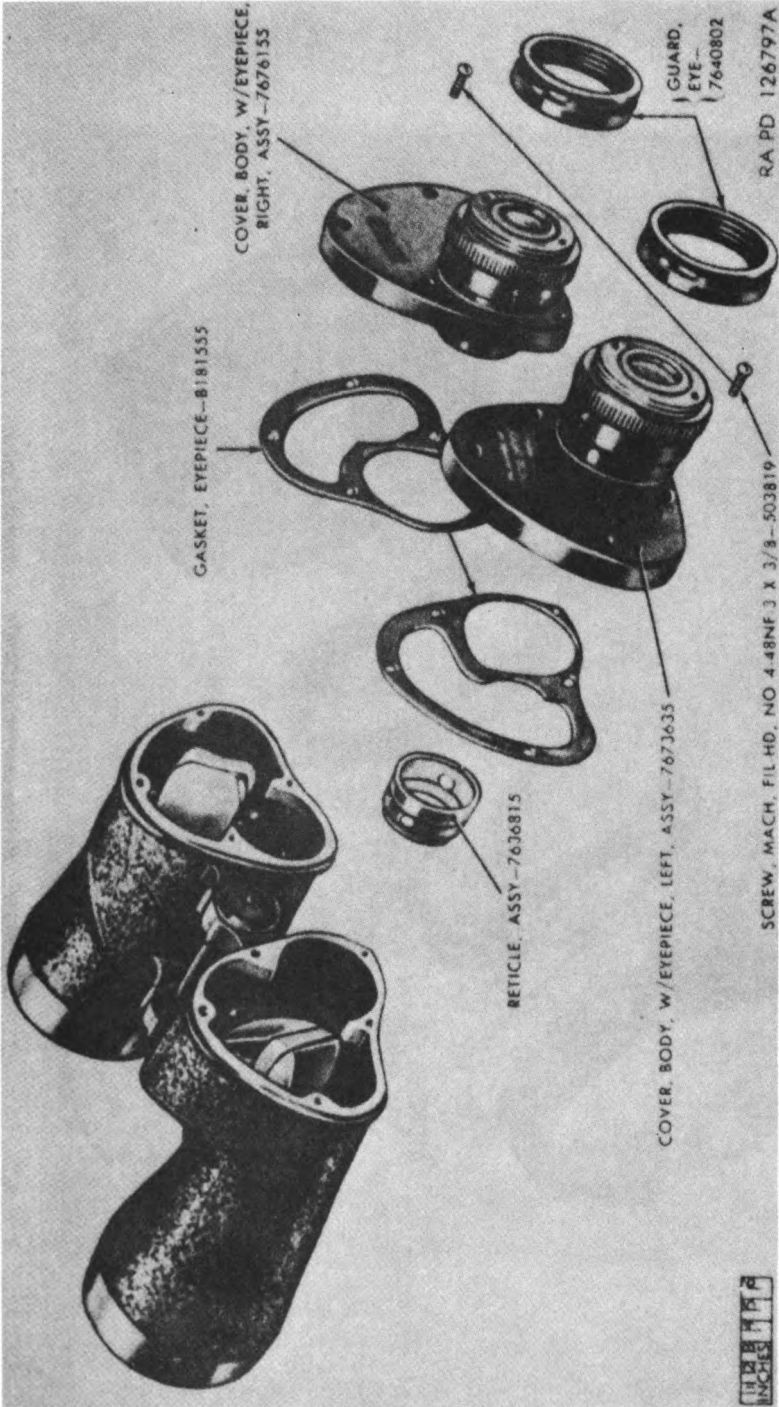

Figure 110. Binocular M17A1 — partial exploded view.

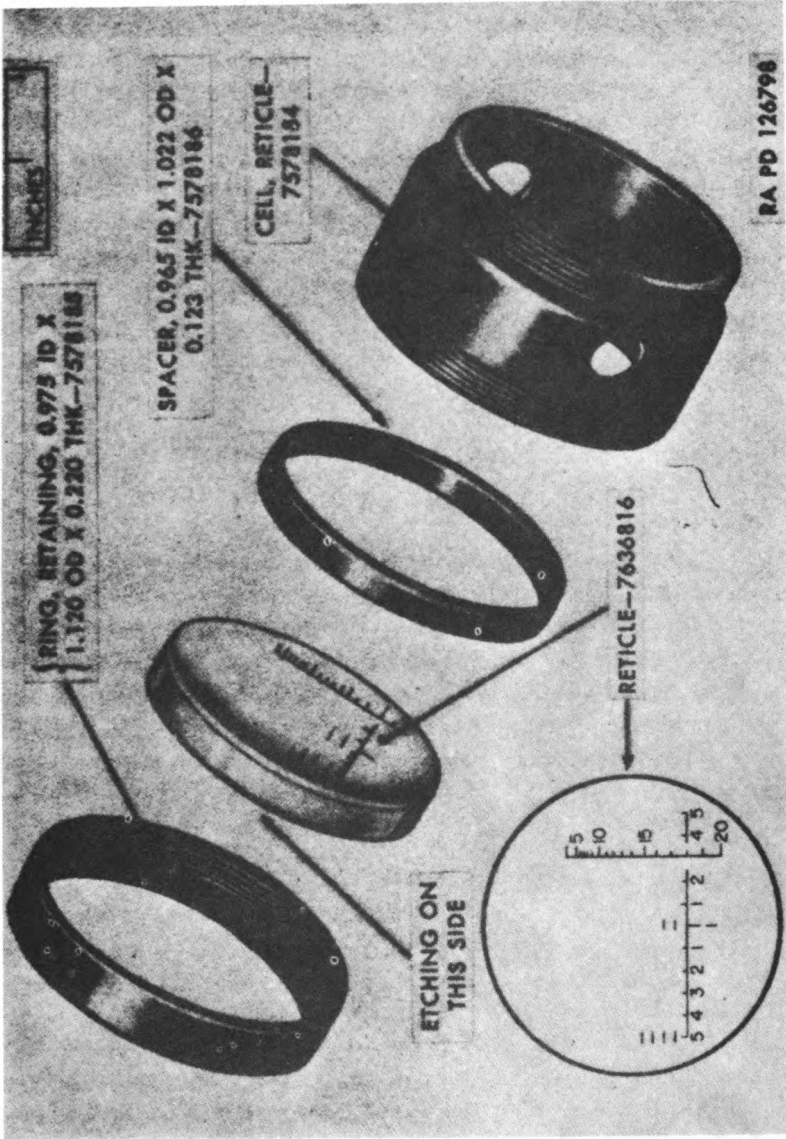

Figure 111. Reticle assembly 7636816 — exploded view.

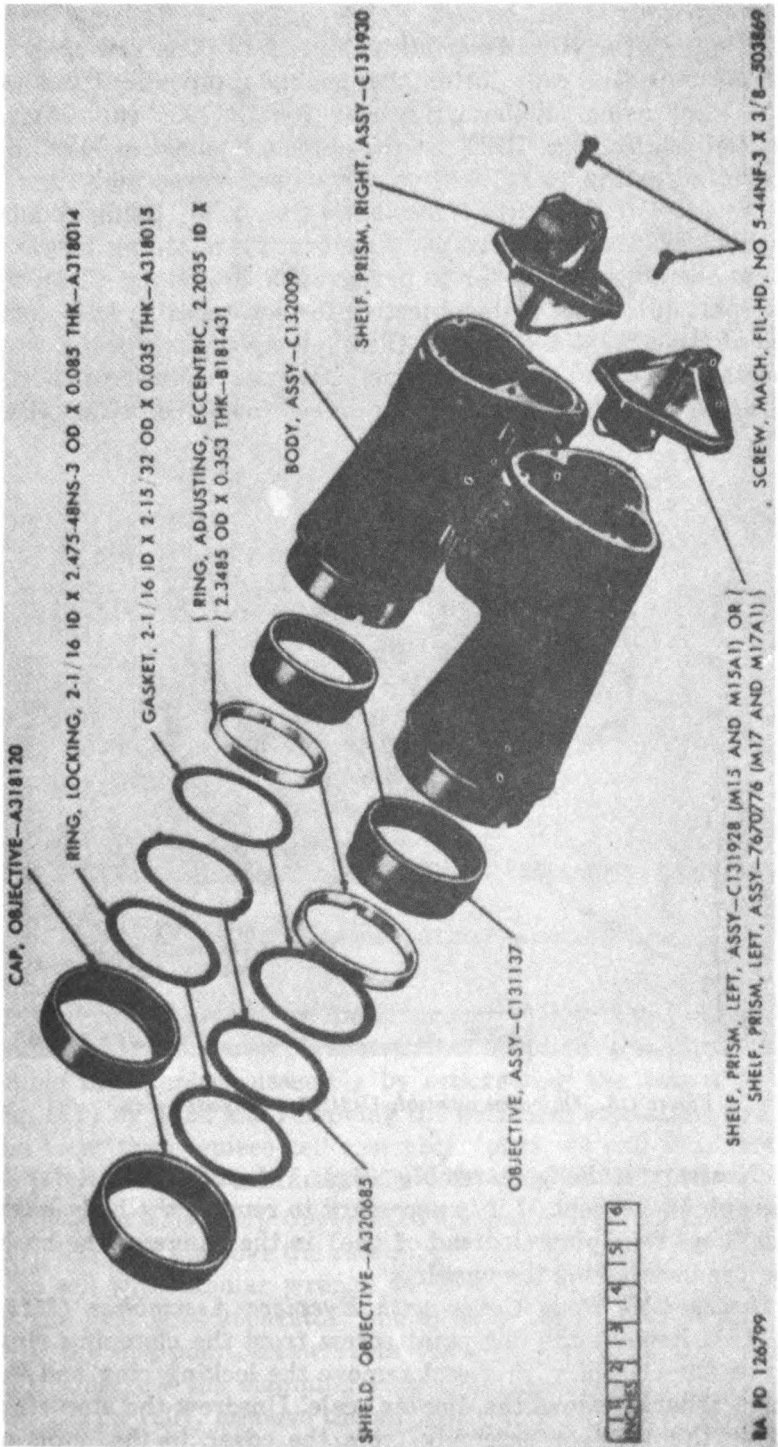

Figure 119. Binocular M15, M15A1, M17 or M17A1 — partial exploded view.

d. Remove Prism Shelf Assemblies (fig. 112). Refer to paragraph 56c.

e. Remove Objective Assemblies (fig. 112). Unscrew and remove the objective cap. Soften the sealing compound (pars. 42 and 51), and using tubular wrench 41-W-3726-295 (fig. 70) remove the locking ring. Take out the objective shield, gasket, and eccentric adjusting ring. Remove the objective assembly.

f. Disassemble Objective Assemblies (fig. 113). Using tubular wrench 41-W-3726-255 (fig. 17), remove the retaining ring and take out the objective. Refer to paragraphs 40 and 43. Clean the parts (par. 46). Inspect the objective for scratches, cracks, separation of the cemented elements. Clean all sealing compound from the metal parts and inspect for defective screw threads, burrs, and bad wrench slots. Remedy any defect found before proceeding further.

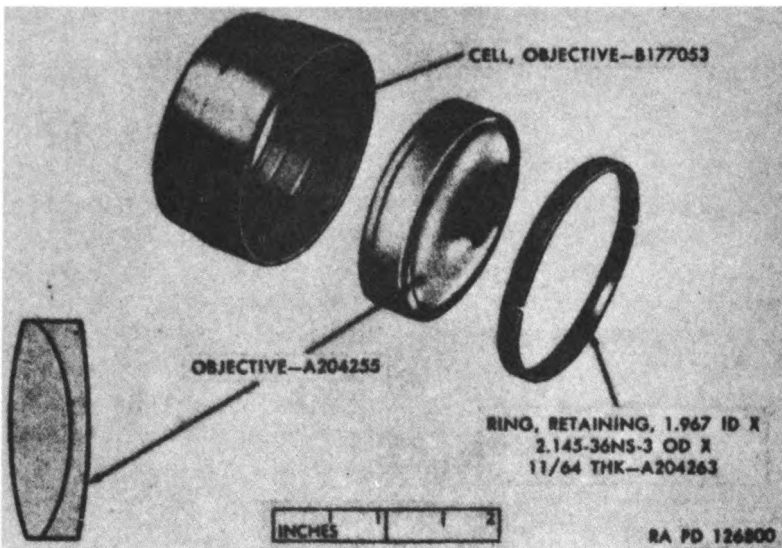

Figure 113. Objective assembly C131157 — exploded view.

g. Disassemble Body Assembly (figs. 114 and 115). Refer to paragraph 56e, except, if it is necessary to remove the body bushing, drill out four pins (instead of one) in the flange of the bushing before unscrewing the bushing.

h. Disassemble Body Cover with Eyepiece Assemblies (M15) (fig. 116). Remove the dog-point screw from the clamping ring. Unscrew the clamping ring and remove the locking ring and the spring washer. Remove the diopter scale. Unscrew the stop ring. Unscrew the eyepiece assembly from the cover to the point of



Figure 114. Body assembly C132000 — exploded view.

disengagement of the multiple threads and scribe the eyepiece assembly to the cover; remove the eyepiece assembly. Disassemble the eyepiece assembly by unscrewing the retaining ring (fig. 117) by hand and removing the field lens, separator, and eyelens from the eyepiece cell assembly (pars. 40 and 43). Remove the pins of the cell assembly (fig. 118) only if damaged.

i. *Disassemble Body Cover with Eyepiece Assemblies (M15A1, M17, M17A1).* Remove the retaining ring (fig. 119) from the eyepiece cell with tubular wrench 41-W-3726-93 (fig. 75) and take out the field lens, separator, and eyelens (pars. 40 and 43). Remove the dog-point screw from the clamping ring (fig. 119 or 120). Unscrew the clamping ring and remove the diopter scale (fig. 119 or 120). Remove the stop ring from the body cover (fig. 119 or 120). Disassemble the body cover assembly (E, fig. 119)



Figure 115. Right body assembly C132011 — exploded view.

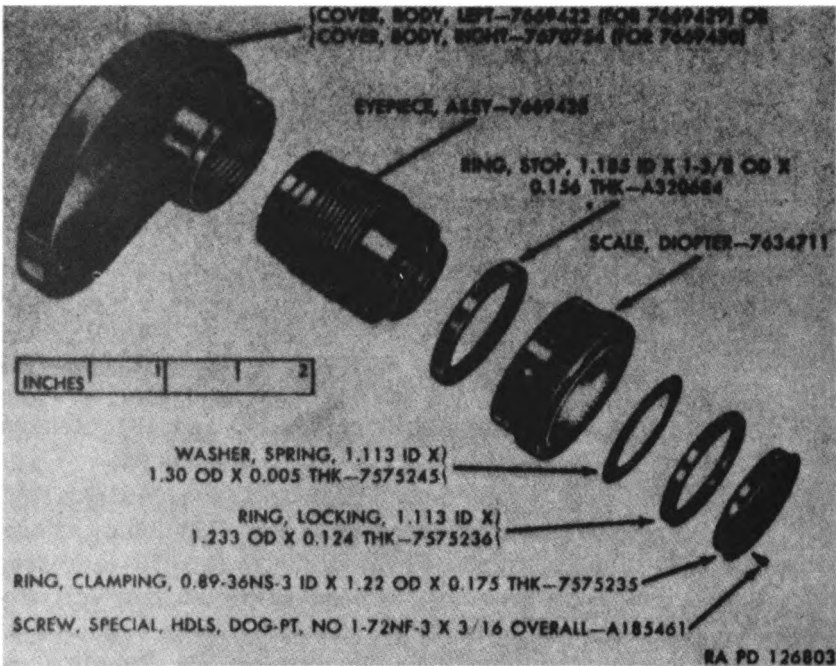

Figure 116. Body cover with eyepiece assembly 7669432 (left, M15) or 7669430 (right, M15) — exploded view.

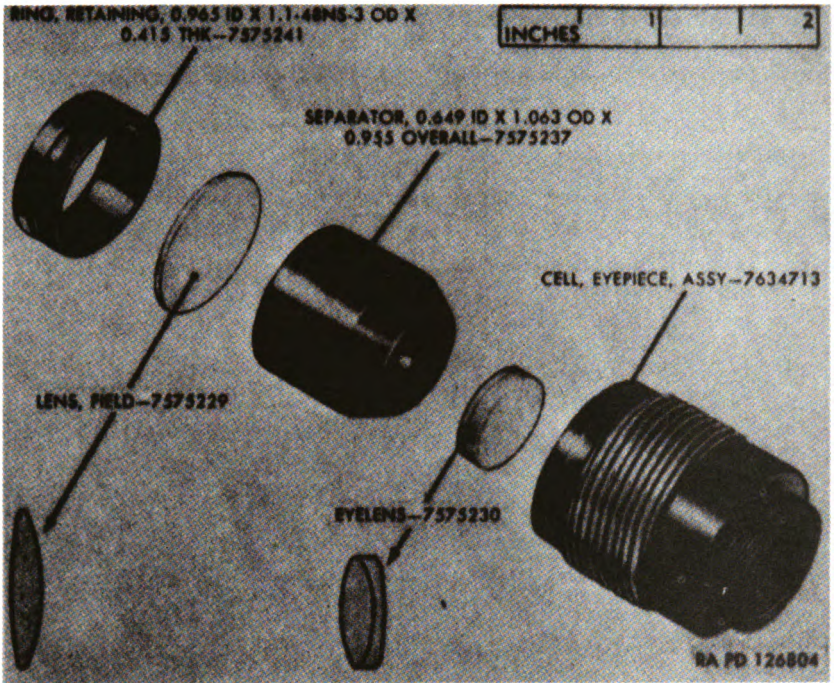

Figure 117. Eyepiece assembly 7669488 (M16 or M16A1) — exploded view.

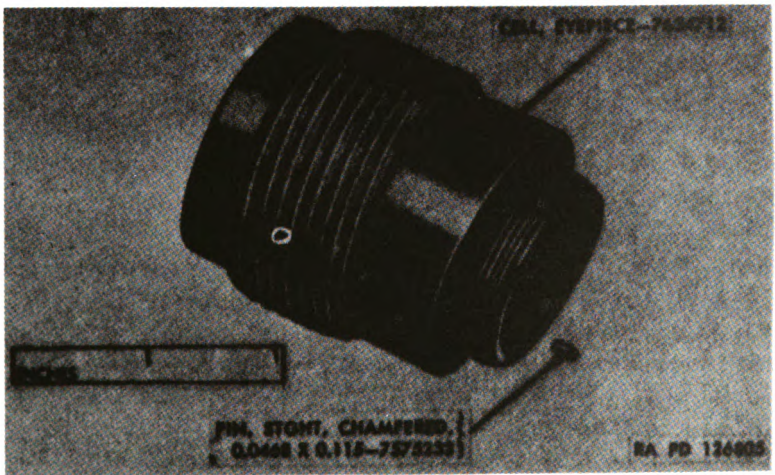

Figure 118. Eyepiece cell assembly 7634713 — exploded view.

by unscrewing the eyepiece cell assembly (fig. 121) to the point of disengagement of the multiple threads. At this point, scribe the cell to the cover and take out the cell assembly. Do not remove the pins from the cell assembly (fig. 118) unless damaged.



Figure 119. Body cover with eyepiece assembly 7670974 or 7670778 or 7672854 or 7673633 or 7673635 or 7676155 — exploded view.

j. Disassemble Prism Shelf Assemblies (figs. 122 and 123). Refer to paragraph 56h.

k. Rebuild of Equipment. Refer to paragraph 68h.

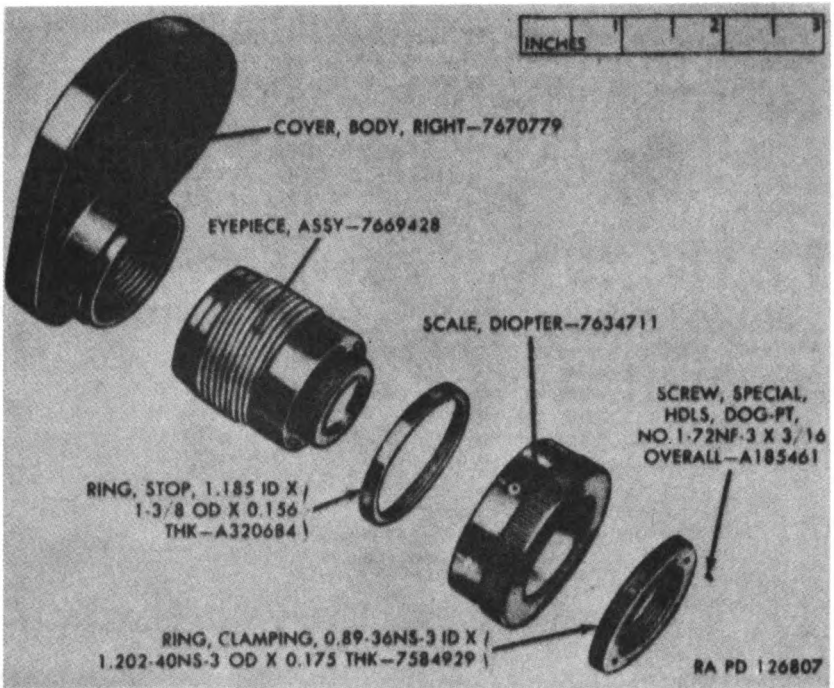

Figure 180. Right body cover and eyepiece assembly 7673696 (M17) — exploded view.



Figure 181. Body cover assembly 7674628 or 7674629 or 7675652 or 7676156 — exploded view.



Figure 122. Prism shelf assembly C131928 or 7670776 or C131930 — exploded view.

113. Assembly

a. *Assemble Body Assembly* (figs. 114 and 115). Proceed as described for binocular M3 (par. 58a), except, if the body bushing was removed from the right body, pin the bushing flange to the body at the eyepiece end with four pins.

b. *Assemble Prism Shelf Assemblies* (figs. 122 and 123). Refer to paragraph 58b.

c. *Install Prism Shelf Assemblies* (fig. 112). Refer to paragraph 58c.

d. *Assemble and Install Objective Assemblies* (figs. 112 and 113). Place the objective in the cell and secure with the retaining ring. Place the objective assembly in the body and install the eccentric adjusting ring around the cell. Place the gasket and the shield over the eccentric ring, engaging the lugs of the shield with the slots in the body assembly. Secure with the locking ring and install the objective cap.

Note. Perform the collimation procedure given in paragraph 37 before sealing the objective assembly.

e. *Assemble and Install Reticle Assembly (M17 and M17A1)* (fig. 111). Refer to paragraph 69e.

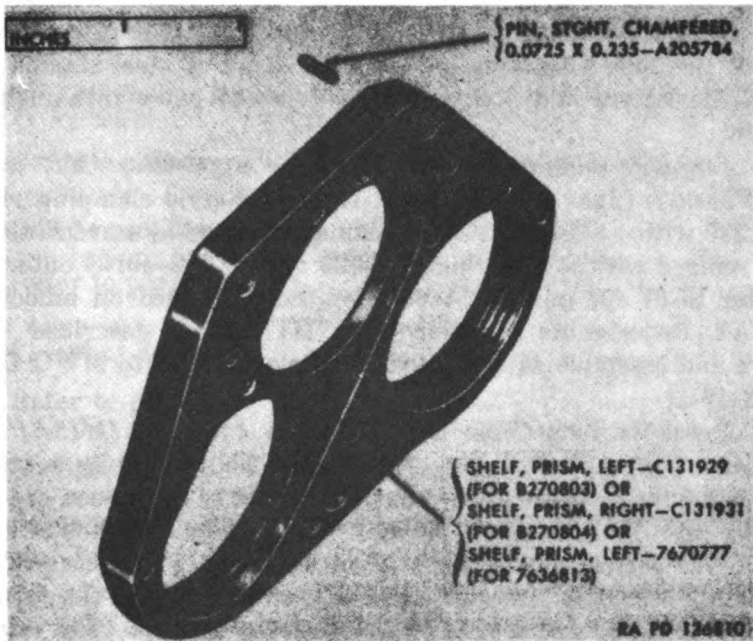

Figure 123. Stripped prism shelf assembly B270803 or B270804, or 7636813 — exploded view.

f. Assemble Body Cover with Eyepiece Assemblies (M15 and M17 with Filters) (figs. 117, 118, and 119). Discard the spring washer 7575245, the locking ring 7575236, and the clamping ring 7575235 (fig. 116) removed at disassembly. Procure a new clamping ring 7584929. Refer to MWO ORD F238-W1. Insert the pins in the eyepiece cell, if removed. Insert the eyelens in the cell assembly and seal with sealing compound (par. 51). Install the separator and the field lens in the cell and secure with the retaining ring. Seal the retaining ring to the cell with shellac. Screw the cell assembly into the body cover (fig. 116), following the scribe marks made at disassembly in meshing the multiple threads. Install the stop ring on the cover. Place the diopter scale on the cell assembly and secure with the new clamping ring as for binocular M15A1 or M17A1. Secure the clamping ring with the dog-point screw. Adjustment of the diopter scale will be made after complete reassembly as described in paragraph 59. Binoculars M15 modified in accordance with this paragraph and by installation of eye guards for filter M1 (*i* below) will be redesignated "M15A1" and binoculars M17 so modified will be redesignated "M17A1." In the field, this will be accomplished by inscribing, with a sharp graver or scribe, "A1" after the present

"M15" or "M17" marking on the body cover. Depots will, at the time of modification, engrave or stamp "A1" after the present "M15" or "M17" marking on the body cover. If steel stamps are used, the letters and figures will not exceed one-eighth inch in height.

g. Assemble Body Cover with Eyepiece Assemblies (M17 without Filters) (figs. 119 and 120). If the old-style clamping ring-7582280 with 1.312-48NS outer diameter is used, discard the ring and replace with a new ring 7584929 with 1.202-40NS outer diameter to fit eye guards 7640802 of the type used on binocular M17A1. Redesignate the binocular "M17A1" as described in *f* above and assemble as described in *h* below. Refer to MWO ORD F238-W1.

h. Assemble Body Cover with Eyepiece Assembly (M15A1 and M17A1) (figs. 118, 119, and 121). Install the pins in the eyepiece cell assembly if these were removed. Screw the eyepiece cell assembly into the body cover, engaging the multiple threads according to the scribe marks made at disassembly. Place the eyelens in the cell assembly and seal (pars. 50 and 51). Install the separator and field lens and secure with the retaining ring. (The retaining ring with 0.132-inch thickness is used on the left eyepiece of binocular M17A1 to allow space for the reticle assembly.) Install the stop ring on the body cover. Place the diopter scale over the stop ring and secure with the clamping ring and the dog-point screw. Adjustment of the diopter scale will be made after complete assembly as described in paragraph 59.

i. Install Body Cover with Eyepiece Assemblies (figs. 108 and 110). Place a light coating of sealing compound (par. 51) around the inside edges of the body cover and around the outer edges of the body opening. Place the gasket over the opening and install the body cover with eyepiece assembly. Secure with the five screws. Install eye guards 7640802 with an annular groove for filter M1; discard other eye guards if removed at disassembly. Refer to MWO ORD F238-W1.

Section II. TESTS AND ADJUSTMENTS

114. Definition of Field of View and Proper Diopter Setting

Refer to paragraph 59.

115. Tilt of Field of View

Adjustment for tilt of field of view was made at the time of re-assembly. Refer to paragraph 60.

116. Parallax and Eyepiece Movement

Refer to paragraph 61 for procedure.

117. Stagger

Refer to paragraph 62.

118. Interpupillary Setting

Refer to paragraph 63.

119. Tilt of Reticle

Refer to paragraph 64.

120. Collimation

Refer to paragraph 65 for procedure, except use wrench 41-W-3740-200 (fig. 14) to rotate eccentric ring and objective cell.

CHAPTER II

REPAIR AND REBUILD OF BC TELESCOPE M65 AND TELESCOPE MOUNT M48

Section I. GENERAL MAINTENANCE

121. General

a. Information and instructions herein are supplementary to instructions for the using organization contained in TM 9-575.

b. This chapter contains general and specific maintenance instructions for the repair and rebuild of each major component of BC telescope M65 and mount M48. In the following sections, specific adjustments, repairs, and rebuild procedures are described. Each major component is restored to a serviceable condition by disassembling its assemblies and subassemblies, by inspecting, by replacing parts, and using necessary machining operations followed by reassembly, tests and adjustments, and final inspection.

c. The general maintenance methods given in paragraphs 37 through 52 are applicable also to BC telescope M65, telescope mounted M48, and equipment. In addition, paragraphs 122 through 124 detail general maintenance methods which involve components or procedures peculiar to the BC telescope or to the mount.

122. Worm and Worm Gear Mechanism

a. General. The worm and worm gear principle is used in the BC telescope and mount as a means of rotation in azimuth and in elevation. Figure 124 illustrates a typical worm and worm gear mechanism. Note that the lateral movement of the worm is prevented by the worm ball cap which is threaded for adjustment, and that the worm is held in mesh by a spring and plunger arrangement on the one end. Before proceeding with any maintenance work in connection with this type of mechanism, all maintenance work for the worm shaft, as outlined in *b* below, must be thoroughly understood and, if necessary, accomplished.

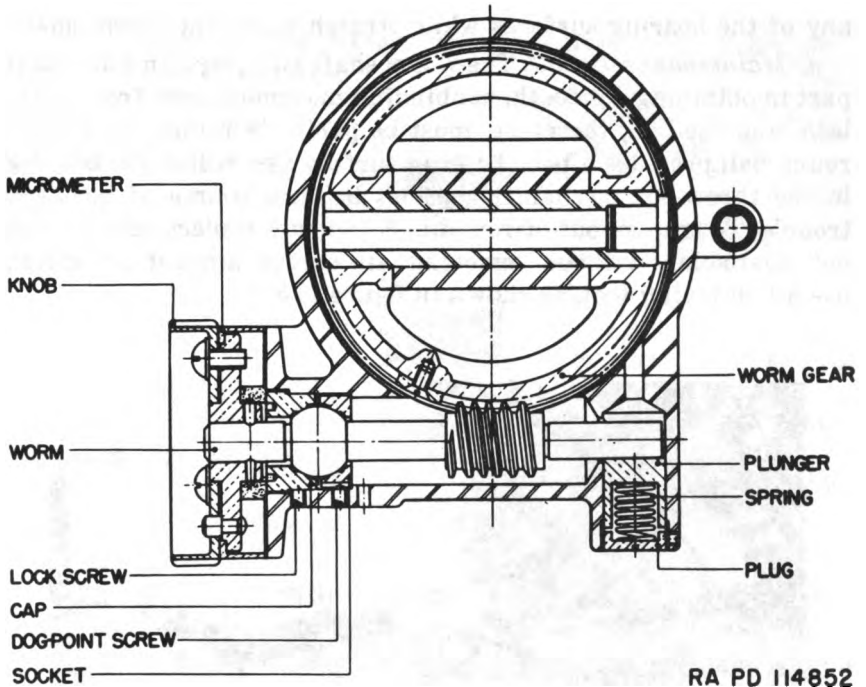

RA PD 114852

Figure 124. Typical worm and worm gear mechanism.

b. Maintenance of Worm Shaft. For a worm shaft to operate properly, the shaft itself must be absolutely true and straight so as to prevent the worm from being thrown off center at each revolution of the shaft and causing a binding movement in the worm and worm gear mechanism. If such binding occurs, it is frequently due to a bend or, more often, several bends in the shaft. In such cases, the entire worm shaft should be replaced. It may sometimes, however, be necessary to try to locate and straighten these bends. This process involves much skill and the ability to select from a wide variety of methods those best suited to the particular condition found. No specific procedure can be specified. If the shaft is not too badly bent, one method is to straighten it by tapping with a lead hammer. If the shaft cannot be straightened, replace with a new one.

Caution: After lapping has been completed, remove all lapping compound to prevent continued wear to the parts. In addition, do not lap ball sockets having plastic inserts.

Generally, the entire length of the shaft must be continually tested during the straightening process, and the shaft must be straightened to a point where the worm thread will be no more than 0.001 inch off center when the shaft is rotated in its bearings. Care must be taken to avoid damaging the worm thread or

any of the bearing surfaces while straightening the worm shaft.

c. Maintenance of Ball. The worm shaft ball plays an important part in obtaining a smooth, nonbinding movement free from backlash, and the ball, therefore, must be perfectly round. An out-of-round ball provides a poor bearing surface and will cause binding in the throw-out mechanism besides being a source of backlash trouble. To true an out-of-round ball (when a replacement part is not available) without removing an excess amount of metal, use a ball truing tool, as shown in figure 125.

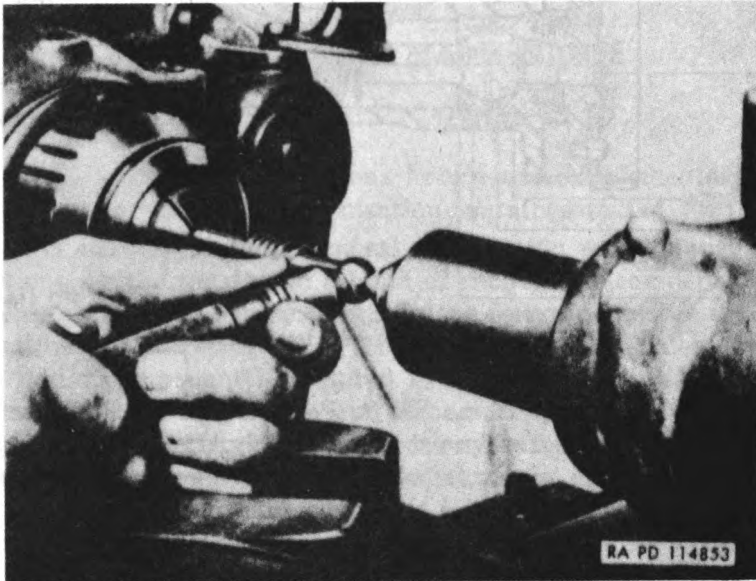
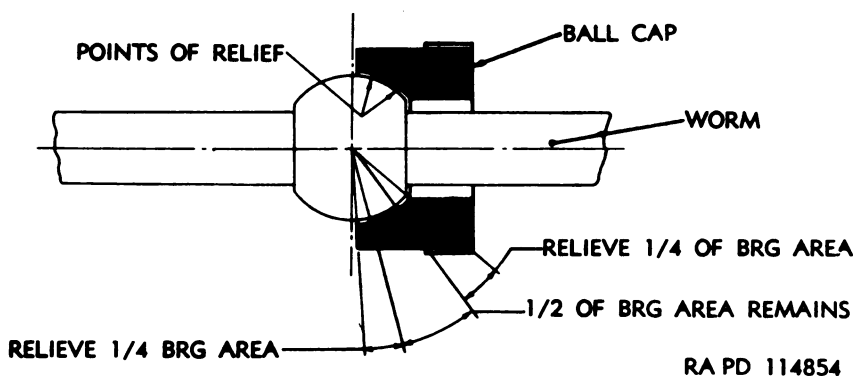

Figure 125. Use of ball truing tool.

d. Fitting Ball Cap and Socket to Ball.

- (1) See that the spherical bearing surfaces on the ball cap and ball sockets have been relieved, as shown in figure 126, before fitting these parts to the ball. The relief may be accomplished with a small bearing scraper made for this purpose. If this is not done, the adjustment of the ball cap becomes very critical. Too much bearing surface on these parts tends to lock or bind the worm shaft movement when the ball cap is brought against the ball. Relieving the bearing surfaces reduces the tendency of these parts to lock themselves on the ball, and the adjustment of the ball cap becomes less critical. Do not cut away more than one-half of the bearing surface, as too

little bearing surface will cause rapid wear with consequent backlash.



RA PD 114854

Figure 188. Points of relief on ball cap.

- (2) The initial fitting is performed by placing the worm shaft in a lathe collect and applying compound (fine pumice) to the ball. Both ball cap and socket are then slipped onto the shaft and held together around the ball while the lathe is turning at a slow speed. This lapping process should continue until a good bearing surface is shown on the ball cap and socket. The cap and socket must then be washed in solvent and assembled in the instrument with a very fine film of the same lapping compound on the ball. The worm shaft is then turned about six times to perform a finish lapping. Then the assembly must again be removed and washed thoroughly in dry-cleaning solvent or volatile mineral spirits. The bearing surfaces should now show a smooth, satin finish. If so, further polishing or burnishing of the parts is unnecessary.

Caution: Do not lap ball caps having plastic inserts as on telescopes of late manufacture.

e. Fitting Plunger to Housing. The plunger must fit in the housing without any side play. If it fits loosely, the worm shaft will have side play which will appear as backlash on the micrometer dial. In order to facilitate handling of a new plunger, when fitting, select a piece of brass or steel rod, a little larger in diameter than the spring hole in the plunger, and turn a slight taper on the end of it. Then force the plunger tightly on the rod. The rod must not turn within the plunger. Lap the plunger in the housing so that the plunger will be free enough to move smoothly up and down when a slight finger pressure is exerted against it.

f. Fitting Plunger to Worm Shaft.

- (1) The worm shaft must fit in the semicircular bearing surface of the plunger without any side play. If side play is present, this will appear on the micrometer dial as backlash, as in the case of a loose fitting plunger. Before lapping in, relieve the center portion of the semicircular bearing. This is done so that the worm shaft will wear itself in deeper, reducing the possibility of developing side play.
- (2) Mount the worm shaft in the housing and adjust the ball cap so that there will be no end play in the shaft. Apply a thin coating of lapping compound (fine pumice) to the plunger's semicircular bearing surface and then insert the plunger into the housing. Insert the plunger spring. Screw in the plug until it is flush with the surface of the housing. Lap in by turning the worm shaft a few turns in each direction. Remove the plunger and clean it in solvent so that the bearing surface can be observed. Lap until there is complete contact of the worm shaft on the semicircular bearing surface of the plunger and worm shaft and clean parts thoroughly. Reassemble into housing and check for side play.

g. Fitting Worm to Worm Gear.

- (1) Before lapping is started, always clean the parts thoroughly and examine the teeth for nicks, burrs, and sharp edges. If a new worm is to be installed, place the worm in a lathe chuck, and with the lathe running at slow speed, file a slight radius on the corners of the worm thread. Whether a new or old worm is used, it is always best to check the gear mesh before lapping is started. Wipe a fine coat of Prussian blue on the worm thread and assemble the instrument. Turn the worm over the entire range of movement and then disassemble. Check for high spots, bottoming, etc. Scrape off the high spots. If an old worm is bottoming in the worm gear, set the worm up in a lathe and turn off about 0.010 inch from the outside diameter of the worm thread. Recheck to insure that the worm is not bottoming on the worm gear.
- (2) If a new worm bottoms in the worm gear, then the worm gear teeth are worn excessively and a new worm gear should be installed. When the bearing of a new worm in an old worm gear is checked, it may be found that the new worm is riding on the corners of the worm thread, because the old worm had a larger radius on the corners. Do not increase the radius on the new worm. Examine

the corners of the worm gear teeth. If there is a visible ridge, scrape it off with a three-cornered scraper. If no ridge is visible, proceed to lap in the worm until an even, smooth movement is obtained and the bearing is shown on the sides of the worm and worm gear teeth. When lapping worm and gear, better results will be obtained by removing the spring behind the plunger and installing a solid plug. In this manner, any minute high spot which might be rolled over will be removed, thus increasing the perfection of the fit. After lapping is finished, place the worm shaft in a lathe and increase the radius on the corners of the worm thread. This is done so that as the movement wears, the worm will move in without developing a bearing on the corners of the thread. A corner bearing will prevent the worm from moving into proper mesh, and backlash will develop.

h. Circular Error.

- (1) Although a worm and worm gear mechanism may operate smoothly and have backlash within the allowable tolerances, there may still be an error in the mechanism due to poorly spaced worm gear teeth. This condition, known as "circular error," is found in mechanisms having scales attached for measuring angles, and will cause errors in scale readings when using the instrument. The condition may be checked by setting up a number of known mil angles and checking the instrument against them, or through testing of the instrument in an azimuth testing fixture (see table II for information regarding this fixture).
- (2) Slight errors may be eliminated as follows: first, locate those teeth on the worm gear that are causing the error. Then determine how they must be corrected to insure that the scale reading will accurately reflect the actual line of sight. Then scrape the faulty teeth to adjust the fit so as to correct the error.
- (3) If the above method is not sufficient, and a replacement part is not available, another method may be used in an emergency. Drift the teeth of the worm gear slightly, as required, through use of an old worm or an offset punch that fits each tooth snugly. Hold the punch or the old worm at the determined point of error. Tap or push the worm gently, but with sufficient force to correct the error. Assemble the mechanism and recheck circular error.

i. Backlash.

- (1) **General.** Backlash is one of the main factors contributing to the malfunctioning of moving mechanical parts. It is free play, or movement of the driving member without corresponding movement of the driven member. The total absence of backlash is the ideal condition for instruments. It is well known, however, that small amounts of backlash must be present in order to obtain smoothly functioning and operable mechanical movements. Tolerance limits for backlash have, therefore, been established for the BC telescope and its mount (pars. 31 and 32). There are many causes for backlash. The most prevalent are looseness in gear meshes, end play in shafts, side play in bearings, and binding in bearing surfaces. In many cases, it will be found that total backlash is a result of combinations of these causes.
- (2) **Inspection for backlash.** The inspection for backlash is primarily a means for determining the angular distance through which the driving member of a mechanism, e.g., a worm, moves before causing movement of the driven member, e.g., a worm gear (par. 31).
- (3) **Looseness in gear meshes.** This type of backlash is due to the slack or looseness between the mating members of a mechanism. A close mesh of the worm with the teeth of the worm gear is obtained by means of pressure against the worm shaft from a spring and plunger (fig. 124). If the teeth are not firmly in mesh, there may be rotation of the worm without a corresponding movement of the worm gear. This condition may be due to a weak plunger spring (fig. 127), which does not force the worm all the way in or which permits it to ride out instead of turning the worm gear. It may be due to burrs or irregularities on the plunger or its housing which do not permit the plunger to bear strongly on the worm shaft. It may be due to the fact that the worm and worm gear are so badly worn that the worm shaft bears on its housing (fig. 128), and the worm is thus prevented from meshing fully with the worm gear. It may also be due to improper clearance between the micrometer and the housing (fig. 129). The lost motion, or slack, may also result from "bottoming" which prevents full mesh of the teeth. "Bottoming" (fig. 130) is the condition which exists when the crests of the teeth of one member bear in the troughs of the other.

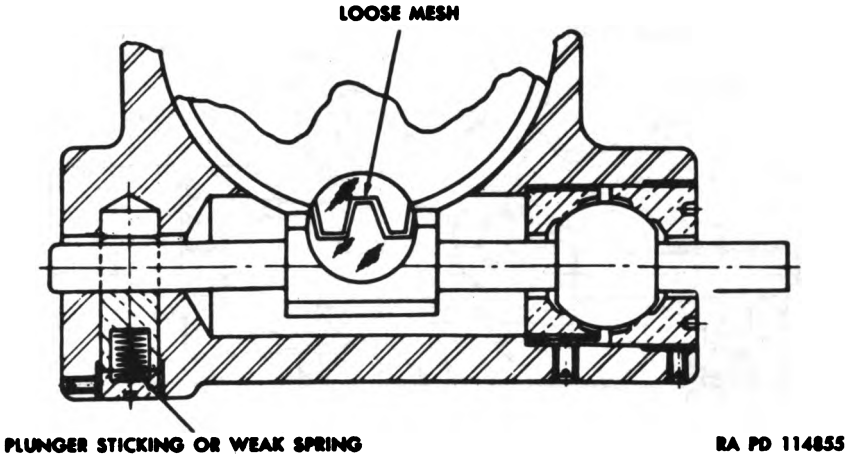

Figure 187. Plunger sticking on weak spring.

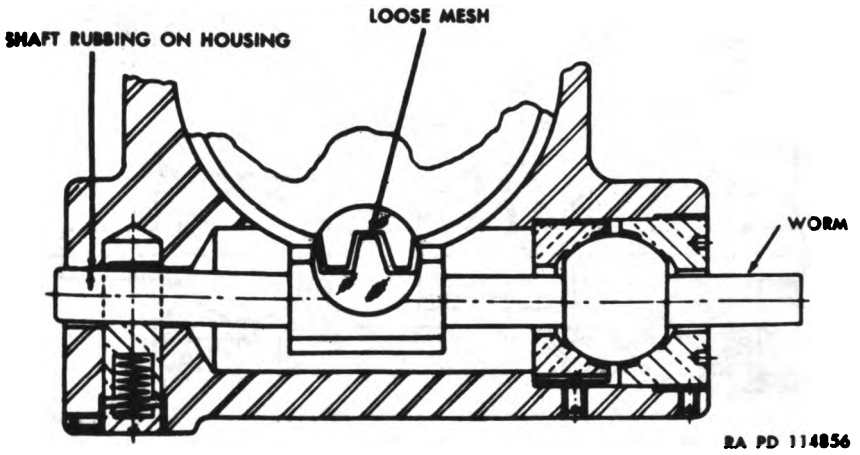

Figure 188. Shaft rubbing on housing.

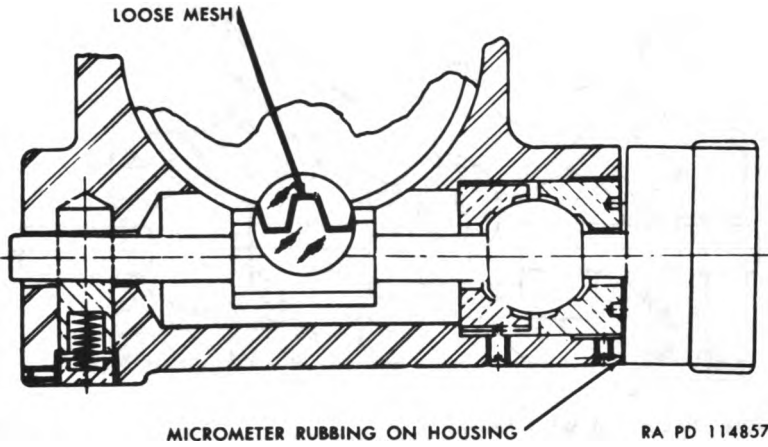

Figure 189. Micrometer rubbing on housing.

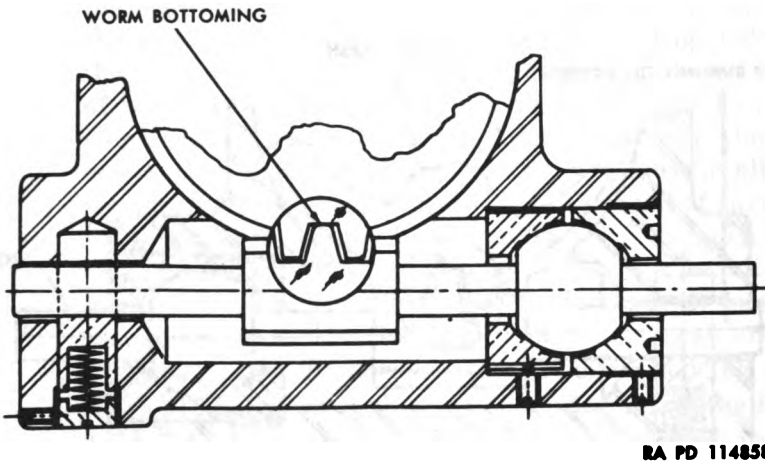
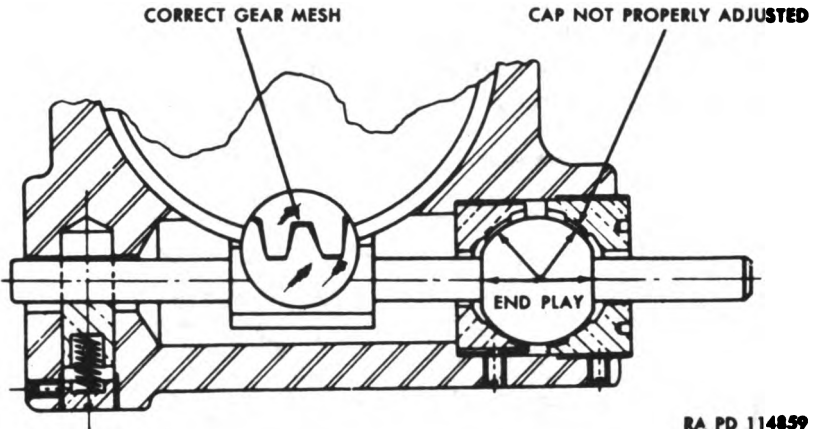

Figure 180. Worm bottoming in worm gear.

- (4) *End play.* End play is the term applied to lengthwise movement of a shaft (fig. 131). Such movement, in a moderate degree, is acceptable when it does *not* contribute to the total backlash. Shafts are normally restricted longitudinally by shoulders, collars, thrust bearings, ball caps, and sockets, or by a combination of these. Ball caps and sockets and worm shaft balls are used for this purpose in the matériel covered in this chapter, the worm shaft ball being held between the ball cap and the socket. If the ball cap is loose, and the ball socket does not bear firmly and uniformly upon the ball, end play in the shaft will result. As the worm shaft is rotated, the slack between the ball and ball cap or socket must be taken up before the shaft will cause the worm gear to rotate.



RA PD 114859

Figure 131. End play in worm shaft.

- (5) *Reduction of backlash.* On worm and worm gear mechanisms, backlash may be reduced by tightening the ball cap against the worm shaft ball. Backlash may sometimes be reduced by replacing the plunger spring. In cases of emergency only, the spring may be shimmed. Backlash may be eliminated by removing irregularities from the plunger which might prevent its movement, or by filing away or relieving the shaft housing if the shaft bears against it. Bottoming of the worm may be eliminated by turning off a small amount of metal from the worm, worm gear, or both.
- j. Chatter.* A chattering movement is usually an indication of a tight ball cap. If adjustment of the ball cap does not cure the trouble without producing excessive backlash, the trouble is else-

where. The ball cap and socket may not be properly relieved, as shown in figure 126, in which case these parts will grip the ball tightly as soon as the ball cap is touching the ball. The ball may be out of round, or the ball cap and socket may not be properly lapped in. The plunger spring may be too tight, or the worm not lubricated. The dog-point set screw which keeps the ball socket (fig. 132) from turning in the housing, may be tight against the socket. The socket is a floating fit in the housing, i.e., the outside diameter of the socket is about 1/64-inch smaller than the diameter of the bore in the housing. When the ball cap is brought against the ball, the socket will center itself on the ball, unless the dog-point screw prevents it from doing so. When the socket is placed in the housing, see that the dog-point is in the groove in the socket and that the socket is free to move from side to side in the housing. After the ball cap has been properly adjusted against the ball, screw the dog-point screw in until it touches the socket and then back it out about one-quarter turn. If the screw is tight against the socket, it is forcing the socket off center, thereby producing a rough or chattering movement.

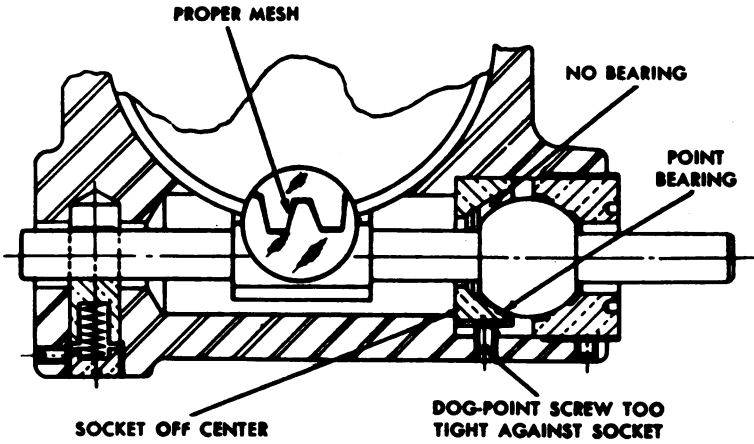

RA PD 114860

Figure 138. Dog-point screw tight against socket.

k. Clicking.

- (1) Clicking can be felt when the worm knob is held between the thumb and forefinger and turned back and forth a few mils. Every time the rotation of the knob is reversed, the movement is loose for a short distance (1 to 3 mils) until a click or bump is felt in the knob when the lost motion has reached its limit. The reason for this is that the dog-point setscrew is fitting loosely in the

threads in the housing, or the dog-point fits loosely in the groove in the socket, or a combination of both (fig. 133). Every time the motion of the knob is reversed, the socket will move in the housing until the dog-point screw has cocked over to the other side. Once it is started, this clicking will grow progressively worse. This condition cannot be permitted to exist because the loose spot is always at the setting point. Turn the knob in the opposite direction from which it was brought to the setting point, or the instrument will be off target. This loose spot in the movement is *not* lost motion which affects the accuracy of the instrument, but it makes the instrument unreliable because it will not hold a set reading. If this condition is found in an elevation or cross-leveling movement (par. 147), watch the level vial bubble move off center when the knob is moved between the limits of the loose portion.

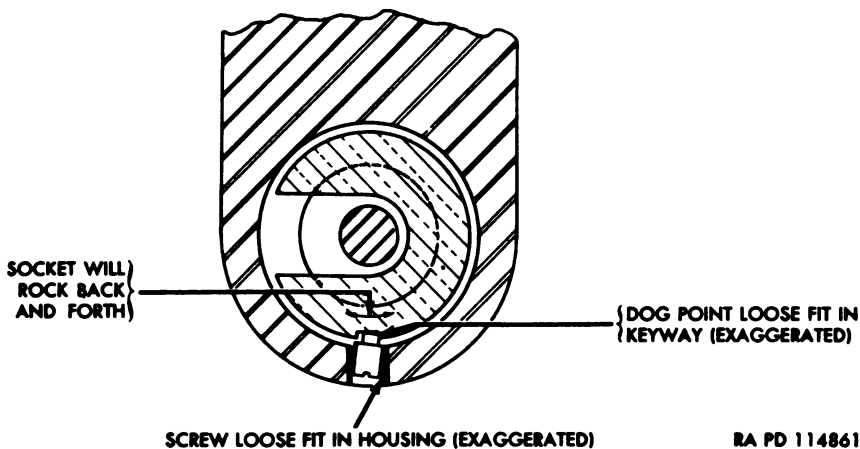

Figure 133. Dog-point screw loose in threads in housing.

- (2) The only remedy for this condition is to install a screw that fits snugly in the housing, and make sure that the dog-point screw fits in the slot in the socket. The repairman should never disturb the dog-point screws. When they are properly set, turning these screws in and out serves no other purpose except to work the screw loose in the housing, and the clicking conditions will result.

1. *Binding.* A binding or uneven movement is usually caused by a bent worm (*b* above). A bind may also be due to the presence of dirt between the worm and worm gear, or by a burr on one of

the teeth. If a burr is present, remove it with a stone, file, or scraper. Polish the area with crocus cloth, lubricate and assemble the parts, then recheck the movement.

123. Tubular Level Vials

a. *Removal of Level Vials from Tubes.*

- (1) To remove any vial from its tube depends upon whether or not the vial is broken. A broken vial may be removed merely by breaking out the old plaster of paris or calcined gypsum, glass, and paper. However, to remove a vial without breaking it calls for exercise of skill and patience. Some of the conditions under which it may be desirable to remove and save a vial for future use are: calcined gypsum broken down in service allowing vial to move within the tube; vial not well centered in tube, causing improper adjustment with jack screws; spare vials in wrong type of tube for instrument to be repaired, etc. The tools used for removing vials are a scriber and a piece of curved steel such as part of a flexible rule.
- (2) If the gypsum is not brick hard, enough of it can be removed to allow the vial to be pushed out. When the gypsum has become very hard, it may be broken down by soaking in vinegar or ordinary photographer's hypo solution for several hours. Another method is to apply penetrating oil to the gypsum, not to soften it but to lubricate that part which cannot be reached with the tools, thus helping the vial to slide out of the tube.

b. *Installation of Tubular Vial in Tube.*

- (1) *Assembly.* The accuracy of the instruments and the maximum adjustment of the vials depends on the care with which they are set in the tubes. This step can best be accomplished by placing the tube in a "V" block 41-B-1472-100 with the shoulder extending over the edge, and placing the "V" block on a cross-leveled surface plate 41-P-1565 (fig. 134). The vial can be fairly well centered in the tube by wrapping narrow single turns of gummed paper near each end. Do not overlap the ends of the paper. Also, leave sufficient space on each end for gypsum. Insert vial in the tube. If one turn of paper is not enough to center vial in the tube, add single turns to each end until vial is well supported. If bubble does not come within one graduation of center, thin wood or metal shims pushed between wood and paper can be used to

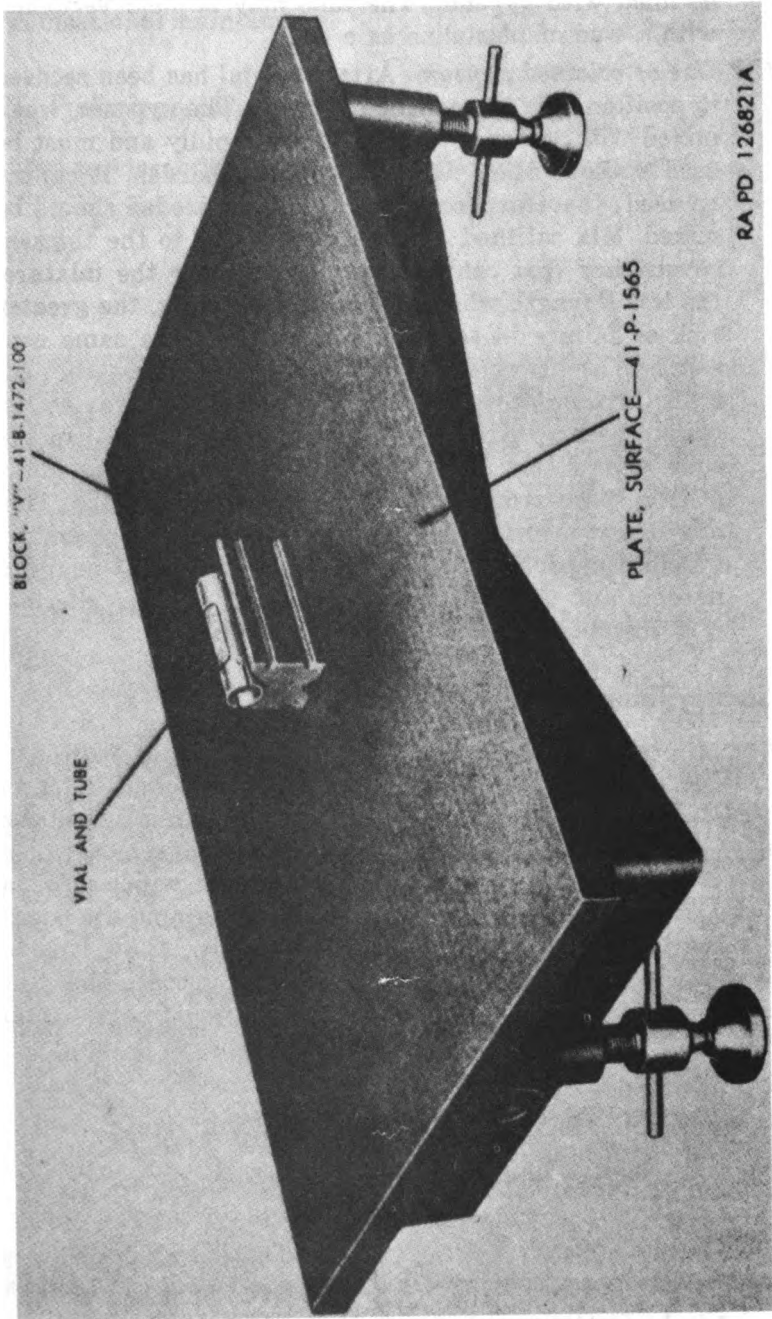

Figure 194. Vial and tube in position for leveling.

obtain level position. Be sure vial will maintain its position in the tube, as the assembly must stand on end to be filled with gypsum. The tube may be held vertically with a wad of plasteline as a base.

- (2) *Use of calcined gypsum.* After the vial has been secured in position, mix the calcined gypsum. The gypsum, when mixed with water, will tend to set rapidly and must be used without delay. Once it starts to harden, it cannot be used; therefore, only as much as is needed should be mixed. Mix calcined gypsum with water to the thickest consistency that can be used. The thinner the mixture, the less strength when set and consequently, the greater risk of failure in service. A mixture of the same consistency as heavy syrup is satisfactory. Force the calcined gypsum down between vial and tube as far as the paper spacer, being careful not to move the vial in the tube. Completely fill jack screw end of tube, but allow a little space around shoulder or split end of tube. This end acts as a spring to solidly support the tube assembly. Calcined gypsum should be given not less than 2 hours to harden, and up to 24 hours when the time permits, before installing and adjusting the assembly.

124. Sealing Telescope Windows

Windows used in BC telescope M65 should be sealed with synthetic rubber cement or knife-grade caulking compound. Refer to ORD 3 SNL K-1. Best results are obtained by applying the rubber cement with a metal hypodermic needle and syringe although a small glass or metal rod may be used. Center the window in its cell on the frame, and apply one strip of cement around the edges in the space between the frame and the window. Allow this to dry (it dries very quickly), then apply a second coat. The first application shrinks slightly while drying, thus requiring a second coat.

Section II. REBUILD OF BC TELESCOPE M65 AND TELESCOPE MOUNT M48

125. General

Organizational maintenance of BC telescope M65 and telescope mount M48 is described in TM 9-575. Preventive maintenance services, care in handling, lubrication and cleaning of mechanical parts, cleaning optical parts, organizational spare parts, tools and

equipment, and serviceability tests are included in TM 9-575. This section contains procedures which are beyond the scope of organizational maintenance.

126. Preliminary Inspection

The serviceability of the BC telescope, telescope mount, and equipment should be determined as described in paragraphs 31 and 32.

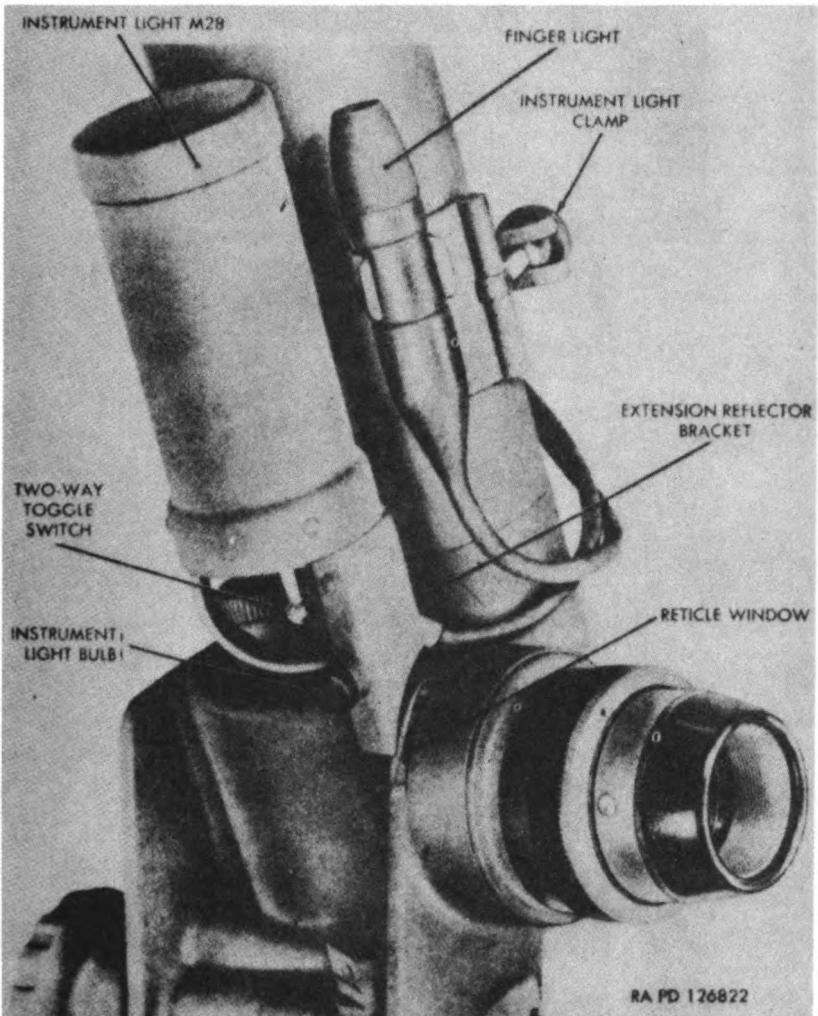

Figure 135. Instrument light M28 mounted on right telescope tube.

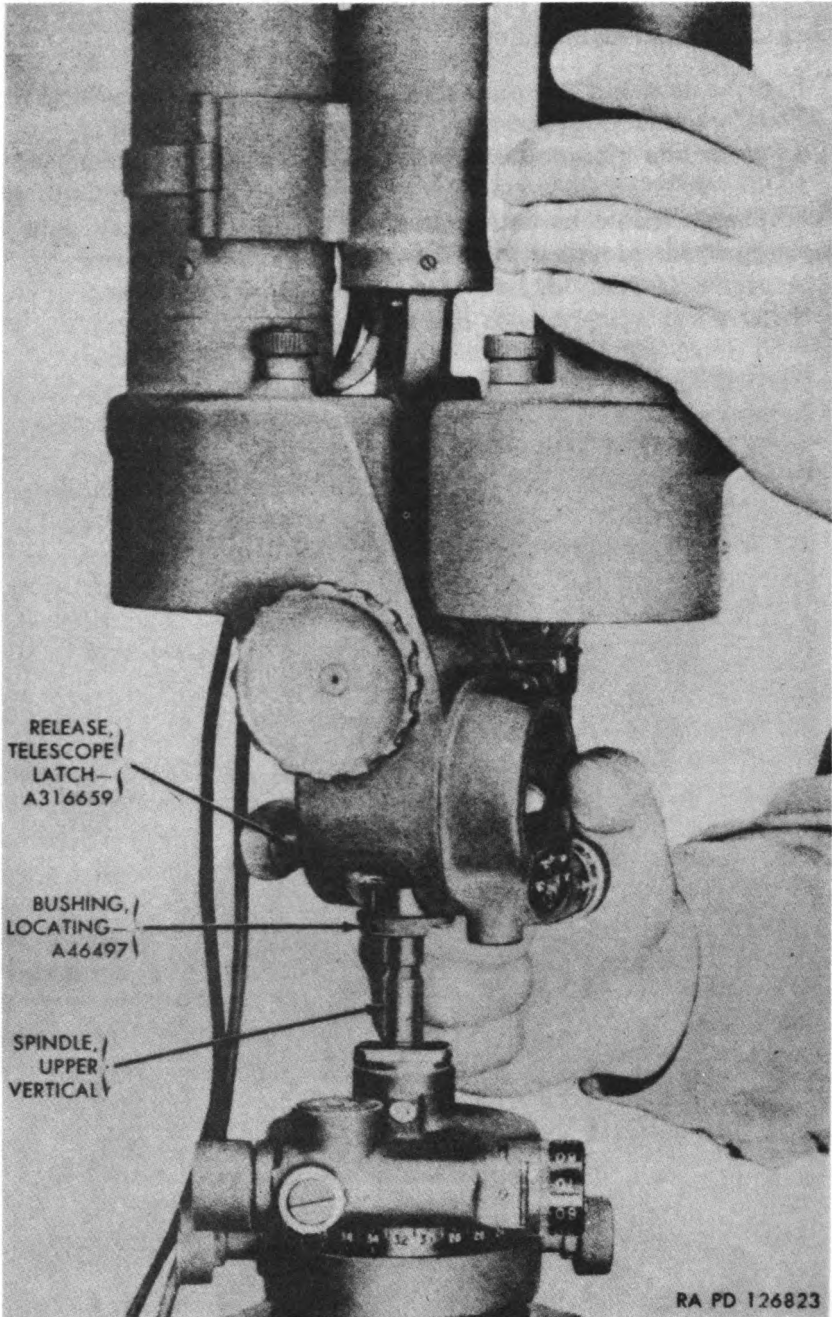

Figure 136. Removing BC telescope M65 from telescope mount M48.

127. Disassembly of BC Telescope M65

a. *Remove Instrument Light M28* (fig. 135). Loosen the clamping screw and remove the instrument light from the right telescope tube.

b. *Remove Telescope from Mount.* If the BC telescope is installed on the mount M48, depress the latch release and lift off the telescope (fig. 136).

c. *Remove Head Assembly* (fig. 137). Apply heat to soften the sealing compound (par. 42) between the head assembly and the two round nuts. Remove the set screws from the round nuts and with spanner wrench 41-W-3249-740 (fig. 138), unscrew the two round nuts. Loosen head assembly and remove from the tubes.

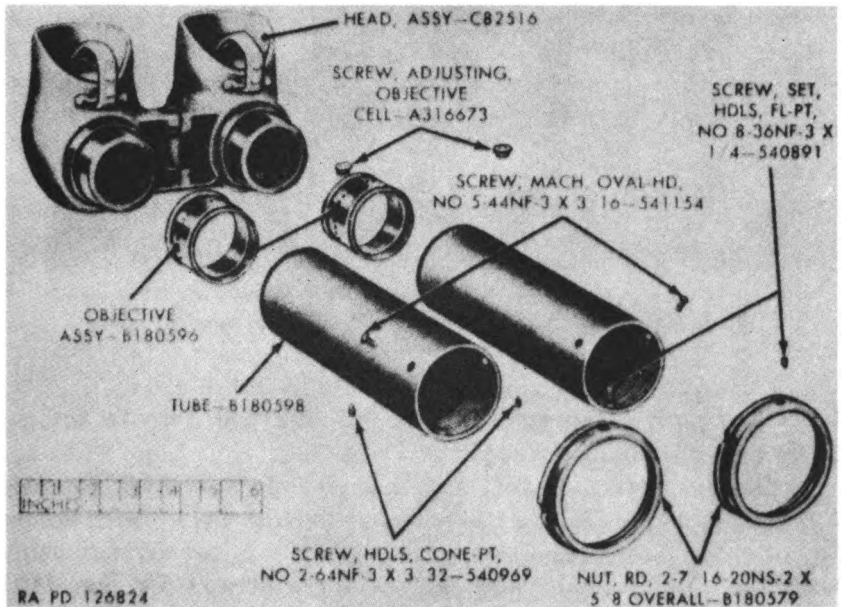

Figure 137. BC telescope M65 — partial exploded view.

d. *Remove Tubes and Objective Assemblies* (fig. 137). Scribe an identifying mark on the right tube and housing. Apply heat to soften the sealing compound between the tube and housing (par. 42), remove the three oval-head machine screws, and unscrew the tube from the housing. Except for the scribe mark, remove the left tube from the left housing in the same manner. Remove the objective cell adjusting screws from the tubes using wrench 41-W-3248-110 (fig. 15) and scribe the objective cell through the screw hole with a circular mark. Remove the setscrews from the

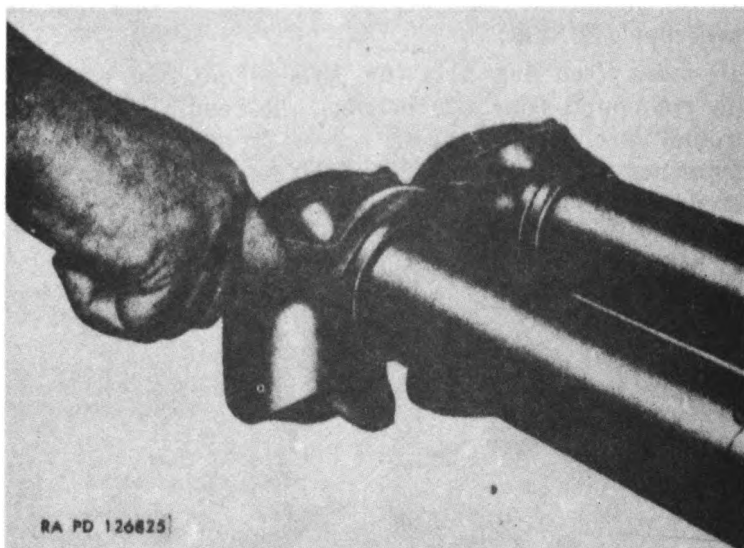

Figure 138. Using spanner wrench 41-W-3249-740 to remove head assembly C82616.

tubes and with tubular wrench 41-W-3726-250, remove the objective assemblies (fig. 139).

e. Remove Interpupillary Screw Assembly and Left Housing Support Bracket. Remove the four screws (fig. 141) which secure the interpupillary screw assembly (fig. 142) to the right housing assembly (A, fig. 141) and remove three screws (T, fig. 140) which secure the left housing support bracket to the left housing. Remove and separate the interpupillary screw assembly and the bracket (J, fig. 140). Remove the pins (K and V, fig. 140).

f. Remove Left Eyepiece Assembly (fig. 140). Remove the eye guard (S). Remove the screw from the diopter scale clamping ring (Q) and take off the clamping ring and the diopter scale (P). Remove the three screws (M) from the eyepiece sleeve (N) and take off sleeve. Remove the oval-head screw (H) from the housing and unscrew the eyepiece assembly after softening the sealing compound, as necessary (par. 42).

g. Remove Right Eyepiece Assembly and Reticle Assembly (fig. 141). Remove the eye guard, clamping ring, diopter scale,

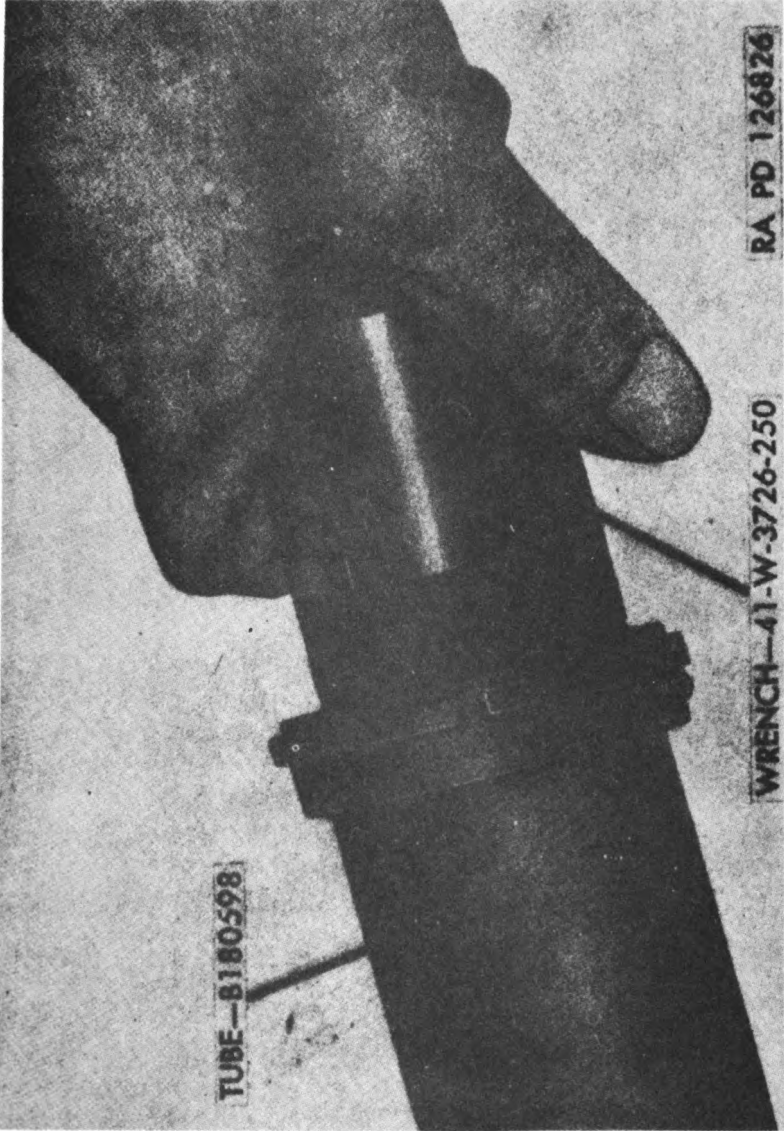

Figure 139. Using tubular wrench 41-W-3726-250 to remove objective assembly B180598.

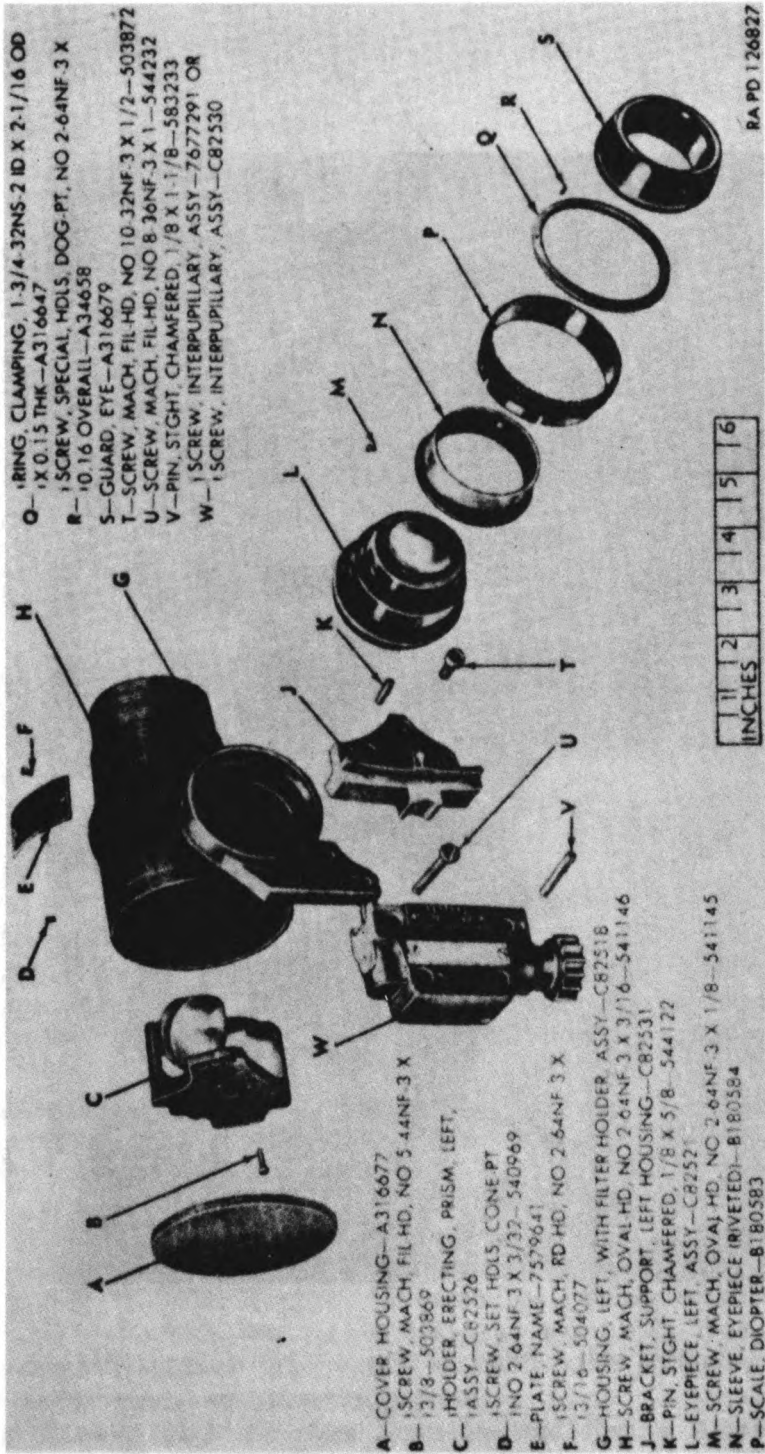
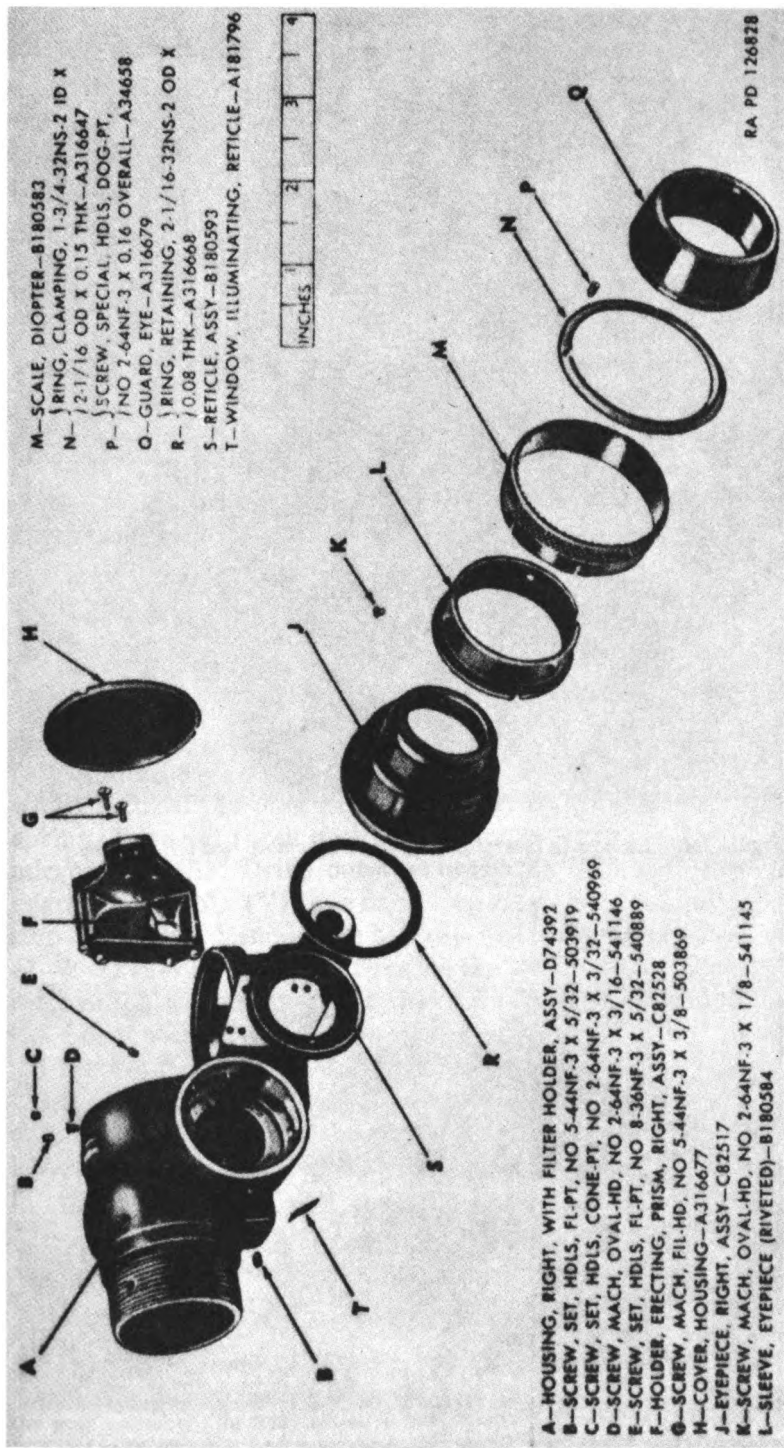

Figure 140. BC telescope M65 — partial exploded view.



M—SCALE, DIOPTR—B180583
 N—RING, CLAMPING, 1-3/4-32NS-2 ID X
 2-1/16 OD X 0.15 THK—A316647
 P—SCREW, SPECIAL, HDLS, DOG-PT,
 /NO 2-64NF-3 X 0.16 OVERALL—A34658
 Q—GUARD, EYE—A316679
 R—RING, RETAINING, 2-1/16-32NS-2 OD X
 /0.08 THK—A316668
 S—RETICLE, ASSY—B180593
 T—WINDOW, ILLUMINATING, RETICLE—A181796

A—HOUSING, RIGHT, WITH FILTER HOLDER, ASSY—D74392
 B—SCREW, SET, HDLS, FL-PT, NO 5-44NF-3 X 5/32—503919
 C—SCREW, SET, HDLS, CONE-PT, NO 2-64NF-3 X 3/32—540969
 D—SCREW, MACH, OVAL-HD, NO 2-64NF-3 X 3/16—541146
 E—SCREW, SET, HDLS, FL-PT, NO 8-36NF-3 X 5/32—540889
 F—HOLDER, ERECTING, PRISM, RIGHT, ASSY—C82528
 G—SCREW, MACH, FIL-HD, NO 5-44NF-3 X 3/8—503869
 H—COVER, HOUSING—A316677
 J—EYEPiece, RIGHT, ASSY—C82517
 K—SCREW, MACH, OVAL-HD, NO 2-64NF-3 X 1/8—541145
 L—SLEEVE, EYEPiece (RIVETED)—B180584

RA PD 126878

Figure 141. BC telescope M66 — partial exploded view.

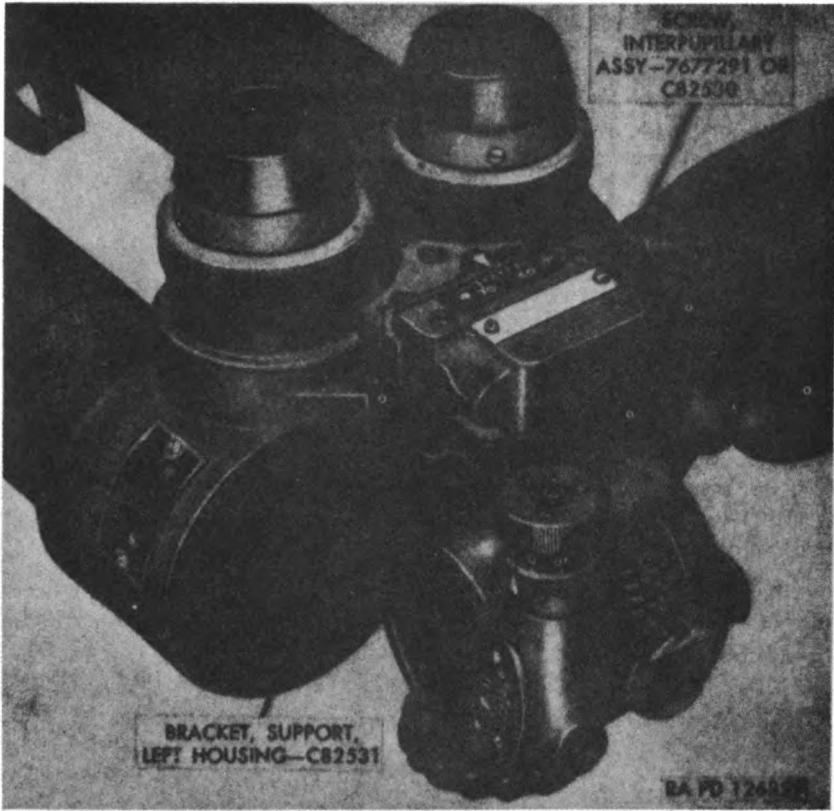

Figure 142. Removing interpillary screw assembly and left housing support bracket.

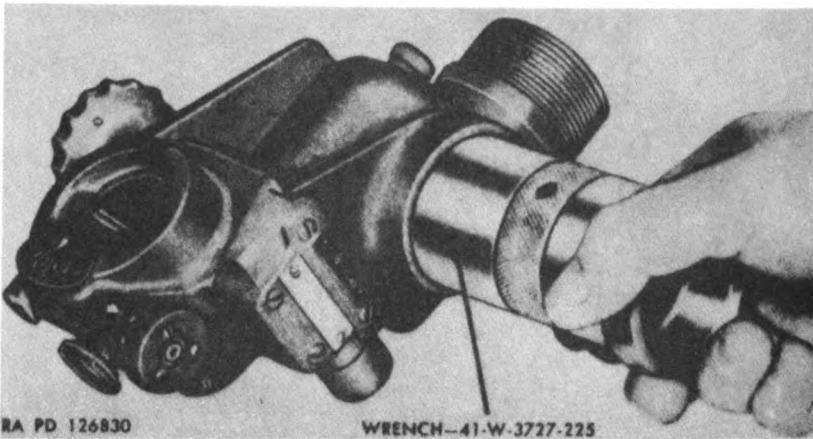

Figure 143. Removing retaining ring A31668 with wrench 41-W-3727-225.

and eyepiece sleeve as described *f* above. Remove the oval-head screw (D) and unscrew the eyepiece assembly (J) as described in *f* above. Remove screw (E) and with wrench 41-W-3727-225 (fig. 143), remove the reticle retaining ring (R). Loosen four screws (B) which position reticle assembly and lift out the reticle assembly.

h. Remove Left Erecting Prism Holder Assembly (fig. 140). Remove the set screw (D) and unscrew the housing cover (A). Remove four fillister-head screws (B). Lift out prism assembly.

i. Remove Right Erecting Prism Holder Assembly (fig. 141). Remove setscrew (C) and proceed as described in *h* above.

j. Remove Elevating Worm (fig. 144). Drive out the taper pin (RR) which secures the elevating knob (QQ) to the worm and slide off the knob assembly (SS), the fixed stop ring (PP), and the rotating stop rings (NN). Remove the setscrew (H) from the housing and unscrew the slotted plug (E). Take out the compression spring (F) and the worm plunger (G). Remove the setscrew (JJ) and with the face spanner wrench 41-W-3248-130 (fig. 15), unscrew the ball cap (MM). Remove the headless screw (GG) within the housing and unscrew the elevating worm (LL). Remove the ball socket from the worm.

k. Remove Angle of Site Worm (fig. 144). Remove two screws (X) and take off the angle of site scale (W). Remove the two headless screws (Y and Z). Remove the headless setscrew (AA) which secures the plug in the housing. Remove the plug and the spring. Take out three screws (U) and remove the knob (T) and micrometer (S). Drive out the taper pin (R) and slide off the adapter assembly (V), one fixed stop ring (N), and eight rotating stop rings (M). Remove the ball cap (L) with face spanner wrench 41-W-3248-115 (fig. 15). Turning the worm (J) counterclockwise remove the worm and ball socket (K) from the housing. Remove the worm plunger (BB).

l. Remove and Disassemble Latch Assembly and Remove Level Vial Holder Assembly (fig. 144). Loosen the setscrew which secures the knob of the latch assembly (fig. 145) and remove the knob. Remove the headless screw (KK) which secures the retaining ring (A) and, using face spanner wrench 41-W-3248-125 (fig. 15), unscrew the retaining ring. Drive out the two taper pins (HH) while supporting the locating bushing (EE) on a block of wood and maintaining the bushing in a centered position. With spanner wrench 41-W-3250-223, remove the locating bushing (fig. 147), and its washer (FF).

Note. The locating bushing (EE) and its attaching parts are components of the gear assembly (fig. 145) which in turn is a component of the latch assembly (fig. 145). These assemblies must be partially disassembled for installation in, or removal from, the instrument.

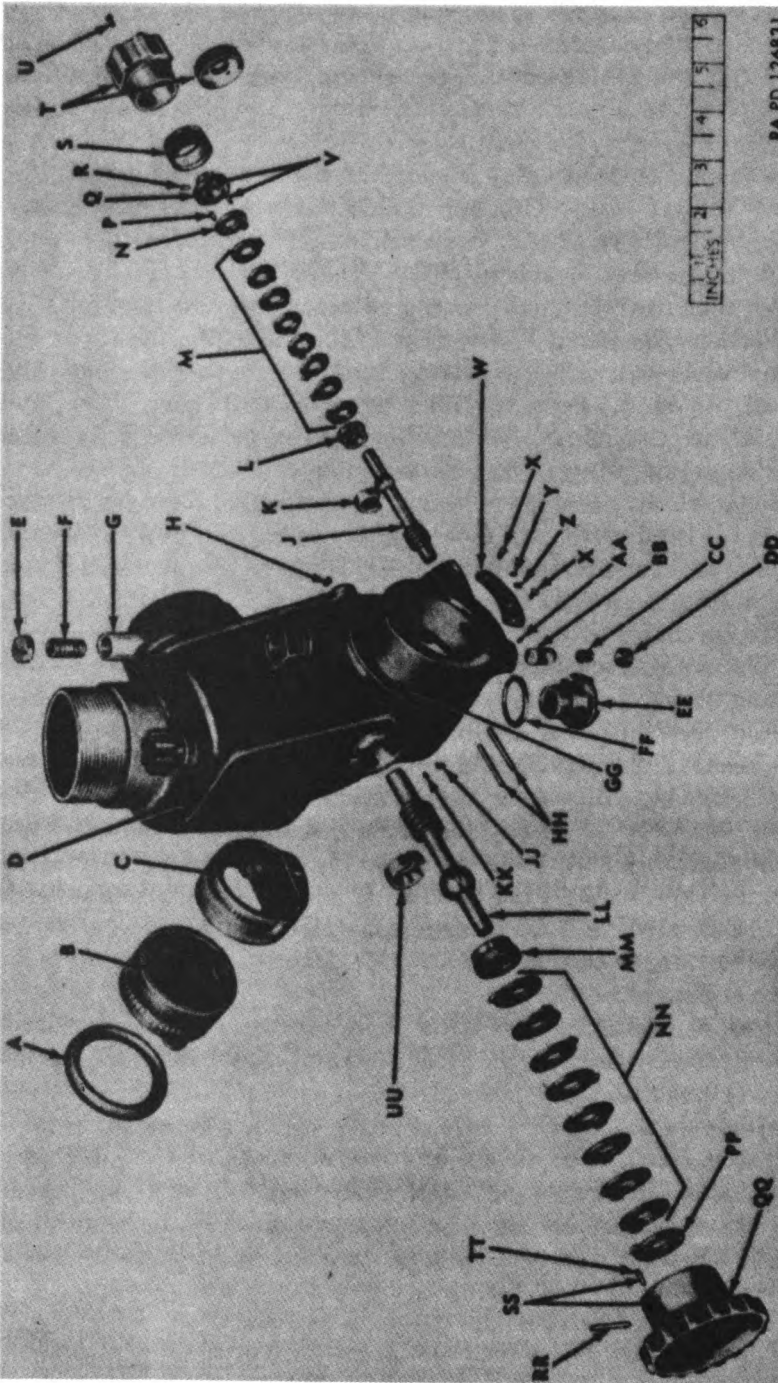

Figure 144. BC telescope M66 — partial exploded view.

A — RING, RETAINING, 1.75 ID X 2-5/16-24NS-2 OD X 0.28 OVERALL
 B180604
 B — LATCH, ASSY — C82523
 C — HOLDER, LEVEL VIAL, ASSY — 7635921 OR HOLDER, LEVEL
 VIAL, ASSY — B180599
 D — HOUSING, RIGHT, WITH FILTER HOLDER, ASSY — D74392
 E — PLUG, SLOTTED, 1/2-32NS-3 X 3/16 — A34656
 F — SPRING, COMPRESSION, 0.047 DIAM STOCK, 0.325 OD, 8 COIL —
 A34447
 G — PLUNGER, WORM — A34709
 H — SCREW, SET, HDLS, FL-PT, NO. 5-44NF-3 X 3/32 — 540882
 J — WORM, ANGLE OF SITE, 2-53/64 LG — B180590
 K — SOCKET, BALL, 13/32 IN (MFG ASSY) — 7579785
 L — CAP, BALL, 13/32 IN (MFG ASSY) — 7579463
 M — RING, STOP, ROTATING, 0.251 IN ID — A181689
 N — RING, STOP, FIXED, 0.251 IN ID — A181688
 P — PIN, STGHT, CHAMFERED, 1/16 X 5/32 — 505548
 Q — ADAPTER, ANGLE OF SITE WORM — A181695
 R — PIN, TAPER, NO. 6/0 (0.078) X 3/8 — 544033
 S — MICROMETER, ANGLE OF SITE — A181694
 T — KNOB, BR, 1 OD — A181693 OR KNOB, BZ, 1-3/8 OD — 7596928
 U — SCREW, MACH, FIL-HD, NO. 3-56NF-3 X 7/32 — 544395
 V — ADAPTER, ANGLE OF SITE WORM, ASSY — B180603
 W — SCALE, ANGLE OF SITE — A181699
 X — SCREW, MACH, RD-HD, NO. 2-64NF-3 X 3/16 — 504077
 Y — SCREW, SET, HDLS, FL-PT, NO 5-44NF-3 X 1/8 — 540883
 Z — SCREW, SPECIAL, HDLS, DOG-PT, NO 5-44NF-2 X 3/16 OVERALL
 — A181708
 AA — SCREW, SET, HDLS, FL-PT, NO 2-64NF-3 X 3/32 — 503890
 BB — PLUNGER, WORM — A316675
 CC — SPRING, COMPRESSION, 0.037 DIAM STOCK, 0.25 OD X 0.24 LG,
 3 COILS — A316676
 DD — PLUG, BR, 3/8-24NF-2 X 1/8 THK — A316660
 EE — BUSHING, LOCATING, 27/64 ID X 1.05 OD AND 5/8-32NS-3 X 0.78
 OVERALL — A46497*
 FF — WASHER, 0.635 ID X 0.87 OD X 0.062 THK (ONE SIDE LEVELED
 IN TWO PLACES) — 7579223*
 GG — SCREW, SPECIAL, HDLS, DOG-PT, NO 5-44NF-3 X 0.17
 OVERALL — A34659
 HH — PIN, TAPER, NO. 4/0 (0.109) X 1 — 501635*
 JJ — SCREW, SET, HDLS, FL-PT, NO. 5-44NF-3 X 3/16 — 503885
 KK — SCREW, SET, HDLS, CONE-PT, NO. 2-64NF-3 X 3/16 — 503913
 LL — WORM, ELEVATING, 3-5/8 IN LG — B180595
 MM — CAP, BALL, 5/8 IN (MFG ASSY) — 7579735
 NN — RING, STOP, ROTATING, 0.314 IN ID — A181684
 PP — RING, STOP, FLXED, 0.314 IN ID — A181683
 QQ — KNOB, BZ, 2 IN OD — A181682
 RR — PIN, TAPER, NO. 4/0 (0.109) x 3/4 — 544096
 SS — KNOB, BZ, 2 IN OD, ASSY — B180602
 TT — PIN, STGHT, CHAMFERED, 1/16 X 5/32 — 544102
 UU — SOCKET, BALL, 5/8 IN (MFG ASSY) — 7579730
 *Part of latch assembly C82523; must be removed to assemble to housing assembly D74392.

Figure 144 — Continued

Press both the latch assembly (less the parts already removed) and the level vial holder assembly (C) out of the housing.

Caution: Do not force. If the assembly binds, tap it back into its original position with a rawhide mallet (in kit 41-K-96) and press the two assemblies out together.

Separate the latch assembly from the level vial holder assembly. Complete the disassembly of the latch assembly by removing the plug (fig. 145) and taking out the compression spring and the latch. The gear assembly (fig. 146) was disassembled above.

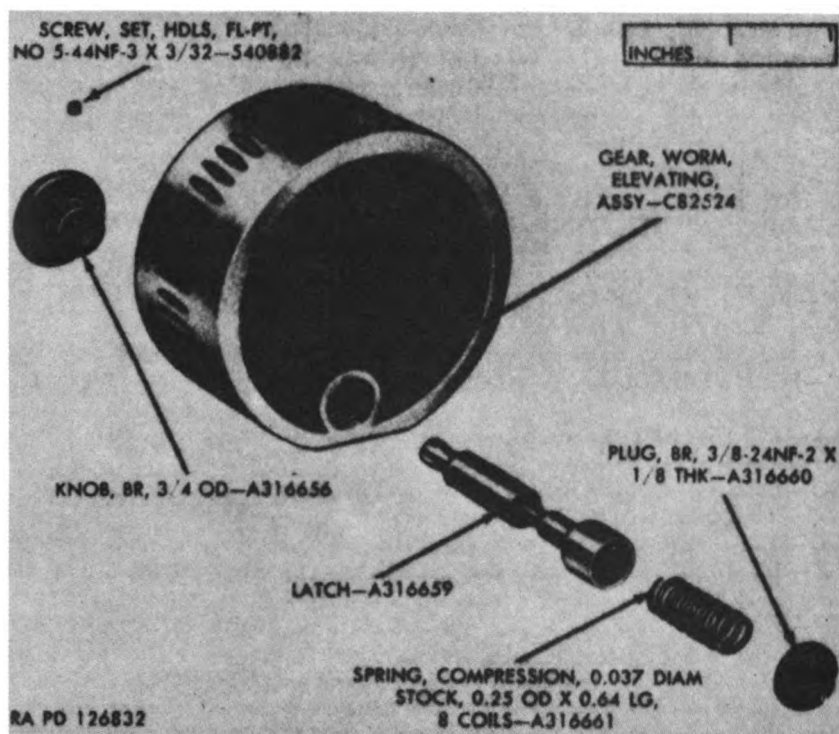

Figure 145. Latch assembly C82523 — exploded view.

m. Disassemble Left or Right Housing with Filter Holder Assembly. Scribe a letter "L" holder assembly (M, fig. 148) in the left housing, and the letter "R" on filter holder assembly (L, fig. 149) in the right housing. Remove the flat-fillister-head screw (N, fig. 148 or M, fig. 149) which secures the filter holder assembly. Remove the filter holder assembly and the washer (L, fig. 148 or G, fig. 149). Remove the two screws (F, fig. 148 or E, fig. 149) which secure the filter holder detent clamp and the filter

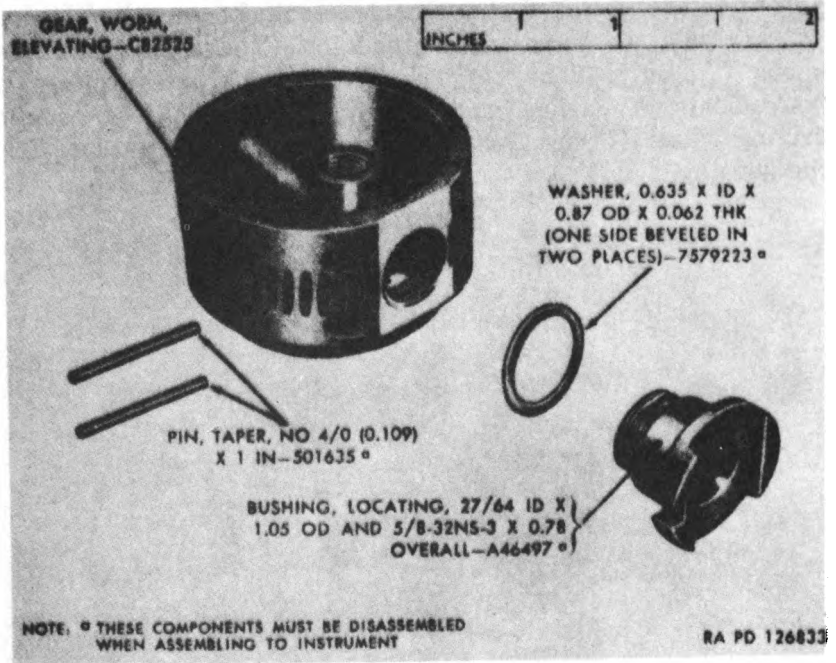

Figure 146. Gear assembly C82524 — exploded view.

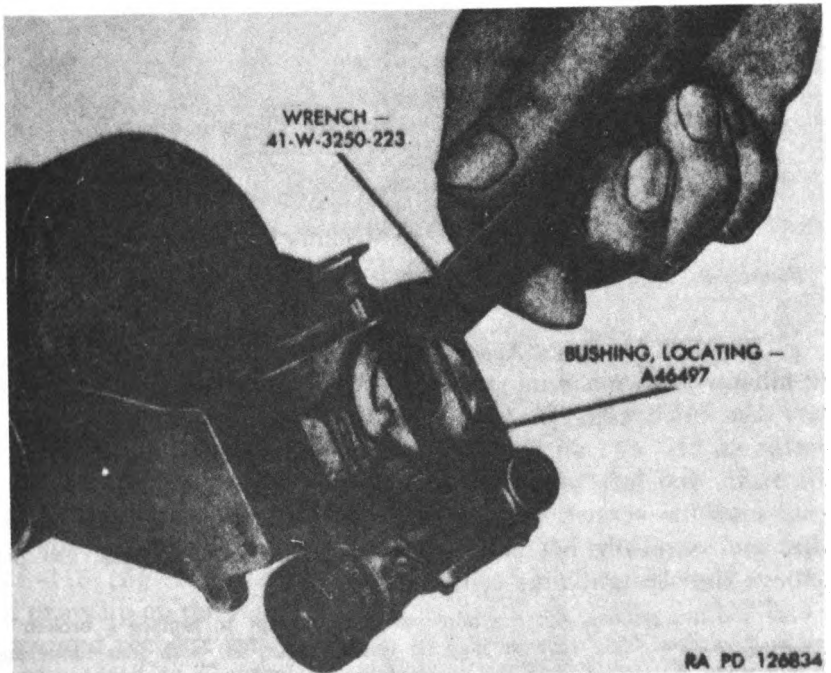

Figure 147. Using spanner wrench 41-W-3250-223 on locating bushing.
234418 O-14—53

holder detent. Remove clamp and detent. Loosen the setscrew (C, fig. 148 or 149) and remove the knob. (The smaller of the two knobs (A, fig. 148 or 149) shown on the figures is used on instruments of earlier manufacture.) Slide the filter holding driving wheel (H, fig. 148 or 149) along with its washer from the housing.



Figure 148. Left housing with filter holder assembly C82518 — exploded view.

n. *Disassemble Head Assembly* (figs. 150 and 151). Remove the 12 fillister-head machine screws and their lock washers which secure the head caps. Remove the head caps and their gaskets. Scribe an "L" and an "R" on the 90° prism holder assemblies in the right and left telescopes, respectively. Remove the 12 oval-head machine screws which secure the two prism holder assemblies and carefully lift out the prism holder assemblies. Do not remove the straight pins unless damaged.

Note. Do not remove either window assembly except to replace a broken or scratched window. The windows may be cleaned (par. 46) with lens tissue and alcohol while still installed in the stripped head assembly.

If the window is damaged, loosen the setscrew and after soften-

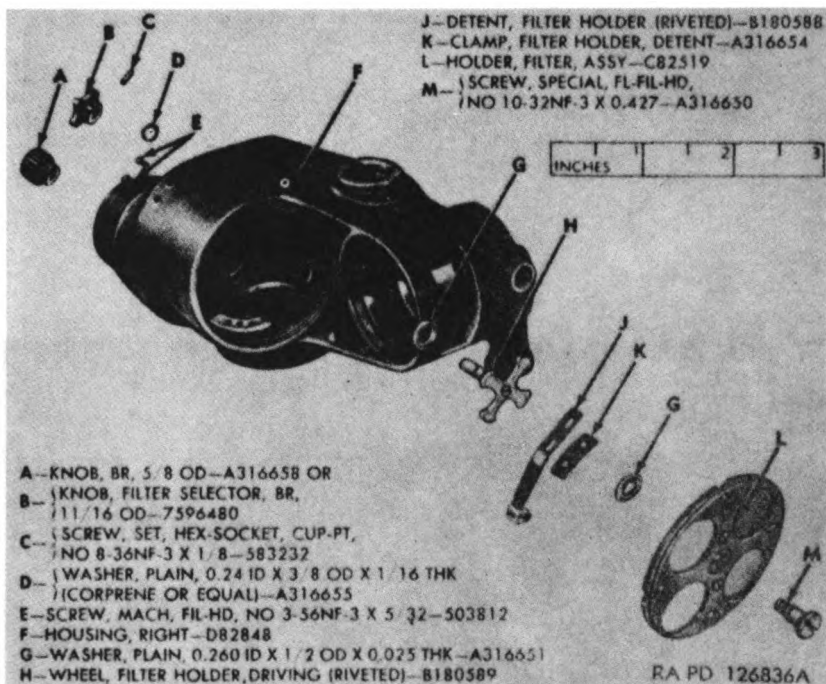

Figure 149. Right housing with filter holder assembly D7492 — exploded view.

ing the sealing compound, remove the window assembly with tubular wrench 41-W-3726-295 (fig. 152). Remove the four screws and their lock washers which secure the two head window plugs and take off the plugs.

o. Disassemble Head Window Assembly (fig. 153). Loosen the shellac which seals the window retaining ring and unscrew the retaining ring with wrench 41-W-3727-225 (fig. 154). Remove the broken or scratched window and clean out the sealing compound with alcohol. Examine the metal parts and replace any broken or damaged parts.

p. Disassemble Left and Right Stripped Head Assembly (fig. 155). Check the movement between the two heads. If the bushing between the two heads is loose, it may be repaired without complete disassembly. Loosen the two setscrews in the front and rear special screws A181696. Using face spanner wrench 41-W-3248-115 (fig. 15), loosen the front special screw several turns and draw up on the rear special screw. Retighten the front special screw and recheck for looseness. If the condition has been eliminated, redrill to accommodate the two setscrews with a No. 50 drill, 1/4-inch deep, and tap with a No. 2-64NF-2 tap. Install the

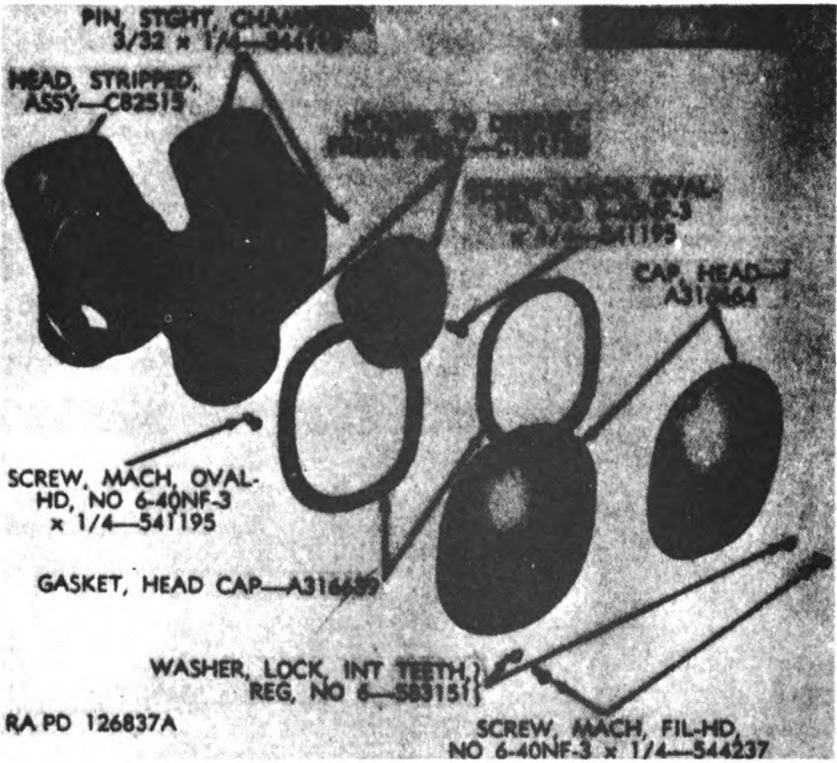

Figure 160. Head assembly C82516 — partial exploded view.

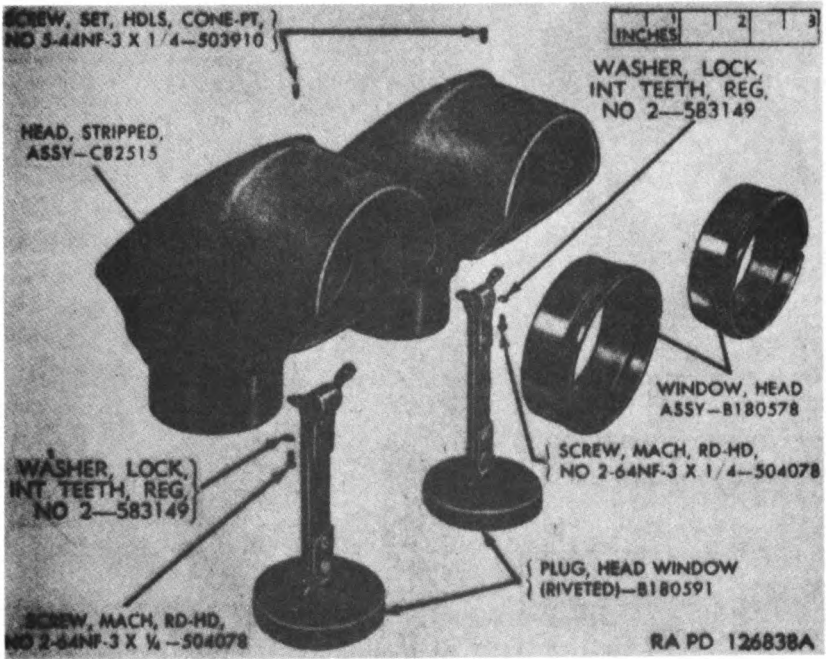

Figure 161. Head assembly C82516 — partial exploded view.

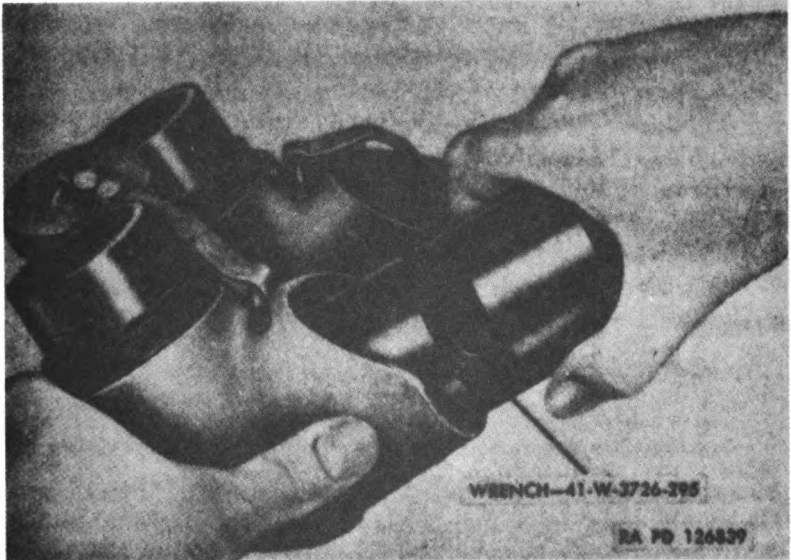

Figure 162. Using tubular wrench 41-W-3726-395 to remove window assembly.

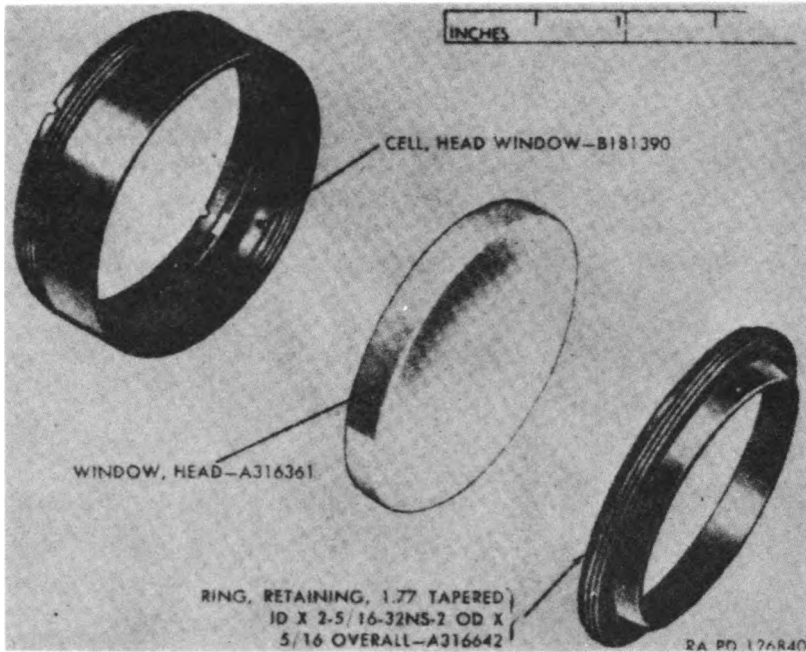

Figure 163. Head window assembly B180578 — exploded view.

setscrews. If the looseness was not eliminated after tightening the special screws as above, disassemble the head assembly as follows: remove the setscrews and the front and rear special screws with face spanner wrench 41-W-3248-115 (fig. 15). With a brass rod (fig. 156), drive out the head spindle from the rear of the instrument. The spindle wedge pin will fall out as the spindle is removed. Remove the setscrew which secures the bushing and with wrench 41-W-3727-221 (fig. 15), unscrew the bushing. Discard the unserviceable bushing and replace with a new one at assembly.

q. Disassemble 90° Prism Holder Assembly (fig. 157).

Note. Do not disassemble prism holder assemblies unless it is necessary to replace a cracked or damaged part or to remove moisture from inaccessible places.

If, on examination, a component part of the prism holder assembly is found to be unserviceable, turn the three No. 10 special screws (from the underside of the holder) approximately one-eighth of an inch into the holder. Remove the four No. 5 special screws releasing the prism clip. Take off the clip and lift the 90°

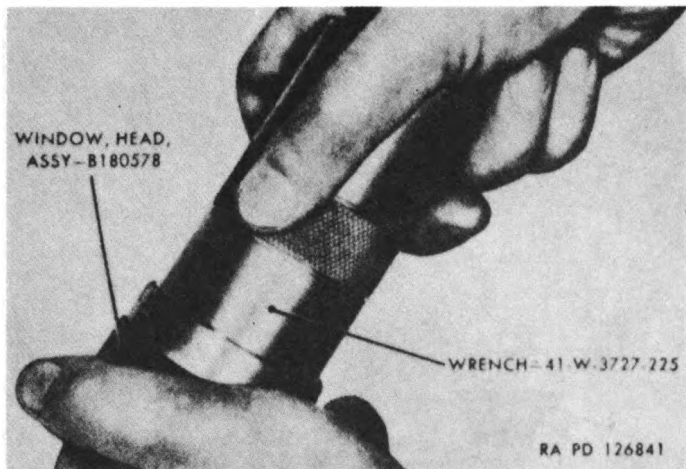

Figure 164. Using wrench 41-W-3727-225 to remove head window retaining ring A316842.

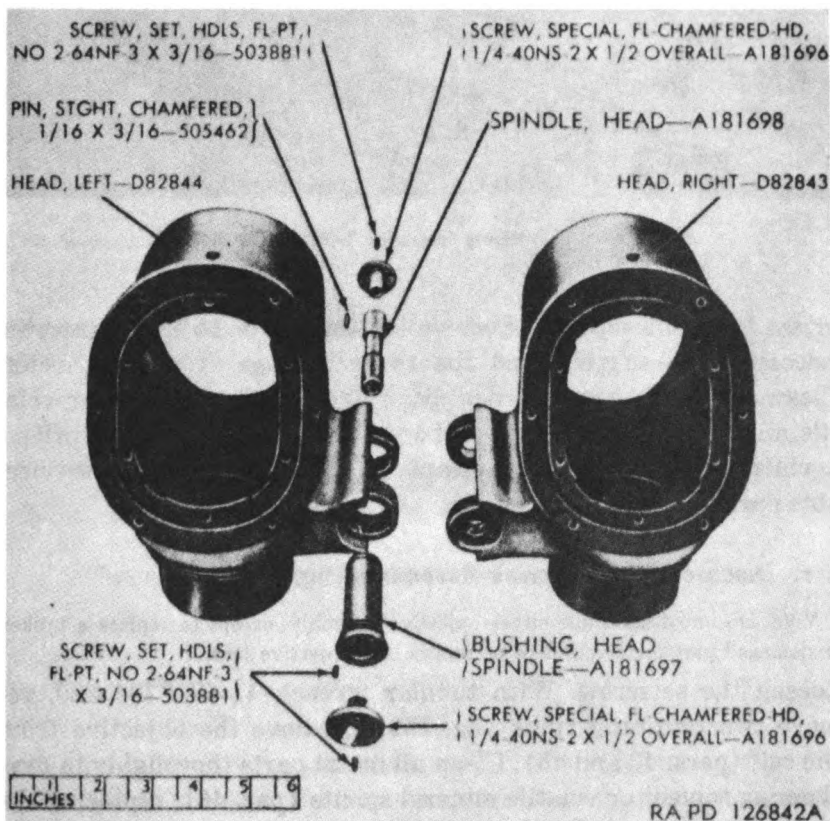

Figure 165. Left and right stripped head assembly C82515 — exploded view.

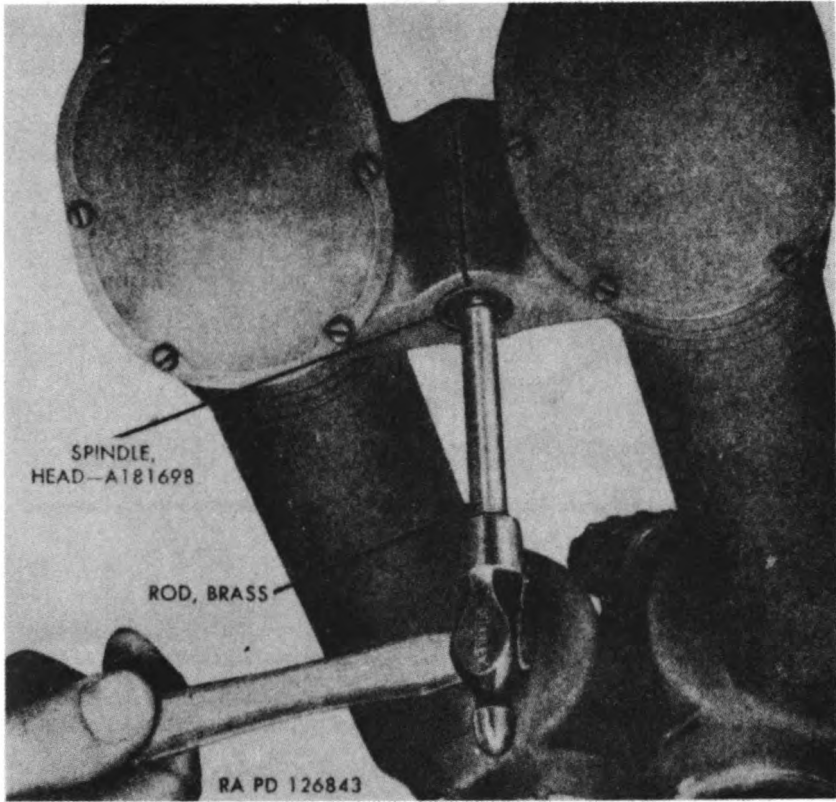

Figure 158. Removing telescope head spindle A181698.

prism from the support. Remove the three No. 10 special screws, releasing the support and the three springs from the holder. Clean all metal parts thoroughly in dry-cleaning solvent or volatile mineral spirits and clean the polished surfaces of the prisms avoiding finger marks after cleaning (par. 46). Replace unserviceable parts.

r. Disassemble Objective Assembly (fig. 158).

Note. Do not disassemble either objective assembly, except to replace a broken or damaged part or to recement or replace the objective lens.

Loosen the setscrew. With tubular wrench 41-W-3726-220, remove two retaining rings (fig. 159). Remove the objective from the cell (pars. 42 and 43). Clean all metal parts thoroughly in dry-cleaning solvent or volatile mineral spirits (par. 46), replacing the parts which are damaged or broken. If the cement in the objective is deteriorated, recement (pars. 44 and 45).

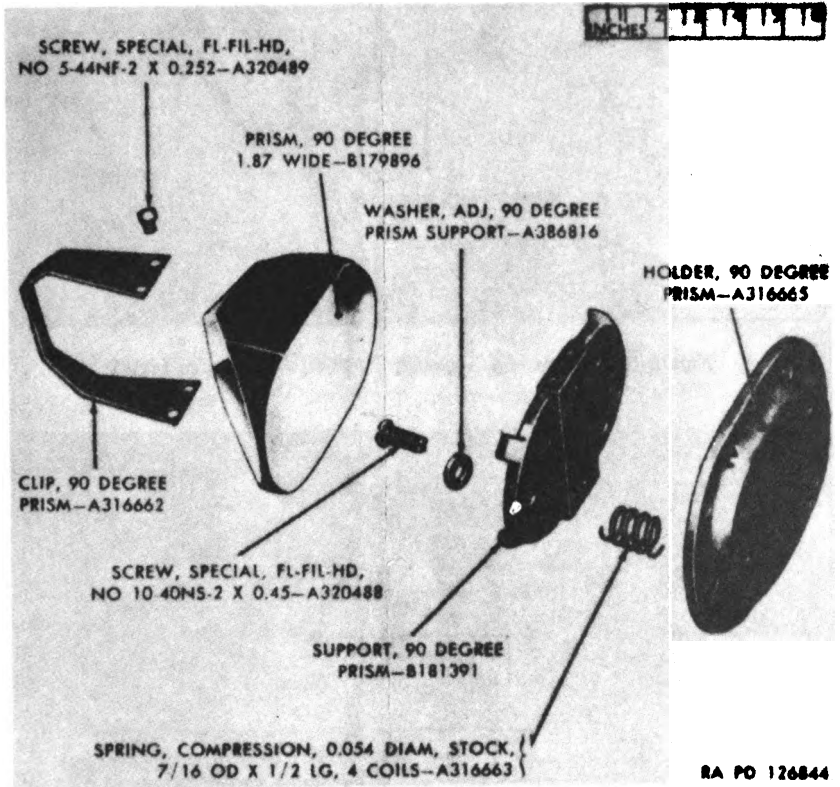

Figure 167. 90° prism holder assembly C191126 — exploded view.

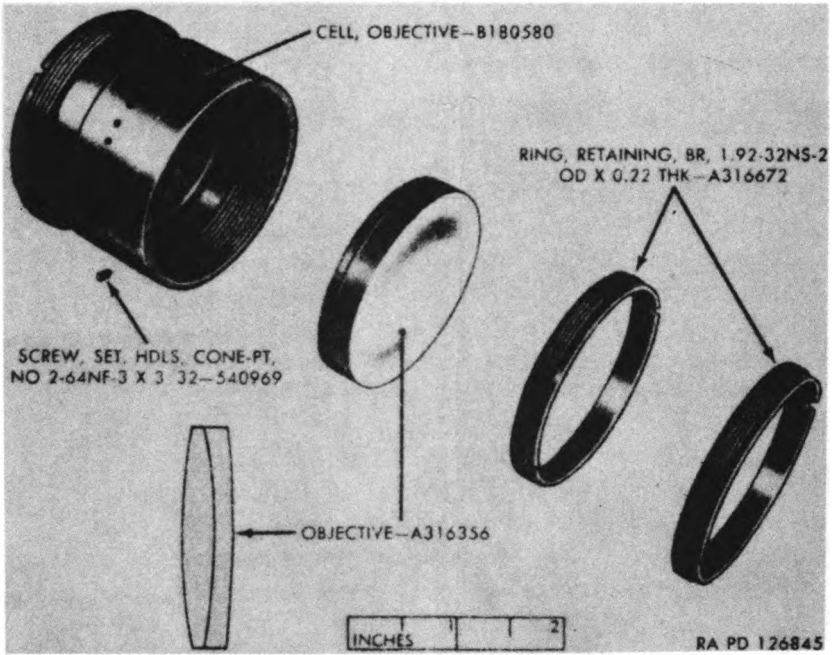

Figure 168. Objective assembly B180589 — exploded view.

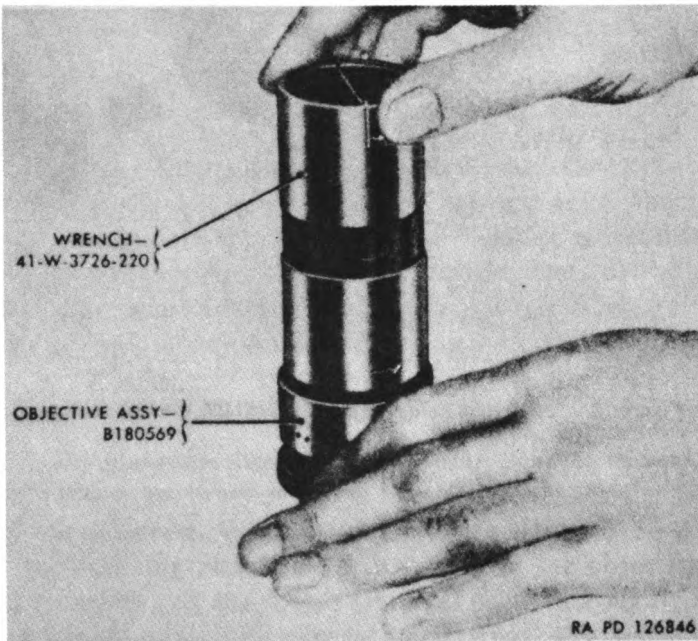

Figure 169. Using tubular wrench 41-W-3726-220 to remove objective retaining ring A316672.

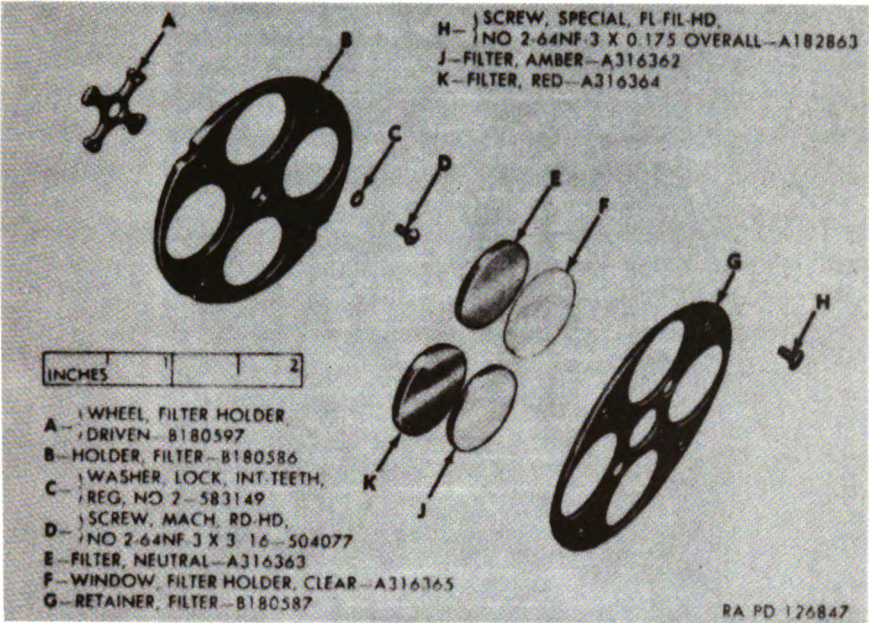

Figure 160. Filter holder assembly C82519 — exploded view.

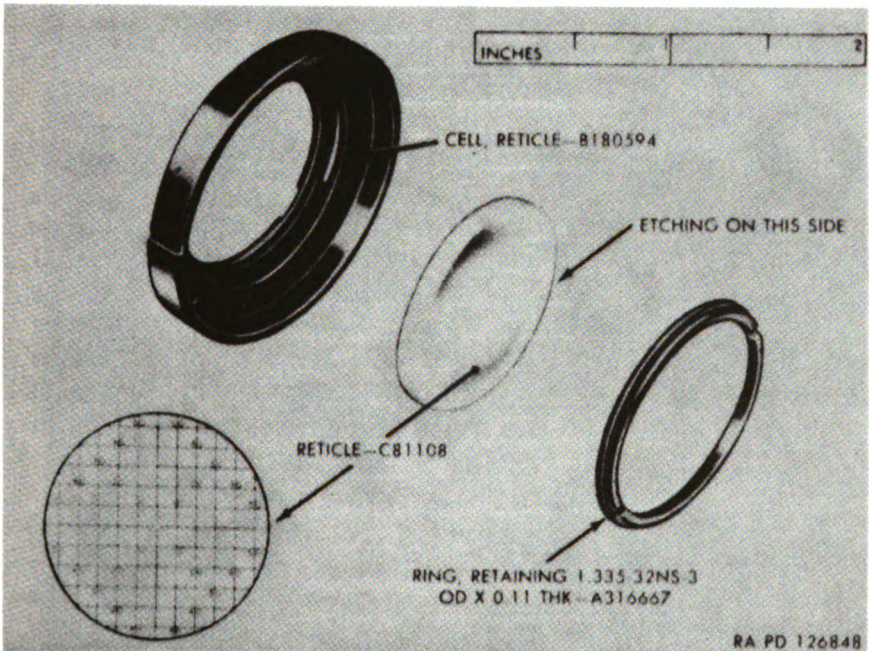

Figure 161. Reticle assembly B180593 — exploded view.

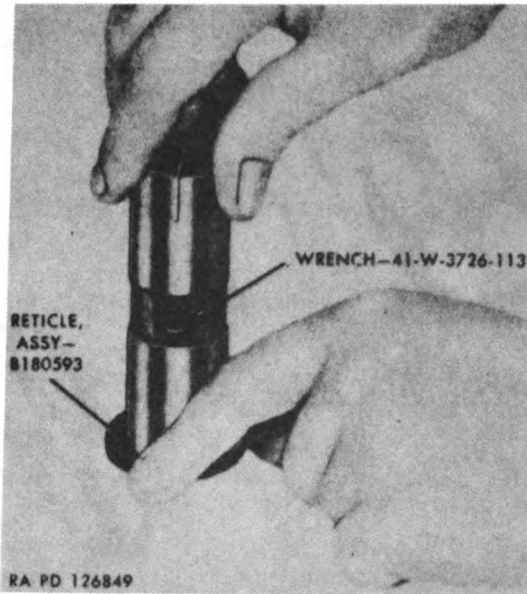

Figure 162. Using tubular wrench 41-W-3726-113 to remove reticle retaining ring A316667.

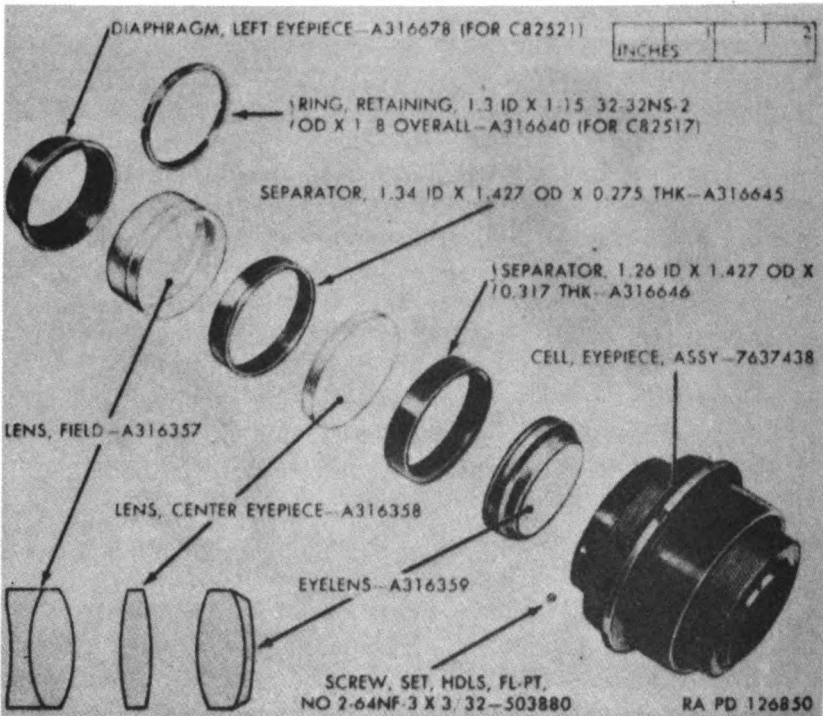

Figure 163. Eyepiece assembly C82517 (right) or C82512 (left) — exploded view.

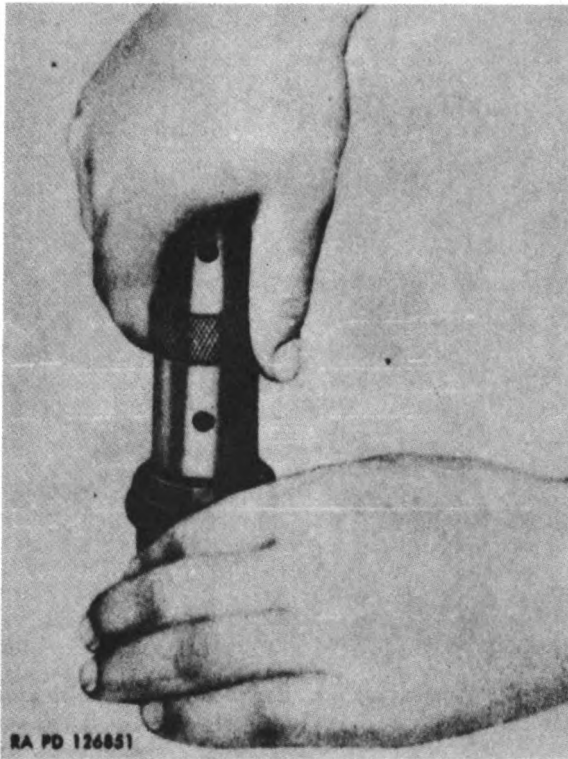

Figure 164. Using tubular wrench 41-W-5726-140 to remove eyepiece retaining ring A318640.

s. Disassemble Filter Holder Assembly (fig. 160).

Note. Do not disassemble filter assemblies except to replace a broken filter or a broken or badly worn metal part. If a part is not repairable and new filter assemblies are available, replace the entire assembly.

If necessary to disassemble the filter assembly, remove four screws (H), and lift off the filter retainer (G) (taking special care to avoid disturbing the position of unbroken filters). Remove two round-head screws and their lock washers releasing the driven filter holder wheel (A). Replace broken filters and broken or worn metal parts with serviceable parts.

t. Disassemble Reticle Assembly (fig. 161).

Note. Do not disassemble reticle assembly except to replace a scratched or broken reticle. Replace the entire reticle assembly if metal parts are damaged. Clean the reticle thoroughly with alcohol and lens tissue and remove all dust particles with a vacuum pickup lens cleaner (figs. 35 and 42) or camel's-hair brush just before final installation of eyepiece assembly.

If necessary to disassemble the reticle assembly, soften shellac with alcohol or heat and remove the retaining ring with tubular

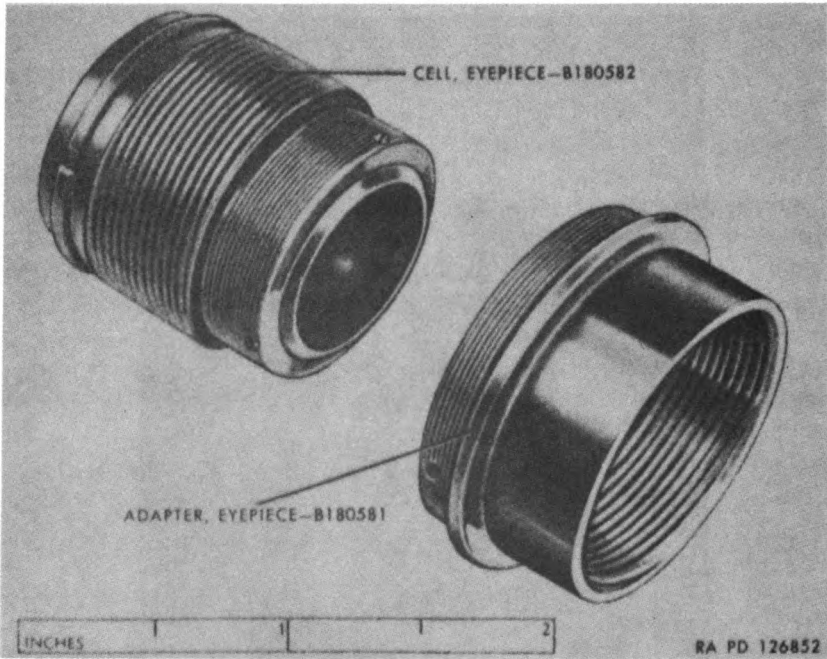

Figure 165. Eyepiece cell assembly 7657458 — exploded view.

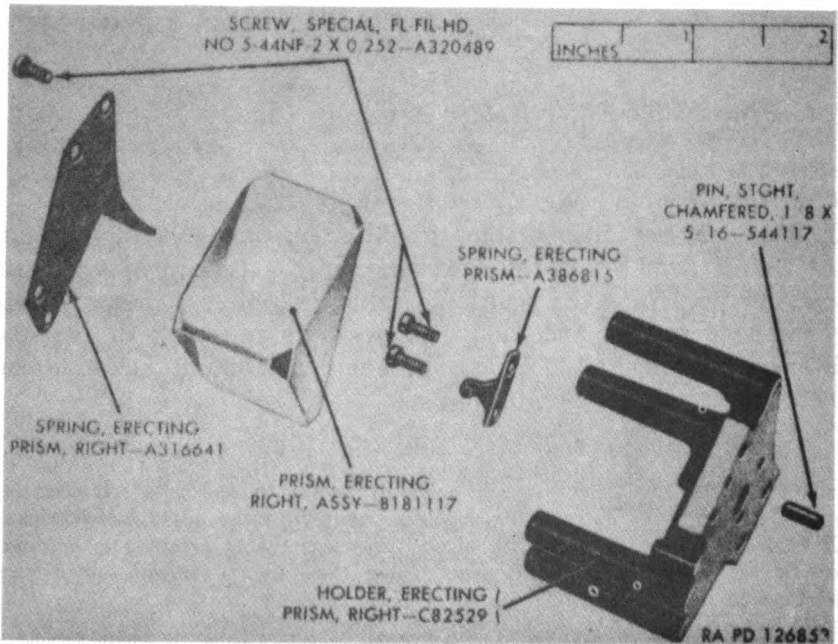

Figure 166. Right erecting prism holder assembly C82528 — exploded view.

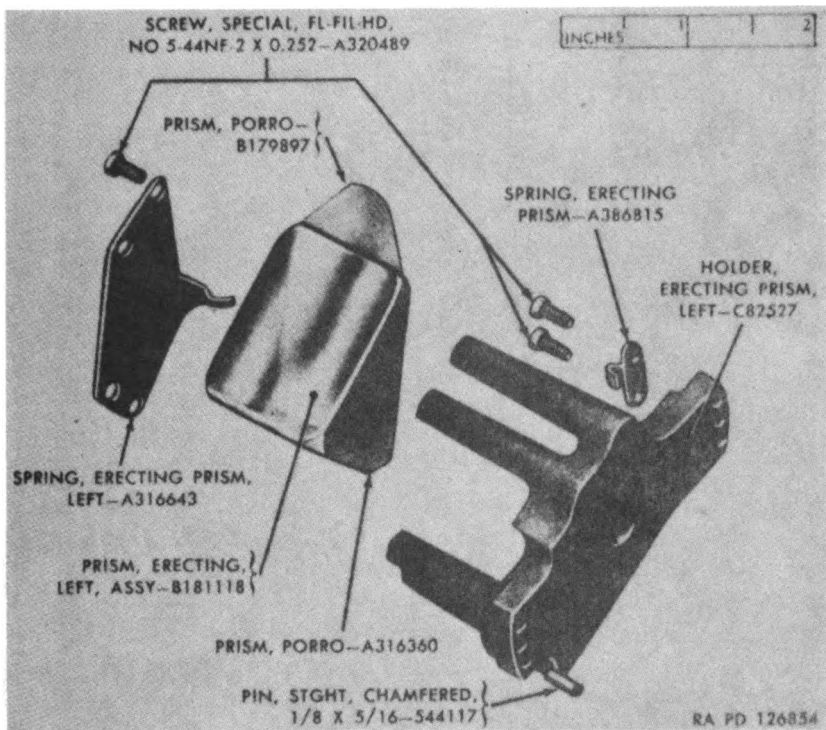

Figure 167. Left erecting prism holder assembly C82526 — exploded view.

wrench 41-W-3726-113 (fig. 162). Remove broken or scratched glass and clean cell with alcohol. Replace broken or damaged parts.

u. Disassemble Eyepiece Assemblies (fig. 163). Remove the setscrew and unscrew the diaphragm by hand on the left eyepiece assembly, or, using tubular wrench 41-W-3726-140, unscrew the retaining ring on the right eyepiece assembly (fig. 164). Remove from the cell assembly (par. 43) the field lens, the separator, the center lens, another separator and, after softening the sealing compound (par. 42b), the eyelens. Turn the eyepiece cell (fig. 165) counterclockwise in the adapter until it reaches the point where it disengages from the adapter. At this point, scribe a mark on the cell in line with the adapter index to insure proper location in assembly. Examine the eyelens and the field lens. If cement in either lens is deteriorated, recement (pars. 44 and 45). Clean the lenses thoroughly (par. 46), taking special care to avoid finger marking after cleaning. Clean all metal parts thoroughly in dry-cleaning solvent or volatile mineral spirits (par. 46), discarding those parts which are badly worn, damaged, or broken, and replacing with serviceable parts. Matching the scribe mark

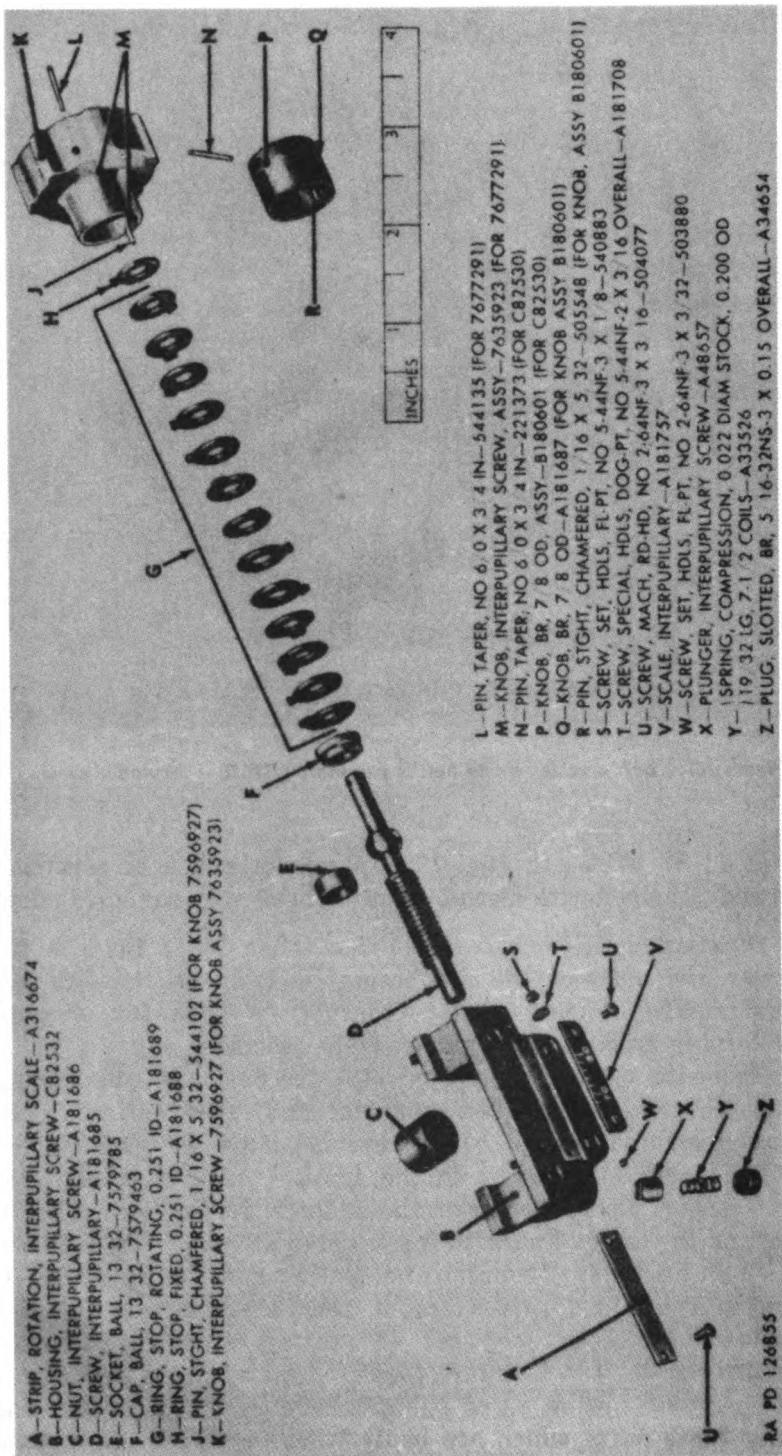

Figure 168. Interpiplary screw assembly 7677291 or C82530 — exploded view.

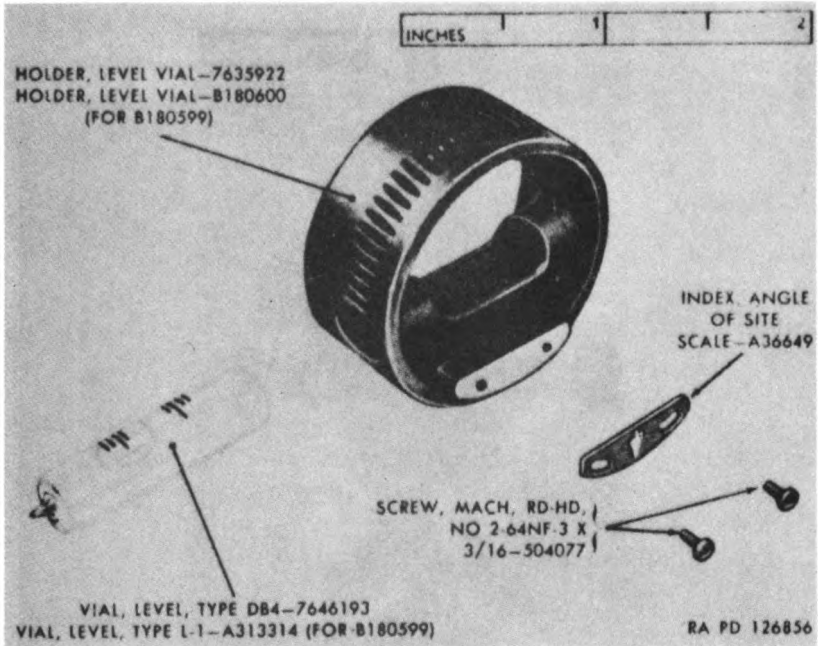

Figure 189. Level vial holder assembly 7635921 or B180599 — exploded view.

and index, temporarily install the eyepiece cell in the eyepiece adapter (fig. 165). Check the movement to detect any unnecessary looseness between the parts. If excessive looseness is noticeable in the fit of the two parts, replace with serviceable parts, lapping them into a close fit (pars. 48 and 49).

Caution: Remove all lapping compound to avoid continued wear. Select the position at which the two parts run smoothest and scribe an identifying mark as described above and in paragraph 39.

v. Disassemble Erecting Prism Holder Assemblies.

Note. Do not disassemble the erecting prism holder assemblies (figs. 166 and 167) except to replace a damaged, uncemented, or uncoated prism or if otherwise unserviceable. Clean polished surfaces (par. 46). If a part is damaged or broken and new prism holder assemblies are available, replace the entire assembly.

If it is necessary to disassemble the prism holder assemblies, remove the four screws which secure the large spring to the posts of the holder and remove the spring (figs. 166 and 167). Remove the two screws which secure the smaller spring and remove the spring and the prism. Press out the straight pins if necessary. Replace damaged or broken parts.

w. Disassemble Interpupillary Screw Assembly (fig. 168). Remove four screws (U) and take off the rotation strip (A) and the interpupillary scale (V). Loosen screw (W) and remove the plug

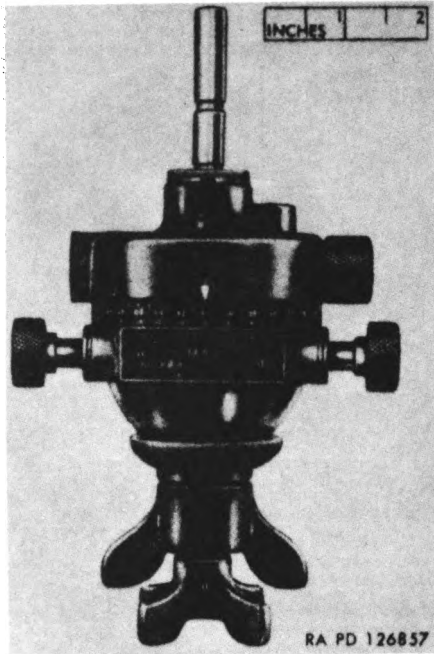

Figure 170. Telescope mount M48 — assembled view.

(Z), spring (Y), and plunger (X). Drive out the taper pin (N or L) and remove the knob assembly (P or M).

Note. The smaller knob assembly (P) is used on instruments of earlier manufacture.

Remove the straight pin (R or J) from the knob (Q or K) only if damaged. Remove one fixed stop ring (H) and 13 rotating stop rings (G) from the end of the screw (D). Remove the ball cap (F) using adjustable pin wrench 41-W-3248-115 (fig. 15). Turn the screw (D) counterclockwise out of the nut (C) and pull the screw, along with the ball socket (E), out of the housing. Clean the parts in dry-cleaning solvent or volatile mineral spirits. Replace any damaged or broken part with a new one.

x. Disassemble Level Vial Holder Assembly (fig. 169). Remove two screws and take off the angle of site scale index. If the level vial is broken, remove calcined gypsum and remains of old level vial. Level vial holder assembly B180599 may be found on instruments of early manufacture.

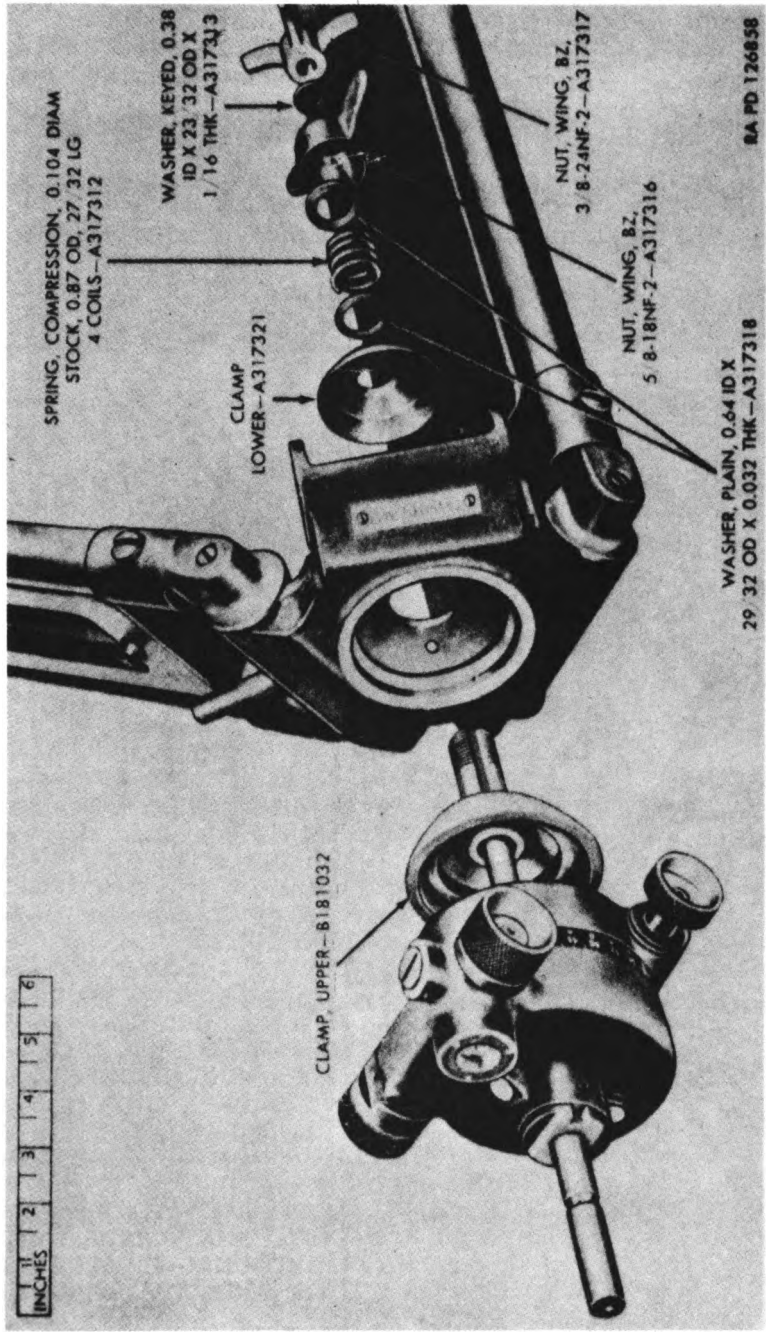

Figure 171. Telescope mount M48 — removed from tripod M17.

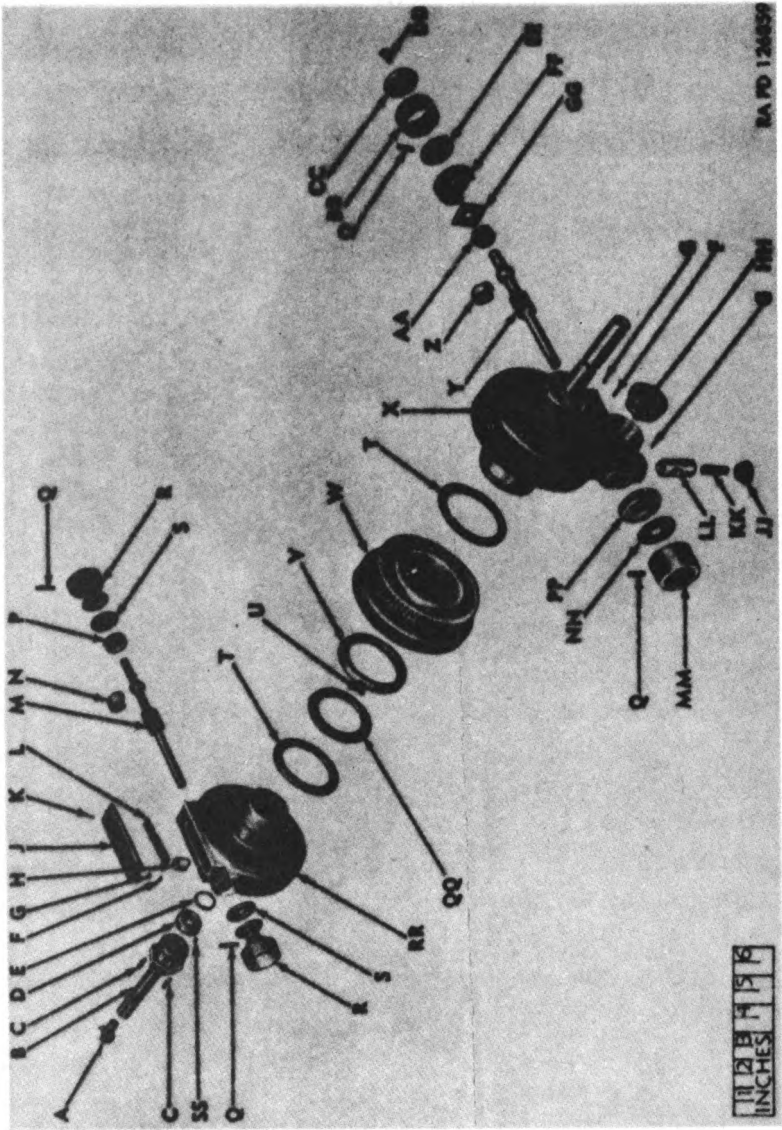

Figure 172. Telescope mount M.19 — partial exploded view.

A—SCREW, SPECIAL, OVAL-FIL-HD, NO 8-36NF-2 LH X 7/16
OVERALL—A317311
B—SPINDLE, LOWER—B181029
C—SCREW, SPECIAL, HDLS, DOG-PT, NO. 5-44NF-3 X 29/64
OVERALL—A202941
D—NUT, RD, 3/8-24NF-2 X 7/32 THK—A317300
E—WASHER, SPRING, 13/32 ID X 5/8 OD X 0.01 THK—A317320
F—SCREW, SPECIAL, SET, HDLS, DOG-PT. NO 2-64NF-3 X 0.11
OVERALL—5039618
G—SCREW, SET, HDLS, FL-PT, NO 2-64NF-3 X 3/32—503880
H—PLUNGER, ORIENTING WORM—A181727
J—COVER, RETAINING, SPRING—A317323
K—SCREW, SET, HDLS, CONE-PT, NO 2-64NF-3 X 1/8—540870
L—SPRING, FLAT, 21/64 WIDE X 1-29/64 LG X 0.031 THK—A46528
M—WORM, ORIENTING, 4-7/32 IN LG—B172547
N—SOCKET, BALL, 13/32 IN—7579785
P—CAP, BALL, 13/32 IN (MFG ASSY)—7579463
Q—PIN, TAPER, NO 4/0 (0.109) X 1/2—140148
R—KNOB, BR, 7/8 IN OD—A181728
S—WASHER, FELT, 3/16 ID X 23/32 OD X 1/16 THK—A181729
T—GASKET, RD, 2-7/16 ID X 2-25/32 OD X 3/32 THK (CORPRENE
OR EQUAL)—A317315
U—SCREW, SET, HDLS, FL-PT, NO 2-64NF-3 X 1/8—504160
V—NUT, RD, 1.409-32NS-2 X 0.18 THK—A317314
W—GEAR, WORM, BZ, 44 TEETH AND 64 TEETH RESPECTIVELY
—C130901
X—HOUSING AZIMUTH WORM, UPPER, ASSY—C130899
Y—WORM, AZIMUTH, 3.68 IN LG—B181031
Z—SOCKET, BALL, 7/16 IN—A184595
AA—CAP, BALL, 7/16 IN (MFG ASSY)—A184597
BB—MICROMETER, AZIMUTH—A315075
CC—DISK, CLAMPING, AZIMUTH MICROMETER—A315076
DD—SCREW, MACH, FIL-HD, NO 5-44NF-3 X 1/4—503868
EE—ADAPTER, AZIMUTH MICROMETER—A39619
FF—INDEX, AZIMUTH MICROMETER—B181030
GG—WASHER, SQ, FELT, 1/4 ID X 11/16 SQ—A318682
HH—LEVEL, CIRCULAR, ASSY—7645011
JJ—PLUG, SLOTTED, 15/32-36NS-3 X 7/32 OVERALL—A39625
KK—SPRING, COMPRESSION, 0.035 DIAM STOCK, 0.21 OD, 43/64 LG,
10 COILS—A317322
LL—PLUNGER, WORM, 7/8 IN LG—A39624
MM—KNOB, NI-SIL, 15/16 OD X 5/8 OVERALL—A39613
NN—WASHER, SPRING, 17/64 ID X 7/8 OD X 0.01 THK—A317308
PP—SHOE, AZIMUTH WORM—A317319
QQ—WASHER, PLAIN, 1.174 ID X 1-11/16 OD X 0.062 THK—A317310
RR—HOUSING, ORIENTING WORM—D63169
SS—SCREW, SET, HDLS, FL-PT, NO 2-64NF-3 X 5/32—540881

Figure 172—Continued

128. Disassembly of Telescope Mount M48

a. *Remove Mount from Tripod M17.* An assembled view of the mount is shown in figure 170. The mount must be partially disassembled (fig. 171) for installation on or removal from the tripod M17. Remove the *left-hand thread oval-fillister-head screw* (A, fig. 172) from the lower spindle (B). This left-hand screw serves as a stop for the four-wing locking nut — A317317. Remove wing nut A317317, washer (fig. 171), wing nut A317316, and washer A317318, the spring, and a third washer (fig. 171). Slide off the lower clamp and lift the mount from the tripod. Slide off the upper clamp. Clean and inspect the parts for burrs, defective threads, and other mechanical defects. Replace any defective part.

b. *Remove Orienting Worm* (fig. 172). Drive out the two taper pins (Q) which secure the two knobs (R) to the worm shaft and take off the knobs and two felt washers (S). Remove the headless screw (K) and slide off the spring retaining cover (J). Lift out the flat spring (L) and the plunger (H). Remove the two screws (F and G) which secure the ball cap and the ball socket within the housing. Unscrew the ball cap (P) and the worm (M) and remove the ball socket (N) from the worm.

c. *Separate Orienting Worm Housing and Azimuth Worm Hous-*

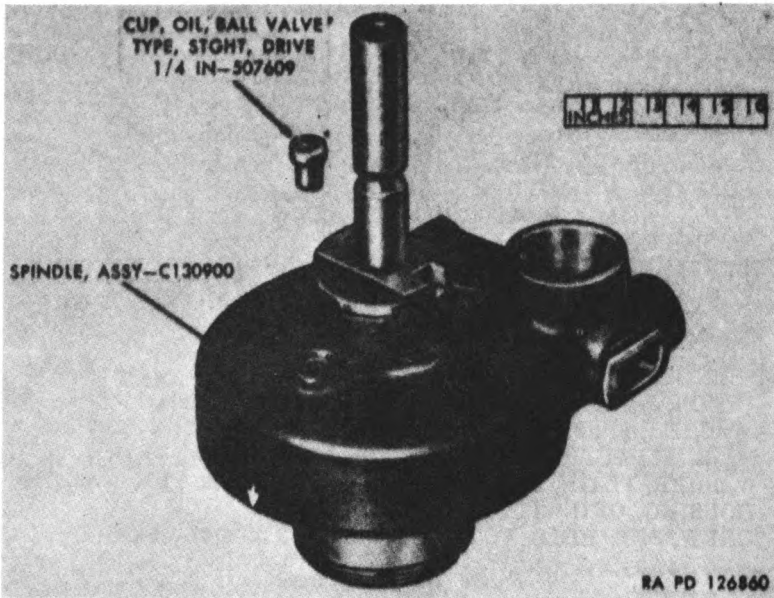

Figure 173. Upper azimuth worm housing assembly C130899 — exploded view.

ing Assembly (fig. 172). Remove two headless screws (C) which secure the lower spindle (B) to the housing and unscrew the spindle (B). Remove the headless screw (FS) which secures the round nut (D) to the base of the upper spindle. Using wrench 41-W-3727-221 (fig. 15), unscrew the round nut and lift out the spring washer (E). Separate the housings. Remove the gasket (T) washer (QQ) from the orienting worm housing.

d. Remove Worm Gear (W) (fig. 172). Remove the setscrew (U) which secures the round nut (V). Unscrew the round nut. Disengage the azimuth worm throwout mechanism and slide off the worm gear (W). Remove the second gasket (T).

e. Remove Azimuth Worm (fig. 172). Remove three fillister-head screws (DD) which secure the azimuth micrometer (BB) to the adapter (EE) and lift off the micrometer and clamping disk (CC). Drive out the taper pin (Q) which secures the micrometer adapter (EE) to the shaft of worm (Y) and slide off the adapter.

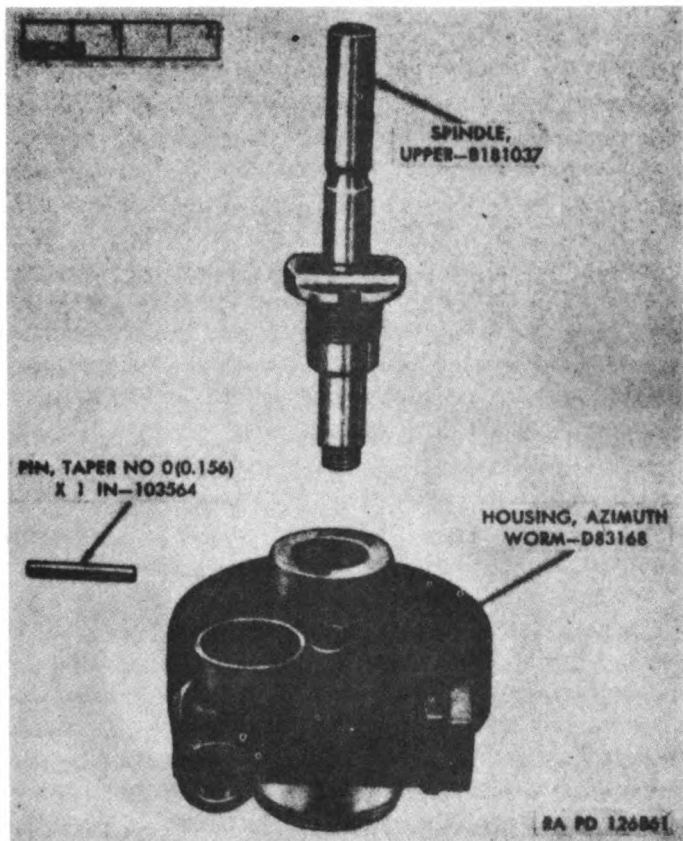

Figure 174. Spindle assembly C130600 — exploded view.

Slide off the micrometer index (FF) and square felt washer (GG). Drive out the taper pin (Q) which secures the azimuth knob (MM) to the worm shaft and slide off the knob, the spring washer (NN), and the shoe (PP). Remove the headless screw (G) which secures the slotted plug (JJ) within the azimuth housing and unscrew the plug. Lift out the compression spring (KK). Remove the two headless screws (G and F) which secure the ball cap (AA) and the ball socket (Z) within the azimuth housing and unscrew the ball cap. Unscrew the worm (Y) and remove the socket (Z). Slide out the worm plunger (LL).

f. *Remove Circular Level Assembly* (fig. 172). Remove the set-screw (F) and unscrew the circular level assembly (HH).

g. *Disassemble Azimuth Worm Housing Assembly* (fig. 173). Remove the oil cups. Oil is no longer used as a lubricant for telescope mount M48. Use instrument lubricating grease. The oil cups will be discarded and the holes in the spindle assembly plugged (TB 9-2835-1).

h. *Disassemble Spindle Assembly* (fig. 174). Drive out the taper pin and unscrew the upper spindle from the azimuth worm housing.

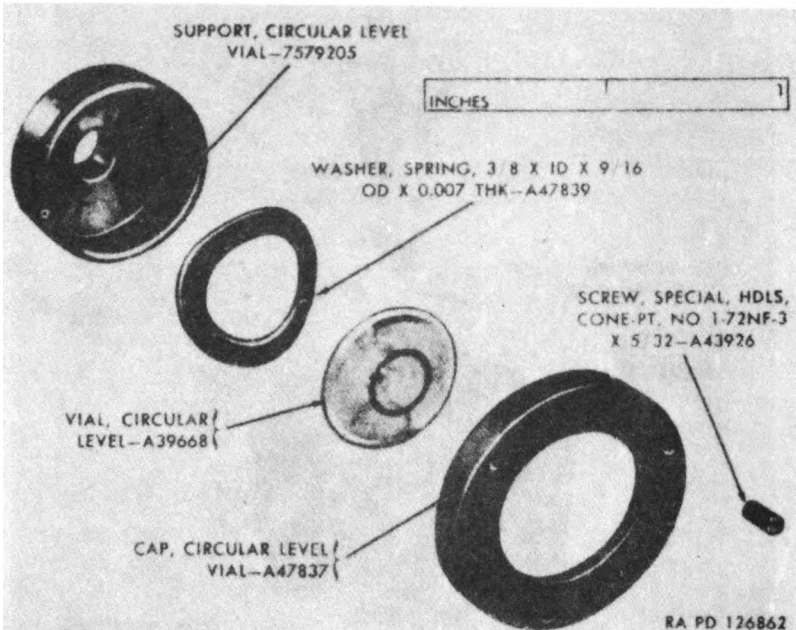

Figure 175. Circular level assembly 7645C11 — exploded view.

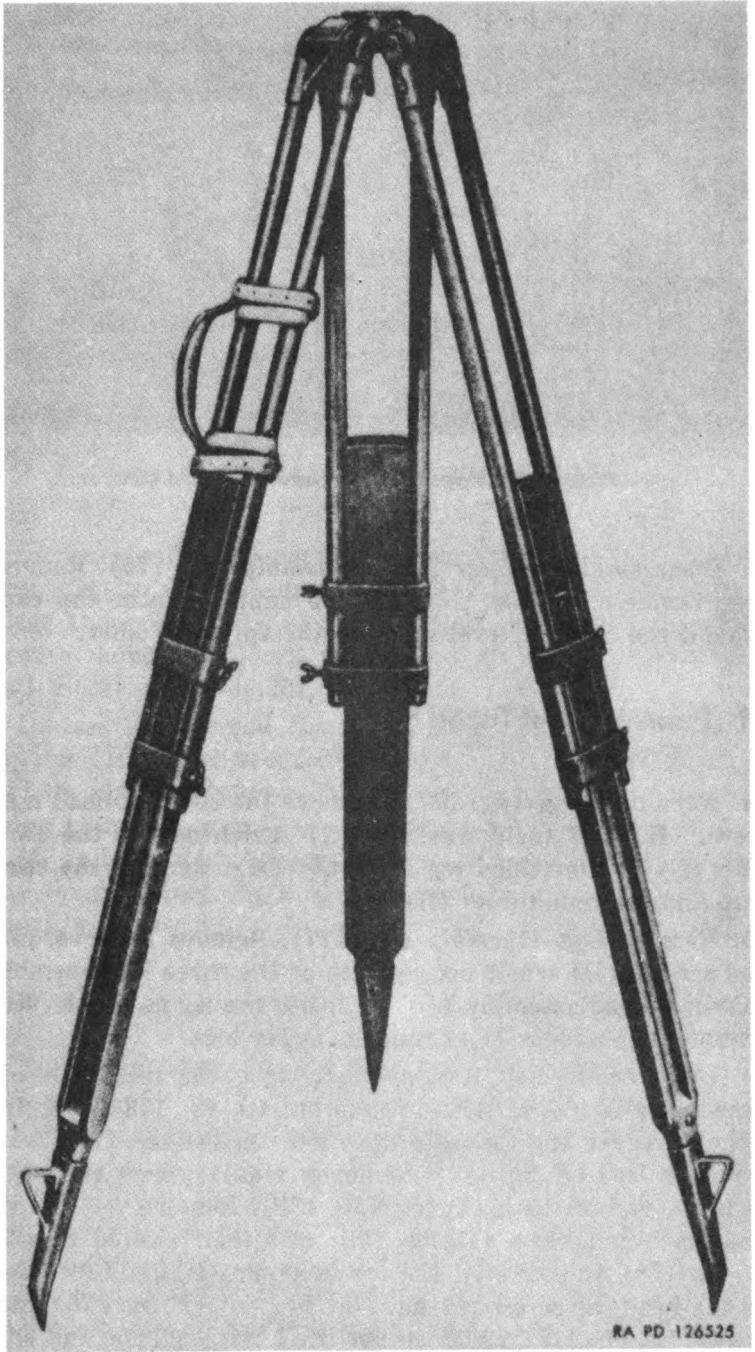

Figure 176. Tripod M17 — assembled view.

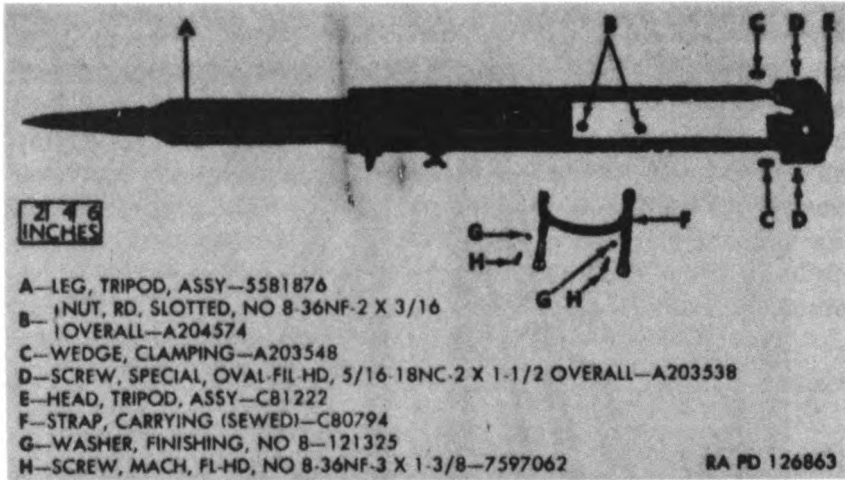

Figure 177. Tripod M17 — partial exploded view.

i. *Disassemble Circular Level Assembly* (fig. 175). Remove the three headless screws. Unscrew the support from the cap and take out the circular level vial and the spring washer.

129. Disassembly of Tripod M17 (fig. 176)

a. *Remove Strap* (fig. 177). Remove the two flat-head machine screws (H) and their washers (G) which secure the carrying strap (F) to the tripod leg assembly (A). Remove the carrying strap and the round nuts (B).

b. *Remove Leg Assembly* (fig. 177). Remove two oval-fillister-head screws (D) which secure each of the three leg assemblies to the tripod head assembly (E). Slide out the leg assembly. Remove the clamping wedges (C) from the upper legs.

c. *Disassemble Leg Assembly*. Remove the fillister-head machine screw (J, fig. 178) and round nut (A, fig. 178) from the top of the lower leg and separate the lower leg (D, fig. 178) from the two upper legs (A, fig. 179). Remove a similar screw and nut from the lower end of the lower leg (fig. 178). Remove the two round-head machine screws (K, fig. 178) and their slotted round nuts (C, fig. 178) and take off the leg fastener (B, fig. 178). Remove the hex-head cap screw (H, fig. 178) hex nut (F, fig. 178) and lock washer (E, fig. 178) which secure the lower leg shoe and slide off the shoe (G, fig. 178). Remove four flat-head wood screws (B, fig. 179) which secure the two clamps (C, fig. 179) to the upper left leg (E, fig. 179) and slide the clamps from the upper left leg.

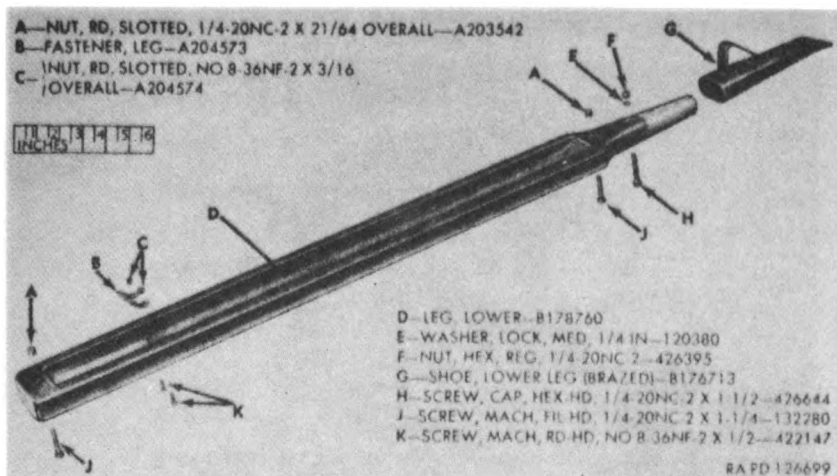

Figure 178. Leg assembly 5581876 — partially exploded view.

Remove four similar screws which secure the two clamping plates (D, fig. 179) to the upper right leg (A, fig. 179). Inspect the tripod legs and replace any of the legs that are warped, broken, or otherwise defective. Check the tripod screws and other metal parts for corrosion; replace if defective.

d. *Disassemble Tripod Head Assembly* (fig. 180). Loosen the safety nut (H) which secures the lever (J) to the hexagonal portion of the clamping screw (K). Using the lever as a wrench, rotate the clamping screw until it becomes disengaged from the caps (G and L). Remove two washers (F) from inside the caps. Rotate the clamping screw further until it is removed from the stripped head assembly (A). Slide off the sleeve (E), safety nut

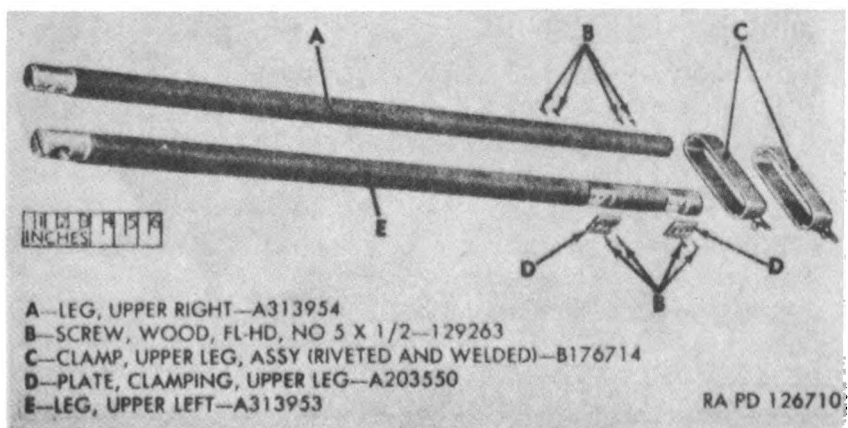

Figure 179. Leg assembly 5581876 — exploded view.

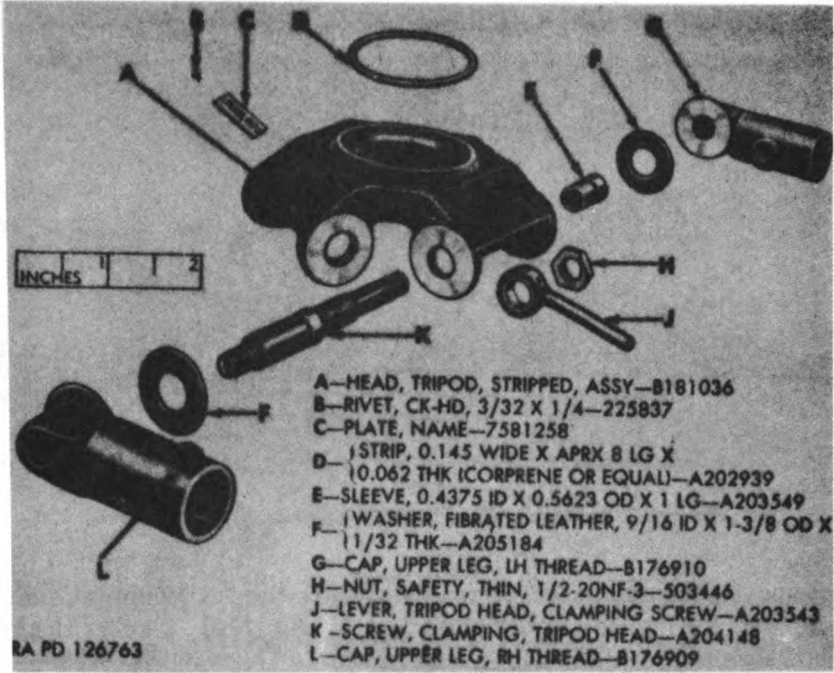

Figure 180. Tripod head assembly C81221 — exploded view.

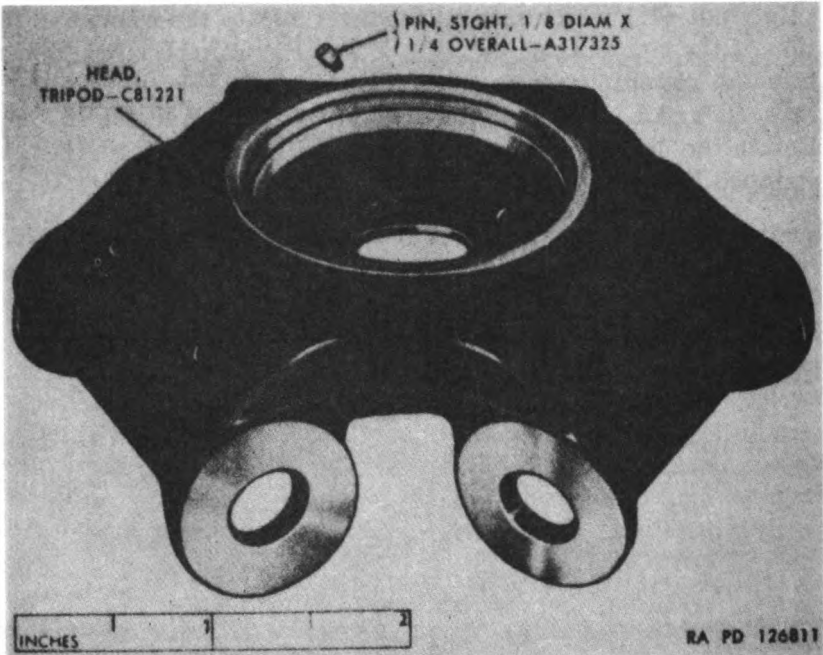

Figure 181. Stripped tripod head assembly B181036 — exploded view.

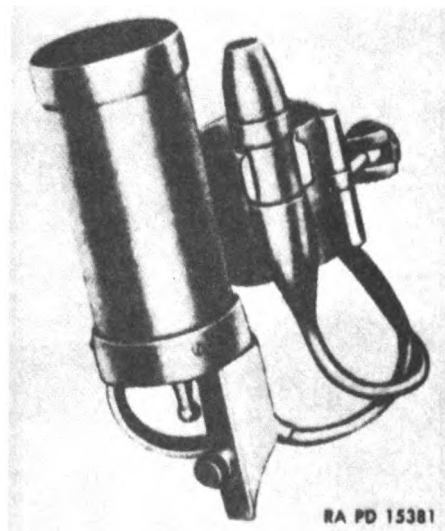

Figure 182. Instrument light M28 — assembled view.

(H), and lever (J). Remove the strip (D) from the annular groove in the stripped head assembly. Remove the rivets and the name plate only if necessary. Disassemble the stripped head assembly (fig. 181) by removing the straight pin from the head only if the pin must be replaced. Clean and inspect the parts. Check the

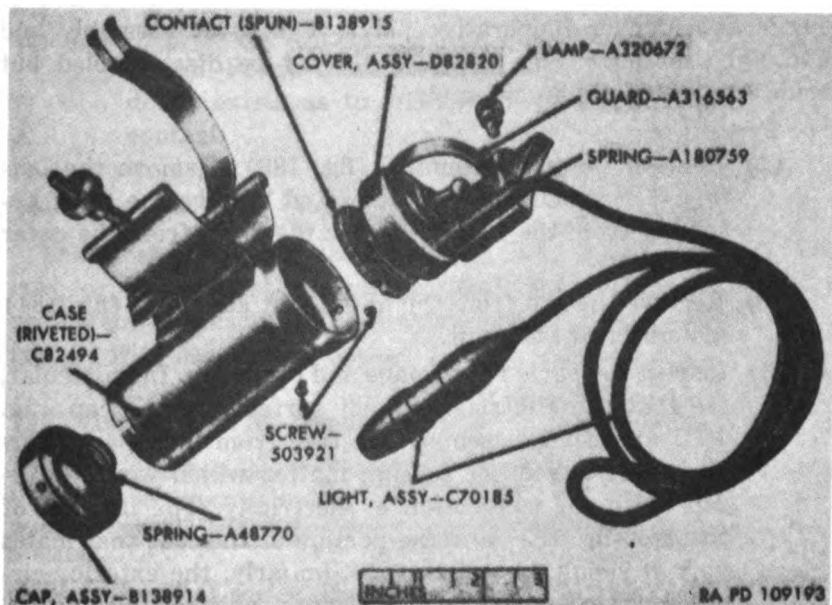

Figure 183. Instrument light M28 — exploded view.

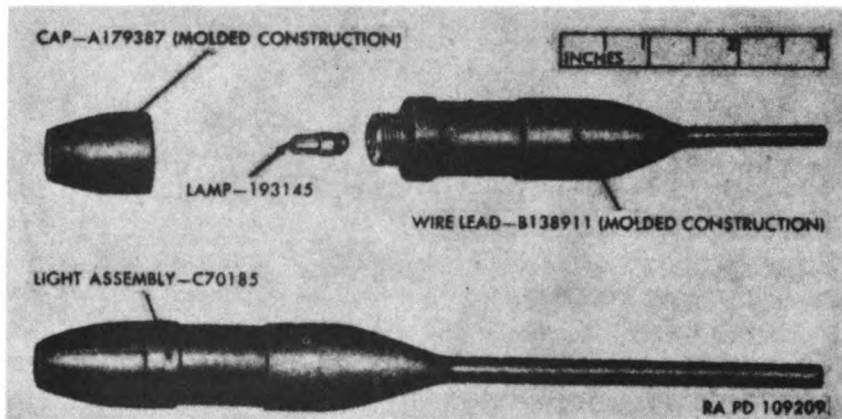

Figure 184. Hand light assembly C70185 — partial exploded view.

bearing surfaces for the upper and lower clamps of mount M48 (fig. 171) for burrs or roughness. Scrape and lap (pars. 48 and 49) together bearing surfaces with that of the clamps (fig. 171) until the roughness is eliminated. Replace any defective part that cannot be repaired.

130. Disassembly of Instrument Light M28

a. General. Disassembly of the instrument light M28 (fig. 182) should not be carried any further than is absolutely necessary to replace damaged or inoperative parts. The cover assembly and hand light assembly (fig. 183) should not be disassembled but should be replaced as an assembly.

b. Procedure.

- (1) Remove the cap assembly (fig. 183). Remove the battery. Loosen the cover screws and remove the cover assembly from the case. Unscrew the lamp from the cover assembly.
- (2) Remove the cap from the hand light assembly (fig. 184) and unscrew the lamp.
- (3) Inspect the parts for damage and corrosion. In particular, see that the electrical contact surfaces of the cap (fig. 183) and cover assembly are free from dirt, paint, corrosion, or any other foreign matter which would interfere with the conduction of electricity. The interior of the cap (fig. 183) and the portion of the case that mates with it should be unpainted. Similarly, the exterior circumference of the cover assembly and the mating interior surface of the case should be free of paint or cor-

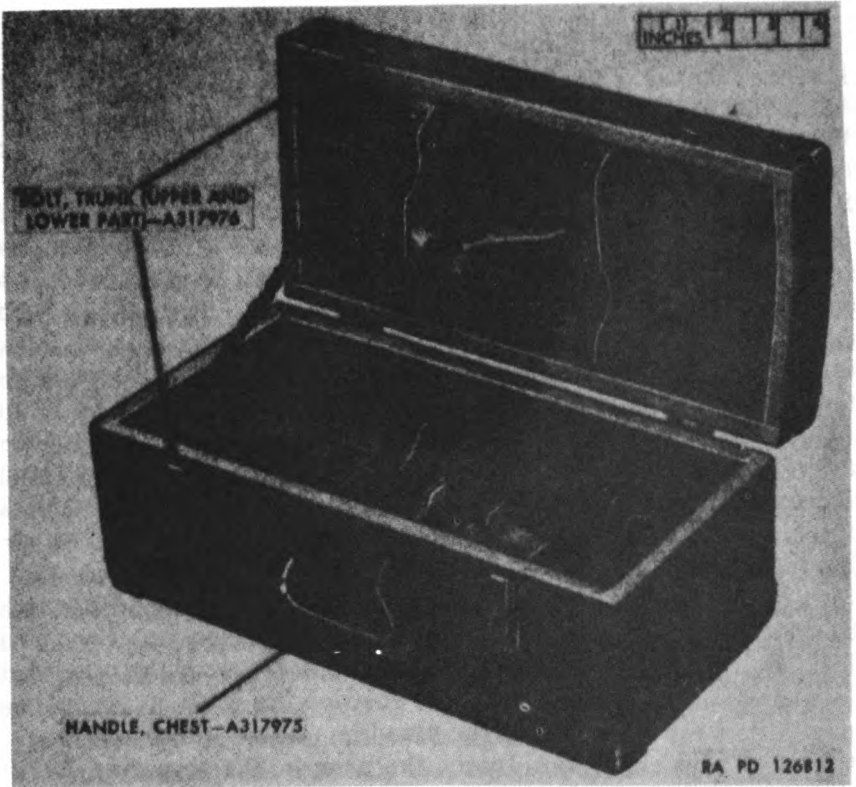

Figure 185. Packing chest M39.

rosion. Polish these surfaces with fine sandpaper if any doubt exists as to whether they afford good electrical contact.

131. Disassembly of Packing Chest M39

The chest handle and the two trunk bolts (fig. 185) are authorized for replacement on packing chest M39. If any of these parts are defective, unscrew the screws securing them to the chest and replace with serviceable parts.

132. Assembly of BC Telescope M65

Note. If it has been necessary to replace either the left or right housing support bracket or the interpupillary screw assembly, drill the pin holes in the bracket or screw assembly (1(4) below) before installing any optical elements in the instrument.

a. Assemble Level Vial Holder Assembly (fig. 169). Refer to paragraph 123.

b. Assemble Interpupillary Screw Assembly (fig. 168). Before proceeding with any required maintenance work, the principles and general repair methods pertaining to worm and worm gear mechanisms in paragraph 122 should be understood. Clean and inspect the parts of the interpupillary screw assembly. Place the interpupillary screw (D) in the lathe and check for straightness (par. 122*b*). Position the rotation strip (A) and the scale (V) on the interpupillary screw housing and secure in place with the four screws (U). Install screw (T). Apply instrument lubricating grease to the interpupillary screw (D), insert in housing, and turn clockwise into nut (C). At the same time, guide the slot of the ball socket (E) onto screw (T). Install the ball cap (F) with adjustable pin wrench 41-W-3248-115 (fig. 15) and tighten sufficiently to allow free movement of the interpupillary screw but no excessive looseness. Secure the ball cap with the setscrew (S). Examine the rotating stop rings (G), replacing those on which the lugs are damaged. Adjust the interpupillary screw (D) until the nut (C) is centralized, and install the stop rings, placing each so that the lugs of alternate rings are directly opposite. Place the fixed stop ring (H) on the screw. Press the two straight pins (J) into the knob (K) if removed, and position the knob on the interpupillary screw (D) so that the pins line up with the two holes in the fixed stop ring (H). Insert the pins in the stop ring holes and line up the holes for the taper pin (L). Install the taper pin.

Note. Knob assembly (P) which was used on instruments of earlier manufacture is installed in the same manner as knob (K).

Install the plunger (X), the spring (Y), and the slotted plug (Z). Secure the plug with the screw (W).

c. Assemble Erecting Prism Holder Assemblies (figs. 166 and 167). Check to make sure that all parts of the erecting prism holder assembly are clean and serviceable. Replace all damaged or broken parts. Position the small erecting prism spring on the holder and secure with the two screws. Set the prism in place just above its proper seat on the holder and withdraw the spring sufficiently with a hook scriber to allow the prism to drop into place. Examine to make sure the prism is properly seated on the holder. Position the larger spring over the prism and secure to the posts with four screws.

d. Assemble Eyepiece Assemblies. Check to make sure that the eyepiece cell (fig. 165) and the adapter are clean and free of all lapping compound. Lubricate the threads of the eyepiece cell with instrument lubricating grease and screw the cell into the adapter, matching the scribe mark made at disassembly. Fill the groove at the eyelens end of the cell with sealing compound (par. 51) and insert the eyelens (fig. 163). Orient the lenses as shown

in figure 163. Insert the separator, the center lens, the remaining separator, and the field lens in the cell (fig. 163). Secure the field lens with the retaining ring (right eyepiece) (figs. 163 and 164) or the diaphragm (left eyepiece) (fig. 163).

e. Assemble Reticle Assembly. With the illumination slot in the upper right-hand quadrant of the cell, position the reticle with the aid of a jeweler's magnifying glass (loupe) (from kit 41-K-96). Adjust the horizontal line of the reticle to line up with the longitudinally drilled hole in the reticle cell (fig. 161). Install and tighten the retaining ring (fig. 162) being careful to keep the reticle in the correct position. Seal the retaining ring in two or more places with shellac (par. 51). Just before installation of the reticle assembly, clean the reticle thoroughly with alcohol and lens tissue (par. 46) and, just before final installation of eyepiece assembly, remove all dust with a vacuum pickup lens cleaner (fig. 42) or camel's hair brush.

f. Assemble Filter Holder Assembly (fig. 160). Attach the driven filter holder wheel (A) to the filter holder (B) with the two screws (D) and their lock washers (C). Position the filters in the filter holder (B). Secure with the retainer (G) and the four screws (H).

g. Assemble Objective Assembly. Slide the objective lens (fig. 158) into the cell. Secure with the two retaining rings (fig. 159) and the setscrew.

h. Assemble 90° Prism Holder Assembly (fig. 157). Make certain that the polished surfaces of the 90° prisms are clean and without finger marks. Position the three springs and the support on the holder and install the three No. 10 screws, drawing each screw up until the end of the screw appears within approximately one-eighth inch of the outer surface of the holder. Position the prism on the support. Install the clip and secure with the four No. 5 screws. From outside the holder, draw the three No. 10 screws to within one-sixteenth inch of the surface of the holder (turning counterclockwise).

i. Assemble Left and Right Stripped Head Assembly (fig. 155). Install a serviceable bushing in the left head. If a new bushing is installed, drill a hole to accommodate the setscrew with a No. 50 drill, ¼-inch deep, and tap with a No. 2-64NF-3 tap. Install the setscrew and position the two heads together. Install the spindle and check to see that the large end of the spindle enters the hole to a depth of 0.002 to 0.005 inch. If necessary, ream the hole with a No. 3 Brown and Sharpe taper reamer (½-inch taper per foot) until the spindle enters the hole to the proper depth. Install the two special screws and the setscrews, adjusting to eliminate looseness as described in paragraph 127p.

j. Assemble Head Window Assembly (fig. 153). Apply a thin coating of sealing compound (par. 51) around the window seat in the head window cell, using a flexible knife. Position a serviceable window in the cell and install and tighten the retaining ring (fig. 154). Remove excess sealing compound and seal the retaining ring at one place with shellac.

k. Assemble Head Assembly. At this point, the repairman should determine whether fungus-proofing of the instrument is required and, if so, install fungicidal capsules in the left and right heads as described in paragraph 137. Install the two head window assemblies (fig. 151) and secure with the two headless setscrews. Apply sealing compound around the head window assemblies (par. 51) to seal them to the heads and re-clean windows, if necessary. Secure each of the two head window plugs to the stripped head assembly with two screws and their lock washers (fig. 151). Re-examine the polished surfaces of the prisms and windows for cleanliness. If the four pins (fig. 150) were removed from the stripped head assembly, press serviceable pins into place. Fill the grooves around the prism holder assembly seat (fig. 150) with sealing compound (par. 51) and position the prism holder assembly marked "L" in the left head of the head assembly and the prism assembly scribed "R" during disassembly, in the right head, and secure each prism holder assembly with 12 oval-head machine screws. Tighten the screws and remove excess sealing compound.

Note. The two caps and their gaskets will be installed after the 90° prisms are adjusted (par. 143).

l. Assemble Left or Right Housing with Filter Holder Assemblies. Place the detent (K, fig. 148, or J, fig. 149) in the housing and secure with its clamp and two fillister-head machine screws (E, fig. 149 or F, fig. 148). Place the washer (G, fig. 148 or 149) on the filter holder driving wheel (H, fig. 148 or 149) and insert the shaft of the wheel in the housing. After installing the composition washer (D, fig. 148 or 149) in its seat, slide the knob (B, fig. 148 or 149) on the shaft of the driving wheel. (Knob A of fig. 148 or 149 was used on instruments of early manufacture. Its installation, if used, is identical with that of knob B of fig. 148 or 149.) Aline the set screw hole in the knob with the flat on the driving wheel shaft and install the set screw (C, fig. 148 or 149). Turn the knob to indicate "C." Position the filter holder assembly so that the clear window is directly over the opening leading to the objective. Insert the No. 10 flat-fillister-head screw (M, fig. 149 or N, fig. 148) through the filter holder assembly (M, fig. 148 or L, fig. 149) and place the washer (L, fig. 148 or G, fig. 149) on the screw. Place the filter holder assembly in the housing, without spilling

off the washer, and secure with the No. 10 screw. Check to make sure that the color of the filters corresponds to that indicated on the knob. Check to see that the filter centers over the objective opening when the detent stop is in the notch of the filter assembly. If the filter is not centered, loosen the two screws (F, fig. 148 or E, fig. 149) and adjust the detent to allow the filter to center. Tighten the screws.

m. Assemble and Install Latch Assembly and Level Vial Holder Assembly.

Note. If it was necessary to replace worm gear in one of these assemblies or one of the worms with which they mate, the mating parts must be temporarily assembled and lapped into close fit (par. 122). Disassemble and thoroughly remove all abrasive before installing.

Apply a thin coating of instrument lubricating grease to the bearing surfaces of the level vial holder assembly (C, fig. 144) and the elevating worm gear (fig. 146) and to their bearing surfaces in the right housing. Insert the latch in the elevating worm gear (fig. 145). Seat the spring in the end of the latch and secure with the plug. Adjust the plug to secure clearance of undercut latch with respect to spindle hole, when spring is compressed so that the latch strikes the end of the plug. Do not yet install the knob (fig. 145), the locating bushing and washer (fig. 146), or the taper pins (fig. 146). Taking special care to avoid binding, install the level vial holder assembly (C, fig. 144) and the latch assembly as thus far assembled in the housing assembly.

Note. Should either assembly wedge in housing, tap out with rawhide mallet and reinstall. Do not attempt to force either into place.

With the spanner wrench 41-W-3250-223 (fig. 147), install washer (FF, fig. 144), and the bushing (EE, fig. 144 and fig. 147) in the gear through the hole in the bottom of the housing. Tighten until the taper pin holes are aligned. Install the two taper pins (HH, fig. 144). Install and tighten the retaining ring (A, fig. 144) using adjustable pin wrench 41-W-3248-125 (fig. 15). Secure with the setscrew (KK). Place the knob on the latch (fig. 145) and secure with the setscrew.

n. Install Elevating Worm (fig. 144). Check the elevating worm (LL) for straightness. Lubricate the worm with instrument lubricating grease. Install the screw (GG) in the housing. Holding the ball socket (UU) in place on the worm, turn the worm clockwise into the housing, at the same time guiding the slot on the socket onto the screw (GG). Install the ball cap (MM) in the housing, tightening with adjustable pin wrench 41-W-3248-130 (fig. 187) sufficiently to eliminate excessive looseness without preventing free movement. Secure with the setscrew (JJ), tighten screw (GG). Examine the eight rotating stop rings (NN),

replacing those on which the lugs are damaged. Adjust the worm so that the locating bushing (EE) is centralized in the opening in the housing and install the eight rotating stop rings on the worm, placing each so that the lug is directly opposite the lug of the stop previously installed. Press two straight serviceable pins (TT) into the knob (QQ). Place the movable stop ring (PP) over the straight pins in the knob and install the knob on the worm shaft. Aline the taper pin holes and install the taper pin (RR). Insert the plunger (G) and spring (F). Install the plug (E), tightening to the point where the worm moves without binding but is not loose. Secure the plug with the setscrew (H).

o. Install Angle of Site Worm (fig. 144). Insert the worm plunger (BB) in the housing so that its hole is parallel to the worm axis. Apply an ample amount of instrument lubricating grease to the worm (J). Install the screw (Z) which secures the ball socket (K). Holding the ball socket in place on the worm, turn the worm clockwise into the housing, meanwhile guiding the slot in the ball socket onto the screw (Z). With adjustable face spanner wrench 41-W-3248-115 (fig. 15), install the ball cap (L) with no looseness. Install the setscrew (Y) which secures the ball cap and tighten screw (Z). Adjust the worm so that the level vial is approximately parallel to the axis of the worm. Install the eight rotating stop rings as described in *n* above. If the two pins were removed from adapter (Q), press serviceable pins back into place and place the fixed stop ring (N) over the pins of the adapter. Place the adapter and fixed stop ring on the worm shaft and secure with the taper pin (R). Place the micrometer (S) and knob (T) over the adapter and secure with the three screws (U). Insert the spring (CC) and secure with the plug (DD) and setscrew (AA). Secure the angle of site scale (W) to the housing with the two screws (X).

p. Install Reticle Assembly (fig. 141). Check the cleanliness of the reticle. Install the reticle assembly (S) in the housing so that the slot in the reticle cell is directly opposite the hole for screw (E). The screw (E) plugs the hole which permits adjustment of the reticle. Install four screws (B); adjust the screws to center the reticle assembly. Install the retaining ring (fig. 147) and secure with screw (fig. 141). Make sure that the reticle is free of all dust particles before installing the right eyepiece assembly. If the reticle window (T) was removed, install a serviceable window and stake and shellac in place.

q. Install Eyepiece Assemblies. Apply sealing compound around the flange of the eyepiece assemblies (par. 51) and screw the eyepiece assemblies (I, fig. 140 or J, fig. 141) into the housing until the screw holes for the oval-head machine screws (H,

fig. 140 or D, fig. 141) are alined. Install the oval-head machine screws. Remove excess sealing compound with a pallet knife and alcohol. Slide the eyepiece sleeve (N, fig. 140 or L, fig. 141) into the diopter scale (P, fig. 140 or M, fig. 141) and install the clamping ring (Q, fig. 140 or N, fig. 141) and secure with the special screw (R, fig. 140 or P, fig. 141). Install the eye guard (S, fig. 140 or Q, fig. 141). Screw these parts just assembled onto the eyepiece assembly until the screw holes in the sleeve aline with those in the eyepiece assembly. Secure with the three oval-head machine screws (M or K).

r. Install Erecting Prism Holder Assemblies. Position the left erecting prism holder assembly (C, fig. 140) in the left housing, seating the guide pins in their holes in the two internal housing flanges. Secure the assembly with four screws (B, fig. 140 or 141). Similarly, install the right erecting prism holder assembly (F, fig. 141) securing with screws (G, fig. 141). If fungus-proofing of the instrument is required, install fungicidal capsules in the left and right housings as described in paragraph 137. Install the housing cover (A, fig. 140 or H, fig. 141) and secure with the set screw (D, fig. 140 or C, fig. 141).

s. Install Objective Assemblies. Install the objective assembly in the tube (fig. 141) turning the cell inward with tubular wrench 41-W-3726-250 (fig. 139) until the circular scribe mark made at disassembly lines up with the hole for the objective cell adjusting screw. Install the adjusting screw (fig. 137). Repeat for the other objective assembly.

t. Assemble Tubes to Housing and Head Assemblies.

- (1) Place the round nuts on the tubes (fig. 137). Apply a moderate amount of sealing compound around the threaded portion of the right housing assembly (A, fig. 141) and screw into the right housing the tube with the scribe mark made at disassembly (par. 127*d*). Tighten the tube until the screw holes aline, and install the three No. 5 oval-head screws (fig. 137). Similarly, assemble the other tube to the left housing assembly. Remove excess sealing compound with a pallet knife and alcohol. Slide the head assembly (fig. 137) into position in the tube, after filling the grooves at the base of the head assembly threads with sealing compound (par. 51). Secure with the two round nuts (fig. 137), tightening with wrench 41-W-3249-740 (fig. 186) to the point where the screw holes aline. Install the headless setscrews (fig. 137) in the round nuts. Remove excess sealing compound.
- (2) Attach the left housing support bracket (J, fig. 140) to the left housing with three screws (T, fig. 140). Position

the interpupillary screw assembly (W, fig. 140) so that the nut of the screw assembly fits into the notch on the support bracket (J, fig. 140). Bring the right housing under the interpupillary screw assembly so that the four screw holes are aligned and lightly secure the interpupillary screw assembly to the right housing with the four screws (U, fig. 140).

- (3) If neither the screw assembly nor the bracket has been replaced, pin the bracket (J, fig. 140) to the left housing with two pins (K, fig. 140) and pin the interpupillary screw assembly to the right housing with two pins (V, fig. 140).
- (4) If it has been necessary to replace either the screw assembly (W, fig. 140) or the bracket (J, fig. 140), tighten the screws sufficiently to hold each part in place yet permit slight changing of position of each by tapping with a rawhide mallet. Tap either or both parts until a snug yet free movement is obtained in the fit of the two parts from one extremity of interpupillary movement to the other. At this point, tighten the screws securely and, using a No. 31 drill, drill two holes for pins (K, fig.

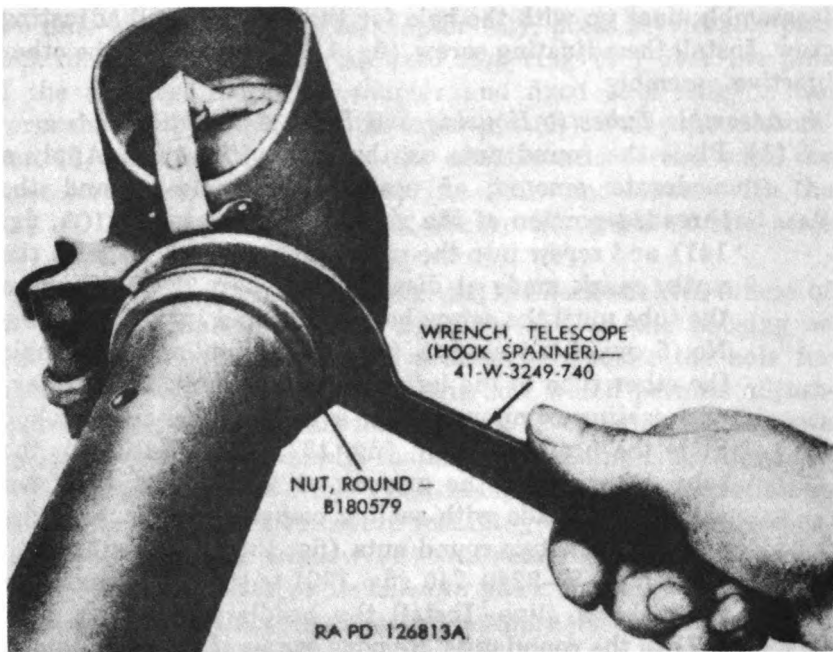

Figure 186. Tightening round nut with telescope (Hook Spanner) wrench — 41-W-3249-740.

140) through bracket and housing and drill two holes for pins (V, fig. 140) to an exact depth of $1\frac{1}{8}$ -inches, including the thickness of the screw assembly. Install the pins (K and V, fig. 140).

Caution: The depth of the holes for pins (V, fig. 140) must not exceed $1\frac{1}{8}$ inches. To exceed this depth will result in the latch assembly binding.

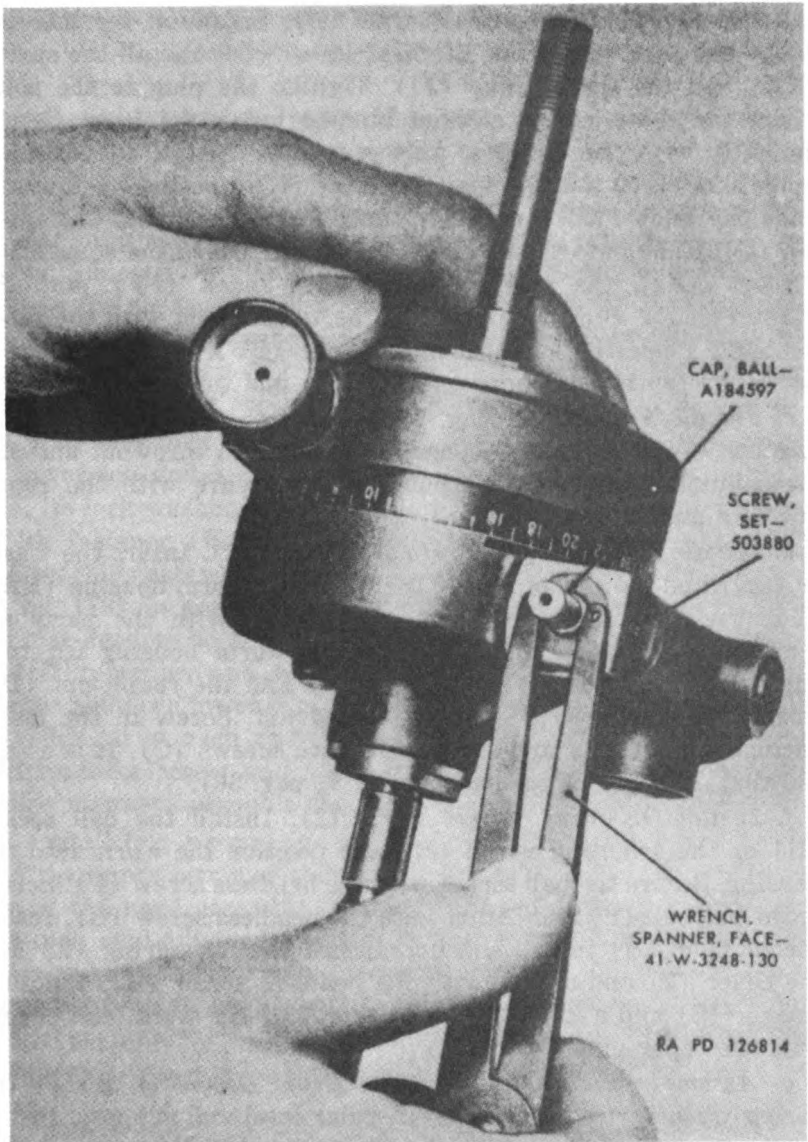

Figure 187. Tightening azimuth worm ball cap.

133. Assembly of Telescope Mount M48

a. *Assemble Spindle Assembly* (fig. 174). Screw the spindle into the housing and secure with the taper pin.

b. *Assemble Azimuth Worm Housing Assembly* (fig. 173). Plug holes from which oil cups were removed.

c. *Install Azimuth Worm* (fig. 172). Slide the worm plunger (LL) into the azimuth worm housing. Install the ball socket (Z) on the worm and screw the worm into the housing. Secure the ball socket with the headless screw (F). Screw on the ball cap (AA) and secure with the headless screw (G). Install the spring (KK) and the slotted plug (JJ). Tighten the plug to the point where the worm moves without binding but is not loose. Secure the plug with the headless setscrew (G). Install the azimuth worm shoe (PP) and the spring washer (NN) on the worm shaft. Slide the knob (MM) onto the shaft and secure with the taper pin (Q). Slide onto the opposite end of the worm the square felt washer (GG), the azimuth micrometer index (FF), and the adapter (EE). Pin the adapter to the worm shaft with the taper pin (Q). Place the azimuth micrometer (BB) over the adapter and secure with the clamping disk (CC) and three screws (DD).

d. *Install Worm Gear* (fig. 172). Place the gasket (T) in the azimuth worm housing. Disengage the azimuth throwout and slip the azimuth worm into the housing and secure with the round nut (V) and setscrew (U).

e. *Install Orienting Worm Housing* (fig. 172). Insert the washer (QQ) and the gasket (T) in the orienting worm housing (RR). Slide the azimuth worm housing assembly, with the parts assembled to it above, and the orienting worm housing together and secure with the spring washer (E) and the round nut (D). Install the setscrew (SS) in the round nut. Screw in the lower vertical spindle (B) and secure with two screws (C). It is essential that all burrs be removed (table V, par. 36).

f. *Install Orienting Worm* (fig. 172). Install the ball socket (N) on the orienting worm (M) and position the worm into the housing. Secure the ball socket with the headless screw (F). Screw in the ball cap (P) and secure with the headless screw (G). Insert the plunger (H) in the housing. Install the flat spring (L) and the cover (J) and secure with the headless screw (K). Install a washer (S) and a knob (R) on each end of the worm and secure with the taper pins (Q).

g. *Assemble and Install Circular Level Assembly*. Install the spring washer (fig. 175) in the circular level vial support. Install the circular level vial and screw the cap onto the support. Install the three headless screws in the cap. Screw the circular

level assembly (HH, fig. 172) into the housing as far as it goes and then back off one-half turn.

h. Install Mount on Tripod (fig. 171). After the tripod is assembled (par. 134), install the upper clamp on the lower spindle. Place the mount and the upper clamp on the tripod and align the slot in the upper clamp on the pin in the tripod. Install on the spindle in the order named the lower clamp, a washer, the compression spring, another washer, the wing nut with two wings, another washer, and the wing nut with four wings. Screw into the bottom of the spindle the *left-hand* thread screw (A, fig. 172).

134. Assembly of Tripod M17

a. Assembly of Tripod Head Assembly (figs. 180 and 181). Press the pin into the tripod head if this was removed. Insert the clamping screw into the bushing of the stripped head assembly. Slide on the clamping lever and screw on the safety nut. Slide on the sleeve. Install a washer inside each of the caps. Using the lever as a wrench, screw the clamping screw into the caps (table V — par. 36). In a similar manner, assemble the two remaining clamping screws to the tripod head.

b. Assemble Leg Assembly. Slide the shoe (G, fig. 178) onto the lower leg and secure with the hex-head cap screw (H, fig. 178), its lock washer (E, fig. 178), and nut (F, fig. 178). Secure the leg fastener (B, fig. 178) to the lower leg with two round-head machine screws and slotted round nuts. Place the two plates (D, fig. 179) in position on the right upper leg and secure with four flat-head wood screws. Place the two clamps in position on the left upper leg and secure in place with four flat-head wood screws. Slide the lower leg (D, fig. 178) through the clamps (fig. 179). Install at each end of the lower leg the 1/4-inch fillister-head machine screw and secure with a slotted round nut. In a similar manner, assemble the other two tripod leg assemblies.

c. Install Leg Assembly (fig. 177). Install the clamping wedges in the upper legs and slide the ends of the upper legs into the caps of the head assembly. Secure the legs to the caps with the 5/16-inch oval-fillister-head screws. Install the remaining tripod leg assemblies in the same manner.

d. Install Carrying Strap (fig. 177). Attach the carrying straps to one leg only of the tripod with two fillister-head machine screws, their finishing washers, and slotted round nuts.

135. Assembly of Instrument Light M28

a. Install the lamps and lamp assemblies in their sockets (figs.

183 and 184). Screw the cap (fig. 184) onto hand lamp.

b. Place the cover assembly in position on the case (fig. 183) and secure in place with the cover screws. Install the battery in the tube and check for illumination of lamps. Install the cap assembly (fig. 183).

136. Assembly of Packing Chest M39

a. If the trunk bolts (fig. 185) were removed, secure to the chest with the four screws. Make sure that the upper and lower portions of the bolt align correctly and that the bolt can be fastened properly.

b. Secure the handle (fig. 185) to the chest, if removed, with the four screws.

137. Fungus Proofing BC Telescope M65

a. *Purpose.* This paragraph provides information regarding the fungus-proofing of the BC telescope by installing fungicidal capsules.

b. *General.*

(1) The necessary fungus-proofing materials are available for issue and are listed in ORD 3 SNL K-1 as follows:

Filled aluminum fungicidal capsule (size 2) 51-C-683.

Asphalt cement (1-lb can) 52-C-135.

Optical lens sealing compound 52-C-3259-185.

(2) The installation of fungicidal capsules will be accomplished by ordnance instrument repairmen in *Pacific, Caribbean, and African areas only*. Because the active fungicidal element employed tends to speed up corrosion action on metallic finishes and to soften optical cements, *fungicidal capsules will be used only in those instruments which are being rendered unserviceable, or which experience has shown will be rendered unserviceable by fungal growth.*

c. *Procedure.*

(1) The partial disassembly of the instrument for the installation of the fungicidal capsules will affect the optical alignment of the 90° prisms in the head assembly. Hence, after installation of the capsules, realign the prisms as described in paragraph 143.

(2) Remove six screws and six lock washers from the left head cap (fig. 150). Remove the cap and gasket from the left head. Remove six screws (fig. 150) and left the 90°

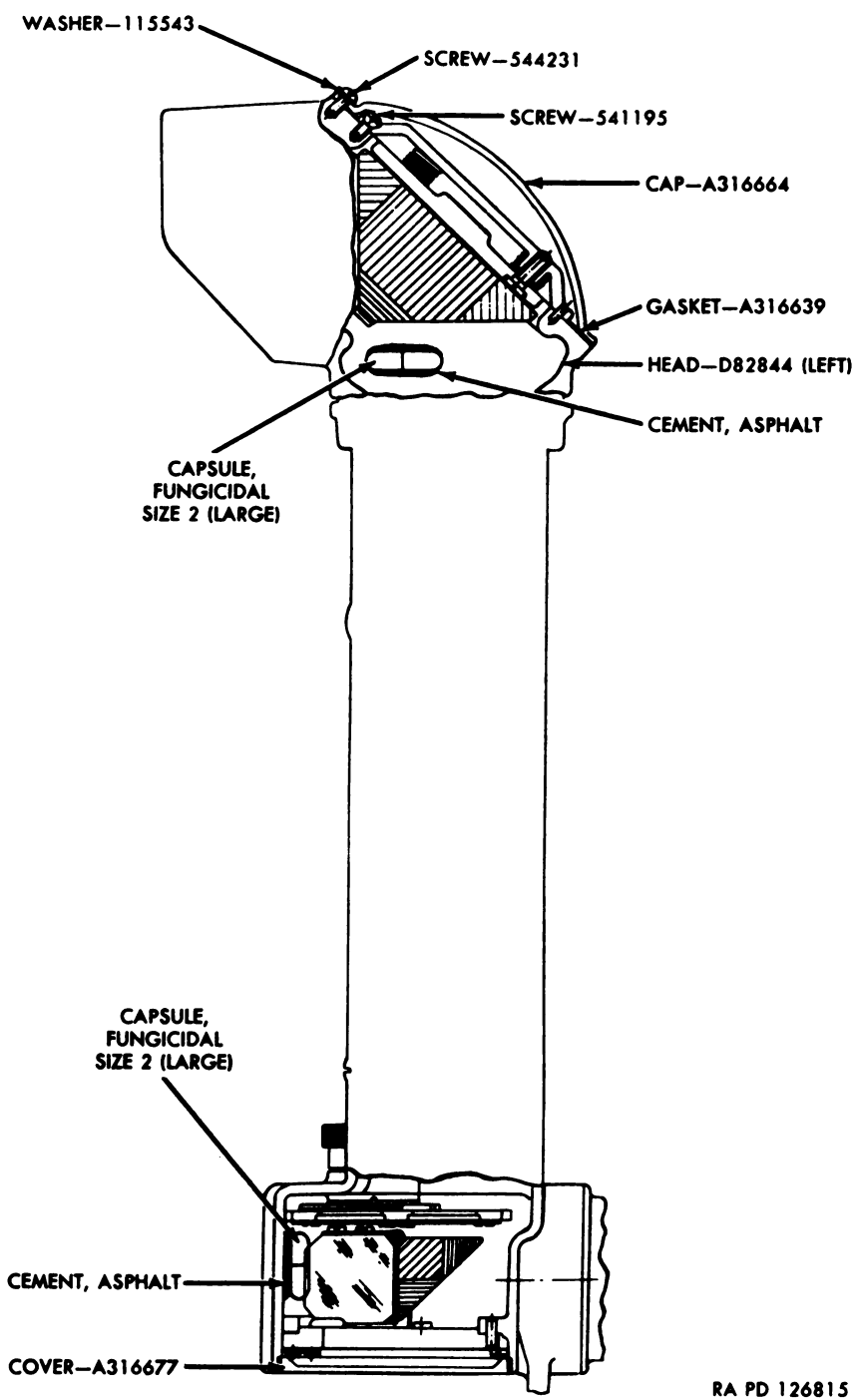

RA PD 126815

Figure 188. BC telescope M65 with fungicidal capsules installed — cross section.

prism holder assembly from the head. The prism holder assembly is located by two pins and it will, therefore, be necessary to pry it evenly on all sides to remove it.

- (3) To prevent the reflection of light rays from their aluminum surfaces, the fungicidal capsules must be completely covered with a thin coating of asphalt cement. The cement is melted in a container over a hot plate, applied to the capsules with a small brush, and allowed to harden. Cover one fungicidal capsule, size 2 (large), with asphalt cement. Place the capsule in the head, as shown in figure 188.
- (4) Cement the capsule in position with asphalt cement. To obtain a good bond between the body of the instrument and the asphalt cement, apply a small amount of the cement to the designated portion of the instrument body and heat the cement by applying a heated iron for a short time. To obtain a good bond between the asphalt cement and the fungicidal capsule, apply a small additional quantity of cement to that on the instrument body while the latter portion is still soft, *heat again*, and then *push the capsule into the heated cement*. Allow the cement to harden.
- (5) After the capsule has been cemented in position and the cement has been allowed to harden, *a small hole will be punched in the capsule with a sharp pointed tool such as a scribe*. Make sure that the asphalt cement

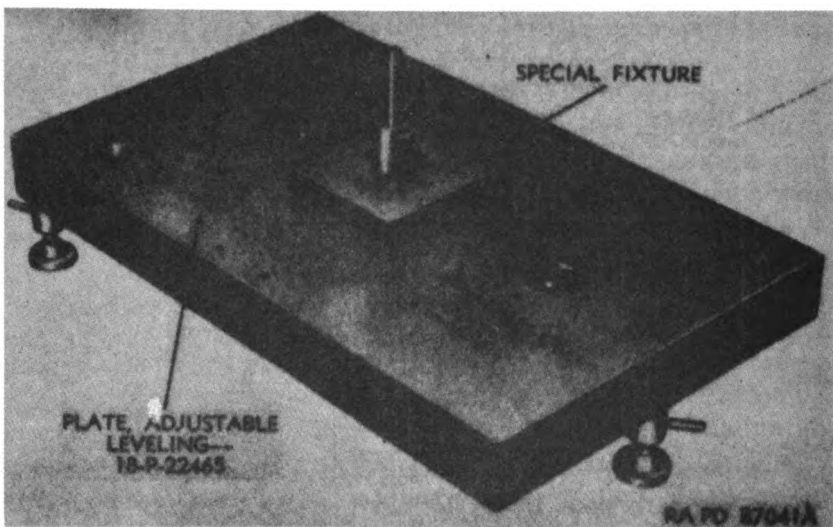

Figure 189. Special fixture in position on leveling plate.

has hardened and that it will not flow over the holes, resealing the capsule and defeating the purpose for which it is intended. *The instrument will then be resealed immediately.*

- (6) Replace and carefully reseal the 90° prism holder assembly with sealing compound (par. 51).
- (7) Replace the six screws securing the prism holder assembly (fig. 150). Check the alinement of the 90° prism (par. 143). Replace the gasket, the head cap, the six screws, and six lock washers (fig. 150).
- (8) Remove the setscrew (D, fig. 140) staking the left hous-

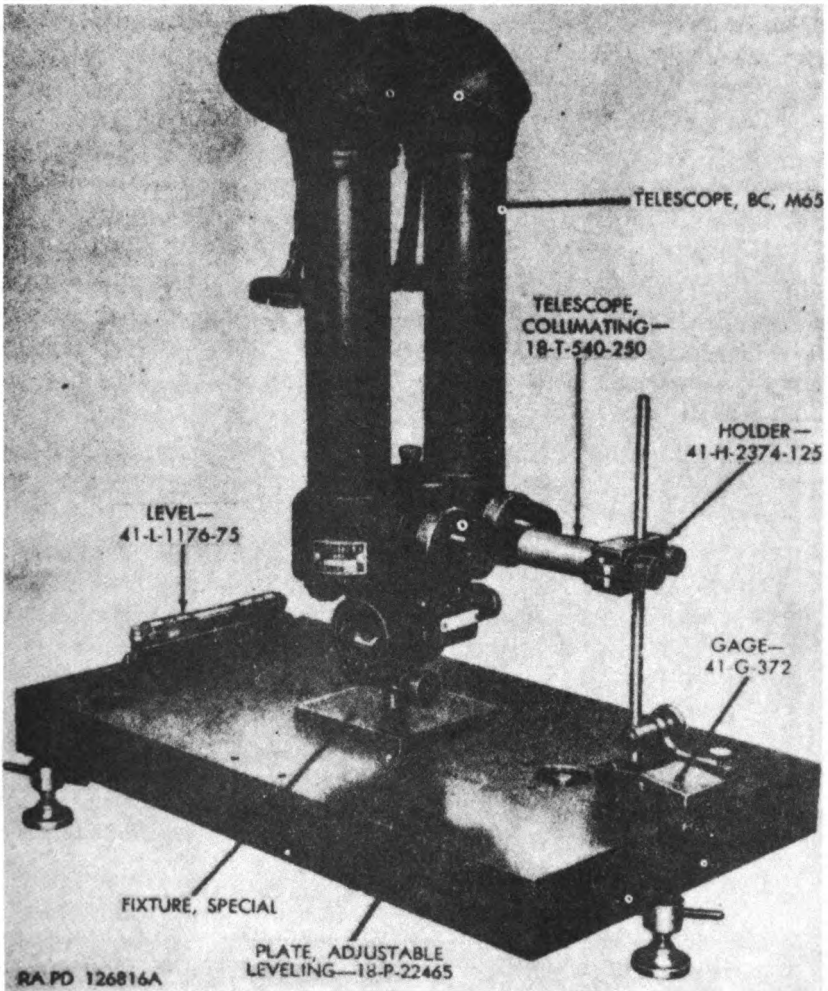

Figure 190. BC telescope M65 in position for collimating.

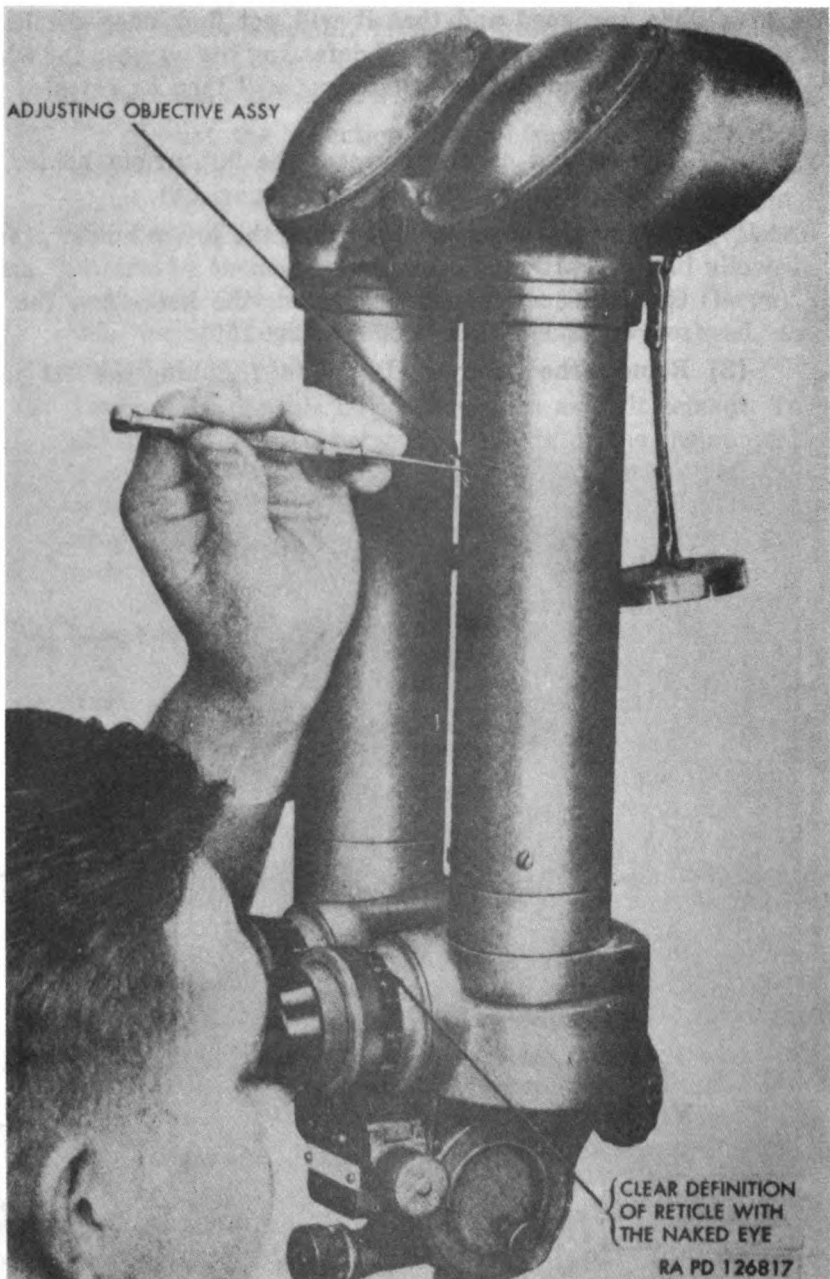

Figure 191. Eliminating parallax.

ing cover (A, fig. 144) to the left housing assembly. Unscrew and remove the cover.

(9) Repeat (2) through (5) above, positioning one fungici-

- dal capsule, size 2 (large) as shown in figure 188.
- (10) Replace and reseal the housing cover and setscrew, following the sealing instructions given in 51.
 - (11) Repeat (1) through (10) above on the right telescope.

Section III. TESTS AND ADJUSTMENTS

138. General

The following optical inspection procedures for the BC telescope involve the use of the special fixture for collimation (par. 19 and fig. 30) and tools shown on figures 189 and 190. Further inspection tools are listed in tables II (par. 11) and III (par. 19) and identified where required in paragraphs 139 through 149. The procedures for setting the BC telescope in position for performing the tests in this section are covered in paragraph 143.

139. Definition of Field of View, Diopter Setting, and Parallax

a. Sighting through an auxiliary telescope of at least 3 power, rotate the right eyepiece until the reticle is sharp and clear. Set right diopter scale at zero. Sight through the right eyepiece at a target 650 yards distant and check for parallax. If parallax exists, rotate the objective assembly in or out as needed (fig. 191).

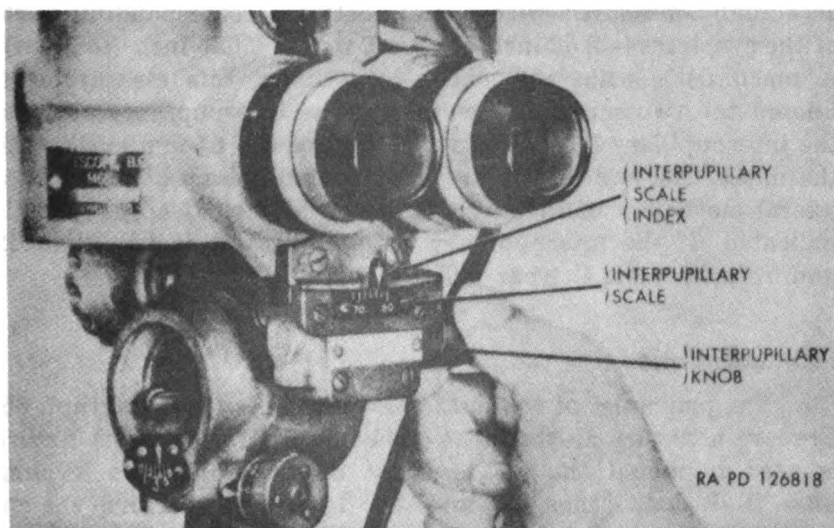

Figure 188. Adjusting interpupillary scale.

b. With the right eyepiece set at zero, lay a straight-edge or scale across the eyepieces. Rotate the left eyepiece until the height is equal to that of the right eyepiece. Set left diopter scale on zero. Rotate left objective assembly in or out until the field of view of the left telescope, as viewed with an auxiliary telescope, is at its sharpest point with the left eyepiece set at zero.

c. Secure the objective assemblies in position with the headless conepoint setscrews. Insert special screws A316673 in tubes.

140. Tilt of Field of View

Since both tilt of field and collimation require adjustment of the 90° prism in the head assemblies, these adjustments are made simultaneously. If tilt of field cannot be removed by adjusting the 90° prisms, replace the erecting prism assembly and retest.

141. Stagger

The inspection tolerance for eyepiece stagger is prescribed in paragraph 31i. If the procedures of paragraphs 139 and 140 were properly performed, stagger is automatically eliminated.

142. Interpupillary Scale Setting

Adjust the interpupillary knob (fig. 192) so that the distance as actually measured with a scale between corresponding parts of the eyepieces is 2.52 inches correct within 0.020 inch (0.5 mm). A machinist's scale will suffice to perform this measurement. Loosen the two screws which secure the interpupillary scale to the interpupillary screw housing and aline the 64-mm mark with the index. The two screws are in elongated holes which permit a lateral movement of the scale against the index if adjustment is indicated. If the interpupillary scale movement is less than 12 mm, refer to table V, (par. 36).

143. Collimation

a. The principles of collimation are presented in paragraph 65. Prepare a fixture as shown in figure 30 (par. 19). This fixture is used to mount the BC telescope on the adjustable leveling plate 18-P-22465 (figs. 189 and 190) in order to perform the optical tests prescribed in this section. It is made with a square base so that the collimating telescope 18-T-540-250 (fig. 190) in

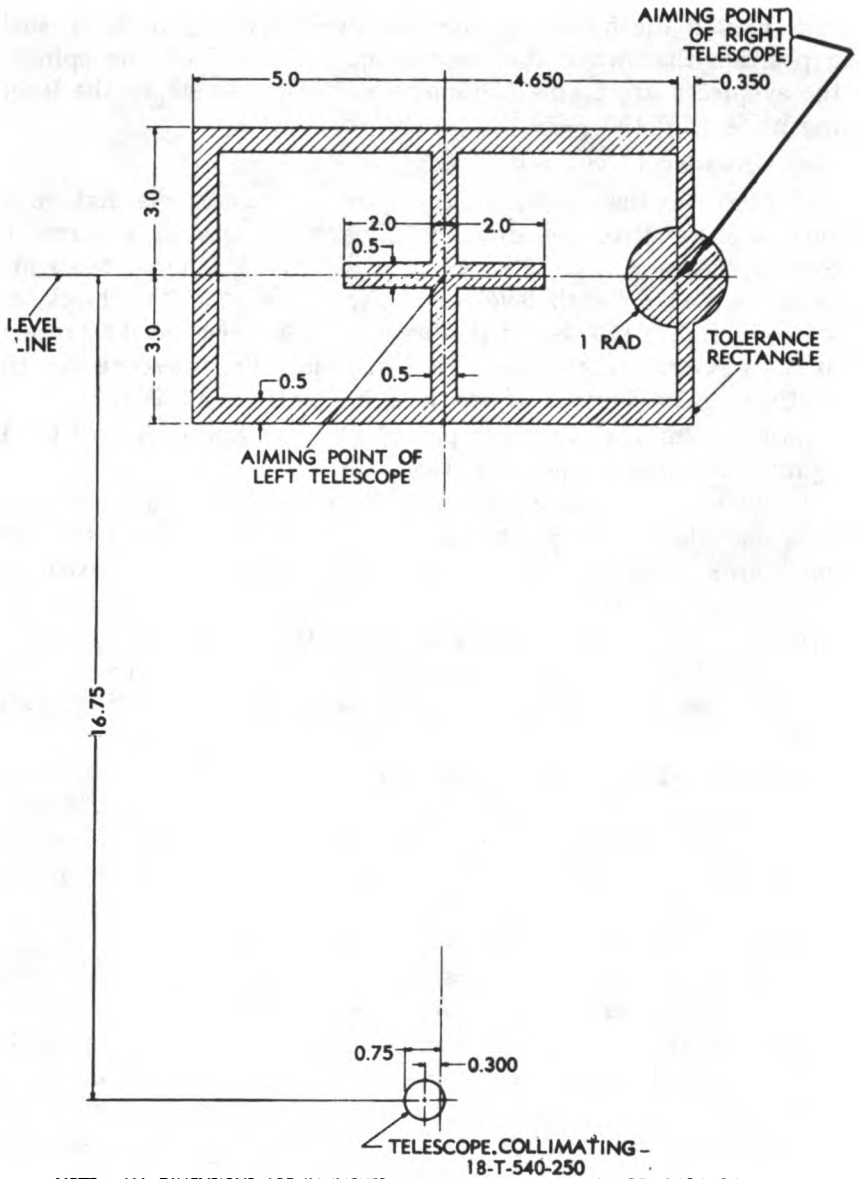

Figure 193. Target for collimating BC telescope M65.

"V" block 41-B-1472-100 will be parallel to the BC telescope when the "V" block is set flush against the side of the improvised special fixture (table III, par. 19) (fig. 190).

b. Prepare the target shown in figure 193.

c. Place the target in a plumb position at the same height as the instrument and 189 yards distant.

d. Fasten the fixture to the adjustable leveling plate in such a position that when the instrument is located on the spindle, the eyepieces are facing the single adjusting screw on the leveling plate (fig. 190).

e. Cross-level the leveling plate.

f. Place the instrument on the spindle of the special fixture in such position that the single leveling plate adjusting screw is toward the rear (fig. 190). Place a "V" block against the right telescope and a bench level upon the end of the "V" block, as shown in figure 195. Bring the instrument to exact level by means of the elevating mechanism. This will place the telescope exactly vertical to the surface of the leveling plate (fig. 190).

g. Place collimating telescope in "V" block and slide "V" block against left side of special fixture.

h. Swing the leveling plate (fig. 190) in azimuth until the collimating telescope is pointed toward the lower circle on the target. Check to see that the leveling plate is exactly level crosswise.

i. Manipulate the rear jackscrew of the leveling plate to elevate or depress the leveling plate until the collimating telescope 18-T-540-250 (fig. 190) is centered on the lower circle of the target. Again check the crosswise level of the leveling plate (fig. 190).

j. Place the collimating telescope 18-T-540-250 in the holder on the surface gage 41-G-372 (fig. 190). With the locating pins of the surface gage flush against the rear edge of the leveling plate, raise the collimating telescope to the level of the eyepieces of the BC telescope.

k. Set the interpupillary distance at 63 mm.

l. Sight the collimating telescope 18-T-540-250 (fig. 190) on a plumb line and check the verticality of its reticle.

m. Slide the surface gage behind the right telescope and sight through the collimator to determine whether or not the line of sight is centered on the upper circle of the target. If it is not, remove the head cap (fig. 150) of the upper right head and adjust the three spring-loaded screws of the 90° prism holder assembly (fig. 194) until the cross-hairs of the collimating telescope reticle split the circle (fig. 193).

n. Slide the surface gage 41-G-372 (fig. 190) to bring the collimating telescope 18-T-540-250 (fig. 190) behind the left eyepiece and perform the above checks and adjustments until the cross-hairs of the collimating telescope reticle split the cross on the target.

o. Set the interpupillary distance at 72 mm and slide the collimating telescope behind the left eyepiece. The cross hairs of

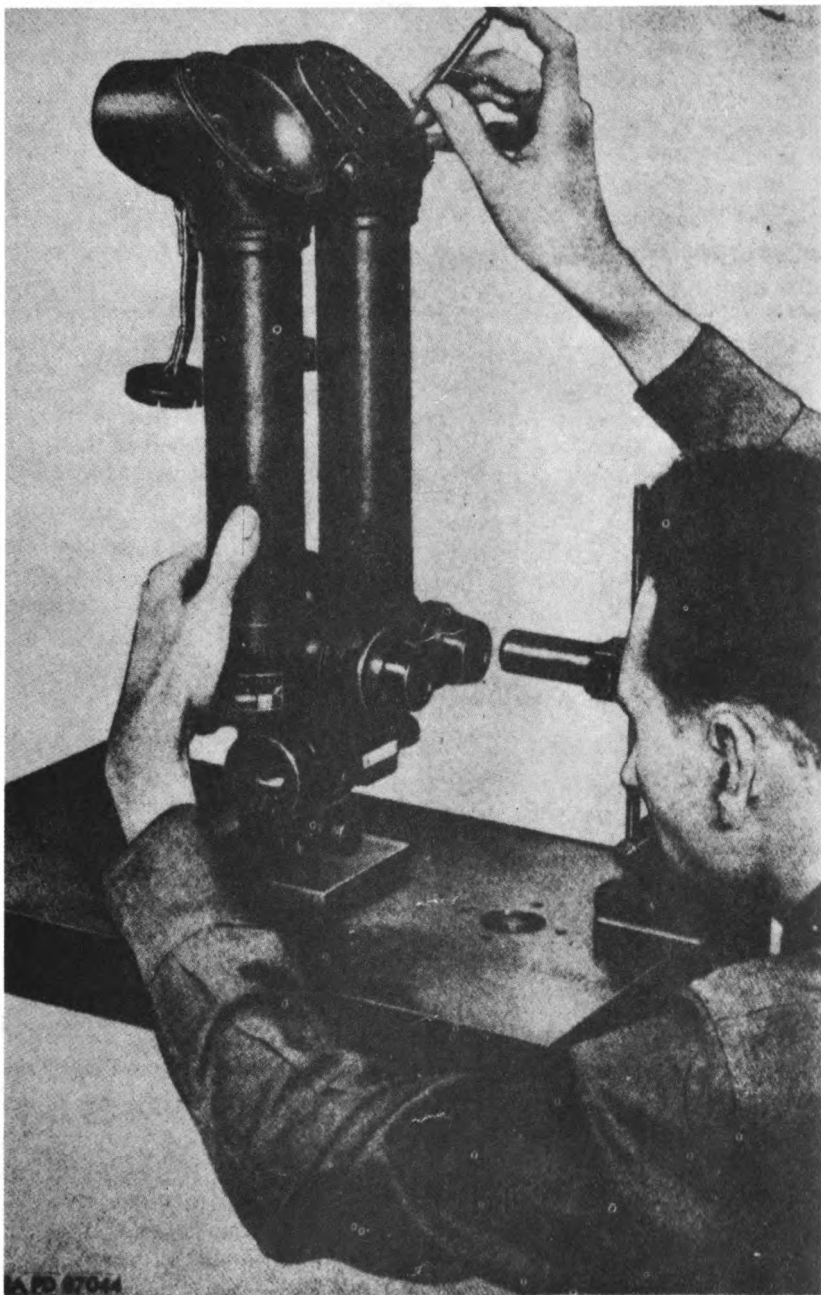

Figure 194. Adjusting 90° prism holder assembly — BC telescope M65.

the collimating telescope reticle must lie within the large tolerance rectangle of the target. Recheck the right telescope to see that its line of sight still splits the circle on the target.



Figure 195. Bringing right telescope into true vertical position.

- p.* Set the interpupillary distance at 60 mm and repeat the test, again checking right telescope to see that it has not moved.
- q.* When the cross-hairs of the collimating telescope 18-T-540-

250 (fig. 190) do not stay within the tolerance rectangle at all interpupillary settings, the optical axes of the telescopes are not parallel to the true mechanical axis of the hinge. Consequently, it is necessary to relocate the optical line of sight by adjusting the head prisms. In making this adjustment, the error will be split on either side of the true line of sight. Thus, a vertical error of 1 mil will read 0.5-mil above and 0.5-mil below the line of sight at the extremities of the interpupillary movement. Horizontal errors will be corrected in the same manner. When the instrument cannot be collimated by adjusting the head prisms, the error can generally be attributed to binding in the hinge or to binding in the interpupillary movement. To inspect the hinge, disassemble the interpupillary movement and swing the left tube outward on the hinge. When released, it should return to its normal position under its own weight. A further check can be made by viewing the target through the left tube with a collimating telescope and moving the left tube and the collimating telescope through the range of the interpupillary movement. When the line of sight remains within the tolerance rectangle, the hinge is not the source of error. To inspect the interpupillary movement, examine the mating surfaces of the left housing bracket and the interpupillary screw housing for burrs, nicks, or binding. Remove burrs or high spots on the mating surfaces of the hinge or of the interpupillary movement with a fine mill file. When these measures fail to correct the collimation error, replace all worn or damaged parts.

Note. Check that all optical elements are properly seated before replacing parts.

r. After locating hinge position on large target, measure its exact distance from upper diamond. Going down to the collimating telescope 18-T-540-250 (fig. 190) in "V" block 41-B-1472-100 (fig. 134) that is set flush against special fixture (fig. 190) and is aiming on lower circle on target, relocate this exact point from the lower circle, only in the opposite direction. Sighting through collimating telescope, adjust jackscrews on leveling plate until cross-hairs are superimposed on located point. This will locate the true mechanical hinge on upper diamond. Recollimate the instrument as directed above.

144. Tilt of Reticle

a. *General.* The reticle of the BC telescope must be correctly oriented with respect to the field of view when the telescope has been set up in a true vertical position (fig. 195). A tolerance for tilt of reticle is $\frac{1}{2}$ -mil block as measured across the entire

field of view.

b. Procedures. With the telescope set up as shown in figure 195 (par. 31d), sight through both eyepieces of the BC telescope at the plumb line target. If the vertical reticle line (fig. 161) does not align with the plumb line, slightly loosen the four reticle positioning screws (B, fig. 141), and remove the No. 8 screw (E, fig. 141). Using a scribe inserted through the hole for the No. 8 screw, rotate the reticle cell the desired amount and recheck. Install the No. 8 screw and tighten the positioning screws.

145. Adjusting Angle of Site Level

With the telescope collimated as directed in paragraph 143 and the adjustable leveling plate is cross-leveled, center the angle of site level bubble. When it is necessary to reset the angle of site index or the micrometer, proceed as follows: Loosen two screws (fig. 169) which secure the angle of site index (fig. 196) to the level vial holder and move the index so that the arrow coincides with the "3" on the angle of site scale. Tighten the two

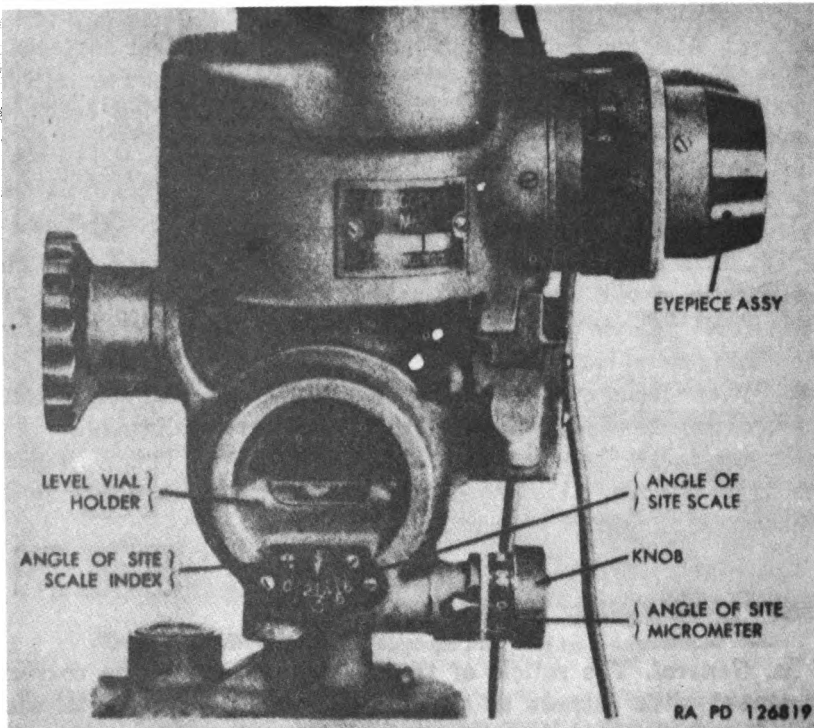

Figure 196. Angle of site mechanism.

screws. Loosen the three retaining screws (fig. 196) which secure the angle of site knob and micrometer and turn the micrometer until the "0" coincides with the index. Tighten the three screws and recheck collimation and level bubble position. The angle of site mechanism should be operated throughout its entire range and should function without undue irregularities, friction, or looseness. Refer to paragraph 147 for checking the accuracy of the angle of site mechanism using leveling fixture 41-F-2994 (fig. 24).

146. Horizontal or Azimuth and Orienting Mechanism Travel

a. General. Rotate the BC telescope, in a horizontal plane. The worm and gear principles and general repair methods in paragraph 122 should be referred to for complete instructions on adjustment and repair procedures. The azimuth worm can be disengaged from its worm wheel by outward pressure on the azimuth worm knob to allow for rapid turning of the BC telescope and for quick approximate settings. Error in horizontal travel is due to the failure of the azimuth and orienting movement to maintain an exact horizontal position throughout a complete rotation of the mount and BC telescope. Instructions for adjustments and repair are presented in paragraph 122.

b. Procedure. The inspection and tolerances for horizontal travel of the BC telescope and mount is prescribed in paragraphs 39, 40 and 41 and is performed as follows:

- (1) Place the BC telescope and mount on a leveled tripod M10 or M17 or surface plate adapter, and zero the scales.
- (2) Select, or erect, a target that is approximately coincidental with the center horizontal line of the telescope's reticle. Aline the horizontal reticle line with the target.
- (3) Loosen the lower spindle clamp (fig. 171) until the mount and telescope can be rotated on the spindle easily but without excessive play.
- (4) Using the azimuth mechanism of the mount, move the line of sight approximately 800 mils to the right or left.
- (5) Return the line of sight to the target, by turning the whole instrument on the spindle, and note whether the horizontal reticle line is above, below, or still in coincidence with the reference point (par. 39).
- (6) Continue this process in 800-mil steps in the same direction until the instrument has made a complete rotation. Note any errors in the four quadrants, as indi-

cated by the departure of the horizontal reticle line from the target. Higher echelons of maintenance follow the same procedure as described above, using the azimuth testing fixture (par. 18). The instrument, however, may be clamped solidly on the fixture spindle, since the spindle rotates by moving an index arm around a scale.

c. Backlash.

- (1) *Azimuth mechanism.* If the amount of backlash in any quadrant exceeds 1 mil, adjust as follows: to correct improper mesh between the azimuth worm and worm gear, increase the tension on the compression spring (KK, fig. 172) by tightening the slotted plug (JJ, fig. 172) located near the azimuth knob. Adjust for end play between the azimuth worm and the ball cap by tightening the ball cap located beneath the azimuth knob (fig. 187). Inspection may also indicate the need for replacement of worn parts. Burrs or irregularities in bearing surfaces may also introduce error requiring truing of these surfaces or the removal of burrs to correct the defect. General repair methods of worm and worm gear mechanisms are covered in paragraph 122 with specific assembly and disassembly instructions in pertinent paragraphs of chapter 11.
- (2) *Orienting mechanism.* Superimpose the center of the reticle on a vertical reference line or plumb line. While viewing the target through the telescope, move the orienting knob slightly and notice if the center of the reticle appears to move away from the reference line. If it does not move immediately, backlash is present. If backlash exists, eliminate as follows: increase the tension on the flat spring (L, fig. 172) or shim the plunger (H, fig. 172) located under the orienting housing cover. To adjust for end play between the orienting worm and ball cap, tighten the orienting worm ball cap (P, fig. 172) located under the orienting knob. Refer to the general repair methods in paragraph 122.

d. Lift.

- (1) *General.* Lift must not be confused with error in horizontal travel. Lift occurs in horizontal movements when there is excessive play between the housings of the driving and driven members.
- (2) *Inspection.* Lift is noted by sighting through the telescope and alternately operating the azimuth worm forward and backward through one or more turns. When

lift is present (par. 32d), the horizontal reticle line will, as the motion is reversed, jump up or down in relation to the reference point.

- (3) *Adjustment.* The correction for lift depends entirely upon the design of the instrument. It usually requires the refitting of the housing or adjacent parts (table V, par. 36).

e. Accuracy of Azimuth Readings.

- (1) *General.* The azimuth scales and micrometers must be checked for accuracy of the angular rotation in relation to the scale readings. If the azimuth and orienting mechanisms of the mount carrying the telescope starts from a point, and moves through any specific angle, the azimuth scale and micrometer must indicate this angle within the tolerances specified in paragraphs 39 and 40. A condition known as "circular error" exists if the azimuth scales and the angular rotation of the telescope are not in accord (par. 41). Circular error must not be confused with backlash, and inspection (2) below, therefore, must be performed with great care.

- (2) *Inspection.*

- (a) A "master" instrument, which is known to be accurate, must be set up on a tripod or azimuth testing fixture 41-F-2995 or 7691596 (figs. 25 and 27). Level this master instrument, zero its scales, and by use of the orienting mechanism or spindle clamp, bring the vertical cross-hair of the reticle on a clearly defined target. Using the azimuth mechanism, select targets from this point that are approximately 400 mils apart. Continue in successive 400-mil steps until the original aiming point is again reached. Record the points selected and their exact mil readings from the master instrument. Replace the master instrument with the instrument under test and observe whether the azimuth readings are within 2 mils, including backlash of those recorded.
- (b) The inspection and adjustments of *a* through *e*(2) (*a*) above are almost identical to that performed with the azimuth testing fixture when available in higher echelon shops. The mount and telescope or mount with a collimating telescope adapter (fig. 27) can be tested on either azimuth testing fixture 41-F-2995 or 7691596 (par. 18 and figs. 25 and 27) in an identical manner, using a single aiming point and rotating the

spindle on which the instrument is mounted a specific number of mils. With this inspection, a master instrument is not required. The azimuth fixture is calibrated in degrees; therefore, to set off 400 mils, the movable arm of the fixture must be turned $22^{\circ} 30'$. The inspection is completed by advancing the fixture $22^{\circ} 30'$ (400 mils) each time and returning the telescope to the aiming point using the azimuth worm mechanism. After each move, the micrometer and azimuth scale reading must be recorded until a complete rotation has been made. Level the fixture by means of the leveling screws. With the azimuth scale and micrometer of the mount set at zero, adjust the radial vernier arm of the fixture to "0" position on the scale and clamp it securely. Align the vertical reticle of the telescope with a suitable target point. Determine the circular or azimuth error by setting the vernier arm at a position equal to exactly 400 mils from "0," in a clockwise or counterclockwise direction. Return the reticle line to coincidence with the target point by rotating the azimuth mechanism of the mount. The reading of the azimuth scale and micrometer of the telescope should indicate 400 mils from "0." Continue displacing the vernier arm of the fixture by 400-mil steps, returning the reticle line to coincidence in each case, until "0" position is reached. The azimuth error noted at each position should not exceed that indicated in paragraphs 39, 40, and 41. Care must be exercised in these inspection methods to keep the movement of the azimuth worm mechanism turning in one direction only so that whatever backlash exists will not be confused with a circular error. This is done by approaching the aiming point slowly, and coming on the reference point without overshooting. Care must also be used in setting the azimuth testing fixture by using the micrometer adjustment on the moving arm (par. 18). Refer to paragraph 65b(11).

- (3) *Adjustment.* The correction for circular error is covered in paragraph 122h. However, when errors are considerable or numerous, replacement of parts is advisable.

f. Zero Scale Settings (par. 43).

- (1) *General.* In order that the instrument may function accurately, all scales must be set at zero in relation to the other optical and mechanical components. Azimuth scales and indexes are placed on the mount in such manner as

to have a permanent relationship with the rest of the instrument, that is, scales are mounted so that little or no adjustment is possible, and indexes are engraved. Thus, only the micrometer scale need be adjusted.

- (2) *Inspection.* To inspect scale settings, it is merely necessary to align zero, or any of the 100-mil graduations of the azimuth scale, with the index and to check the micrometer for zero.
- (3) *Adjustment.* A jewelers' eye loupe (part of kit 41-K-96) should be used here to aid in aligning the scale and index for either the inspection or adjustment of the micrometer scale. For assembly and disassembly instructions, refer to paragraphs 128e and 133c.

147. Plumb (Vertical) Travel

a. General. The elevation mechanism (fig. 10) rotates the BC telescope in a vertical plane. The full elevating movement is about 18° above to 18° below the horizontal line of sight. The elevation or vertical movement is of the worm and gear segment type (fig. 144). Since vertical movements are subject to the same deficiencies as horizontal movements, they must be inspected for backlash, error in vertical travel, accuracy of elevation readings, and in addition, for level line of site (par. 146).

b. Backlash in Angle of Site Mechanism. Set the angle of site scale at "3" and the micrometer at "0." Center the bubble of the angle of site level vial by rotating the elevating knob. Rotate the angle of site micrometer until the scale reads "0," and bring it back again until the level vial bubble is again centered. Do not overpass the point of level. Note the micrometer reading. Rotate the micrometer until the scale reads "6" and return to the level point. Again note the micrometer reading. The sum of the differences between the two readings is the amount of backlash. If the backlash exceeds 1 mil, increase the tension on the compression spring (CC, fig. 144) by loosening the setscrew which secures the slotted plug (DD, fig. 144) and tightening the plug. If the backlash results from end play in the worm, tighten the ball cap (L, fig. 144). Refer to paragraph 122 for further repair methods of worm and worm gear mechanisms and to paragraph 145 for resetting the angle of site micrometer scale.

c. Inspection. Prior to this inspection, the test in paragraph 145 should be performed. As indicated under ordnance shop inspection (par. 31q), the telescope should be mounted on the improvised collimating fixture (table III, par. 19) and adjustable

leveling plate. Perform the procedures presented in paragraph 143d through f using a plumb line as a target set up long enough to accommodate as much of the elevating movement as possible. Place the BC telescope close enough so that the plumb line is easily observed. A diaphragm placed over the right eyepiece or objective should be used since it will permit sharper focus and eliminate any parallax introduced by viewing the nearby plumb line. Aline a point on the reticle with the plumb line and operate the elevating mechanism to its high and low limits (*a* above), observing the point on the reticle as it follows the plumb line. A continually widening gap between the reticle point and the plumb line during operation of the mechanism indicates an error in vertical travel. "Shift" may also be noted during this inspection and should not be confused with vertical travel. "Shift" is similar to "lift" (par. 146d) in horizontal movements and is evident when the elevating mechanism is operated forward and backward, through one or more complete turns. Through the telescope, shift is seen as a sudden displacement between the reticle reference point and the plumb line when the movement is reversed. It may or may not be accompanied by an error in vertical travel. A micrometer scale reading against a line of sight and level vial determine the elevation readings (par. 145).

d. Accuracy of Elevation Readings. If the level line of site is correct (par. 145), the telescope must be checked at each point of elevation for proper scale readings. Shop inspection may be conducted by using the leveling fixture 41-F-2994 (fig. 24) (par. 17). Known angles of elevation or depression are set in the cross leveling fixture and the elevating mechanism of the telescope in a manner similar to the azimuth check described when using the azimuth testing fixture 41-F-2995 or 7691596 (figs. 25 and 27) (par. 146e(2)(b)). In using the cross leveling testing fixture, however, the elevation movement is displaced vertically in known angular steps, and the level vial bubble is centered to obtain the elevation error. For further information on the leveling fixture, refer to paragraphs 17 and 310. Check to see that the error of any angle of site reading, including backlash ((b) above), does not exceed 2 mils.

e. Adjustment. Adjustment for improper elevation readings are very similar to that for circular error (par. 146). Elevation errors may indicate irregular tooth spacing on the gear segment, in which case the section of the segment causing the error should be processed as indicated in paragraph 122h.

f. Extent and Backlash of Elevating Movement. See that the elevation mechanism has full 700-mil movement. Place the angle of site scale at "0" and the micrometer at "0." See if the bubble

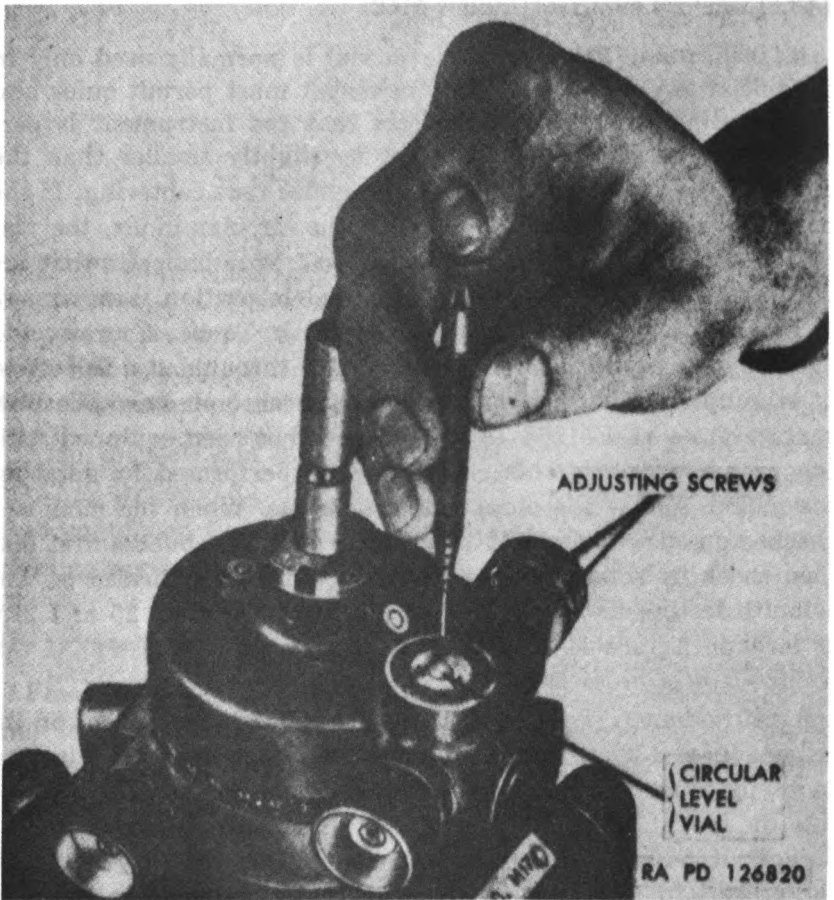

Figure 197. Adjusting circular level vial.

can be centered by rotating the elevating knob. Repeat this procedure with the angle of site scale of "6" and the micrometer at "0." If the bubble cannot be centered by rotating the elevating knob when the angle of site scale is set at "0" or "6" and the micrometer at "0," inspect and replace the elevating worm gear if unserviceable. If full movement is still not attained, check the position of the stop rings and see that they are in proper relationship to each other (par. 132*n*). If this fails to loosen the movement, lap the elevating worm and worm gear together (par. 122). The high spots on the extremities of the worm gear must be worn down to match the wear in the center of the worm gear. This should result in a smooth movement over the full 700 mils. Backlash in elevation is corrected in the same manner as for backlash in the angle of site mechanism ((*b*) above). Refer to table V (par. 36).

148. Circular Level Vial (Mount M48)

a. Inspection. The circular level vial is normally used only in the initial leveling of the instrument, but must permit quick and easy readings to establish the fact that the instrument is perfectly horizontal. The bubble must be slightly smaller than the circular index in order to quickly recognize true centering. If the bubble is as large as or larger than the circular index, the vial must be replaced. If initial inspection (par. 32a) indicates that the vial meets the above inspections, a final inspection is necessary to determine the accuracy of the reading. To be accurate, the bubble must stay within the circular index throughout a full circle of azimuth rotation. The mount may be checked on a cross-leveled surface plate 41-P-1565 (fig. 16) which has been equipped with the proper adapter. This check may be performed by rotating the mount 360° while observing the bubble. When the mount is checked on either tripod M10 or M17, center the bubble first and then check by rotation. This test may also be performed on the azimuth testing fixture 41-F-2995 or 7691596 (figs. 25 and 27) or leveling fixture 41-F-2994 (fig. 24) (table II, par. 11) if the fixture is first cross leveled.

b. Adjustment. To adjust the level vial with the mount on its tripod (par. 133h), first center the bubble within the circular index by adjusting the ball and socket type mounting. Then rotate the mount 180°. Remove half of any existing error by tightening and loosening alternate level vial jackscrews (fig. 197) and the other half by adjusting the ball and socket mechanism (fig. 171). Repeat this procedure until the bubble stays within the circular index during a complete rotation of the mount.

149. Adjustment of Tripod M17

If the tripod head assembly fails to support the leg in a horizontal position, back off the safety nut (fig. 198) and, using the clamping lever as a wrench, rotate the clamping screw until the head assembly will support the weight of the leg. Tighten the safety nut.

CHAPTER 12

FINAL INSPECTION

Section I. INSPECTION OF BINOCULARS

150. General

Final inspection of the binoculars M3, M7, M8, M9, M13, M13A1 M15A1, and M17A1 is performed after repair and rebuild has been completed to insure that the binoculars are serviceable according to established inspection standards.

151. Procedure

Final inspection for the binoculars to be returned to the user and to stock is completely covered by the technical inspection and serviceability standards and procedures given in chapter 3.

Note. Where tolerances are specified in these inspections, ordnance maintenance shops, during the course of repair and rebuild, should utilize these tolerances to the fullest extent only when an excessive amount of work would be required to maintain more accurate readings or settings.

Section II. INSPECTION OF BC TELESCOPE M65 AND TELESCOPE MOUNT M48

152. General

Final inspection of BC telescope M65, telescope mount M48, and equipment is performed after repair and rebuild has been completed to insure that the matériel is serviceable according to established inspection standards.

153. Procedure

Final inspection of the BC telescope and telescope mount to be returned to the user and to stock is completely covered by

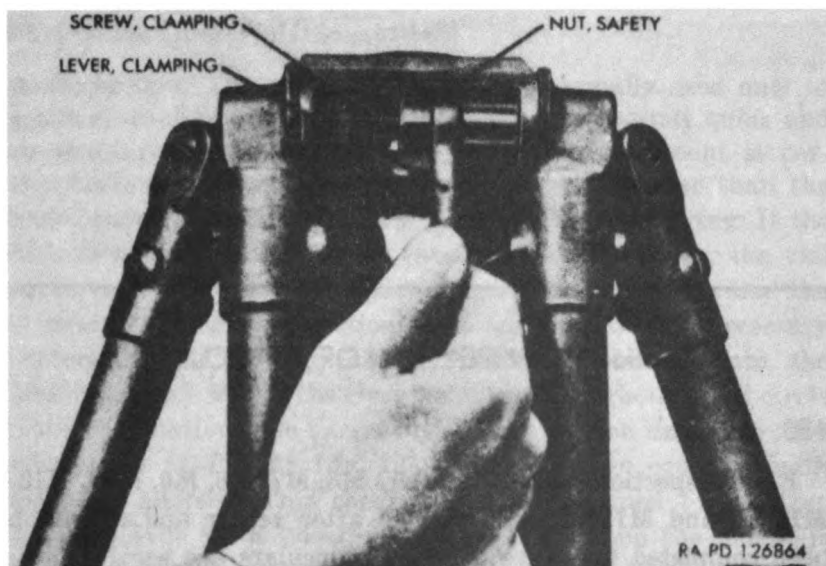

Figure 198. Tightening tripod head clamping screw.

the technical inspection and serviceability standards and procedures given in chapter 3.

Note. Where tolerances are specified in these inspections, ordnance maintenance shops, during the course of repair and rebuild, should utilize these tolerances to the fullest extent only when an excessive amount of work would be required to maintain more accurate readings or settings.

APPENDIX

REFERENCES

1. Publication Indexes

Special Regulations in the 310-20 series, SR 110-1-1, ORD 1, FM 21-8, and SB 9-1 should be consulted frequently for latest changes or revisions of references given in this appendix and for new publications relating to matériel covered in this manual.

2. Supply Catalogs

The following Department of the Army Supply Catalogs pertain to this matériel:

a. Destruction to Prevent Enemy Use.

Land Mines and Components; Demolition Explosives and Related Items; and Ammunition for Simulated Artillery, Booby Trap, Hand Grenade, and Land Mine Fire ORD 3 SNL R-7

b. Repair and Rebuild.

Chains, Locks, Hasps, and Hinges ORD 5 SNL H-8

Cleaners, Preservatives, Lubricants, Recoil Fluids, Special Oils, and Related Maintenance Materials ORD 3 SNL K-1

Common Tools and Equipment (except Machine Tools) ORD 3 SNL J-17

Fire Control Major Items and Major Combinations for Use With Antiaircraft, Harbor Defense, and Railway Artillery ORD 3 SNL F-2

Fire Control Major Items and Major Combinations for Use With Small Arms, Automatic Guns, Trench Mortars, and Field Artillery ORD 3 SNL F-1

Items of Soldering, Metalizing, Brazing, and Welding Materials; Gases and Related Items ORD 3 SNL K-2

Lubricating Equipment, Accessories, and Related Dispensers	ORD 5 SNL K-3
Lubricating Fittings, Oil Filters, and Oil Filter Elements	ORD 5 SNL H-16
Machine Tools and Related Equipment....	ORD 3 SNL J-1
Miscellaneous Hardware.....	ORD 5 SNL H-2
Standard Hardware.....	ORD 5 SNL H-1
Straps, Leather Findings, and Piece Leather	ORD 5 SNL H-3
Tool Set, Fire Control Repairman	ORD 6 SNL J-10, Sec 13
Tool Set, Instrument Repairman (MOS 3922)	ORD 6 SNL J-10, Sec 14
Tool Sets for Maintenance of Sighting and Fire Control Equipment	ORD 6 SNL F-272
Truck, 2½-Ton, 6x6, Instrument Repair, Load A, M10; Load B, M10; Load A, M10A1; Load B, M10A1.....	ORD 7 SNL G-141, Vol 1
<i>c. Sighting and Fire Control Equipment.</i>	
Binocular, M3, M8, M9, M13, M13A1.....	ORD (*) F-210
Binocular, M7, M15, M15A1, M16, M17, M17A1, MK21, MK21A1.....	ORD (*) F-238
Telescope, BC, M65.....	ORD (*) F-259

3. Forms

The following forms pertain to this matériel:

WD AGO Form 9-71, Locator and Inventory Control Card
 WD AGO Form 9-72, Ordnance Stock Record Card
 DAForm 9-76, Request for Work Order
 WD Form 9-77, Job Order Register
 WD AGO Form 9-78, Job Order
 DAForm 9-79, Parts Requisition
 WD AGO Form 9-80, Job Order File
 WD AGO Form 9-81, Exchange Part or Unit Identification Tag
 DAForm 446, Property Issue Slip
 DAForm 447, Property Turn-in Slip
 DAForm 468, Unsatisfactory Equipment Report
 DAForm 811, Work Request and Job Order
 DAForm 811-1, Work Request and Hand Receipt
 DAForm 828, Job Time Ticket — Individual
 WD AGO Form 829, Rejection Memorandum
 WD AGO Form 865, Work Order
 WD AGO Form 866, Consolidation of Parts

(*) See ORD 1, Introduction and Index for published catalogs of the ordnance section of the Department of the Army Supply Catalog.

WD AGO Form 867, Status of Modification Work Order
DD Form 6, Report of Damaged or Improper Shipment

4. Other Publications

The following explanatory publications contain information pertinent to this matériel and associated equipment:

- a. Camouflage.*
Camouflage, Basic Principles FM 5-20
- b. Decontamination.*
Decontamination TM 3-220
Defense Against Chemical Attack..... FM 21-40
- c. Destruction to Prevent Enemy Use.*
Explosives and Demolitions FM 5-25
Ordnance Service in the Field FM 9-5
- d. General.*
Auxiliary Sighting and Fire Control Equipment TM 9-575
Inspection of Ordnance Matériel in the hands of
Troops TM 9-1100
Reports of Accident Experience..... SR 385-10-40
Artillery Matériel and Associated Equipment... TM 9-2300
Supplies and Equipment: Unsatisfactory
Equipment Report SR 700-45-5
- e. Repair and Rebuild.*
Abrasive, Cleaning, Preserving, Sealing, Adhesive, and
Related Materials Issued for Ordnance Matériel TM 9-850
Alteration of Leveling Fixture 41-F-2994 (D23553)
to Accommodate Test Adapters for Inspection of
Fire Control Instruments TB ORD 373
Black Finishing Equipment for Ferrous Metals TM 9-1861
Cold Weather Lubrication: Operation and Maintenance of Artillery and Sighting and Fire Control
Matériel TB ORD 193
Electrical Testing Apparatus for Fire Control
Equipment TM 9-1672
Fire Control Matériel: Lubrication..... TB 9-2835-1
Hand, Measuring, and Power Tools..... TM 10-590
Instruction Guide: Elementary Optics and Applications to Fire Control Instruments..... TM 9-2601
Instruction Guide: Instrument Repairman..... TM 9-2602
Lubrication TM 9-2835
Maintenance and Care of Hand Tools..... TM 9-867
Modification of Ordnance Matériel..... SB 9-38
Operation and Maintenance of Optical Coating
Equipment TM 9-1501

Ordnance Maintenance and General Supply in the Field	FM 9-10
Painting Instructions for Field Use.....	TM 9-2851
<i>Shipment and Stand-by or Long-Term Storage.</i>	
Army Shipping Document.....	TM 38-705
Instruction Guide: Ordnance Packaging and Shipping (Posts, Camps, and Stations).....	TM 9-2854
Marking and Packing of Supplies and Equipment:	
Marking of Oversea Supply.....	SR 746-30-5
Ordnance Storage and Shipment Chart — Group F	SB 9-OSSC-F
Processing of Motor Vehicles and Related Unboxed Matériel for Shipment and Storage.....	SB 9-4
Preservation, Packaging, and Packing of Military Supplies and Equipment.....	TM 38-230
Protection of Ordnance General Supplies in Open Storage	TB ORD 379
Shipment of Supplies and Equipment: Report of Damaged and Improper Shipment.....	SR 745-45-5
Standards for Oversea Shipments and Domestic Issue of Ordnance Matériel Other than Ammunition and Army Aircraft.....	TB ORD 385

INDEX

	<i>Paragraphs</i>	<i>Page</i>
Accidents, field report.....	3	2
Adapter, tripod M10.....	27g	60
Adapters, leveling fixture.....	17c	40
Adjustable leveling plate.....	16	39
Allocation of maintenance.....	2	1
Angle of site:		
Error.....	31l, m	69
Level.....	31o, 145	70, 258
Mechanism, backlash.....	27h, 147b	60, 263
Worm:		
Installation.....	132o	240
Removal.....	127k	201
Assembly:		
BC telescope.....	132	235
Binoculars:		
M3.....	58	105
M7 and M16.....	69	132
M8.....	80	141
M9.....	91	145
M13 and M13A1.....	102	154
M15, M15A1, M17, and M17A1.....	113	174
Asimuth and orienting mechanism travel.....	146	259
Asimuth:		
Readings (horizontal travel).....	146e	261
Testing fixtures.....	18	41
Backlash:		
Angle of site mechanism.....	27h, 147f	60, 264
Elevating mechanism.....	27h, 147f	60, 264
Horizontal travel (telescope).....	146c	260
Worm and worm gear.....	122i	184
Ball, worm shaft.....	122c,d	180
Binocular:		
Testing fixture.....	14	32
Vibration tester (<i>See</i> Vibration tester)		
Body assembly:		
Assembly:		
M3.....	58a	105
M7 and M16.....	69a	132
M8.....	80a	141
M9.....	91a	145
M13 and M13A1.....	102a	154
M15, M15A1, M17, and M17A1.....	113a	174
Disassembly:		
M3.....	56e	99
M7 and M16.....	68e	127

	<i>Paragraphs</i>	<i>Page</i>
Body assembly—Continued		
M8.....	69e	133
M9.....	90e	143
M13 and M13A1.....	101e	153
M15, M15A1, M17, and M17A1.....	112g	168
Body cover:		
Installation:		
M3.....	58f	106
M7 and M16.....	69f	133
M8.....	80f	141
M9.....	91f	146
Removal:		
M3.....	56a	96
M7 and M16.....	68a	124
M8.....	79a	135
M9.....	90a	143
Body cover w/eyepiece assemblies:		
Assembly:		
M15 and M17 w/filters.....	113f	175
M17 w/o filters.....	113g	176
M15A1 and M17A1.....	113h	176
Disassembly:		
M15.....	112h	168
M15A1, M17, and M17A1.....	112i	169
Installation (M15, M15A1, M17, and M17A1)	113i	176
Removal (M15, M15A1, M17, and M17A1)	112b	161
Burrs, removal	48	90
Carrying cases:		
Maintenance	53	96
Rebuild:		
M3.....	57c,d	104
M7 and M16.....	68h	132
Cementing	51c	92
Chatter (worm and worm gear)	122f	182
Chest, packing (<i>See</i> Packing chest M39)		
Circular error (worm and worm gear)	122h	183
Circular level	32a	71
Circular level vial (telescope mount)	148	266
Classification of matériel (inspection)	23	53
Cleaning	46	87
Clicking (worm and worm gear)	122k	188
Collimating telescope	15	39
Collimation:		
Adjustments (BC telescope)	31g	69
BC telescope	143	252
Binoculars:		
M3.....	65	114
M7 and M16.....	76	134
M8.....	87	142
M9.....	98	149
M13, and M13A1.....	109	160
M15, M15A1, M17, and M17A1.....	120	177
Check	30d	64
Differences among binoculars	6	16

	<i>Paragraphs</i>	<i>Page</i>
Diopter setting:		
BC telescope.....	139	251
Binoculars:		
M3.....	59	107
M7 and M16.....	70	134
M8.....	81	141
M9.....	92	146
M13 and M13A1.....	103	156
M15, M15A1, M17, and M17A1.....	114	176
Proper setting.....	30c	64
Disassembly:		
BC telescope.....	127	195
Binoculars:		
M3.....	56	96
M7 and M16.....	68	124
M8.....	79	135
M9.....	90	143
M13 and M13A1.....	101	150
M15, M15A1, M17, and M17A1.....	112	161
Double vision:		
BC telescope.....	28e	62
Binoculars.....	26g	57
Elevating mechanism:		
Inspection.....	31p	70
Vertical travel.....	147	263
Elevating worm (telescope):		
Installation.....	132n	239
Removal.....	127j	201
End play (worm and worm gear).....	122i	184
Equipment (See also Tools and equipment):		
Inspection, technical.....	25l	55
Ordnance shop inspection.....	32	71
Rebuild:		
Binoculars:		
M3.....	57	104
M7 and M16.....	68A	132
M13 and M13A1.....	101A	154
M15, M15A1, M17, and M17A1.....	112k	172
Unsatisfactory (report).....	3	2
Erecting prism holder (See Prism holders)		
Eye guard, removal (M15, M15A1, M17, and M17A1).....	112a	161
Eyepiece assemblies (See also Body cover w/eyepiece assemblies):		
Assembly:		
BC telescope.....	132d	236
Binoculars:		
M3.....	58g	107
M7 and M16.....	69g	133
M8.....	80g	141
M9.....	91g	146
M13 and M13A1.....	102f	155
Disassembly:		
BC telescope.....	127u	219
Binoculars:		
M3.....	56f	101

	<i>Paragraphs</i>	<i>Page</i>
Eyepiece assemblies (See also Body cover w/eyepiece assemblies):—Cont.		
M7 and M16.....	68f	127
M8.....	69f	133
M9.....	90f	143
M13 and M13A1.....	101f	154
Eyepiece movement:		
M3.....	61	110
M7 and M16.....	72	134
M8.....	83	142
M9.....	94	147
M13 and M13A1.....	105	160
M15, M15A1, M17, and M17A1.....	116	177
Installation:		
BC telescope.....	132q	240
Binoculars:		
M3.....	58g	107
M7 and M16.....	69g	133
M8.....	80g	141
M9.....	91g	146
M13 and M13A1.....	102g	156
Removal:		
BC telescope.....	127f,g	196
Binocular:		
M3.....	56a	96
M7 and M16.....	68a	124
M8.....	79a	135
M9.....	90a	143
M13 and M13A1.....	101a	150
Field of view:		
Definition:		
BC telescope.....	139	251
Binocular:		
M3.....	59	107
M7 and M16.....	70	134
M8.....	81	141
M9.....	92	146
M13 and M13A1.....	103	156
M15, M15A1, M17, and M17A1.....	114	176
Inspection.....	26c, 30c	57, 64
Tilt:		
BC telescope.....	140	252
Binoculars:		
M3.....	60	107
M7 and M16.....	71	134
M8.....	82	142
M9.....	93	147
M13 and M13A1.....	104	156
M15, M15A1, M17, and M17A1.....	115	176
General.....	26c	57
Filter M1:		
Inspection.....	30q	67
Modification work order.....	6c, 25g	17, 55
Filter holder adapter assemblies, removal (M15, M15A1, M17, and M17A1).....	112a	161

	<i>Paragraphs</i>	<i>Page</i>
older assembly:		
assembly.....	132 <i>f,l</i>	237, 238
Disassembly.....	127 <i>s</i>	217
Fixtures (<i>See</i> Azimuth testing fixtures <i>and</i> Binocular testing fixtures)		
Forms, records, and reports.....	3	2
Functional description:		
BC telescope.....	5 <i>b</i>	16
Binoculars.....	5 <i>a</i>	16
Fungus proofing telescope.....	137	246
Gypsum, calcined.....	123 <i>b</i>	190
Head assembly (telescope):		
Assembly.....	132 <i>i,j,k</i>	237, 238
Disassembly.....	127 <i>n,o,p</i>	206, 207
Installation.....	132 <i>c</i>	236
Removal.....	127 <i>c</i>	195
Horizontal travel (<i>See</i> Travel)		
Housing support bracket (left) (telescope):		
Installation.....	132 <i>t</i>	241
Removal.....	127 <i>e</i>	196
Housing w/filter holder assembly (telescope):		
Assembly.....	132 <i>l</i>	238
Disassembly.....	127 <i>m</i>	204
Images, tilt.....	31 <i>d</i>	67
In-process inspection.....	22 <i>c</i>	53
Inspection (<i>See also</i> Final inspection <i>and</i> Preliminary inspection):		
BC telescope:		
Mechanical components.....	27	58
Optical components.....	28	62
Ordnance shop.....	31	67
Binoculars:		
Mechanical components.....	25	54
Optical components.....	26	56
Ordnance shop.....	30	63
Categories of technical.....	22	52
Classification of Matériel:		
Serviceable.....	23 <i>a</i>	53
Unserviceable.....	23 <i>b</i>	53
Pre-embarkation.....	33, 34	72
Purposes.....	21	52
Record forms.....	3	2
Technical:		
In ordnance shop.....	29-32	63
Matériel in the hands of troops.....	24-28	54
Telescope mount M48.....	32	71
Tripods.....	32	71
Instrument light:		
Assembly.....	135	245
Disassembly.....	130	234
Inspection.....	27 <i>i</i>	61
Installation.....	135	245
Removal.....	127 <i>a</i>	195
Instrument repair kit.....	38 <i>b</i>	80

	<i>Paragraphs</i>	<i>Page</i>
Interpupillary scale setting:		
BC telescope.....	142	252
Binoculars:		
M3.....	63	112
M7 and M16.....	74	134
M8.....	85	142
M9.....	96	147
M13 and M13A1.....	107	160
M15, M15A1, M17, and M17A1.....	118	177
Ordnance shop inspection:		
BC telescope.....	31 <i>k</i>	69
Binoculars.....	30 <i>j</i>	65
Technical inspection:		
BC telescope.....	27 <i>h</i>	60
Binoculars.....	26 <i>a</i>	58
Interpupillary screw assembly:		
Assembly.....	132 <i>b</i>	236
Disassembly.....	127 <i>w</i>	221
Lapping mating parts.....	49	90
Latch assembly (telescope):		
Assembly.....	132 <i>m</i>	239
Disassembly.....	127 <i>l</i>	201
Installation.....	132 <i>m</i>	239
Removal.....	127 <i>l</i>	201
Lenses:		
Installation.....	50	90
Marking.....	40 <i>b</i>	82
Removal from cells.....	43	86
Sealing.....	51 <i>c</i>	92
Level vial, circular.....	148	266
Level vial holder assembly (telescope):		
Assembly.....	132 <i>a,m</i>	235, 239
Disassembly.....	127 <i>z</i>	222
Installation.....	132 <i>m</i>	239
Removal.....	127 <i>l</i>	201
Level vials, tubular (See Tubular level vials)		
Leveling fixture, description.....	17	39
Leveling plate (See Adjustable leveling plate)		
Lift.....	32 <i>d</i> , 146 <i>d</i>	71, 280
Lubrication.....	47	89
Maintenance:		
Allocation.....	2	1
BC telescope and telescope mount:		
General.....	121-124	178
Organisational.....	125	192
Binocular M3:		
General.....	37-53	80
Organisational.....	54	96
Marking:		
Metal components.....	39	81
Optical elements.....	40	82
Metal:		
Components, marking.....	39	81
Parts, cleaning.....	46 <i>a</i>	87

	<i>Paragraphs</i>	<i>Page</i>
Binoculars M15A1 and M17A1.....	110	161
To accommodate filter M1.....	6c, 25g	17, 55
To prevent rotation of objective assembly.....	6c, 25g	17, 55
Negligence, report.....	3	2
Objective assembly:		
Assembly:		
BC telescope.....	132g	237
Binoculars:		
M3.....	58d	107
M7 and M16.....	69d	133
M8.....	80d	141
M9.....	91d	145
M13 and M13A1.....	102d	154
M15, M15A1, M17, and M17A1.....	113d	174
Disassembly:		
BC telescope.....	127r	212
Binoculars:		
M3.....	56d	98
M7 and M16.....	68d	124
M8.....	79d	135
M9.....	90d	143
M13 and M13A1.....	101d	150
M15, M15A1, M17, and M17A1.....	112e	168
Installation:		
BC telescope.....	132s	241
Binoculars:		
M3.....	58d	106
M7 and M16.....	69d	133
M8.....	80d	141
M9.....	91d	145
M13 and M13A1.....	102d	154
M15, M15A1, M17, and M17A1.....	113d	174
Removal:		
BC telescope.....	127d	195
Binoculars:		
M3.....	56d	98
M7 and M16.....	68d	124
M8.....	79d	135
M9.....	90d	143
M13 and M13A1.....	101d	150
M15, M15A1, M17, and M17A1.....	112e	168
Optical elements:		
Cementing.....	30l, 44	66, 86
Cleaning.....	46b	87
Coated.....	30m	66
Coating.....	45	86
Inspection:		
BC telescope.....	28a,b	62
Binoculars.....	26a	56
Installing.....	50	90
Marking.....	40	82
Orienting mechanism.....	146	259
Over-all inspection.....	22a	52

	<i>Paragraphs</i>	
Packing chest M39:		
Assembly	136	246
Disassembly	131	235
Painting, touch up	52	93
Parallax:		
BC telescope.....	23d, 31f, 139	62, 69, 251
Binoculars:		
M3.....	61	110
M7 and M16.....	72	134
M8.....	83	142
M9.....	94	147
M13 and M13A1.....	105	160
M15, M15A1, M17, and M17A1.....	116	177
Inspection	26d, 30e	57, 65
Parts:		
Handling of disassembled.....	38	80
Inspection of spare parts.....	25f	55
Lapping mating parts together.....	49	90
Requisitioning.....	9	20
Sealing metal-to-metal parts.....	51c	92
Parts tray and boxes	38	80
Plate:		
Adjustable leveling.....	16	39
Surface (<i>See</i> Surface plate)		
Plumb (vertical) travel	28i, 31g, 147	63, 70, 263
Pre-embarkation inspection	22b, 33, 34	53, 72
Preliminary inspection:		
BC telescope and telescope mount.....	126	193
Binocular:		
M3.....	55	96
M7 and M16.....	67	124
M8.....	78	135
M9.....	89	143
M13 and M13A1.....	100	150
M15, M15A1, M17, and M17A1.....	111	161
Prism holder assemblies:		
Assembly:		
90-degree prism.....	132A	237
Erecting prism.....	132c	236
Disassembly:		
90-degree prism.....	127g	210
Erecting prism.....	127v	221
Installation (erecting prism)	132r	241
Removal (erecting prism)	127A,i	201
Prism shelf assemblies (binoculars):		
Assembly:		
M3.....	58b	106
M7 and M16.....	60b	132
M8.....	80b	141
M9.....	91b	145
M13 and M13A1.....	102b	154
M15, M15A1, M17, and M17A1.....	113b	174
Disassembly:		
M3.....	56A	109

Prism shelf assemblies (binoculars)—Continued	<i>Paragraphs</i>	<i>Page</i>
Disassembly—Continued		
M7 and M16.....	68g	129
M8.....	79g	141
M9.....	90g	143
M13 and M13A1.....	101g	154
M15, M15A1, M17, and M17A1.....	112j	172
Installation:		
M3.....	58c	106
M7 and M16.....	69c	133
M8.....	80c	141
M9.....	91c	145
M13 and M13A1.....	102c	154
M15, M15A1, M17, and M17A1.....	113c	174
Removal:		
M3.....	56c	97
M7 and M16.....	68c	124
M8.....	79b	135
M9.....	90c	143
M13 and M13A1.....	101c	150
M15, M15A1, M17, and M17A1.....	112d	168
Prisms:		
Description.....	4	3
Marking.....	40c	82
<i>(See also Prism holder assemblies and Prism shelf assemblies)</i>		
Rebuild:		
BC telescope and telescope mount.....	125-137	192
Binoculars:		
M3.....	54-58	96
M7 and M16.....	66-69	124
M8.....	77-80	135
M9.....	88-91	143
M13 and M13A1.....	99-102	150
M15, M15A1, M17, and M17A1.....	110-113	161
Records and reports.....	3	2
Retaining rings and cells:		
Installation.....	50	90
Removal.....	42	84
Reticle assembly:		
Assembly:		
BC telescope.....	132e	237
Binoculars:		
M3.....	58c	106
M8.....	80e	141
M13 and M13A1.....	102e	155
M16.....	69e	133
M17 and M17A1.....	113e	174
Disassembly:		
BC telescope.....	127t	217
Binoculars:		
M3.....	56g	103
M13 and M13A1.....	79b	135
M16.....	68b	124
M17 and M17A1.....	112c	161

Reticle Assembly—Continued	Paragraphs	Page
Installation:		
BC telescope.....	132 <i>p</i>	240
Binoculars:		
M3.....	58 <i>e</i>	106
M8.....	80 <i>e</i>	141
M9.....	91 <i>e</i>	145
M13 and M13A1.....	102 <i>e</i>	155
M16.....	69 <i>e</i>	133
M17 and M17A1.....	113 <i>e</i>	174
Removal:		
BC telescope.....	127 <i>g</i>	196
Binoculars:		
M3.....	56 <i>b</i>	97
M8.....	79 <i>b</i>	135
M9.....	90 <i>b</i>	143
M13 and M13A1.....	101 <i>b</i>	150
M16.....	68 <i>b</i>	124
M17 and M17A1.....	112 <i>c</i>	161
Reticle tilt:		
BC telescope.....	144	257
Binoculars:		
M3.....	64	112
M8.....	86	142
M9.....	97	147
M13 and M13A1.....	106	160
M16.....	75	134
M15, M15A1, M17, and M17A1.....	119	177
Inspection in hands of troops.....	26 <i>f</i>	57
Ordnance shop inspection.....	31 <i>e</i>	69
Scale setting, interpupillary (<i>See</i> Interpupillary scale setting)		
Scale settings, zero.....	146 <i>f</i>	262
Screws (<i>See also</i> Interpupillary screw assembly):		
Damaged setscrews.....	41	83
Sealing and cementing.....	51 <i>c</i>	92
Sealing lenses and screws.....	51 <i>c</i>	92
Setscrews, damaged.....	41	83
Spot check inspection.....	22 <i>e</i>	53
Stagger:		
BC telescope.....	141	252
Binoculars:		
M3.....	62	111
M7 and M16.....	73	134
M8.....	84	142
M9.....	95	147
M13 and M13A1.....	106	160
M15, M15A1, M17, and M17A1.....	117	177
Strap assemblies (neck and shoulder), rebuild:		
M3.....	57 <i>a,b</i>	104
M7 and M16.....	68 <i>a</i>	132
Surface plate.....	16	39
Table I — Tabulated data.....	7	18
Table II — Special tools and equipment for field and depot maintenance.....	11	20
Table III — Improvised tools for field and depot maintenance..	19	44

	<i>Paragraphs</i>	
Table IV — Trouble shooting — binoculars	36	,
Table V — Trouble shooting — BC telescope M65 and equipment	36	74
Tabulated data (table I)	7	18
Technical inspection (<i>See Inspection</i>)		
Telescope, collimating (<i>See Collimating telescope</i>)		
Telescope latch (<i>See Latch assembly</i>)		
Telescope mount:		
Assembly	133	244
Disassembly	128	226
Inspection	27e	59
Maintenance:		
General	121-124	178
Organisational	125	192
Ordnance shop inspection	32	74
Removal of telescope from mount	127b	195
Telescope windows:		
Assembly	132j	238
Disassembly	127o	207
Installation	132k	238
Removal	127m	204
Sealing	124	192
Tester, vibration (<i>See Vibration testers</i>)		
Testing fixtures (<i>See Azimuth testing fixtures and Binocular testing fixture</i>)		
Tests and adjustment:		
BC telescope and telescope mount	138-149	251
Binocular:		
M3	59-65	107
M7 and M16	70-76	134
M8	81-87	141
M9	92-98	146
M13 and M13A1	103-109	156
M15, M15A1, M17, and M17A1	114-120	176
Tilt:		
Field of view:		
BC telescope	140	252
Binoculars:		
M3	60	107
M7 and M16	71	134
M8	82	142
M9	93	147
M13 and M13A1	104	156
M15, M15A1, M17, and M17A1	115	176
General	26e	57
Image:		
BC telescope	31d	67
Binoculars	30f	65
Reticle:		
BC telescope	28f, 31e, 144	62, 69, 257
Binoculars:		
M3	64	112
M8	86	142
M9	97	147
M13 and M13A1	108	160

	<i>Paragraphs</i>	<i>Page</i>
Tilt—Continued		
Reticle—Continued		
Binoculars—Continued		
M16.....	75	134
M15, M15A1, M17, and M17A1.....	119	177
General.....	26f	57
Tools and equipment:		
Common.....	10	20
Improvised (table III).....	19	44
Special (table II).....	11	20
Touch-up painting.....	52	93
Travel:		
Horizontal.....	28A, 32c	63, 71
Horizontal or azimuth and orienting mechanism.....	146	259
Plumb (vertical).....	28i, 147	63, 263
Tripod M17:		
Adjustment.....	149	266
Assembly.....	134	245
Disassembly.....	129	230
Installation of mount.....	133A	245
Removal of mount.....	128a	226
Tripods:		
Ordnance shop inspection.....	32	71
Technical inspection.....	27f,g	60
Tubes (telescope):		
Installation.....	132t	241
Removal.....	127d	196
Tubular level vials, removal and installation.....	123	190
Universal vibration tester (<i>See</i> Vibration tester)		
Unsatisfactory equipment or material (report).....	3	2
Vertical travel (<i>See</i> Travel)		
Vibration testers:		
Description:		
Binocular.....	13	27
Universal (BC telescope).....	12	27
Test (binoculars).....	30a	63
Vision, double (<i>See</i> Double vision)		
Windows, telescope (<i>See</i> Telescope windows)		
Worm:		
Angle of site (<i>See</i> Angle of site worm)		
Elevating (<i>See</i> Elevating worm)		
Worm gear mechanism.....	122	178
Shaft.....	122b	179
Zero scale settings (horizontal travel).....	146f	262





