

TM 11-4871

DEPARTMENT OF THE ARMY TECHNICAL MANUAL

U. S. DOCUMENT
RECEIVED

OCT 28 1952

MICHIGAN STATE LIBRARY

DIRECTORY OF SIGNAL CORPS
EQUIPMENTS

SOUND AND LIGHT
AND MISCELLANEOUS
EQUIPMENT



3 0000 010 449 357

LIBRARY OF MICHIGAN

DEPARTMENT OF THE ARMY

APRIL 1951

Digitized by Google

DEPARTMENT OF THE ARMY
WASHINGTON 25, D. C., 12 April 1951

TM 11-487 I, is published for the information and guidance of all concerned.
[AG 413.44 (7 Dec 50)]

BY ORDER OF THE SECRETARY OF THE ARMY:

OFFICIAL:

EDWARD F. WITSELL
Major General, USA
The Adjutant General

J. LAWTON COLLINS
Chief of Staff, United States Army

DISTRIBUTION:

Tech Svc (1) except 11 (50); Arm & Svc Bd (1); AFF Bd (1) ea Svc Test Sec (1); AFF (5); AA Comd (5); OS Maj Comd (5); Base Comd (2); MDW (2); A (20); CHQ (2); FC (2); Sch (3) except 11 (10); Dep 11 (10); Tng Ctr (1); PE (5), OSD (2); Lab 11 (2); 4th & 5th Ech Maint Shops 11 (2); Two copies to each of the following T/O&E's: 5-512T; 6-77; 11-39; 11-500 IO, IS, IT, IU, IV; 30-600 AL; SPECIAL DISTRIBUTION.

For explanation of distribution formula see SR 310-90-1.

FOREWORD

This is the ninth of a series of nine manuals, each covering the standard, substitute standard, and limited standard Signal Corps equipments in a particular field. This manual covers sound and light and miscellaneous equipment which includes the following classes of equipment:

1. Code training and practice equipment.
2. Flash ranging equipment.
3. Intercommunication equipment.
4. Operations centers.
5. Public address equipment.
6. Pigeon equipment.
7. Sound ranging equipment.
8. Sound recording and reproducing equipment.
9. Tool equipment.
10. Visual signaling equipment.
11. Material not otherwise classified.

The nine manuals cover, respectively, radio communication equipment, wire communication equipment, ground radar and recognition equipment, radio direction finding equipment, power equipment, photographic equipment, meteorological equipment, and test equipment.

The principal items of sound and light and miscellaneous equipment are covered by nomenclature type numbers in alphabetical and numerical sequence. An illustration and the following applicable information are given for each item of equipment.

Nomenclature	Application
Status	Technical characteristics
Signal Corps stock number	Principal components
Technical literature	Weights and dimensions
Description	

The nomenclature type names of all of the equipments are listed alphabetically in the index at the back of the manual, and the nomenclature type numbers are listed alphabetically in the table of contents at the front of the manual.

The following abbreviations are used in this manual:

ac.....	alternating current	hr.....	hour
amp.....	ampere	in.....	inch
amp-hr.....	ampere-hour	max.....	maximum
am.....	amplitude modulation	mi.....	mile
af.....	audio frequency	mm.....	millimeter
avc.....	automatic volume control	mw.....	milliwatt
cu ft.....	cubic feet	min.....	minimum
cps.....	cycles per second	oz.....	ounce
cw.....	continuous wave	lb.....	pound
db.....	decibels	rms.....	root mean square
diam.....	diameter	v.....	volt
dc.....	direct current	vu.....	volume unit
ea.....	each	w.....	watt
fm.....	frequency modulation	wpm.....	words per minute
hp.....	horsepower	yd.....	yard

CONTENTS

	Page		Page
Introduction.....	III	J-38, Key.....	55
AM-43/FRC, Dual Channel Amplifier.....	1	J-45, Key.....	56
AM-91/GNQ, Amplifier.....	2	J-47, Key.....	56
AM-92/TI, Amplifier.....	3	LS-3, Loudspeaker.....	57
AM-93/TI, Amplifier.....	4	LS-7, Loudspeaker.....	58
AM-129/U, Amplifier.....	5	LS-11, Loudspeaker.....	58
AM-130/U, Amplifier.....	6	LS-112/U, Loudspeaker.....	59
AM-200/F, Amplifier.....	7	LS-113/U, Loudspeaker.....	60
AM-364/U, AF Amplifier.....	8	LS-114/U, Loudspeaker.....	61
AN/FIA-1, Audio Distributing Central.....	9	LS-116/U, Loudspeaker.....	62
AN/GNQ-4, Recorder-Reproducer.....	11	LS-117/U, Loudspeaker.....	63
AN/GNQ-5 (*), Recorder-Reproducer.....	12	LS-122/U, Loudspeaker.....	64
AN/GNQ-6, Reproducer.....	13	LS-124(*)/FI, Intercommunicating Station.....	65
AN/GNQ-7, Recorder-Reproducer.....	14	LS-125/FI, Intercommunicating Station.....	66
AN/GNQ-7A, Recorder-Reproducer.....	15	LS-126/FI, Intercommunicating Station.....	67
AN/GNQ-8, Recorder-Reproducer.....	16	LS-127/FI, Intercommunicating Station.....	68
AN/GNQ-9 (*), Recorder-Reproducer.....	17	LS-128/FI, Intercommunicating Station.....	68
AN/GNQ-10, Reproducer.....	18	LS-129/FI, Intercommunicating Station.....	69
AN/GNQ-11, Record Set.....	19	LS-130/FI, Intercommunicating Station.....	70
AN/GSC-T1, Code Training Set.....	20	LS-133/FI, Intercommunicating Station.....	71
AN/GTC-1, Flash Ranging Set.....	21	LS-134/FI, Intercommunicating Station.....	72
AN/PIQ-1, Public Address Set.....	22	LS-138/FI, Intercommunicating Station.....	73
AN/PIQ-2, Public Address Set.....	23	LS-154/U, Speaker Assembly.....	74
AN/PNR-1, Sound Detector Set.....	24	M-2/U, Microphone.....	74
AN/PVQ-1, Spotlight Set.....	25	M-11/U, Microphone.....	75
AN/SIQ-1, Public Address Set.....	26	M-25/U, Microphone.....	76
AN/TIQ-2 (*), Public Address Set.....	27	M-209-(*), Converter.....	77
AN/TIQ-3, Public Address Set.....	28	M-238, Flag Set.....	78
AN/TIQ-8, Public Address Set.....	29	MC-181-(*), Stamp.....	79
AN/TTQ-1, Operations Center.....	30	MC-209, Record Set.....	80
AN/TTQ-2, Operations Center.....	31	MC-364-(*), Reproducing Equipment.....	80
AN/UIC-1, Intercommunication Set.....	32	MC-420, Alarm.....	81
AN/UIQ-1 (*), Public Address Set.....	33	MX-155/GT, Connecting and Switching Kit.....	82
AN/UIQ-3, Public Address Set.....	34	MX-212/U, Flashlight.....	83
AN/UNQ-1 (*), Sound Recording Set.....	35	MX-290/GV, Lantern.....	83
AN/URA-T1, Training Generator.....	36	MX-477/U, Magnetic Release Attachment.....	84
AN/VIA-1, Auxiliary Interphone Equipment.....	37	MX-480/U, Tape Reel.....	84
AN/VRS-1 (*), Detector Set.....	38	MX-481(*)/U, Tape Bridge.....	85
AP-50-(*), Panel Set.....	39	MX-550/U, Acoustical Headset.....	85
BC-1016, Recorder.....	40	PA-1-(*), Public Address Set.....	86
BD-70, Switchboard.....	41	PA-2-(*), Public Address Set.....	87
BD-114, Switchboard.....	42	PA-4-(*), Public Address Equipment.....	88
BG-121, Message Bag.....	43	PA-5-(*), Public Address Set.....	89
EE-84, Signal Lamp Equipment.....	44	PA-8, Intercommunication Set.....	90
EE-94-(*), Code Practice Equipment.....	45	PG-15, Band.....	91
EE-95-(*), Code Practice Equipment.....	46	PG-34-A, Scraper.....	91
EE-96-(*), Code Practice Equipment.....	48	PG-35, Sieve.....	91
GR-3-(*), Sound Ranging Set.....	49	PG-36, Brush.....	91
GR-4-(*), Flash Ranging Set.....	50	PG-37, Fountain.....	92
GR-6-(*), Sound Locating Set.....	51	PG-37-C, Fountain.....	92
GR-8, Sound Ranging Set.....	52	PG-38, Pan.....	92
H-16/U, Headset.....	53	PG-46-A, Loft.....	92
HS-16-(*), Headset.....	54	PG-49, Crate.....	93
HS-30-(*), Headset.....	55	PG-50, Cage.....	93
J-37, Key.....	55	PG-61, Cup.....	93
		PG-67, Message Holder.....	93

PG-68/TB, Loft.....	94	SE-11-(*), Signal Lamp Equipment.....	108
PG-75, Bowl.....	94	T-17-(*), Microphone.....	109
PG-100/CB, Parachute Equipment.....	94	T-30-(*), Microphone.....	110
PG-101/CB, Parachute Equipment.....	95	T-36, Microphone.....	110-(*)
PG-103/CB, Pigeon Equipment.....	95	T-45, Microphone.....	111
PG-105/CB, Pigeon Equipment.....	95	T-55, Microphone.....	112
PG-106/CB, Pigeon Vest.....	96	TE-5, Tool Equipment.....	113
PG-107/PB, Container.....	96	TE-6, Tool Set.....	114
RC-53-(*), Interphone Equipment.....	97	TE-8, File Equipment.....	114
RC-99, Interphone Equipment.....	98	TE-9, Wrench Equipment.....	115
RC-169, Recording Equipment.....	99	TE-11, Tool Set.....	115
RC-179, Recording Equipment.....	100	TE-14, Tool Set.....	116
RC-298, Interphone Extension Kit.....	101	TE-26, Soldering Equipment.....	116
RD-17/U, Recorder.....	102	TE-33, Tool Equipment.....	117
RD-23/TN, Recorder.....	102	TE-51, Tool Set.....	118
RD-31(*)/U, Recorder-Reproducer.....	103	TG-8-(*), Code Transmitter and Recorder.....	119
RD-36/U, Reproducer.....	104	TG-10-(*), Keyer.....	120
RD-38/FN, Recorder-Reproducer.....	105	VO-3-(*), Oscillator.....	121
S-1/FM, Shelter.....	106	Index.....	123
SCR-625-(*), Detector Set.....	107		

This manual supersedes the sound and light and miscellaneous equipment portions of TM 11-487, 2 October 1944

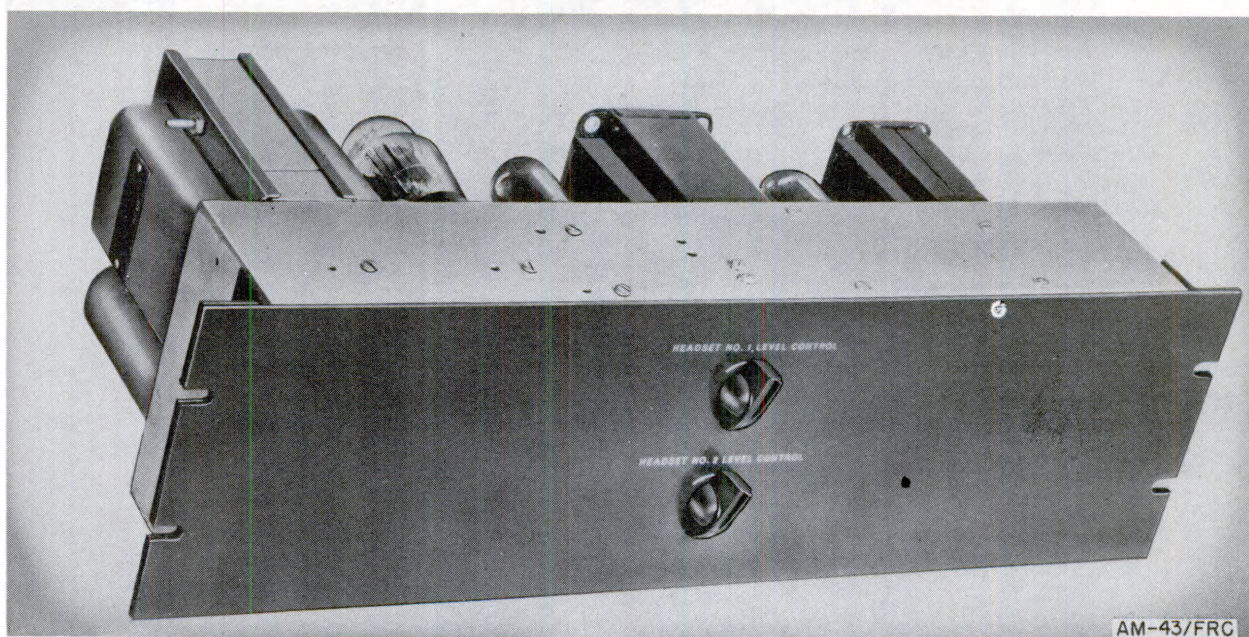

Figure 1. Dual Channel Amplifier AM-43/FRC.

Status: Limited/Standard. Stock No.: 2C449-43. Reference: TM 11-2520.

Dual Channel Amplifier AM-43/FRC is an audio-frequency amplifier designed to amplify two speech-frequency channels or tone circuits in the speech-frequency range. It is used primarily for amplification of low-level signals from telephone lines or other similar long transmission lines. It operates into a headset or loudspeaker circuit attached to the output terminals of each channel. Both channels may be used simultaneously.

TECHNICAL CHARACTERISTICS

POWER INPUT: 110 to 120 v, ac, 50 to 60 cps; 25 w.

WEIGHT AND DIMENSIONS

	Dimensions (in.)	Weight (lb)	Volume (cu ft)
Unpacked -----	17¼ x 10 x 5	19.7	.5



Figure 2. Amplifier AM-91/GNQ.

Status: Standard. **Stock No.:** 6C9-2. **Reference:** TM 11-2579.

Amplifier AM-91/GNQ is a three-stage, push-pull, audio amplifier with a built-in loudspeaker. Separate inputs are provided for a microphone and two turntables. Jacks are provided for an external speaker and for headset monitoring. Three binding posts are provided for microphones. Amplifier AM-91/GNQ is used with accessory recorder-reproducer and turntable (neither supplied with Amplifier AM-91/GNQ) as a combination portable sound recorder, record player, and public address system.

U/w Recorder-Reproducer AN/GNQ-9()

TECHNICAL CHARACTERISTICS

FREQUENCY RESPONSE:	Flat from 30 to 15,000 cps.
NOISE LEVEL:	-35 to -40 db.
GAIN:	90 db.
IMPEDANCE:	Input—500 ohms. Output—500 ohms.
DISTORTION:	Less than 1 percent at max level required at any frequency from 50 to 7,500 cps.
LOUDSPEAKER:	8-in. permanent magnet, dynamic.
POWER OUTPUT:	10 w.
POWER:	115 v, ac, 60 cps; 120 w.

WEIGHTS AND DIMENSIONS

	Dimensions (in.)	Weight (lb)	Volume (cu ft)
Unpacked	17 x 13 x 18½	53	2.37
Export pack	31 x 25 x 19	120	8.50

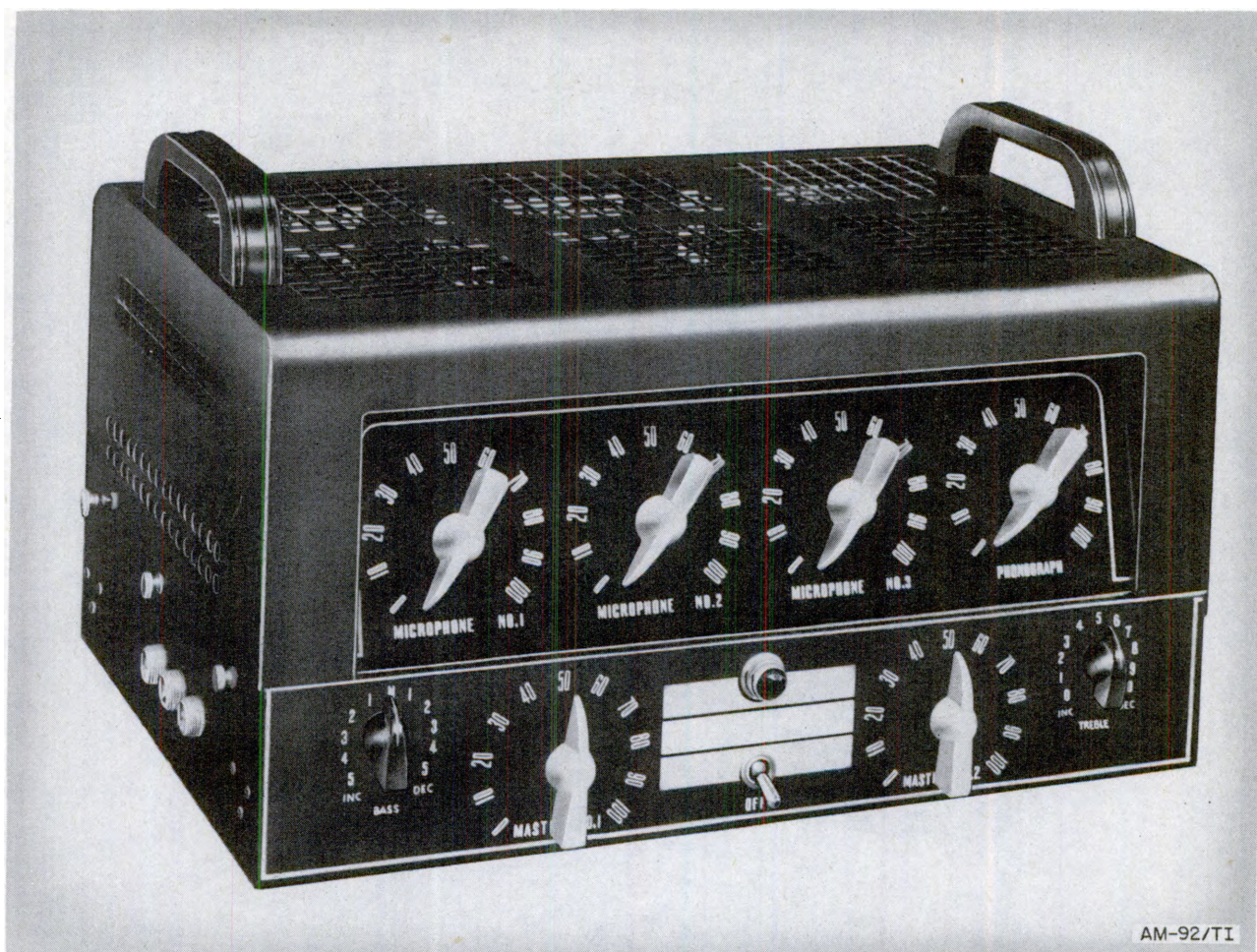

Figure 3. Amplifier AM-92/TI.

Status: Standard. *Stock No.:* 2C449-92. *Reference:* TM 11-2573.

Amplifier AM-92/TI is a public address amplifier using 14 tubes in a dual 4-stage resistance-coupled circuit with dual outputs that terminate in separate receptacles. Amplifier AM-92/TI when used with its associated equipment forms a complete system for the amplification and reproduction of sound over large areas. The associated equipments include a microphone, microphone stand, cables, a re-entrant horn speaker, and a transformer box assembly.

TECHNICAL CHARACTERISTICS

INPUT CHANNELS: 3 high-impedance microphone circuits.
1 high-impedance record-player input circuit.

POWER OUTPUT: 50 w, with not more than 5 percent distortion. The output is divided into 2 channels of 25 w ea.

POWER: 105 to 125 v, a.c., 50 to 60 cps; 275 w.

WEIGHTS AND DIMENSIONS

	Dimensions (in.)	Weight (lb)	Volume (cu ft)
Unpacked.....	10 x 14 x 16½	41	1.33
Export pack.....	105	3.75

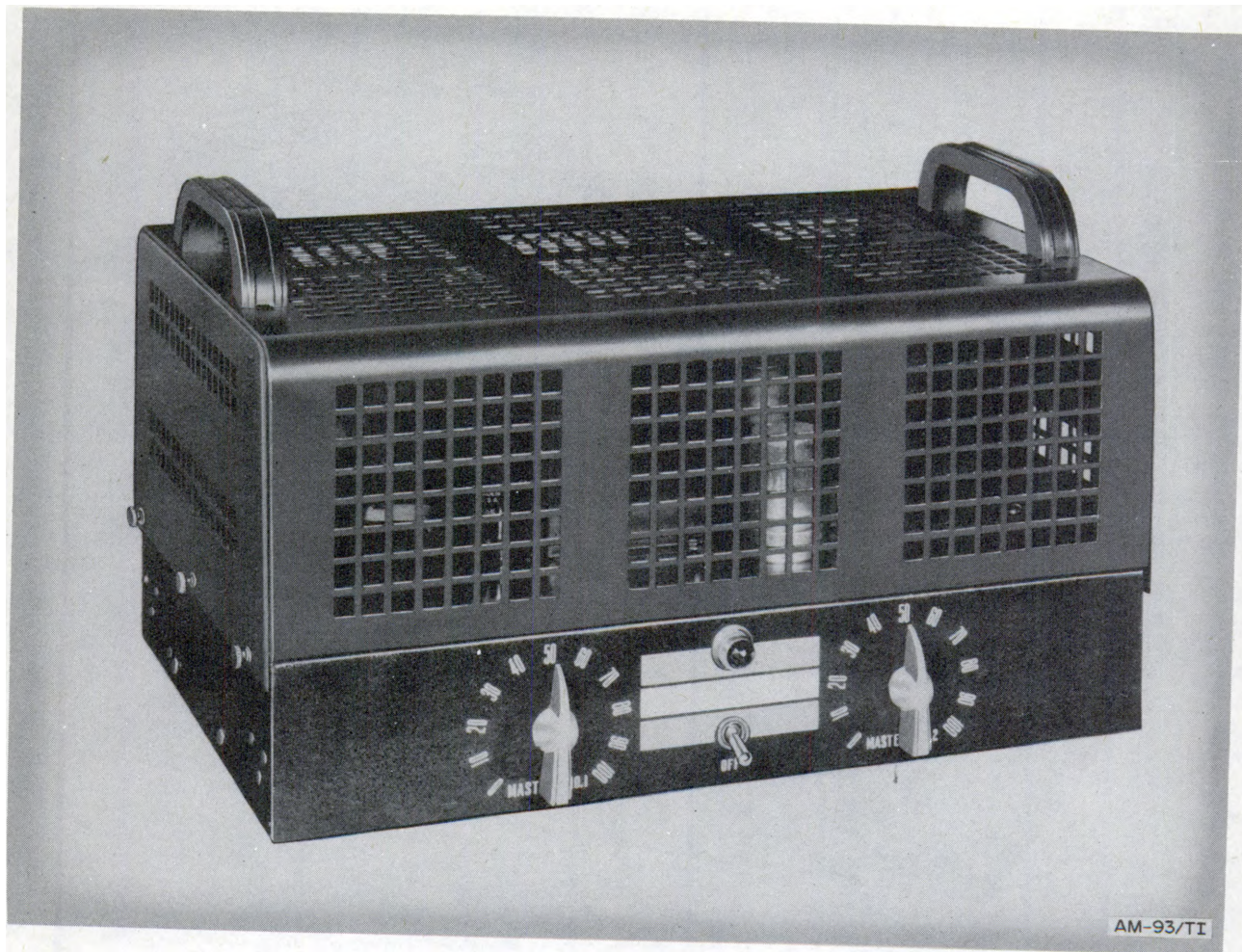

Figure 4. Amplifier AM-93/TI.

Status: Standard. Stock No.: 2C449-93. Reference: TM 11-2573.

Amplifier AM-93/TI is a booster amplifier using 10 tubes in a dual 3-stage resistance-coupled circuit with dual outputs that terminate in separate outputs. Amplifier AM-93/TI is used as a booster amplifier in conjunction with Amplifier AM-92/TI. When so used, the power output of the AM-92/TI is doubled.

U/w but not p/o Amplifier AM-92/TI.

TECHNICAL CHARACTERISTICS

POWER OUTPUT: 50 w, when used with Amplifier AM-92/TI.
 POWER: 105 to 125 v, ac, 50 to 60 cps; 250 w.

WEIGHTS AND DIMENSIONS

	Dimensions (in.)	Weight (lb)	Volume (cu ft)
Unpacked.....	10 x 14 x 16½	37	1.33
Export pack.....	137	5.0

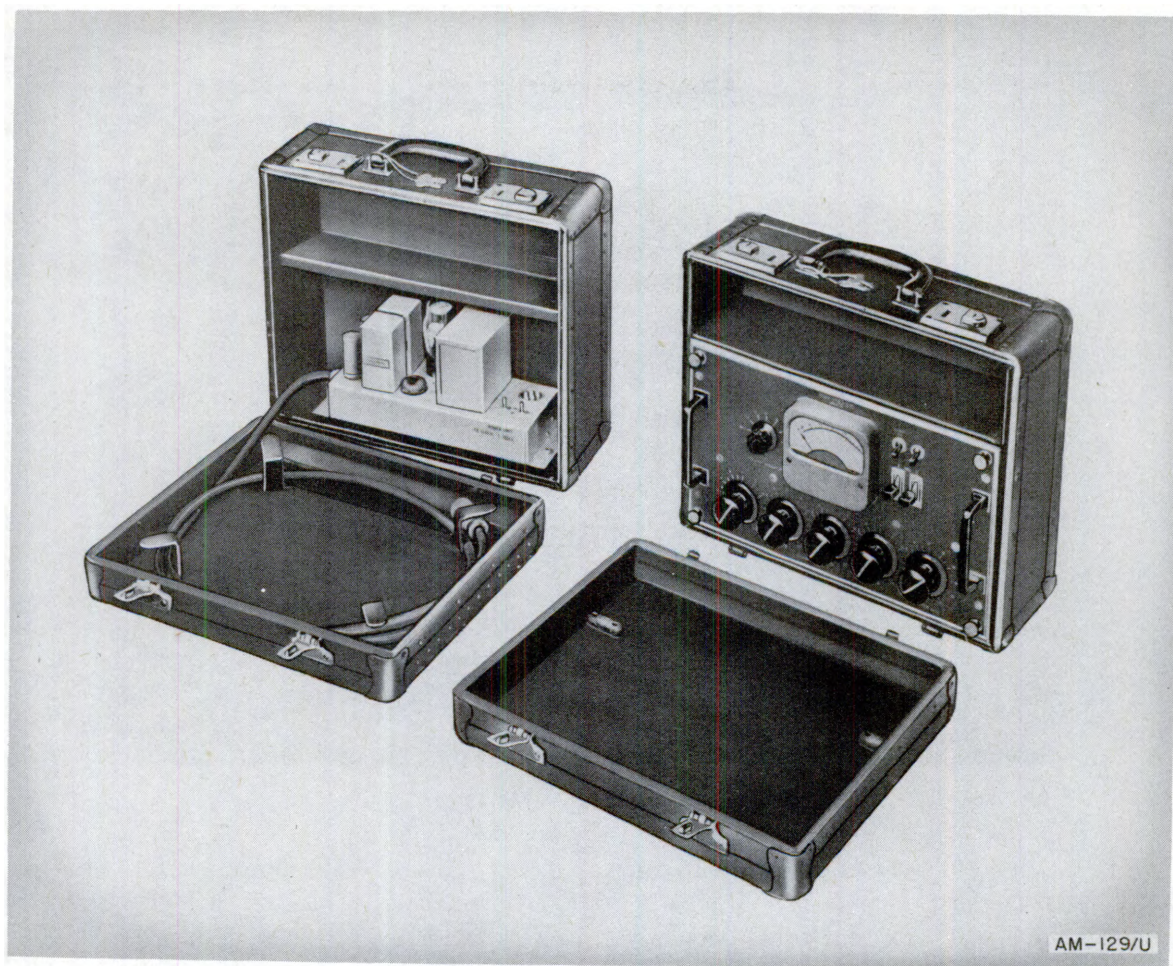

Figure 5. Amplifier AM-129/U.

Status: Standard. *Stock No.:* 2C449-129. *Reference:* TM 11-2588.

Amplifier AM-129/U is a portable speech-input equipment designed to provide complete pick-up facilities for remote broadcast programs. It consists of a combination amplifier and control unit, a power supply (rectifier) unit for ac, two carrying cases, and a power supply cord. Amplifier AM-129/U, with accessory equipment, forms a complete public address system for use in auditoriums, theaters, and other assembly halls. It may also be used as a mixing input unit with Audio Distributing Central AN/FIA-1.

U/w but not p/o Amplifier AM-130/U.

TECHNICAL CHARACTERISTICS

IMPEDANCE: Input—four 30-ohm microphones.
Output—150 or 600 ohms.

NET GAIN: 92 db.

POWER: 115 v, ac, 60 cps; 28 w.

WEIGHTS AND DIMENSIONS

	Dimensions (in.)	Weight (lb)	Volume (cu ft)
Unpacked ¹	15½ x 8¼ x 17	49	2.52
Export pack.....	17 x 18¼ x 21	56	3.77

¹ Unpacked equipment in two carrying cases. Dimensions are for each case, weight and volume for both.

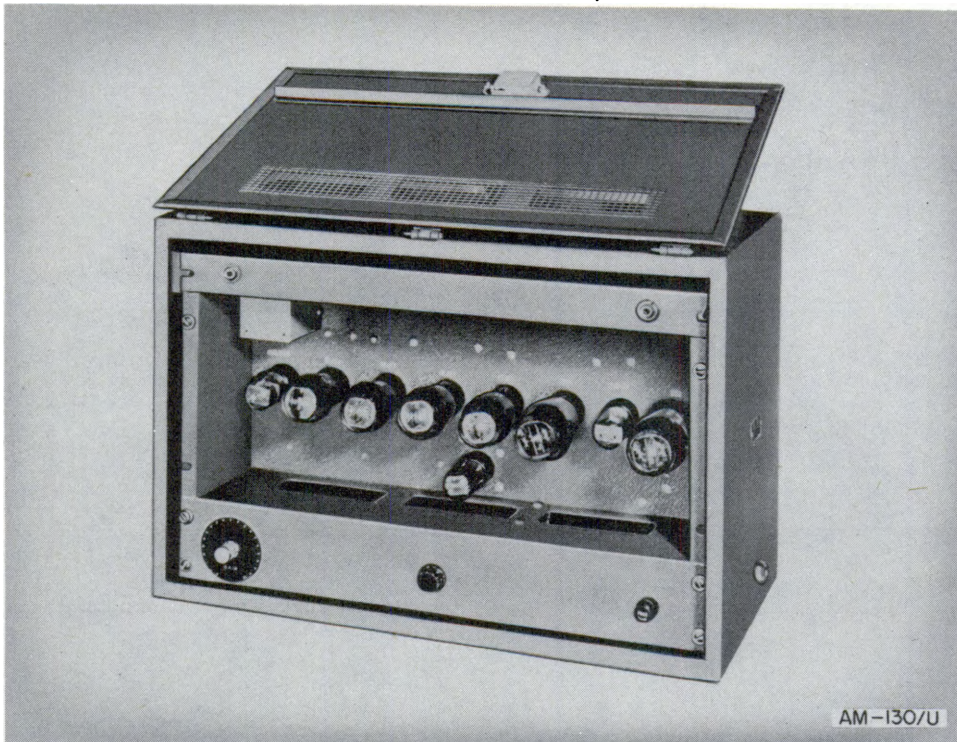

Figure 6. Amplifier AM-130/U.

Status: Standard. Stock No.: 2C449-130.
Reference: TM 11-2589.

Amplifier AM-130/U is a nine-tube, two-stage, push-pull, parallel amplifier that is mounted in a metal wall cabinet. It is used as a booster unit with Amplifier AM-129/U for installation in auditoriums, theaters, and other large assembly halls.

U/w but not p/o Amplifier AM-129/U.

TECHNICAL CHARACTERISTICS

INPUT: Bridged transformer—12,500 ohms, reflected load to input line.
INPUT SIGNAL: 1.1 v, 0-db level on 200-ohm line.

GAIN: Signal—39.2 db from 200-ohm, 0-db level to 50-w output level.
Power—57.2 db, based on 12,500-ohm input.
OUTPUT: 50 w or 70.7 v across 100 ohms with total 3 percent harmonic distortion.
FREQUENCY RESPONSE: 50 to 7,000 cps—within ½ db.
10,000 cps—within -1 db.
15,000 cps—within -2 db.
NOISE LEVEL: 65 db below rated output.
POWER REQUIRED: 206 w, max, 78 w, stand-by.
POWER: 115 or 230 v, ac, 60 cps.

WEIGHTS AND DIMENSIONS

	Dimensions (in.)	Weight (lb)	Volume (cu ft)
Unpacked.....	14 x 12 x 20½	65	1.98
Export pack.....	15 x 13 x 30	80	3.38

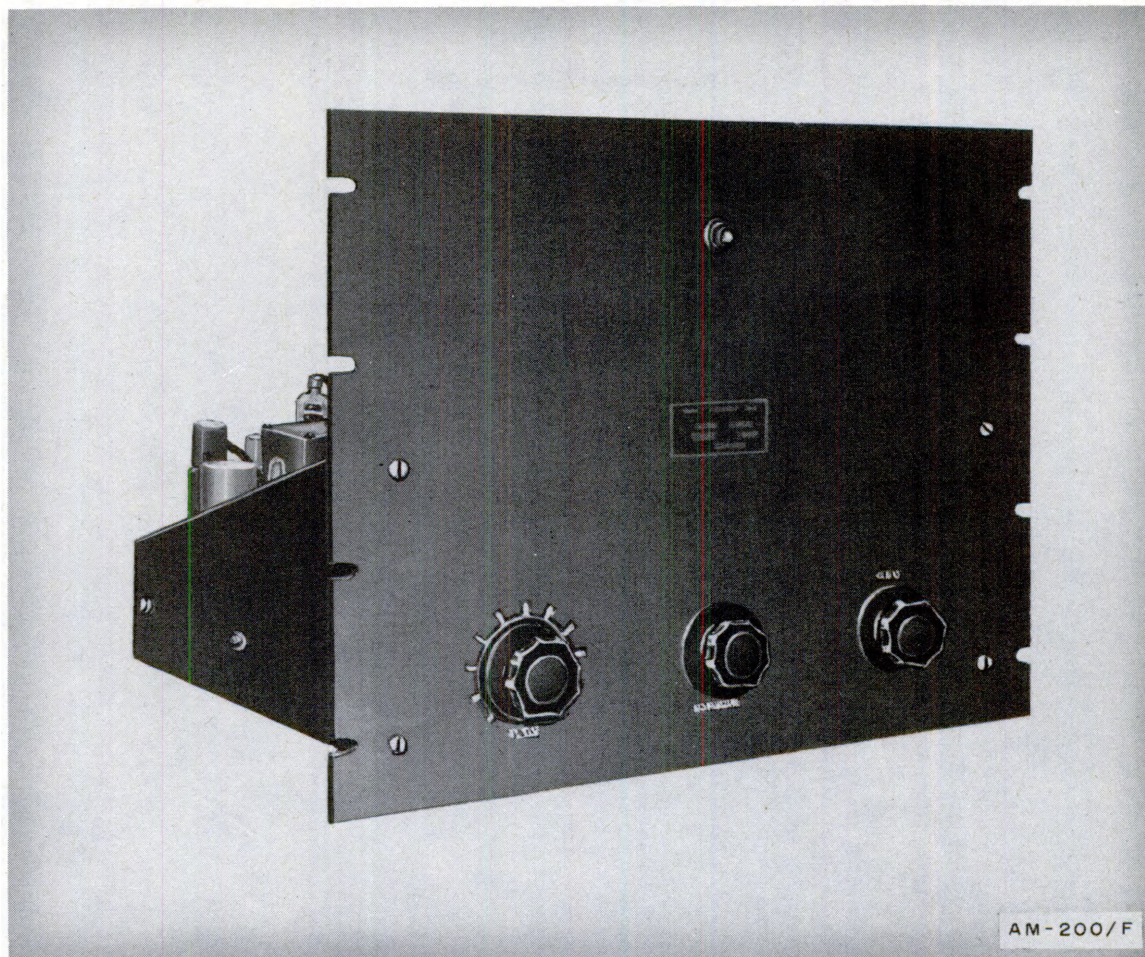

Figure 7. Amplifier AM-200/F.

Status: Standard.

Amplifier AM-200/F is a recording amplifier used in conjunction with recording and reproducing equipment. It is used to standardize the frequency response of recordings so that they will complement exactly the characteristics of high-fidelity reproducing equipment used in broadcasting stations.

TECHNICAL CHARACTERISTICS

FREQUENCY RESPONSE. 20 to 17,000 cps, flat within 1 db.

IMPEDANCES:

Input—500 or 15,000 ohms.
Output—500, 250, 15, or 6 ohms.

GAIN:

For 500-ohm input—85 db.
For 15,000-ohm input bridging a 500-ohm line—70 db.

POWER OUTPUT:

50 w.

DISTORTION:

Less than 1½ percent at full output.

NOISE LEVEL:

40 db below zero level.

POWER INPUT:

110 v, ac, 50 to 60 cps; 200 w.

WEIGHT AND DIMENSIONS

	Dimensions (in.)	Weight (lb)	Volume (cu ft)
Unpacked.....	14 x 19 x 14	---	2.15
Domestic pack.....	32 x 19 x 17½	95	6.6

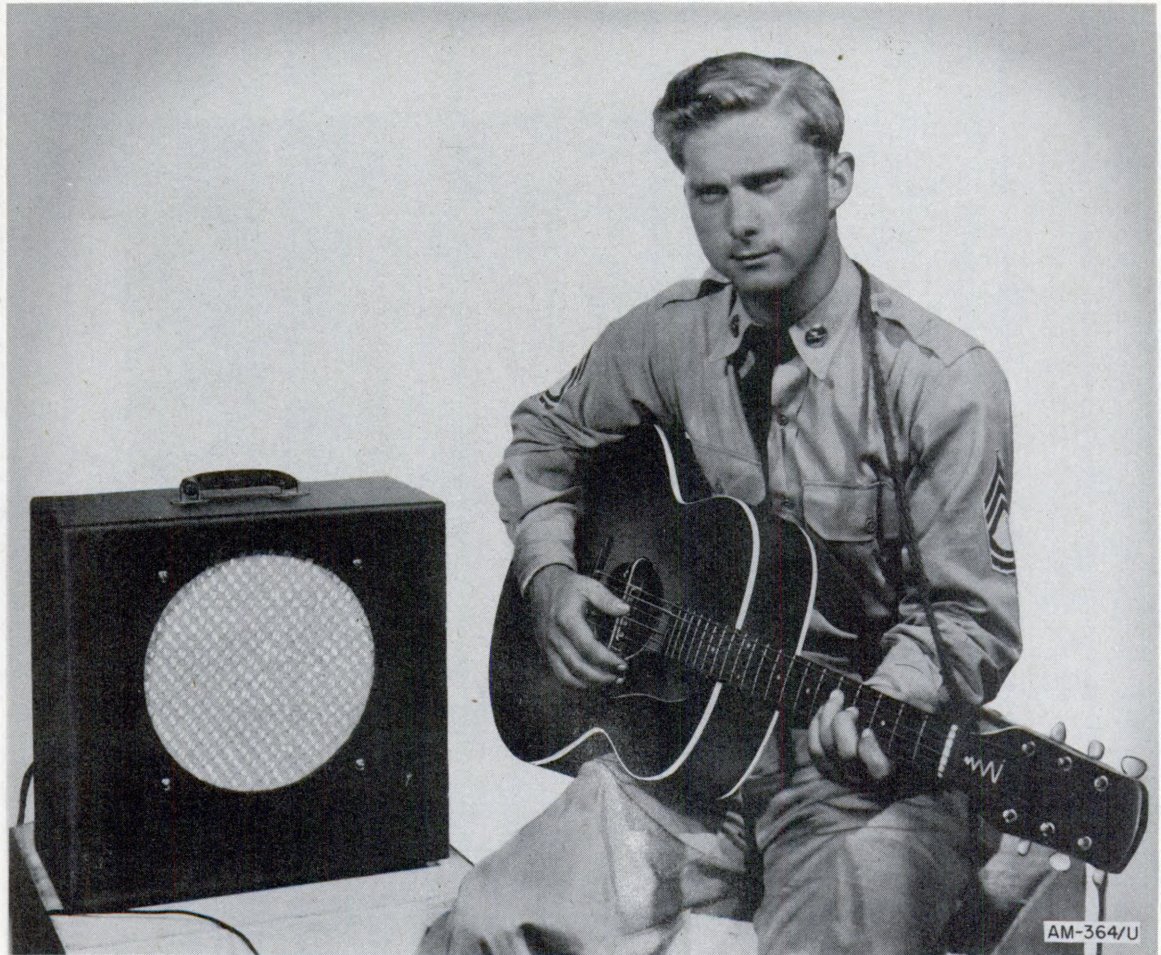

Figure 8. AF Amplifier AM-364 U in operation with Spanish guitar.

Status: Standard. *Stock No.:* 3C449-364. *Reference:* TM 11-5521.

AF Amplifier AM-364/U consists of a 10-tube amplifier, a special magnetic guitar pick-up, a portable cabinet containing a 12-inch permanent-magnet dynamic speaker, and a protective cover of canvas for the entire equipment. AF Amplifier AM-364/U is used to amplify the sounds of a Spanish guitar either for solo performances or as part of an orchestral rendition. Three guitarists may use this equipment simultaneously.

TECHNICAL CHARACTERISTICS

AMPLIFIER: Input channels—3 channels of 500,000 ohms ea to accommodate 3 guitar pick-ups, high-impedance microphones, or any combination of both.
Output impedance—6 ohms.

Frequency response—100 to 10,000 cps, within ± 3 db.
Volume controls—One to control two input channels, the other to control the third channel.
Power output—12 w.
Power—115 v, ac, 60 cps or 115 v, dc.

GUITAR PICK-UP: D-c resistance—150,000 ohms.
Impedance—500,000 ohms.
Volume control—Built in, 500,000 ohms (within reach of performer's finger).
Frequency response—40 to 10,000 cps within ± 1 db.
SPEAKER: Voice-coil impedance—6 ohms.

WEIGHTS AND DIMENSIONS

	<i>Dimensions (in.)</i>	<i>Weight (lb)</i>	<i>Volume (cu ft)</i>
Unpacked	16 $\frac{1}{8}$ x 15 $\frac{1}{2}$ x 8 $\frac{3}{4}$	20	1.3
Export pack	22 $\frac{1}{4}$ x 11 x 20 $\frac{1}{2}$	38	2.8

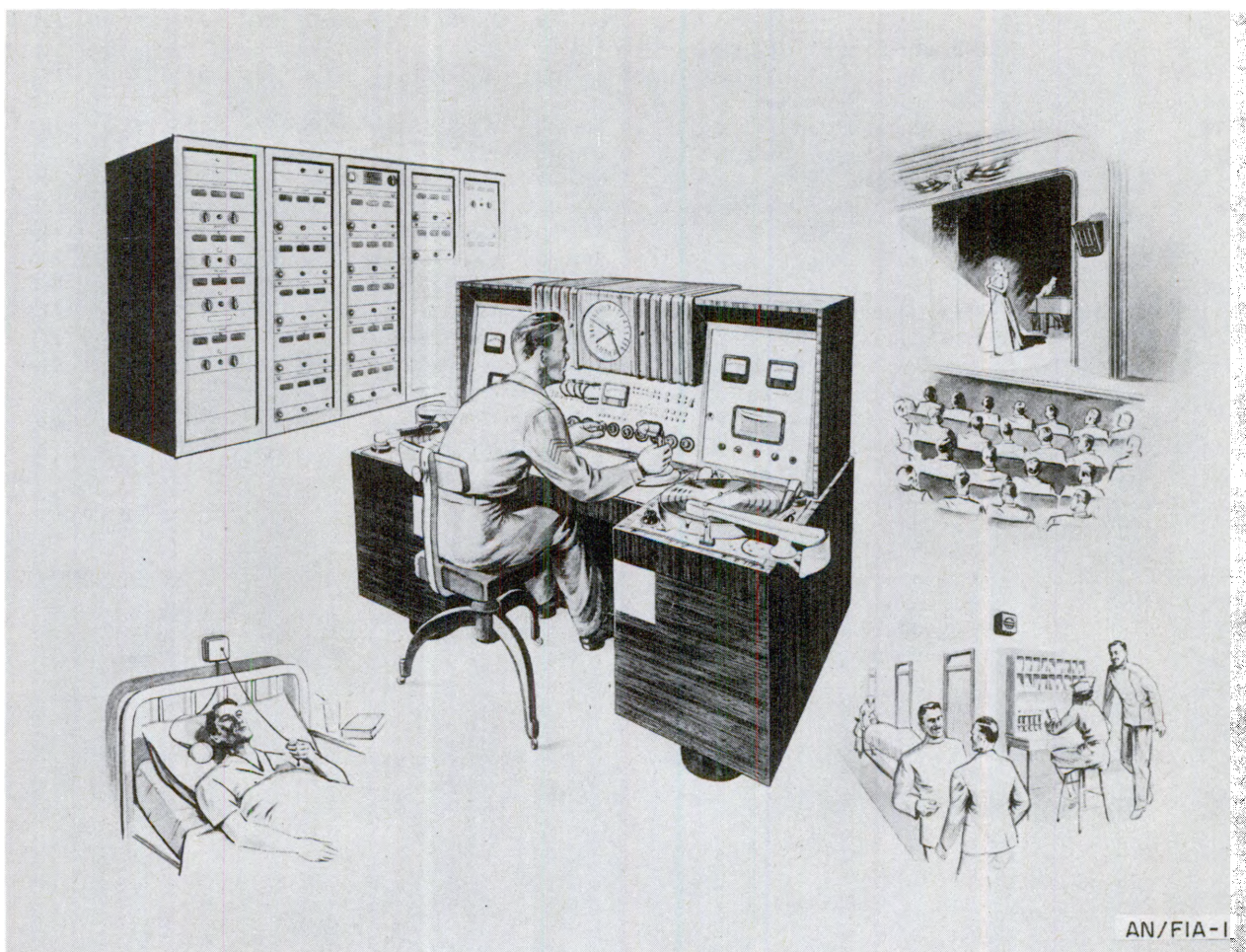

Figure 9. Audio Distributing Central AN/FIA-1.

Status: Standard. *Stock No.:* 6C190-1. *Reference:* TM 11-2590.

Audio Distributing Central AN/FIA-1 is an assembly of sound amplification and reproduction equipment. It is used for the amplification and reproduction of programs through pillow speakers, program speakers, and paging speakers in hospitals and similar installations. The system can originate programs from recordings or transcriptions; it can pick up and amplify two f-m, standard a-m, or short-wave a-m broadcast programs simultaneously. Programs piped in from telephone lines or originated by speech input equipment can be amplified by this system. Each pillow speaker unit and program selector is provided with a selector switch to select any of four program channels.

TECHNICAL CHARACTERISTICS

RADIO RECEIVER FREQUENCY RANGE.	A-m band—540 to 1,600 kc, 5.9 to 15.6 mc. F-m band—88 to 108 mc.
---------------------------------------	--

DRIVER AMPLIFIERS.

Input—60 ohms.
Input signal—45 μ v at 5,000 cps.
Gain—89 db, 60-ohm input to 200-ohm circuit.
Output No. 1—200 ohms, +7 db or 2.45 v, .03-w max. Balanced center tapped.
Output No. 2—500 ohms, +19 db or 15.5 v, .48-w max. Not center tapped.
Power output—.5 w with 1 percent distortion.
Frequency response—5 db at 60 cps, flat from 300 to 7,000 cps.
Tone control—18-db max bass attenuation at 50 cps. 22-db max treble attenuation at 10,000 cps.
Noise level—40 db below normal output level.
Impedance input—12,500 ohms.
Impedance output—100 ohms.
Input signal—1.1 v (0-db level on 200-ohm line).

POWER AMPLIFIERS.

**TURNTABLE
SPEEDS.
REPRODUCER,
DYNAMIC.**

**REPRODUCER,
CRYSTAL.**

**MICROPHONE
ASSEMBLY.**

Gain—39.2 db from 200-ohm,
0-db level to 50-w output
level.
Output—50 w or 70.7 v across
100 ohms.
Frequency response—50 to
7,000 cps, within ½ db; 10,000
cps, within -1 db; 15,000
cps, within -2 db.
Noise level—65 db below rated
output.
33½ and 78 rpm.
Max frequency cut-off—above
10,000 cps.
Impedance—into 30 ohms.
Output level— -62 vu.
Stylus pressure—35 grams.
Impedance—1.6 meg at 100 cps.
Frequency response—50 to
5,000 cps, within 1 db. Over
5,000 cps, within 10 db.
Stylus pressure—30 grams.
Impedance—20 ohms.
Frequency response—40 to
10,000 cps within ± 4 db.
Output level— -82 vu.

PRINCIPAL COMPONENTS¹

<i>Item</i>	<i>Dimensions (in.)</i>	<i>Weight (lb)</i>
Console OA-23/FIA-1, left side.	33½ x 24 x 27	121
Console OA-23/FIA-1, right side.	33½ x 24 x 27	121
Console OA-23/FIA-1, main section.	57½ x 30 x 74½	439
Console OA-23/FIA-1, desk section.	4 x 15 x 32	30
Amplifier AM-124/U	73¼ x 16½ x 22½	213
Amplifier AM-125/U	73¼ x 16½ x 22½	293
Amplifier AM-126/U	73¼ x 16½ x 22½	285
Amplifier AM-127/U	73¼ x 16½ x 22½	218
Amplifier AM-128/U	73¼ x 16½ x 22½	171
Microphone Assembly M-10/ FIA-1.	10¼ x 7½ (diam)	9½ ea
F-m converter	7¼ x 4¼ x 2¼	5

PACKED WEIGHT AND VOLUME

	<i>Total weight (lb)</i>	<i>Total volume (cu ft)</i>
<u>Export pack</u>	2,812	95

¹ The following are not included with AN/FIA-1 but are required for complete operation:

Loudspeakers LS-112/U	Headsets MX-550/U
Loudspeakers LS-113/U	Adapters MX-551/FIA-1
Loudspeakers LS-114/U	Outlet Boxes J-175/FIA-1

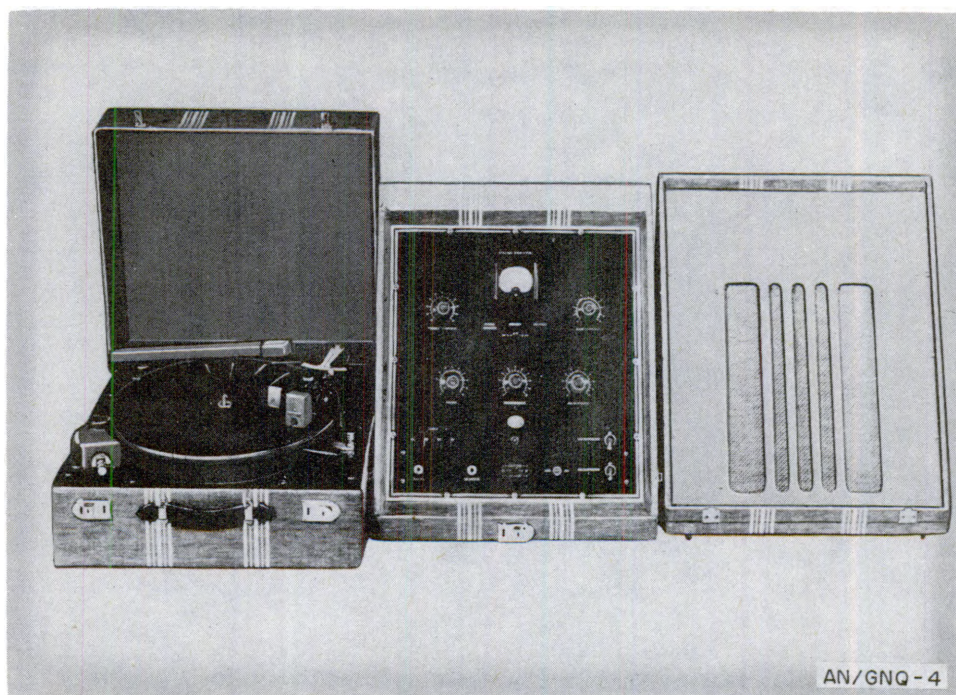

Figure 10. Recorder-Reproducer AN/GNQ-4

Status: Substitute/Std. *Stock No.:* 6C263-13.
Reference: TM 11-2567.

Recorder-Reproducer AN/GNQ-4 is a portable combination sound recorder, record player, and public address system. It consists of an amplifier, a turntable, and a loudspeaker. A microscope, a microphone, cables, and needles are furnished with equipment. Recorder-Reproducer AN/GNQ-4 is used to make electrical transcriptions of high quality. It may also be used as a public address system, serving audiences up to 500 persons.

TECHNICAL CHARACTERISTICS

RECORDING DISK: 7-in. plastic or metal disk.
TURNTABLE SPEEDS. 33½ and 78 rpm.
FREQUENCY RESPONSE. Amplifier—30 to 10,000 cps, normal. Treble control produces a max peak of 17 db at 6,500 cps. Treble control as scratch filter gives max attenuation of 20 db at 5,000 cps. Bass control produces a max peak of 20 db at 100 cps. Cutting head—50 to 8,000 cps. Pickup—70 to 7,500 cps.

NOISE LEVEL: Over 35 db below max useful sound level reproduced from recordings.
AMPLIFIER GAIN: 115 db.
IMPEDANCE: Input—50 ohms. Line input—500 ohms. Output—8 ohms.
CUTTING PITCH: 110 lines per in.
SPEED ACCURACY: Within .5 percent at both 33½ and 78 rpm. Regulation within a single revolution is accurate to .25 percent.
POWER: 115 v, ac, 60 cps; 180 w.
POWER OUTPUT: 10 w.

PRINCIPAL COMPONENTS

Item	Dimensions (in.)	Weight (lb)
Amplifier AM-69/GNQ-4	23½ x 12 x 20	57
Recorder Turntable Unit RD-13/GNQ-4	20½ x 11 x 19	49
Loudspeaker LS-109/GNQ-4	2½ x 15½ x 17	5

PACKED WEIGHT AND VOLUME

	Weight (lb)	Volume (cu ft)
Export pack	210	14.8



Figure 11. Recorder-Reproducer AN/GNQ-5.

Status: Standard. *Stock No.:* 6C623-9 (AN/GNQ-5) and 6C263-9A (AN/GNQ-5A). *Reference:* TM 11-2547.

Recorder-Reproducer AN/GNQ-5(*) represents AN/GNQ-5 and AN/GNQ-5A. Recorder-Reproducer AN/GNQ-5(*) consists of a dual-speed turntable, a driving motor, a recording arm, a playback arm, a microphone, and an audio amplifier with a loudspeaker. All of this equipment is mounted in an airplane-luggage style case. A record holder is provided in the lid of the case for carrying a supply of records and recording disks. Recorder-Reproducer AN/GNQ-5(*) is used to record either voice or music from a microphone, a radio, or a telephone line. It is also used to play back commercial phonograph records or transcriptions at speeds of 78 or 33½ rpm. The unit may also be used as a public address set without utilizing its recording or play-back functions.

TECHNICAL CHARACTERISTICS

RECORDING DISK: 7-in acetate disk.
 TURNTABLE SPEED: 33½ and 78 rpm.
 POWER INPUT: 105 to 125 v, ac, 60 cps, 70 w.
 AMPLIFIER POWER 3 w.
 OUTPUT.

WEIGHT AND DIMENSIONS

	<i>Dimensions (in.)</i>	<i>Weight (lb)</i>	<i>Volume (cu ft)</i>
Unpacked.....	17½ x 11¼ x 17½	43½	2.00

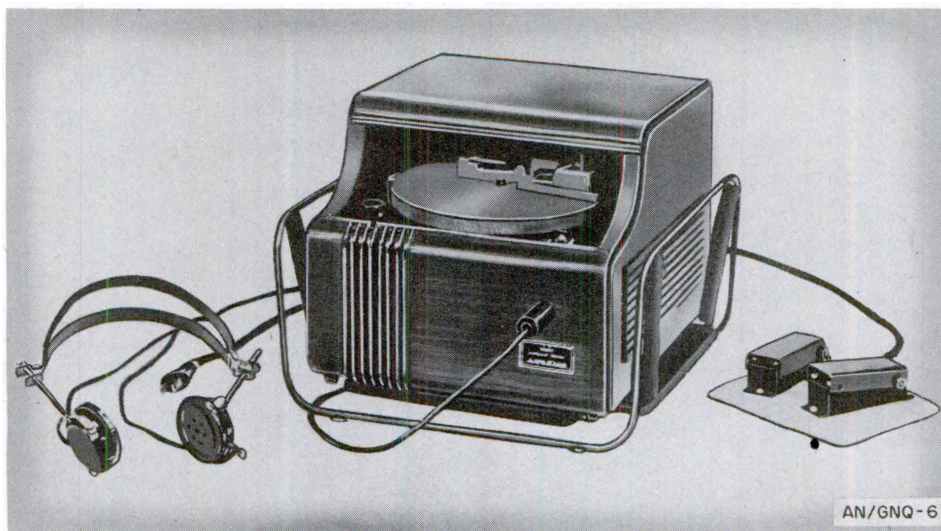

Figure 12. Reproducer AN/GNQ-6.

Status: Standard. *Stock No.:* 6C263-10. *Reference:* TM 11-2511.

Reproducer AN/GNQ-6 consists of a desk-model cabinet, a turntable unit and turntable motor, a reproducer head, an amplifier, a step-back and brake assembly, a headset, and a cradle. It is used for transcribing from a disk record. The equipment reproduces through a headset.

U/w but not p/o Recorder-Reproducer AN/GNQ-8.

TECHNICAL CHARACTERISTICS

TURNTABLE SPEED:	33 $\frac{1}{3}$ rpm.
RECORDING DISK:	7-in. plastic disk.
FREQUENCY RESPONSE.	200 to 3,000 cps, flat within 6 db.
OVER-ALL GAIN:	110 db.
IMPEDANCE.	Reproducer head—50 ohms. Headset—500 ohms.
POWER:	115 v, ac, 60 cps; 50 w.
POWER OUTPUT:	3 w.

WEIGHTS AND DIMENSIONS

	Dimensions (in.)	Weight (lb)	Volume (cu ft)
Unpacked.....	12 $\frac{1}{2}$ x 8 $\frac{1}{2}$ x 10 $\frac{1}{4}$ ---	17	.63
Export pack.....	19 x 19 x 29.....	91	6.06

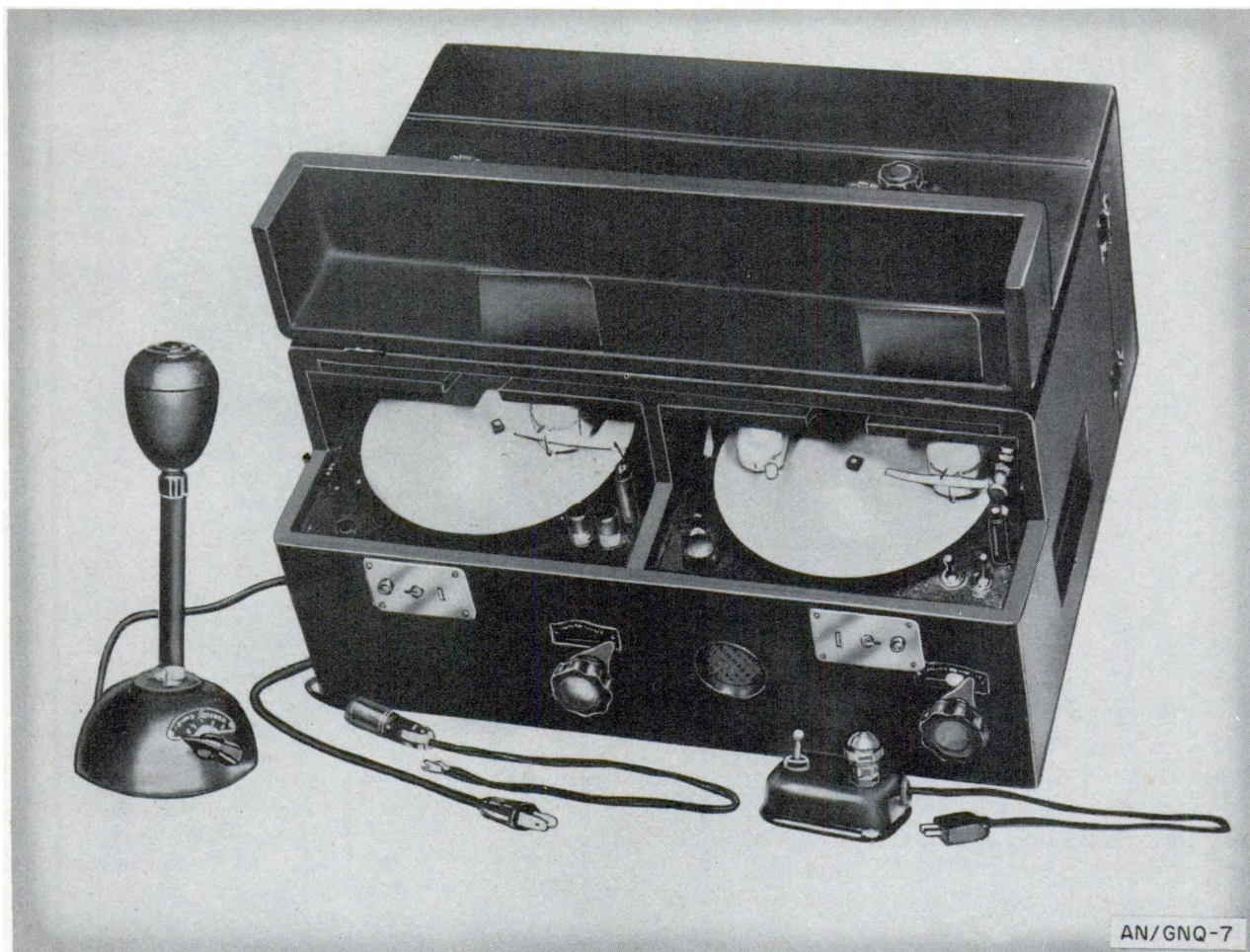

Figure 13. Recorder-Reproducer AN/GNQ-7.

Status: Standard. *Stock No.:* 6C263-11. *Reference:* TM 11-2511.

Recorder-Reproducer AN/GNQ-7 consists of a cabinet, an a-v-c unit, and two turntable and motor units—one with both recorder and reproducer heads and the other with a reproducer head only. Also included are an amplifier, a built-in permanent magnet speaker, a microphone, a remote control unit, an a-c power cable, and a telephone tap cord. Recorder-Reproducer AN/GNQ-7 is used to make recordings of dictations, conferences, telephone conversations, and the like, and to play back the recordings. The equipment reproduces through a loudspeaker and is provided with a logging system to determine recorded positions on the record.

TECHNICAL CHARACTERISTICS

RECORDING DISK: 7-in. plastic disk.
CAPACITY: 15 min.
TURNTABLE SPEED: 33 $\frac{1}{3}$ rpm.
FREQUENCY RANGE: 200 to 3,000 cps, flat within 6 db.
OVER-ALL GAIN: 110 db.
IMPEDANCE: Reproducer head—50 ohms.
 Recorder head—17 ohms.
 Microphone—50 ohms.
POWER: 115 v, ac, 60 cps; 75 w.
POWER OUTPUT: 3 w.

WEIGHTS AND DIMENSIONS

	Dimensions (in.)	Weight (lb)	Volume (cu ft)
Unpacked.....	10 $\frac{1}{4}$ x 16 $\frac{1}{4}$ x 19.	46	1.80
Export pack.....	17 x 24 x 31.....	130	7.34

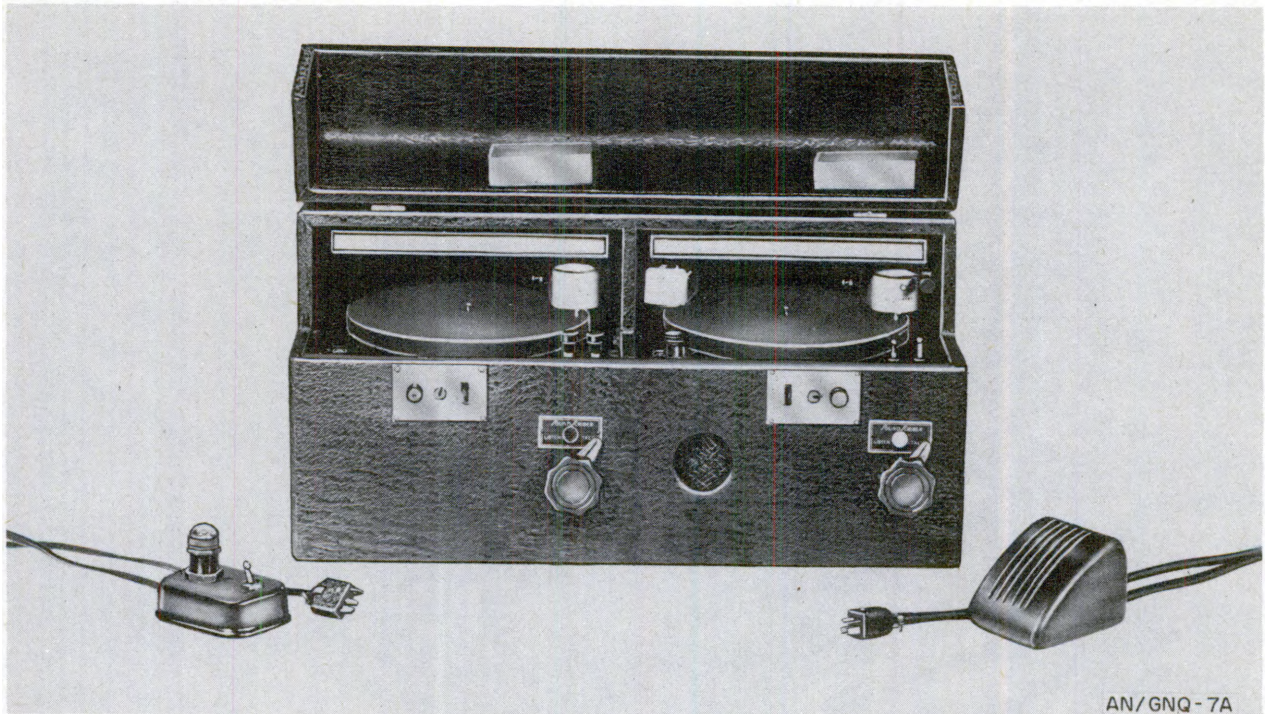

Figure 14. Recorder-Reproducer AN/GNQ-7A.

Status: Standard. *Stock No.:* 6C263-11. *Reference:* TM 11-2511.

Recorder-Reproducer AN/GNQ-7A consists of a cabinet, an a-v-c unit, and two turntable and motor units—one with both recorder and reproducer heads and the other with a reproducer head only. Also included are an amplifier, a built-in permanent magnet speaker, a microphone, a remote control unit, an a-c power cable, and a telephone tap cord. Recorder-Reproducer AN/GNQ-7A is used to make recordings of dictations, conferences, telephone conversations and the like, and to play back the recordings. The equipment reproduces through a loudspeaker and is provided with a logging system to determine recorded positions on the record.

TECHNICAL CHARACTERISTICS

RECORDING DISK:	7-in. plastic disk.
CAPACITY:	15 min.
TURNTABLE SPEED:	33 $\frac{1}{3}$ rpm.
FREQUENCY RANGE:	200 to 3,000 cps, flat within 6 db.
OVER-ALL GAIN:	110 db.
IMPEDANCE:	Reproducer head—50 ohms. Recorder head—4 ohms. Microphone—10 ohms.
POWER:	115 v, ac, 60 cps; 75 w.
POWER OUTPUT:	3 w.

WEIGHT AND DIMENSIONS

	Dimensions (in.)	Weight (lb)	Volume (cu ft)
Unpacked	10 $\frac{1}{8}$ x 16 $\frac{1}{2}$ x 19	46	1.80

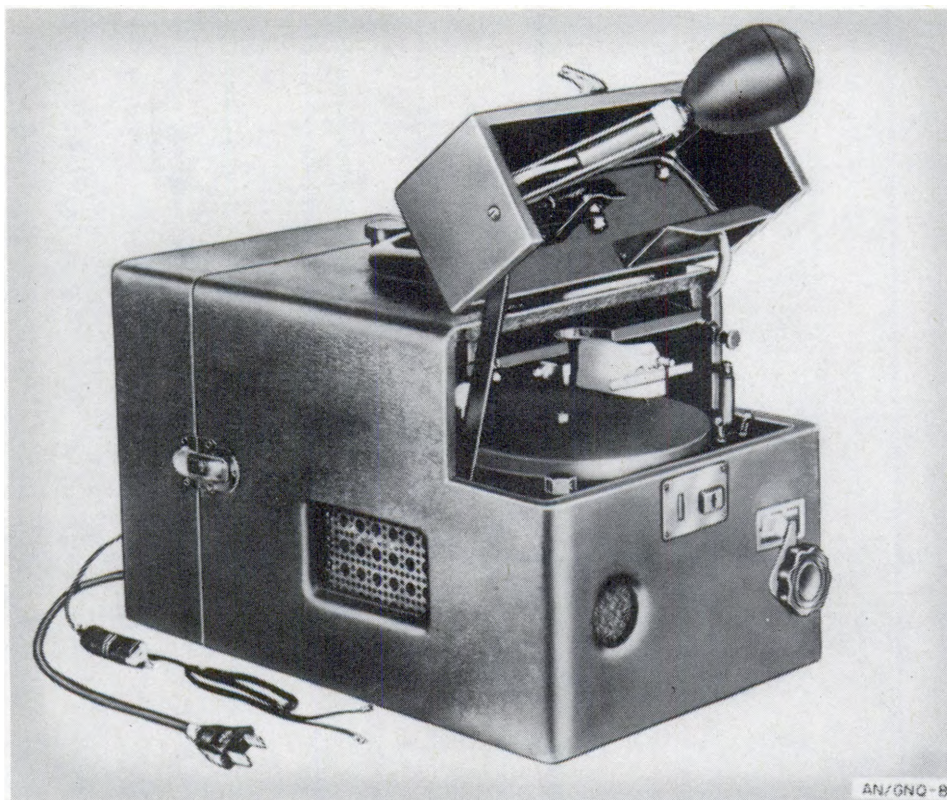

Figure 15. Recorder-Reproducer AN/GNQ-8.

Status: Standard. *Stock No.:* 6C263-15. *Reference:* TM 11-2511.

Recorder-Reproducer AN/GNQ-8 consists of a cabinet, an a-v-c unit, a turntable unit with turntable motor, a built-in speaker, a microphone, cords, and recorder and reproducer heads. Recorder-Reproducer AN/GNQ-8 is used to make recordings of dictations, conferences, telephone conversations, and the like, and to play back the recordings. The equipment reproduces through a loudspeaker and is provided with a logging system to determine recorded positions on the record.

U/w but not p/o Reproducer AN/GNQ-6.

TECHNICAL CHARACTERISTICS

RECORDING DISK:	7-in. plastic disk.
CAPACITY:	15 min.
TURNTABLE SPEED:	33 $\frac{1}{3}$ rpm.
FREQUENCY RANGE:	200 to 3,000 cps, flat within 6 db.
OVER-ALL GAIN:	110 db.
IMPEDANCE:	Reproducer head—50 ohms. Recorder head—17 ohms. Microphone—50 ohms.
POWER:	115 v, ac, 60 cps; 50 w.
POWER OUTPUT:	3 w.

WEIGHTS AND DIMENSIONS

	Dimensions (in.)	Weight (lb)	Volume (cu ft)
Unpacked.....	10 x 10 $\frac{1}{4}$ x 16 $\frac{1}{4}$..	29 $\frac{1}{2}$.95
Export pack.....	16 x 16 x 28.....	89	4.15

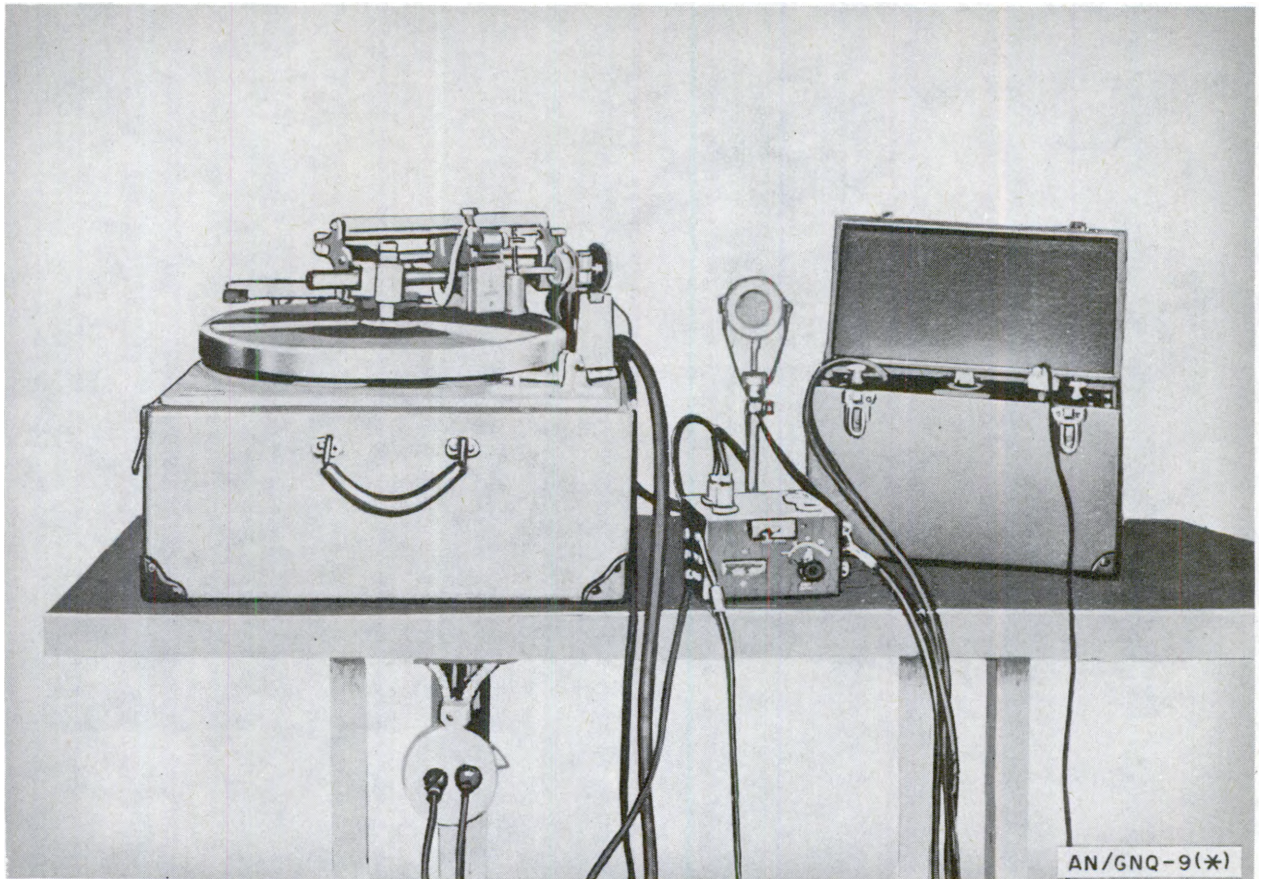

Figure 16. Recorder-Reproducer AN/GNQ-9, with amplifier.

Status: Standard. *Stock No.:* 6C263-6N. *Reference:* TM 11-2579.

Recorder-Reproducer AN/GNQ-9(*) represents AN/GNQ-9 and AN/GNQ-9A. Recorder-Reproducer AN/GNQ-9(*) is a portable sound recorder which utilizes 16-inch acetate disks. It consists of a turntable and automatic equalizer. A separate amplifier, such as Amplifier AM-91/GNQ, which is matched to the unit, is required. Recorder-Reproducer AN/GNQ-9(*) is used to make continuous electrical transcriptions of high quality in broadcasting stations and in recording studios.

U/w Amplifier AM-91/GNQ.

TECHNICAL CHARACTERISTICS

RECORDING DISK:	16-in. acetate disks.
TURNTABLE SPEEDS.	33½ and 78 rpm.
FREQUENCY RESPONSE.	Cutter head—50 to 8,000 cps. Pick-up head—70 to 7,500 cps.

CUTTING PITCH:	112 lines per in., inside-out, with feed screw supplied.
SPEED ACCURACY:	Within 5 percent at both 33½ and 78 rpm. Regulation within a single revolution is accurate to 25 percent.
AUTOMATIC EQUALIZER RESPONSE.	Recordings at 33½ rpm can be made uniform to 6,000 cps between a radius of 3½ and 4½ in. The full response of the cutting head can be reproduced at a groove radius of 5½ in. or more.
IMPEDANCE:	500 ohms, input and output.
INSERTION LOSS:	30 db at 1,000 cps.
POWER:	115 v, ac, 60 cps; 60 w.

WEIGHTS AND DIMENSIONS

	Dimensions (in.)	Weight (lb)	Volume (cu ft)
Unpacked.....	20¼ x 20 x 15	82	3.69
Export packed.....	39 x 28 x 18	150	11.4

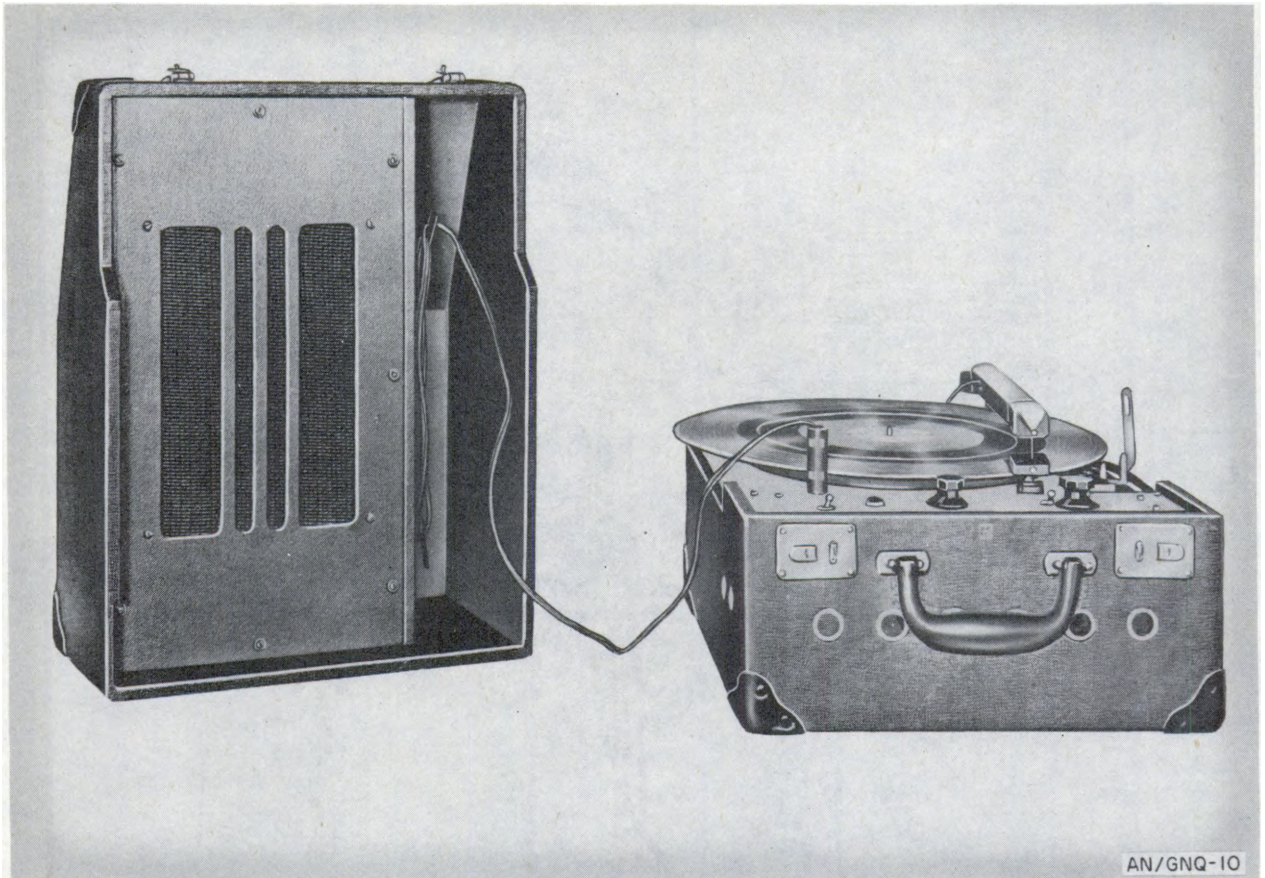

Figure 17. Reproducer AN/GNQ-10.

Status: Standard. Stock No.: 6C263-14. Reference: TM 11-2580.

Reproducer AN/GNQ-10 consists of a 12-inch dual-speed rim-driven turntable, a 16-inch magnetic pick-up which folds into the case when not in use, a three-stage amplifier, and an 8-inch loudspeaker; all are mounted in a single carrying case. The speaker is equipped with a 20-foot extension cable and plug. A semipermanent playing needle is supplied with the equipment. Reproducer AN/GNQ-10 is used to reproduce 10-, 12-, and 16-inch sound recordings for morale and training purposes and for general entertainment.

TECHNICAL CHARACTERISTICS

TURNTABLE SPEEDS.	33½ and 78 rpm.
FREQUENCY RESPONSE.	80 to 7,500 cps, flat within 2 db.

GAIN: REPRODUCER.	More than 70 db at 1,000 cps.
LOUDSPEAKER:	Lateral, magnetic, high-impedance type; needle pressure 1¼ ounces.
OUTPUT IMPEDANCE.	8-in. permanent magnet, dynamic type; 6-ohm voice-coil impedance.
POWER OUTPUT:	8 ohms.
SPEED ACCURACY:	4.5 w undistorted.
POWER:	Within .5 percent at both 33½ and 78 rpm. Regulation within a single revolution is accurate to .3 percent.
	115 v, ac, 60 cps; 110 w.

WEIGHTS AND DIMENSIONS

	Dimensions (in.)	Weight (lb)	Volume (cu ft)
Unpacked.....	19½ x 15½ x 14	46	2.45
Export packed.....	27 x 24½ x 19	85	7.27



Figure 18. Record Set AN/GNQ-11.

Status: Standard. *Stock No.:* 6C273D-11.

Record Set AN/GNQ-11 is a set of 11 records, each simulating one condition of cw signals and messages masked by noise, static, or howl. The set is arranged in a loose-leaf album for convenience. It is used for training and testing telegraph and radiotelegraph operators.

TECHNICAL CHARACTERISTICS

RECORDS: 12-in. vinylite disk.
TURNTABLE SPEED: 78 rpm.
CONDITIONS SIMULATED. Stepped tones, random noise, random keying sounds, spark sounds, sweep through sounds, howl sounds, cw signals masked with high and low level stepped tones and high and low level noise, cw messages masked with low and medium level stepped tones and static, phono channel at 500,000 ohms, auditory test marked with random noise, and auditory test marked with stepped tones.

PRINCIPAL COMPONENTS

Item	Dimensions (in.)
Case CY-539/GNQ-11.....	13½ x 13½ x 5½
Record MX-621/GNQ-11.....	12 (diam)
Record MX-622/GNQ-11.....	12 (diam)
Record MX-623/GNQ-11.....	12 (diam)
Record MX-624/GNQ-11.....	12 (diam)
Record MX-625/GNQ-11.....	12 (diam)
Record MX-626/GNQ-11.....	12 (diam)
Record MX-627/GNQ-11.....	12 (diam)
Record MX-628/GNQ-11.....	12 (diam)
Record MX-629/GNQ-11.....	12 (diam)
Record MX-630/GNQ-11.....	12 (diam)
Record MX-631/GNQ-11.....	12 (diam)

DIMENSIONS

	Dimensions (in.)	Volume (cu ft)
Unpacked	13½ x 13½ x 5½	. 58

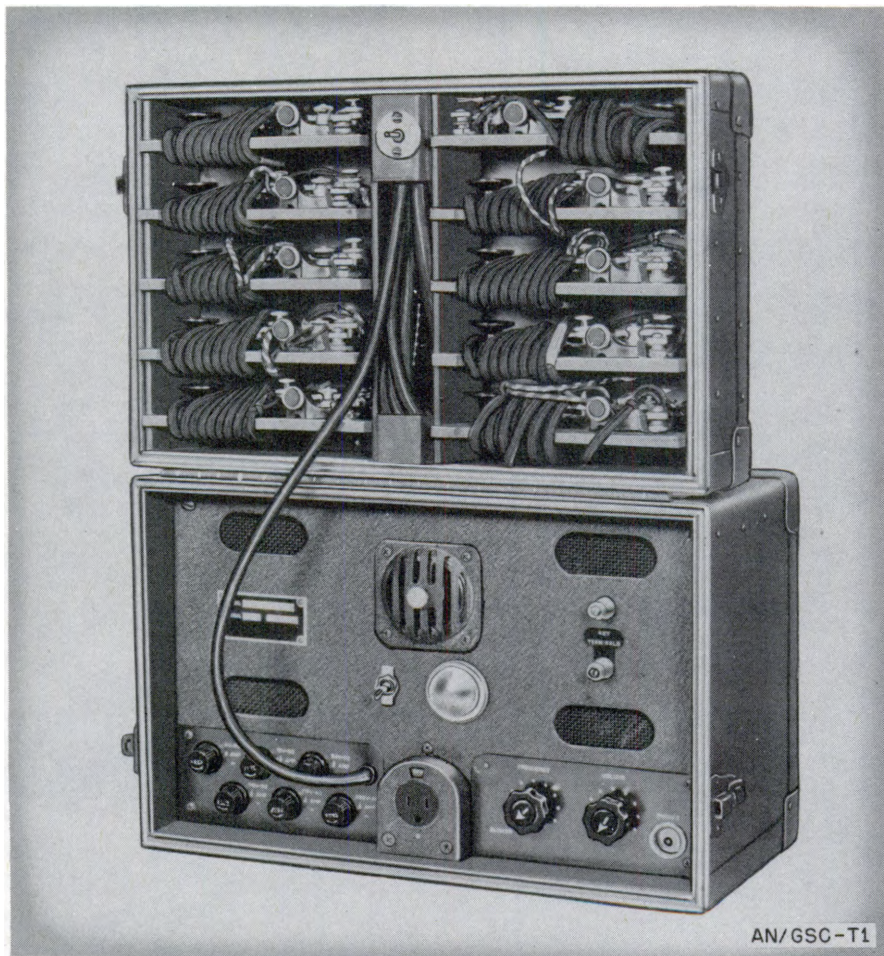

Figure 19. Code Training Set AN/GSC-T1.

Status: Standard. *Stock No.:* 4A401-T1. *Reference:* TM 11-437.

Code Training Set AN/GSC-T1 is a portable device consisting of all equipment necessary to practice transmission and reception of International Morse Code Signals by both visual and audible methods, so that operators may maintain code speed after school training is completed. All the equipment is contained in one carrying case. This equipment is sufficient to allow 10 operators to practice at one time.

TECHNICAL CHARACTERISTICS

POWER: 115 or 230 v, ac, 50 to 60 cps; or 6, 12, 24, or 115 v, dc, with vibrators.

WEIGHTS AND DIMENSIONS

	<i>Dimensions (in.)</i>	<i>Weight (lb)</i>	<i>Volume (cu ft)</i>
Unpacked.....	17 x 10¼ x 13	40	1.31
Export pack.....	17½ x 20½ x 17	100	3.53



Figure 20. Flash Ranging Set AN/GTC-1.

Status: Standard. **Stock No.:** 4G699-1. **Reference:** TM 11-5516.

Flash Ranging Set AN/GTC-1 is a complete, portable, all-weather telephone system designed for use by field artillery observation units. Enemy gun flashes are observed by outpost observers who report the azimuth of the flashes to the central operator of this equipment. The information is then transmitted to the battalion headquarters over the special trunk line. The set includes all components and parts required for individual, independent operation of the telephone system (except field wire and batteries).

TECHNICAL CHARACTERISTICS

OUTPOST STATIONS: 6

CIRCUITS PROVIDED: Combination line circuits—6.
Trunk circuit—1.
Operator's telephone circuit—1.
Ringing circuit—1.
Battery circuit—1.
Panel lamp circuit—1.
Night-alarm circuit—1.

POWER:

Battery operated—4 Batteries
BA-23, 1 Battery BA-26.

PRINCIPAL COMPONENTS

Item	Dimensions (in.)	Weight (lb)
Switchboard SB-4/GTC---	13 x 21½ x 19¾	72
Battery Case CY-386/GTC-1.	7½ x 15½ x 5¾	4¾
7 Control Box C-100/GTC-1.	5 x 2 x 2¾	2
7 Telephone EE-8-B-----	9½ x 7½ x 3½	9½
Handset TS-9-----	3½ x 9½ x 2¾	1
Head Set HS-30/U-----	-----	½
Chest Set H-12/GT-----	-----	-----
Microphone T-45-----	-----	-----
Terminal Strip TM-184---	1¾ x 15¼ x 3¾	4½
6 Axle Assembly RL-27-C	32½ x 1¾ (diam)	7
Ground Rod GP-16-----	24 x ½ (diam)	-----

WEIGHT AND VOLUME

	Total weight (lb)	Total volume (cu ft)
Export pack-----	300	27.7



Figure 21. Public Address Set AN/PIQ-1

Status: Standard. *Stock No.:* 6C198-1. *Reference:* TM 11-2566.

Public Address Set AN/PIQ-1 is a portable, electroacoustic system consisting of an amplifier, a battery tray, a loudspeaker, a microphone, and other accessories. Public Address Set AN/PIQ-1 is used to address small groups of personnel under training or tactical conditions.

TECHNICAL CHARACTERISTICS

FREQUENCY RESPONSE: 250 to 5,000 cps, flat within 2½ db.
MAX. GAIN: 35 db at 1,000 cps.
COMMUNICATION RANGE: 600 ft with 100 percent intelligibility.
AMPLIFIER POWER OUTPUT: 1½ w with not more than 10 percent distortion.
POWER: Battery operated—3 Batteries BB-206/U.

PRINCIPAL COMPONENTS

Item	Dimensions (in.)	Weight (lb)
Amplifier AM-74/PIQ-1.....	4¾ x 9¾ x 2¾	3.4
Battery Tray MT-352/PIQ-1.	4¾ x 14½ x 2¾	5
Loudspeaker LS-110/PIQ-1..	10¾ x 5 (diam)	1.75
Microphone M-8/PIQ-1.....	3¾ x 3½ x 62	.9
Tripod MT-353/PIQ-1.....	55 (extended)	2.25
Transformer TF-102/PIQ-1..	4¾ x 5¼ x 3¾	2

PACKED WEIGHT AND DIMENSIONS

	Dimensions (in.)	Weight (lb)	Volume (cu ft)
Export pack.....	13½ x 13½ x 24½	70	2.57

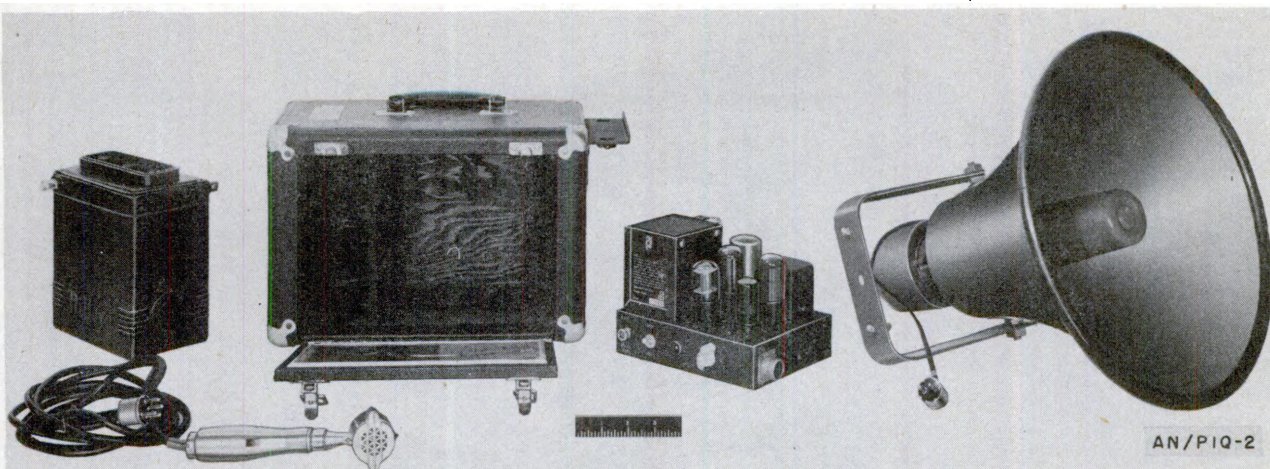

Figure 22. Public Address Set AN/PIQ-2

Status: Limited/Std. *Stock No.:* 6C260-146S.

Public Address Set AN/PIQ-2 is a portable public address equipment consisting of a loudspeaker, an amplifier, a microphone, and all necessary cables and connectors. It is used in amphibious operations and for controlling crowds, prisoners, or rioters, and for other emergencies.

TECHNICAL CHARACTERISTICS

RANGE: Over water—400 yd.
Over land—300 yd.
OUTPUT: 14 w, max.
POWER: 6-v storage battery.

WEIGHTS AND DIMENSIONS

	<i>Dimensions (in.)</i>	<i>Weight (lb)</i>
Unpacked.....	13¼ x 10½ x 7½	39.5
Domestic pack.....	50
Export pack.....	87



Figure 23. Sound Detector Set AN/PNR-1.

Status: Limited/Std. *Stock No.:* 2B2180-1.
Reference: TM 11-2541.

Sound Detector Set AN/PNR-1 is a portable, battery-operated, three-stage audio amplifier. Two pairs of headphones, two microphones, and a recorder jack are provided for listening in on or recording conversations. Sound Detector Set AN/PNR-1 is used to enable the operator to listen to telephone conversations without the knowledge of those speaking. The equipment is adapted for use under four different conditions, as follows:

a. When it is possible to plant a microphone in the room prior to the conversation taking place.

b. When only a wall or panel of an adjoining room is available.

c. When it is desired to listen in on telephone conversations by a direct tap.

d. When it is desired to listen in on telephone conversations by use of induction coil tapping, without actual wire connection.

TECHNICAL CHARACTERISTICS

POWER: Battery-operated—1 Battery BA-31, 2 Batteries BA-63, 1 Battery BA-65.

WEIGHTS AND DIMENSIONS

	Dimensions (in.)	Weight (lb)	Volume (cu ft)
Unpacked	14½ x 11½ x 8¼	20	.80
Export pack	-----	64	3.5



Figure 24. Spotlight Set AN/PVQ-1.

Status: Standard. *Stock No.:* 6Z8370-1. *Reference:* TM 11-394.

Spotlight Set AN/PVQ-1 is a portable kit consisting of a pistol-grip searchlight, a battery, a mounting stanchion, and a carrying case. Spotlight Set AN/PVQ-1 is used to provide light where more illumination is required than can be furnished by a flashlight.

TECHNICAL CHARACTERISTICS

POWER: Battery-operated—1 Battery BA-207/U.
LAMP: One 6- to 8-v, 21 candlepower automobile lamp with bayonet socket.

WEIGHTS AND DIMENSIONS

	Dimensions (in.)	Weight (lb)	Volume (cu ft)
Unpacked	10½ x 5¼ x 8½	3	.88
Export pack		7	4.0



Figure 25. Public Address Set AN/SIQ-1, with packing cases.

Status: Limited/Std. Stock No.: 6C197-1.
Reference: TM 11-2577.

Public Address Set AN/SIQ-1 consists of a rotary converter, an amplifier, a phonograph, four single-unit horn-type speakers, four speaker stands, a microphone, four microphone stands, and all necessary cables and connections. Public Address Set AN/SIQ-1 is used to make announcements over a large area, so that instructional and recreational programs can be broadcast to large audiences.

TECHNICAL CHARACTERISTICS

FREQUENCY RESPONSE.	500 to 5,000 cps.
COMMUNICATION RANGE.	½ mi under ideal conditions.
POWER OUTPUT. POWER:	50 w. 105 to 125 v, ac, 60 cps; 250 w.

WEIGHT AND VOLUME

	Total weight (lb)	Total volume (cu ft)
Export pack.....	692	35



Figure 26. Public Address Set AN/TIQ-2.

Status: Standard. **Stock No:** 6C200-2 (AN/TIQ-2) and 6C200-2A (AN/TIQ-2A). **Reference:** TM 11-2586.

Public Address Set AN/TIQ-2(*) represents AN/TIQ-2 and AN/TIQ-2A. Public Address Set AN/TIQ-2(*) is a six-tube, portable, sound amplification system consisting of an amplifier, a turntable, loudspeakers and stands, a microphone, a headset, and all necessary wire and cords. Public Address Set AN/TIQ-2 is used to serve large audiences. Speech and music are fed into the system by a microphone, a radio input circuit, or a phonograph turntable.

TECHNICAL CHARACTERISTICS

FREQUENCY RANGE: Amplifier—50 to 10,000 cps, flat within 3 db. Microphone—60 to 7,500 cps.

INPUT CHANNELS: 2 high-impedance microphone input circuits.
2 low-impedance microphone input circuits.
100-ohm carbon microphone input circuit.
High-impedance radio input circuit.
100-ohm line input circuit.
100-ohm phonograph input circuit.

OUTPUT CIRCUIT: 250-, 125-, 60-, 30-, and 6-ohm taps for speaker matching.

BOOSTER CIRCUIT: Output circuit tapped at 100 ohms to provide input voltage for additional amplifier when greater audience coverage is desired.

TURNTABLE SPEEDS: 33½ and 78 rpm.

REPRODUCER HEAD: Permanent magnet, removable needle type, 100-ohm impedance.

MICROPHONE OUTPUT. —56 db.

SPEAKER IMPEDANCE. 250-, 500-, 1,000-, and 2,500-ohm windings on transformer primary.

POWER OUTPUT: Speaker—20 w, normal, 25-w peak.
Amplifier—20 w at less than 5 percent distortion.

POWER: 115 or 230 v, ac, 50 to 60 cps.

PRINCIPAL COMPONENTS

Item	Dimensions (in.)	Weight (lb)
Amplifier AM-20/TIQ-2	10 x 16 x 21	75
Turntable MX-39/TIQ-2	10 x 16 x 21	47
2 Loudspeaker LS-103/TIQ-2	25 x 19 (diam)	22 ea
2 Loudspeaker Stand MT-128/TIQ-2.	48 (when collapsed)	18½ ea
2 Microphone M-2/U		¾ ea

PACKED WEIGHT AND VOLUME

	Total weight (lb)	Total volume (cu ft)
Export pack	576	31

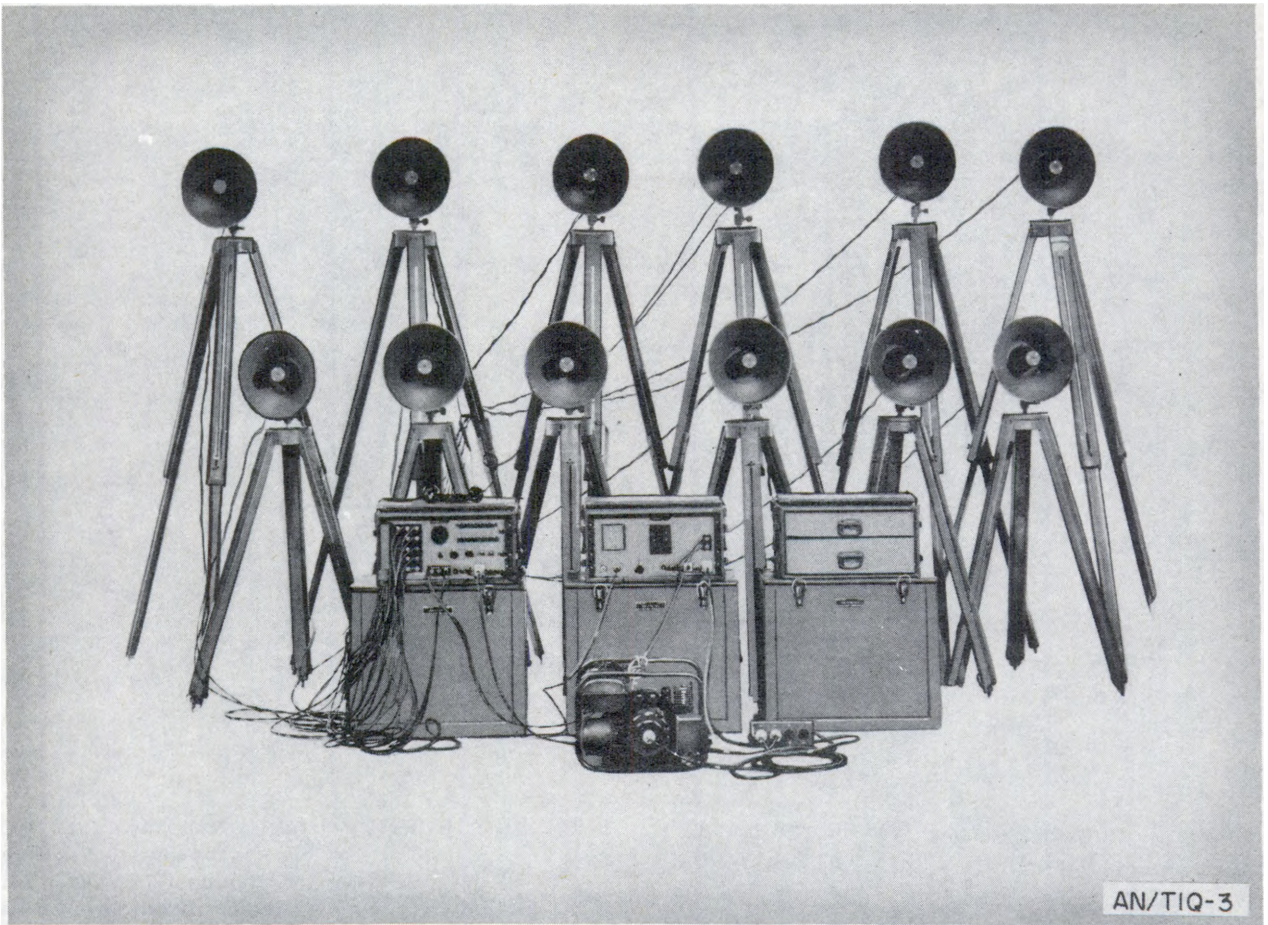

Figure 27. Public Address Set AN/TIQ-3.

Status: Standard. *Stock No.:* 6C200-3. *Reference:* TM 11-2531.

Public Address Set AN/TIQ-3 is a transportable public address system designed for fixed operation. It consists of a control unit, an amplifier, a power unit, a handset, and 12 loudspeakers. Public Address Set AN/TIQ-3 is used to serve very large areas. The handset or a monitor speaker on the control unit permits two-way communication with selected speakers or may be used to communicate over the whole system. A tone generator provides a constant, intermittent, or warble tone to be sent over the system for signaling.

TECHNICAL CHARACTERISTICS

FREQUENCY RANGE: 50 to 10,000 cps.
POWER OUTPUT: 50 w at less than 10 percent distortion.
POWER: 115 or 230 v, ac, 60 cps, or from Power Unit PE-214-B.

PRINCIPAL COMPONENTS

Item	Dimensions (in.)	Weight (lb)
Amplifier AM-34/TIQ-3	8 3/4 x 19 x 13	65
Control Unit C-104/TIQ-3	8 3/4 x 19 x 13	40 1/4
12 Loudspeaker LS-104/TIQ-3	15 1/2 x 13 3/8 (diam)	20 1/4 ea
12 Stand MT-128/TIQ-2	84 1/2 (height)	19 ea
Power Unit PE-214-B	12 1 3/16 x 14 3/8 x 17 3/4	60 1/4

PACKED WEIGHT AND VOLUME

	Total weight (lb)	Total volume (cu ft)
Export pack	1,325	67.4



Figure 28. Public Address Set AN/TIQ-8.

Status: Limited/Std.

Public Address Set AN/TIQ-8 is a portable 50-watt sound system designed for use in covering large, outside areas. The equipment, with the exception of the microphone and stand, is contained in two carrying cases.

TECHNICAL CHARACTERISTICS

AMPLIFIER FREQUENCY RESPONSE.	30 to 10,000 cps, flat within 2 db.
MICROPHONE INPUTS.	2 provided; ea 2 meg impedance for crystal or high-impedance dynamic microphone.
PHONOGRAPH INPUT.	500,000 ohms impedance.
AMPLIFIER GAIN:	Microphone input—130 db. Phonograph input—92 db.

HUM LEVEL:
OUTPUT IMPEDANCES.
AUDIO POWER OUTPUT.

50 db below rated output.
2, 4, 83, 125, 166, 250, and 500 ohms.
50 w with not more than 5% distortion in the secondary of the output transformer when terminated with nominal load impedance.
240 w max.

POWER CONSUMPTION.
POWER INPUT:

110 to 125 v, ac, 50 to 60 cps.

PRINCIPAL COMPONENTS

- 1 Webster model 18-50 amplifier.
- 1 Webster model S4546-1 crystal microphone w/20-ft shielded cable and plug.
- 1 Webster model S4549 microphone stand.
- 2 Webster model S4638 heavy-duty, 12-in. permanent magnet loudspeakers.

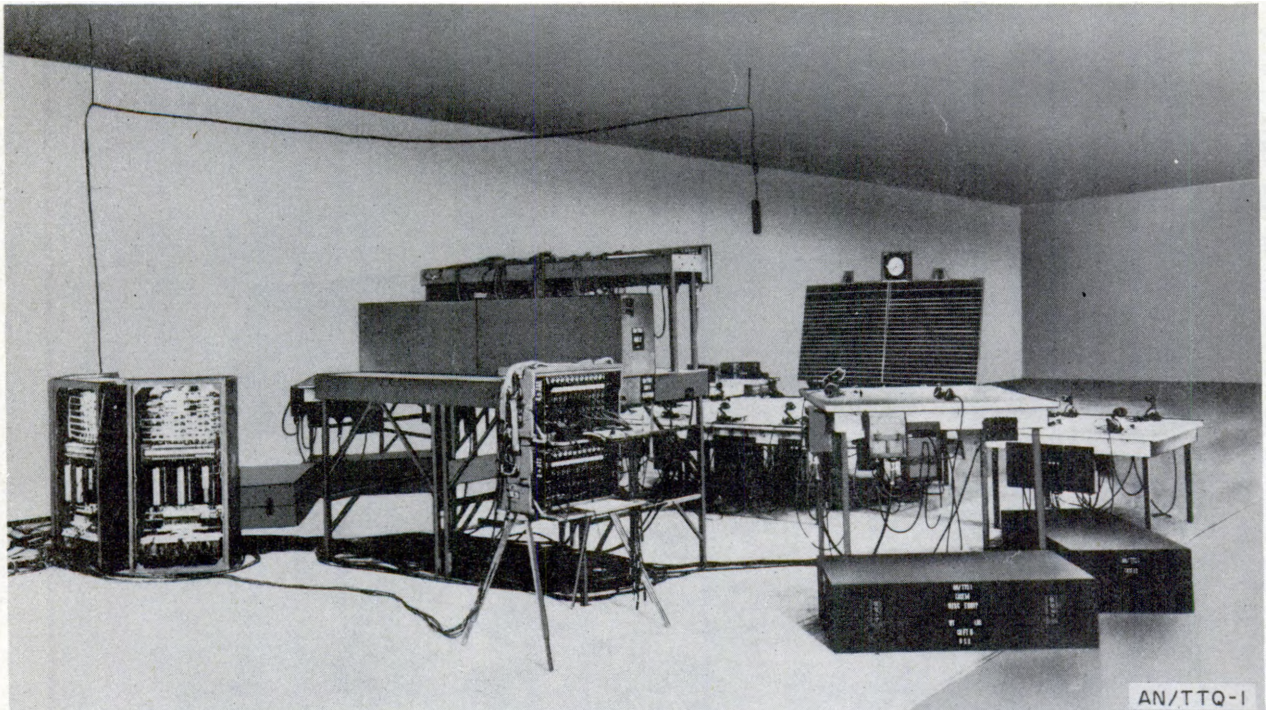

Figure 29. Operations Center AN/TTQ-1.

Status: Standard. *Stock No.:* 4C5990-1. *Reference:* TM 11-438.

Operations Center AN/TTQ-1 consists of equipment which is installed at a central point in an air warning system for receiving information on flights and for passing information for fighter control. Telephone, power and lighting equipment, furniture, and plotting material make up the assembly. Operations Center AN/TTQ-1 is used in fixed installations as a Wing Filter Room, Wing Operations Room, Fighter Control Area Operations Room, and Combined Filter-fighter Control Area Operations Room. The components may be mounted ready for operation in trucks and trailers to function as a Wing Filter Center, Fighter Control Area Center, and Combined Filter-fighter Control Area Operations Center.

TECHNICAL CHARACTERISTICS

POWER:

115 v, ac, 60 cps or from Power Unit PU-8/TTQ-1.
One 24 v, 40 amp-hr storage battery.

PRINCIPAL COMPONENTS

Item	Dimensions (in.)
4 Plotting Table FN-3/TTQ.....	47 $\frac{3}{4}$ x 47 $\frac{3}{4}$ x 28
2 Platform Table FN-2/TTQ.....	46 x 12 x 28
Plotting Kit PT-11/TTQ.....	
Telephone Power Unit SB-26/TTQ.....	48 x 24 x 12
28 Line Unit TA-10/TTQ.....	4 $\frac{1}{2}$ x 7 $\frac{1}{2}$ x 9
2 Relay Unit RE-8/TTQ-1.....	19 $\frac{1}{4}$ x 8 $\frac{1}{2}$ x 5 $\frac{1}{2}$
Relay Unit RE-24/TTQ.....	48 x 24 x 12
3 Control Unit C-199/TTQ.....	6 $\frac{1}{2}$ x 4 $\frac{1}{2}$ x 5 $\frac{1}{2}$
2 Switchboard BD-72.....	
36 Telephone Unit TA-9/TTQ.....	7 $\frac{1}{2}$ x 9 x 4 $\frac{1}{2}$
Ringer TA-13/TT.....	
Timing Indicator ID-110/TTQ.....	
7 Headset HS-30-U.....	
7 Chest Set HS-18-()/U.....	
2 Power Unit PU-8/TTQ-1.....	22 x 44 x 33
Test Set TS-380/U.....	7 $\frac{1}{2}$ x 3 x 4

PACKED WEIGHT AND VOLUME

	Total weight (lb)	Total volume (cu ft)
Export pack.....	6, 500	260

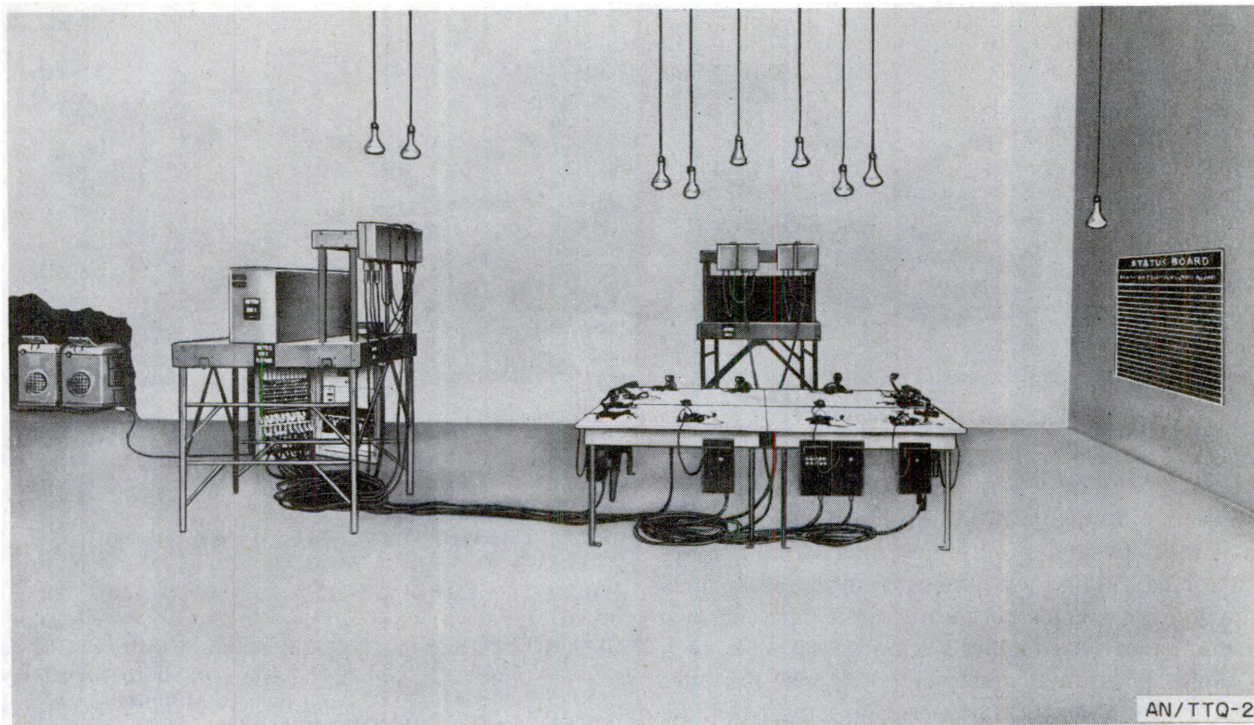

Figure 30. Operations Center AN/TTQ-2.

Status: Standard. *Stock No.:* 4C5990-2. *Reference:* TM 11-448.

Operations Center AN/TTQ-2 consists of equipment which is used for receiving intelligence concerning activities in an area, for displaying intelligence for quick analysis, and for operational communications. Telephone, power and lighting equipment, furniture, and plotting material make up the assembly. Operations Center AN/TTQ-2 is used as an anti-aircraft operations room; it serves as the tactical or battle headquarters of an anti-aircraft defense.

TECHNICAL CHARACTERISTICS

POWER: 115 v, ac, 60 cps or from Power Unit PU-8/TTQ-1.
One 24-v, 40 amp-hr storage battery.

PRINCIPAL COMPONENTS

Item	Dimensions (in.)
2 Plotting Table FN-3/TTQ.....	47¾ x 47¾ x 28
2 Platform Table FN-2/TTQ.....	46 x 12 x 28
Plotting Kit PT-11/TTQ.....	
Telephone Power Unit SB-26/TTQ....	48 x 24 x 12
14 Line Unit TA-10/TTQ.....	4½ x 7½ x 9
Relay Unit RE-8/TTQ-1.....	19¾ x 8½ x 5½
Relay Unit RE-24/TTQ.....	48 x 24 x 12
3 Control Unit C-199/TTQ.....	6½ x 4½ x 5½
Switchboard BD-95.....	
20 Telephone Unit.....	7½ x 9 x 4½
Ringer TA-13/TT.....	
Timing Indicator ID-110/TTQ.....	
7 Headset HS-30-U.....	
7 Chest Set H-18-()/GT.....	
2 Power Unit PE-197.....	44 x 22¼ x 30
Multimeter TS-380/U.....	7½ x 3 x 4

PACKED WEIGHT AND VOLUME

	Total weight (lb)	Total volume (cu ft)
Export pack.....	4,595	163

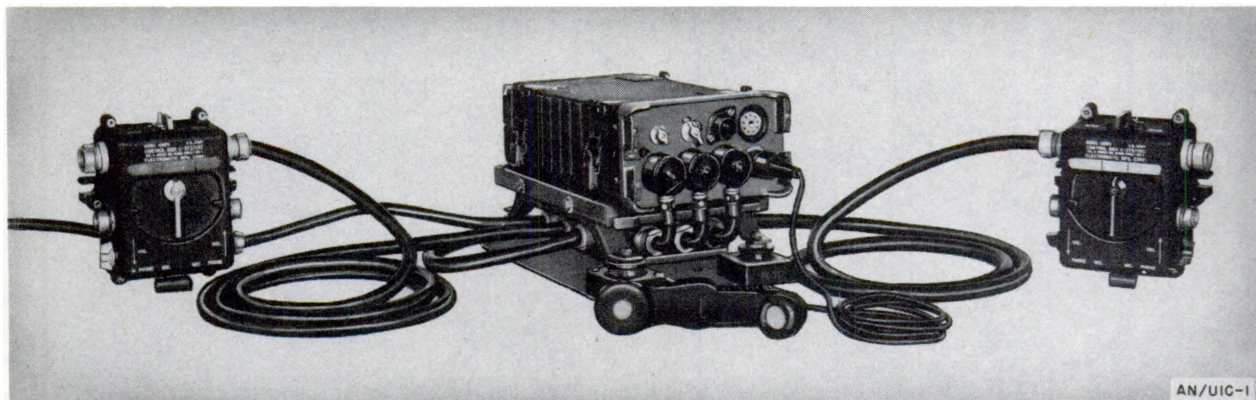

Figure 31. Intercommunication Set AN/UIC-1.

Status: Standard. Reference: TM 11-2643.

Intercommunication Set AN/UIC-1 is a combination of an audio amplifier and two or more control boxes; the equipment is intended to provide two-way voice communication between two or more positions in large armored vehicles such as tanks, personnel carriers, etc. It also provides facilities for monitoring or transmitting over one or more radio sets when the intercommunication set is employed in conjunction with other systems which use such sets. Telephone lines, microphones, or other radio outputs may be used as input, and the output may be through headphones, the receivers of handsets, or loudspeakers. The system provides for the mixing of three signals. The audio accessories are not components of the basic set, but are supplied with various installation kits for different vehicles.

TECHNICAL CHARACTERISTICS

SIGNAL CHANNELS:	Chan 1	Chan 2	Chan 3
	Set 1 plus INT	Set 2 plus INT	Set 1 plus Set 2 plus INT
SIGNAL INPUT LEVELS, V MAX.	5	5	5
SIGNAL OUTPUT LEVELS, MW MAX:			
FOR 7-V SIGNAL INTO CHANNEL 1.	350	-----	800
FOR 7-V SIGNAL INTO CHANNEL 2.	-----	350	800

FOR 5-V SIGNAL INTO INT.	350	350	1,800
INPUT IMPEDANCES, OHMS.	1,500	1,500	150
OUTPUT IMPEDANCES, OHMS.	150	150	150 and 600
A-F RESPONSE.....	Flat within 4 db from 400 to 2,500 cps; sharp cut-off beyond these limits.		
OVERLOAD DISTORTION.	10 percent max ea channel.		
CROSSTALK, CHANNELS:			
1 AND 2.....	50 db down, max.		
INPUT VOLTAGE.....	From Power Supply PP-281/GRC—12 v at 3.85 amp.		
	From Power Supply PP-282/GRC—24 v at 2.4 amp.		

PRINCIPAL COMPONENTS

Item	Dimensions (in.)	Weight (lb)
AF Amplifier AM-65/GRC	4¼ x 12½ x 7⅞	15.5
2 Control Box C-375/VRC	6⅛ x 3¼ x 7	3.25
Mounting MT-300/GR	3⅛ x 13 x 8⅛	10.0
Power Supply PP-281/GRC or Power Supply PP-282/GRC.....	4¼ x 5¼ x 2⅛	5.5

WEIGHTS AND VOLUMES

	Total weight (lb)	Total volume (cu ft)
Unpacked.....	38.3	.78
Export pack.....	71	1.72



Figure 32. Public Address Set AN/UIQ-1.

Status: Standard. *Stock No.:* 6C200-1. *Reference:* TM 11-2505.

Public Address Set AN/UIQ-1(*) represents AN/UIQ-1 and AN/UIQ-1A. Public Address Set AN/UIQ-1(*) is a portable electroacoustic system consisting of two amplifiers, a multiunit horn-type speaker, a speaker mounting stand, two power units, microphones, and all necessary interconnecting cables. Public Address Set AN/UIQ-1(*) is used to address large groups of personnel over wide areas and under adverse conditions. It is used to direct landing operations, to command ground operations from an airplane, to issue orders under combat conditions over wide areas, and to address enemy personnel on the battlefield.

TECHNICAL CHARACTERISTICS

FREQUENCY RANGE: 800 to 5,000 cps.

COMMUNICATION 2 mi, max.

RANGE.

POWER OUTPUT: 350 w.

POWER: From Power Unit PE-75—115 to 127 v, 1c, 60 cps.

PRINCIPAL COMPONENTS

Item	Dimensions (in.)	Weight (lb)
Amplifier MC-225.....	11¼ x 17½ x 21..	157
Loudspeaker B-12.....	12 x 16¼ (diam)..	111
Stand.....	44 (height).....	19
2 Power Unit PE-75.....	26½ x 19½ x 36...	330 ea



Figure 33. Public Address Set AN/UIQ-3.

Status: Standard. *Stock No.:* 6C199-3. *Reference:* TM 11-2560.

Public Address Set AN/UIQ-3 is a portable electroacoustic system consisting of an amplifier, a multiunit horn-type speaker, a speaker mounting stand, a microphone, and the necessary interconnecting cables. All parts of the equipment are corrosion resistant. Public Address Set AN/UIQ-3 is used to address large groups of personnel over wide areas and under adverse conditions. It is used to direct landing operations, to command ground operations, to issue orders under combat conditions over wide areas, and to address enemy personnel on the battlefield.

TECHNICAL CHARACTERISTICS

FREQUENCY RESPONSE: 800 to 5,000 cps.
COMMUNICATION RANGE: 2 mi, max.
POWER OUTPUT: 175 w, normal, 350 w, peak.
POWER: 115 to 127 v, ac, 60 cps.

PRINCIPAL COMPONENTS

Item	Dimensions (in.)	Weight (lb)
Amplifier MC-225.....	11¾ x 17½ x 21	157
Speaker AA-7.....	24½ x 18¼ x 23¼	205
Stand.....	44 (length)	19

PACKED WEIGHT AND VOLUME

	Total weight (lb)	Total volume (cu ft)
Export pack.....	511	13.8

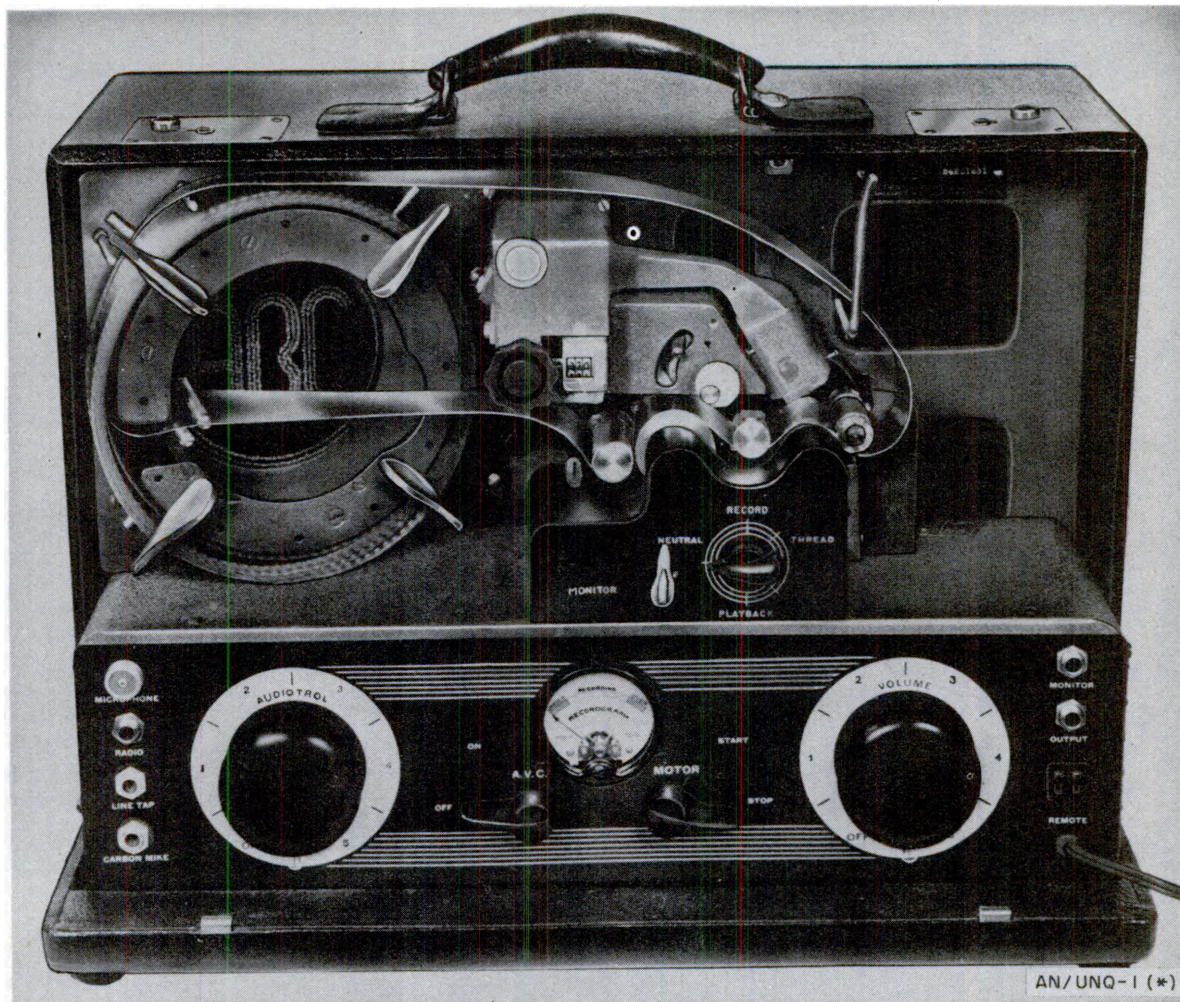

Figure 34. Sound Recording Set AN/UNQ-1.

Status: Standard. Stock No.: 6C274-1. Reference: TM 11-2522.

Sound Recording Set AN/UNQ-1(*) represents AN/UNQ-1 and AN/UNQ-1A. Sound Recording Set AN/UNQ-1(*) is a portable sound recording and play-back machine which utilizes 35-mm non-inflammable cellulose-acetate film as the recording medium. A microphone, crystal earphones, a telephone tap cord, and a kit of tools are included with the equipment. Two hundred cartons, each containing a 50-foot length of film, are shipped with it. Sound Recording Set AN/UNQ-1(*) is used to record conferences, radio programs, speeches, telephone conversations, or any sound within its frequency range. It may also be used to pick up and amplify weak sounds and emit those amplified sounds from its loud-speaker. The set may be used to address large audiences.

TECHNICAL CHARACTERISTICS

RECORDING MATERI- 35-mm cellulose-acetate film.

AL.

RECORDING CAPACITY: 1½ hr.

FREQUENCY RANGE: 150 to 4,000 cps at 60 fpm film speed. Narrower at 40 fps.

GAIN: Microphone terminal—114 db.
Radio input—85 db.

POWER: 110 v, ac, 50 to 60 cps.

MODEL WEIGHTS AND DIMENSIONS

Item	Dimensions (in.)	Weight (lb)
Sound Recording Set AN/UNQ-1.	16 x 9.6 x 19	53
Sound Recording Set AN/UNQ-1A.	16 x 9.6 x 19	48

PACKED WEIGHT AND DIMENSION¹

	Dimension (in.)	Weight (lb)	Volume (cu ft)
Export pack-----	22 x 42½ x 26½	192	14

¹ The recording set and film are packed in two separate boxes. Dimensions are for each box, weight and volume for both.

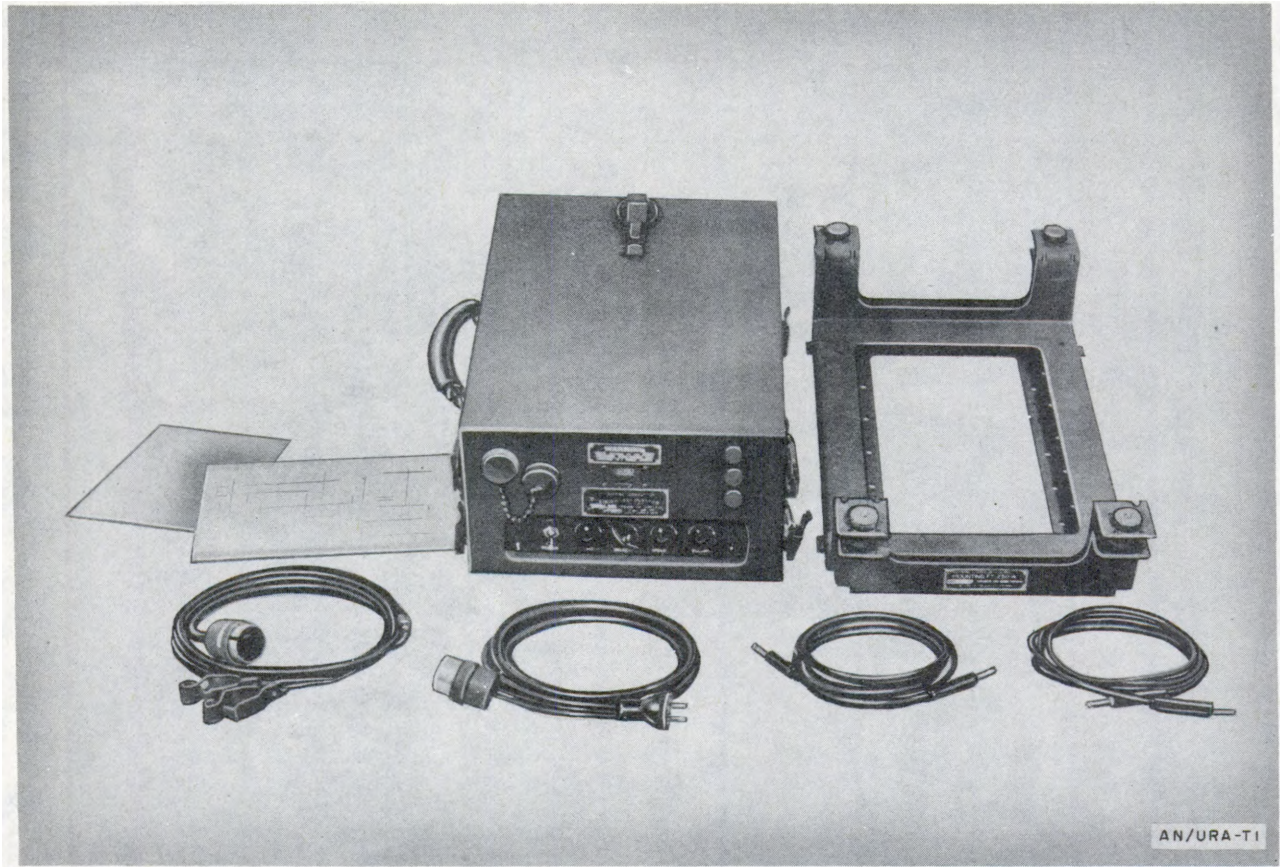

Figure 35. Training Generator AN/URA-T1.

Status: Standard. Stock No.: 2S5501-T1. Reference: TM 11-2509.

Training Generator AN/URA-T1 is a device which simulates several types of electrical interference encountered by a radio operator in receiving messages. It is designed to train the operator to read signals through this interference by mixing the generator's output with code-oscillator signals fed to a standard practice table. In field training, the generator may be used to modulate a standard radio transmitter, familiarizing operators in a net with several types of interference which may be encountered under combat conditions.

TECHNICAL CHARACTERISTICS

INTERFERENCE PRODUCED. Tones—A repeated series of five notes creating a sound similar to that produced by bagpipes.
Noise—A hissing, crackling sound simulating static noise heard in a receiver operating

near high-tension lines or sparking electrical equipment.
Random keying—A continuous series of meaningless dots and dashes.

JACKS PROVIDED: TRANSMITTER—
1-v output at 200 ohms for tone.
1.25-v output at 200 ohms for noise operation.
OUTPUT—1.5 w at 50 to 500 ohms; may only be used on 60-cps-a-c source.
MICROPHONE—Enables operator to modulate a transmitter from training generator.
POWER: 110 v, ac, 50 to 60 cps or 6- or 12-v battery.

PRINCIPAL COMPONENTS

Item	Dimensions (in.)	Weight (lb)
Modulator MD-22/URA-T1.	7½ x 13¾ x 15½	36.4
Mounting FT-250-()	4¾ x 12½ x 20	11.25

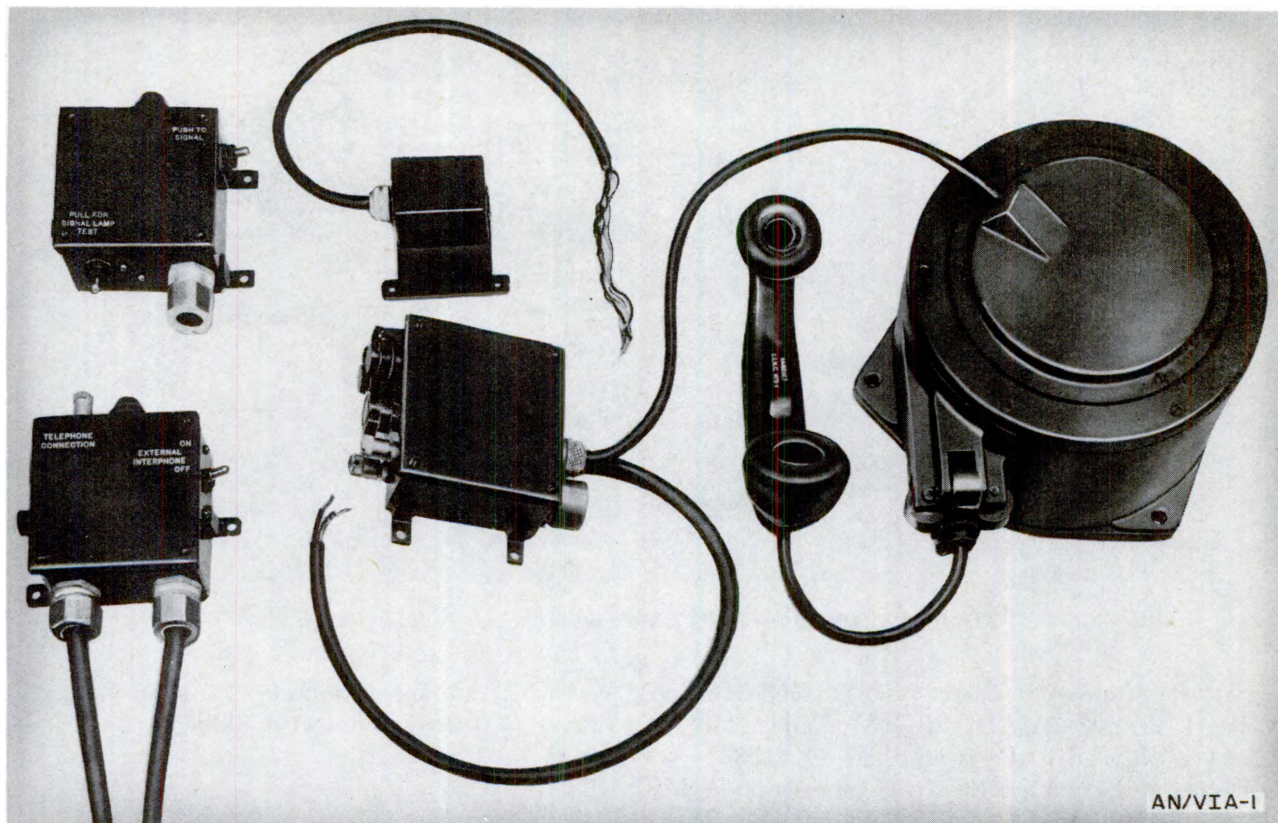

Figure 36. Auxiliary Interphone Equipment AN/VIA-1.

Status: Standard.

Auxiliary Interphone Equipment AN/VIA-1 consists of a rugged handset and a spring-loaded reel containing 40 feet of cable, mounted in an external housing provided in armored vehicles. Through a switch within the vehicle, the handset may be connected to the interphone system of the vehicle. Auxiliary Interphone Equipment AN/VIA-1 is used to extend the interphone sys-

tems of armored vehicles to the outside of the vehicle to provide facilities for communication between crew members and accompanying foot troops.

U/w Medium Tank M46.

TECHNICAL CHARACTERISTICS

POWER: Operates from 24-v vehicular storage battery.

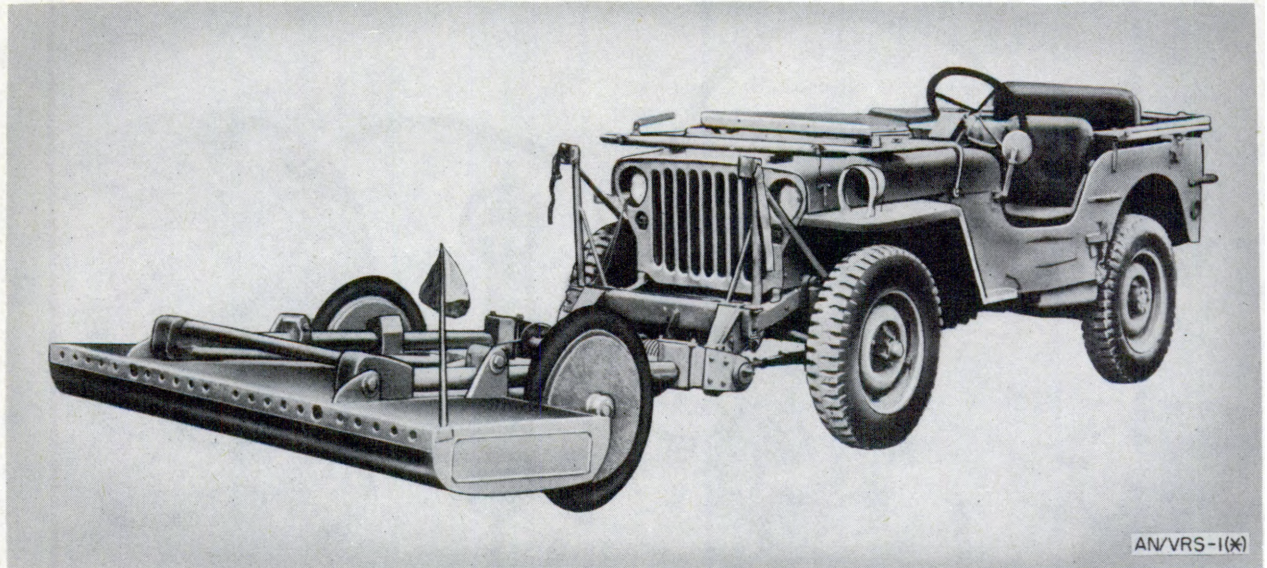

Figure 37. Detector Set AN/VRS-1, with boom in operating position.

Status: Standard. *Stock No.:* 2S4503-1(AN/VRS-1), 2S4503-1A(AN/VRS-1A), and 2S4503-1B (AN/VRS-1B). *Reference:* TM 11-1138.

Detector Set AN/VRS-1(*) represents AN/VRS-1, AN/VRS-1A, and AN/VRS-1B. Detector Set AN/VRS-1(*) consists of a mine-detecting unit mounted on a jeep, associated electronic equipment mounted between the seats, a control unit on the steering column, and automatic braking and declutching equipment which stops the

jeep when a mine is found. Detector Set AN/VRS-1(*) is used to detect metallic antitank land mines.

TECHNICAL CHARACTERISTICS

- RANGE:** Capable of detecting a buried standard American antitank mine at a distance of 6 in. in reasonably level ground.
- SCOPE:** Detects over a path 6 ft wide.
- POWER:** Operates from jeep battery.

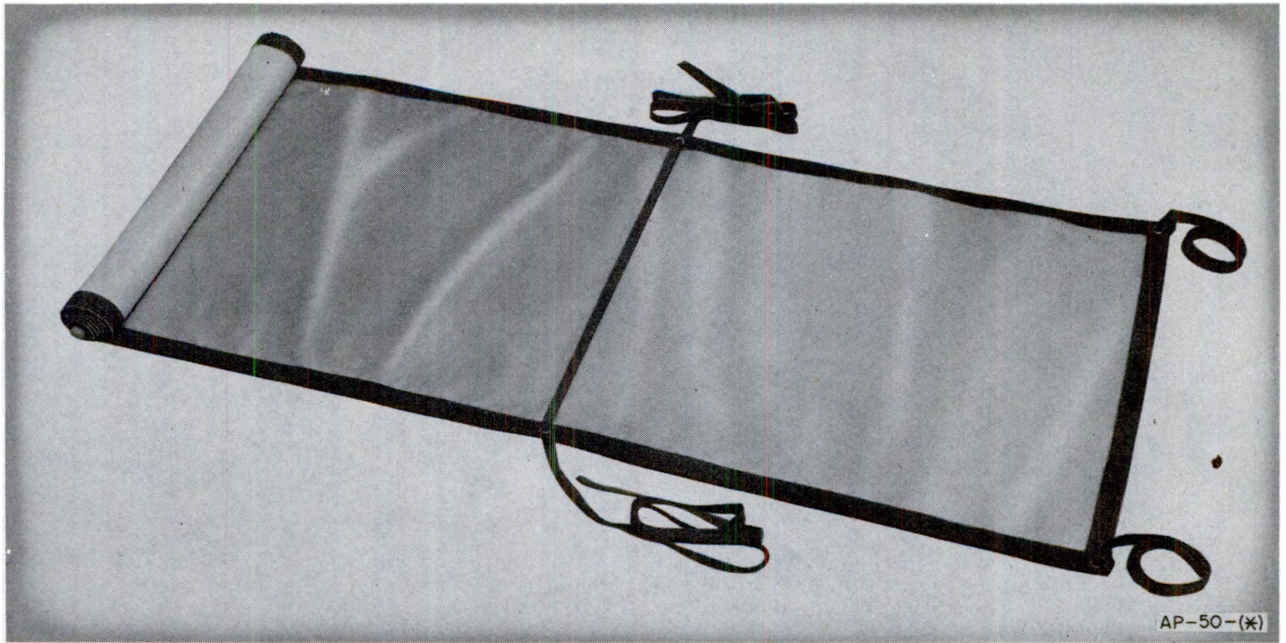

Figure 38. Panel AL-140 of Panel Set AP-50-(*).

Status: Standard. *Stock No.:* 6A3550.

Panel Set AP-50-(*), represents AP-50-A and AP-50-B. Panel Set AP-50-(*), consists of two panels: One panel is white on one side and red on the other side; the second panel is white on one side and yellow on the other side. Each panel is equipped with detachable tie cords and is on a

wooden dowel to facilitate packing. Panel Set AP-50-(*), is used for recognition by friendly air support units.

PRINCIPAL COMPONENTS

<i>Item</i>	<i>Dimensions (ft)</i>
Panel AL-140 in Case CS-150.....	12 x 2 $\frac{1}{8}$
Panel AL-141 in Case CS-150.....	12 x 2 $\frac{1}{8}$



Figure 39. Recorder BC-1016.

Status: Standard. *Stock No.:* 4A1953. *Reference:* TM 11-441.

Recorder BC-1016 is an inked-line, tape-type recorder. It is designed for ink recording of code signals up to 400 words per minute on three-eighths-inch paper tape. The input of the recorder may be connected to a telephone line transmitting radio signals or directly to the output circuit of a radio receiver. The recorder also may be keyed directly. Tape may be added without interfering with the normal operation of the equipment, and, in an emergency, the tape may be used to record four times its normal capacity.

P/o various code practice equipments.

TECHNICAL CHARACTERISTICS

CAPACITY:	1,000 ft of tape per reel or 2 hr at a speed of 8 ft per min.
INPUT SIGNAL:	.75 to 50 v.
POWER:	117 to 170, 210 to 240 v, ac, 50 to 60 cps.
POWER CONSUMPTION.	140 w.

WEIGHTS AND DIMENSIONS

	Dimensions (in.)	Weight (lb)	Volume (cu ft)
Unpacked (in cabinet).	10¼ x 19¼ x 14¾	80	1.7
Unpacked (for rack mount).	8¾ x 19¼ x 14¾	65	1.4

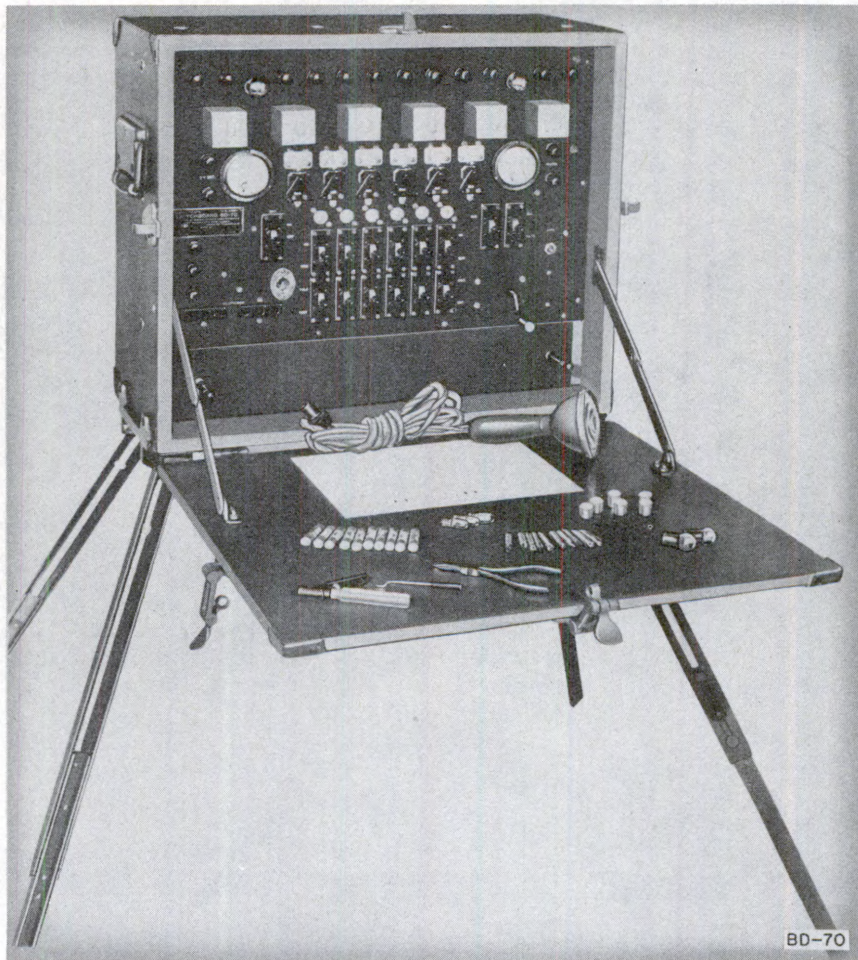

Figure 40. Switchboard BD-70.

Status: Standard. *Stock No.:* 4G4770. *Reference:* TM 11-439.

Switchboard BD-70 is a flash ranging switchboard for use at the central station to permit telephone conversation between the switchboard operator and observers at outlying posts. The switchboard is arranged to connect the operator's telephone set to any of the six field telephone lines equipped with Telephone EE-8-() for talking or ringing. Magneto drop and line lamp signals are provided for each line and serve as signals for an incoming call. A hand generator is provided for ringing the outlying stations.

P/o Flash Ranging Set GR-4-().

TECHNICAL CHARACTERISTICS

RANGE:	10 to 11 mi of Wire W-110-B.
CIRCUITS:	Combination line—6. Operator's telephone—1. Night-alarm—1. Milliammeter test—1. Voltmeter test—1. Ringing (hand generator)—1. Heater—1. Panel lamp—1. Battery supply—1. Protector AR-8.
PROTECTOR:	6.
NUMBER OF PROTECTED PAIRS.	
POWER INPUT:	From 6-v, 80-amp-hr rate storage battery, such as 2 Batteries BB-29.

WEIGHT AND VOLUME

	<i>Weight (lb)</i>	<i>Volume (cu ft)</i>
Unpacked	85	3.6

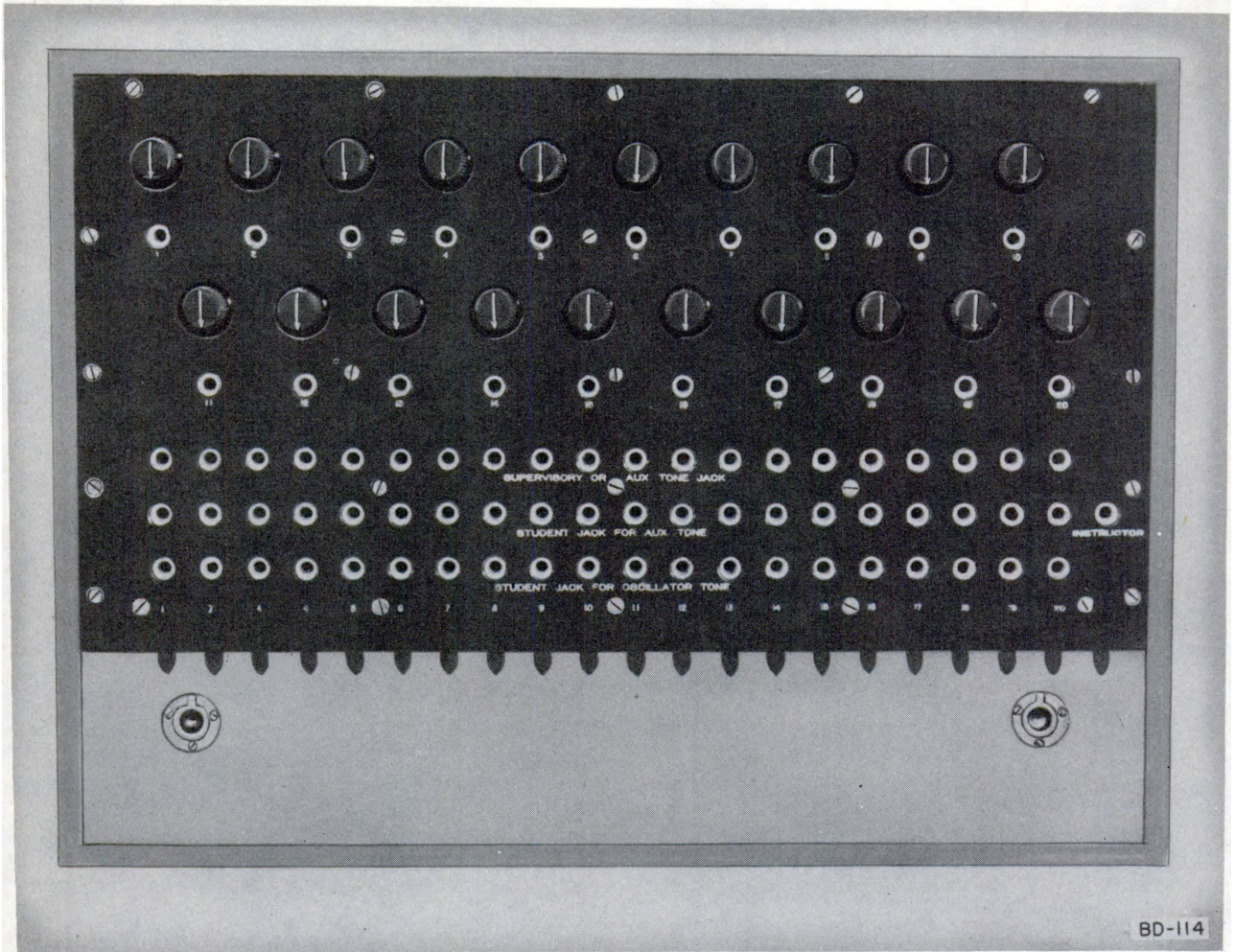

Figure 41. Switchboard BD-114.

Status: Standard. Stock No.: 4A2584. Reference: TM 11-2093.

Switchboard BD-114 is a code practice switchboard designed to facilitate the training of wire and radiotelegraph operators. Radiotelegraph signals are automatically transmitted to the students for receiving practice, steady tone is furnished for sending practice, and combinations of connections can be made which will group the students in practice sending and receiving nets. The instructor is able to monitor the practice transmissions made by the students.

P/o Code Practice Equipments EE-94-(), EE-95-(), and EE-96-().

TECHNICAL CHARACTERISTICS

- JACKS:** Student jacks for oscillator tone—20.
Student jacks for auxiliary tone—20.
Supervisory—20.
Auxiliary tone—20.
Auxiliary—20.
Instructor's jack—1.
- CORDS:** Students' station—20 (black).
Auxiliary patching—12.
Instructor's—1 (white).
Oscillator VO-3-().
- TONE SOURCE:** Ea input terminal applies a min 1,000-ohm load to connected components.
- INPUT TERMINATION:** Ea input terminal applies a min 1,000-ohm load to connected components.
- POWER:** None.

WEIGHT AND DIMENSIONS

	Dimensions (in.)	Weight (lb)	Volume (cu ft)
Unpacked	25½ x 18¾ x 12¼	38.5	4

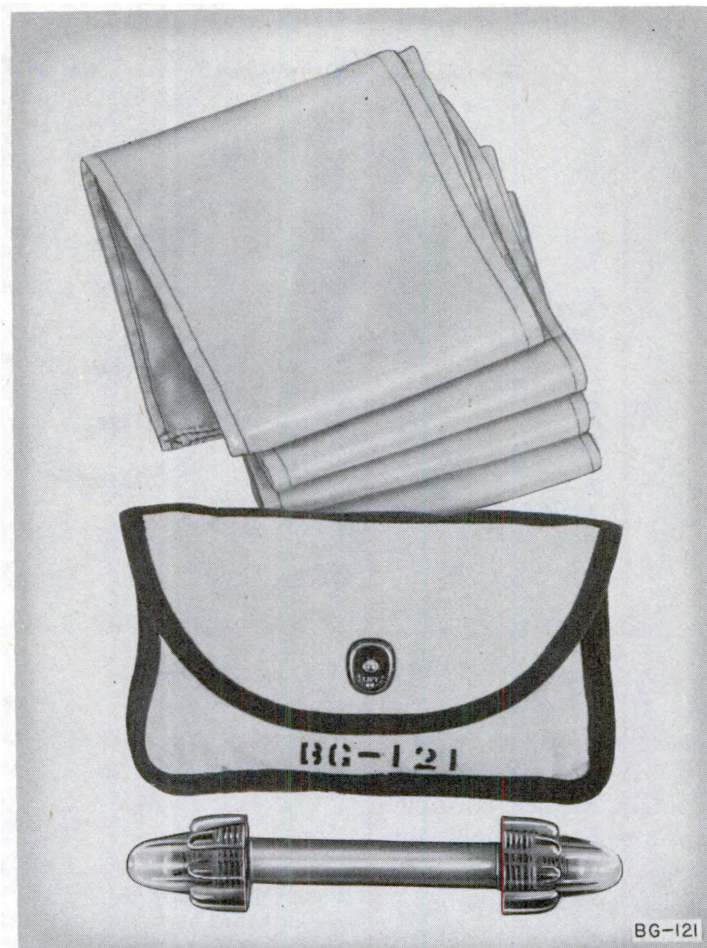

Figure 42. Message Bag BG-121.

Status: Standard. *Stock No.:* 2Z521.

Message Bag BG-121 consists of a white duck pouch to which is attached a yellow acetate rayon streamer. It is used to drop messages to ground troops from aircraft. A flashlight is also attached to the message bag so that it may be visible during its drop when used at night.

TECHNICAL CHARACTERISTICS

POWER FOR FLASHLIGHT: Battery operated—2 Batteries BA-58.

PRINCIPAL COMPONENTS

<i>Item</i>	<i>Dimensions (in.)</i>
Message Bag BG-121.....	7 x 4¾
Flashlight TL-214.....	7⅞ x 1½ (diam)

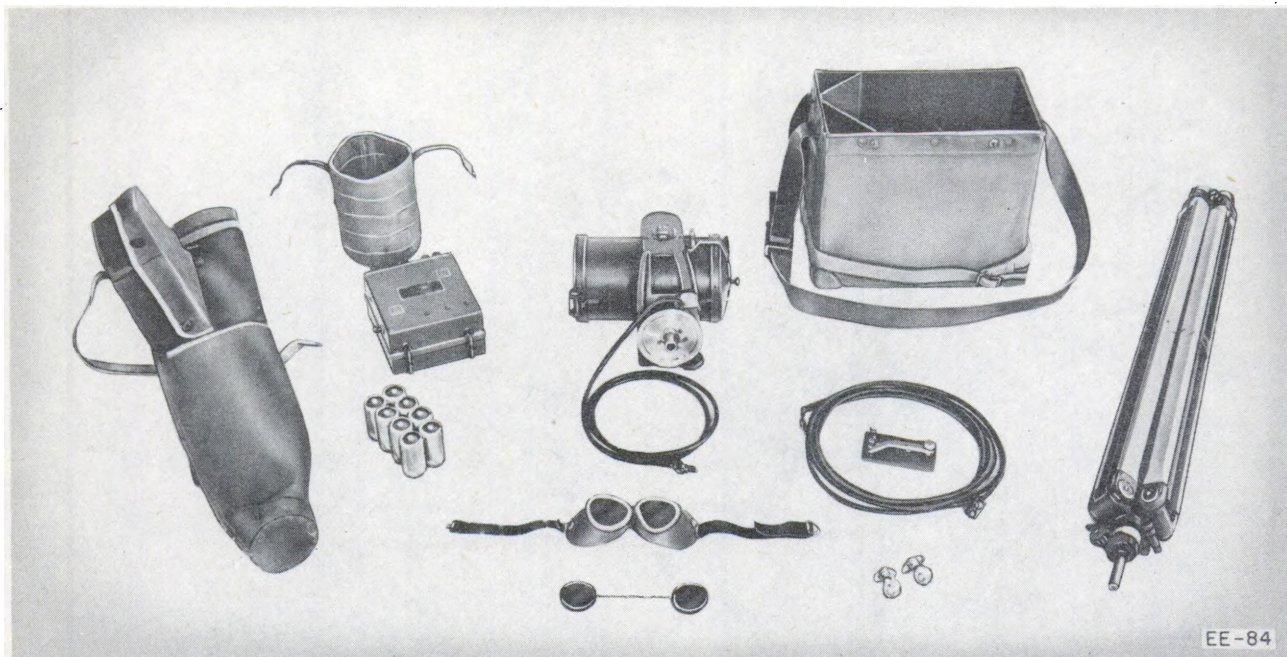

Figure 43. Signal Lamp Equipment EE-84.

Status: Limited/Std. Stock No.: 6B819. Reference: TM 11-391.

Signal Lamp Equipment EE-84 is a portable field equipment for transmitting messages by means of white or red flashes of light in International Morse Code. It consists of a signal lamp, a lamp, a mounting, filters, a tripod, and all necessary accessories.

TECHNICAL CHARACTERISTICS

MAXIMUM RANGE: 5,000 yd in clear bright sunlight.
 BEAM WIDTH: ¼ degrees.
 CODE SPEED: 8 wpm.
 POWER: Battery operated—8 Batteries BA-30.

PRINCIPAL COMPONENTS

Item	Dimensions (in.)	Weight (lb)
Box BX-22.....	7.9 x 6 x 3.2	2.7
2 Filter MC-189.....	½ x 1.9 (diam)	.1 ea
Key J-46.....	4 x 2 x 1	.2
Lamp Mounting FT-159....	8.5 x 7 x 4.5	4.0
Signal Lamp M-132.....	10 x 5½ (diam)	5.5
Tripod, Ord Dept type G....	34 x 4 (diam), folded	7.4
Lamp LM-22.....	2 x 1¼ (diam)	

PACKED WEIGHT AND VOLUME

	Total weight (lb)	Total volume (cu ft)
Export pack.....	70	6

TECHNICAL CHARACTERISTICS

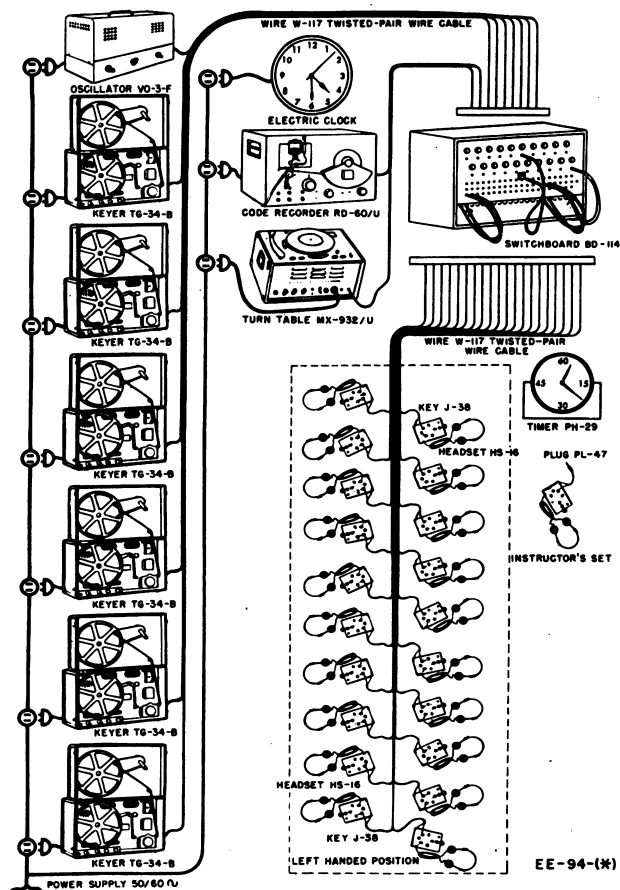

Figure 44. Code Practice Equipment EE-94-F.

Status: Standard. Stock No.: 4A394A (EE-94-A), 4A394B (EE-94-B), 4A394C (EE-94-C), 4A394D (EE-94-D), 4A394E (EE-94-E), and 4A394F (EE-94-F). Reference: TM 11-2093.

Code Practice Equipment EE-94-(*) represents EE-94-A, EE-94-B, EE-94-C, EE-94-D, EE-94-E, and EE-94-F. Code Practice Equipment EE-94-(*) consists of all the electrical components, auxiliary equipments, and supplies which are necessary to train personnel as radiotelegraph operators, as landline operators of circuits terminated with equipment giving signals equivalent in character to radiotelegraph signals, and as operators of any other audio-signaling system using International Morse Code. This equipment is sufficient to train 20 students at one time.

- RECORDER:** Signal input—500 to 5,000 cps; .75 to 25 rms v for low-impedance input, 1.5 to 20 rms v for high-impedance input.
- SWITCHBOARD:** Output impedance—4 ohms. 1,000-ohm load applied by ea. input terminal.
- KEYER:** Output signal—800 cps. Output impedances—4, 8, or 15 ohms.
- OSCILLATOR:** Output frequency—800 cps. Output impedances—4, 8, 12, or 16 ohms.
- TURN TABLE:** Power output—10 w, max. Input channels—
1 high impedance to match crystal phonograph pick-up.
1 low impedance to match magnetic type microphone. Output impedance—4 ohms. Power output—10 w, normal; 12 w, peak. Frequency response—70 to 9,000 cps, flat within -2db.
- POWER:** 115 or 230 v, ac, 50 to 60 cps.

PRINCIPAL COMPONENTS

Item	Dimensions (in.)	Weight (lb)
Switchboard BD-114	25½ x 18¾ x 12¼	38½
Code Recorder RD-60/U	21½ x 17 x 14	135
Turntable MX-932/U	11 x 19½ x 19	46
6 Keyer TG-34-B	10½ ₁₆ x 10½ x 15½ ₁₆	45
Oscillator VO-3-()	12¼ x 10¼ x 7¼	20
21 Headset HS-16	7¼ x 3½ x 2½	1¼ ea
22 Key J-38	7¼ x 3½ x 1¾	1 ea
Timer PH-29	6 x 5½ x 3	2
Code Practice Tape MC-650 in Case CS-158.	14½ x 8½ x 7½	16
Record Set MC-209	12 x 12 x ¼	1
Wire W-117, 2,000 ft	4 x 12 (diam) per 100 ft.	15 ea

PACKED WEIGHT AND VOLUME

	Total weight (lb)	Total volume (cu ft)
Export pack	980	39

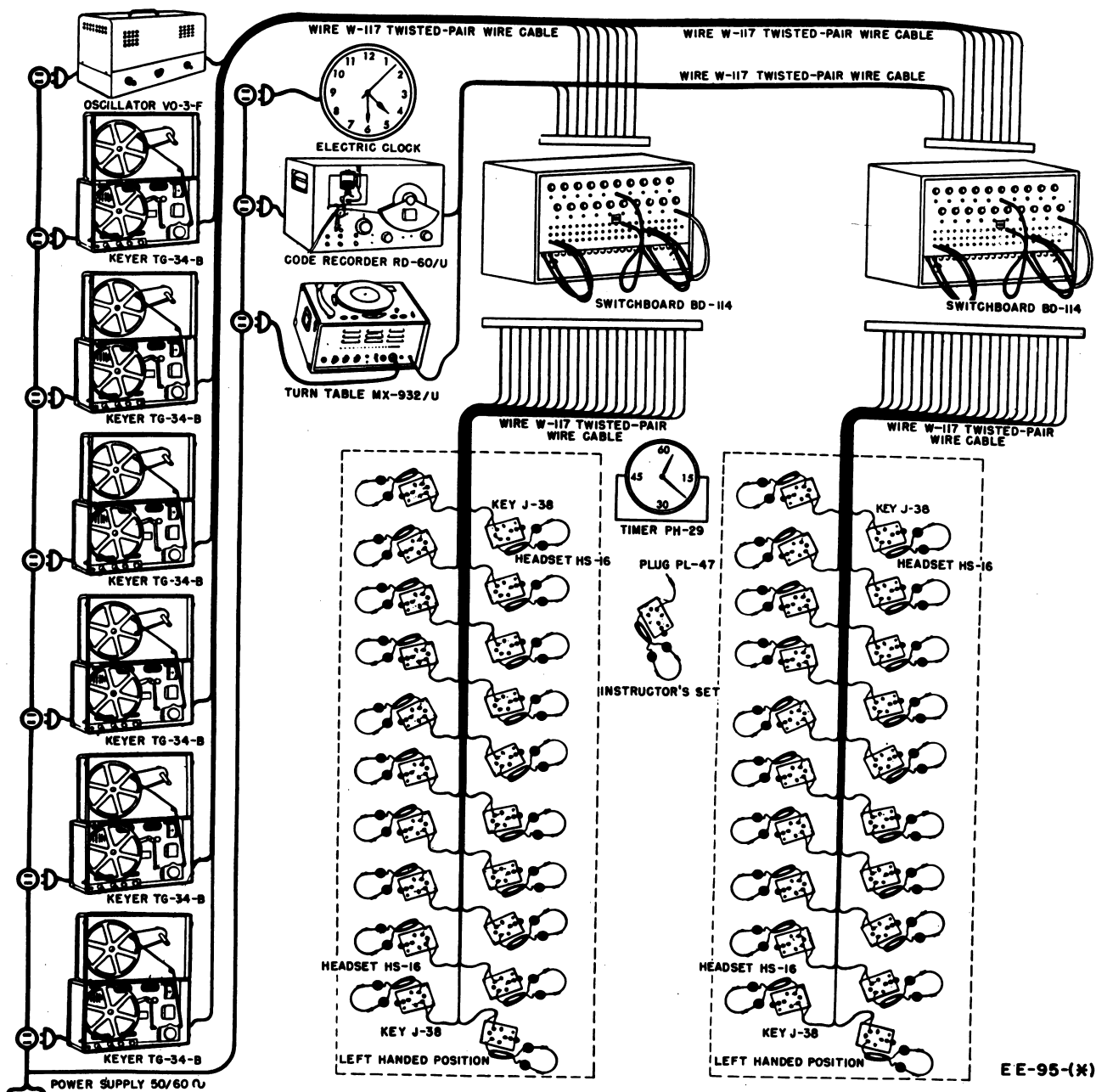

Figure 45. Code Practice Equipment EE-95-F.

Status: Standard. Stock No.: 4A395A (EE-95-A), 4A395B (EE-95-B), 4A395C (EE-95-C), 4A395D (EE-95-D), 4A395E (EE-95-E), and 4A395F (EE-95-F). Reference: TM 11-2093.

Code Practice Equipment EE-95-(*), represents EE-95-A, EE-95-B, EE-95-C, EE-95-D, EE-95-E, and EE-95-F. Code Practice Equipment EE-95-(*), consists of all the electrical components, auxiliary components, and supplies

which are necessary to train personnel as radiotelegraph operators, as landline operators of circuits terminated with equipment giving signals equivalent in character to radiotelegraph signals, and as operators of any other audio-signaling system using International Morse Code. This equipment is sufficient to train 40 students at one time.

TECHNICAL CHARACTERISTICS

RECORDER: Signal input—500 to 5,000 cps;
 .75 to 25 rms v for low-impedance input, 1.5 to 50 rms v for high-impedance input.

SWITCHBOARD: Output impedance—4 ohms.
 1,000-ohm load applied by ea terminal.

KEYER: Output signal—800 cps.
 Output impedance—4, 8, or 15 ohms.

OSCILLATOR: Output frequency—800 cps.
 Output impedances—4, 8, 12, or 16 ohms.

TURNTABLE: Input channels—
 1 high impedance to match crystal phonograph pick-up.
 1 low impedance to match magnetic type microphone.
 Output impedance—4 ohms.
 Power output—10 w, normal; 12 w, peak.
 Frequency response — 70 to 9,000 cps, flat within -2 db.

POWER: 115 or 230 v, ac, 50 to 60 cps.

PRINCIPAL COMPONENTS

<i>Item</i>	<i>Dimensions (in.)</i>	<i>Weight (lb)</i>
2 Switchboard BD-114.....	25½ x 18¼ x 12¼	38½
1 Code Recorder RD-60/U.....	21½ x 17 x 14	135
1 Turntable MX-932/U.....	11 x 19¾ x 19	46
6 Keyer TG-34-B.....	10⅞ x 10½ x 15⅞	45
1 Oscillator VO-3-().....	12¼ x 10¼ x 7¼	20
42 Headset HS-16.....	7¼ x 3½ x 2½	1¼ ea
44 Key J-38.....	7¼ x 3½ x 1¼	1 ea
1 Timer PH-29.....	6 x 5½ x 3	2
1 Code Practice Tape MC-650 in Case CS-158.....	14½ x 8½ x 7½	16
1 Record Set MC-209.....	12 x 12 x ¼	1
1 Wire W-117, 3,000 ft.....	4 x 12 (diam) per 100 ft.	15 ea

PACKED WEIGHT AND VOLUME

	<i>Total weight (lb)</i>	<i>Total volume (cu ft)</i>
Export pack.....	1,640	68

EE-96-(*)

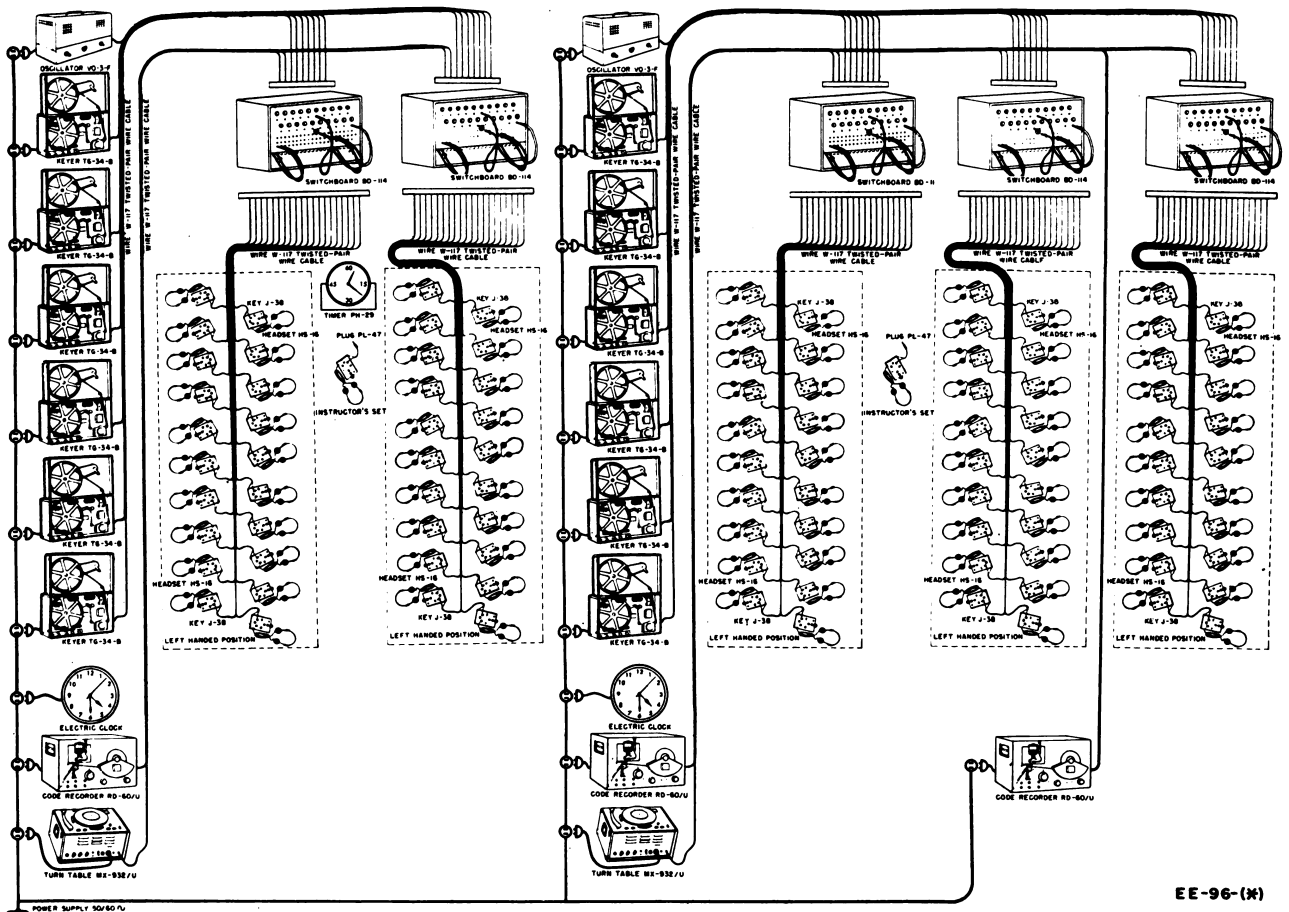

EE-96-(*)

Figure 46. Code Practice Equipment EE-96-F.

Status: Standard. **Stock Nos.:** 4A396A (EE-96-A), 4A396B (EE-96-B), 4A396C (EE-96-C), 4A396D (EE-96-D), 4A396E (EE-96-E), and 4A396F (EE-96-F). **Reference:** TM 11-2093.

Code Practice Equipment EE-96-(*), represents EE-96-A, EE-96-B, EE-96-C, EE-96-D, EE-96-E, and EE-96-F. Code Practice Equipment EE-96-(*), consists of all the electrical components, auxiliary components, and supplies necessary to train personnel as radiotelegraph operators, as landline operators of circuits terminated with equipment giving signals equivalent in character to radiotelegraph signals, and as operators of any other audio-signaling system using International Morse Code. This equipment is sufficient to train 100 students at one time.

TECHNICAL CHARACTERISTICS

RECORDER: Signal input—500 to 5,000 cps; .75 to 25 rms v for low-impedance input, 1.5 to 50 rms v for high-impedance input.

SWITCHBOARD: 1,000-ohm load applied by ea input terminal.

KEYER:

OSCILLATOR:

TURN TABLE:

POWER:

Output signal—800 cps.
 Output impedance—4, 8, or 15 ohms.
 Output frequency—800 cps.
 Output impedance—4, 8, 12, or 16 ohms.
 Power output—10 w, max.
 Input channels—
 1 high impedance to match crystal phonograph pickup.
 1 low impedance to match magnetic type microphone.
 Output impedance—4 ohms.
 Power output—10 w, normal; 12 w, peak.
 Frequency response—70 to 9,000 cps, flat within -2 db.
 115 or 230 v, ac, 50 to 60 cps.

PRINCIPAL COMPONENTS

Item	Dimensions (in.)	Weight (lb)
5 Switchboard BD-114..	25½ x 18¾ x 12¼	38½ ea
3 Code Recorder RD-60/U.	21½ x 17 x 14	135 ea
2 Turntable MX-932/U..	11 x 19⅞ x 19	46 ea
12 Keyer TG-34-B.....	10⅞ x 10½ x 15⅜	45 ea
2 Oscillator VO-3-()..	12¼ x 10¼ x 7¼	20 ea

Item	Dimensions (in.)	Weight (lb)
105 Headset HS-16.....	7¼ x 3½ x 2½	1¼ ea
110 Key J-38.....	7¼ x 3½ x 1¼	1 ea
Timer PH-29.....	6 x 5½ x 3	2
Code Practice Tape MC-650 in Case CS-158.	14½ x 8½ x 7½	16
2 Record Set MC-209...	12 x 12 x ¼	1 ea
Wire W-117, 5,000 ft....	4 x 12 (diam) per 100 ft.	15 ea

PACKED WEIGHT AND VOLUME

	Total weight (lb)	Total volume (cu ft)
Export pack.....	2,768	118

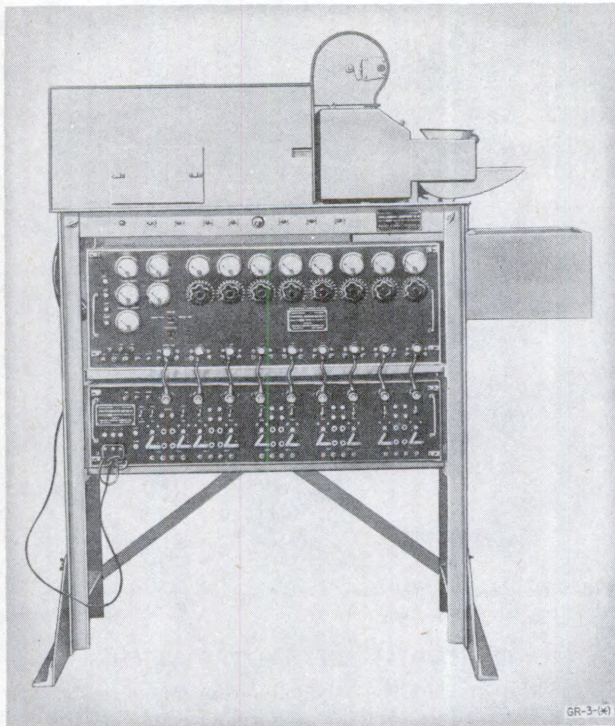

Figure 47. Switchboard BD-62 of Sound Ranging Set GR-3-(*).

Status: Limited/Std. Stock No.: 4G3003 (GR-3, GR-3-B, and GR-3-D), 4G3003A (GR-3-A), and 4G3003C (GR-3-C). Reference: TM 11-444.

Sound Ranging Set GR-3-(*)) represents GR-3, GR-3-A, GR-3-B, GR-3-C, and GR-3-D. Sound Ranging Set GR-3-(*)) consists of oscillograph equipment, a control board, a switchboard, a relay unit, a sound recording set, microphones, telephones, tool and test sets, and carrying cases. Sound Ranging Set GR-3-(*)) is used to detect

the sound of artillery fire or shell detonation and to record the difference in arrival times of the sound wave at a maximum of eight microphone locations.

TECHNICAL CHARACTERISTICS

MICROPHONE SPACING:	2,000 yd apart, max.
SWITCHBOARD CIRCUITS:	1 telephone. 2 outpost. 8 microphone.
CONTROL BOARD CIRCUITS:	8 microphone.
POWER:	8 Batteries BA-26, 20 Batteries BA-28, 40 Batteries BA-30, 8 Batteries BB-29.

PRINCIPAL COMPONENTS

Item	Dimensions (in.)	Weight (lb)
Oscillograph Equipment IE-14-()..	19 x 11 x 36½	90
Control Board BD-85-()..	12½ x 8¾ x 32¾	36
Switchboard BD-62-().....	8½ x 8¾ x 32¾	27.4
Relay Unit BK-9-().....	4½ x 8 x 4½	6
Protector AR-8.....	16 x 12 (diam)	13
Microphone T-21-().....	16 x 6 (diam)	24
Protector AR-4.....	7¾ x 3½ x 3	1
Outpost Unit BE-51.....	2½ x 3¼ x 7	6
Outpost Connecting Box BE-71.	4½ x 2 x 1½	1
Telephone EE-8-().....	2½ x 7¼ x 9½	4
Tool Set TE-6.....		108
Tool Equipment TE-37.....		.75
Test Set EE-65-().....	8 x 10 x 6	14
Test Set I-56-K.....	11 x 13½ x 9½	26

PACKED WEIGHTS AND VOLUMES

	Weight (lb)	Volume (cu ft)
Domestic pack.....	1,510	31.5
Export pack.....	2,600	60

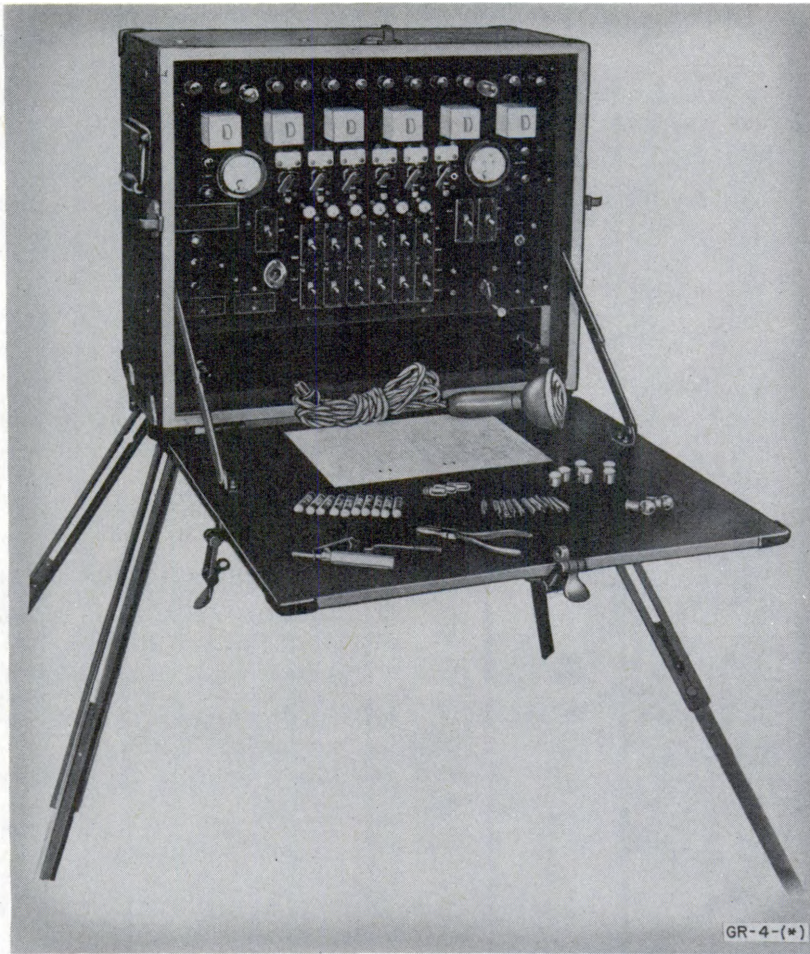

Figure 48. Switchboard BD-70 of Flash Ranging Set GR-4-(*).

Status: Limited/Std. *Stock No.:* 4G3004. *Reference:* TM 11-439.

Flash Ranging Set GR-4-(*) represents GR-4 and GR-4-A. Flash Ranging Set GR-4-(*) consists of a switchboard, field telephones, handsets, headsets, and miscellaneous tools and hardware. Flash Ranging Set GR-4-(*) is used by Field Artillery observation batteries to determine the location of enemy gun positions from reports made by observers of gun flashes.

TECHNICAL CHARACTERISTICS

SWITCHBOARD CIRCUITS. 6 combination line circuits.
1 operator's telephone circuit.
POWER: Battery operated—2 Batteries BB-29, 12 Batteries BA-30.

PRINCIPAL COMPONENTS

Item	Dimensions (in.)	Weight (lb)
Capacitor Unit BE-59-----	3 $\frac{3}{16}$ x 3 x 2	1
Outpost Unit BE-51-----	2 $\frac{1}{2}$ x 3 $\frac{3}{4}$ x 7	6
Handset TS-9-()-----	9 $\frac{1}{16}$ x 2 $\frac{3}{4}$ x 3 $\frac{15}{16}$	1. 1
Headset HS-30-()-----		
Protector AR-8-----	14 x 6 (diam)	10
Switchboard BD-70-----	23 x 21 x 10	85
Telephone EE-8-()-----	9 $\frac{1}{16}$ x 7 $\frac{15}{16}$ x 3 $\frac{1}{2}$	9. 25

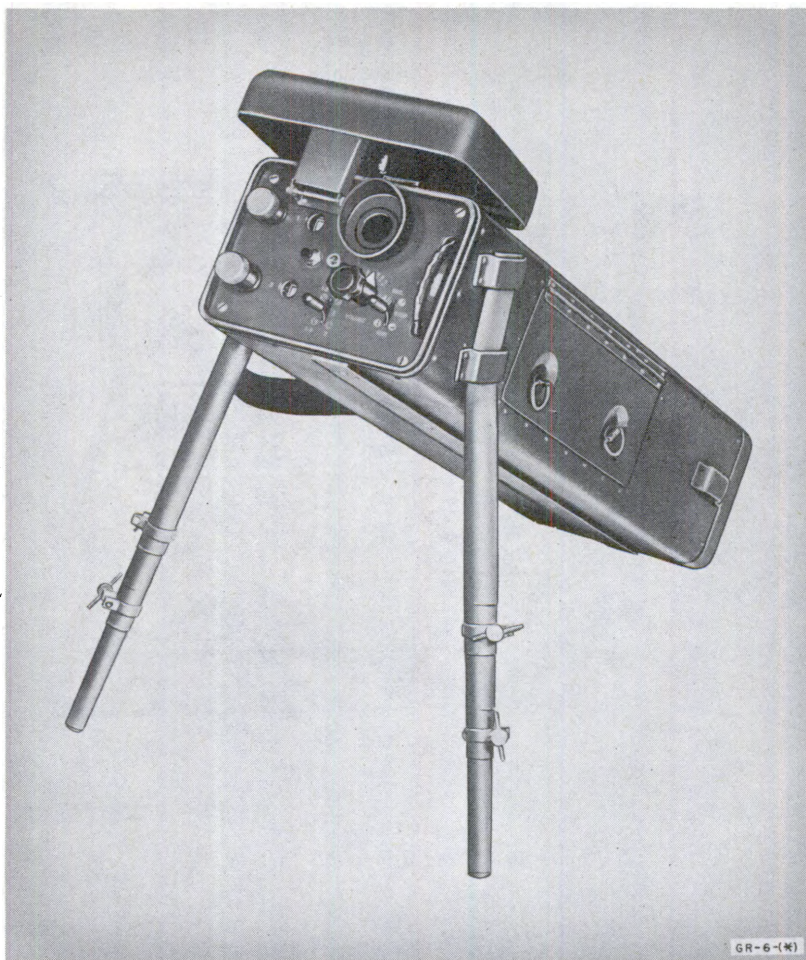

Figure 49. Recorder BC-1323-A of Sound Locating Set GR-6-A.

Status: Standard. *Stock No.:* 4G3006. *Reference:* TM 11-2552.

Sound Locating Set GR-6(*) represents GR-6 and GR-6-A. Sound Locating Set GR-6(*) consists of appropriate telephone equipment, radio transmitter and receiver, gasoline-engine driven generator for charging the supplied lead-acid-type storage batteries, and other allied equipment and accessories required to operate and maintain the equipment. The GR-6(*) is used to determine the range and azimuth of small arms fire. The sound of a muzzle blast is picked up by an array of three specially placed microphones whose output is fed to a recorder. The recording is made on steel tape and played back to operating personnel who determine the point of origin of the enemy gunfire.

TECHNICAL CHARACTERISTICS

AMPLIFIER FREQUENCY RANGE.	60 to 300 cps, recording and reproducing.
AMPLIFIER CHANNELS.	3.
PHASE MATCHING:	Relative differences in electrical phase between any two channels within .2 milliseconds.
OPERATING RANGE:	2,000 to 4,000 yards.
POWER:	Battery operated—Batteries BB-54 and BB-221/U.

PRINCIPAL COMPONENTS

Item	Dimensions (in.)	Weight (lb)
3 Recorder BC-1323-()	30 x 8 x 6	35
4 Microphone T-56	9½ x 4½ (diam)	4¾
Headset HS-30/U		
2 Reel Equipment CE-11	20⅞ x 8 x 7	3
12 Battery Box CH-291	12 x 6½ x 5½	4¾
6 Battery Box CH-318	12⅞ x 11¼ x 9⅞	18

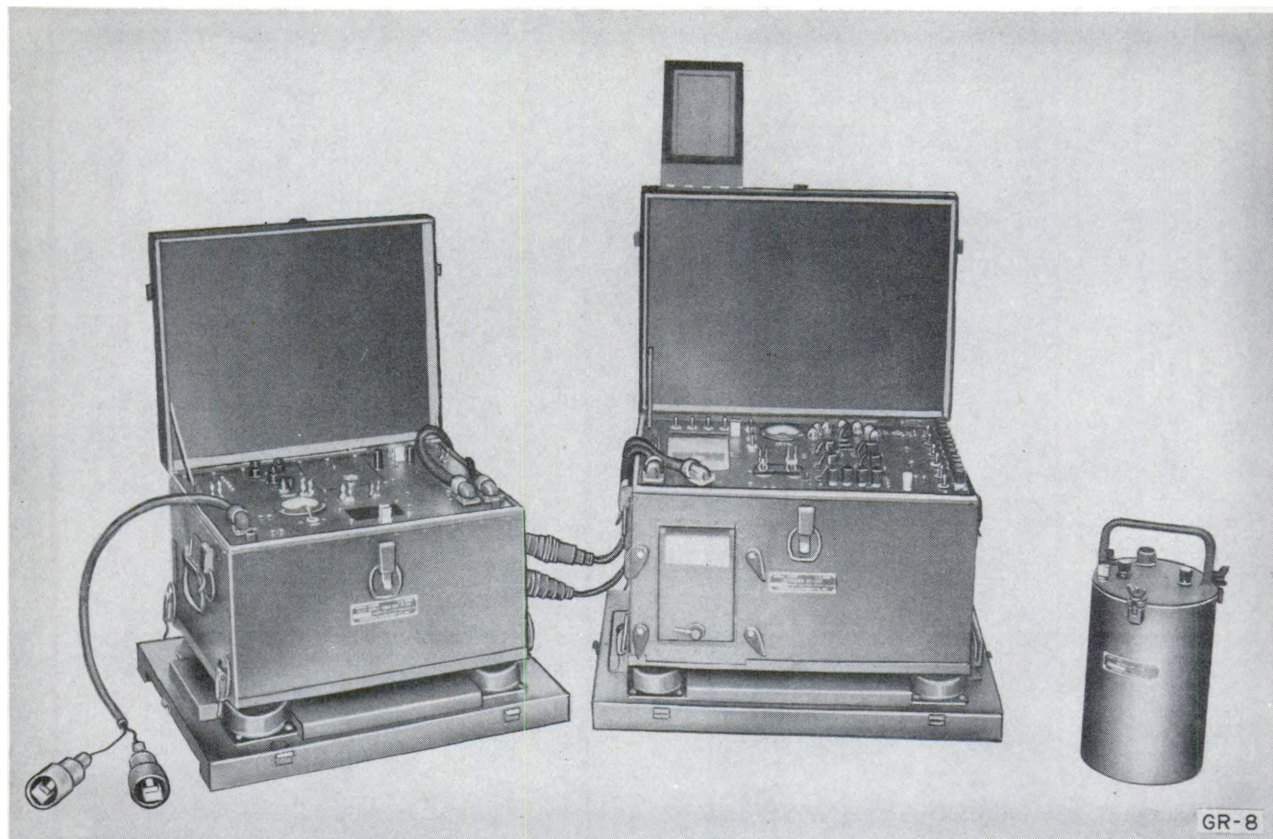

Figure 50. Sound Ranging Set GR-8.

Status: Standard. *Stock No.:* 4G3008. *Reference:* TM 11-2568.

Sound Ranging Set GR-8 consists of a recorder, a power supply, microphones, connecting cables and wire, and associated equipment required to operate and maintain a sound ranging system. Sound Ranging Set GR-8 is used to detect the sound of artillery fire or shell detonations and to record the difference in the arrival times of the sound waves at a maximum of six microphone locations.

TECHNICAL CHARACTERISTICS

MICROPHONE SPACING. 2,000 yd apart, maximum.

POWER: Battery operated—2 Batteries BB-53, 4 Batteries BB-200/U (6 Batteries BA-30 may be used in place of 4 BB-200/U).
Power Unit PE-210.

PRINCIPAL COMPONENTS

Item	Dimensions (in.)	Weight (lb)
Recorder BC-1337-----	10 x 18 x 12	58
Plate Supply-Timer Unit PE-244.	9 x 15 x 12	43
6 Microphone T-23-----	13 x 6 (diam)	10 ea
2 Outpost Connecting Box BE-71.	5 x 2 x 2 $\frac{1}{4}$	1 ea
2 Outpost Switch Box SA-45/G.		$\frac{1}{2}$ ea
4 Telephone EE-8-()	9 $\frac{1}{2}$ x 7 $\frac{1}{16}$ x 3 $\frac{1}{2}$	9 $\frac{1}{4}$ ea
Test Set TS-26/TSM---	5 $\frac{1}{2}$ x 7 $\frac{1}{8}$ x 8 $\frac{5}{32}$	8 $\frac{1}{2}$
Test Set I-56-K-----	14 $\frac{3}{4}$ x 9 $\frac{3}{4}$ x 20 $\frac{1}{2}$	55
Tool Equipment TE-37-		1
Power Unit PE-210----	13 x 18 x 14	61



Figure 51. Headset H-16/U.

Status: Standard. *Stock No.:* 2B800-16.

Headset H-16/U consists of an adjustable headband to fit the contours of the wearer's head, and two earcups (each containing a receiver unit, an impedance-matching transformer, and an ear inset). The cord terminates in Plug PL-54. Headset H-16/U is used in armored vehicles and

may be worn under Helmet M1 and crash helmets used by the Infantry and Armored Forces.

TECHNICAL CHARACTERISTICS

IMPEDANCE: 8,000 ohms.

WEIGHT

Unpacked.....

*Weight
(lb)*
1.0



Figure 52. Headset HS-16.

Status: Standard. *Stock No.:* 4A916. *Reference:* TM 11-2093.

Headset HS-16-(*) represents HS-16 and HS-16-A. Headset HS-16-(*) consists of a pair of low-impedance receivers with a headband and cord for connection to Key J-38, Switchboards BD-57-() or BD-114. It is used by students and instructors for code practice training.

P/o Code Practice Equipments EE-94-(), EE-95-(), and EE-96-().

TECHNICAL CHARACTERISTICS

IMPEDANCE: 520 ohms at 1,000 cps.
D-C RESISTANCE: 2,500 ohms.

WEIGHT AND DIMENSIONS

	<i>Dimensions (in.)</i>	<i>Weight (lb)</i>	<i>Volume (cu ft)</i>
Unpacked-----	7¼ x 3½ x 2½	1.25	1.06

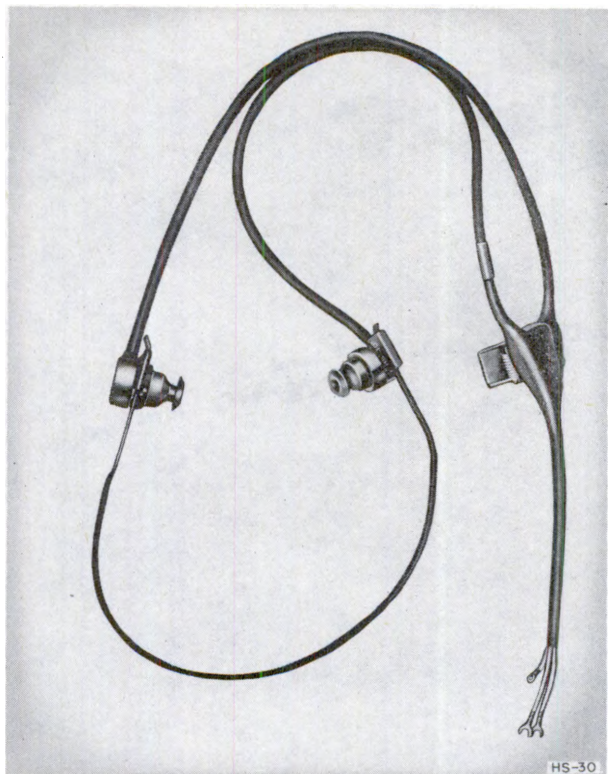

Figure 53. Headset HS-30-(*).

Status: Standard. Stock No.: 2B830.

Headset HS-30-(*) represents 14 models of HS-30. It is a lightweight, close-fitting headset. Special soft rubber earpieces snapped to the receivers of the headset are designed to fit snugly into the ear cavities and exclude outside noises. The headband is adjustable to the contour of the operator's head. It is intended for general applications.

TECHNICAL CHARACTERISTICS

IMPEDANCE: 250 ohms.

WEIGHT

	Weight (lb)
Unpacked.....	.57

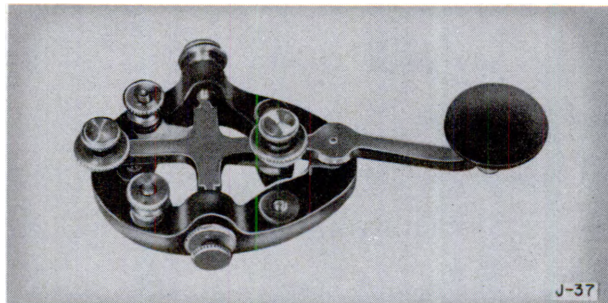

Figure 54. Key J-37.

Status: Standard. Stock No.: 3Z3437.

Key J-37 is a manually operated telegraph key with a three-way, adjustable lever and two binding posts. It is used with standard Signal Corps radio and telegraph equipment.

DIMENSIONS

	Dimensions (in.)	Volume (cu ft)
Unpacked.....	5 $\frac{1}{16}$ x 2 $\frac{1}{8}$ x 1	.01

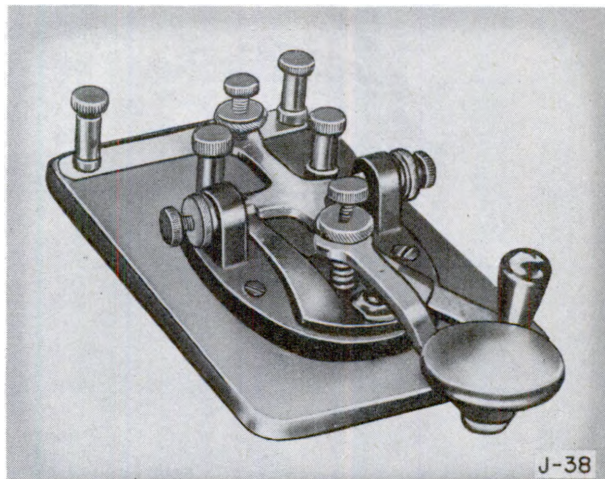

Figure 55. Key J-38, with headset.

Status: Limited/Std. Stock No.: 3Z3438.

Key J-38 is a standard lever-type hand telegraph key incorporating a circuit-closing switch used to short-circuit the keying contacts. The switch is kept closed for all operations except sending. Binding posts are provided for line and headset connections. Key J-38 is used with standard Signal Corps telegraph, code practice, and radio equipment.

WEIGHT AND DIMENSIONS

	Dimensions (in.)	Weight (lb)	Volume (cu ft)
Unpacked.....	7 $\frac{1}{4}$ x 3 $\frac{1}{2}$ x 1 $\frac{1}{4}$	1	.03

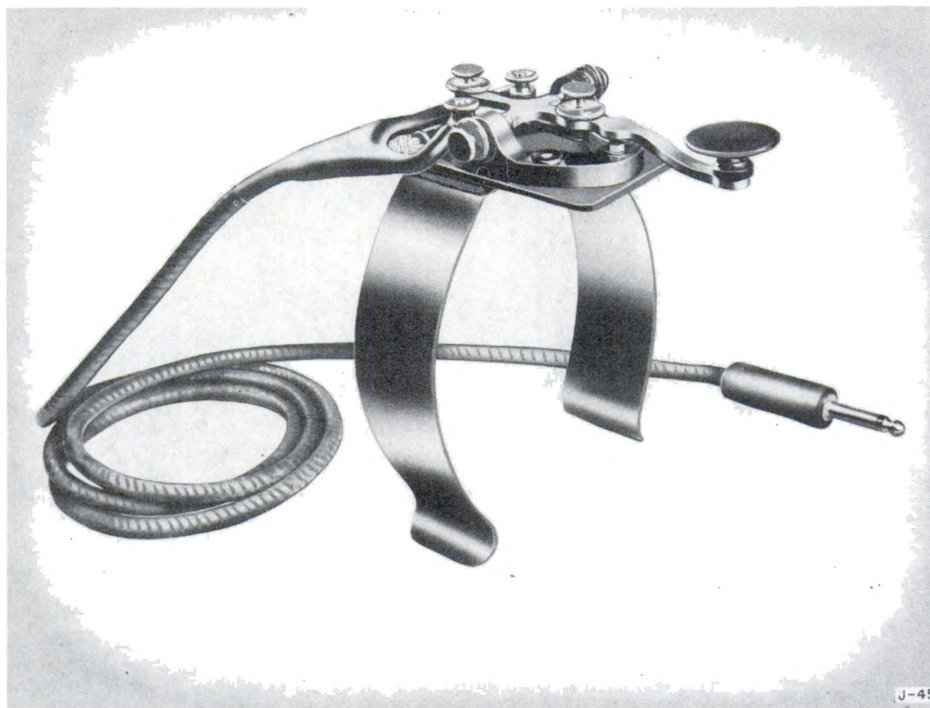

Figure 56. Key J-45.

Status: Standard. Stock No.: 3Z3445.

Key J-45 is a manually operated telegraph key with a leg clip to hold it to the operator's leg. It has a three-way adjustable lever and two binding posts. It is used with standard Signal Corps telegraph and radio equipment.

WEIGHT AND DIMENSIONS

	Dimensions (in.)	Weight (lb)	Volume (cu ft)
Unpacked.....	6 x 2 x 2½	1	.01

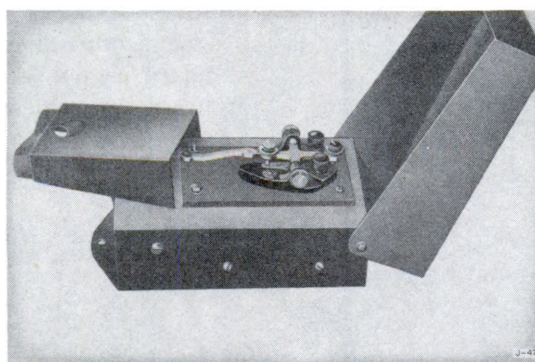

Figure 57. Key J-47, mounted in a key box.

Status: Standard. Stock No.: 3Z3447.

Key J-47 is a manually operated key with a three-way adjustable lever and two binding posts, mounted on a phenolic plate. It is used with signal lamp equipment to obtain coded light flashes.

P/o Signal Lamp Equipment EE-80-().

WEIGHT AND VOLUME

	Weight (lb)	Volume (cu ft)
Unpacked.....	1	.015

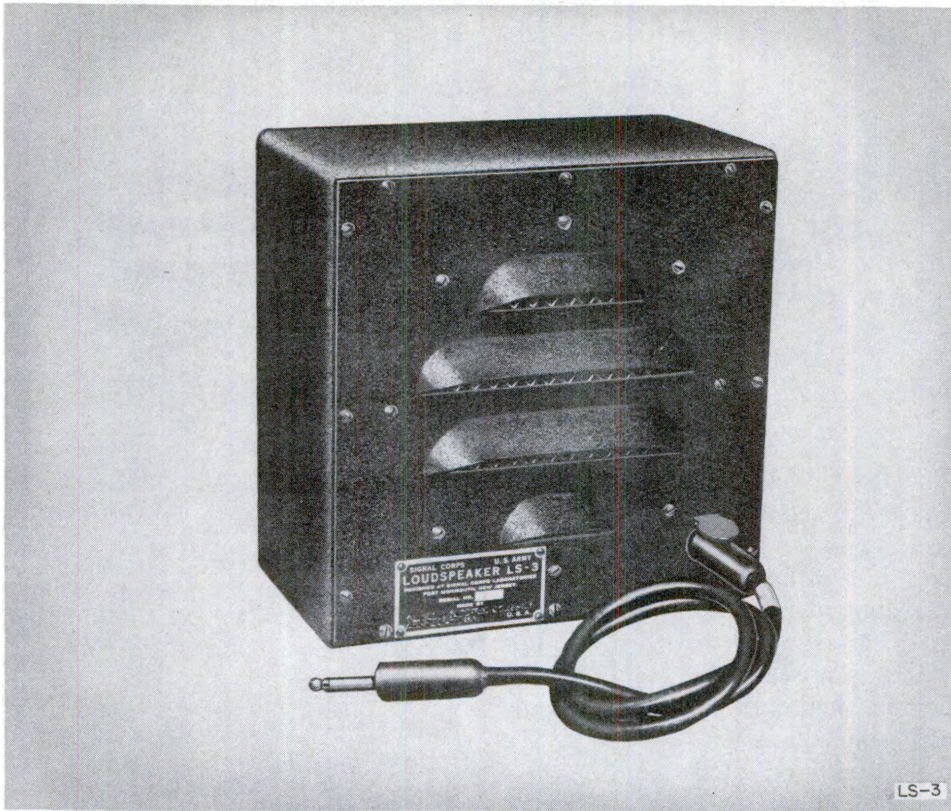

Figure 58. Loudspeaker LS-3.

Status: Standard. Stock No.: 2Z6303.1.

Loudspeaker LS-3 is a permanent-magnet type speaker, housed in a steel case. Included as a part of the equipment is a transformer designed to match the impedance of the speaker voice coil to that of a radio receiver output. Cord CD-314 (not supplied) is used to connect the loudspeaker to the receiver. Loudspeaker LS-3 is used with standard Signal Corps receivers, sound systems, and paging systems.

TECHNICAL CHARACTERISTICS

IMPEDANCE: 8,000 ohms.
 SPEAKER SIZE: 6 in.

WEIGHT AND DIMENSIONS

	Dimensions (in.)	Weight (lb)	Volume (cu. ft)
Unpacked.....	8¼ x 8¼ x 5¼	9	.21

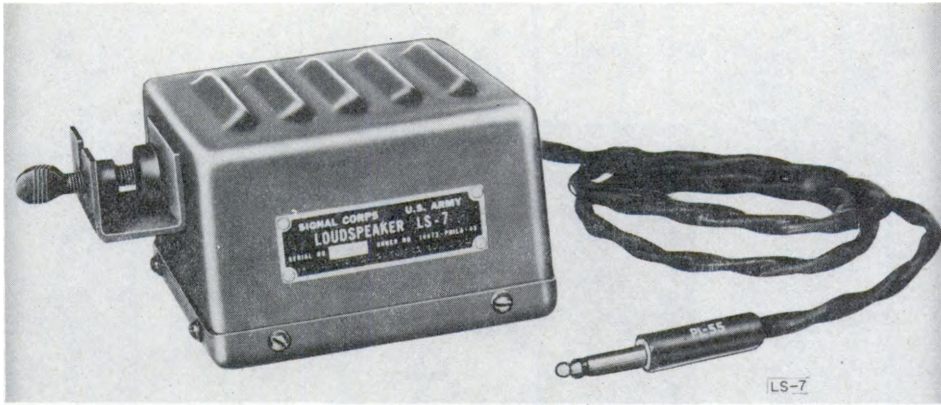

Figure 59. Loudspeaker LS-7.

Status: Standard. Stock No.: 2Z6310-7.

Loudspeaker LS-7 is a 4-inch permanent-magnet type speaker unit with an input transformer, mounted in a rectangular steel case. A 3-foot cord with Plug PL-55 is included with the equipment, and a clamp is provided for mounting the unit on the edge of a shelf. It is used with standard Signal Corps radio equipment.

U/w but not p/o Radio Set SCR-284-().

TECHNICAL CHARACTERISTICS

INPUT IMPEDANCE: 4,000 ohms.
 CONE DIAMETER: 4 in.

DIMENSIONS

	Dimensions (in.)	Volume (cu ft)
Unpacked	4 $\frac{3}{8}$ x 4 $\frac{3}{8}$ x 2 $\frac{3}{8}$.04

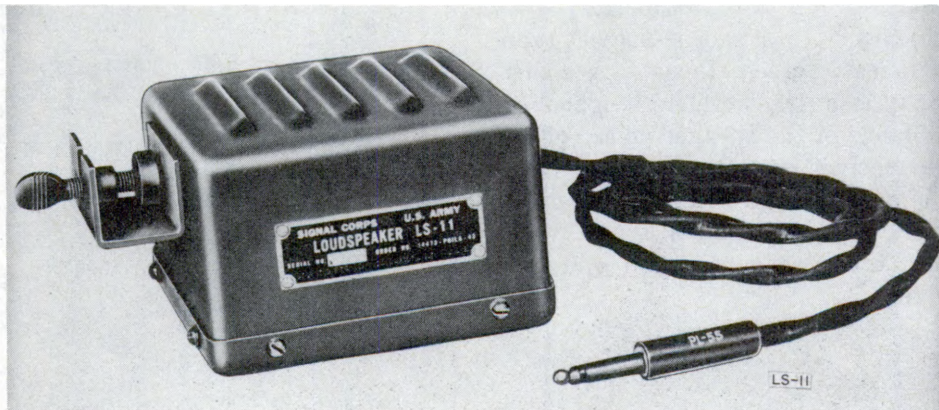

Figure 60. Loudspeaker LS-11.

Status: Standard. Stock No.: 6C51.

Loudspeaker LS-11 is a 4-inch, permanent-magnet type speaker unit with an input transformer, mounted in a rectangular steel case. A 3-foot cord with Plug PL-55 is included with the equipment, and a clamp is provided for mounting the unit on the edge of a shelf. It is used with standard Signal Corps radio and public address equipment.

TECHNICAL CHARACTERISTICS

INPUT IMPEDANCE: 250 ohms.

DIMENSIONS

	Dimensions (in.)	Volume (cu ft)
Unpacked	4 $\frac{3}{8}$ x 4 $\frac{3}{8}$ x 2 $\frac{3}{8}$.04

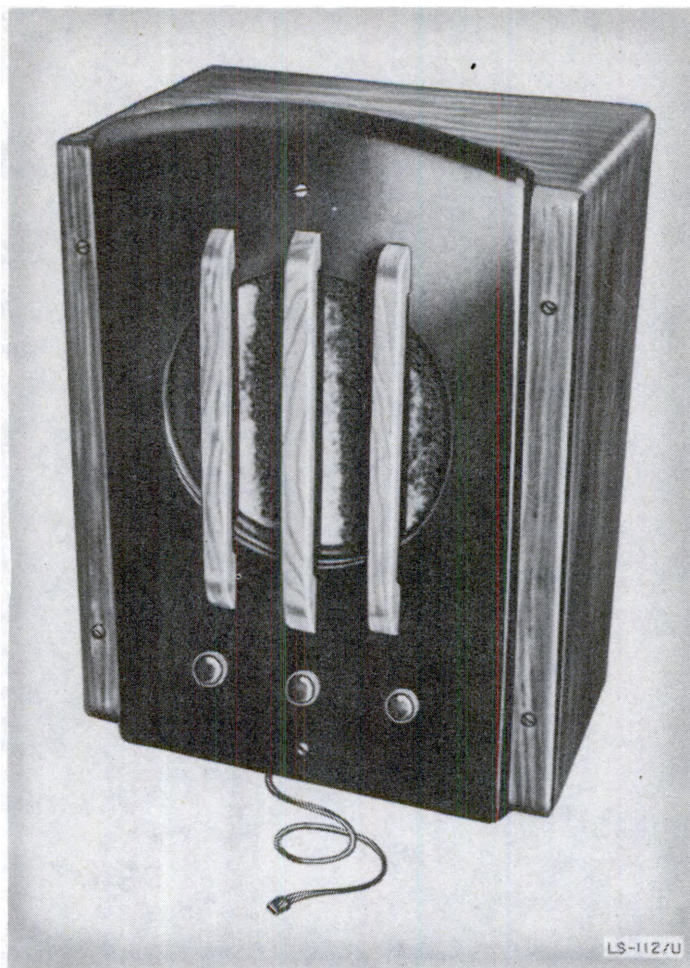

Figure 61. Loudspeaker LS-112/U.

Status: Standard. Stock No.: 6C42-112. Reference: TM 11-2590.

Loudspeaker LS-112/U is a permanent-magnet type speaker. It is mounted in a sloping baffle and is intended for wall-mounting in small theaters and auditoriums.

P/o Audio Distributing Central AN/FIA-1.

TECHNICAL CHARACTERISTICS

CONE DIAMETER: 8 in.

VOICE COIL IMPEDANCE: 45 ohms.
 INPUT IMPEDANCE: Low power—16,670 ohms.
 Medium power—4,170 ohms.
 High power—1,040 ohms.
 SELECTOR SWITCH: 5 channels and off.

WEIGHTS AND DIMENSIONS

	Dimensions (in.)	Weight (lb)	Volume (cu ft)
Unpacked	16½ x 9 x 12¾/16	11½	1.04
Export pack	17¾ x 10¼ x 13¾	17	1.43

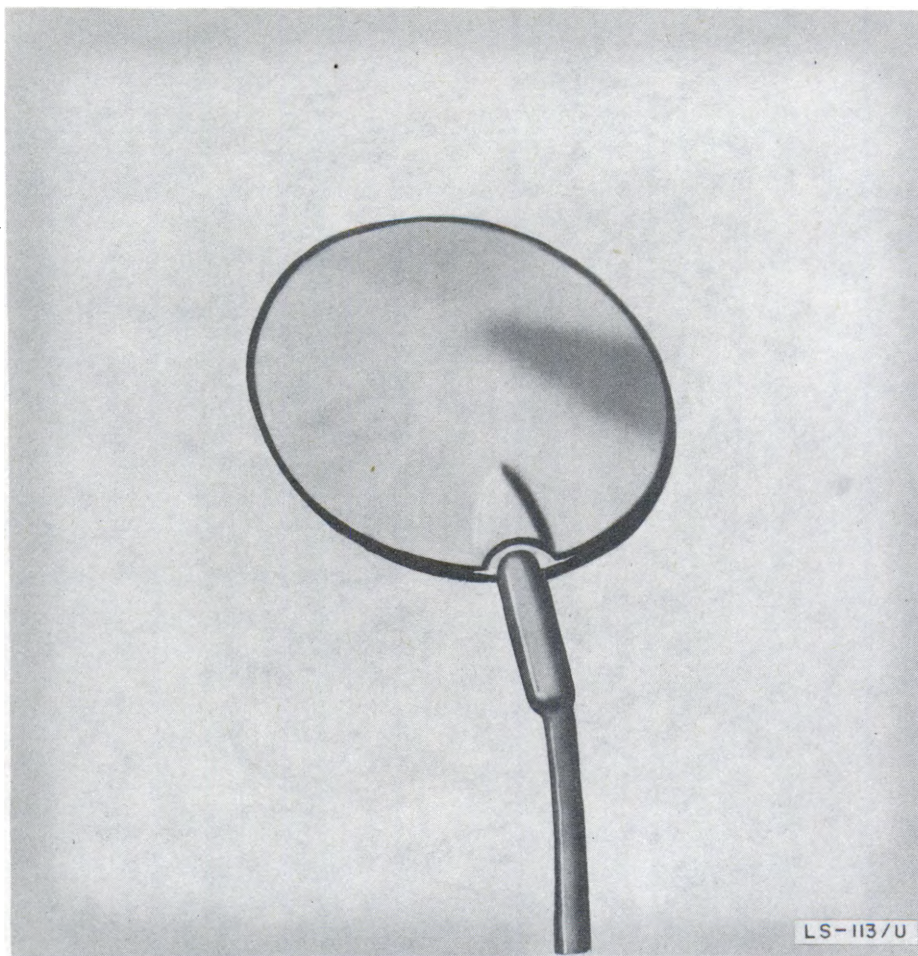

Figure 62. Loudspeaker LS-113/U.

Status: Limited/Std. *Stock No.:* 6C42-113.
Reference: TM 11-2590.

Loudspeaker LS-113/U is a magnetic pillow-type speaker for individual patients in a hospital. It is provided with a 10-foot, 2-conductor cord with a standard radio plug on one end. The entire unit can be sterilized by submersion in a 70-percent solution of alcohol at temperatures below 120° F.

P/o Audio Distributing Central AN/FIA-1.

TECHNICAL CHARACTERISTICS

DIAPHRAGM SIZE: 3 in.
 INPUT: .02 w, normal.
 IMPEDANCE: 12,000 ohms at 1,000 cps.

WEIGHTS AND DIMENSIONS

	Dimensions (in.)	Weight (lb)	Volume (cu ft)
Unpacked.....	1½ x 3 x 3	½	
Export pack ¹	8½ x 16¼ x 20¼	57	1.66

¹ 100 per package.



Figure 63. Loudspeaker LS-114/U.

Status: Standard. Stock No.: 6C42-114. Reference: TM 11-2590.

Loudspeaker LS-114/U is a paging speaker housed in a wooden baffle. It is used to page personnel in hospital installations.

P/o Audio Distributing Central AN/FIA-1.

TECHNICAL CHARACTERISTICS

TYPE: Dynamic.
 CONE DIAMETER: 5 in.

VOICE COIL IMPEDANCE: 45 ohms.

INPUT IMPEDANCE: Low power—83,000 ohms.
 Medium power—20,830 ohms.
 High power—5,210 ohms.

WEIGHTS AND DIMENSIONS

	Dimensions (in.)	Weight (lb)	Volume (cu ft)
Unpacked	7¼ x 4½ x 7¼	3½	.14
Export pack	9 x 20¼ x 27¼	47	2.91

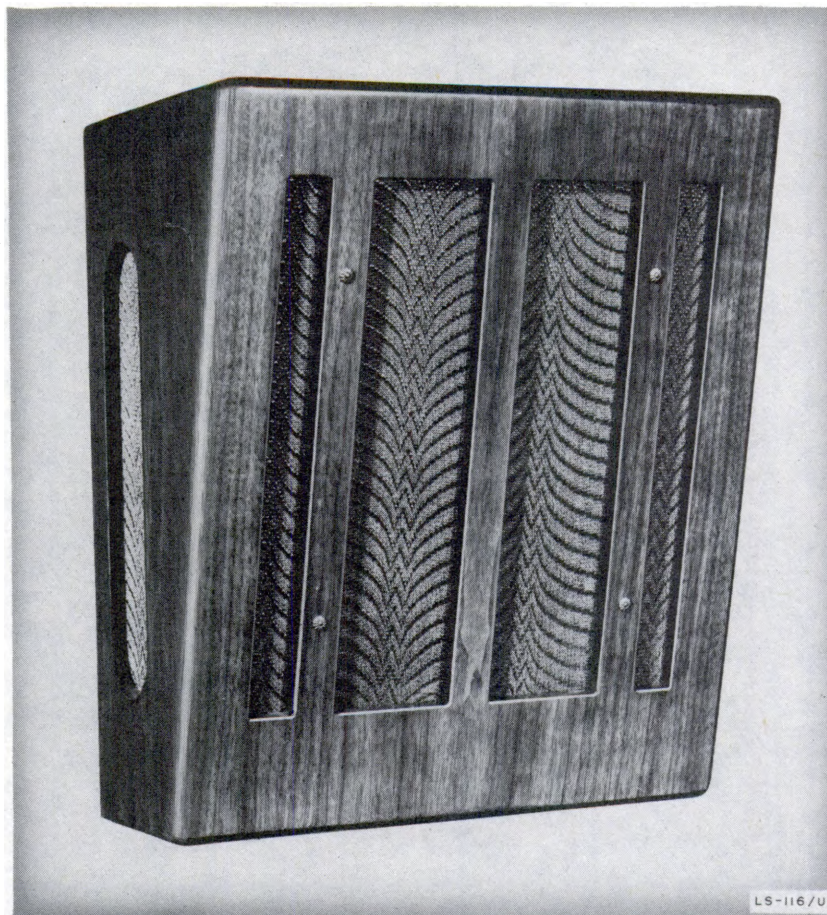

Figure 64. Loudspeaker LS-116/U.

Status: Standard. *Stock No.:* 6C43-17. *Reference:* TM 11-2573.

Loudspeaker LS-116/U is a permanent-magnet, cone-type speaker. It is mounted in a wooden housing designed to direct the sound down at a 15° angle. Wall mounting brackets are installed on the housing. It is intended for indoor use.

U/w Amplifiers AM-92()/TI and AM-93/TI.

TECHNICAL CHARACTERISTICS

INPUT IMPEDANCE: 500, 1,000, 1,500, and 2,000 ohms.

POWER OUTPUT: 12 w.

CONE SIZE: 12 in.

WEIGHT AND DIMENSIONS

	<i>Dimensions (in.)</i>	<i>Weight (lb)</i>
Unpacked.....	18 x 14½ x 12	15½



Figure 65. Loudspeaker LS-117/U.

Status: Standard. *Stock No.:* 6C43-17. *Reference:* TM 11-2573.

Loudspeaker LS-117/U is a re-entrant horn speaker with a separate transformer-box assembly. It is suitable for use outdoors and will project sound at high levels over long distances. It is equipped with a heavy swivel for attachment to a pipe fitting mounting with a 1¼-inch thread. The line-matching transformer is installed in a watertight box for mounting adjacent to the speaker.

U/w Amplifiers AM-92()/TI and AM-93/TI.

TECHNICAL CHARACTERISTICS

INPUT IMPEDANCE: 500, 1,000, 1,500, and 2,000 ohms.
POWER OUTPUT: 20 w at 250 cps; provides an air column equivalent to a 3½-foot trumpet..
BELL SIZE: 18½ in.

WEIGHT AND DIMENSIONS

	<i>Dimensions (in.)</i>	<i>Weight (lb)</i>
Unpacked.....	21 x 18½ (diam)	25

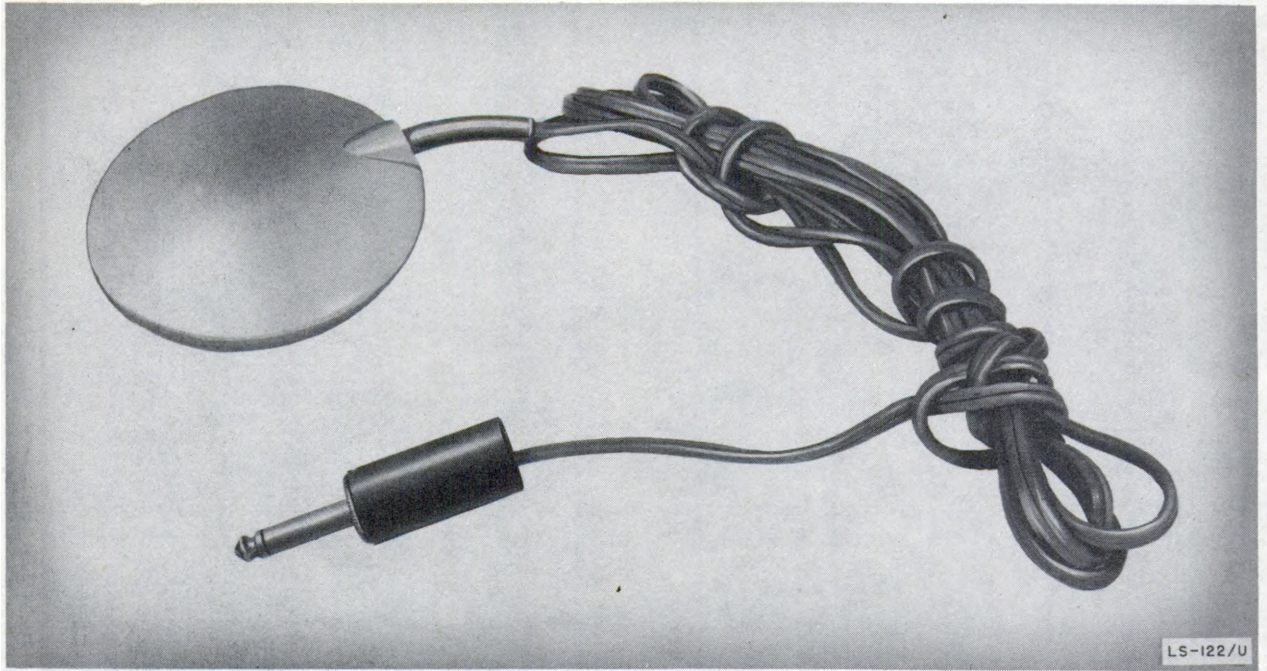

Figure 66. Loudspeaker LS-122/U.

Status: Standard. *Stock No.:* 6C42-122. *Reference:* TM 11-2590.

Loudspeaker LS-122/U is a pillow-type speaker for use where the listener is confined to bed. It is equipped with a 10-foot, 2-conductor cord, one end of which is fixed to the speaker, the other end terminating in a standard radio plug. The entire unit is capable of sterilization by submersion in a 70 percent solution of alcohol at a temperature of 125° F.

U/w but not p/o Audio Distributing Central AN/FIA-1.

TECHNICAL CHARACTERISTICS

OUTPUT: Normal—.001 w.
Peak—.003 w.
IMPEDANCE: 10,000 ohms at 1,000 cps.

WEIGHTS AND DIMENSIONS

	Dimensions (in.)	Weight (lb)	Volume (cu ft)
Unpacked.....	1 3/32 x 3 3/8 (diam)	.5	----
Export pack ¹	8 1/2 x 16 1/4 x 20 1/4	57	1.54

¹ 100 per package.

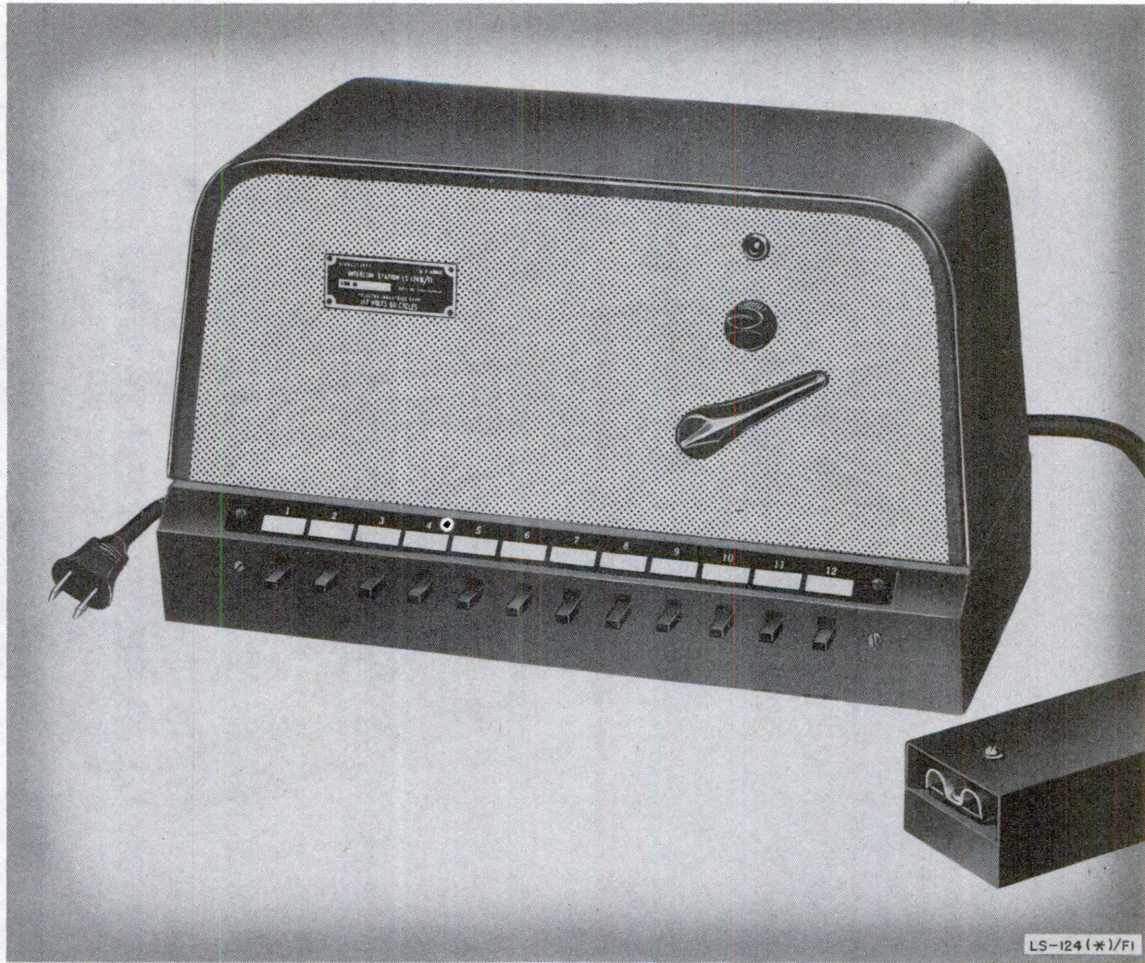

Figure 67. Intercommunicating Station LS-124/FI.

Status: Standard. Stock No.: 4B1482M. Reference: TM 11-2572.

Intercommunicating Station LS-124(*)/FI represents LS-124/FI, LS-124A/FI, and LS-124B/FI. Intercommunicating Station LS-124(*)/FI is a master station unit consisting of a self-contained speaker-microphone, a three-tube amplifier, and an a-c power cord. Intercommunicating Station LS-124(*)/FI is used as the control switching unit in an intercommunication system. Any master station can be combined with other master units and speaker-microphone units for intercommunication.

U/w Intercommunicating Station LS-129/FI.

TECHNICAL CHARACTERISTICS

- STATION CAPACITY: 11 remote stations if 1 or more is a master station.
12 remote stations if all are speaker-microphone units.
- IMPEDANCE: 50 ohms, input and output.
- SPEAKER IMPEDANCE: 45 ohms.
- INTERSTATION WIRE SIZE: #22 or larger.
- POWER: 110 to 125 v, ac, 50 to 60 cps.
- POWER CONSUMPTION: 15 w, when idle.
- POWER OUTPUT: 2½ w.

WEIGHTS AND DIMENSIONS

	Dimensions (in.)	Weight (lb)	Volume (cu ft)
Unpacked	7¾ x 6¾ x 13¾	20½	.5
Export pack	34 x 12 x 14	70	3.30

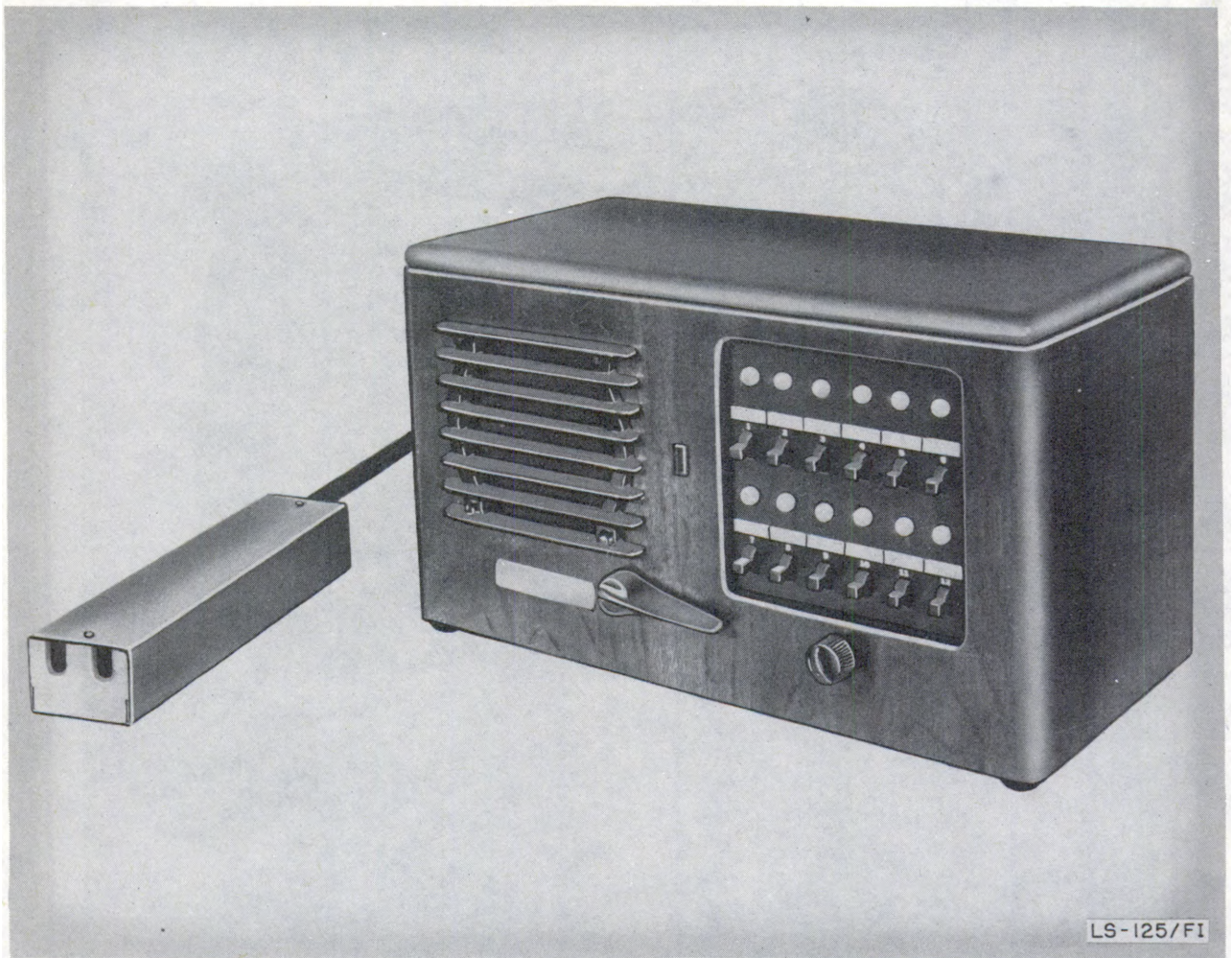

Figure 68. Intercommunicating Station LS-125/FI.

Status: Standard. Stock No.: 4B1482AM.
Reference: TM 11-2572.

Intercommunicating Station LS-125/FI is a master station unit consisting of a self-contained speaker-microphone, a three-tube amplifier, and an a-c power cord. The station is equipped with a three-position switch for operating the annunciators on another master station. Intercommunicating Station LS-125/FI is used as the control switching unit in an intercommunication system. Any master station can be combined with other master units and speaker-microphone units for intercommunication.

U/w Intercommunicating Station LS-130/FI.

TECHNICAL CHARACTERISTICS

- STATION CAPACITY: 11 remote stations if 1 or more is a master station.
12 remote stations if all are speaker-microphone units.
- IMPEDANCE: 50 ohms, input and output.
SPEAKER 45 ohms.
- IMPEDANCE.
INTERSTATION #22 or larger.
- WIRE SIZE.
- POWER: 110 to 125 v, ac, 50 to 60 cps.
POWER 15 w, when idle.
- CONSUMPTION.
- POWER OUTPUT: 2½ w.

WEIGHTS AND DIMENSIONS

	Dimensions (in.)	Weight (lb)	Volume (cu ft)
Unpacked	7¾ x 6¾ x 13¾	20½	.5
Export pack	34 x 12 x 14	70	3.30

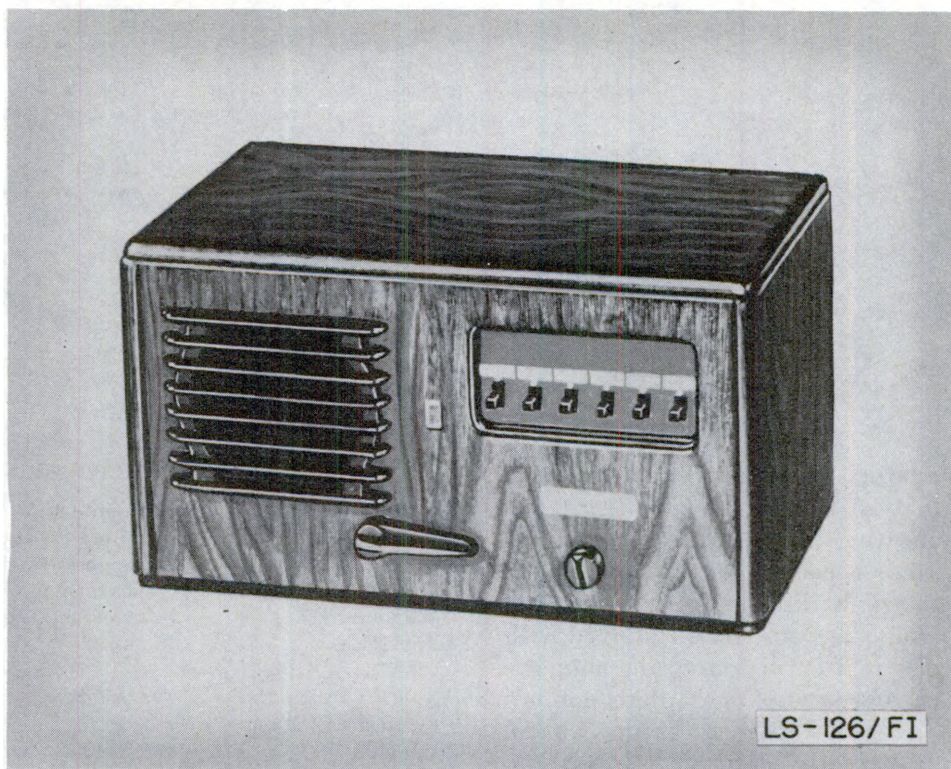

Figure 69. Intercommunicating Station LS-126/FI.

Status: Limited/Std. Stock No.: 4B1846M.
Reference: TM 11-2572.

Intercommunicating Station LS-126/FI is a master station unit consisting of a self-contained speaker-microphone, a three-tube amplifier, and an a-c power cord. The station is equipped with a switching circuit that enables the unit to be used in a system operating at either 50- or 500-ohm impedance. Intercommunicating Station LS-126/FI is used as the control switching unit in a intercommunication system. Any master station can be combined with other master units and speaker-microphone units for intercommunication.

U/w Intercommunicating Station LS-129/FI.

TECHNICAL CHARACTERISTICS

- STATION CAPACITY: 5 remote stations if 1 or more is a master station.
6 remote stations if all are speaker-microphone units.
- IMPEDANCE: 50 or 500 ohms, input and output.
- SPEAKER IMPEDANCE. 45 ohms.
- INTERSTATION WIRE SIZE. #22 or larger.
- POWER: 110 to 125 v, ac, 50 to 60 cps.
- POWER CONSUMPTION. 15 w, when idle.
- POWER OUTPUT: 2½ w.

WEIGHTS AND DIMENSIONS

	Dimensions (in.)	Weight (lb)	Volume (cu ft)
Unpacked.....	7½ x 6½ x 13½	20½	.5
Export pack.....	34 x 12 x 14	70	3.30

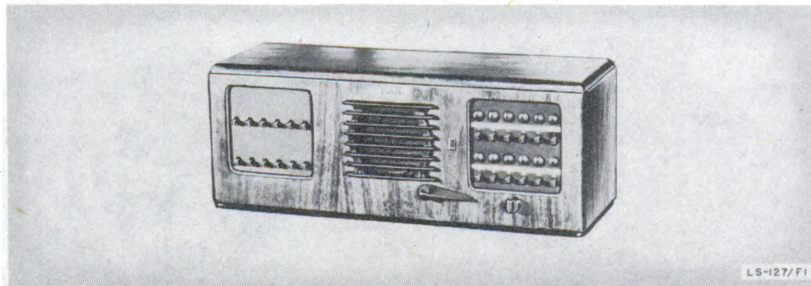

Figure 70. Intercommunicating Station LS-127/FI.

Status: Standard. Stock No.: 4B1484A M.
Reference: TM 11-2572.

Intercommunicating Station LS-127/FI is a master station unit consisting of a self-contained speaker-microphone, a three-tube amplifier, and an a-c power cord. The station is equipped with a three-position switch for operating the annunciators on another master station. Intercommunicating Station LS-127/FI is used as the control switching unit in an intercommunication system. Any master station can be combined with other master units and speaker-microphone units for intercommunication.

U/w Intercommunicating Station LS-130/FI.

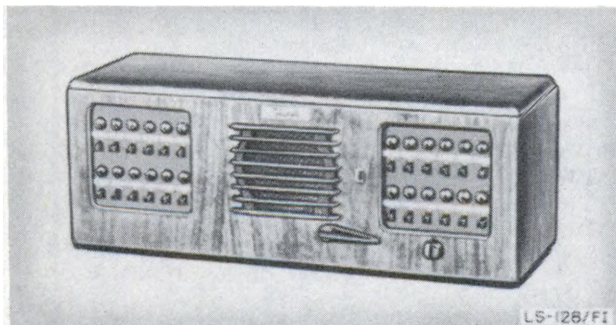

Figure 71. Intercommunicating Station LS-128/FI.

Status: Standard. Stock No.: 4B1484M. Reference: TM 11-2572.

Intercommunicating Station LS-128/FI is a master station unit consisting of a self-contained speaker-microphone, a three-tube amplifier, and an a-c power cord. Intercommunicating Station LS-128/FI is used as the control switching unit in an intercommunication system. Any master station can be combined with other master station

TECHNICAL CHARACTERISTICS	
STATION CAPACITY.	23 remote stations if 1 or more is a master station. 24 remote stations if all are speaker-microphone units.
IMPEDANCE: SPEAKER	50 ohms, input or output. 45 ohms.
IMPEDANCE: INTERSTATION WIRE SIZE.	#22 or larger.
POWER: POWER CONSUMPTION.	110 to 125 v, ac, 50 to 60 cps. 15 w, when idle.
POWER OUTPUT:	2½ w.

WEIGHTS AND DIMENSIONS

	Dimensions (in.)	Weight (lb)	Volume (cu ft)
Unpacked	7¾ x 6¾ x 19¼	30	.75
Export pack	40 x 12 x 14	79½	3.75

units and speaker-microphone units for intercommunication.

U/w Intercommunicating Station LS-129/FI.

TECHNICAL CHARACTERISTICS

STATION CAPACITY.	23 remote stations if 1 or more is a master station. 24 remote stations if all are speaker-microphone units.
IMPEDANCE: SPEAKER	50 ohms, input and output. 45 ohms.
IMPEDANCE: INTERSTATION WIRE SIZE.	#22 or larger.
POWER: POWER CONSUMPTION.	110 to 125 v, ac, 50 to 60 cps. 15 w, when idle.
POWER OUTPUT:	2½ w.

WEIGHTS AND DIMENSIONS

	Dimensions (in.)	Weight (lb)	Volume (cu ft)
Unpacked	7¾ x 6¾ x 13¾	20½	.5
Export pack	34 x 12 x 14	70	3.30



Figure 72. Intercommunicating Station LS-129/FI.

Status: Standard. *Stock No.:* 6C290-1. *Reference:* TM 11-2572.

Intercommunicating Station LS-129/FI is a speaker-microphone unit consisting of a 5-inch cone and a voice coil mounted in a cabinet. It is used as a remote station with intercommunicating stations which have output-input impedances of 50 ohms.

U/w Intercommunicating Stations LS-124()/FI, LS-126/FI, and LS-128/FI.

TECHNICAL CHARACTERISTICS

VOICE COIL IMPEDANCE: 45 ohms.
POWER OUTPUT: 2 w.

WEIGHTS AND DIMENSIONS

	Dimensions (in.)	Weight (lb)	Volume (cu ft)
Unpacked.....	7 $\frac{1}{2}$ x 3 $\frac{1}{4}$ x 7 $\frac{1}{2}$	4 $\frac{1}{4}$. 13
Export pack.....	39 $\frac{1}{2}$ x 10 $\frac{1}{4}$ x 17	40	3. 98

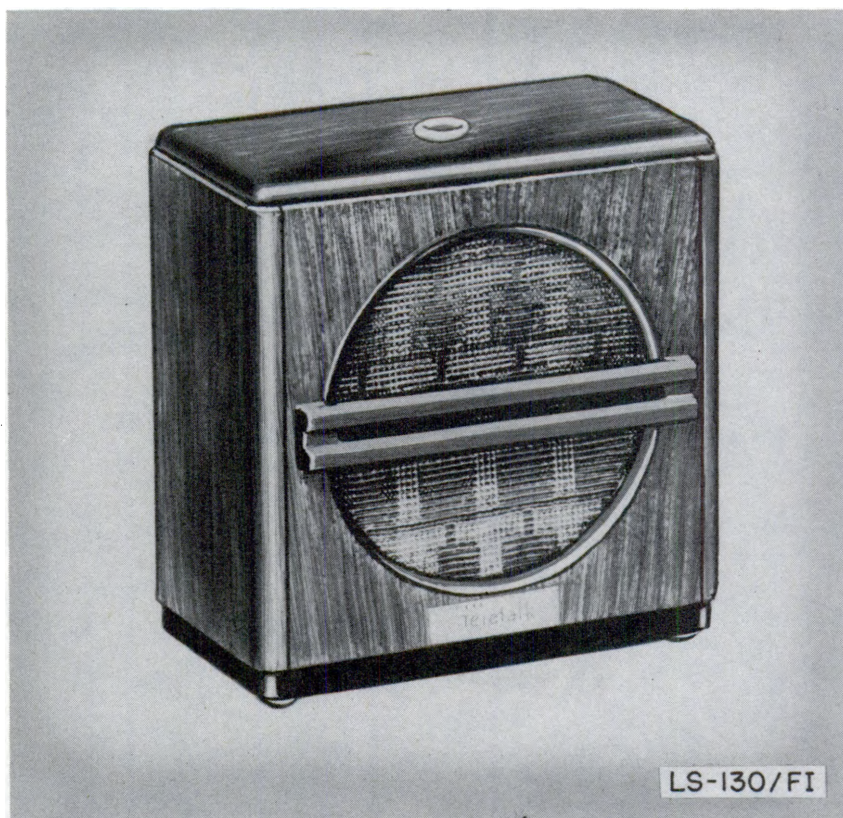

Figure 73. Intercommunicating Station LS-130/FI.

Status: Standard. *Stock No.:* 6C290. *Reference:* TM 11-2572.

Intercommunicating Station LS-130/FI is a speaker-microphone unit consisting of a 5-inch cone and a voice coil mounted in a cabinet. It is used as a remote station with annunciator-type intercommunicating stations which have input-output impedances of 50 ohms.

U/w Intercommunicating Stations LS-125/FI and LS-127/FI.

TECHNICAL CHARACTERISTICS

VOICE COIL IMPEDANCE: 45 ohms.
POWER OUTPUT: 2 w.

WEIGHTS AND DIMENSIONS

	Dimensions (in.)	Weight (lb)	Volume (cu ft)
Unpacked.....	7½ x 3¼ x 7½	4½	.13
Export pack.....	39½ x 10¼ x 17	40	3.98

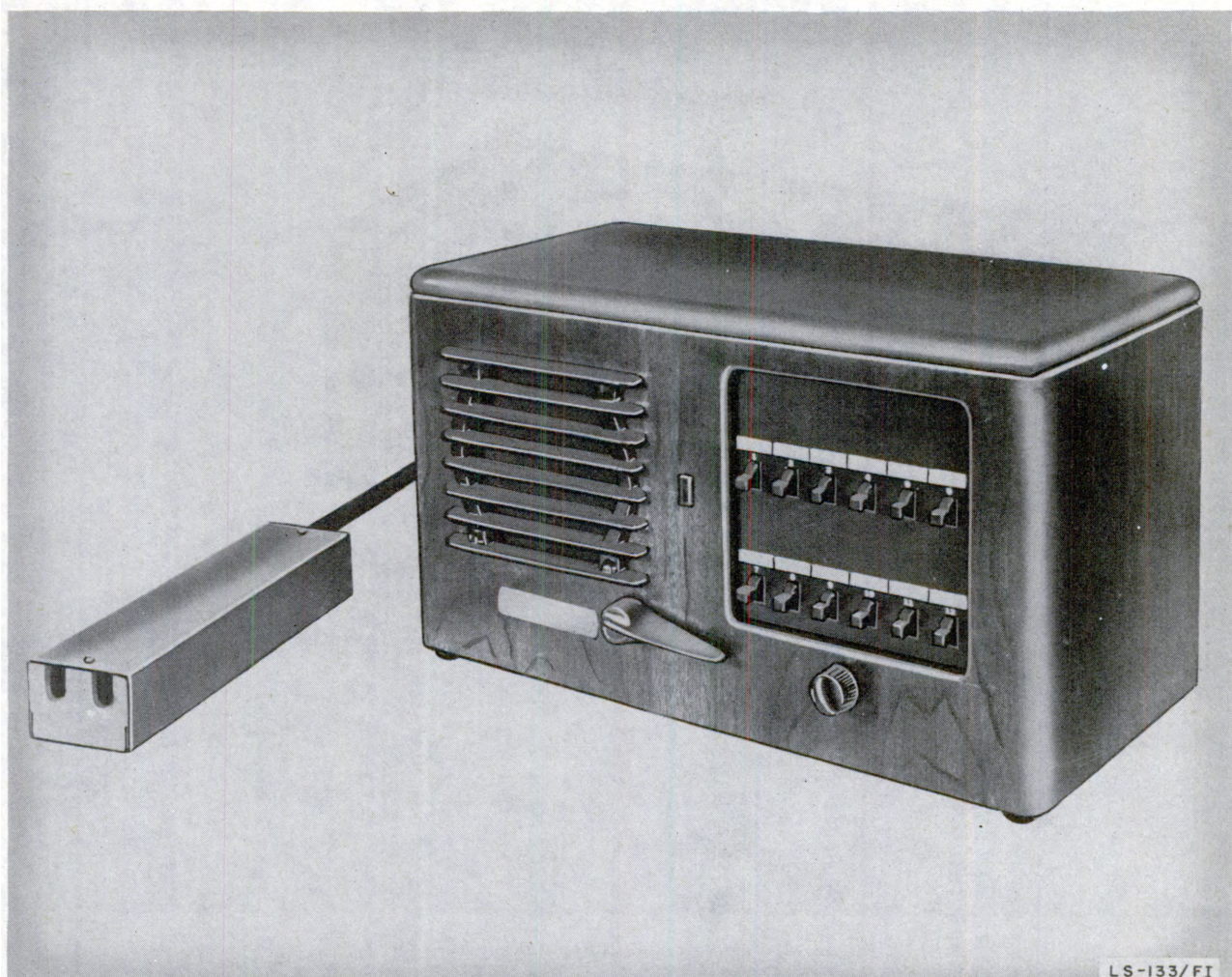

Figure 74. Intercommunicating Station LS-133/FI.

Status: Limited/Std. *Stock No.:* 4B1482MA.

Intercommunicating Station LS-133/FI is a master station unit consisting of a self-contained speaker-microphone, a three-tube amplifier, and an a-c power cord. It may be used to establish communication between itself and 12 remote stations. It also may be used to communicate with other master stations and their remote stations.

TECHNICAL CHARACTERISTICS

REMOTE STATIONS SERVED:	12.
IMPEDANCE:	Input—50 ohms. Output—50 ohms.
SPEAKER IMPEDANCE:	45 ohms.
POWER OUTPUT:	2½ w.
POWER CONSUMPTION:	15 w, idle.
POWER INPUT:	220 v, ac, 50 to 60 cps.

WEIGHTS AND DIMENSIONS

	Dimensions (in.)	Weight (lb)	Volume (cu ft)
Unpacked.....	7¾ x 6¾ x 13¾	20½	.5
Export pack.....	34 x 12 x 14	70	3.3

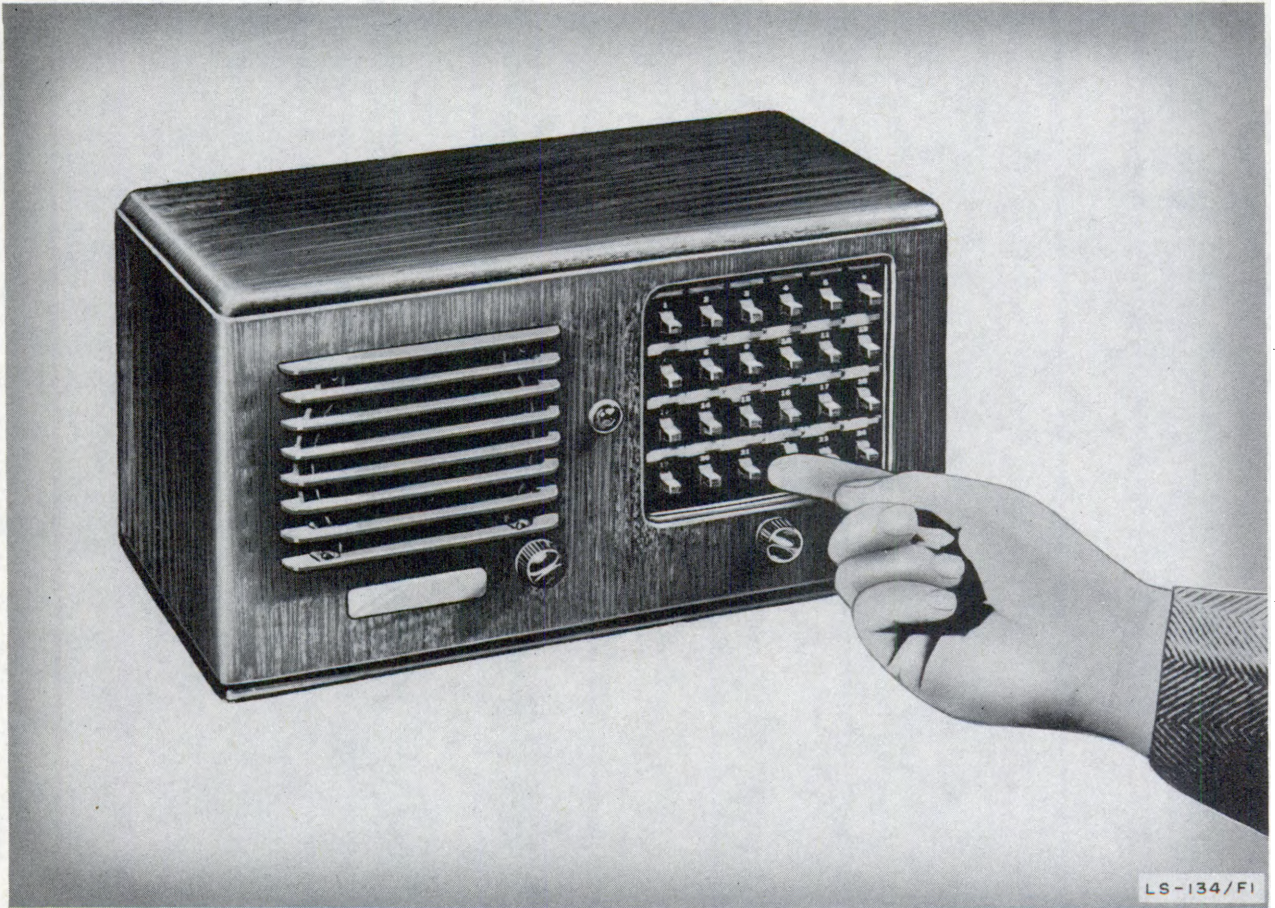

Figure 75. Intercommunicating Station LS-134/FI.

Status: Limited/Std. *Stock No.:* 4B1482S.

Intercommunicating Station LS-134/FI is a master station unit consisting of a self-contained speaker-microphone, a three-tube amplifier, and an a-c power cord. It may be used to establish communication between itself and 24 remote stations. It also may be used to communicate with other master stations and their remote stations. The circuit provides a secretive system wherein a station cannot listen in on another station without its consent, but can call in to give precedence to important messages.

TECHNICAL CHARACTERISTICS

REMOTE STATIONS SERVED.	24.
IMPEDANCE:	Input—50 ohms. Output—50 ohms.
SPEAKER IMPEDANCE:	45 ohms.
POWER OUTPUT:	2½ w.
POWER CONSUMPTION:	15 w, idle.
POWER INPUT:	110 to 125 v, ac, 50 to 60 cps.

WEIGHTS AND DIMENSIONS

	<i>Dimensions (in.)</i>	<i>Weight (lb)</i>	<i>Volume (cu ft)</i>
Unpacked	7¾ x 6¾ x 19¼	30	.75
Export pack	40 x 12 x 14	79.5	3.9



Figure 76. Intercommunicating Station LS-138/FI.

Status: Standard. *Stock No.:* 4B1482AMA.

Intercommunicating Station LS-138/FI is a master station unit consisting of a self-contained speaker-microphone, a three-tube amplifier, and an a-c power cord. It may be used to establish communication between itself and 12 remote stations. It also may be used to communicate with other master station units and their remote stations. The station is equipped with annunciators.

TECHNICAL CHARACTERISTICS

REMOTE STATIONS SERVED.	12.
IMPEDANCE:	Input—50 ohms. Output—50 ohms.
SPEAKER IMPEDANCE:	45 ohms.
POWER OUTPUT:	2½ w.
POWER CONSUMPTION:	15 w, idle.
POWER INPUT:	220 v, ac, 50 to 60 cps.

WEIGHTS AND DIMENSIONS

	Dimensions (in.)	Weight (lb)	Volume (cu ft)
Unpacked.....	7½ x 6½ x 13½	20½	.5
Export pack.....	34 x 12 x 14	70	3.3

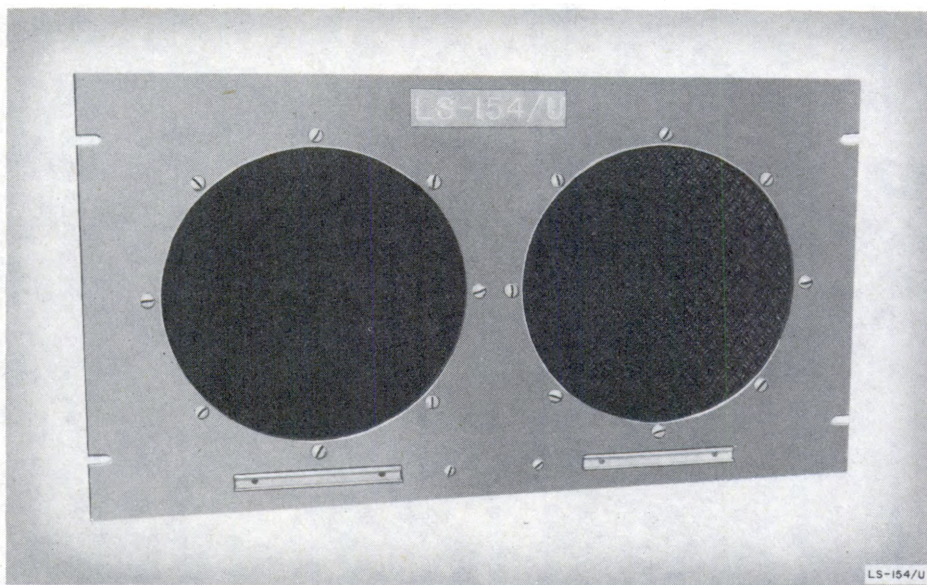

Figure 77. Speaker Assembly LS-154/U.

Status: Standard. *Stock No.:* 6C42-154.

Speaker Assembly LS-154/U consists of two 8-inch permanent magnet speakers mounted on one steel panel. The speakers are furnished with individual matching transformers. The panel is designed for a standard 19-inch radio rack mounting. The LS-154/U is designed for use with radio equipment, but may be used wherever a speaker assembly of its capabilities is needed.

TECHNICAL CHARACTERISTICS

OUTPUT POWER: 4 w.
VOICE COIL IMPEDANCE: 6 to 8 ohms.
TRANSFORMER INPUT IMPEDANCE: 500 ohms ea.

WEIGHT AND DIMENSIONS

	<i>Dimensions (in.)</i>	<i>Weight (lb)</i>	<i>Volume (cu ft)</i>
Unpacked.....	19 x 10½ x 5	18	.58

Status: Standard. *Stock No.:* 2B1657-2.

Microphone M-2/U is an aluminum finished microphone of the dynamic, moving-coil type. It is provided with a swivel for mounting on a microphone stand. Microphone M-2/U is used with various public address equipments.

P/o Public Address Set AN/TIQ-2.

TECHNICAL CHARACTERISTICS

IMPEDANCE: 100 ohms.
OUTPUT: 56 db.
FREQUENCY RESPONSE: 60 to 7,500 cps.
ANGULAR MOVEMENT: 180°.

WEIGHT

	<i>Weight (lb)</i>
Unpacked.....	.875

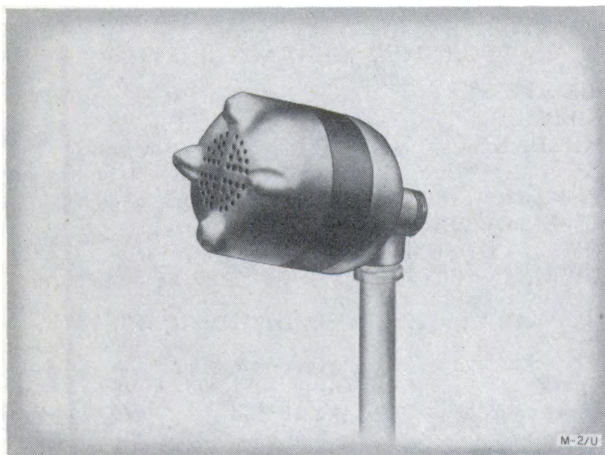

Figure 78. Microphone M-2/U.



Figure 79. Microphone M-11/U.

Status: Standard. *Stock No.:* 2B1758. *Reference:* TM 11-2588.

Microphone M-11/U is a moving-coil, semi-directional, dynamic type of microphone, mounted on a floor stand. It is used as a component of public address and sound distributing systems.

TECHNICAL CHARACTERISTICS

FREQUENCY RESPONSE: 40 to 10,000 cps, flat within 4 db.
IMPEDANCE: 20 ohms \pm 2 ohms.
OUTPUT: 82 vu, 0 level calibration
 1 mw.

DIMENSIONS

	<i>Dimensions (in.)</i>	<i>Volume (cu ft)</i>
Unpacked	4 x 2 x 66	. 31

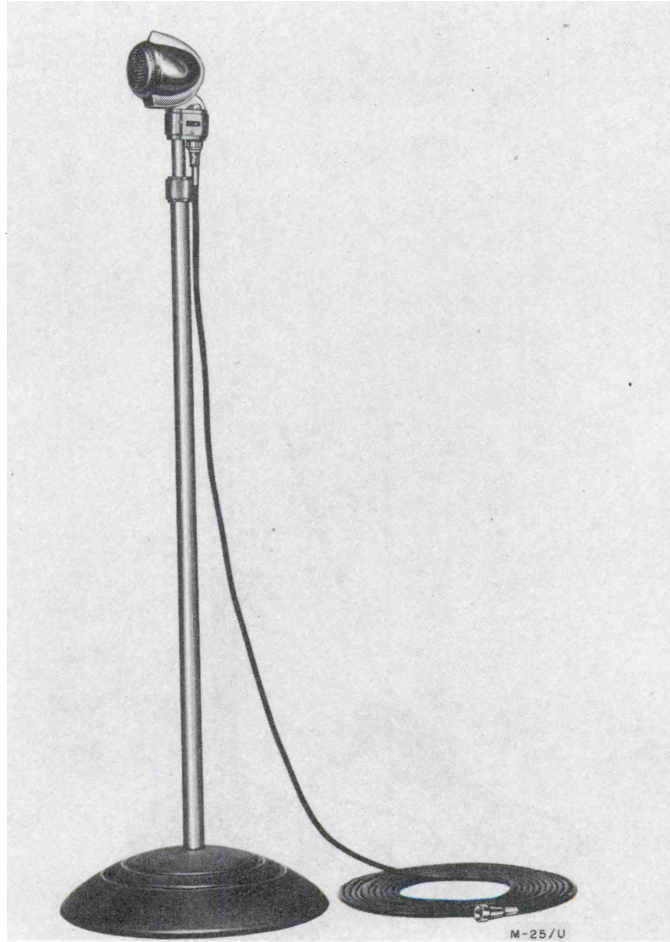

Figure 80. Microphone M-25/U.

Status: Standard. *Stock No.:* 2B1755-1. *Reference:* TM 11-2573.

Microphone M-25/U is a floor-stand mounted, dynamic, unidirectional, high-impedance microphone. The unit is supplied with a 25-foot cable and an on-off switch which shorts the microphone in the off position.

U/w but not p/o Amplifiers AM-92()/TI and AM-93/TI.

TECHNICAL CHARACTERISTICS

IMPEDANCE: 25,000 ohms.
OUTPUT LEVEL: 54 db below 1 v per bar in high-impedance circuit.
FREQUENCY RESPONSE: 50 to 9,000 cps, flat within 5 db.

• WEIGHT AND DIMENSIONS

	<i>Dimensions (in.)</i>	<i>Weight (lb)</i>
Unpacked.....	3½ x 2¾ x 2¾	1.5

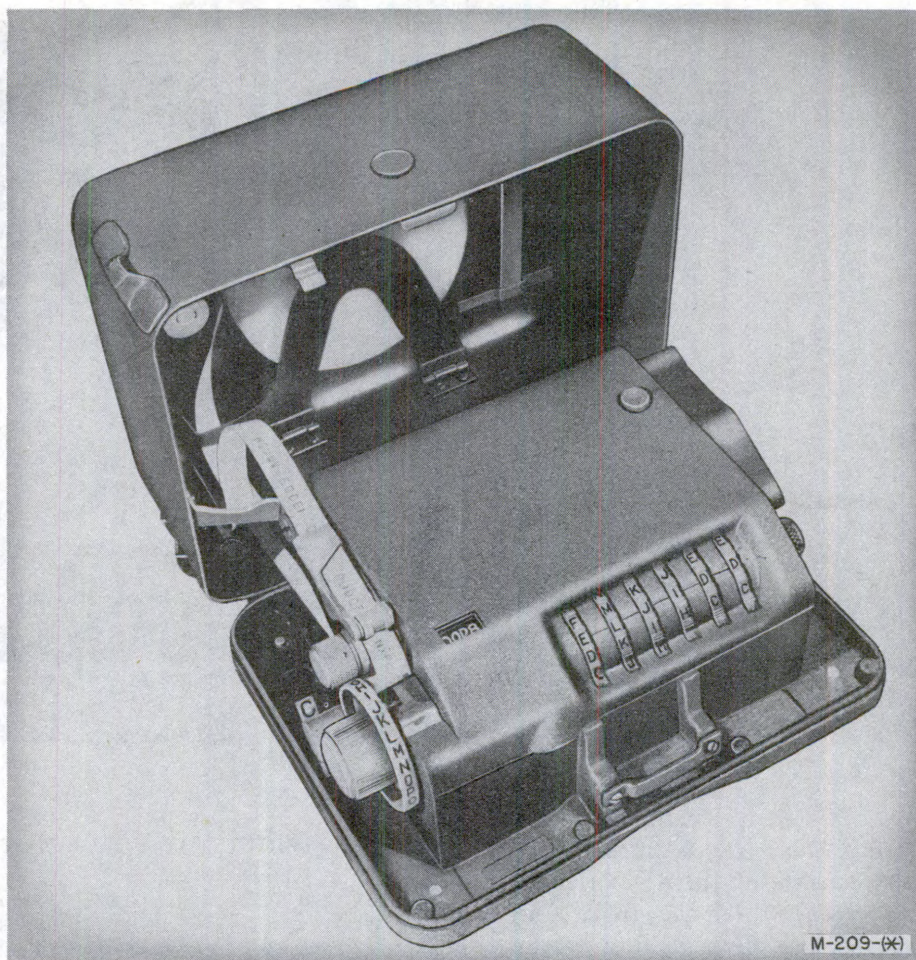

Figure 81. Converter M-209-(*).

Status: Standard. *Stock Nos.:* 6E1009 (M-209), 6E1009A (M-209-A), and 6E1009B (M-209-B). *Reference:* TM 11-380.

Converter M-209-(*), represents M-209, M-209-A, and M-209-B. Converter M-209 is a compact, hand-operated, tape-printing, mechanical cipher machine. It is contained in a metal box, and all necessary accessories are included with the equipment. Converter M-209-(*), is used to encipher plain-text messages by substituting a letter for a letter, to automatically print the enciphered text on a message tape in five-letter groups, and to decipher messages previously enciphered by a Converter M-209-(*), by printing the clear text on the paper tape.

tuting a letter for a letter, to automatically print the enciphered text on a message tape in five-letter groups, and to decipher messages previously enciphered by a Converter M-209-(*), by printing the clear text on the paper tape.

WEIGHTS AND DIMENSIONS

	Dimensions (in.)	Weight (lb)	Volume (cu ft)
Unpacked.....	7¼ x 5⅙ x 3½	6	.08
Export pack.....	10	.37

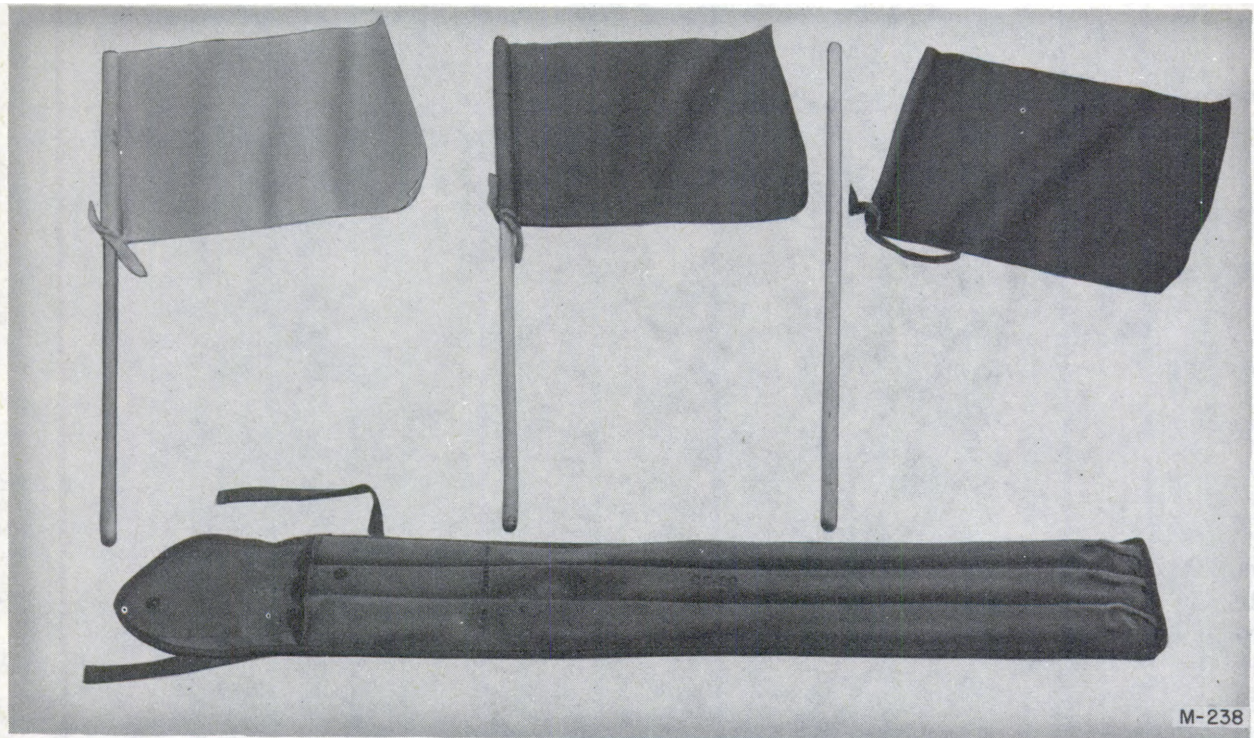

Figure 82. Flag Set M-238.

Status: Standard. *Stock No.:* 6A2238.

Flag Set M-238 consists of three colored flags (red, yellow, and green), three flagstaffs, and a carrying case. It is used for signaling between tanks.

PRINCIPAL COMPONENTS

<i>Item</i>	<i>Dimensions (in.)</i>
Flag MC-273.....	18 x 18
Flag MC-274.....	18 x 18
Flag MC-275.....	18 x 18
Flagstaff MC-270.....	36 x $\frac{1}{4}$ (diam)
Case CS-90.....	5 $\frac{1}{2}$ x 45 $\frac{1}{2}$ x 1 $\frac{1}{8}$

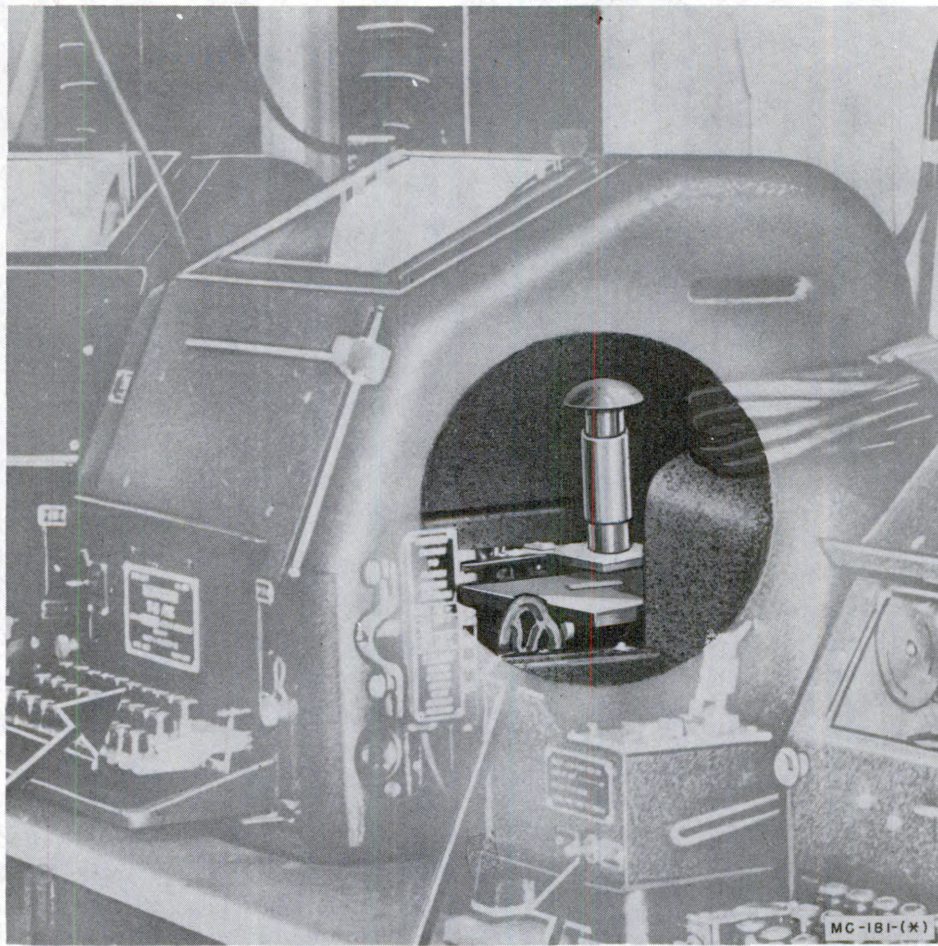

Figure 83. Stamp MC-181-A.

Status: Standard. *Stock No.:* 6M1211 (MC-181) and 6M1211A (MC-181-A).

Stamp MC-181-(*) represents MC-181 and MC-181-A. Stamp MC-181-(*) is a manually operated time stamp which prints the words MSG CENTER followed by the name of the organization, the month, date, year, and time. It is used in the message centers of divisions and higher units.

WEIGHT AND DIMENSIONS

	<i>Dimensions (in.)</i>	<i>Weight (lb)</i>	<i>Volume (cu ft)</i>
Unpacked.....	10½ x 6¼ x 6¼	8	.257



Figure 84. Record Set MC-209.

Status: Standard. *Stock No.:* 4A1959.

Record Set MC-209 is a set of three single-faced phonograph records, 12 inches in diameter, made from master molds. The recordings on the disks are code aptitude tests designed to be transmitted at 78 rpm from Turntable MX-932/U to groups of candidates to be selected for training as radio-telegraph operators.

P/o Code Practice Equipments EE-94-(), EE-95-(), and EE-96-().

TECHNICAL CHARACTERISTICS

TURNTABLE SPEED REQUIRED: 78 rpm.

WEIGHT AND DIMENSIONS

	Dimensions (in.)	Weight (lb)	Volume (cu ft)
Unpacked.....	12 x 12 x ¼	1	.03



Figure 85. Reproducing Equipment MC-364-C.

Status: Standard. *Stock Nos.:* 6C264A (MC-364-A), 6C264B (MC-364-B), and 6C264C (MC-364-C). *Reference:* TM 11-402.

Reproducing Equipment MC-364-(*), repre-

sents MC-364-A, MC-364-B, and MC-364-C. Reproducing Equipment MC-364-(*), is a portable, sound reproducer designed to play standard phonograph records. A separate film strip projector may be mounted on a tray on the reproducer when sound recordings are used with film strips. Reproducing Equipment MC-364-(*), can be used for training purposes or as a public address system by incorporating a single channel for use either as a microphone pick-up or as a mixer for superimposing speech on a recorded background.

TECHNICAL CHARACTERISTICS

TURNTABLE SPEEDS: 33½ and 78 rpm.

RECORD SIZES: 10, 12, and 16 in.

POWER REQUIRED: 80 w, when used independently; 380 w, when used with accessory film-strip projector.

POWER: 110 to 120 v, ac, 60 cps; or 220 to 250 v, a-c, 50 to 60 cps.

WEIGHT AND DIMENSIONS

	Dimensions (in.)	Weight (lb)	Volume (cu ft)
Unpacked.....	22½ x 18 x 9¾	52	2.30

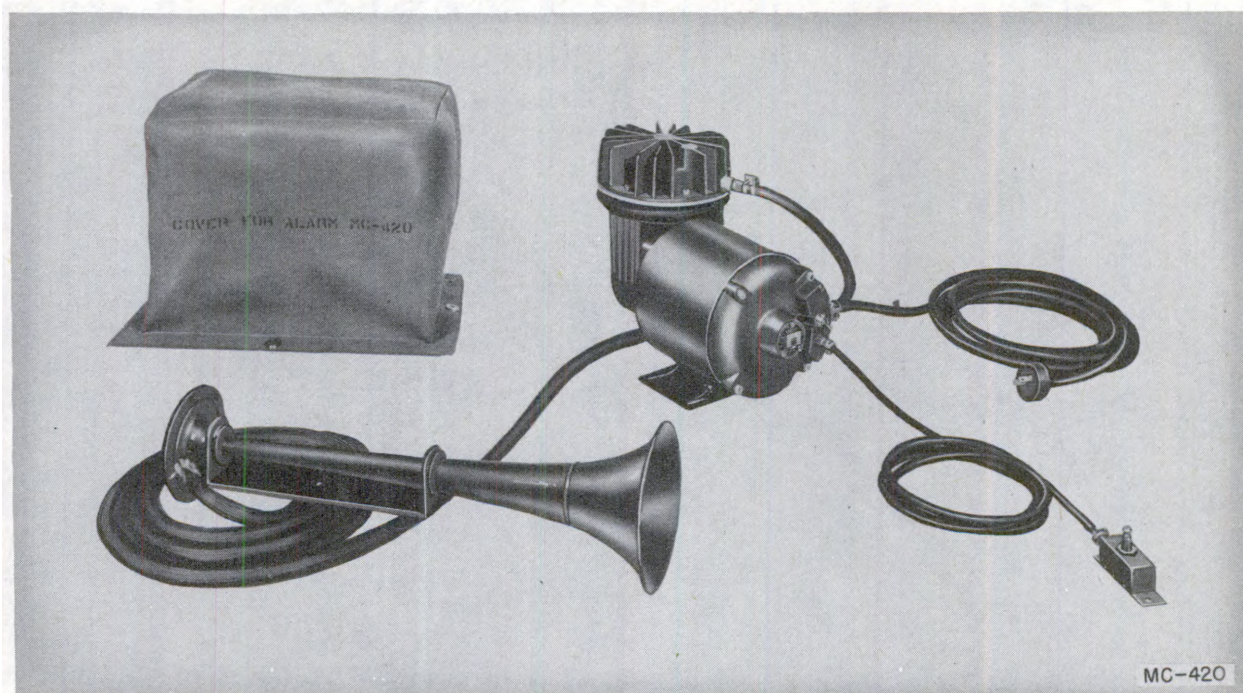

Figure 86. Alarm MC-420.

Status: Standard. *Stock No.* 6Z156.

Alarm MC-420 is a compressed air horn that produces sounds of high intensity; the horn is actuated by a continuous flow of compressed air delivered by a motor-driven compressor. The MC-420 is used for alarm and signaling purposes and may be mounted on large vehicles.

TECHNICAL CHARACTERISTICS

SOUND OUTPUT LEVEL: 92 db at a distance of 100 ft.
COMPRESSOR MOTOR: $\frac{1}{8}$ -hp, continuous duty,
1,725 rpm 110 v, ac, 60
cps input.

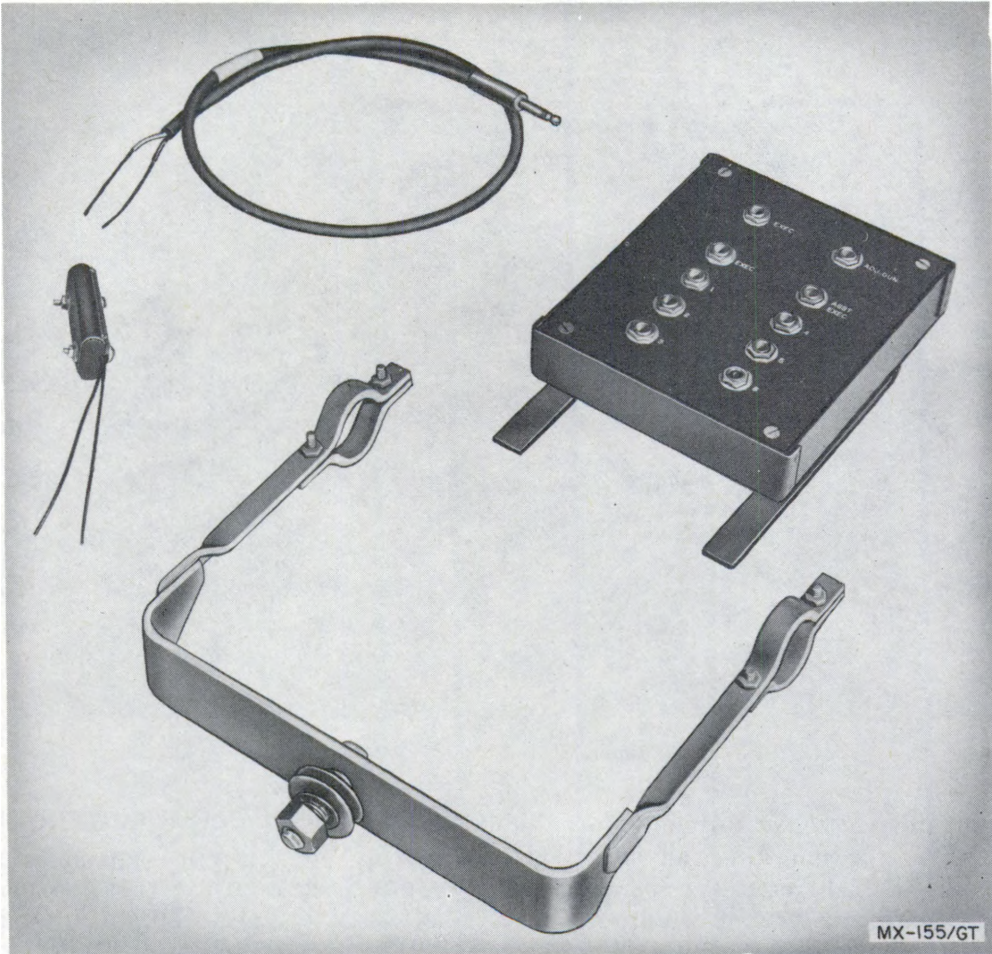

Figure 87. Connecting and Switching Kit MX-155/GT.

Status: Standard. *Stock No.:* 4C5325-155.
Reference: TM 11-2546.

Connecting and Switching Kit MX-155/GT consists of a jack panel, plugs, jacks, and a sufficient quantity of cordage. It is used to provide a quick and convenient means for establishing individual telephone circuits among the battery executive officer, the battery assistant executive officer, and the six gun sections of an armored Field Artillery battery. It also provides a means for communication between the battery executive officer and the executive officer of an adjacent gun battery.

TECHNICAL CHARACTERISTICS

CIRCUITS: EXEC and ASST EXEC and 1, 2, 3, 4, 5, and 6.
 EXEC and ADJ GUN.
POWER: None.

PRINCIPAL COMPONENTS ¹

Item	Dimensions (in.)
Jack Panel SB-16/GT.....	
7 Jack U-17/GT.....	
15 Cord CX-231/GT.....	32 (length)
7 Reel brackets.....	9 1/2 x 8 1/4

¹ Connecting and Switching Kit MX-155/GT is used in conjunction with the following equipment already issued to the battery:
 a. Telephones EE-8-().
 b. Head and Chest Sets HS-19 or equal.
 c. Reels RL-39-().
 d. 1/4-mile lengths of Wire W-130.

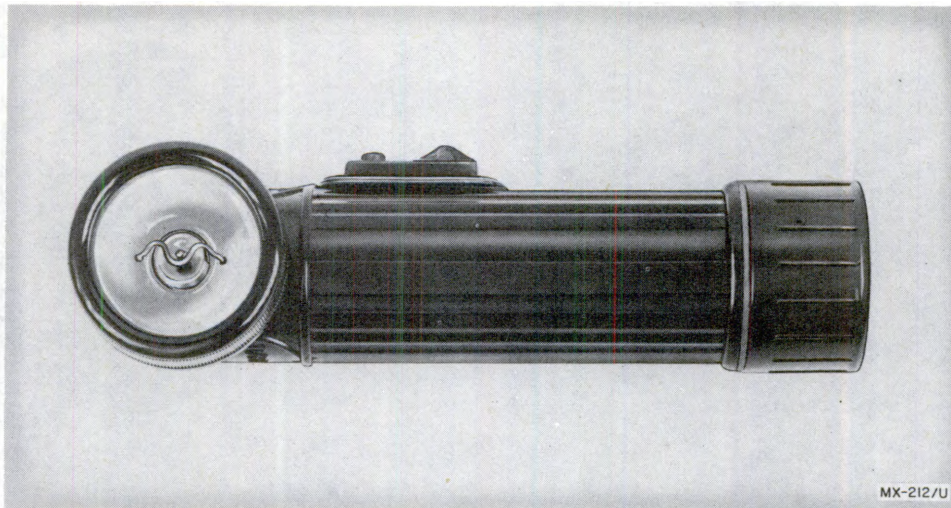

Figure 88. Flashlight MX-212/U.

Status: Standard. *Stock No.:* 6Z4007-212.

Flashlight MX-212/U is a portable flashlight contained in a right-angle tubular plastic case. It has a slide switch, and it is waterproof and explosion-proof. One Blackout Adapter M-374 and two Flashlight Filters M-384 are included with the flashlight.

TECHNICAL CHARACTERISTICS

FOCUS: Prefocused.
 LAMP: Type # PR-9 incandescent.
 POWER: Battery operated—2 Batteries BA-30.

WEIGHT AND DIMENSIONS

	Dimensions (in.)	Weight (lb)
Unpacked.....	6 $\frac{1}{2}$ x 5 $\frac{3}{4}$ (diam)	1

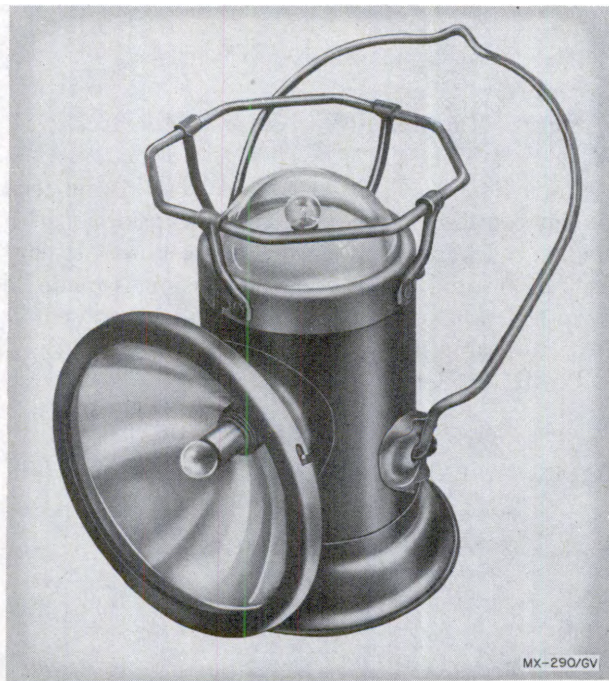

Figure 89. Lantern MX-290/GV.

Status: Standard. *Stock No.:* 6Z6914-290.

Lantern MX-290/GV is a portable, battery operated lantern used to provide illumination for emergency repairs of equipment at night or in poorly illuminated areas. A support is provided which serves the dual function of handle and tilting device. The lantern has two lamps which may be switched on alternately; one lamp provides a narrow beam by means of a reflector, the other provides diffused illumination.

TECHNICAL CHARACTERISTIC

POWER: Battery operated—1 Battery BA-200/U.

WEIGHT AND DIMENSIONS

	Dimensions (in.)	Weight (lb)	Volume (cu ft)
Unpacked.....	6 $\frac{1}{2}$ x 3 $\frac{1}{2}$ (diam)	1 $\frac{3}{4}$.04

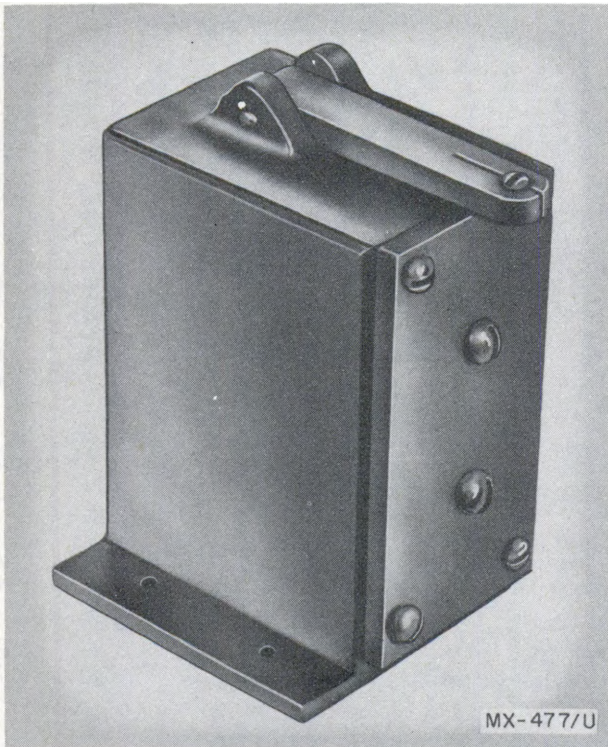

Figure 90. Magnetic release attachment MX-477/U.

Status: Standard. Stock No.: 4A2764.1. Reference: TM 11-377.

Magnetic Release Attachment MX-477/U is used with a tape puller in a high-speed keying and recording system to control the stopping and starting of the tape from a remote position. It consists of a pair of electromagnets and an armature, both mounted in a metal case.

P/o Radio Set AN/MRC-1.

TECHNICAL CHARACTERISTIC

POWER: Obtained from tape puller.

WEIGHTS AND DIMENSIONS

This equipment is shipped only with the tape bridge with which it is used.

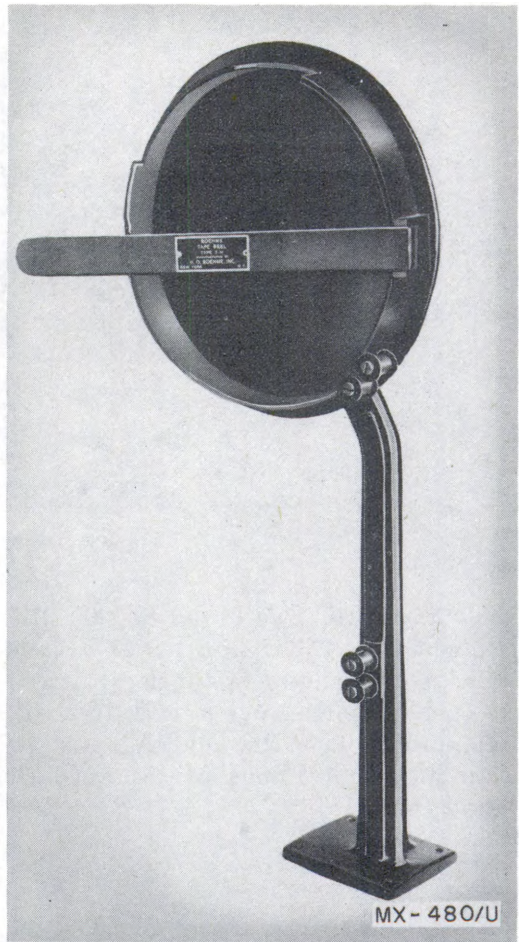

Figure 91. Tape Reel MX-480/U.

Status: Limited/Std. Stock No.: 4A2787H. Reference: TM 11-377.

Tape Reel MX-480/U is used to hold and feed paper-recording tape into the ink recorder of a high-speed keying and recording system. It consists of a stand and a reel. Provision is made to keep the tape securely in place and to prevent it from overrunning.

P/o Radio Set AN/MRC-1.

TECHNICAL CHARACTERISTIC

PAPER TAPE CAPACITY: One 8-in. diam roll of 3/8-in. wide tape.

WEIGHTS AND DIMENSIONS

	Dimensions (in.)	Weight (lb)	Volume (cu ft)
Unpacked	10 1/2 x 3 1/2 x 23	5	.50
Export pack	12 x 5 x 26	20	.90

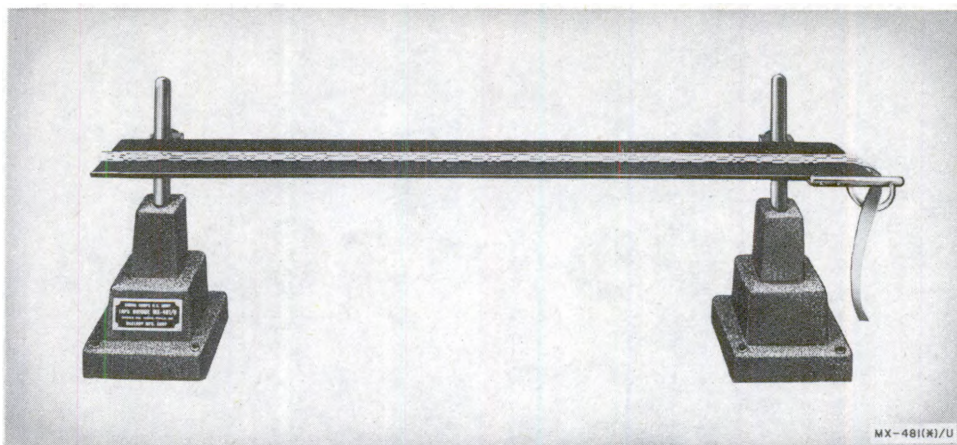

Figure 92. Tape Bridge MX-481A/U.

Status: Standard. Stock No.: 4A2744K. Reference: TM 11-377.

Tape Bridge MX-481(*)/U represents MX-481/U and MX-481A/U. Tape Bridge MX-481(*)/U is used with high-speed keying and recording equipment to guide, over the keyboard of a typewriter, the moving paper tape on which

is recorded the incoming message. The tape bridge consists of two cast metal supports attached to a paper bridge.

WEIGHTS AND DIMENSIONS

	Dimensions (in.)	Weight (lb)
Unpacked	23½ x 9¾	4½
Export pack	23 x 4 x 5¼	5

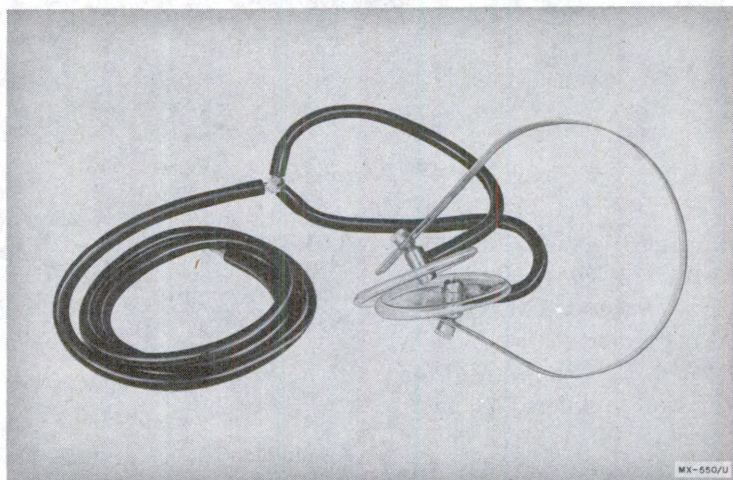

Figure 93. Acoustical Headset MX-550/U.

Status: Standard. Stock No.: 6C2-550. Reference: TM 11-2590.

Acoustical Headset MX-550/U is a sound-powered headset consisting of a metal headband, two ear cushions, and two pieces of rubber tubing 54 inches long. It is used with Loudspeakers LS-113/U and LS-122/U, and pillow speakers to enable recumbent hospital patients to listen to radio programs and other entertainment piped in over radio circuits.

U/w but not p/o Audio Distributing Central AN/FIA-1.

WEIGHTS AND DIMENSIONS

	Dimensions (in.)	Weight (lb)	Volume (cu ft)
Unpacked	1½ x 5 x 7½	.31	
Export pack ¹	16½ x 18 x 21	44.	3.6

¹ 100 per package.

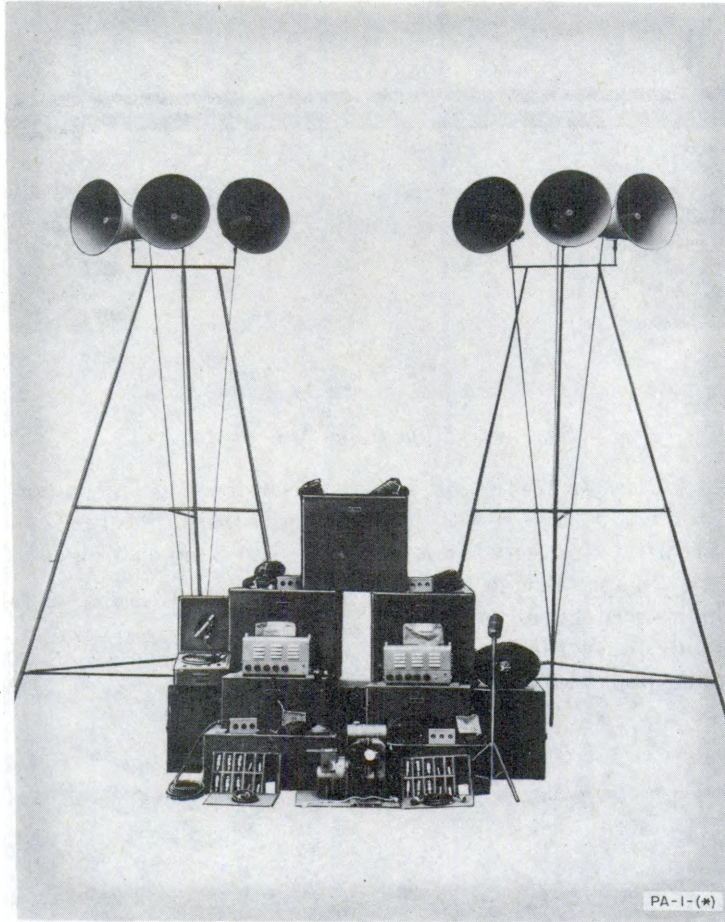

Figure 94. Public Address Set PA-1-F.

Status: Limited/Std. *Stock Nos.:* 6C201A (PA-1-A), 6C201C (PA-1-C), 6C201D (PA-1-D) and 6C201F (PA-1-F). *Reference:* TM 11-442.

Public Address Set PA-1-(*) represents PA-1-A, PA-1-C, PA-1-D, and PA-1-F. Public Address Set PA-1-(*) consists of two amplifiers, six loudspeakers, two speaker towers, a turntable, a power unit, and all necessary accessories. Public Address Set PA-1-(*) is used to amplify voice or music and project it over a large area. The sound sources are microphones, phonograph records, or radio tuners.

TECHNICAL CHARACTERISTICS

FREQUENCY RESPONSE: 50 to 10,000 cps, flat within 2.5 db.
OVER-ALL GAIN: 126 db at 1,000 cps.
HUM LEVEL: 42 db below 50-w output.

TURNTABLE SPEEDS: 33 $\frac{1}{3}$ and 78 rpm.
POWER OUTPUT: 50 w, normal; 90 w, peak.
POWER: 105 to 125 v, ac, 60 cps.

PRINCIPAL COMPONENTS

Item	Dimensions (in.)	Weight (lb)
2 Amplifiers.....	11 x 11 x 18	75 ea
Reproducer.....	9 x 15 $\frac{1}{2}$ x 19	35
Microphone D-4.....	2 x 3 (diam)	1
Microphone D-9.....	4 x 7 (diam)	2
Power Unit.....	22 $\frac{1}{2}$ x 22 $\frac{1}{4}$ x 27 $\frac{1}{2}$	150
6 Loudspeakers.....	25 x 27 (diam)	27 ea
2 Stands.....	10 x 15 x 96	70 ea

PACKED WEIGHT AND DIMENSION

	Total Weight (lb)	Total Volume (cu ft)
Export pack.....	1, 578	65

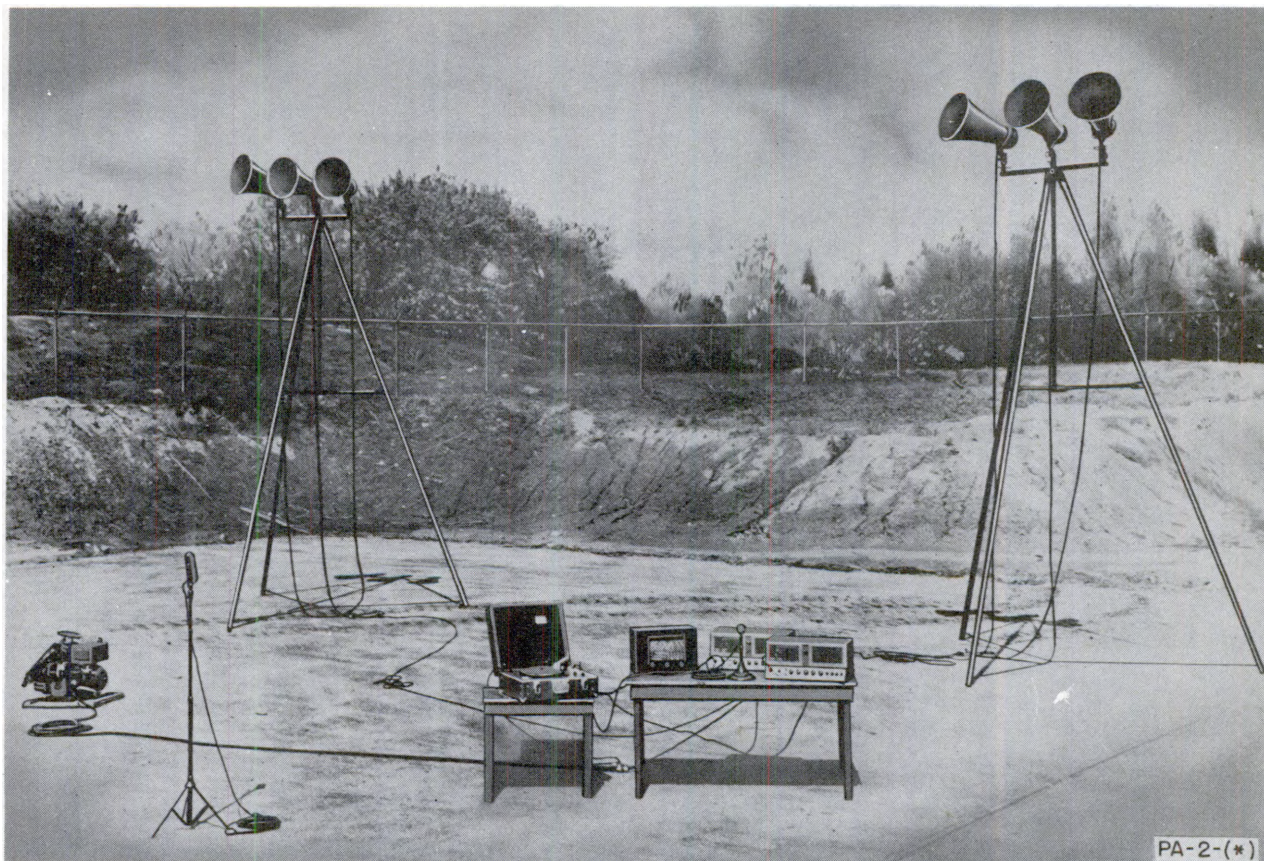

Figure 95. Public Address Set PA-2-B.

Status: Limited/Std. *Stock Nos.:* 6C202 (PA-2), 6C202A (PA-2-A), 6C202B (PA-2-B), and 6C202C.1 (PA-2-C). *Reference:* TM 11-449.

Public Address Set PA-2-(*), represents PA-2-A, PA-2-B, and PA-2-C. Public Address Set PA-2-(*), is a portable public address system consisting of two amplifiers, six loudspeakers, two stands, a phonograph, an all-wave radio tuner, two microphones, and all necessary accessories. Public Address Set PA-2-(*), is used for the amplification of speech or music. It is used indoors or outdoors.

TECHNICAL CHARACTERISTICS

TUNER FREQUENCY RANGE: 540 kc to 22.5 mc.
FREQUENCY RESPONSE: Microphones—40 to 10,000 cps.
TURNTABLE SPEEDS: 33 $\frac{1}{3}$ and 78 rpm.
POWER OUTPUT: 50 w.
POWER: 115 v, ac, 60 cps, or from Power Unit PE-75-(*).

PRINCIPAL COMPONENTS

Item	Dimensions (in.)	Weight (lb)
Radio tuner RCA No. MI-5056.		
Phonograph RCA No. MI-4829-B.	21 $\frac{1}{2}$ x 19 $\frac{1}{8}$ x 9 $\frac{1}{2}$	32
2 Amplifier RCA No. MI-12214-GI.	23 x 9 $\frac{1}{2}$ x 12	50 ea
6 Loudspeaker RCA No. MI-2924-2.	18 $\frac{1}{2}$ x 18 $\frac{1}{2}$ x 29 $\frac{1}{4}$	19 $\frac{1}{2}$ ea
2 Stand RCA No. MI-2969.	124 (length)	125 ea
Microphone RCA No. MI-6226-J.	2 $\frac{1}{8}$ x 3 x 3 $\frac{3}{8}$	2 $\frac{1}{4}$
Microphone RCA No. MI-2199.	3 $\frac{3}{4}$ x 8 x 2 $\frac{5}{8}$	2
Power Unit PE-75-()	36 x 19 $\frac{1}{2}$ x 26 $\frac{1}{2}$	330

PACKED WEIGHT AND VOLUME

	Total weight (lb)	Total volume (cu ft)
Export pack-----	2,000	80



Figure 96. Public Address Equipment PA-4-C.

Status: Limited/Std. Stock No.: 6C204. Reference: TM 11-435.

Public Address Equipment PA-4(*) represents PA-4, PA-4-A, PA-4-B, and PA-4-C. Public Address Equipment PA-4(*) is a lightweight, portable public address system consisting of an amplifier, a loudspeaker, a microphone, a shoulder harness, a tripod, and all necessary connectors. Public Address Equipment PA-4(*) is used for speech amplification in limited areas for mobile or stationary use.

TECHNICAL CHARACTERISTICS

IMPEDANCE: Input—250 ohms for carbon microphone.
Output—3.5 ohms.

POWER OUTPUT: 2 w, undistorted.
POWER: Battery operated—4 Batteries BA-30, 2 Batteries BA-51.

PRINCIPAL COMPONENTS

Item	Dimensions (in.)	Weight (lb)
Amplifier BC-641-()	8 $\frac{3}{8}$ x 8 $\frac{1}{4}$ x 3 $\frac{3}{16}$	7
Loudspeaker LS-6-()	14 $\frac{1}{2}$ x 10 $\frac{3}{8}$ (diam)	6
Microphone T-36-()		$\frac{1}{2}$
Tripod M-230-()	53 $\frac{1}{2}$ (extended)	1 $\frac{3}{4}$

PACKED WEIGHT AND VOLUME

	Weight (lb)	Volume (cu ft)
Export pack	38.5	2.5

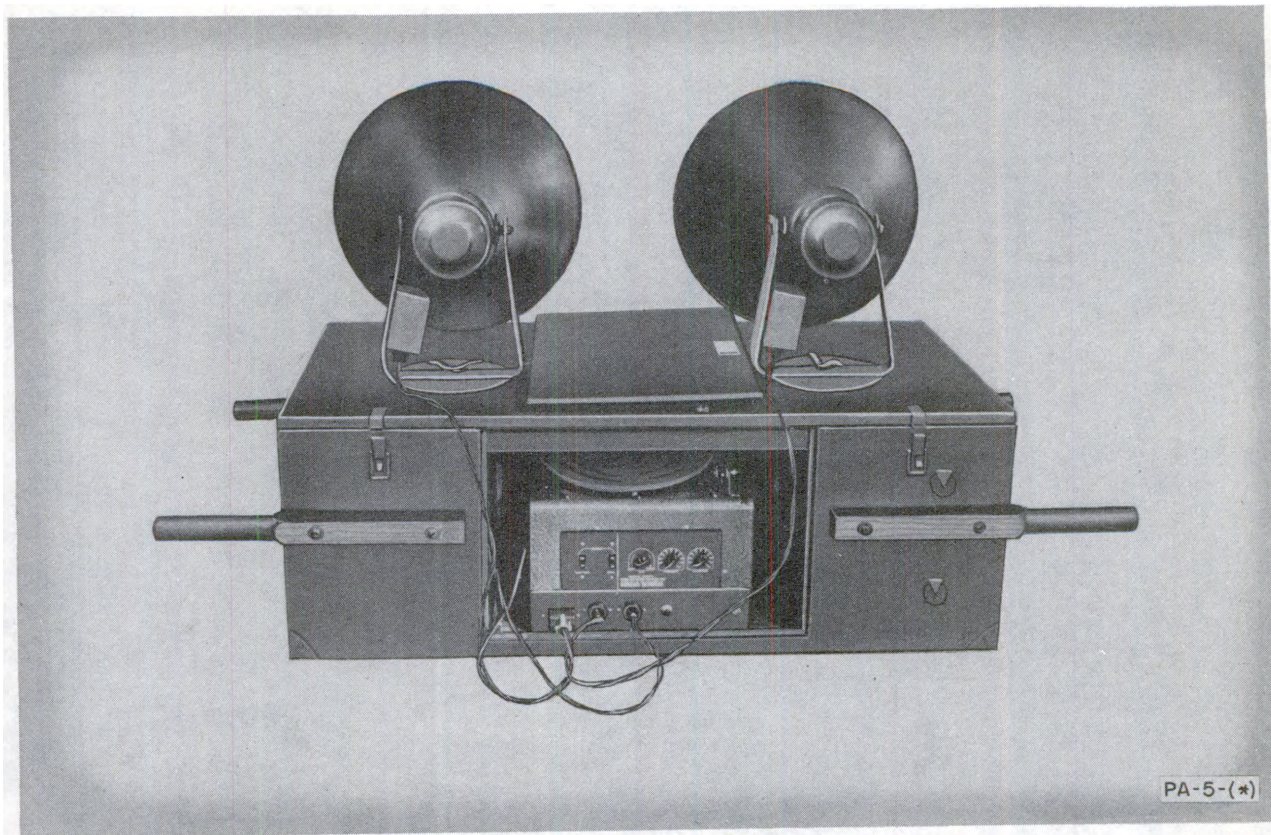

Figure 97. Public Address Set PA-5.

Status: Substitute/Std. *Stock No.:* 6C205.
Reference: TM 11-2504.

Public Address Set PA-5-(*), represents PA-5, PA-5-A, and PA-5-B. Public Address Set PA-5-(*), is a portable public address system consisting of a combination amplifier and record player, two loudspeakers and stands, a rectifier, a microphone, and all necessary connectors. Public Address Set PA-5-(*), is used for fixed or mobile operations. It reproduces sound either through the use of microphone or record reproduction.

TECHNICAL CHARACTERISTICS

POWER OUTPUT: 20 w at 5 percent distortion when operated from a-c power.
 16 w at 5 percent distortion when battery operated.

POWER: 110 to 117 v, ac, 60 cps or one 6-v storage battery.

PRINCIPAL COMPONENTS

Item	Dimensions (in.)	Weight (lb)
Amplifier and Record Player BC-1292.	16½ x 11¾ x 10½	33½
Microphone T-55	5¾ x 2½ x 1½	1½
2 Loudspeaker Stand M-405	48 x 36 x 32	10¼ ea
2 Loudspeaker LS-12-	21½ x 19 (diam)	46 ea

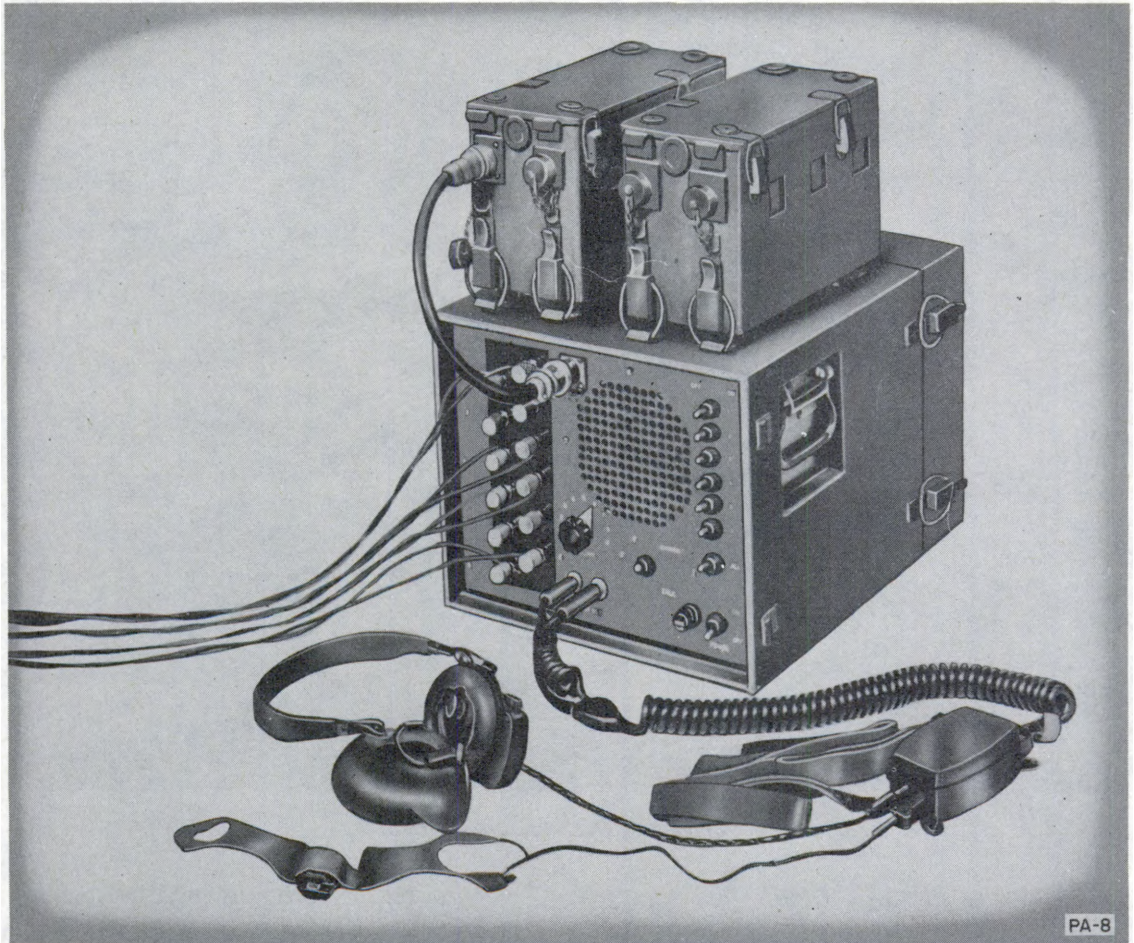

Figure 98. Intercommunication Set PA-8.

Status: Standard. Stock No.: 6C208. Reference: TM 11-2564.

Intercommunication Set PA-8 consists of a control-amplifier unit, four loudspeakers, three battery boxes, and associated equipment, including head and chest set, microphone, cords, and extension cord. Intercommunication Set PA-8 is used in the field to maintain communication between a battery executive officer and a number of remotely located gun crews. All of the components of the set are inclosed in watertight cabinets which permit the operation of the set under adverse weather conditions.

TECHNICAL CHARACTERISTICS

REMOTE STATIONS SERVED. 6 max.
 FREQUENCY RESPONSE: 500 to 5,000 cps.
 COMMUNICATION RANGE: 5 mi between remote station and control station.

POWER OUTPUT: 1.5 w.
 POWER: Battery operated—3 Batteries BB-54-(*).

PRINCIPAL COMPONENTS

Item	Dimensions (in.)	Weight (lb)
Control Amplifier Unit BC-1346.	10 $\frac{1}{2}$ x 16 x 13 $\frac{1}{2}$	36
4 Loudspeaker LS-13.....	7 x 11 $\frac{1}{8}$ x 8 $\frac{1}{2}$	11 $\frac{1}{4}$ ea
9 Battery BB-54-().....	5 $\frac{1}{2}$ x 3 x 4	3 $\frac{3}{4}$ ea
Box CH-291.....	6 $\frac{1}{4}$ x 11 $\frac{1}{4}$ x 5 $\frac{1}{2}$	3 $\frac{1}{4}$
Chest Set TD-4.....	1 $\frac{1}{8}$ x 3 x 6	.7
Headset H-16/U.....	8 x 3 $\frac{3}{4}$ x 6	.75
Microphone T-45.....	$\frac{3}{8}$ x 1 $\frac{1}{4}$ x 1 $\frac{1}{4}$.11

WEIGHTS AND VOLUMES

	Total weight (lb)	Total volume (cu ft)
Unpacked.....	125	4.5
Export pack.....	296	17

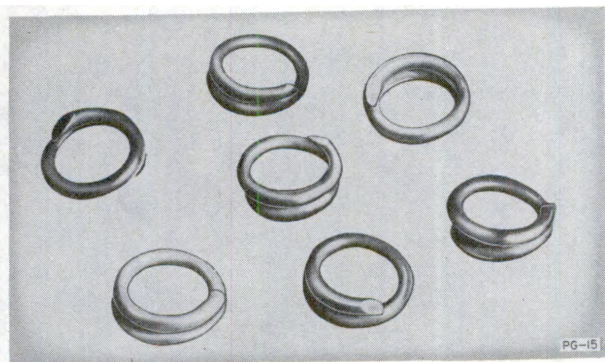

Figure 99. Band PG-15.

Stock Nos.: 9A315 (assorted colors), 9A315G (green), 9A315B (light blue), 9A315P (pink), 9A315BK (black), 9A315R (red), 9A315DB (dark blue), and 9A315Y (yellow). **Reference:** TM 11-410.

Band PG-15 is a spiral, celluloid leg band used for special identification of pigeons. It consists of a coil of $1\frac{1}{2}$ turns. The inside diameter of the coil is approximately $\frac{5}{16}$ inch and the band is $\frac{3}{16}$ inch high. Band PG-15 is available in light blue, black, dark blue, green, pink, red, and yellow.

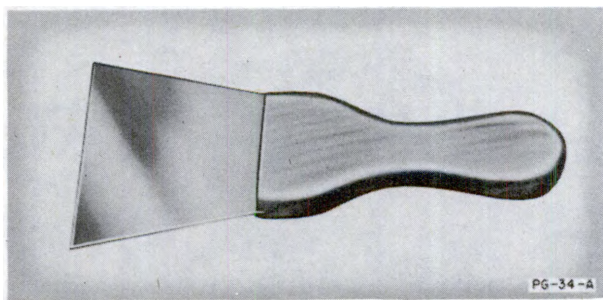

Figure 100. Scraper PG-34-A.

Stock No.: 9A2034A. **Reference:** TM 11-410.

Scraper PG-34-A is a knife type scraper used to clean pigeon lofts and cages. It consists of a metal blade $4\frac{1}{4}$ inches long by 3 inches wide set in a stiff, noninflammable composition or Cocobolo-wood handle $3\frac{3}{4}$ inches long.

PG-15 PG-34-A PG-35 PG-36



Figure 101. Sieve PG-35.

Status: Standard. **Stock No.:** 9A2035. **Reference:** TM 11-410.

Sieve PG-35 is an item of equipment used in pigeon loft maintenance and for examining feed for the presence of insects. The frame is approximately 14 inches in diameter and the copper screen is $\frac{1}{16}$ -inch mesh. The net weight of Sieve PG-35 is .4 pound. The packed weight is .5 pound.



Figure 102. Brush PG-36.

Status: Standard. **Stock No.:** 9A636. **Reference:** TM 11-410.

Brush PG-36 is a counter duster used to clean pigeon lofts and cages. It is 9 inches long. The net weight of Brush PG-36 is 1 pound. The packed weight is 1.25 pounds.

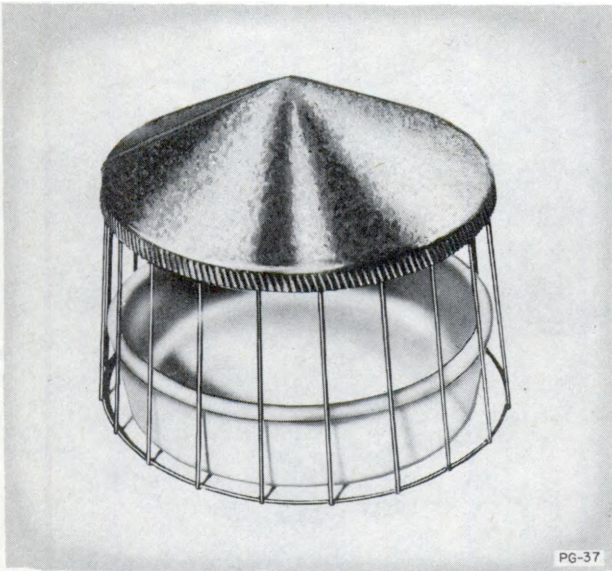

Figure 103 Fountain PG-37.

Status: Standard. *Stock No.:* 9A1237. *Reference:* TM 11-410.

Fountain PG-37 is an English-type, earthenware receptacle with an enamel pan used for watering pigeons. It is equipped with an overhanging, galvanized iron cover and a galvanized iron guard. The pan is 3 inches high. The guard is 12 inches in diameter. The net weight of Fountain PG-37 is 6 pounds. The packed weight is 10 pounds.

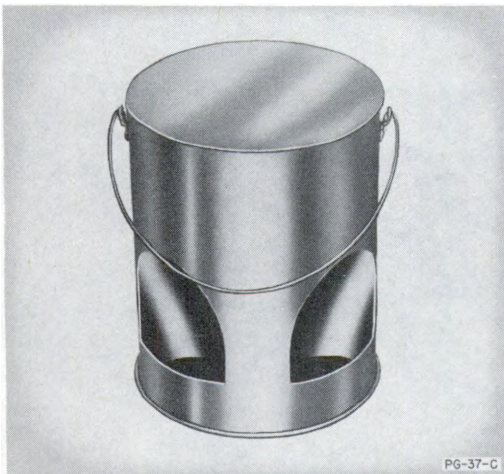

Figure 104. Fountain PG-37-C.

Stock No.: 9A1237C. *Reference:* TM 11-410.

Fountain PG-37-C is a two-section, telescopic, self-filling, double-opening, galvanized iron drinking fountain used for watering pigeons. The fountain is equipped with a carrying handle. Fountain PG-37-C has a capacity of 1½ gallons.



Figure 105. Pan PG-38.

Status: Standard. *Stock No.:* 9A1838. *Reference:* TM 11-410.

Pan PG-38 is a galvanized iron receptacle used to provide bath water for pigeons. The bottom of the pan is 23 inches in diameter; the top is 27¼ inches in diameter. It is 6 inches deep. The net weight of Pan PG-38 is 12.5 pounds. The packed weight is 15 pounds.

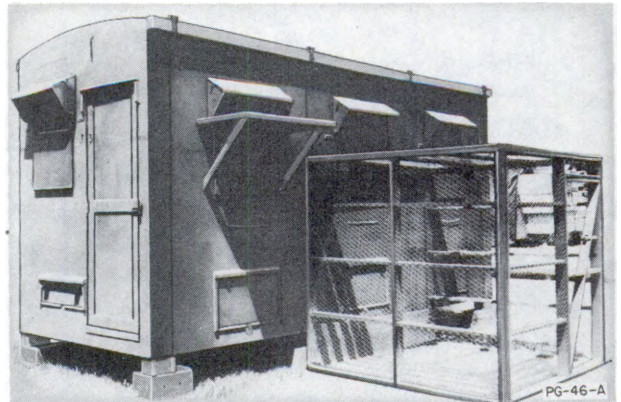

Figure 106. Loft PG-46-A.

Stock No.: 9A1646A. *Reference:* TM 11-410.

Loft PG-46-A is a portable, sectional housing for 60 pigeons. The loft may be enlarged to accommodate more pigeons by adding sections. It is used by Signal Pigeon Companies and permanent installations for breeding young homing pigeons.

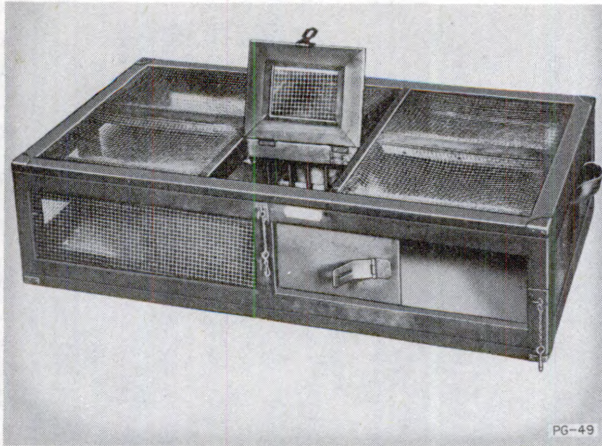

Figure 107. Crate PG-49.

Status: Standard. *Stock No.:* 9A939. *Reference:* TM 11-410.

Crate PG-49 is a crate used to transport up to 20 pigeons for any distance for universal purposes in pigeon service. The crate frame is covered with #2 wire mesh. The floor is heavy canvas. Crate PG-49 has a small hinged door on top, a smaller hinged door leading to the water compartment at the back, and a large sliding metal door at the front. It has two carrying handles. Crate PG-49 is 44 inches long by 24 inches wide by 12 inches high and it weighs 25 pounds.

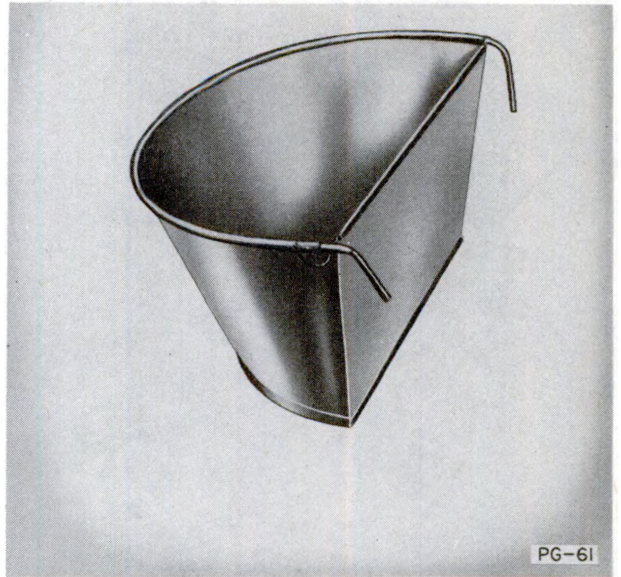

Figure 109. Cup PG-61.

Status: Standard. *Stock No.:* 9A941. *Reference:* TM 11-410.

Cup PG-61 is a one-half-pint galvanized iron cup used for watering or feeding pigeons in separate compartments or cages. The top and bottom of the cup are semicircular. The front of the cup is curved; the back is a flat surface so that the cup will rest against the side of the cage when it is suspended by the two hooks at the top and back of the cup.

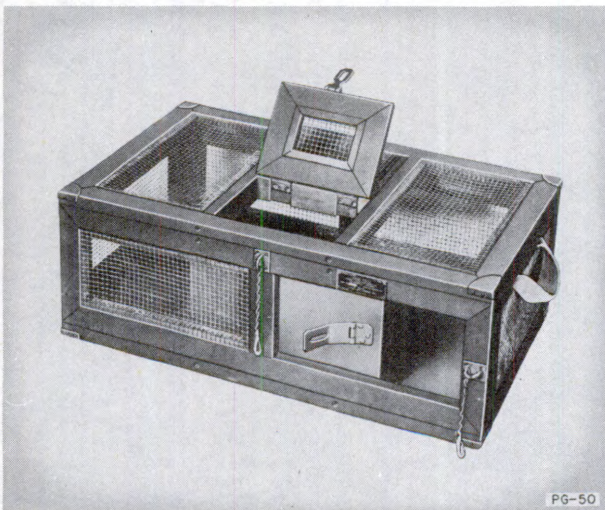

Figure 108. Cage PG-50.

Status: Standard. *Stock No.:* 9A725. *Reference:* TM 11-410.

Cage PG-50 is a collapsible cage used to transport up to 10 pigeons for training purposes. It is 30 inches long by 18 inches wide by 12 inches high and it weighs 15 pounds.



Figure 110. Message Holder PG-67.

Status: Standard. *Stock No.:* 9A1767. *Reference:* TM 11-410.

Message Holder PH-67 is a capsule-type, transparent, cellulose acetate message container made in two sections that screw together. The ends are hemispherical. A leg attachment, firmly affixed to the message holder, provides for fastening it to the band on the pigeon's leg. Message Holder PG-67 is 1½ inches long by ½ inch in diameter.

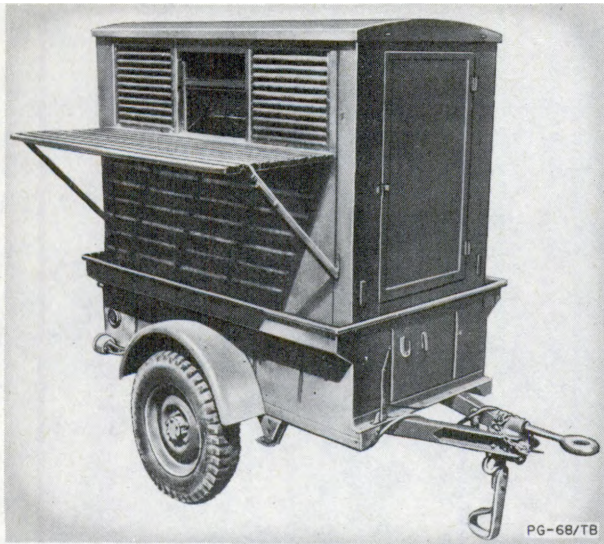

Figure 111. Loft PG-68/TB.

Status: Standard. *Stock No.:* 9A1648. *Reference:* TM 11-410.

Loft PG-68/TB is a transportable, collapsible housing for pigeons used in training and in combat. The loft can be transported in a $\frac{1}{4}$ -ton, two-wheel trailer; three lofts can be transported in a $2\frac{1}{2}$ -ton truck. Loft PG-68/TB measures $62\frac{1}{2}$ by 37 by $63\frac{1}{2}$ inches and it weighs approximately 250 pounds.

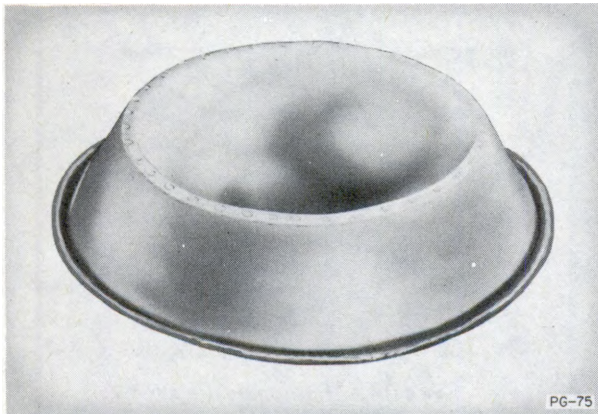

Figure 112. Bowl PG-75.

Stock No.: 9A575. *Reference:* TM 11-410.

Bowl PG-75 is a pressed wood-pulp concave receptacle used as a nesting place for pigeons. The base is $10\frac{1}{2}$ inches in diameter and the top is $7\frac{3}{8}$ inches in diameter. The concave portion of the bowl is $2\frac{1}{8}$ inches.

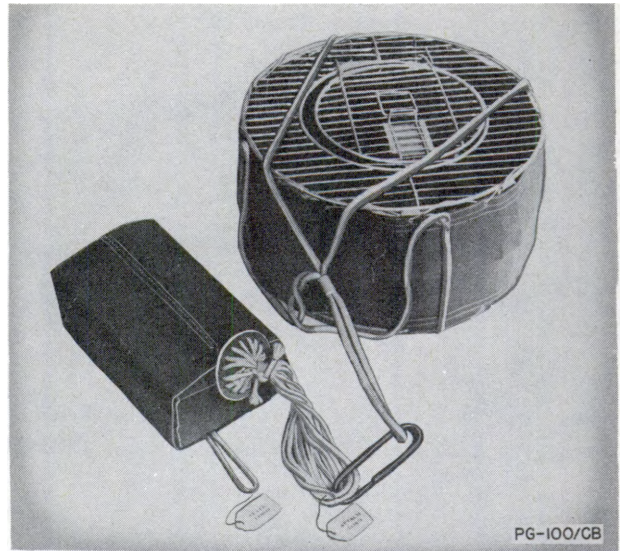

Figure 113. Parachute Equipment PG-100/CB.

Status: Standard. *Stock No.:* 9A1845-100. *Reference:* TM 11-410.

Parachute Equipment PG-100/CB is a collapsible, cylindrical, wire frame, four-bird container used to deliver pigeons by air. The container is 13 inches in diameter by $6\frac{1}{2}$ inches high. It is attached to a 6-foot hemispherical, baseball-type, cotton parachute equipped with a quick-release clip. The net weight of Parachute Equipment PG-100/CB is 7 pounds. The packed weight is 8 pounds.

Pigeon Equipment PG-103/CB is a two-bird unit used to deliver pigeons to combat units. The complete unit of issue includes a light plywood Container PG-102/CB containing feed and water facilities, 12 Message Holders PG-67, a tissue map overlay pad (S. C. Form No. 181), 2 drawing pencils, and a Message Book M-210-A. The net weight of Pigeon Equipment PG-103/CB is 7 pounds. The packed weight is 8 pounds. The volume is .620 cubic feet.

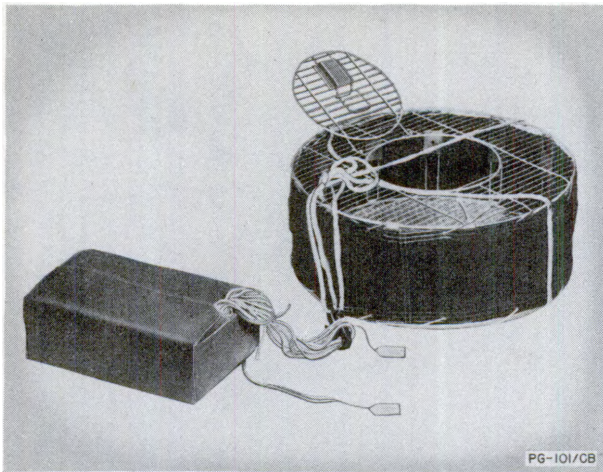

Figure 114. Parachute Equipment PG-101/CB.

Status: Standard. Stock No.: 9A1845-101. Reference: TM 11-410.

Parachute Equipment PG-101/CB is a collapsible, cylindrical, wire frame, eight-bird container used to deliver pigeons by air. The container is 17 inches in diameter by 6½ inches high. It is attached to a 9-foot hemispherical, baseball-type, cotton parachute equipped with a quick-release clip. The net weight of Parachute Equipment PG-101/CB is 8.5 pounds. The packed weight is 10 pounds.

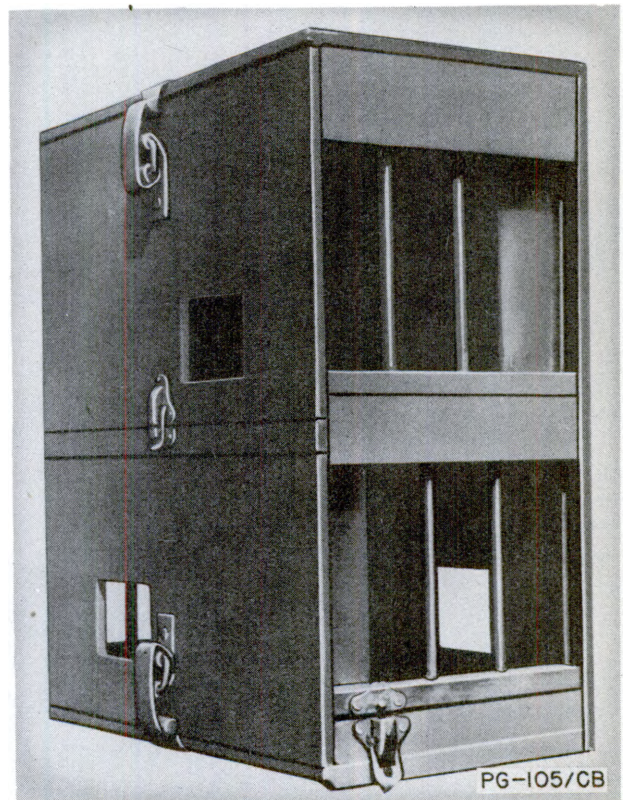

Figure 116. Pigeon Equipment PG-105/CB.

Status: Standard. Stock No.: 9A1857-105. Reference: TM 11-410.

Pigeon Equipment PG-105/CB is a four-bird unit used to deliver pigeons to combat units. The complete unit of issue includes a light plywood Container PG-104/CB containing feed and water facilities, 24 Message Holders PG-67, a tissue map overlay pad (S. C. Form No. 181), 2 drawing pencils, and a Message Book M-210-A. The net weight of Pigeon Equipment PG-105/CB is 10.5 pounds. The packed weight is 12 pounds. The volume is 1.08 cubic feet.

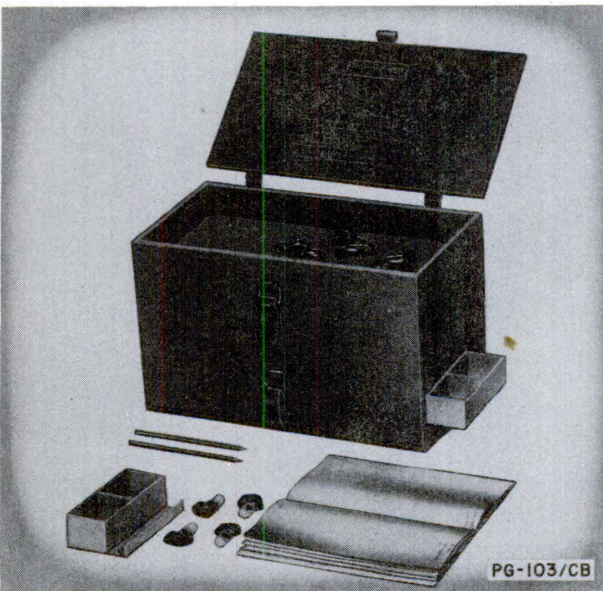

Figure 115. Pigeon Equipment PG-103/CB.

Status: Standard. Stock No.: 9A1857-103. Reference: TM 11-410.

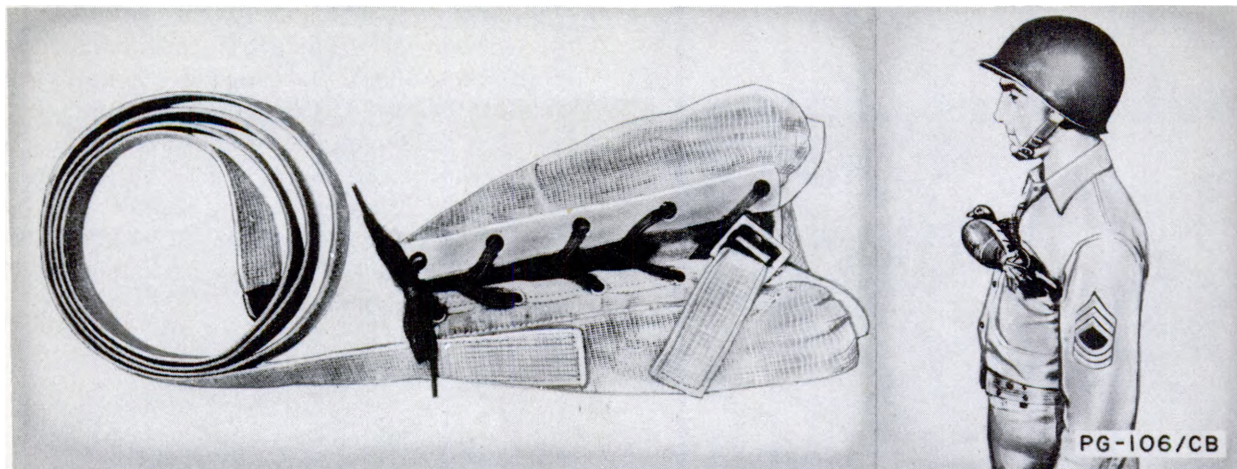

Figure 117. Pigeon Vest PG-106/CB.

Status: Standard. *Stock No.:* 9A1886-106. *Reference:* TM 11-410.

Pigeon Vest PG-106/CB is an adjustable, porous fabric vest shaped to fit any size pigeon and used by paratroopers or scouting patrols to carry one

pigeon per man. Each vest is provided with an attached strap for carrying the pigeon on the man's chest. Pigeon Vest PG-106/CB permits the pigeon's head, neck, wing tips, tail, and feet to protrude from the vest.

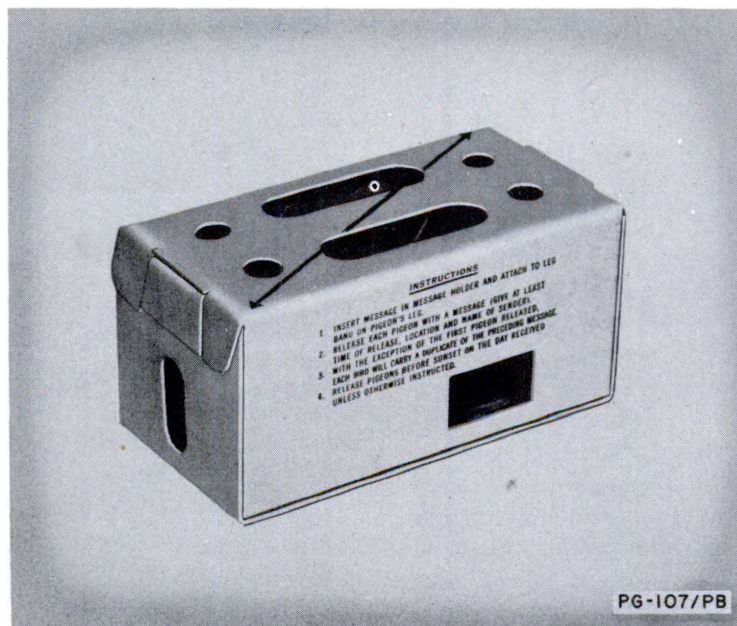

Figure 118. Container PG-107/PB.

Stock No.: 9A837. *Reference:* TM 11-410.

Container PG-107/PB is a two-bird, collapsible, .080 fiberboard container used to transport pigeons to using organizations. The inside dimensions of the assembled container are 11½ inches

long by 6 inches square. The container, when folded flat, measures approximately 15 by 12 inches. The net weight of Container PG-107/PB is 1 pound.

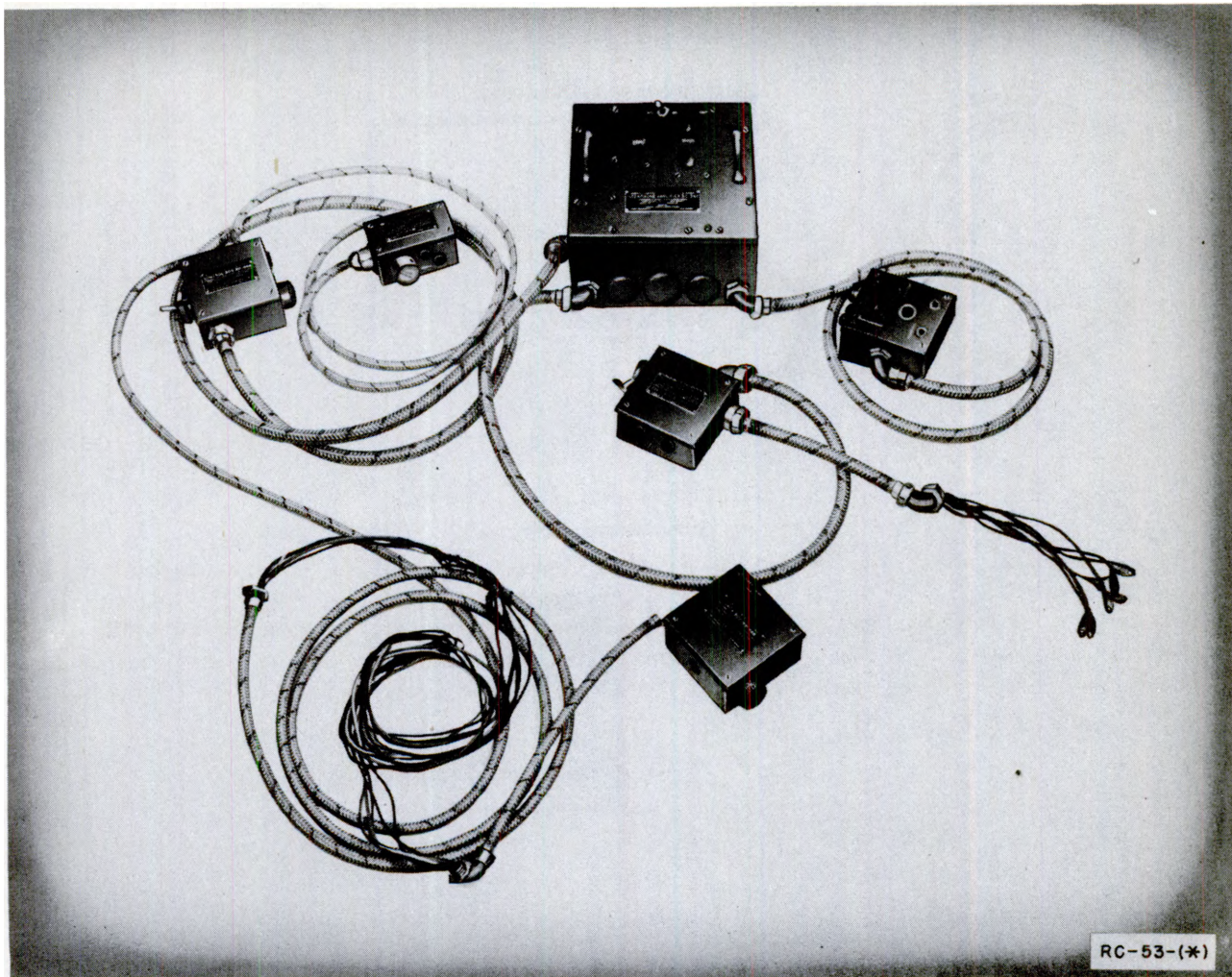

Figure 119. Interphone Equipment RC-53.

Status: Limited/Std. Reference: TM 11-700.

Interphone Equipment RC-53-(*) represents RC-53 and RC-53-A. Interphone Equipment RC-53-(*) is a six-station, intra-vehicular system for use in medium tanks. In addition to providing voice communication between all members of the vehicular crew, the interphone equipment enables the radio operator and tank commander to retain partial control of the vehicular radio apparatus for intervehicular and base-station voice communication.

TECHNICAL CHARACTERISTICS

POWER OUTPUT: 2 w.
 POWER INPUT: RC-53—12-v, 168 amp-hr, vehicular storage battery; 3.0 to 3.5 amp, operating current.
 RC-53-A—12-v, 168 amp-hr, vehicular storage battery; 1.5 to 2.0 amp, operating current.

PRINCIPAL COMPONENTS

Item	Dimensions (in.)	Weight (lb)
Control Box BC-422.....	4 x 4 x 2	2
Control Box BC-449.....	4 x 4 x 2	1.7
6 Headset HS-18.....		
Interphone Amplifier BC-367. ¹	8¼ x 8¼ x 4½	18.5
Interphone Amplifier BC-667. ²	8¼ x 8¼ x 4½	18.5
Jack Box BC-378 ¹	4 x 4 x 2	3.2
Jack Box BC-379.....	4 x 4 x 2	1.3
Jack Box BC-448.....	4 x 4 x 2	1.7
Jack Box BC-678 ²	4 x 4 x 2	3.2
5 Microphone T-30-A.....	-----	.3 ea

¹ RC-53 only.
² RC-53-A only.

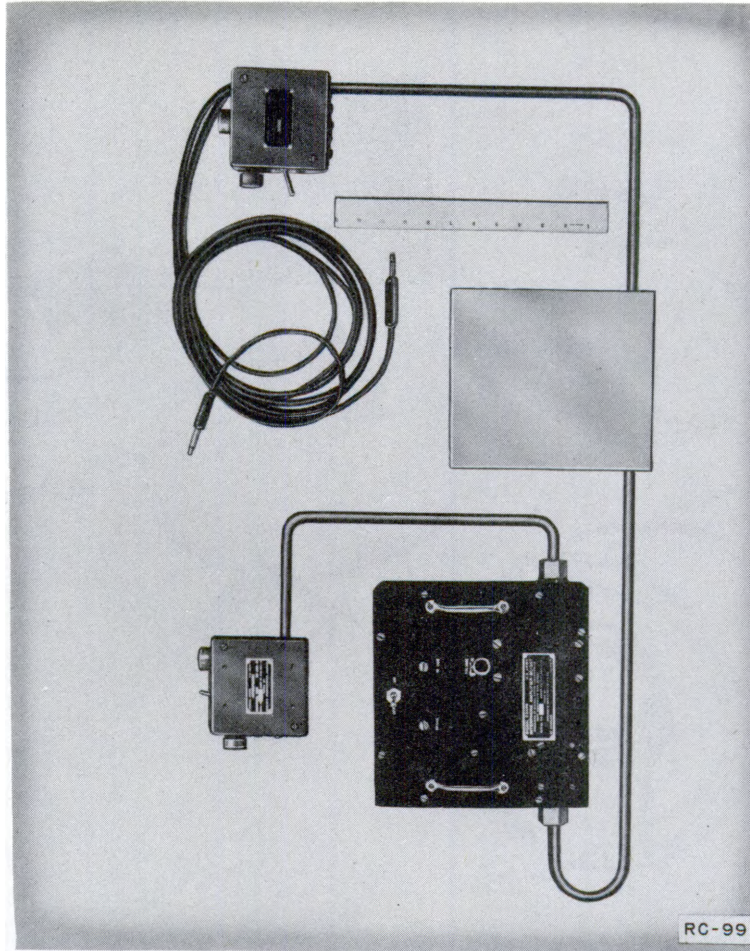

Figure 120. Interphone Equipment RC-99

Status: Standard. *Stock No.:* 2S99. *Reference:* TM 11-702.

Interphone Equipment RC-99 is a multistation, intravehicular communication system for use in various types of mobile units. All necessary cords, headsets, and microphones are included with the equipment. It is used to provide voice communication between members of the vehicular crew. In addition, it permits the radio operator and vehicle commander to retain partial control of the vehicular radio system for intervehicular and base-station voice communication.

- U/w Light Tanks M5 and M5A1.
- U/w Medium Tanks M4 to M4A4.
- U/w Medium Armored Cars M5 and MG.
- U/w Armored Car T18.

TECHNICAL CHARACTERISTICS

POWER: Battery-operated—one 12-v, 168 amp-hr, 8-hr rate vehicular storage battery.

POWER OUTPUT: 2 w.

PRINCIPAL COMPONENTS

	<i>Dimensions (in.)</i>	<i>Weight (lb)</i>
Control Box VC-739-----		2½
Interphone Amplifier BC-367. 8½ ¹ / ₁₆ x 8½ ¹ / ₁₆ x 5 ⁵ / ₁₆		19
Interphone Amplifier BC-667. 8½ ¹ / ₁₆ x 8½ ¹ / ₁₆ x 5 ⁵ / ₁₆		19
Interphone Control Box BC-606-D.-----		2



Figure 121. Recorder-Reproducer MC-572 of Recording Equipment RC-169.

Status: Standard. Stock No.: 6C262-169. Reference: TM 11-2569.

Recording Equipment RC-169 is a portable, sound recording equipment that consists of a recorder-reproducer, a remote control unit, a steno control unit, a dual interconnecting cord, a microphone, a headset, and interconnecting cables. Two hundred recording disks are supplied with the equipment. Recording Equipment RC-169 is used to record from a microphone or line input, under direct or remote control. The equipment reproduces recorded disks through the speaker or headset. It also operates as a transcriber for the purpose of copying recorded material from disk to typewritten form.

TECHNICAL CHARACTERISTICS

FREQUENCY RESPONSE: Flat within 5 db from 300 to 4,000 cps.
REPRODUCING SPEEDS: 7½ to 30 rpm forward, 30 rpm reverse.

RECORDING SPEED: 30 rpm, forward only.
RECORDING DISK: 7-in. plastic disk.
CAPACITY: 15 min.
INPUT IMPEDANCE: 50 ohms for dynamic microphone.
 500- or 5,000-ohm lines.
OUTPUT IMPEDANCE: For 5-ohm loudspeaker.
 Jack for 600-ohm headset or 8-ohm load.
 Jack for 600-ohm line or headset.
POWER: 115/230 v, ac, 50 to 60 cps.
POWER CONSUMPTION: 60 w.

PRINCIPAL COMPONENTS

Item	Dimensions (in.)	Weight (lb)
Recorder-Reproducer MC-572	11 x 12 x 12	38
Remote Control Unit RM-56	300 (length)	1.7
Steno Control Unit MC-571	84 (length)	

PACKED WEIGHT AND DIMENSIONS

	Dimensions (in.)	Weight (lb)	Volume (cu ft)
Export pack	27½ x 44 x 19	225	13.3

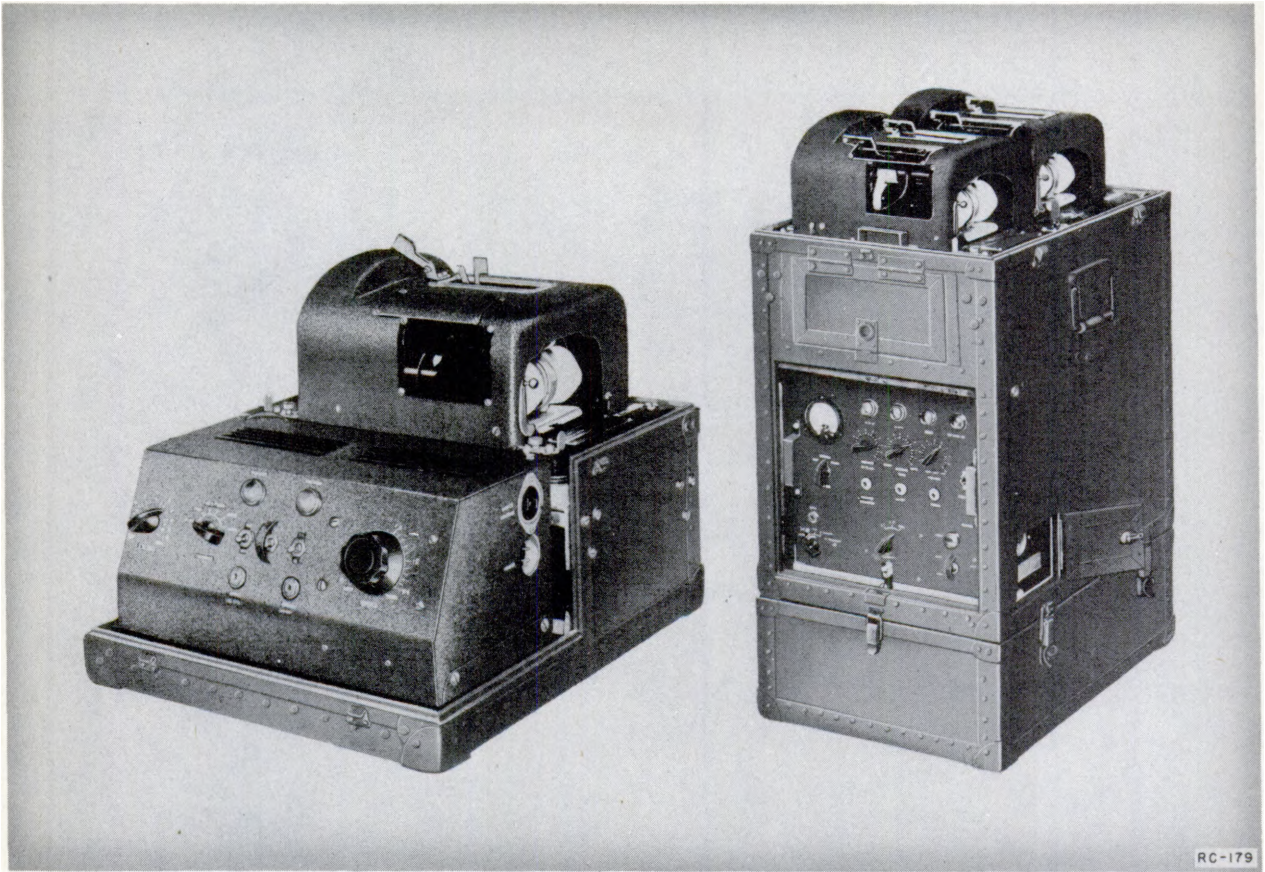

Figure 122. Recording Equipment RC-179.

Status: Standard. *Stock No.:* 6C262-179. *References:* TM 11-2542 and TM 11-2543.

Recording Equipment RC-179 consists of a speech recorder, a speech reproducer, and all necessary accessories. The equipment is designed for mobile operation. It is used for radio supervision and interception, and for recording and immediate reproduction of telephone, telegraph, radio, and other signals. The equipment utilizes standard Dictaphone-type wax cylinders and may be operated without interruption because of the twin mandrel feature.

TECHNICAL CHARACTERISTICS

SPEECH RECORDER:

AUDIO-INPUT CHANNELS: High sensitivity—500 ohms.
Bridging—5,000 ohms.

AUDIO-INPUT POWER: Any 60-db range between -80 and +20 db.

AUDIO-OUTPUT CHANNELS: 600 and 5,000 ohms.
AUDIO-OUTPUT POWER: 2.0 w.
BACKGROUND NOISE: 25 db or more below max signal at 1,000 cps.
CROSSTALK IN PLAY-BACK: 20 db below recording level.
FREQUENCY RESPONSE: 300 to 2,500 cps, flat within 3 db.
DISTORTION: 10 percent.
MANDREL SPEED: 15-in. record—78 rpm.
30-in. record—39 rpm.
POWER INPUT: 115 or 230 v, ac, 50 to 60 cps.

SPEECH REPRODUCER:

AUDIO-OUTPUT CHANNELS: 600 and 5,000 ohms.
AUDIO-OUTPUT POWER: 2.0 w.
MANDREL SPEED: Max—78.0 rpm.
Min—5.2 rpm.
POWER INPUT: 115 or 230 v, ac, 50 to 60 cps.

PRINCIPAL COMPONENTS

Item	Dimensions (in.)	Weight (lb)
Speech Recorder MC-502.....	26 x 16 x 21	133
Speech Reproducer MC-503...	14 x 15½ x 19%	75

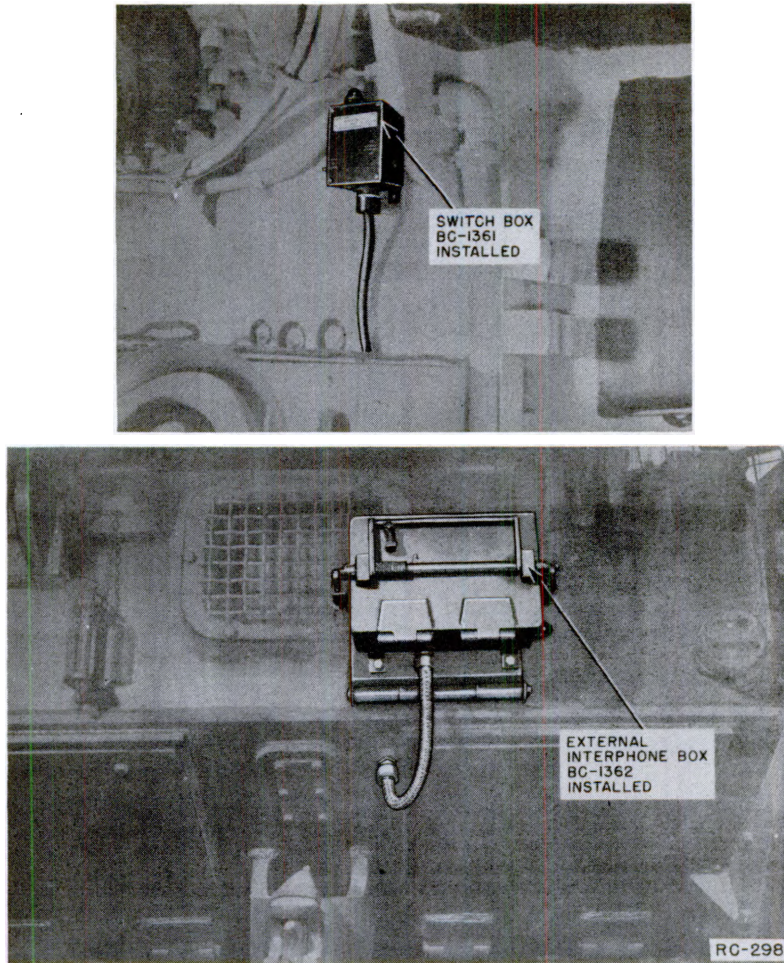

Figure 123. Interphone Extension Kit RC-298, position of components installed.

Status: Substitute/Std. *Stock No.:* 2C1963-298.
Reference: TM 11-703.

Interphone Extension Kit RC-298 consists of an interphone box and a switch box. All necessary cords and connectors are included with the equipment. It is used to provide communication between the crew of a vehicle and persons using the externally mounted interphone box.

TECHNICAL CHARACTERISTICS

POWER: Operates from the electrical system of the vehicle in which it is installed.

PRINCIPAL COMPONENTS

<i>Item</i>	<i>Dimensions (in.)</i>
External Interphone Box BC-1362	7½ x 4½ x 11.
Switchbox BC-1361	3½ x 2 x 4.



Figure 124. Recorder RD-17/U.

Status: Limited/Std. *Stock No.:* 4A1954. *Reference:* TM 11-377.

Recorder RD-17/U is designed for recording high-speed radiotelegraph signals in ink on three-eighths inch wide standard recording paper tape. It consists of a field coil pot, a faucet cone and handle, an ink pot, a pen adjusting assembly, a pen arm and pen, and a dust cover. The recorder may be operated on a polar circuit, either direct wire line or radio channel.

P/o Radio Set AN/MRC-1.

TECHNICAL CHARACTERISTICS

SPEED OF OPERATION.	Operated on double (marking and spacing) current—400 wpm max.
	Operated on single current—300 wpm max.
POWER:	110 v, dc, 35-ma max current.

WEIGHTS AND DIMENSIONS

	Dimensions (in.)	Weight (lb)	Volume (cu ft)
Unpacked.....	10 x 9 x 10	29	53
Export pack.....	18½ x 18½ x 15	88	3

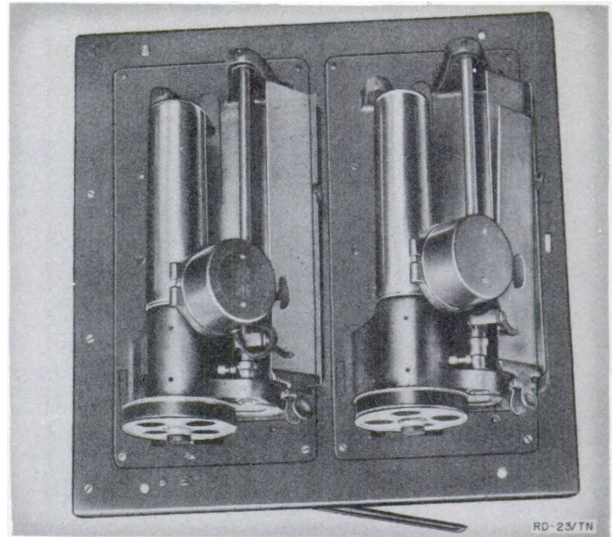

Figure 125. Recorder RD-23/TN.

Status: Standard. *Stock No.:* 4A1402. *Reference:* TM 11-2554.

Recorder RD-23/TN is an electromagnetic sound recorder that utilizes standard wax cylinders as the recording medium. It consists of a floor cabinet in which are mounted a double mandrel, an amplifier, and a remote signal control unit. Two chip pans, power cables, and headsets are supplied with the equipment. Recorder RD-23/TN is used to record conferences, dictation, and the like for reference or for stenographic transcription. The automatic change-over feature allows continuous recording for any length of time.

TECHNICAL CHARACTERISTICS

RECORDING DISK:	6.5-in. wax cylinder.
AMPLIFIER OUTPUT:	2 w.
POWER:	110 v, ac, 60 cps; 140 w.
	110 v, dc; 140 w.

DIMENSIONS

	Dimensions (in.)	Volume (cu ft)
Unpacked.....	15½ x 15½ x 32	4.45



Figure 126. Recorder-Reproducer RD-31B/U.

Status: Standard. *Stock No.:* 6C262-7. *Reference:* TM 11-5502.

Recorder-Reproducer RD-31(*)/U represents RD-31/U, RD-31A/U, and RD-31B/U. Recorder-Reproducer RD-31(*)/U is a portable electro-mechanical wire recorder which is used to make and reproduce permanent recordings. It consists of an amplifier, an oscillator, a spool drive assembly, and an erase-record-reproduce assembly, all housed in one case. A microphone, spools, and wire are furnished. Recorder-Reproducer RD-31(*)/U is used to record either voice or music signals on steel wire. Separate inputs are provided for a high-impedance, dynamic-type microphone and for a radio or telephone line. The unit simultaneously erases a preceding recording while a new recording is being made. The recording may be reproduced through the self-contained loudspeaker or by connection to an external loudspeaker or headset. The recorder-reproducer may also be used as a public address system without utilizing its recording and reproducing features.

TECHNICAL CHARACTERISTICS

FREQUENCY RANGE:	150 to 5,000 cps, within ± 3 db.
INPUT CHANNELS:	Microphone input—100,000 ohms. High level input jack—500,000 ohms.
OSCILLATOR FREQUENCY:	30,000 cps.
OUTPUT TRANSFORMER IMPEDANCE:	10 ohms.
WIRE SPEED:	Forward—2.5 fps. Rewind—5 fps.
CAPACITY:	1 hr.
WIRE:	.004-in stainless steel.
ERASE HEAD:	Magnetic type, cut-off frequency of 5,000 cps; 3,000 ohms impedance at 400 cps.
MICROPHONE:	High-impedance, moving-coil.
LOUDSPEAKER:	5-in. permanent magnet; 5 w peak power; 3.2 ohms voice coil impedance.
MOTOR:	Single-phase, capacitor start, induction motor 1,600 rpm.
POWER:	115 v, ac, 60 cps.

WEIGHTS AND DIMENSIONS

	Dimensions (in.)	Weight (lb)	Volume (cu ft)
Unpacked	12 $\frac{3}{8}$ x 7 $\frac{7}{8}$ x 13 $\frac{7}{16}$	32	.72
Domestic pack	20 x 15 x 22	56	3.82



Figure 127. Reproducer RD-36/U.

Status: Standard. *Stock No.:* 6C272-4. *Reference:* TM 11-2561.

Reproducer RD-36/U consists of a 2-speed turntable with a pickup arm, a five-tube amplifier, a dynamic microphone, an 8-inch permanent-magnet loudspeaker, and various connecting cables. All elements are contained in an air-luggage style case. Reproducer RD-36/U is used to play records of 10-, 12-, and 16-inch sizes at speeds of 33½ or 78 r.p.m. Two input circuits permit the simultaneous use of voice and sound reproduction. An additional jack that it mounted on the control panel permits the output

of the pick-up unit to be fed into an external amplifier if desired.

TECHNICAL CHARACTERISTICS

TURNTABLE SPEEDS:	33½ and 78 rpm.
RECORD SIZE:	10-, 12-, and 16-in.
POWER:	110 to 115 v, ac, 50 to 60 cps; 70 w.
POWER OUTPUT:	7 w at less than 5 percent distortion.

DIMENSIONS

	<i>Dimensions (in.)</i>	<i>Volume (cu ft)</i>
Unpacked.....	19¼ x 10½ x 19	2.28



Figure 128. Recorder-Reproducer RD-38/FN.

Status: Limited/Std. *Stock No.:* 4A1941. *Reference:* TM 11-2553.

Recorder-Reproducer RD-38/FN is a portable sound recording machine that consists of a recorder-reproducer, an amplifier, a microphone speaker, a power cable, and an inductive pick-up. Recorder-Reproducer RD-38/FN is used to record conferences, conversations, dictation, etc., and to play them back for reference or stenographic transcription. Provision is made for distant or close position to microphone.

TECHNICAL CHARACTERISTICS

RECORDING DISK: 6.5-in. wax cylinder.
 CAPACITY: 1 hr.
 POWER: 110 v, ac, 60 cps.

DIMENSIONS

	<i>Dimensions (in.)</i>	<i>Volume (cu ft)</i>
Unpacked.....	14 x 12 x 34	3.30



Figure 129. Shelter S-1/FM.

Status: Standard. *Stock No.:* 7A1653-1. *Reference:* TM 11-2563.

Shelter S-1/FM consists of prefabricated plywood sections designed for quick assembly. No special equipment is required to erect the shelter. Heat is supplied by a Miller utility heater model OG-31-A-115, and two 25-foot, rubber-insulated electric cables are used to extend electric power within the shelter. Shelter S-1/FM is used to

house direction-finder equipment and repair and service work shops.

TECHNICAL CHARACTERISTICS

HEATER: Electrical, operates on 110 v, ac, 60 cps.

WEIGHT AND VOLUME

	<i>Weight (lb)</i>	<i>Volume (cu ft)</i>
Export pack	9,599	1,013



Figure 130. Detector Set SCR-625-(*) .

Status: Limited/Std. *Stock No.:* 2S625. *Reference:* TM 11-1122.

Detector Set SCR-625-(*) represents SCR-625-A, SCR-625-B, SCR-625-C, SCR-625-D, and SCR-625-E. Detector Set SCR-625-(*) is a portable device capable of detecting all types of metals. The set consists of an exploring-rod assembly, an amplifier, a resonator, and all necessary accessories. Detector Set SCR-625-(*) is used to locate buried masses of metals, such as antitank mines.

TECHNICAL CHARACTERISTICS

DETECTION RANGE: Detects a standard American antitank mine at a distance of 24 in. from the exploring rod.

POWER: Battery operated—2 Batteries BA-30, 1 Battery BA-38.

PRINCIPAL COMPONENTS

Item	Dimensions (in.)	Weight (lb)
Amplifier BC-1141-()	14 x 6 x 5	5
Control Box BC-1140-()	7 x 7 x 5	3
Resonator M-356-()	3 x 3 (diam)	$\frac{3}{16}$
Search Coil C-446-()	1 x 13 (diam)	3

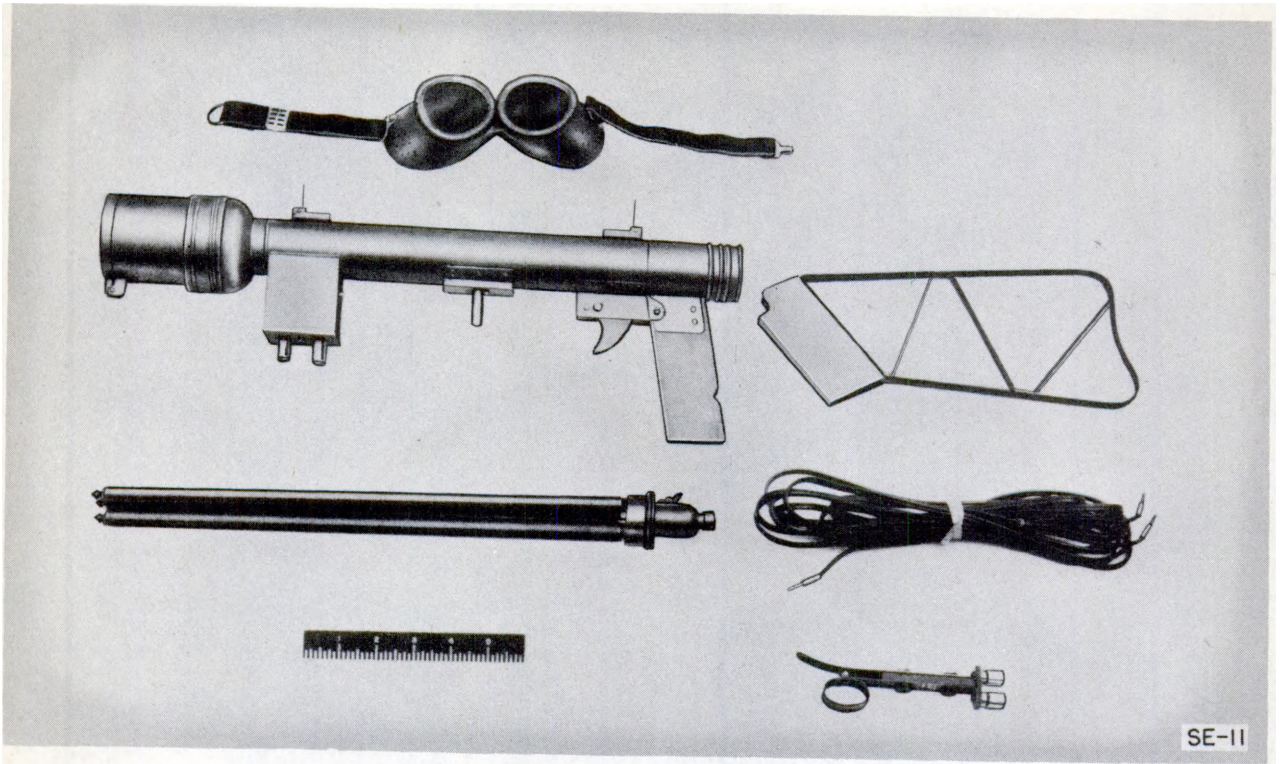

Figure 131. Signal Lamp Equipment SE-11.

Status: Standard. *Stock No.:* 6B841. *Reference:* TM 11-392.

Signal Lamp Equipment SE-11-(*) represents SE-11 and SE-11-A. Signal Lamp Equipment SE-11-(*) is a light, portable field equipment for transmitting messages by means of white or red flashes of light in International Morse Code. It consists of a signal lamp, lamps, a tripod, a hand key, a gunstock, filters, and all necessary accessories.

TECHNICAL CHARACTERISTICS

MAXIMUM RANGE: 2,000 yd in bright sunlight, 5 mi at night; with red filter, 1,000 yd in daylight, 2½ mi at night.

CODE SPEED: 10 wpm.

BEAM WIDTH: 8°.

POWER: Battery operated—5 Batteries BA-30.

PRINCIPAL COMPONENTS

Item	Dimensions (in.)	Weight (lb)
2 Filters MC-430.....	1 15/16 x 1 (diam)	. 1
Gunstock M-341.....	11 x 4 1/2 x 3/8	. 4
Hand Key J-51.....	1 1/16 x 5 3/4 x 1/2	. 1
Signal Lamp M-227.....	18 1/2 x 6 x 1 3/4	2. 1
Tripod LG-21.....	1 3/8 x 17 (lg)	1. 4
Lamp LM-61.....	1 3/2 x 3/16 (diam)	-----

PACKED WEIGHTS AND VOLUMES

	Weight (lb)	Volume (cu ft)
Domestic pack.....	7	. 4
Export pack.....	17. 5	1. 2



Figure 132. Microphone T-17-(*)

Status: Standard. *Stock No.:* 2B1617.

Microphone T-17-(*), represents various models of the T-17. Microphone T-17 is an antinoise, carbon-button, hand microphone. The microphone is unidirectional and it is controlled by the push-to-talk switch. Microphone T-17-(*), is used with standard Signal Corps radio and telephone equipment.

TECHNICAL CHARACTERISTICS

FREQUENCY RESPONSE: 400 to 2,600 cps.
IMPEDANCE: To match 35- to 90-ohm circuit.
OUTPUT: 34 db to 50 db, depending on frequency.

DIMENSIONS

Dimensions (in.)
 Unpacked..... $5\frac{1}{4} \times 2\frac{5}{8}$ (diam of housing).

T-30-(*)

T-36-(*)



Figure 133. Microphone T-30.

Status: Standard. *Stock Nos.:* 2B1630 (T-30 through T-30-N), 2B1630.1 (T-30-P through T-30-V).

Microphone T-30-(*) represents T-30-A through T-30-V. Microphone T-30-(*) is a carbon inertia type throat microphone. It consists of two units in series in the neckpiece with an 11½-inch cord and a plug. It is used with aircraft and vehicular radio and interphone sets.

TECHNICAL CHARACTERISTICS

IMPEDANCE: To match 250-ohm circuit.
FREQUENCY RESPONSE: 200 to 5,000 cps, flat within 3 db.

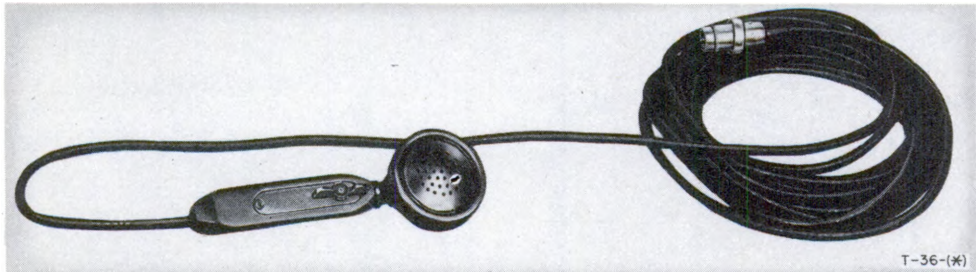

Figure 134. Microphone T-36-C.

Status: Limited/Std. *Stock No.:* 2B1636.

Microphone T-36-(*) represents various models of the T-36. Microphone T-36-(*) consists of a carbon microphone unit that is assembled in a hand housing. The hand housing is fitted with a thumb-operated switch. A 24-foot, 3-conductor cord with connector is attached to the handle of the microphone to connect it to Amplifier BC-641-(*)).

U/w but not p/o Amplifier BC-641-() and Loudspeaker LS-6 ().

TECHNICAL CHARACTERISTICS

IMPEDANCE: 250 ohms.

WEIGHT

	<i>Weight (lb)</i>
Unpacked5

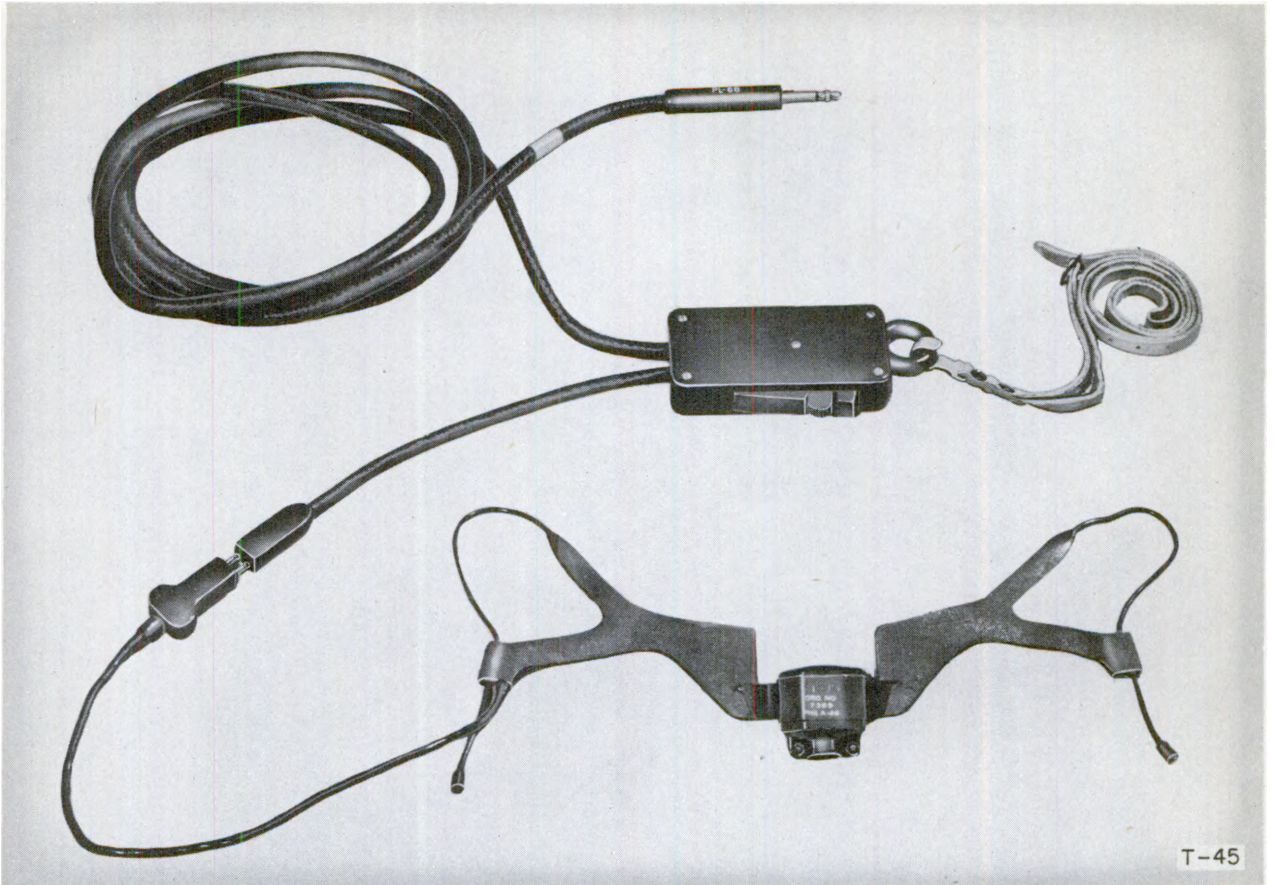

Figure 135. Microphone T-45.

Status: Standard. *Stock No.:* 2B1645.

Microphone T-45 is a noise-canceling, single-button, carbon-type microphone designed to be worn on the upper lip. The design of the microphone reduces background noise, but allows speech to be reproduced clearly under all conditions. This microphone is used in conjunction with Cord CD-318 (not supplied as a part of the T-45).

Microphone T-45 is used with standard Signal Corps radio and telephone equipment.

TECHNICAL CHARACTERISTICS

IMPEDANCE: 100 ohms.

WEIGHT

	<i>Weight (lb)</i>
Unpacked.....	.094

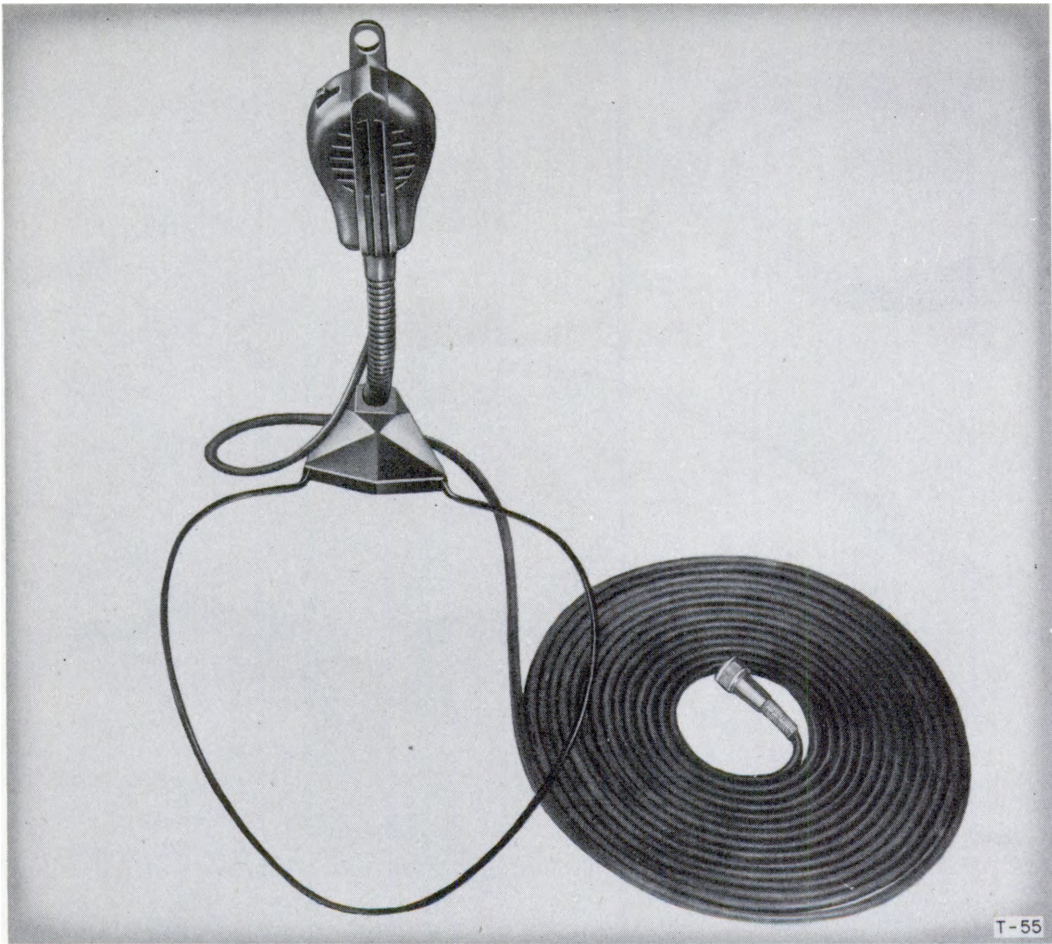

Figure 136. Microphone T-55.

Status: Substitute/Std. *Stock No.:* 2B1655.
Reference: TM 11-2504.

Microphone T-55 is a unidirectional high-impedance dynamic type microphone; it is equipped with a bracket that rests on the operator's shoulders. A flexible gooseneck allows adjustment of the microphone to the proper operating distance and position. The microphone may be unscrewed from the bracket and used by holding it in the hand.

TECHNICAL CHARACTERISTICS

FREQUENCY RESPONSE: 50 to 8,000 cps.
 OUTPUT LEVEL: -50 or -57 db below
 6 mv.
 CORD: 7 ft, removable.

WEIGHT AND DIMENSIONS

	<i>Dimensions (in.)</i>	<i>Weight (lb)</i>	<i>Volume (cu ft)</i>
Unpacked.....	5½ x 2½ x 1¼ ₁₆	1½	.016

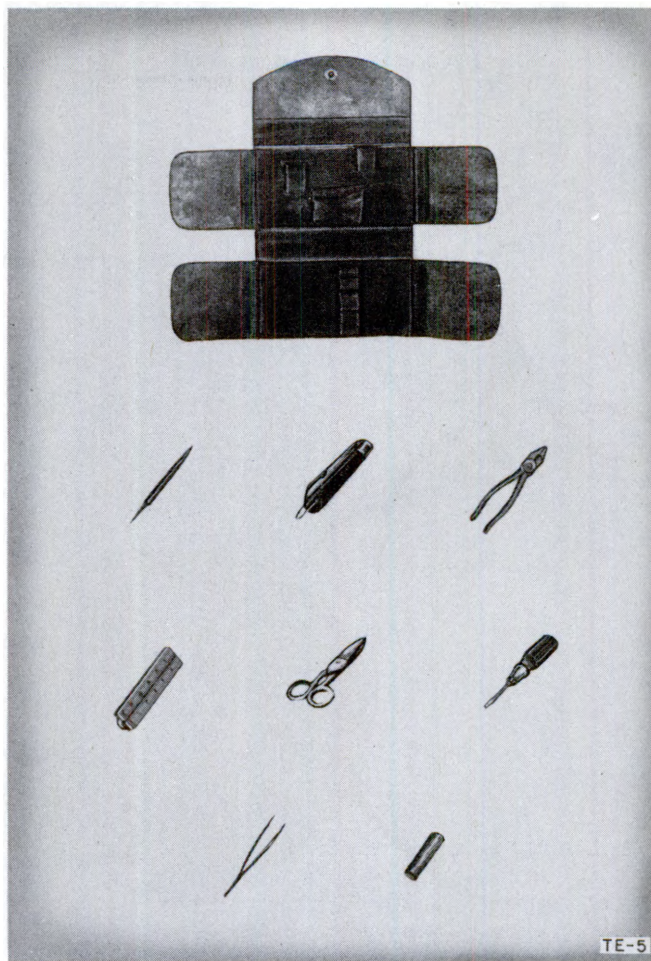

Figure 137. Tool Equipment TE-5.

Status: Standard. Stock No.: 6R38005. Reference: SIG-6-TE-5.

Tool Equipment TE-5 consists of an assembly of tools contained in a leather case. It is used as an inspector's pocket kit for general application.

Knife TL-29.....	1
Pliers TL-119.....	1
Rule, boxwood, 2 ft, 4-fold.....	1
Screw driver TL-15.....	1
Scissors, 5 in.....	1
Tweezers, 4½ in.....	1

PRINCIPAL COMPONENTS

<i>Item</i>	<i>Quantity</i>
Case BG-29.....	1
File, half-round, 3 in.....	1
Handle, file, 3 in.....	1

WEIGHT AND VOLUME

	<i>Total weight (lb)</i>	<i>Total volume (cu ft)</i>
Export pack.....	1.56	.05

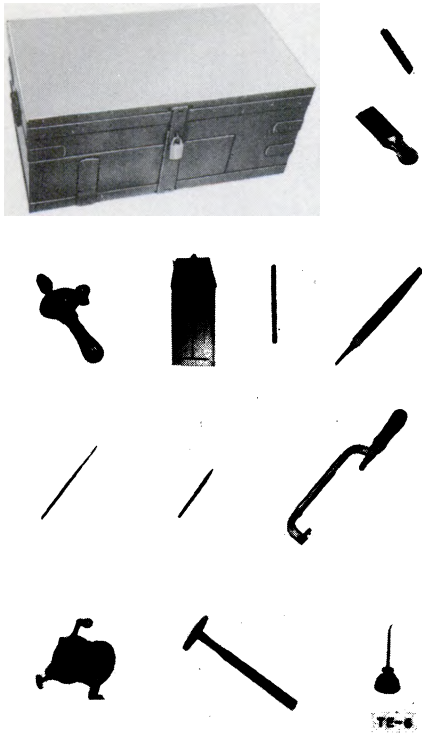

Figure 138. Representative Items of Tool Set TE-6.

Status: Limited/Std. Stock No.: 6R38006. Reference: SIG 6-TE-6.

Tool Set TE-6 is a general-purpose mechanic's tool set. All necessary expendable and non-expendable items for repairing metal objects are included in the equipment.

PRINCIPAL COMPONENTS

Item	Quantity
Chest BC-77.....	1
Chisel: cold; 1/2 x 6 in.....	1
Drill: hand; ratchet for round shank drills 0 to 1/4 in.....	1
Drill: twist, steel; #1 to #60.....	1 ea size
Files: flat; round; square.....	20
Frame: hack-saw; adjustable; 8 to 12 in.....	1
Grinder: tool; hand.....	1
Hammer: riveting; 4 oz.....	1
Padlock MC-92.....	1
Pliers TL-13.....	1
Pliers TL-103.....	1
Pliers TL-126.....	1
Screwdriver, TL-25.....	1
Screwdriver Set TL-128.....	1
Screwplate set: little Giant #AA-4.....	1
Soldering Iron TL-46.....	1
Torch TL-320()/U.....	1
Vise: bench; 2 in.....	1

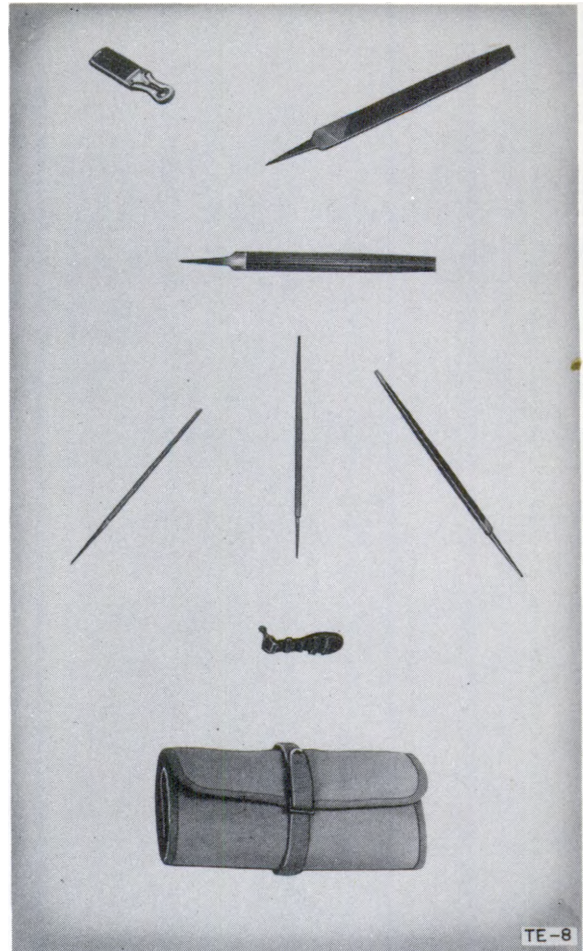

Figure 139. File Equipment TE-8.

Status: Standard. Stock No.: 6Q37008. Reference: SIG-6-TE-8.

File Equipment TE-8 consists of a tool roll containing an assortment of files. It is used for general-purpose repair work.

PRINCIPAL COMPONENTS

Item	Quantity
Cleaner, file, Phoenix 2.....	1
File, flat bastard, 8 in.....	1
File, flat bastard, 10 in.....	1
File, half-round, 8 in.....	2
File, bastard, 8 in.....	1
File TL-133.....	1
File, bastard, square, 8 in.....	1
File, taper, saw, 6 in.....	2
Handle, file, 5/4 in.....	1
Tool Roll BG-30.....	1

WEIGHT AND VOLUME

	Total weight (lb)	Total volume (cu ft)
Export pack.....	5.5	.16



Figure 140. Wrench Equipment TE-9.

Status: Standard. Stock No.: 6R59309. Reference: SIG-6-TE-9.

Wrench Equipment TE-9 is an assortment of double open-ended wrenches, all contained in an eight-pocket tool roll.

PRINCIPAL COMPONENTS

Item	Quantity
Tool Roll BG-31.....	1
Wrench, double end.....	1
Wrench, TL-447/U.....	1
Wrench, double end, thin.....	3

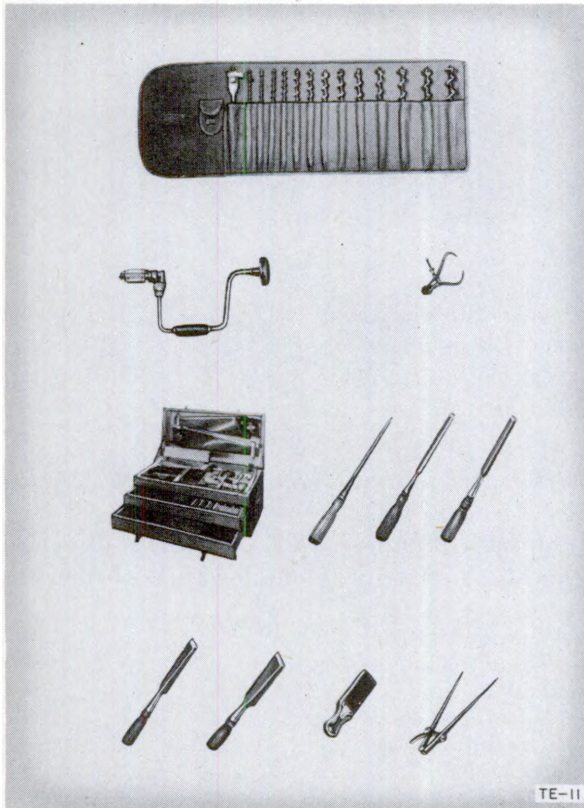

Figure 141. Representative items of Tool Set TE-11.

Status: Limited/Std. Stock No.: 6R38011. Reference: SIG-6-TE-11.

Tool Set TE-11 consists of a carrying chest containing an assortment of woodworking tools. It is used for general-purpose repairs on wooden equipment.

PRINCIPAL COMPONENTS

Item	Quantity
Bit Equipment TE-25.....	1
Brace Ratchet TL-397/U.....	1
Caliper, outside, 4 in.....	1
Chest BC-88.....	1
Chisel, wood, 1/4 in.....	1
Chisel, wood, 5/8 in.....	1
Chisel, wood, 3/4 in.....	1
Chisel, wood, 1 1/4 in.....	1
Chisel, wood, 1 3/4 in.....	1
Cleaner, file, Phoenix 2.....	1
Divider, wing, 8 in.....	1
Drill Equipment TE-13.....	1
File Equipment TE-17.....	1
Hammer TL-39.....	1
Hammer, riveting, 7 oz.....	1
Handle TL-14.....	1
Handle TL-215.....	1
Hatchet, half, 3 1/4 in.....	1
Knife, 8-in. blade.....	1
Oilstone, mounted.....	1
Plane jack, steel.....	1
Plane, smooth, 8 in.....	1
Puller, nail, 18 in.....	1
Rule, boxwood, 6 ft.....	1
Saw TL-104.....	1
Saw, rip, 26 in.....	1
Set saw, hand.....	1
Screw driver, 5-in. blade.....	1
Screw driver, 8-in. blade.....	1
Screwplate set.....	1
Square, steel, 24 x 14 in.....	1
Tape, measuring, 100 ft.....	1
Wrench TL-480/U.....	1
Wrench, monkey, 15 in.....	1
Wrench, pipe, 14 in.....	1

WEIGHT AND VOLUME

	Total weight (lb)	Total volume (cu ft)
Export pack.....	153	6

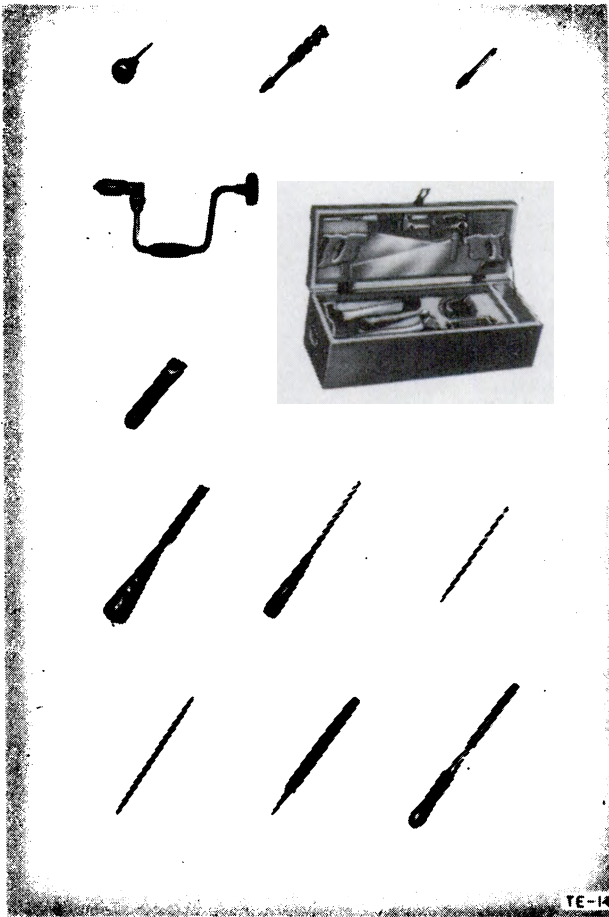

Figure 142. Representative items of Tool Set TE-14.

Status: Limited/Std. Stock No.: 6R38014.

Reference: SIG-6-TE-14.

Tool Set TE-14 is a carpenter's tool set consisting of an assortment of woodworking tools that are contained in a carrying chest.

PRINCIPAL COMPONENTS

Item	Quantity
Awl, scratch	1
Bit, auger, 1/4 in.	1
Bit, auger, 1/2 in.	1
Bit, auger, 3/4 in.	1
Bit, gimlet, 1/4 in.	1
Brace, ratchet, 1/4 in.	1
Chest BC-90	1
Chisel, cold, 3/4 in.	1
Chisel, wood, 3/4 in.	1
Chisel, wood, 5/16 in.	1
File TL-133	1
File, saw, 8 in.	1
File, bastard, 8 in.	1
Gouge, wood, 3/8 in.	1
Hammer TL-39	1
Hatchet, claw, 4-in. blade	1
Knife, 14-in. blade	1
Oilstone, soft, mounted	1

Item	Quantity
Plane, smooth, 9 in.	1
Pliers TL-13	1
Rule, boxwood, 2 ft, 4-fold	1
Saw, hack, 5 1/2-in. blade	1
Saw, hand, 24 in.	1
Saw, hand, 20 in.	1
Screw driver, 2-in. blade	1
Screw driver, cabinet, 5 1/2-in. blade	1
Square, 9 in.	1
Tape, measuring, steel, 50 ft.	1
Wrench, monkey	1
Blade, hack-saw, 5 1/2 in.	2
Handle TL-14	1
Handle TL-215	2

WEIGHT AND VOLUME

	Total weight (lb)	Total volume (cu ft)
Export pack	72	4

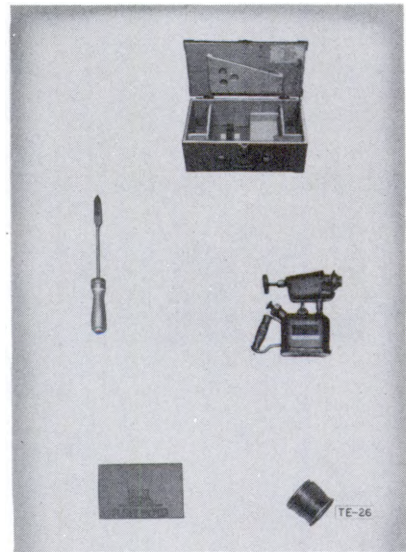

Figure 143. Soldering Equipment TE-26.

Status: Limited/Std. Stock No.: 6R24426. Reference: SIG-6-TE-26.

Soldering Equipment TE-26 consists of various items of soldering tools contained in a wooden box.

PRINCIPAL COMPONENTS

Item	Quantity
Solder M-31	10 lb
Box BC-87-()	1
Soldering Iron TL-46	1
Torch TL-66-()	1
Paper, sand, flint, #1	4

WEIGHT AND VOLUME

	Total weight (lb)	Total volume (cu ft)
Export pack	24.6	.8

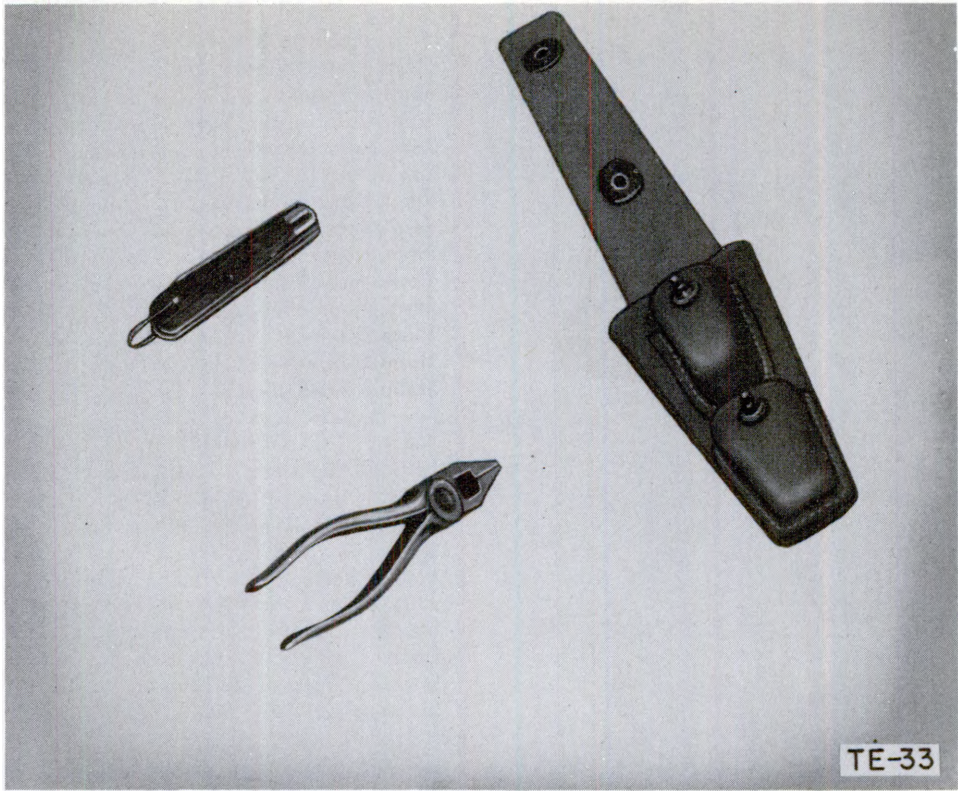

Figure 144. Tool Equipment TE-33.

Status: Standard. Stock No.: 6R38033. Reference: SIG-6-TE-33.

Tool Equipment TE-33 is a set of general use tools consisting of a pouch, a pair of side-cutting pliers, and a knife.

PRINCIPAL COMPONENTS

Item	Quantity
Knife TL-29-----	1
Pliers TL-13-----	1
Pouch CS-35-----	1

WEIGHT AND VOLUME

	Total weight (lb)	Total volume (cu ft)
Export packed-----	3.5	.15

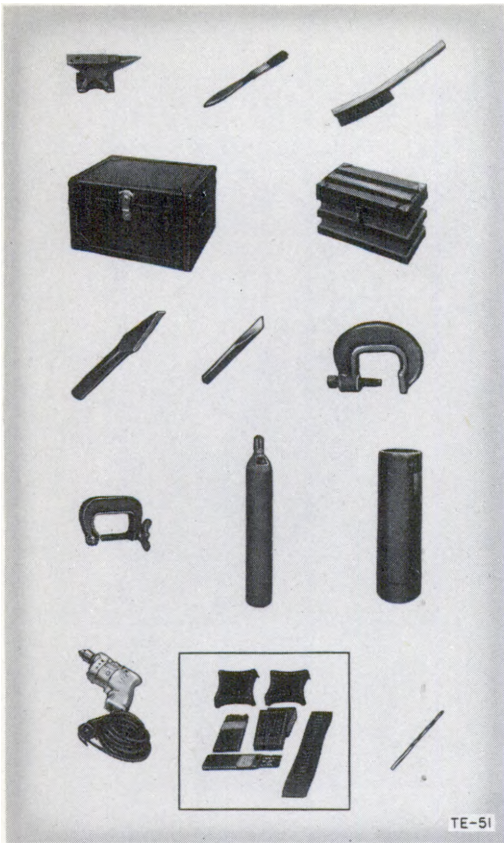

Figure 145. Representative items of Tool Set TE-51.

Status: Standard. Stock No.: 6R38051.3 (for use inside U. S. continental limits only) and 6R38051.4 (for use outside U. S. continental limits only). Reference: SIG-6-TE-51.

Tool Set TE-51 is an assembly of all of the equipment necessary to perform oxyacetylene welding.

PRINCIPAL COMPONENTS

Item	Quantity
Chest BC-5	2
Acid, sulphuric	½ pt
Zinc oxide	2 oz
Flux, aluminum	1 lb
Flux, brazing	1 lb
Flux, silver solder	1 lb
Flux, cast-iron	1 lb
Flux, soldering	2 oz
Rod, ½ in., brazing	5 lb
Rod, ¼ in., brazing	3 lb
Rod, ⅜ in., square	5 lb
Rod, ⅜ in., brazing	5 lb
Rod, ½ in., bronze	10 lb
Rod, ⅜ in., welding	10 lb
Rod, ⅜ in., cast-iron	10 lb
Rod, ⅜ in., steel	10 lb
Rod, ⅜ in., steel	25 lb

Item	Quantity
Solder, silver, yellow	3 oz
Solder, silver, white	3 oz
Solder, tin lead	16
Anvil, 70 lb	1
Blade, hack saw, 10 in	12
Chest CH-91	2
Chisel, cape, ⅝ in	1
Chisel, cape, ¼ in	1
Chisel, cape, hand	3
Chisel, cold, ⅝ in	1
Chisel, cold, ¼ in	1
Clamp TL-487/U	6
Clamp, 3-in. opening	6
Clamp TL-490/U	6
Cylinder, 225 cu ft ¹	
Drill, electric, portable	1
Drill, twist	2
File, flat, bastard, 10 in	2
File, bastard, 12 in	2
Flatter	2
Frame, hack saw	1
Fuller, ¼ in	1
Grinding and drilling equipment	1
Hammer, hand, blacksmith	1
Hammer, machinist's, 12 oz	1
Hammer, machinist's, 24 oz	1
Hammer TL-216	4
Hardy, blacksmith's	1
Manifold, acetylene	1
Pliers TL-107	1
Pliers TL-125	1
Rule, steel, 72 in	1
Screwdriver TL-105	1
Square, try, 9 in	1
Swage, blacksmith's, ¼ in	1
Tongs	4
Torch, preheating, 24 oz	1
Torch equipment	2
Truck, welding	1
Vise TL-338/U	1
Wrench, monkey	2
Brick, fire clay	24
Bruch TL-72	1
Brush, steel wire	1
Cylinder, 220 cu ft ²	
Gloves, welding	4
Goggles TL-547/U	2 pr
Goggles, welders	3
Lighter flint torch	6
Oiler, ⅜ pt	1
Regulator, Prest-O-Lite	1
Table, welding	1
Tank, 40 cu ft ³	

WEIGHTS AND VOLUMES

	Total weight (lb)	Total volume (cu ft)
Domestic pack	1, 676	80
Export pack	7, 232	260. 6

¹ Inside U. S.—4; outside U. S.—16.
² Inside U. S.—1; outside U. S.—30.
³ Inside U. S.—1; outside U. S.—10.

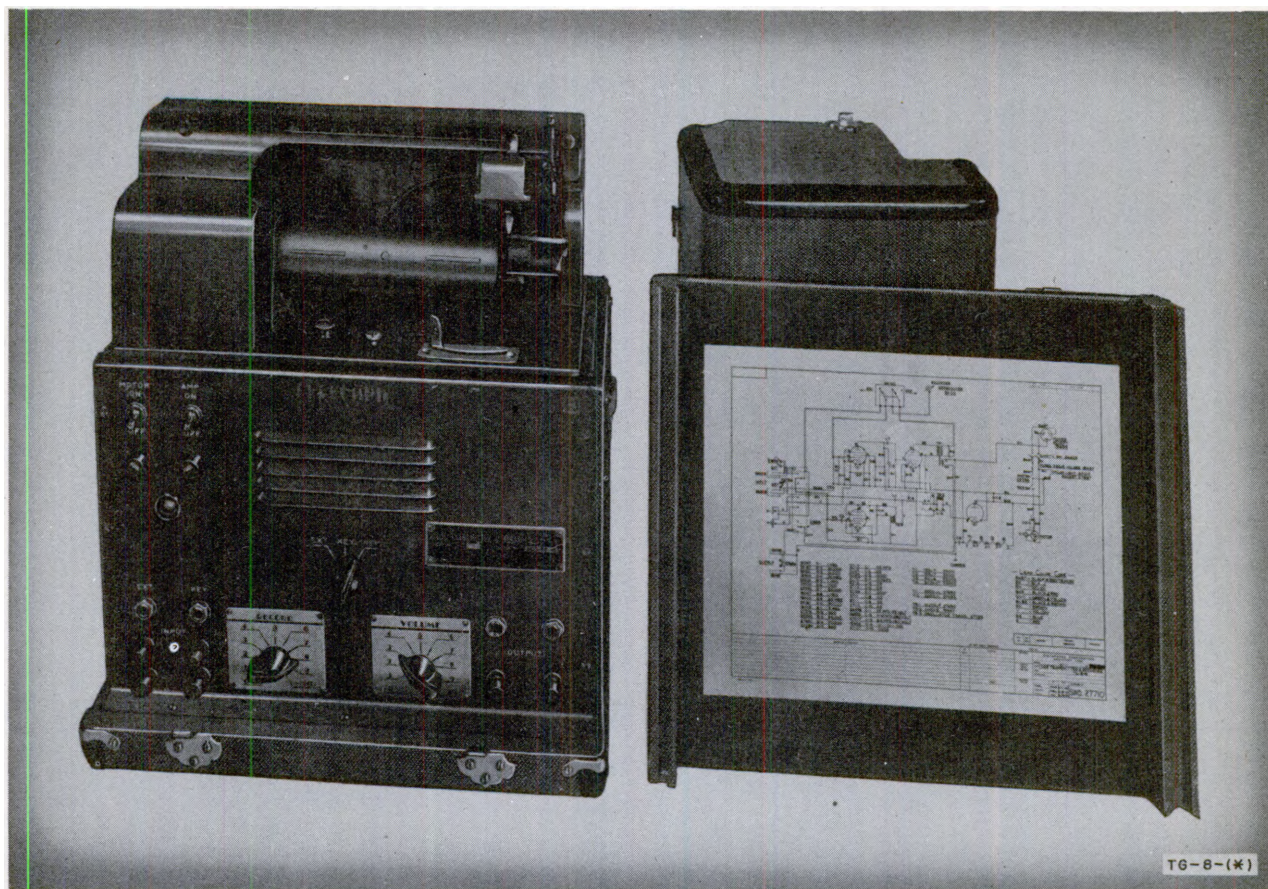

Figure 146. Code Transmitter and Recorder TG-8.

Status: Limited/Std. *Stock No.:* 4A408C.4.

Code Transmitter and Recorder TG-8-(*), represents TG-8, TG-8-A, TG-8-B, and TG-8-C. The TG-8-(*), is primarily a code practice and training set. An internal oscillator supplies a tone for recording keyed signals. Recordings also may be made from an external source. Twenty permanent records are supplied with the equipment for use in code training. Facilities are

present for playing back both the permanent records and the code recordings. An accessory shaving machine (not supplied) enables the code recordings to be reused several times.

TECHNICAL CHARACTERISTICS

RECORDING MEDIUM: Wax cylinder.
 MAXIMUM SPEED: 40 wpm.
 POWER: 110 v, ac, 50 to 60 cps and
 110 v, dc.

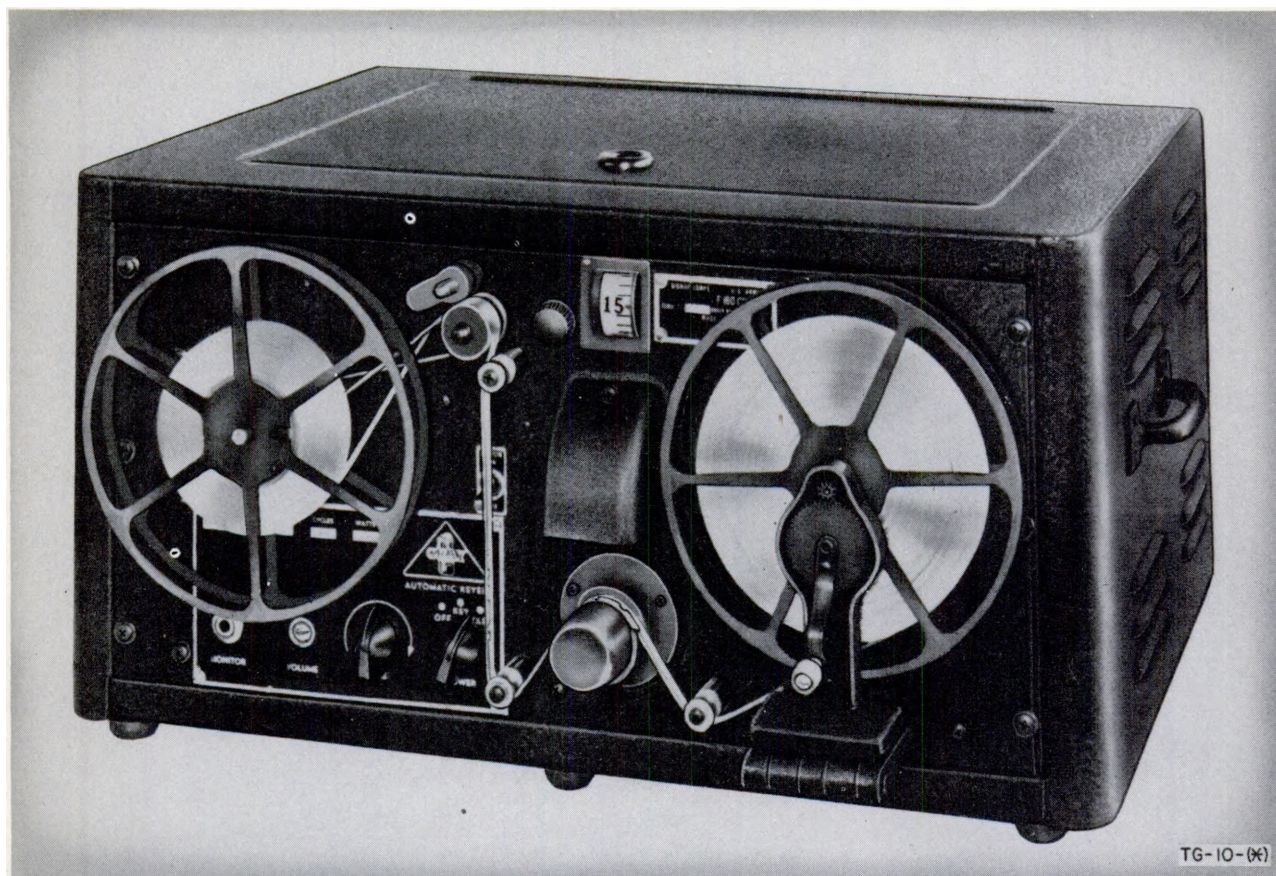

Figure 147. Keyer TG-10-F.

Status: Limited/Std. Stock No.: 4A1200. Reference: TM 11-447.

Keyer TG-10-(*) represents TG-10-A, TG-10-B, TG-10-C, TG-10-D, TG-10-F, TG-10-G, TG-10-H, and TG-10-J. Keyer TG-10-(*) is an automatic unit which provides audible code signals from an inked tape recording. It may also be operated from an external telegraph key, either manually or automatically. Keyer TG-10-(*) is used as part of various code practice equipments.

P/o Code Practice Equipments EE-94- (), EE-95- (), and EE-96- ().

TECHNICAL CHARACTERISTICS

OUTPUT: A-f note of 800 cps.
 CAPACITY: 500 to 1,000 headsets.
 POWER: TG-10-A-115 v, ac, 25 cps
 All others—115 v, ac, 60 cps

MODEL WEIGHTS AND DIMENSIONS

Item	Dimensions (in.)	Weight (lb)
TG-10-A	10¾ x 21¾ x 18½	70
TG-10-B, -C	10¾ x 21¾ x 18½	61
TG-10-D, -F, -G, -H, -J	11 x 24 x 18½	63

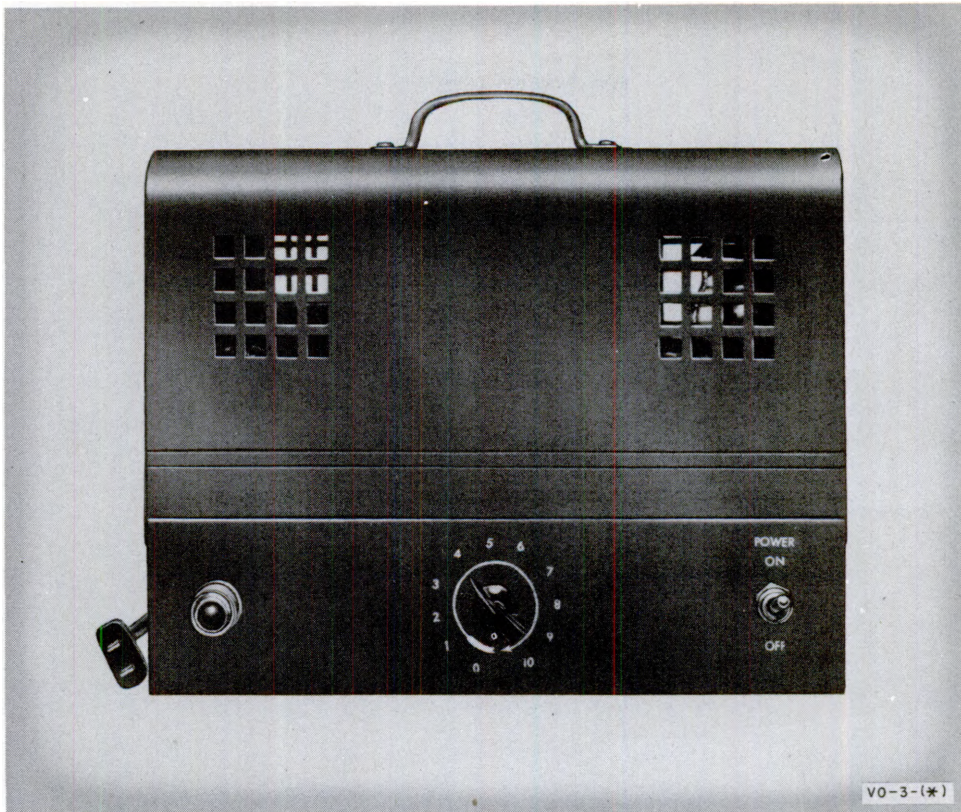

Figure 148. Oscillator VO-3-F.

Status: Standard. *Stock No.:* 2C2773.

Oscillator VO-3-(*), represents VO-3, VO-3-A, VO-3-B, VO-3-C, VO-3-D, VO-3-E, and VO-3-F. Oscillator VO-3-(*), is an a-f signal generator with a constant output of 800-cps tone. It is used to furnish constant tone to switchboards for code training purposes. It is a part of several code training sets.

TECHNICAL CHARACTERISTICS

FREQUENCY OUTPUT: 800 cps.
 OUTPUT IMPEDANCE: 4, 8, 12, or 16 ohms.
 POWER INPUT: 115 or 230 v, ac, 50 to 60 cps.
 POWER OUTPUT: 10 w, max.

WEIGHT AND DIMENSIONS

	Dimensions (in.)	Weight (lb)	Volume (cu ft)
Unpacked	12¼ x 10¼ x 7¼	20	.5

INDEX

	Page		Page
Accoustical Headset MX-550/U.....	85	Intercommunicating Station—Continued	
AF Amplifier AM-364/U.....	8	LS-127/FI.....	68
Alarm MC-420.....	81	LS-128/FI.....	68
Amplifier:		LS-129/FI.....	69
AM-91/GNQ.....	2	LS-130/FI.....	70
AM-92/TI.....	3	LS-133/FI.....	71
AM-93/TI.....	4	LS-134/FI.....	72
AM-129/U.....	5	LS-138/FI.....	73
AM-130/U.....	6	Interphone Equipment:	
AM-200/F.....	7	RC-53-(*).....	97
Audio Distributing Central AN/FIA-1.....	9	RC-99.....	98
Auxiliary Interphone Equipment AN/VIA-1.....	37	Interphone Extension Kit RC-298.....	101
Band PG-15.....	91	Key:	
Bowl PG-75.....	94	J-37.....	55
Brush PG-36.....	91	J-38.....	55
Cage PG-50.....	93	J-45.....	56
Code Practice Equipment:		J-47.....	56
EE-94-(*).....	45	Keyer TG-10-(*).....	120
EE-95-(*).....	46	Lantern MX-290/GV.....	83
EE-96-(*).....	48	Loft:	
Code Training Set AN/GSC-T1.....	20	PG-46-A.....	92
Code Transmitter and Recorder TG-8-(*).....	119	PG-68/TB.....	94
Connecting and Switching Kit MX-155/GT.....	82	Loudspeaker:	
Container PG-107/PB.....	96	LS-3.....	57
Converter M-209-(*).....	77	LS-7.....	58
Crate PG-49.....	93	LS-11.....	58
Cup PG-61.....	93	LS-112/U.....	59
Detector Set AN/VRS-1(*).....	38	LS-113/U.....	60
Detector Set SCR-625-(*).....	107	LS-114/U.....	61
Dual Channel Amplifier AM-43/FRC.....	1	LS-116/U.....	62
File Equipment TE-8.....	114	LS-117/U.....	63
Flag Set M-238.....	78	LS-122/U.....	64
Flash Ranging Set:		Magnetic Release Attachment MX-477/U.....	84
AN/GTC-1.....	21	Message Bag BG-121.....	43
GR-4-(*).....	50	Message Holder PG-67.....	93
Flashlight MX-212/U.....	83	Microphone:	
Fountain:		M-2/U.....	74
PG-37.....	92	M-11/U.....	75
PG-37-C.....	92	M-25/U.....	76
Headset:		T-17-(*).....	109
H-16/U.....	53	T-30-(*).....	110
HS-16-(*).....	54	T-36.....	110
HS-30-(*).....	55	T-45.....	111
Intercommunication Set:		T-55.....	112
AN/UIC-1.....	32	Operations Center:	
PA-8.....	90	AN/TTQ-1.....	30
Intercommunicating Station:		AN/TTQ-2.....	31
LS-124(*)/FI.....	65	Oscillator VO-3-(*).....	121
LS-125/FI.....	66	Pan PG-38.....	92
LS-126/FI.....	67	Panel Set AP-50-(*).....	39

	<i>Page</i>		<i>Page</i>
Parachute Equipment:		Reproducer:	
PG-100/CB.....	94	AN/GNQ-6.....	13
PG-101/CB.....	95	AN/GNQ-10.....	18
Pigeon Equipment:		RD-36/U.....	104
PG-103/CB.....	95	Reproducing Equipment MC-364-(*).....	80
PG-105/CB.....	95	Scraper PG-34-A.....	91
Pigeon Vest PG-106/CB.....	96	Shelter S-1/FM.....	106
Public Address Equipment PA-4-(*).....	88	Sieve PG-35.....	91
Public Address Set:		Signal Lamp Equipment:	
AN/PIQ-1.....	22	EE-84.....	44
AN/PIQ-2.....	23	SE-11-(*).....	108
AN/SIQ-1.....	26	Soldering Equipment TE-26.....	116
AN/TIQ-2(*).....	27	Sound Detector Set AN/PNR-1.....	24
AN/TIQ-3.....	28	Sound Locating Set GR-6-(*).....	51
AN/TIQ-8.....	29	Sound Ranging Set:	
AN/UIQ-1(*).....	33	GR-3-(*).....	49
AN/UIQ-3.....	34	GR-8.....	52
PA-1-(*).....	86	Sound Recording Set AN/UNQ-1(*).....	35
PA-2-(*).....	87	Speaker Assembly LS-154/U.....	74
PA-5-(*).....	89	Spotlight Set AN/PVQ-1.....	25
Recorder:		Stamp MC-181-(*).....	79
BC-1016.....	40	Switchboard:	
RD-17/U.....	102	BD-70.....	41
RD-23/TN.....	102	BD-114.....	42
Recording Equipment:		Tape Bridge MX-481(*)/U.....	85
RC-169.....	99	Tape Reel MX-480/U.....	84
RC-179.....	100	Tool Equipment:	
Recorder-Reproducer:		TE-5.....	113
AN/GNQ-4.....	11	TE-33.....	117
AN/GNQ-5(*).....	12	Tool Set:	
AN/GNQ-7.....	14	TE-6.....	114
AN/GNQ-7A.....	15	TE-11.....	115
AN/GNQ-8.....	16	TE-14.....	116
AN/GNQ-9(*).....	17	TE-51.....	118
RD-31(*)/U.....	103	Training Generator AN/URA-T1.....	36
RD-38/FN.....	105	Wrench Equipment TE-9.....	115
Record Set:			
AN/GNQ-11.....	19		
MC-209.....	80		



